

## Operation & Installation Guide



### **Steel Security Safe with Programmable Digital Lock**

Models 5103S-5107S / 5103-5108 / 5112DOJ / 5112-5113 /  
5103GS-5107GS / 5103G-5108G / 5112G-DOJ / 5112G-5113G

Read this manual carefully and never store it inside the safe!

# Index

Welcome / Package Contents .....	Page 1
Override Access Key / Install Batteries.....	Page 2
Locking Safe / Unlocking Safe.....	Page 3
Entering The Wrong Code / Secure Lockout Period / If You Forget Your Passcode.....	Page 4
Replacing Batteries / Care and Maintenance / Removable Shelf.....	Page 5
Anchoring Your Safe.....	Page 6
Consumer Assistance.....	Page 7
Ordering Additional Keys / Safe Identification Record.....	Page 8
Notes.....	Page 9
Warranty Information.....	Back Cover

## For Your Protection

- Do not remove the Serial Number tag from the safe.
- Never Store Override Access Keys inside safe.
- Record all Safe Identification Numbers on Safe Identification Record (page 8).
- Save this manual and NEVER keep it inside the safe.

## WELCOME

Your Honeywell Steel Security Safe will provide years of safe and secure protection for your valuables, important documents and other personal items. All Honeywell safes are designed and built using the highest manufacturing standards to ensure maximum user satisfaction under a variety of conditions. With proper care, your Honeywell safe will provide “Peace of Mind” for many years to come.

Thank you and enjoy!

## PACKAGE CONTENTS

The following list outlines the items and quantities of each included with your new safe. Please carefully check the list to confirm all items have been received. If any item is missing, please contact Consumer Assistance (See page 7 for contact information).

Operation Manual (1 ea.)

Override Access Keys (2 ea.)

“AA” Batteries (4 ea.)

Mounting Hardware (1 set)

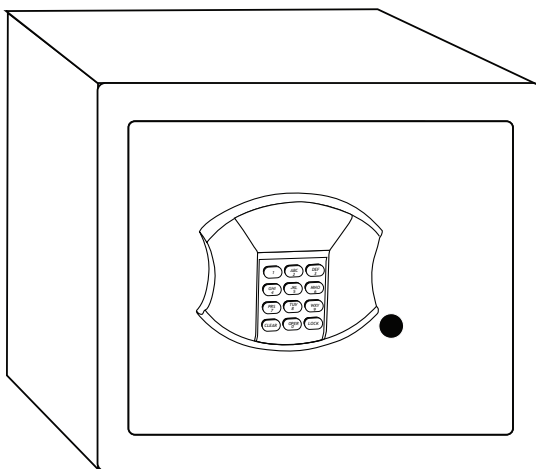

## Attention: DO NOT RETURN SAFE TO STORE

If you are missing parts or have difficulty operating your safe, please contact our Consumer Assistance Department by telephone. Store will not accept returned products without prior authorization. You must first contact our consumer assistance department. (See page 7 for contact information)

## OVERRIDE ACCESS KEY

Your safe is equipped with an override access key which allows immediate access in case you forget your user codes or the batteries need to be installed or replaced. There are 2 versions of this safe, one in which the key turns to the left and another in which the key turns to the right.

1. Remove override key cover with small screwdriver (Figure 1).
2. Insert override key and turn left (or right for some versions) to unlock safe (Figure 2).
3. Pull door open using handle located at the bottom of the keypad (Figure 3).
4. Remove override access key and store it in a safe place away from the safe. Replace the cover over the key lock and proceed to "Install Batteries" (Figure 4).

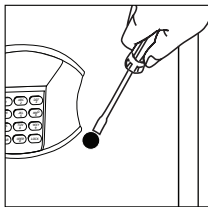

Figure 1

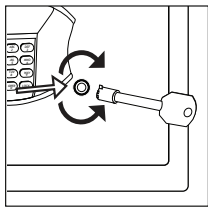

Figure 2

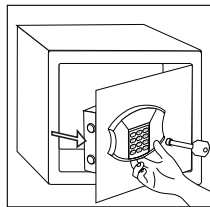

Figure 3

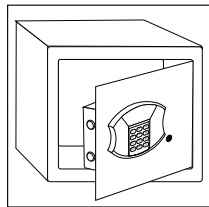

Figure 4

## INSTALL BATTERIES

For your convenience, we have included 4 "AA" batteries that provide the power for the electronic locking system. These batteries must be installed before using your safe. The battery compartment is located inside the safe on the lock cover panel.

1. Remove battery compartment cover on inside door (Figure 1).
2. Insert 4 "AA" batteries (included). Ensure the batteries are installed in the correct direction, with regard to polarity (+ and -) (Figure 2).
3. Replace the battery cover (Figure 3).
4. Proceed to the "Locking Safe" section on next page.

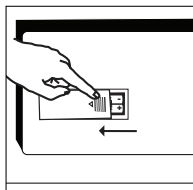

Figure 1

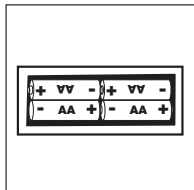

Figure 2

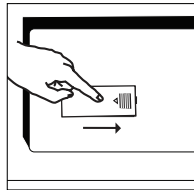

Figure 3

# LOCKING SAFE

The lock design allows for a new user code each time that the safe is locked

1. Enter any 3-6 digit Pass Code, for example “1”-“5”-“9” (Figure 1).
2. Immediately after entering the code, press the “LOCK” key (Figure 2).
3. Lock bolts should extend into the locked position (Figure 3).
4. The LED will display **CLOSED** for 3 seconds followed by the active code entered as a reminder. (Figure 4 & 5).

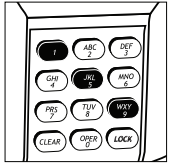

Figure 1

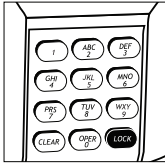

Figure 2

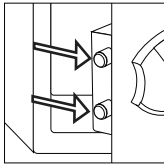

Figure 3

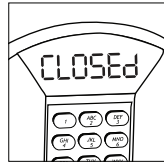

Figure 4

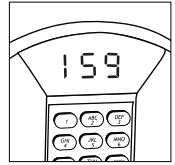

Figure 5

**PRIVACY MODE:** To prevent the LED displaying the pass code entered, press “CLEAR” prior to entering a code.

**LOCK SOUND:** To turn “beep” sound On or Off, press the “CLEAR” button twice.

# UNLOCKING SAFE

1. To open safe enter the new pass code that was used to lock the safe in Step 1 of the “LOCKING SAFE” section above (Figure 1).
2. Immediately after entering the code, press the “LOCK” key (Figure 2).
3. Lock bolts should recede into the unlocked position (Figure 3).
4. The LED will display **OPENED** and you can then pull door open using the handle located at the bottom of the keypad (Figure 4).

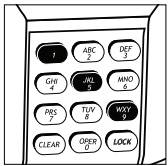

Figure 1

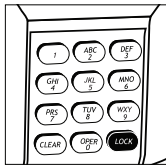

Figure 2

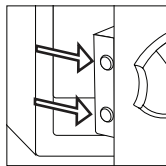

Figure 3

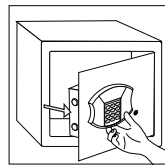

Figure 4

**NOTE:** You can relock the safe by entering any 3-6 digit Pass Code followed by the “LOCK” key

## ENTERING THE WRONG CODE

1. If you press a wrong key while entering your code, you may press “CLEAR” to reset prior to pressing “LOCK” (Figure 1).
2. If you have entered the wrong code followed by “LOCK”, the LED panel will display **E-CODE** (Figure 2).

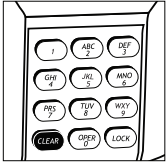

Figure 1

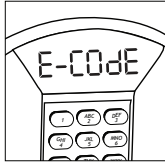

Figure 2

## SECURE LOCKOUT PERIOD

If a wrong code is entered 3 times in a row, the digital keypad will begin a five-minute lockout period. During this period the LED will display **HOLDOS** and the keypad will become disabled. Once the lockout period has expired, the safe can be unlocked using the active code.

### NOTE:

You may use the Override Access Key to open safe, but keypad will complete the full lockout period.

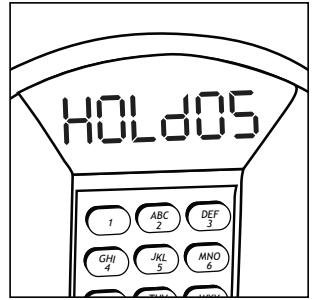

## IF YOU FORGET YOUR PASSCODE

If you forget your passcode AND your key turns to the RIGHT:

1. Insert Override Key and turn to the right to unlock the safe.
2. With the key in the open position, press the “CLEAR” button and the LED will display **NORMAL**.
3. Turn the Override Key to the left and remove it from lock.
4. The safe will be unlocked after entering any 3-6 digit code followed by pressing the “LOCK” button.
5. The safe is returned to normal operation. You may enter any new 3-6 digit code followed by pressing the “LOCK” button.

If you forget your passcode AND your key turns to the LEFT:

1. Screen must be blank. Wait 30 seconds after pressing any key.
2. Insert Override Key and turn to the left to unlock the safe.
3. With the key in the open position, press the “CLEAR” button and the LED will display **NORMAL**.
4. Turn the Override Key to the right and remove it from lock.
5. The safe will be unlocked after entering any 3-6 digit code followed by pressing the “CLEAR” button.
6. The safe is returned to normal operation. You may enter any new 3-6 digit code followed by pressing the “LOCK” button.

## REPLACING BATTERIES

You may check the battery power at any time by pressing the "LOCK" key just once. The LED display will show one of the following messages:

**HI-bAT**: Battery power is good (Figure 1).

**LO-bAT**: Battery power is low and batteries should be replaced (Figure 2).

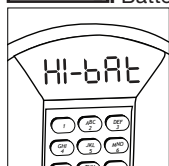

Figure 1

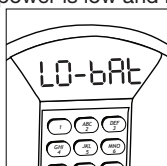

Figure 2

Weak or dead batteries should be replaced immediately and all 4 batteries should be changed. It is NOT RECOMMENDED to use Non-alkaline or rechargeable batteries. Remember to always remove the batteries from the safe if not using it for an extended period of time.

NOTE: The active code will not be erased if the batteries become weak or are removed.

## CARE AND MAINTENANCE

When properly maintained, your safe will continue to operate for many years. In order to ensure optimum performance of your safe, please follow these simple precautions:

**CLEAN HANDS** - Never attempt to operate the digital keypad if your hands have excessive dirt, debris or liquids on them.

**CLEAN SAFE** - To clean the surface of your safe, it is recommended that you use a mild cleaner (e.g., window cleaner) to avoid scratching or discoloring the surface. Always wipe dry and NEVER use abrasive cleansers on the safe or digital keypad.

**MOISTURE** - We recommend that you place delicate items such as pictures or intricate jewelry into an air-tight container before storing them in your safe. Avoid placing your safe in areas of high humidity. For optimum performance, the safe should be opened and aired out for at least 20 minutes every two weeks.

For future reference, store this Operation and Installation Guide in a secure area away from the safe.

**DO NOT DISCARD!**

## REMOVABLE SHELF

**Models 5103S, 5103, 5104, 5107S, 5107, 5108, 5112DOJ, 5113**

**5103GS, 5103G, 5104G, 5107GS, 5107G, 5108G, 5112GDOJ, 5113G**

If your safe is equipped with a removable shelf, it can easily be removed to accommodate the storage of taller or larger items.

1. Empty shelf of all contents and remove any carpeting
2. Remove by lifting and tilting to side to fit through door opening.

DO NOT discard shelf. It is recommended that you keep it for future needs.

## ANCHORING YOUR SAFE

You may bolt your safe to the wall or floor to added theft protection and resistance to tipping. Your safe has pre-drilled bolt-down holes in the back panel and in the floor.

### To secure your safe to the wall and/or floor:

1. Select a suitable and convenient location for your safe.
2. Empty the safe and remove the carpet.
3. Locate the predrilled holes on the inside of safe.
4. Place your safe in the desired location.
5. Line up the predrilled holes and mark the floor or wall through the holes (Figure 1).  
NOTE: It is not recommended to attempt to bolt to both floor and wall.
6. Move the safe aside to clear marked spots for drilling.
7. Drill holes appropriate for hardware being used and the mounting surface (Figure 2).  
INCLUDED: (2 each – bolts, washers and masonry anchors).
8. Place the safe back over the holes and install the fasteners as required (Figure 3).
9. Once completed, replace the carpet.

NOTE: Bolting/unbolting of the unit is at the consumer's expense and discretion. LH Licensed Products is not responsible for any costs incurred if the unit is to be replaced.

If you have any questions about mounting the safe, please check with your local home center/hardware retailer or independent contractor.

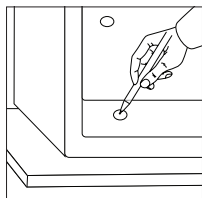

Figure 1

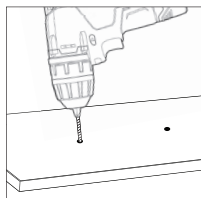

Figure 2

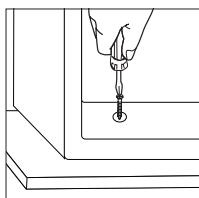
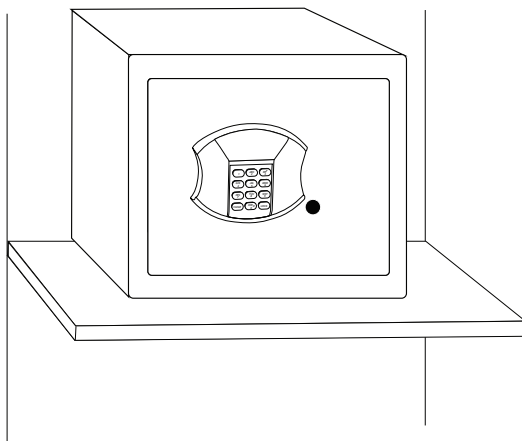

Figure 3





# CONSUMER ASSISTANCE

EMAIL: [LHLPCustomerService@LHLPinc.com](mailto:LHLPCustomerService@LHLPinc.com)

WEBSITE: [www.honeywellsafes.com](http://www.honeywellsafes.com)

ADDRESS: Consumer Assistance Dept.  
LH Licensed Products, Inc., 860 East Sandhill Avenue Carson, CA 90746 USA

TELEPHONE: **US/Canada** 1-877-354-5457 (Toll Free)

**Mexico** 01-800-288-2872 After English voice recording stops you must then enter 800-860-1677 to complete your call. (Toll Free)

**Australia** 0011-800-5325-7000 (Toll Free)

**Germany/New Zealand** 00-800-5325-7000 (Toll Free)

**Other Countries** XX\*-310-323-5722 (Toll Charges Apply)

XX\*- Dial U.S. Country Code first

CALL CENTER HOURS: US/Canada 7am – 5pm (Pacific\*\*) Mon – Fri (Subject to change)

CALL BACK HOURS: Other Countries 7am – 8pm (Pacific\*\*) Mon – Fri (Subject to change)

Pacific Time\*\*- Local time in Los Angeles, CA, USA

\* Insert correct Country Code

\*\* Local Time based on Los Angeles California USA

## INTERNATIONAL CALL BACK HOURS:

If you need to speak with a consumer assistant and cannot contact us during the Call Center hours above, please send an email or leave a telephone message, including your Name, Telephone Number and the best time for us to contact you during the Call Back hours above and we will make our every effort to contact you and help answer any of your questions or concerns.

# ORDERING ADDITIONAL OVERRIDE ACCESS KEYS

The following information is required to order keys:

## 1. PROOF OF OWNERSHIP (1 of 2 Options Below)

### A) SALES RECEIPT & IDENTIFICATION – INTERNATIONAL ORDERS ONLY!

- Copy of sales receipt showing Store, Date & Product Description.
- Copy of your picture I.D. (Drivers license, passport, regular I.D.).

### B) PRODUCT OWNERSHIP VERIFICATION FORM

If sales receipt is not available, contact us by email or telephone to request a “Product Ownership Verification Form”.

## 2. ORDER INFORMATION

### CONTACT

- Name & Shipping Address
- E-mail address (If Available)
- Telephone Number
- Best Time to Contact You

### PRODUCT

- Model #
- Serial #
- Lock Key #
- Quantity of Keys Ordered

## 3. PLACING AN ORDER

- To begin the order process, contact us by telephone, email, or mail

## 4. METHOD OF PAYMENT

- Visa, MasterCard, Check or Money Order

NOTE: For pricing please contact Consumer Assistance. Contact information is located on the back cover of this manual. Payment method and pricing subject to change.

# SAFE IDENTIFICATION RECORD

Model Number: \_\_\_\_\_

Serial Number: \_\_\_\_\_

Override Access Key Number: \_\_\_\_\_



# Limited Warranty

LH Licensed Products, Inc., ("LHLP, Inc.") warrants that for a period of seven (7) years from the date of purchase, this product will be free from structural or mechanical defects resulting from materials or workmanship. LHLP, Inc., at its sole option and as the purchaser's sole remedy under this warranty, will repair or replace this product or any component of the product found to be defective during the warranty period. Replacement or repair will be made with a new or remanufactured product or component. If the product is no longer available, replacement may be made with a similar product of equal or greater value.

## THIS IS YOUR EXCLUSIVE WARRANTY.

Our goods come with guarantees that cannot be excluded under the Australian Consumer Law. You are entitled to a replacement or refund for a major failure and for compensation for any other reasonably foreseeable loss or damage. You are also entitled to have the goods repaired or replaced if the goods fail to be of acceptable quality and the failure does not amount to a major failure.

This warranty is only valid for the original retail purchaser from the date of initial retail purchase and is not transferable. You must keep the original sales receipt. Proof of purchase is required to obtain warranty service.

LHLP, Inc. dealers, service centers, or retail stores selling this product do not have the right to alter, modify or in any way change the terms and conditions of this warranty.

This warranty does not apply to the finish on the product. This warranty does not cover normal wear and tear of parts or damage resulting from any of the following: negligent use or misuse of the product, use contrary to the operating instructions, disassembly, repair or alteration by anyone other than LHLP, Inc. or an authorized service center, improper installation, or exposure to extremes of heat or humidity. Further, the warranty does not cover Acts of God, such as fire, flood, earthquakes, hurricanes and tornadoes.

LHLP, Inc. shall not be liable for any incidental or consequential damages caused by the breach of any express or implied warranty or otherwise relating to the sale of this product. LHLP, Inc. is also not responsible for: costs associated with removing or installing the product; damage or loss of the contents of the product; nor for the unauthorized removal of the contents; or damages incurred during shipment.

THE ABOVE WARRANTY IS IN LIEU OF ALL OTHER WARRANTIES, EXPRESS OR IMPLIED, INCLUDING ANY WARRANTIES OF MERCHANTABILITY OR FITNESS FOR A PARTICULAR PURPOSE, AND LHLP, INC. DISCLAIMS ANY AND ALL OTHER COVENANTS AND WARRANTIES.

Except to the extent prohibited by applicable law, any implied warranty of merchantability or fitness for a particular purpose is limited in duration to the duration of the above warranty period. Some states, provinces or jurisdictions do not allow the exclusion or limitation of incidental or consequential damages or limitations on how long an implied warranty lasts, so the above limitations or exclusion may not apply to you. This warranty gives you specific legal rights, and you may also have other rights that vary from state to state, or province to province, or jurisdiction to jurisdiction.



Manufactured by:  
LH Licensed Products, Inc.  
860 East Sandhill Avenue  
Carson, CA 90746

The Honeywell Trademark is used under license from Honeywell International Inc. Honeywell International Inc. makes no representations or warranties with respect to this product.

## Free Manuals Download Website

<http://myh66.com>

<http://usermanuals.us>

<http://www.somanuals.com>

<http://www.4manuals.cc>

<http://www.manual-lib.com>

<http://www.404manual.com>

<http://www.luxmanual.com>

<http://aubethermostatmanual.com>

Golf course search by state

<http://golfingnear.com>

Email search by domain

<http://emailbydomain.com>

Auto manuals search

<http://auto.somanuals.com>

TV manuals search

<http://tv.somanuals.com>