

# Honeywell

THESE T8611 CHRONOTHERM III PROGRAMMABLE THERMOSTATS PROVIDE AUTOMATIC CONTROL OF MULTISTAGE HEAT PUMP SYSTEMS AND OFFER USERS THE HIGHEST STANDARD OF COMFORT AND CONVENIENCE AVAILABLE WITH ENERGY SAVINGS.

- Different schedules may be selected for weekdays, Saturday and Sunday.
- Can be programmed in hand (with batteries installed) or on the wall to provide up to four temperature settings per period.
- Large digital clock (liquid crystal display) indicates continuous time-of-day, day-of-week, current period and room temperature.
- Adaptive Intelligent Recovery™ brings room temperature to programmed temperature at programmed time, maximizing comfort and energy savings.
- Temperature control program maintains temperature within 1° F of set point.
- Temporary program override available by using—
  - WARMER and COOLER keys
  - SKIP next period key
  - CHANGE to last period key
- HOLD TEMP key provided for indefinite program override (vacation/holiday).
- Installer self-test with time delay override saves installation time.
- ENRG. SAV. and SYSTEM light-emitting diodes (LEDs) included on thermostat.
- AUX. HT., EM. HT., CHECK (some models) light-emitting diodes (LEDs) included on subbase.
- Model available with automatic heat/cool change-over.
- Batteries packed with devices provide power to maintain clock and memory during power failures.
- Thermostats include a switching subbase with wiring terminals.
- Thermostats are powered directly from control transformer.

## CHRONOTHERM III HEAT PUMP THERMOSTATS

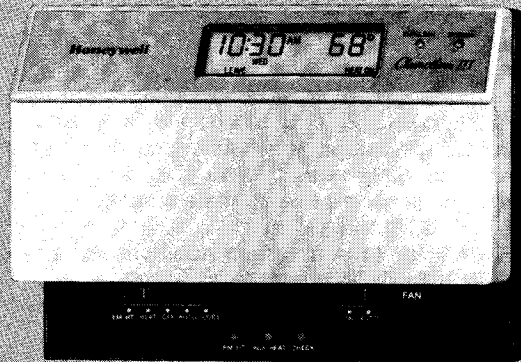

## T8611G,R

# SPECIFICATIONS

## TRADELINE MODELS

TRADELINE models are selected and packaged to provide ease of stocking and handling and also maximum replacement value.

TRADELINE models available are listed in Table I.

TABLE I—TRADELINE MODELS AVAILABLE

| THERMOSTAT | STAGES |      | CHANGEOVER<br>TYPE | SWITCHING                     |         | APPLICATION | PROGRAM |
|------------|--------|------|--------------------|-------------------------------|---------|-------------|---------|
|            | HEAT   | COOL |                    | SYSTEM                        | FAN     |             |         |
| T8611G     | 2      | 1    | AUTOMATIC          | EM.HT.-HEAT-OFF-<br>AUTO-COOL | ON-AUTO | HEAT PUMP   | 5-1-1   |
| T8611R     | 2      | 1    | MANUAL             | EM.HT.-HEAT-OFF-<br>COOL      | ON-AUTO | HEAT PUMP   | 5-1-1   |

**LIGHT-EMITTING DIODES (LEDs):**

ENRG SAV LED (green) on thermostat lights during LEAVE and SLEEP periods.

SYSTEM LED (yellow) on thermostat lights during thermostat ON cycle.

EM.HT. LED (red) on subbase lights when system switch is in EM.HT. On some systems, may light to indicate need to switch to EM.HT. because of heat pump problem.

AUX. HT. LED (green) on subbase lights when thermostat is calling for operation of auxiliary heat.

CHECK LED (yellow) on some subbase models lights when a problem needs to be checked. Consult heat pump literature to determine meaning.

VOLTAGE RATING: 15 to 30 Vac.

CURRENT RATING: 1.6 A maximum, total per stage.

POWER CONSUMPTION: Less than 1.0 watt.

OPERATING HUMIDITY RANGE: 5 to 90 percent relative humidity; noncondensing.

OPERATING AMBIENT TEMPERATURE RANGE: 40° F to 110° F [4° C to 43° C].

SET POINT RANGE: 45° F to 88° F [7° C to 31° C].

CALIBRATION: Self-calibrating thermostat and thermometer to ±1° F.

CHANGEOVER DIFFERENTIAL: 3° F [2° C] on T8611G.

INTERSTAGE DIFFERENTIAL: None. The T8611 controls within 1° F [1° C] of setpoint under all loads.

SHIPPING TEMPERATURE: -20° F to +120° F [-29° C to +49° C].

**CYCLES PER HOUR ADJUSTMENT:**

Auxiliary heating—factory-set at 3 cph (field adjustable to 6 cph for special systems); minimum off-time of five minutes.

First stage heating and cooling—factory-set at 3 cph (not field adjustable); minimum off-time of five minutes.

## ORDERING INFORMATION

**WHEN PURCHASING REPLACEMENT AND MODERNIZATION PRODUCTS FROM YOUR TRADELINE WHOLESALE OR DISTRIBUTOR, REFER TO THE TRADELINE CATALOG OR PRICE SHEETS FOR COMPLETE ORDERING NUMBER, OR SPECIFY—**

- |   |   |
|---|---|
| <ol style="list-style-type: none"> <li>1. Model number.</li> <li>2. Number of heat and cool stages desired.</li> <li>3. <b>MANUAL</b> or <b>AUTO</b> changeover.</li> </ol> | <ol style="list-style-type: none"> <li>4. System, fan switching desired.</li> <li>5. Application.</li> <li>6. Program.</li> </ol> |
|---|---|

**IF YOU HAVE ADDITIONAL QUESTIONS, NEED FURTHER INFORMATION OR WOULD LIKE TO COMMENT ON OUR PRODUCTS OR SERVICES, PLEASE WRITE OR PHONE:**

1. YOUR LOCAL HONEYWELL RESIDENTIAL SALES OFFICE (CHECK WHITE PAGES OF YOUR PHONE DIRECTORY).
2. RESIDENTIAL DIVISION CUSTOMER SERVICE  
HONEYWELL INC., 1885 DOUGLAS DRIVE NORTH  
MINNEAPOLIS, MINNESOTA 55422-4386 (612)542-7500

**IN CANADA—HONEYWELL LIMITED/HONEYWELL LIMITEE, 740 ELLESMERE ROAD, SCARBOROUGH, ONTARIO M1P 2V9. INTERNATIONAL SALES AND SERVICE OFFICES IN ALL PRINCIPAL CITIES OF THE WORLD.**

FINISH: Beige matte with decorative brushed metal faceplate.

DIMENSIONS: Thermostat (mounted on subbase)—7 in. [178 mm] long, 5-5/16 in. [135 mm] high, 1-3/4 in. [44 mm] deep. See Fig. 1 for subbase dimensions.

**REPLACEMENT PARTS:**

220529A Replacement Door.  
AAA alkaline batteries, available locally.

**ACCESSORIES:**

193121A Cover Plate Assembly. Includes cover plate, adapter ring and screws; 6-9/10 in. X 4-3/4 in. [175 mm X 121 mm]. Covers marks left by old thermostat. Allows mounting on vertical or horizontal outlet box.

TG501 Thermostat Guards. Include plastic cover, ring and solid type mounting bases, tumbler lock with 2 keys, and screw anchors.

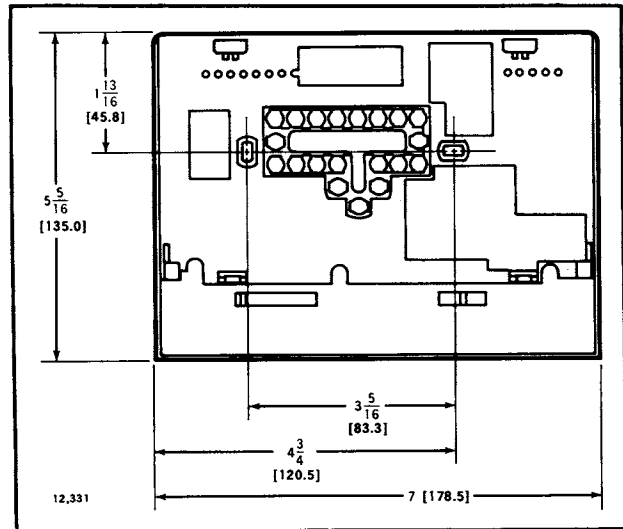

FIG. 1—T8611G,R SUBBASE MOUNTING DIMENSIONS IN in. [mm IN BRACKETS].

## SELECTION/APPLICATION

The T8611 thermostat uses the latest microelectronic design and control technology to provide home and building owners the highest level of comfort available with optimal energy savings in a package that is easy to use and easy to live with.



The following section is intended as a guide to selection and application of the best thermostat to meet individual customer needs. To best meet the need for indoor temperature control, consider the following.

### APPEARANCE AND TECHNOLOGY

Will the owner/occupant be comfortable with and enjoy the modern high-tech look of the new T8611 Chronotherm III, or a familiar clock-type thermostat? See table under Programming for photos.

### PROGRAMMING

Does the thermostat selected accommodate the customer's daily schedule, lifestyle or work schedule? Refer to choices below.

| TRADELINE DEVICE   | PROGRAMMING                 | DAILY TEMP. SELECTION |
|--|-----------------------------|-----------------------|
| T8085R <sup>a</sup><br> | 24-hour; repeats daily      | 2 heat or 2 cool      |
| T8611G,R<br>            | 5-1-1 (Mon-Fri, Sat., Sun.) | 4 heat and 4 cool     |
| T8611M <sup>b</sup><br> | 7-day (each day different)  | 4 heat and 4 cool     |

<sup>a</sup> See specification sheet form no. 68-0010 for information.

<sup>b</sup> See specification sheet form no. 68-0076 for information on 7-day programming models.

### IF NEW CONSTRUCTION APPLICATION, CONSIDER

- the equipment type
  - staging required
  - system switching required
  - status indication provided (see manufacturer's specifications)
- control wiring—number of conductors required to operate equipment and thermostat.

#### IMPORTANT

The T8611 requires a conductor to transformer common to provide continuous 24 V power for thermostat operation. This feature is commonly specified and provided by equipment manufacturer.

### IF RETROFIT/REPLACEMENT APPLICATION, CONSIDER

- the equipment requirements
  - staging (heat stages, cool stages).
  - system switching (manual: Em. Heat-Heat-Off-Cool, automatic: Em. Heat-Heat-Off-Auto-Cool).
  - unique heat pump functions of emergency or supplemental heat, heat to cool changeover, and status indication.
  - table III lists typical applications by manufacturer.
- existing wiring
  - Are there enough conductors to operate the equipment and the thermostat? Can a new cable be pulled?
- existing thermostat
  - Table III is a guide for replacing popular Honeywell standard non-programmable thermostats with a T8611.

## SECURITY

Does the thermostat selected provide access to programming and the override features which will best suit the application? Refer to choices below.

| ACCESS  | TYPICAL APPLICATION                        | DEVICE   |
|---|--|--|
| Free access to programming and adjustment/override. | Home or owner-occupied commercial building | T8085R or T8611  |
| Restricted access to set point, programming.        | Managed building                           | T8085R with locking cover and set point lever restriction. |
| Restricted access to device.                        | Public building                            | T8085R or T8611 with TG501 locking guard.                  |

Table II lists features and wiring terminal functions of two of the more commonly used TRADELINE T8611 thermostats with 5-1-1 programming.

TABLE II—T8611G,R FEATURES AND TERMINALS



| FEATURES  | <br>T8611G1004<br>T8611G1012 (°C) | <br>T8611R1000<br>T8611R1042 (°C) | COMMENTS   |
|---|--|--|--|
| Heating Stages  | 2  | 2  |  |
| Cooling Stages  | 1  | 1  |  |
| Changeover  | Auto   | Manual   |  |
| Programming   | 5-1-1  | 5-1-1  |  |
| System LED  | Yes  | Yes  | Lights on call for heat or cool.   |
| Energy Saving LED   | Yes  | Yes  | Lights during energy-saving LEAVE and SLEEP periods.   |
| EM HEAT LED (red)   | Yes  | Yes  | Lights continuously in EM HEAT mode.   |
| AUX HEAT LED (green)  | Yes  | Yes  | Lights during call for final auxiliary heat stage.   |
| CHECK LED (yellow)  | Yes  | No   | Field wired option; to indicate equipment malfunction.   |
| <b>WIRING TERMINAL FUNCTION</b>   |  |  |  |
| 24 Vac Common   | (C)  | (C)  | Must be connected to control transformer to operate thermostat.  |
| 24 Vac Power  | (R)  | (R)  |  |
| Compressor  | (Y)  | (Y1) (W1)  | Stage 1 cool (Y1) and stage 1 heat (W1) factory-jumpered; remove jumper for separate first stage heat/cool applications. |
| Auxiliary (Resistive) Second Stage Heat   | (W2)   | (W2)   |  |
| Fan   | (G)  | (G)  |  |
| Changeover Heat Mode  | (B)  | (B)  |  |
| Changeover Cool Mode  | (O)  | (O)  |  |
| System Monitor, continuously energized in EM. HEAT mode                           | (L)  | (L)  |  |
| Emergency Heat intermittently energized on call for stage 1 heat in EM. HEAT mode | (E)  | (E)  |  |
| Defrost continuously energized in heat and cool                                   |  | (P)  |  |
| Check LED terminals to indicate equipment malfunction                             | (X1) (X2)  |  | See wiring diagrams for hookup alternatives.   |

TABLE III—T8611 GUIDE FOR REPLACING POPULAR T874 AND T872 THERMOSTATS, BY MANUFACTURER.

| THERMOSTAT (SUBBASE INCLUDED)                                      |  |  |  |  |  |                         | COMMENTS   |
|--|--|--|---|--|--|-------------------------|--|
| Auto changeover 5-1-1 programming<br>T8611G1004<br>T8611G1012 (°C) | Manual changeover 5-1-1 programming<br>T8611R1000<br>T8611R1042 (°C) | Auto changeover 7-day programming<br>T8611M7008<br>(also see 68-0076 spec sheet) | THERMOSTAT  | SUBBASE  | THERMOSTAT   | SUBBASE                 |  |
|  |  |  | T874  | Q674   | T872   | Q672                    |  |
|  |  |  | Amana   |  |  |                         |  |
|  | •  |  | D1009<br>D1017<br>D1165   | F1022  | D1003<br>D1011<br>D1300  | F1026                   | Separate first stage heat/cool terminals W1, Y1.   |
| •  | •  | •  | Arco/Comfort Maker  |  |  |                         |  |
|  |  |  | na  | na   | na   | na                      | Check LED optional; X = X1, jump X2 to C.  |
| •  | •  | •  | Arco/Friedrich  |  |  |                         |  |
|  |  |  | na  | na   | na   | na                      | Changeover on heat, check LED optional.  |
| •  | •  | •  | Bard  |  |  |                         |  |
|  |  |  | N1024<br>R1129  | F1261<br>L1181   | N1036<br>R1146   | F1299<br>L1185          | Changeover on heat (typ.) check LED optional, equipment terminal W1 to thermostat B.                         |
| •  | •  | •  | Bryant, Day-Night, Payne  |  |  |                         |  |
|  |  |  | G1451<br>G1261<br>J1010<br>R1335  | F1113<br>F1253<br>L1371<br>L1405                                     | G1166<br>G1174   | F1125                   | Check LED optional; F = X1, jump X2 to C. Note: "P" terminal available on manual changeover models only.     |
| •  | •  | •  | Carrier   |  |  |                         |  |
|  |  |  | G1055<br>G1071<br>G1121   | J1035<br>L1041<br>L1397<br>P1005                                     | G1075<br>G1158<br>G1182<br>G1273<br>G1307<br>G1257                                 | J1054<br>L1052          | Check LED optional (typical)   |
| •  | •  | •  | J1002<br>J1028<br>D1074   | L1371<br>L1074<br>F1059<br>F1030<br>F1063<br>E1114<br>E1042<br>L1116 |  | L1169                   | Multistage heat pump   |
| •  | •  | •  | D1264   |  |  |                         | No Supl. Ht. function<br>No Supl. Ht. function<br>Multistage heat pump                                       |
| •  | •  | •  | Command Aire  |  |  |                         |  |
|  |  |  | H1005<br>G1352  | C1041<br>C1066   | H1009  | C1086                   | No AUX. HEAT or EM. HEAT required; Y1 = 0  |
| •  | •  | •  | Coleman   |  |  |                         |  |
|  |  |  | R1368   | L1421  | na   | na                      | Late models optional check LED. Z = X2, jump X1 and C, K = L.  |
| •  | •  | •  | na  | na   | na   | na                      | Earlier T.H.E. models with reverse-acting EM. HT. require relay isolation.                                   |
| •  | •  | •  | Crispaire/Marvair   |  |  |                         |  |
|  |  |  | G1089<br>R1111  | F1162<br>F1204<br>L1215  | G1208<br>R1156   | F1166<br>F1323<br>L1094 |  |
| •  | •  | •  | Fedders/Airtemp/Climatrol   |  |  |                         |  |
|  |  |  | C1398<br>C1406<br>C1414   | L1090  | C1509<br>C1517<br>C1541  | L1102                   | Separate first stage heat/cool terminals required; check LED optional; equipment terminal K to thermostat E. |

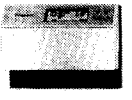
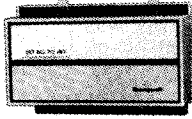

continued

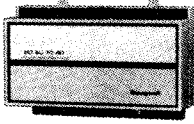
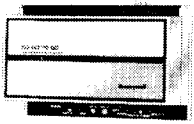
TABLE III (continued)

| THERMOSTAT (SUBBASE INCLUDED)                                |  |  |  |                                  |  |                                  | COMMENTS   |
|--|--|--|---|----------------------------------|--|----------------------------------|--|
| Auto changeover 5-1-1 programming T8611G1004 T8611G1012 (°C) | Manual changeover 5-1-1 programming T8611R1000 T8611R1042 (°C) | Auto changeover 7-day programming T8611M7008 (also see 68-0076 spec sheet) | THERMOSTAT  | SUBBASE                          | THERMOSTAT   | SUBBASE                          |  |
|  |  |  | T874  | Q674                             | T872   | Q672                             |  |
| •  | •  | •  | Florida Heat Pump   |                                  |  |                                  | Optional check LED; X = X1, jump X2 to C.  |
|  |  |  | na  | na                               | na   | na                               |  |
| •  | •  | •  | Heatwave/Southwest Mfg.   |                                  |  |                                  |  |
|  |  |  | G1105   | F1170                            | G1232  | F1224                            |  |
| •  | •  | •  | Heil Quaker/Whirlpool/Tempstar  |                                  |  |                                  | Equipment terminal B to thermostat C.  |
|  |  |  | R1137   | L1132                            | R1172  | L1193                            |  |
| •  | •  | •  | Honeywell   |                                  |  |                                  | Separate first stage heat/cool terminals.<br>°C<br>°C<br>TRADELINE<br>°C<br>Changeover on heat; equipment terminal C to thermostat Y, W1 to B, K to E. |
|  |  |  | A-D (typ.)  | F1006<br>F1022<br>F1048<br>F1089 | A-D (typ.)   | F1000<br>F1026<br>F1042<br>F1075 |  |
| •  | •  | •  | C1000   |                                  | C1004  |                                  |  |
| •  | •  | •  | C1018   |                                  | C1038  |                                  |  |
| •  | •  | •  | C1117   |                                  | C1350  |                                  |  |
| •  | •  | •  | C1240   |                                  | C1566  |                                  |  |
| •  | •  | •  | G1246   | F1212                            | G1224  | F1208                            |  |
| •  | •  | •  | G1444   |                                  | G1000  | F1018                            |  |
| •  | •  | •  |   |                                  | G1018  |                                  |  |
| •  | •  | •  | G1212   | F1238                            | G1083  | F1158                            |  |
| •  | •  | •  | G1139   |                                  |  |                                  |  |
| •  | •  | •  | N1016   | F1220                            | N1002  | F1133                            |  |
| •  | •  | •  | N1040   | F1261                            | N1028  | F1216                            |  |
| •  | •  | •  | R1004   | B1042                            | R1008  | B1046                            |  |
| •  | •  | •  |   | B1109                            | R1057  | L1037                            |  |
| •  | •  | •  | R1152   | L1207                            | R1198  | L1227                            |  |
| •  | •  | •  | R1285   | L1157                            |  |                                  |  |
| •  | •  | •  | R1350   | L1181                            |  |                                  |  |
| •  | •  | •  | Janitrol/Tappan   |                                  |  |                                  | Equipment terminal C to thermostat C.  |
|  |  |  | G1147   | F1139                            | G1109  | F1117                            |  |
| •  | •  | •  | Lennox  |                                  |  |                                  | NOTE: Rewire for single 75 Va transformer if two-transformer system.<br>°C<br>DoD specs—use guard.   |
|  |  |  | G1014   | F1113                            | G1026  | F1067                            |  |
| •  | •  | •  | G1022   | E1148                            | G1125  | E1019                            |  |
| •  | •  | •  | G1162   |                                  | G1091  |                                  |  |
| •  | •  | •  | G1154   | F1105                            | G1323  | L1201                            |  |
| •  | •  | •  | R1024   | B1160                            |  |                                  |  |
| •  | •  | •  | R1040   | B1202                            |  |                                  |  |
| •  | •  | •  | R1178   | L1355                            |  |                                  |  |
| •  | •  | •  |   | L1165                            |  |                                  |  |
| •  | •  | •  | C1148   | L1165                            |  |                                  |  |
| •  | •  | •  | D1207   | L1199                            |  |                                  |  |
|  |  |  |   | L1389                            |  |                                  |  |
|  |  |  | Terminal Conversion Guide:  |                                  |  |                                  |  |
|  |  |  |   | Lennox                           | Standard   |                                  |  |
|  |  |  | Transformer   |                                  |  |                                  |  |
|  |  |  | Common  | X                                | C  |                                  |  |
|  |  |  | Transformer   |                                  |  |                                  |  |
|  |  |  | Power   | VR (in)                          | R  |                                  |  |
|  |  |  |   | V (out)                          |  |                                  |  |
|  |  |  | Compressor  | M                                | Y  |                                  |  |
|  |  |  |   | M2                               | Y2   |                                  |  |

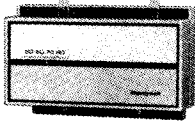

continued

TABLE III (continued)

| THERMOSTAT (SUBBASE INCLUDED)                                |  |  |  |         |  |         | COMMENTS  |  |        |          |              |   |    |     |   |   |                   |   |   |         |   |           |                    |   |   |            |   |                  |
|--|--|--|---|---------|--|---------|---|--|--------|----------|--------------|---|----|-----|---|---|-------------------|---|---|---------|---|-----------|--------------------|---|---|------------|---|------------------|
| Auto changeover 5-1-1 programming T8611G1004 T8611G1012 (°C) | Manual changeover 5-1-1 programming T8611R1000 T8611R1042 (°C) | Auto changeover 7-day programming T8611M7008 (also see 68-0076 spec sheet) | THERMOSTAT  | SUBBASE | THERMOSTAT   | SUBBASE |   |  |        |          |              |   |    |     |   |   |                   |   |   |         |   |           |                    |   |   |            |   |                  |
|  |  |  | T874  | Q674    | T872   | Q672    |   |  |        |          |              |   |    |     |   |   |                   |   |   |         |   |           |                    |   |   |            |   |                  |
|  |  |  |   |         |  |         | <table border="1"> <thead> <tr> <th></th> <th>Lennox</th> <th>Standard</th> </tr> </thead> <tbody> <tr> <td>Aux. Heating</td> <td>Y</td> <td>W2</td> </tr> <tr> <td>Fan</td> <td>F</td> <td>G</td> </tr> <tr> <td>Changeover System</td> <td>R</td> <td>O</td> </tr> <tr> <td>Monitor</td> <td>L</td> <td>L, X1, X2</td> </tr> <tr> <td>Em. Heat (Cycling)</td> <td>E</td> <td>E</td> </tr> <tr> <td>Thermistor</td> <td>A</td> <td>T (not required)</td> </tr> </tbody> </table> |  | Lennox | Standard | Aux. Heating | Y | W2 | Fan | F | G | Changeover System | R | O | Monitor | L | L, X1, X2 | Em. Heat (Cycling) | E | E | Thermistor | A | T (not required) |
|  | Lennox   | Standard   |   |         |  |         |   |  |        |          |              |   |    |     |   |   |                   |   |   |         |   |           |                    |   |   |            |   |                  |
| Aux. Heating   | Y  | W2   |   |         |  |         |   |  |        |          |              |   |    |     |   |   |                   |   |   |         |   |           |                    |   |   |            |   |                  |
| Fan  | F  | G  |   |         |  |         |   |  |        |          |              |   |    |     |   |   |                   |   |   |         |   |           |                    |   |   |            |   |                  |
| Changeover System  | R  | O  |   |         |  |         |   |  |        |          |              |   |    |     |   |   |                   |   |   |         |   |           |                    |   |   |            |   |                  |
| Monitor  | L  | L, X1, X2  |   |         |  |         |   |  |        |          |              |   |    |     |   |   |                   |   |   |         |   |           |                    |   |   |            |   |                  |
| Em. Heat (Cycling)   | E  | E  |   |         |  |         |   |  |        |          |              |   |    |     |   |   |                   |   |   |         |   |           |                    |   |   |            |   |                  |
| Thermistor   | A  | T (not required)   |   |         |  |         |   |  |        |          |              |   |    |     |   |   |                   |   |   |         |   |           |                    |   |   |            |   |                  |
| •  | •  | •  | Luxaire   |         |  |         |   |  |        |          |              |   |    |     |   |   |                   |   |   |         |   |           |                    |   |   |            |   |                  |
|  |  |  | G (Borg Warner)   | F1188   | G1315  | F1281   |   |  |        |          |              |   |    |     |   |   |                   |   |   |         |   |           |                    |   |   |            |   |                  |
| •  | •  | •  | Magic Chef  |         |  |         |   |  |        |          |              |   |    |     |   |   |                   |   |   |         |   |           |                    |   |   |            |   |                  |
|  |  |  | na  | na      | na   | na      | Earlier "PB" series, separate first stage heat/cool.<br>Late "PE" series, optional check LED, X1 = X1, jump X2 to R.  |  |        |          |              |   |    |     |   |   |                   |   |   |         |   |           |                    |   |   |            |   |                  |
| •  | •  | •  | na  | na      | na   | na      |   |  |        |          |              |   |    |     |   |   |                   |   |   |         |   |           |                    |   |   |            |   |                  |
| •  | •  | •  | Rheem/Ruud  |         |  |         |   |  |        |          |              |   |    |     |   |   |                   |   |   |         |   |           |                    |   |   |            |   |                  |
|  |  |  | G1097   | F1238   | G1133  | F1158   |   |  |        |          |              |   |    |     |   |   |                   |   |   |         |   |           |                    |   |   |            |   |                  |
|  |  |  | G1238   |         | G1141  | L1157   |   |  |        |          |              |   |    |     |   |   |                   |   |   |         |   |           |                    |   |   |            |   |                  |
|  |  |  | G1220   | R1081   | L1045  |         |   |  |        |          |              |   |    |     |   |   |                   |   |   |         |   |           |                    |   |   |            |   |                  |
|  |  |  | R1079   | R1107   | L1136  |         |   |  |        |          |              |   |    |     |   |   |                   |   |   |         |   |           |                    |   |   |            |   |                  |
|  |  |  | R1095   |         |  |         |   |  |        |          |              |   |    |     |   |   |                   |   |   |         |   |           |                    |   |   |            |   |                  |
| •  | •  | •  | Square D/Sun Dial   |         |  |         |   |  |        |          |              |   |    |     |   |   |                   |   |   |         |   |           |                    |   |   |            |   |                  |
|  |  |  | C1224   | F1071   | C1525  | F1182   | Separate first stage heat/cool required; optional check LED; X = X1, jumper X2 to R.  |  |        |          |              |   |    |     |   |   |                   |   |   |         |   |           |                    |   |   |            |   |                  |
| •  | •  | •  | Trane/General Electric  |         |  |         |   |  |        |          |              |   |    |     |   |   |                   |   |   |         |   |           |                    |   |   |            |   |                  |
|  |  |  | G1204   | J1043   | G1059  | J1039   | Optional check LED; F = X1, jump X2 to C, T not used; equipment terminal B to thermostat X, R to R, Y to Y (Y1 + W1), W to W2, G to G, O to O, X2 to E.   |  |        |          |              |   |    |     |   |   |                   |   |   |         |   |           |                    |   |   |            |   |                  |
| •  | •  | •  | Weather King  |         |  |         |   |  |        |          |              |   |    |     |   |   |                   |   |   |         |   |           |                    |   |   |            |   |                  |
|  |  |  | na  | na      | G1265  | F1265   | Optional check LED; X = X1, jump X2 to R; equipment terminal C to thermostat C, W1 to Y (W1 + Y1), E to W2, Y1 to O.  |  |        |          |              |   |    |     |   |   |                   |   |   |         |   |           |                    |   |   |            |   |                  |
| •  | •  | •  | Wesco/Addison   |         |  |         |   |  |        |          |              |   |    |     |   |   |                   |   |   |         |   |           |                    |   |   |            |   |                  |
|  |  |  | G1287   | F1253   |  |         | Equipment terminal C1 to thermostat C, W1 to Y (W1 + Y1), Y1 to O. Common to thermostat direct from control transformer.  |  |        |          |              |   |    |     |   |   |                   |   |   |         |   |           |                    |   |   |            |   |                  |
|  |  |  | R1012   | B1109   | R1016  | B1103   |   |  |        |          |              |   |    |     |   |   |                   |   |   |         |   |           |                    |   |   |            |   |                  |
|  |  |  |   |         | G1265  | F1265   |   |  |        |          |              |   |    |     |   |   |                   |   |   |         |   |           |                    |   |   |            |   |                  |
|  |  |  |   |         | G1281  |         |   |  |        |          |              |   |    |     |   |   |                   |   |   |         |   |           |                    |   |   |            |   |                  |

continued

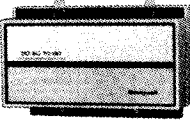
TABLE III—(Continued)

| THERMOSTAT (SUBBASE INCLUDED)                                |  |  |  |   |  |   | COMMENTS   |
|--|--|--|---|---|--|---|--|
| Auto changeover 5-1-1 programming T8611G1004 T8611G1012 (°C) | Manual changeover 5-1-1 programming T8611R1000 T8611R1042 (°C) | Auto changeover 7-day programming T8611M7008 (also see 68-0076 spec sheet) | THERMOSTAT  | SUBBASE                                   | THERMOSTAT   | SUBBASE                                   |  |
|  |  |  | T874  | Q674                                      | T872   | Q672                                      |  |
|  |  |  | Westinghouse  |   |  |   |  |
| •  | •  | •  | G1048   | F1121<br>F1246<br>F1279<br>J1019<br>J1050 | G1034  | F1141<br>F1091<br>F1257<br>J1013<br>J1062 |  |
| •  | •  | •  | R1103   | L1108<br>L1173                            | R1149  | L1110<br>L1128<br>L1151                   |  |
| •  | •  | •  | na  | na  | na   | na  | Separate first stage heat/cool terminals required.   |
| •  | •  | •  | D1108   | L1223                                     | G1356  | L1219                                     | 2-speed heat pump; optional check LED; L = X1, jump X2 to C.   |
|  |  |  | White Rodgers   |   |  |   |  |
| •  | •  | •  | na  | na  | na   | na  | 1F58-910/S28 series.   |
|  |  |  | Williamson  |   |  |   |  |
| •  | •  | •  | R1236   | L1348                                     | na   | na  |  |
| •  | •  | •  | N1008   | F1196                                     | na   | na  | Changeover on heat; W1 = B.  |
|  |  |  | York/Borg Warner  |   |  |   |  |
| •  | •  | •  | G1170   | J1027                                     | G1042  | J1021                                     |  |
| •  | •  | •  | G1295   | F1311                                     | G1299  | L1177                                     | Optional check LED; X = X1, jump X2 to C; equipment terminal B to thermostat C, W to W2, H to B, T not required. |
| •  | •  | •  | G1345   | L1363                                     | G1331  | D1077                                     |  |
| •  | •  | •  | G1402   | D1032                                     | G1364  |   |  |
| •  | •  | •  | G1410   |   | G1398  |   |  |
| •  | •  | •  | G1428   |   |  |   |  |
| •  | •  | •  | G1436   |   |  |   |  |
| •  | •  | •  | R1046   | L1017                                     | R1032  | L1011                                     |  |
| •  | •  | •  | R1169   | L1330                                     |  |   |  |
| •  | •  | •  | R1251   | L1272                                     |  |   |  |
|  |  |  | Zone Aire   |   |  |   |  |
| •  | •  | •  | N1040   | F1261                                     |  |   |  |
| •  | •  | •  | R1350   | L1181                                     |  |   | Changeover on heat; W1 = B.  |



# INSTALLATION

## COMPATIBILITY

The T8611G,R Thermostats will replace most 2-heat/1-cool heat pump thermostats. As long as ac power is continuously available to the transformer, the thermostat will be compatible with almost any low-volt control system.

## WHEN INSTALLING THIS PRODUCT...

1. Read these instructions carefully. Failure to follow them could damage the product or cause a hazardous condition.
2. Check the ratings and description given on the product to make sure the product is suitable for your application.
3. Installer must be a trained, experienced service technician.
4. Allow thermostat to warm to room temperature before operating.
5. After installation is complete, check out product operation as provided in these instructions.

## CAUTION

Disconnect power supply to prevent electrical shock or equipment damage.

## LOCATION

Install thermostat and subbase about 5 ft. [1.5 m] above the floor in an area with good air circulation at room temperature.

Do not install the thermostat where it may be affected by—

- drafts or dead spots behind doors, in corners or under cabinets.
- hot or cold air from ducts.
- radiant heat from sun or appliances.
- concealed pipes and chimneys.
- unheated (uncooled) areas behind the thermostat, such as an outside wall.

## IF REPLACING AN EXISTING THERMOSTAT

Turn thermostat power off at heat pump. A two-transformer system may require turning off two switches or disconnects. Remove any existing wallplate or subbase from wall. Label or write down each wire color with the letter or number on the wiring terminal as the wire is removed, to avoid miswiring later.

## IF NEW INSTALLATION

Run cable to a hole at the selected wall location, and pull about 3 in. [76 mm] of wire through the opening. Color-coded, 18-gauge thermostat cable with at least one conductor for each wiring terminal is recommended. Good service practice recommends selection of cable with one or two more conductors than the immediate application requires.

## MOUNTING SUBBASE

### IMPORTANT

Mount the subbase with the system switch in the OFF position only.

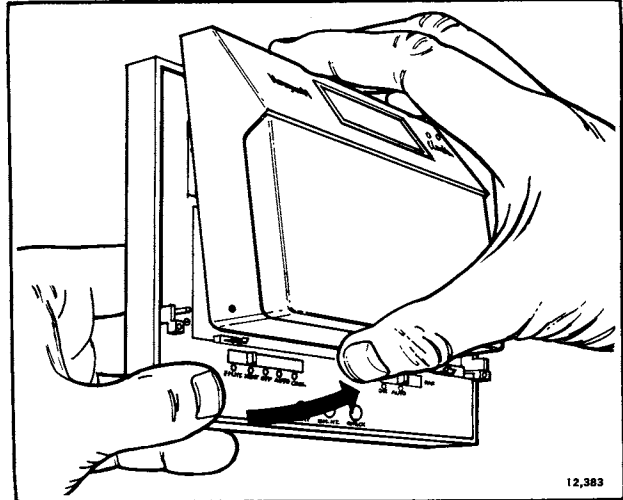

FIG. 2—REMOVING THERMOSTAT FROM SUBBASE.

The subbase does not require leveling for operation, but for appearance only.

Loosen captive mounting screws, and remove thermostat from subbase (Fig. 2).

The subbase mounts directly onto the wall with the screws and anchors included in the package.

Use the subbase as a template, and with a pencil, mark the two mounting screw positions (Fig. 3).

If drywall construction, plastic anchors must be used; use 3/16 in. bit to drill holes for anchors. Gently tap anchors into holes until they are flush to the wall surface.

Thread wires through the center opening of the subbase.

Mount the subbase using two screws provided. Gently tighten screws, level top surface of subbase, then securely tighten screws.

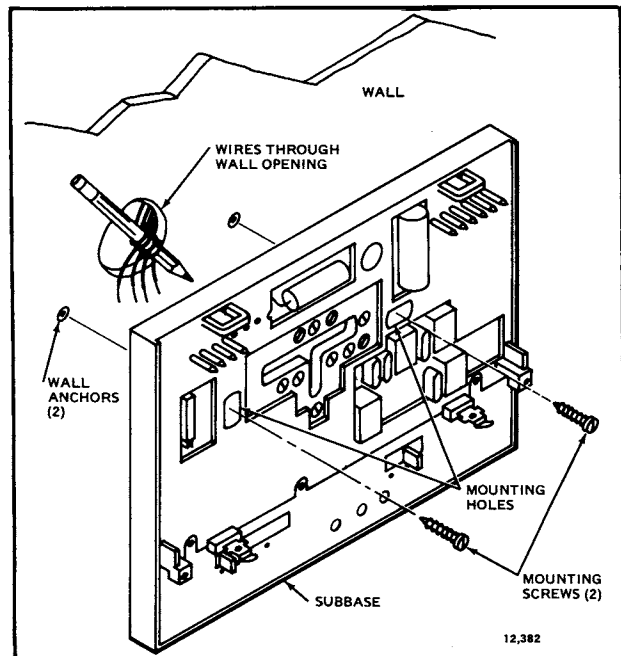

FIG. 3—MOUNTING SUBBASE ON WALL.

## WIRING

All wiring must comply with local electrical codes and ordinances.

Disconnect power before wiring to prevent electrical shock or equipment damage.

The shape of the terminal barrier permits insertion of straight or conventional wraparound wiring connections. Either method is acceptable.

Push excess wire back into the hole, and plug hole with nonhardening caulk, putty or insulation to prevent drafts from affecting thermostat operation.

Refer to Figs. 5-6 for typical hookups of subbase and thermostat.

NOTE: Keep all wiring restricted to recessed area surrounding terminals (Fig. 4) to assure thermostat/subbase contact.

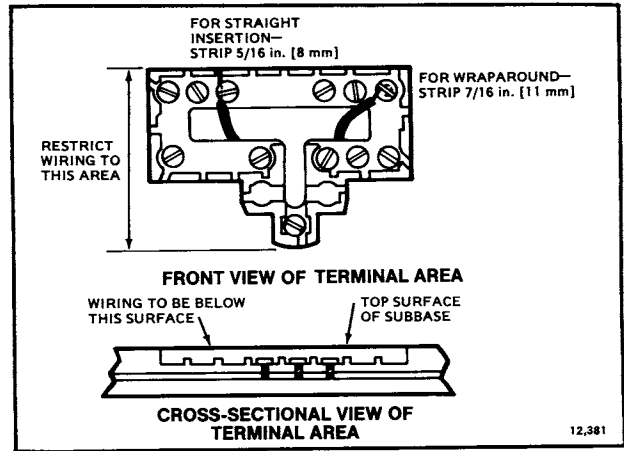

FIG. 4—KEEP WIRING RESTRICTED TO RECESSED AREA SURROUNDING TERMINALS.

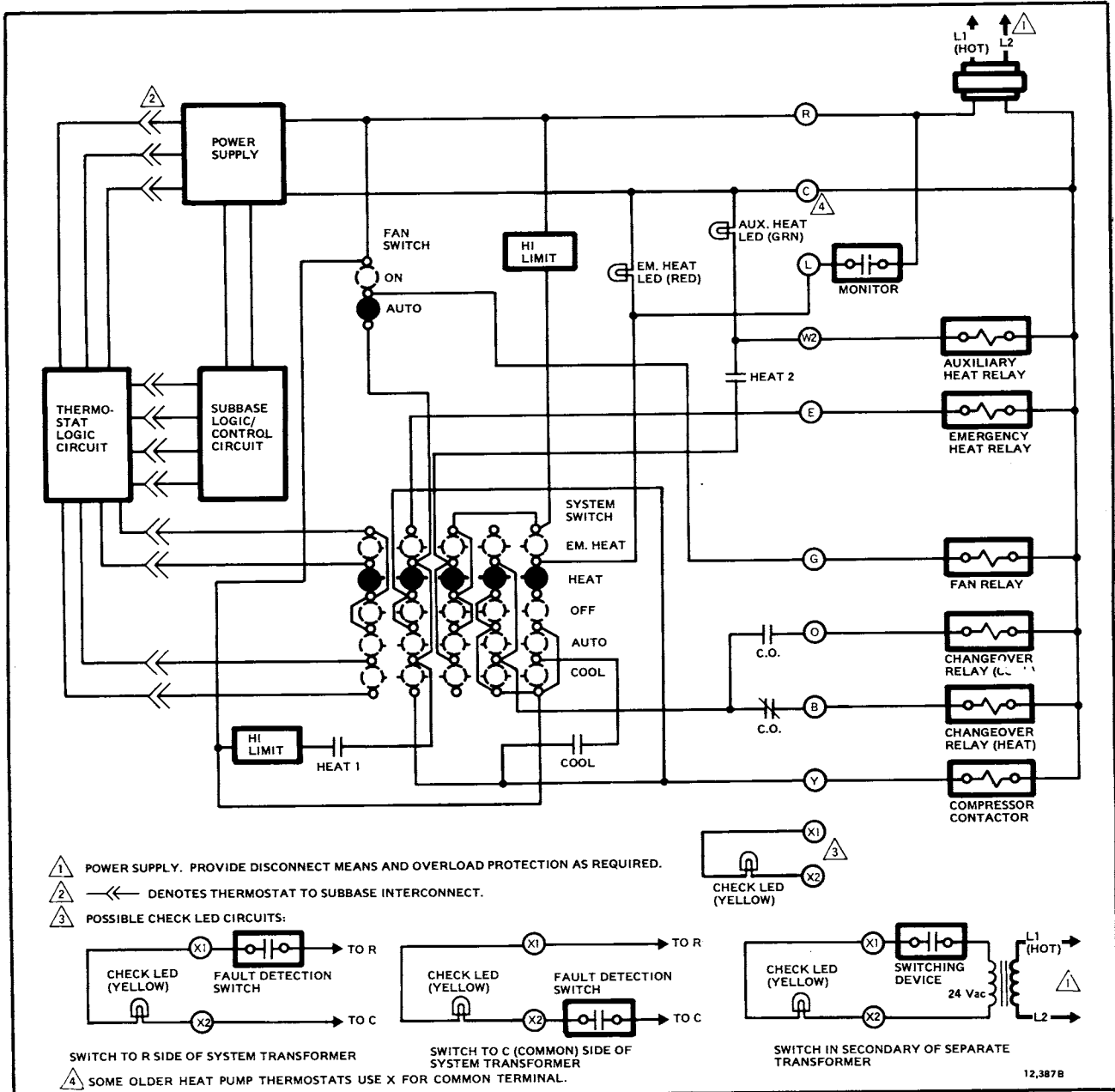

FIG. 5—T8611G HEATING/COOLING WIRING DIAGRAM; AUTO CHANGEOVER.

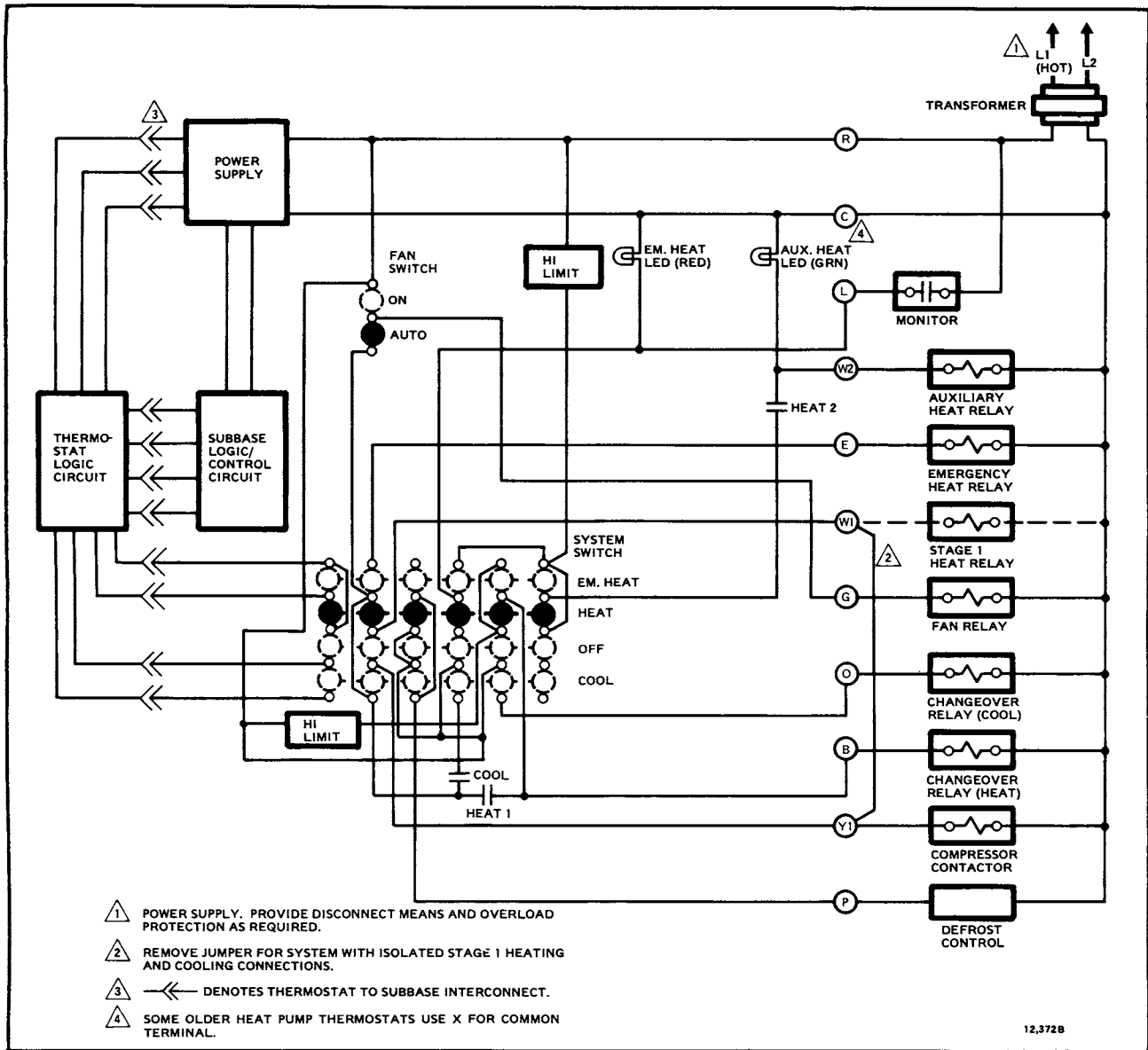

FIG. 6—T8611R HEATING/COOLING WIRING DIAGRAM; MANUAL CHANGEOVER.

### ADJUSTING CYCLE RATE

To custom-tailor the thermostat's cycling performance to different types of auxiliary heating equipment, a cycle rate adjustment screw is provided on the back of the thermostat. Correct setting of this screw will provide optimum savings and occupant comfort.

NOTE: MOST APPLICATIONS WILL NOT REQUIRE A CHANGE IN CYCLE RATE.

The room air temperature will normally vary slightly from the comfort temperature setting with the cycling of the heat pump or auxiliary heater.

The cycle rate of these thermostats is factory-set for heat pumps. The heat pump compressor cycle rate can not be adjusted. The auxiliary heat cycle rate can be adjusted by turning the cycle rate adjustment screw located on the back of the thermostat. See Fig. 7. Increasing the cycle rate will reduce room temperature swings.

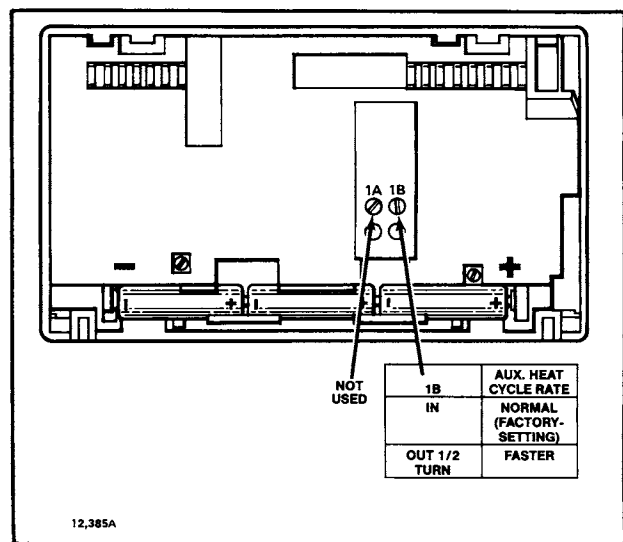

FIG. 7—CYCLE RATE ADJUSTMENT.

## INSTALLING BATTERIES

Three AAA alkaline batteries are provided as backup to prevent program loss in case of power outage. Batteries are included with thermostat. Install batteries in back of thermostat as shown in Fig. 8.

Without battery backup, the program will remain about 20 seconds in event of power loss. When batteries are first installed, the display will flash 1:00 PM and 32°. After a brief delay, the display will flash 1:00 PM and room temperature.

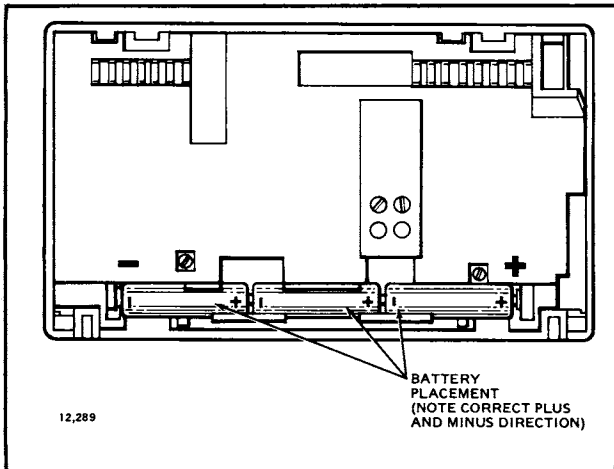

FIG. 8—BATTERY PLACEMENT.

When the batteries are low, the display will flash REPL BAT. Homeowner will have 20-30 seconds to replace batteries after removing batteries from thermostat. After 20-30 seconds, it will be necessary to reprogram. REPL BAT indication will disappear when thermostat is mounted back on the powered subbase.

If batteries are completely dead, the display will go blank when the thermostat is removed from subbase. After replacing the battery in this case, reprogramming will be necessary.

## POWER OUTAGES

Backup batteries will hold the programming and keep the display on during most power outages. Once the power is restored, the system will resume normal operation.

If the display goes off when power is lost, either the backup batteries need to be replaced or are not installed. When power is restored, the display will flash 1:00 PM to remind you to reprogram.

## MOUNTING THE THERMOSTAT

With the system switch set to OFF, hang the thermostat on the tabs at the top of the subbase (Fig. 9a). Swing down and press on lower edge until thermostat snaps in place (Fig. 9b). Open cover and tighten the captive mounting screws (Fig. 9c).

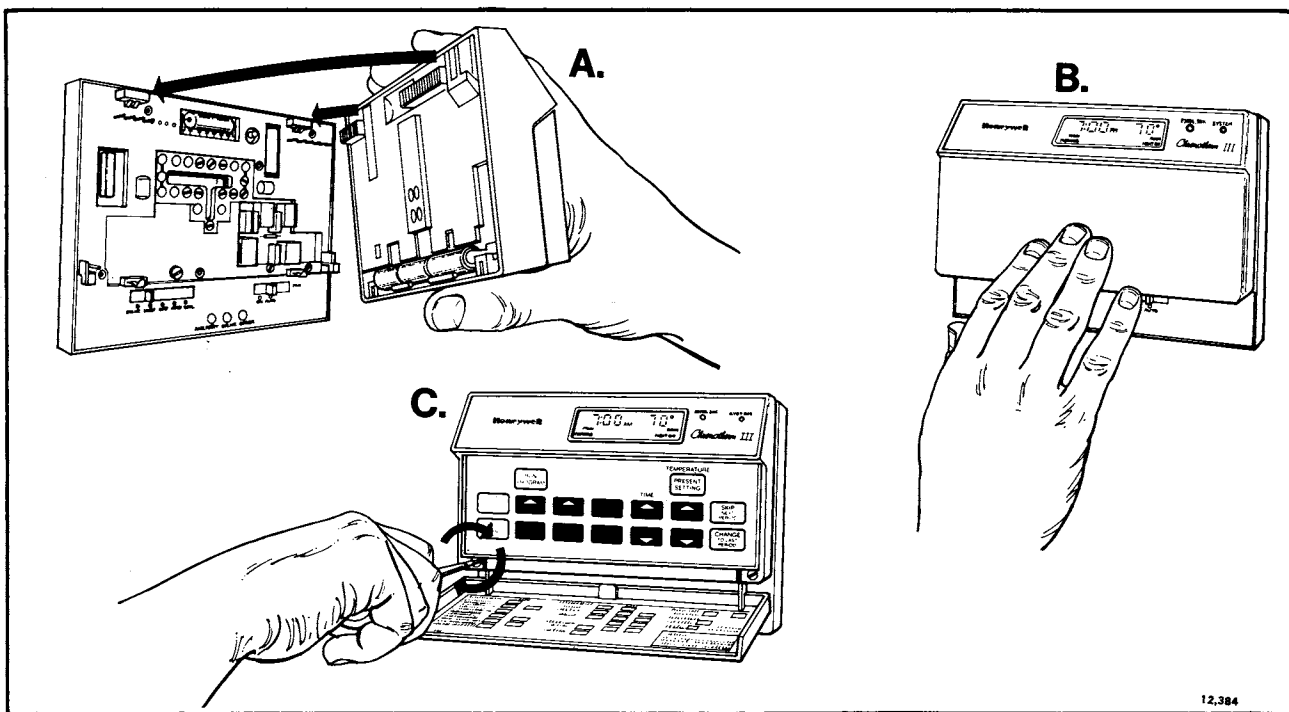

FIG. 9—MOUNTING THE THERMOSTAT ON SUBBASE.

## SETTING DAY AND TIME

Restore 24 V power to the thermostat. Set present day and time.

Press .

Press to set the current day. Each press of the DAY key advances the display one day.

Press TIME or to set the current time.

- If the display will not come on,
- check mounting of thermostat to subbase. If loose or misaligned, remove thermostat and reinstall on the subbase, making sure it is firmly attached.
  - check to see that system power is on.
  - check voltage between R and C; should be 20 to 30 Vac.

# CHECKOUT

## CAUTION

During cold weather, some heat pumps will require that crankcase heater be energized several hours before operating heat pump. Refer to manufacturer's recommendations.

## HEATING

**NOTE:** When heating setting is changed, thermostat will wait up to 5 minutes before turning on the heating equipment. This delay protects the compressor.

Move the system switch to HEAT and the fan switch to AUTO. Press WARMER key until the setting is about 10° F [6° C] above room temperature. Heating should start and the fan should run (there may be a delay of 5-10 minutes before heat turns on). Press COOLER key until the setting is about 10° F [6° C] below room temperature. The heating equipment and fan should shut off.

**NOTE:** On an AUTO changeover thermostat, the cooling temperature must be set at least 3° F [2° C] above the heating temperature, or display will flash.

## COOLING

## CAUTION

Do not operate cooling if outdoor temperature is below 50° F [10° C]. Refer to manufacturer's recommendations.

**NOTE:** When cooling setting is changed, thermostat will wait up to five minutes before turning on the cooling equipment. This delay protects the compressor.

Move the system switch to COOL and the fan switch to AUTO. Press COOLER key until the setting is about 10° F [6° C] below room temperature. The cooling equipment and fan should start. Press WARMER key until the setting is about 10° F [6° C] above room temperature. The cooling equipment and fan should stop.

**NOTE:** On an AUTO changeover thermostat, the heating temperature must be set at least 3° F [2° C] below the cooling temperature, or display will flash.

## FAN

Move the system switch to OFF, and the fan switch to ON. The fan should run continuously. When the fan switch is in the AUTO position, fan cycles with the heating or cooling system.

## INSTALLER SELF-TEST (OPTIONAL)

### IMPORTANT

- Thermostat must have AC power to perform self-test.
- Five-minute time delay on compressor does not function during self-test.

Perform the following test as a check of all thermostat functions. If thermostat does not respond as indicated, thermostat must be replaced.

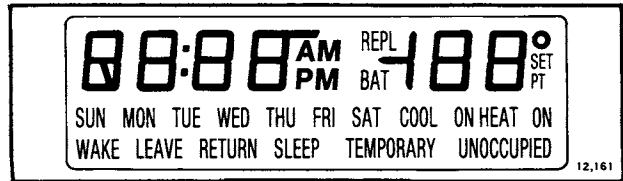

**FIG. 10—ALL SEGMENTS ON DISPLAY.**

1. Press AHEAD and BACK keys at the same time. While holding keys down, all segments of the display should be on (see Fig. 10).

2. Set system switch to OFF. Press AHEAD and BACK and PRESENT SETTING keys at the same time to enter self-test.

3. Press each key as listed below, and look for responses listed, as key is held down and released. Keys may be pressed in any order, except RUN PROGRAM should be pressed last, as it ends self-test.

| Press this key.            | Look for this response. |  |
|----------------------------|-------------------------|--|
|                            | Key Down                | Key Released   |
| PRESENT SETTING            | 15                      | see note a following   |
| SKIP NEXT PERIOD           | 07                      | blank  |
| CHANGE TO LAST PERIOD      | 03                      | blank  |
| COOLER                     | 02                      | blank  |
| WARMER                     | 06                      | blank  |
| BACK                       | 04                      | blank  |
| AHEAD                      | 05                      | blank  |
| RETURN                     | 00                      | blank  |
| LEAVE                      | 01                      | blank  |
| SLEEP                      | 08                      | blank  |
| WAKE                       | 12                      | see note b following   |
| SET HEAT/COOL              | 09                      | blank  |
| DAY                        | 13                      | micro-processor mask number and revision number                      |
| HOLD TEMP                  | 10                      | blank  |
| SET PRESENT DAY/TIME       | 14                      | see note c following   |
| RUN PROGRAM (first press)  | 11                      | colon flashes, followed by normal operating display one minute later |
| RUN PROGRAM (second press) |                         | normal operating display   |

<sup>a</sup> Allows manual operation of cooling equipment, bypassing 5-minute time delay. If the system switch is in COOL or AUTO, the following sequence will occur:

**CAUTION**

Do not operate cooling if outdoor temperature is below 50° F [10° C]. Refer to manufacturer's recommendations.

First press—cooling system and SYSTEM LED on.  
 Second press—cooling system and SYSTEM LED off.

<sup>b</sup> Allows checkout of model type and configuration. HEAT will be displayed when system switch is in heat, COOL when in cool, HEAT and COOL when in auto, and neither when in off position; in addition a four-digit code number will appear when the key is released. The four digits of the code represent the following options.

First Digit (auxiliary heat cycle rate)  
 0 or 2 6 cycles per hour  
 4 or 6 3 cycles per hour

Second Digit (degree F or C, clock)  
 0 degrees F, 12 hour  
 1 degree C, 12 hour  
 4 degrees F, 24 hour  
 5 degrees C, 24 hour

Third Digit (system switch)  
 0 system switch in HEAT, EM. HT. or OFF  
 2 system switch in AUTO  
 4 system switch in COOL

Fourth Digit (changeover/mode)

- 0 manual changeover, system switch in COOL or OFF
- 1 auto changeover; system switch in COOL, AUTO or OFF
- 2 manual changeover; system switch in EM. HT. or HEAT
- 3 auto changeover; system switch in EM. HT. or HEAT

<sup>c</sup> Allows manual operation of heating equipment, bypassing 5-minute time delay. If the system switch is in HEAT or AUTO, the following sequence will occur:

**CAUTION**

Do not operate cooling if outdoor temperature is below 50° F [10° C]. Refer to manufacturer's recommendations.

First press—1st stage heating and SYSTEM LED on.

Second press—2nd stage heating also on.

Third press—2nd stage heating off.

Fourth press—1st stage heating and SYSTEM LED off. (If system switch is in EM. HT., operation is as above, except 1st stage heating is locked out.)

## PROGRAMMING THE THERMOSTAT

### STEP 1 SETTING THE CURRENT DAY AND TIME

This thermostat can be programmed either on the wall or in hand. SEE PAGE 9 TO FIND OUT HOW TO REMOVE THE THERMOSTAT FROM THE WALL.

Always press the keys with fingertip or similar blunt tool. Sharp instruments like a pen or pencil point can damage the keyboard.

NOTE: Check the glossary, page 25, for definitions of unfamiliar words.



Press and release. The display shows 1:00 PM Mon.



Press and hold until the current day appears in the display.



Press and hold until the current time appears in the display. Be sure AM or PM appears as desired.

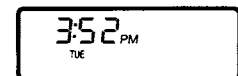

The current day and time have now been programmed. Go on to Step 2.

## STEP 2 SETTING THE PROGRAM SCHEDULE AND HEATING TEMPERATURES

Start by programming the WAKE time and temperature for weekdays.

The thermostat requires a program for WAKE. Program LEAVE, RETURN and SLEEP or not, as desired.



Press and release. Note that the display shows WAKE and the preprogrammed time and temperature.



If the display reads COOL, press and release to switch to HEAT.



If display reads SAT or SUN, press and hold until MON TUE WED THU FRI appears.



Press and hold until the display shows the desired starting time.



Press and hold until the display shows the desired temperature.



If the display starts to blink while holding down TEMPERATURE WARMER or COOLER, the setting limit has been reached. If thermostat can switch automatically between heating and cooling, the heating temperature must be at least 3 degrees below the cooling temperature. For example, if the cooling setting is 75° F, the maximum heating setting is 72° F.

Program the LEAVE time and temperature, if desired.



Press and release. The display shows LEAVE, but no time or temperature.



NOTE: To cancel the LEAVE, RETURN or SLEEP program, hold down the period key until the time and temperature disappear from the display.



Press and hold until the display shows the desired starting time.



Press and hold until the display shows the desired temperature.



Program the RETURN time and temperature, if desired.



Press and release. The display shows RETURN, but no time or temperature.



Press and hold until the display shows the desired starting time.



Press and hold until the display shows the desired temperature.



Program the SLEEP time and temperature, if desired.



Press and release. The display shows SLEEP and the preprogrammed time and temperature.



Press and hold until the display shows the desired starting time.



Press and hold until the display shows the desired temperature.



Set the SATURDAY schedule. Use the same procedure as for weekdays.



Press and release until SAT appears on the display.



Press WAKE, LEAVE, RETURN or SLEEP to select the time period.



Use the AHEAD/BACK keys to set the time and the WARMER/COOLER keys to set the temperature.



Set the SUNDAY schedule. Use the same procedure as for weekdays.



Press and hold until SUN appears on the display.



Press WAKE, LEAVE, RETURN or SLEEP to select the time period.



Use the AHEAD/BACK keys to set the time and the WARMER/COOLER keys to set the temperature.



This completes setting the program schedule and heating temperatures. To set cooling, go to Step 3.



If not programming the cool temperature at this time, skip Step 3 and press RUN PROGRAM key.

### STEP 3 SETTING THE COOLING TEMPERATURES

The program times are the same for both heating and cooling. Only the cooling temperatures need to be programmed if programming has been completed for heating.



Press and release. The display shows WAKE and the time and temperature previously programmed for heating.



Press and release so COOL shows on the display, along with the preprogrammed cooling temperature.





To set times while programming the cooling temperatures, use the TIME AHEAD and BACK keys as described in Step 2. Remember that if the times are being changed for cooling, they are also changing for heating at the same time.



If display reads SAT or SUN, press and hold until MON TUE WED THU FRI appears.



First program the WAKE temperature for weekdays.



Press and hold until the display shows the desired temperature.



If the display blinks while holding down TEMPERATURE WARMER or COOLER, the setting limit has been reached. If thermostat can switch automatically between heating and cooling, the cooling temperature must be at least 3 degrees higher than the corresponding heating temperature. For example, if the heating setting is 70° F, the minimum cooling setting is 73° F.

Program the LEAVE temperature, if desired.



Press and release. The display shows LEAVE, the time programmed for heating, and 78° F.



Press and hold until the display shows the desired temperature.



Program the RETURN temperature, if desired.



Press and release. The display shows RETURN, the time programmed for heating, and 78° F.



Press and hold until the display shows the desired temperature.



Program the SLEEP temperature, if desired.



Press and release.



Press and hold until the display shows the desired temperature.



Set the cooling temperatures for the SATURDAY schedule. Use the same procedure as for weekdays.



Press and hold until SAT appears on the display.

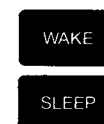

Press WAKE, LEAVE, RETURN or SLEEP to select the time period.



Set the cooling temperatures for the SUNDAY schedule. Use the same procedure as for weekdays.



Use the WARMER/COOLER keys to set the temperature.

Press and hold until SUN appears on the display.



Press WAKE, LEAVE, RETURN or SLEEP to select the time period.



Use the WARMER/COOLER keys to set the temperature.

This completes programming the cooling temperatures.

Press and release to start the program.



Go to Step 4.

#### STEP 4 SETTING THE SYSTEM AND FAN SWITCHES ON THE SUBBASE.

Depending on thermostat model, some of the switch positions shown may not be available. Note the positions provided on subbase, then set the switch(es) as desired.

First set the fan switch.

Then set the system switch.

**FAN ON:** The fan runs continuously. Use for improved air circulation during special occasions or for more efficient electronic air cleaning.



**FAN AUTO:** Normal setting for most homes and businesses. The fan starts and stops with the compressor in heat pump systems when the system switch is set to HEAT, AUTO or COOL. When system switch is set to EM. HT., the fan operates with the auxiliary heat (on some models).



**EM. HT.:** The thermostat controls only the backup heat. The heat pump is off.



**HEAT:** The thermostat controls the heating system.



**OFF:** Both the heating and cooling systems are off.



**AUTO (select models only):** The thermostat controls either heating or cooling system, depending on room temperature.



**COOL:** The thermostat controls the cooling system.

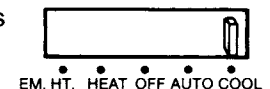

Now, read on to learn about the operating flexibility that makes this thermostat THE SMART CHOICE.

This completes thermostat programming.

If thermostat was removed from the wall to program, replace it following the procedure on page 12.

# OPERATING THE THERMOSTAT

## TEMPORARILY CHANGING THE PROGRAM

These features allow custom-tailoring of the program for those times when someone comes home early, or is staying up late, or planning to be out for the evening.

To keep the current temperature through the next program period:



Press and release. The name of the period to be skipped will flash in the display until the next regularly scheduled period starts.



To go back to the temperature of the previous program period:



Press and release. The display will show the name of the previous period and flash "temporary" until the next regularly scheduled period starts.



To temporarily raise or lower the temperature for the current period only:



Press and hold until the desired temperature is reached. The display will flash "temporary" until the next programmed time period starts.



To change back:



Press and release to cancel any of the temporary settings.



## PERMANENTLY CHANGING THE PROGRAM

If schedule changes or a different temperature is desired, update any setting without affecting the rest of the program.



Press and release the desired period key.

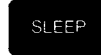

Press and hold until the desired day schedule shows on the display.



Press and hold the Time or Temperature keys until the display shows the desired new program.



Press and release to return to normal operation.

## OPERATING THE THERMOSTAT MANUALLY

This feature is particularly useful when going on vacation or other extended absences. It does not cancel the program.



Press and release.

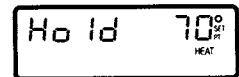

Press and hold to change the temperature setting. After a few seconds the display will show the current temperature.



Press and release to check the temperature setting.



Press and release to cancel HOLD.



## CANCELING PROGRAM SETTINGS

The thermostat requires time and temperature settings in the WAKE period, but any of the others can be canceled. Weekday, Saturday and Sunday settings are canceled separately.



Press and hold the desired period key until the time and temperature clear from the display (about 3 seconds).

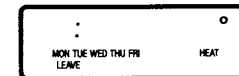

Press and release to return to normal operation.

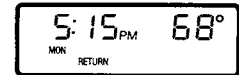

## CHECKING THE PROGRAM TIMES AND TEMPERATURES

If desired, check all the stored settings without affecting the permanent program.



Press and release the desired period key. The start time and temperature setting will appear on the display.

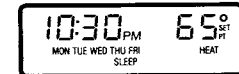

Press and release to display the next daily time and temperature for that period.



Press and release to return to normal operation.

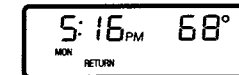

## CHECKING THE CURRENT TEMPERATURE SETTING

Press a single key to compare current room temperature to the setting at any time.

PRESENT  
SETTING

Press and release. The display will show the current temperature setting for several seconds, then revert to the room temperature.



During recovery from winter energy savings, the setting displayed will not match the programmed setting. This is because the thermostat gradually raises the temperature setting during recovery to provide most efficient use of the heating equipment. The same is true during recovery from summer energy savings, except the temperature is gradually lowered during recovery.

## OPERATION

The T8611G and R thermostats provide automatic control of multistage heat pump systems with 2 stages of heat and 1 stage of cool. The first heat stage is the heat pump and the second stage is electric, gas, or oil auxiliary heat. T8611G provides automatic changeover from heat to cool; T8611R provides manual changeover.

### ADAPTIVE INTELLIGENT RECOVERY™ OPERATION

Adaptive Intelligent Recovery™ is Honeywell's trademark for the way the T8611 controls the heating and cooling equipment during recovery from an energy savings setting to a comfort setting. During recovery, the control point changes gradually rather than jumping from the energy savings setting to the comfort setting all at once. This provides additional energy savings over conventional recovery.

When Adaptive Intelligent Recovery™ is used in the heating mode, the control point raises gradually, maximizing the use of the more economical heat pump to bring the sensed temperature to the desired comfort set point. This minimizes the use of the typically more expensive auxiliary heat.

In both heating and cooling, the thermostat monitors recovery each day and adjusts the next day's recovery start time. This ensures that the building is at the desired temperature at the programmed time, regardless of the outdoor temperature. Recovery time varies depending on the weather conditions and the building's heating/cooling system.

The advantages of this approach are:

- The comfort setting is achieved at the programmed time and maintained regardless of weather conditions; occupants come home and wake up to comfort.
- Minimizes drafts from low temperature discharge air during occupied periods.
- The thermostat automatically uses the more economical first stage of the heat pump as the primary heat

source during heat mode recovery, avoiding the use of the expensive second stage of heating (auxiliary heat).

- Comfort and energy savings can be achieved in both heating and cooling.
- Reduces heat pump compressor cycling, extending equipment life.

### Use of Outdoor Thermostats

Because Adaptive Intelligent Recovery™ calls for auxiliary heat only when it is truly needed, it eliminates the need for an outdoor thermostat. If an outdoor thermostat is used with T8611 and it is set close to the balance point<sup>a</sup>, the recovery time from energy savings will be prolonged because the outdoor thermostat will prevent operation of the auxiliary heat even when the T8611 is calling for it. The resulting unnecessarily long recovery times reduce the energy savings.

### When Adaptive Intelligent Recovery™ Is Used

Adaptive Intelligent Recovery™ is used during recovery from energy savings. It is bypassed when the set point is changed, and when the CHANGE TO LAST PERIOD, SKIP NEXT PERIOD or HOLD TEMP key is pressed. If Adaptive Intelligent Recovery™ is bypassed, the system operates the stages of equipment like a conventional thermostat.

### WHAT TO EXPECT DURING RECOVERY FROM ENERGY SAVINGS IN HEATING

The T8611 controls the heating equipment based on the indoor sensed temperature, which is a combination of air temperature and wall temperature.

<sup>a</sup> Balance point is the outdoor temperature below which the heat pump must call on auxiliary heat to help handle the load.

### In Mild Weather (Fig. 11)

When the outdoor temperature is mild, say 50° F [10° C], the recovery from energy savings will be handled completely by the heat pump, without using the more costly auxiliary heat. The heat pump starts only after the control point has risen above the sensed temperature and is locked on until the comfort set point is reached. During the comfort period, the heat pump will cycle on and off as needed to maintain the sensed temperature within +/-1 F of the set point. During energy savings periods, T8611 will call the heat pump on only if the sensed temperature falls below the control point.

### In Moderate Weather (Fig. 12)

When outdoor temperature is close to the balance point<sup>a</sup> of the heat pump, the heat pump will run continuously during the recovery period and the auxiliary heat will cycle as necessary. During the comfort period, the heat pump runs continuously and auxiliary heat cycles until the next energy savings period begins. During energy savings, the heat pump cycles on only when the sensed temperature falls below the control point. Under these conditions, auxiliary heat is typically not needed during the energy savings period.

<sup>a</sup>Balance point is the outdoor temperature below which the heat pump must call on auxiliary heat to help handle the load.

### In Severe Weather (Fig. 13)

When the outdoor temperature is severe, say 0° F [-18° C], the heat pump is on continuously and auxiliary heat cycles even during the energy savings period. When recovery from energy savings begins, the heat pump will stay on and auxiliary heat will cycle. During recovery, the auxiliary heat ON times will be long, and the OFF times will be short. The ON times will shorten as the control point approaches the comfort set point. During the comfort period, the heat pump is on continuously and auxiliary heat cycles until the next energy

savings period. When energy savings begins, the heat pump cycles off until the sensed temperature falls below the control point. Although the heat pump comes on when the sensed temperature falls below the control point, the sensed temperature may lag 2° or 3° F below the control point because of the time required to warm up the walls and furniture. Auxiliary heat will cycle as necessary during the energy savings period.

## THERMAL PERFORMANCE WITH T8611

During severe weather, the T8611 actually controls closer to the set point than a conventional thermostat. This is because the heat anticipator is replaced by two electronic control strategies—cycling by heat anticipation and proportional plus integral control.

Electronic cycling by heat anticipation acts like a traditional heat anticipator, except that it never needs adjustment for different control circuit load currents. It cycles the heat pump off slightly before the room temperature reaches the set point to keep heat left in the ductwork from overheating the room.

In severe weather, a conventional thermostat with a heat anticipator tends to turn the thermostat off too soon, so the effective control point is somewhat below the set point. In very cold weather, the difference between set point and effective control point may be 5° F or 6° F [2° C or 3° C] with a conventional thermostat. This phenomenon is called "droop."

Proportional plus integral action eliminates droop by adjusting the on time of the stage that's cycling longer or shorter until the control point matches the set point. The T8611 controls space temperature within one degree of set point, once the temperature has stabilized after an energy savings period.

This "zero droop" performance of the T8611 provides improved occupant comfort and energy savings. Occupants do not need to continually adjust thermostat settings to maintain desired temperature, even during severe weather.

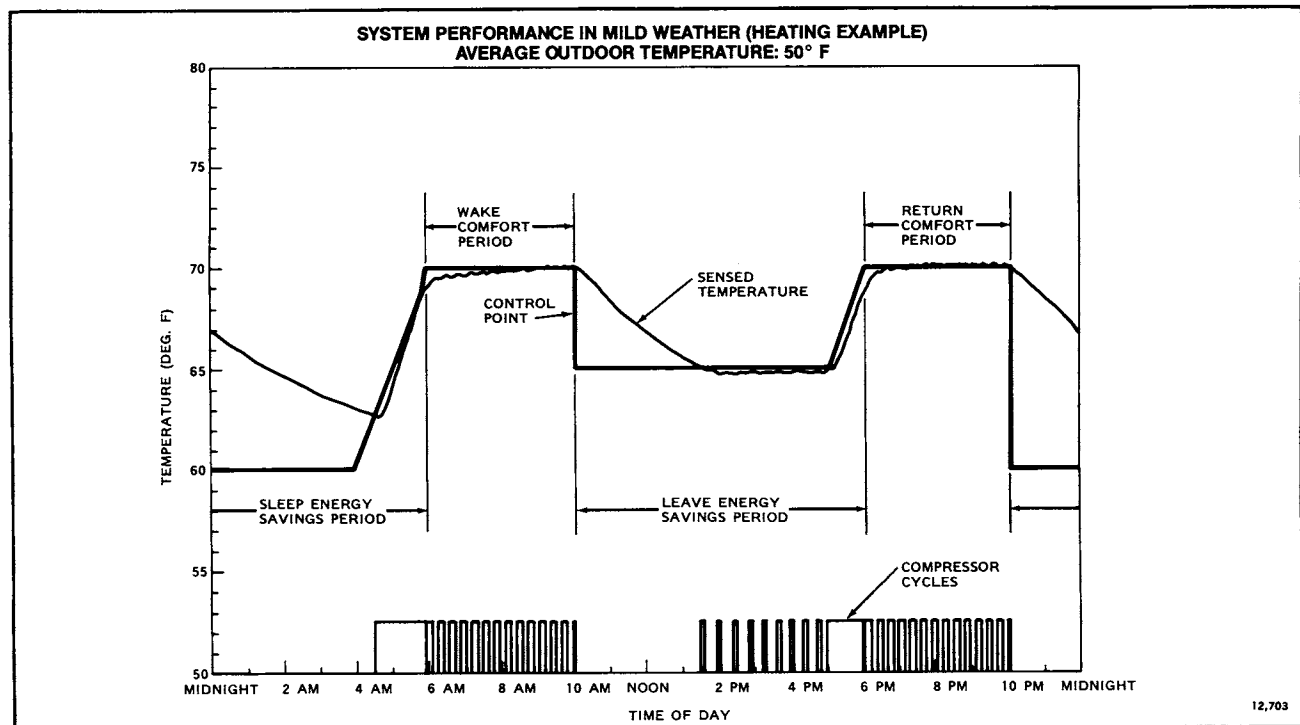

FIG. 11—THERMOSTAT CONTROL OPERATION (HEATING EXAMPLE) IN MILD WEATHER.

## MINIMUM OFF TIMING

A minimum-off timer in the T8611 ensures that the compressor won't come on again for at least five minutes after it turns off. The minimum-off timer is triggered when the compressor goes off, and when the system

switch is moved from HEAT to COOL or vice versa. If the compressor turns off when the set point is changed or the CHANGE TO LAST PERIOD key is pressed, then the minimum-off timer is triggered. The minimum-off timer operates on the first stage of both heating and cooling.

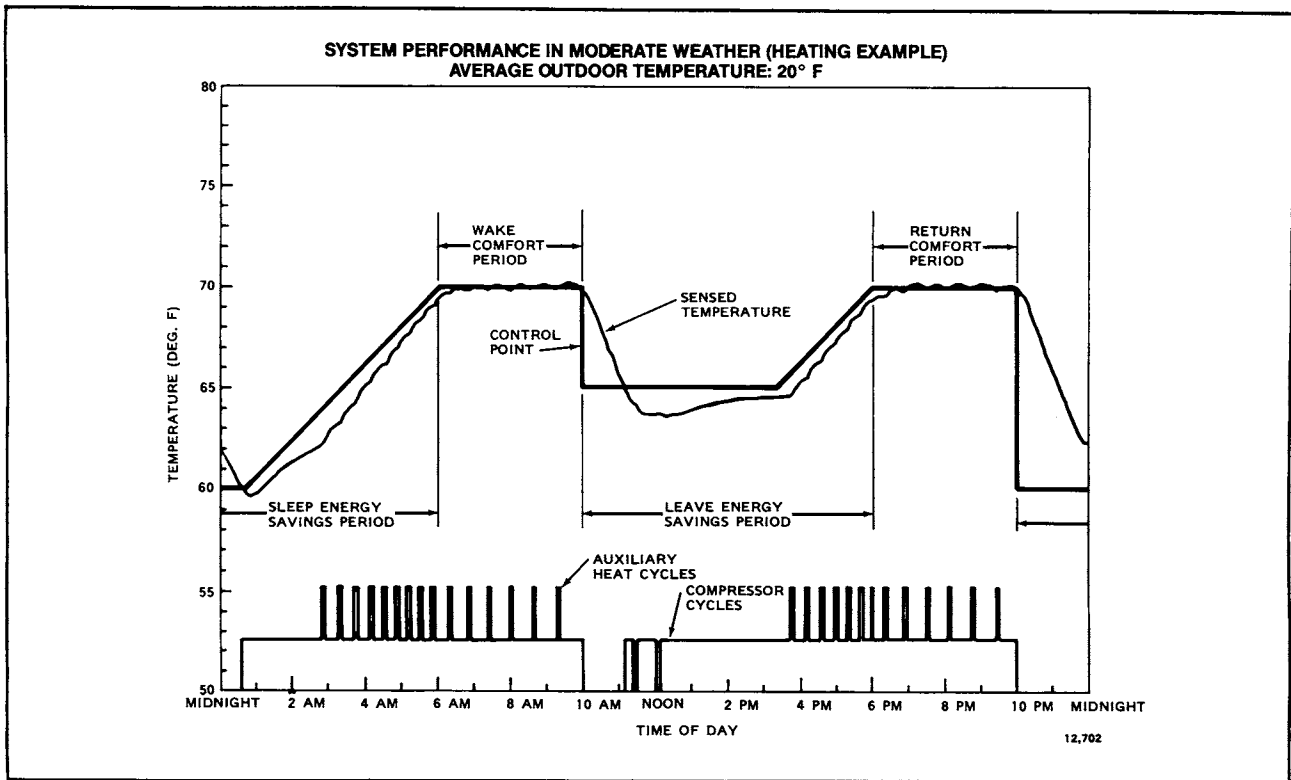

FIG. 12—THERMOSTAT CONTROL OPERATION (HEATING EXAMPLE) IN MODERATE WEATHER.

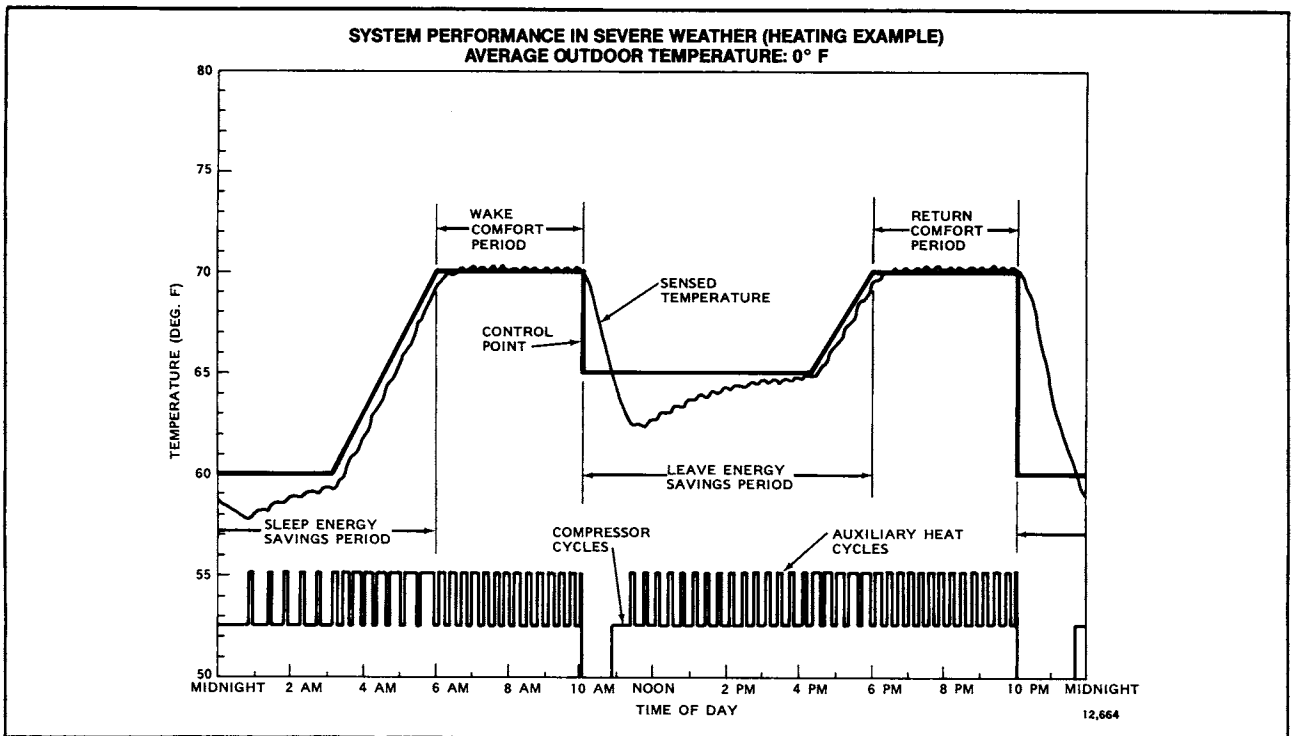
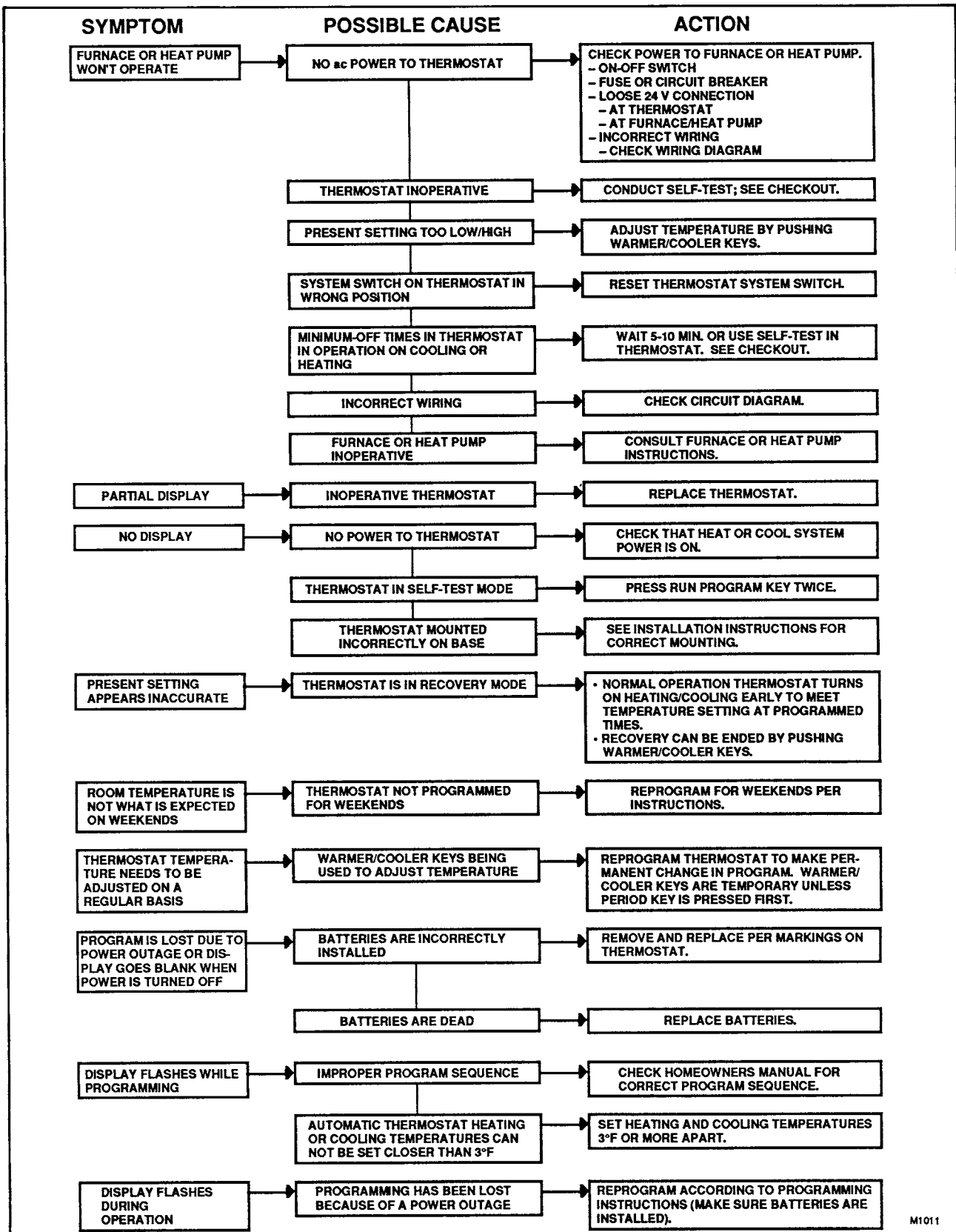

FIG. 13—THERMOSTAT CONTROL OPERATION (HEATING EXAMPLE) IN SEVERE WEATHER.

# TROUBLESHOOTING

Start the system by setting the thermostat and observing system response. If problem occurs, establish symptom and use the following troubleshooting chart to check for possible cause and action.



M1011



# GLOSSARY

## Comfort Temperature

The temperature wanted in the morning and evening when home.

## Energy Saving Temperature

The lower (heating) or higher (cooling) temperature that allows savings on heating and cooling costs when asleep or away. Also called the setback (heating) or setup (cooling) temperature.

## Period Key

One of the four keys—WAKE, LEAVE, RETURN, or SLEEP—to press to check or program the start time and temperature for a time period.

## Preprogrammed Schedule

This is the schedule programmed into the thermostat at the factory. It sets a night program that provides energy savings if homeowner doesn't set his/her own program, or if personal program is lost for any reason. The program, which is the same for all days of the week, is:

| Period | Start Time | Temperature |         |
|--------|------------|-------------|---------|
|        |            | Heating     | Cooling |
| WAKE   | 6:00 AM    | 70° F       | 78° F   |
| LEAVE  | -----      | No program  | -----   |
| RETURN | -----      | No program  | -----   |
| SLEEP  | 10:00 PM   | 60° F       | 78° F   |

## Program

The times and temperatures homeowner sets to define the comfort and energy savings periods for each schedule (weekdays, Saturday, Sunday).

## Recovery

The time when the thermostat operates the heating or cooling equipment to return the house from the energy savings temperature to the comfort temperature. The thermostat starts the recovery period early so the house will be at the comfort setting by the time the homeowner has chosen.

## Saturday Program Schedule

The schedule of WAKE, LEAVE, RETURN, and SLEEP period start times and temperatures that homeowner programs to run on Saturdays.

## Setback

Reducing the temperature in the house for a set period every day in winter for energy savings. The lower temperature is the energy savings temperature.

## Setup

Raising the temperature in the house for a set period every day in summer for energy savings. The higher temperature is the energy savings temperature.

## Set Point

The temperature homeowner sets on the thermostat. The thermostat turns the heating or cooling equipment

on and off to maintain this temperature at the thermostat location until another temperature setting goes into effect.

**Status Lights**—Lights that show system operating mode.

**ENRG SAV light (green)**—This light glows during the LEAVE and SLEEP periods (located on thermostat).

**SYSTEM light (yellow)**—This light glows whenever the thermostat is calling for heating or cooling (located on thermostat).

**AUX. HT. light (green)**—This light glows whenever the thermostat is calling for operation of the backup heater. Backup (auxiliary) heat is more expensive to operate than the heat pump, and typically is used only when the heat pump is unable to handle the load (located on subbase).

**CHECK light (yellow)**—Consult heat pump equipment literature to determine whether this light is used and its meaning (located on subbase of some models).

**EM. HT. light (red)**—This light glows whenever the thermostat system switch is in the EM. HT. position (located on subbase). On some systems, it may also indicate the need to switch to EM. HT. because of a heat pump problem.

## Sunday Program Schedule

The schedule of WAKE, LEAVE, RETURN, and SLEEP period start times and temperatures that homeowner programs to run on Sundays.

## Time Period

One of four program periods: WAKE, LEAVE, RETURN, and SLEEP available with the Chronotherm III thermostat. One period begins when the previous period ends.

**WAKE**—The time period when homeowner wants the house at a comfortable temperature while the family gets up and gets ready to leave for work or school. This is the only period that must contain a time and temperature.

**LEAVE**—The time period when homeowner can set back (winter) or up (summer) the temperature for energy savings because the family is usually away from home.

**RETURN**—The time period when homeowner wants the house at a comfortable temperature for family activities in the evening before bedtime.

**SLEEP**—The time period when homeowner can set back (winter) or up (summer) the temperature for energy savings because the family is sleeping. Homeowner should set it to start at family's normal bedtime. Often the SLEEP program is set only for the heating season so family members can sleep cool in summer.

## Weekday Program Schedule

The schedule of WAKE, LEAVE, RETURN and SLEEP period start times and temperatures that homeowner programs to run Monday through Friday.

# TABLE OF CONTENTS

|  | page |
|--|------|
| <b>SPECIFICATIONS</b> .....  | 2    |
| <b>ORDERING INFORMATION</b> .....  | 2    |
| <b>SELECTION/APPLICATION</b> .....   | 3    |
| <b>INSTALLATION</b> .....  | 9    |
| <b>Compatibility</b> .....   | 9    |
| <b>Location</b> .....  | 9    |
| <b>Mounting Subbase</b> .....  | 9    |
| <b>Wiring</b> .....  | 10   |
| <b>Adjusting Cycle Rate</b> .....  | 11   |
| <b>Installing Batteries</b> .....  | 12   |
| <b>Power Outages</b> .....   | 12   |
| <b>Mounting the Thermostat</b> .....                                       | 12   |
| <b>Setting Day and Time</b> .....  | 12   |
| <b>CHECKOUT</b> .....  | 13   |
| <b>Heating</b> .....   | 13   |
| <b>Cooling</b> .....   | 13   |
| <b>Fan</b> .....   | 13   |
| <b>Installer Self-Test</b> .....   | 13   |
| <b>PROGRAMMING THE THERMOSTAT</b> .....                                    | 14   |
| <b>Setting the Current Day and Time</b> .....                              | 14   |
| <b>Setting the Program Schedule and Heating Temperatures</b> .....         | 15   |
| <b>Setting the Cooling Temperatures</b> .....                              | 16   |
| <b>Setting the System and Fan Switches on the Subbase</b> .....            | 18   |
| <b>OPERATING THE THERMOSTAT</b> .....                                      | 19   |
| <b>Temporarily Changing the Program</b> .....                              | 19   |
| <b>Permanently Changing the Program</b> .....                              | 19   |
| <b>Operating the Thermostat Manually</b> .....                             | 20   |
| <b>Canceling Program Settings</b> .....                                    | 20   |
| <b>Checking the Program Times and Temperatures</b> .....                   | 20   |
| <b>Checking the Current Temperature Setting</b> .....                      | 21   |
| <b>OPERATION</b> .....   | 21   |
| <b>Adaptive Intelligent Recovery™ Operation</b> .....                      | 21   |
| <b>What to Expect During Recovery from Energy Savings in Heating</b> ..... | 21   |
| <b>Thermal Performance with T8611</b> .....                                | 22   |
| <b>Minimum Off Timing</b> .....  | 23   |
| <b>TROUBLESHOOTING</b> .....   | 24   |
| <b>GLOSSARY</b> .....  | 25   |

---

**Honeywell Inc.**  
1885 Douglas Drive N.  
Golden Valley, MN 55422-4386

International Sales Offices in all principal cities of the world. Manufacturing in  
Australia, Canada, Finland, France, Germany, Japan, Mexico, Netherlands,  
Spain, Taiwan, United Kingdom, U.S.A.

PRINTED IN U.S.A.



## Free Manuals Download Website

<http://myh66.com>

<http://usermanuals.us>

<http://www.somanuals.com>

<http://www.4manuals.cc>

<http://www.manual-lib.com>

<http://www.404manual.com>

<http://www.luxmanual.com>

<http://aubethermostatmanual.com>

Golf course search by state

<http://golfingnear.com>

Email search by domain

<http://emailbydomain.com>

Auto manuals search

<http://auto.somanuals.com>

TV manuals search

<http://tv.somanuals.com>