

EQUIP™ Series IP Camera

NTSC / PAL

HCD554IP HCD554IPX

HCS554IP HCS554IPX

Reference Guide

Revisions

Issue	Date	Revisions
A	08/07	New document (Pre-release version).
B	02/08	Production released version of the manual.
C	08/08	Revised production released version for technical review comments; Add trademark to EQUIP; updated back cover.

Contents

About This Document	7
Overview of Contents	7
Cautions and Warnings	8
FCC Compliance Statement	8
Manufacturer's Declaration of Conformance	9
North America	9
Europe	9
Warranty and Service	9
1 Introduction	11
Features	12
2 Installation and Setup	13
Before you Begin	13
Unpack Everything	13
Overview of Installation Procedure	14
Camera Components and Functions	14
Installation	14
Selecting the Lens	14
Adjusting the Back Focus	15
Mounting the Camera	15
Wiring	16
Connecting Video	16
Connecting Power	17
Connecting Alarms	18
Connecting Audio	20
Restore Factory Defaults	20
3 Configuring Network Settings	21
Preparing the Honeywell IP Utility	21
System Requirements	21
Installing the IP Utility	22
Uninstalling the IP Utility	22
User Profiles	23
Logging On to the IP Utility	23
Changing the User Password	24
User Interface	25
IP Camera Network Configuration	26
Discovering Devices	26
Connecting to Devices	26
Configuring IP Network Settings	27
Upgrading the Firmware	29
Launching the Web-Client Application	29
Changing Web-Client Application Password	30

4	IP Camera Web-Client	31	
	Overview	31	
	User Profiles	31	
	Accessing the IP Camera Web-Client	32	
	First Time Setup Requirements	32	
	Logging On	33	
	Installing Honeywell IP (ActiveX Plug-in)	34	
	Logging Off	35	
	Uninstalling Honeywell IP (ActiveX Plug-in)	35	
	Navigating the User Interface	36	
	Live View	37	
	Device Settings	37	
	Compression Settings	39	
	Compression Settings	40	
	Audio Settings	40	
	Camera Setup	40	
	Auto Exposure	41	
	White Balance	42	
	Video Analytics	43	
	Video Blurring	44	
	Camera Blinding	45	
	Camera Field of View Change	46	
	Appendix A	Troubleshooting	47
	Technical Support	47	
	Problem: Web-Client Does Not Display the Expected Video	47	
	Problem: Cannot Connect to a Device	48	
	Appendix B	Specifications	49

Figures

Figure 1-1	Camera Overview	11
Figure 2-1	Back Focus Adjustment	15
Figure 2-2	Camera Mount	16
Figure 2-3	Camera Connections	16
Figure 2-4	Alarm Connections	19
Figure 2-5	Normal Alarm States	19
Figure 2-6	Alarm Output Connection	19
Figure 3-1	IP Utility Login Screen	24
Figure 3-2	IP Utility Change Password Dialog Box	24
Figure 3-3	IP Utility User Interface	25
Figure 3-4	IP Network Settings Obtained Automatically	27
Figure 3-5	IP Network Settings Obtained Manually	28
Figure 3-6	IP Utility Firmware Upgrade	29
Figure 3-7	Changing Web-Client User Passwords	30
Figure 4-1	Internet Options	32
Figure 4-2	Security Settings	33
Figure 4-3	Logon Screen	34
Figure 4-4	Honeywell IP Installation (ActiveX Plug-in)	35
Figure 4-5	Web-Client: Administrator User	36
Figure 4-6	Web-Client: Guest User	37
Figure 4-7	Device Settings	38
Figure 4-8	Compression Settings	39
Figure 4-9	Camera Setup	41
Figure 4-10	Video Analytics	44
Figure 4-11	Video Analytics Message	44
Figure A-1	ActiveX Control Failed Message	47
Figure A-2	Install Unknown Software Prompt	48
Figure A-3	Limited or No Connection Message	48
Figure B-1	Network Camera Dimensions	51

About This Document

This document introduces the Honeywell Color Day/Night Network Camera. It covers how to install, configure and operate the camera in a network environment. See *Table 0-1* for a list of camera models.

Table 0-1 Network Camera Model Numbers

Model Number	Description
HCD554IP	True Day/Night Network Camera, NTSC, Analog output
HCD554IPX	True Day/Night Network Camera, PAL, Analog output
HCS554IP	Day/Night Network Camera, NTSC, Analog output
HCS554IPX	Day/Night Network Camera, PAL, Analog output





This document is intended for system installers, administrators, and operators.

Overview of Contents

This document contains the following chapters and appendixes:

- *Chapter 1, Introduction*, introduces the Honeywell network camera and gives a functional overview of its components.
- *Chapter 2, Installation and Setup*, provides procedures for installing cameras, lens adjustment, and setting up a network camera environment.
- *Chapter 3, Configuring Network Settings*, describes how to install and use the Honeywell IP Utility application.
- *Chapter 4, IP Camera Web-Client*, describes how the Web-Client application is used to view video and configure the available settings for the network camera.
- *Appendix A, Troubleshooting*, lists common problems encountered when setting up the network camera.
- *Appendix B, Specifications*, provides specifications for the network camera.

Cautions and Warnings

	CAUTION RISK OF ELECTRIC SHOCK DO NOT OPEN		 THIS SYMBOL INDICATES THAT DANGEROUS VOLTAGE CONSTITUTING A RISK OF ELECTRIC SHOCK IS PRESENT WITHIN THE UNIT.
CAUTION: TO REDUCE THE RISK OF ELECTRIC SHOCK, DO NOT REMOVE THE COVER. NO USER-SERVICEABLE PARTS INSIDE REFER SERVICING TO QUALIFIED SERVICE PERSONNEL			 THIS SYMBOL INDICATES THAT IMPORTANT OPERATING AND MAINTENANCE INSTRUCTIONS ACCOMPANY THIS UNIT.

Installation and servicing should be performed only by qualified and experienced technicians to conform to all local codes and to maintain your warranty.

WARNING! 12 VDC/24 VAC models require the use of CSA Certified/UL Listed Class 2 power adapters to ensure compliance with electrical safety standards. Power over Ethernet (PoE) should meet the IEEE 802.3 af PoE standard.

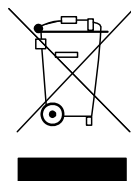

WEEE (Waste Electrical and Electronic Equipment). Correct disposal of this product (applicable in the European Union and other European countries with separate collection systems). This product should be disposed of, at the end of its useful life, as per applicable local laws, regulations, and procedures.

Caution When powering the camera from 24 VAC, a UPS source should be considered to ensure satisfactory performance.

FCC Compliance Statement

Information to the User: This equipment has been tested and found to comply with the limits for a Class B digital device. Pursuant to Part 15 of the FCC Rules, these limits are designed to provide reasonable protection against harmful interference in a residential installation. This equipment generates, uses, and can radiate radio frequency energy and, if not installed and used in accordance with the instruction manual, may cause harmful interference to radio communications. However, there is no guarantee that interference will not occur in a particular installation.

If this equipment does cause harmful interference to radio or television reception, which can be determined by turning the equipment off and on, the user is encouraged to try to correct the interference. For example, try reorienting or relocating the receiving antenna, increasing the separation between the equipment and receiver, or connecting the equipment to an outlet on a different circuit.

Caution Changes or modifications not expressly approved by the party responsible for compliance could void the user's authority to operate the equipment.

This Class B digital apparatus complies with Canadian ICES-003.

Manufacturer's Declaration of Conformance

North America

The equipment supplied with this guide conforms to UL 60950-1 and CSA C22.2 No. 60950-1.

Europe

The manufacturer declares that the equipment supplied with this guide is compliant with the essential protection requirements of the EMC directive 89/336/EEC and the Low Voltage Directive LVD 73/23 EEC, conforming to the requirements of standards EN 55022 for emissions, EN 50130-4 for immunity, and EN 60950 for Electrical Equipment safety.

Warranty and Service

Subject to the terms and conditions listed on the Product warranty, during the warranty period Honeywell will repair or replace, at its sole option, free of charge, any defective products returned prepaid.

In the event you have a problem with any Honeywell product, please call Customer Service at 1.800.796.CCTV for assistance or to request a **Return Merchandise Authorization (RMA)** number.

Be sure to have the model number, serial number, and the nature of the problem available for the technical service representative.

Prior authorization must be obtained for all returns, exchanges, or credits. **Items shipped to Honeywell without a clearly identified Return Merchandise Authorization (RMA) number may be refused.**

Introduction

The Honeywell color day/night network camera provides high picture quality remote video surveillance over a network connection. See [Table 1-1](#) for a list of camera models.

Table 1-1 Network Camera Model Numbers

Model Number	Description
HCD554IP	True Day/Night Network Camera, NTSC, Analog output
HCD554IPX	True Day/Night Network Camera, PAL, Analog output
HCS554IP	Day/Night Network Camera, NTSC, Analog output
HCS554IPX	Day/Night Network Camera, PAL, Analog output

Figure 1-1 Camera Overview

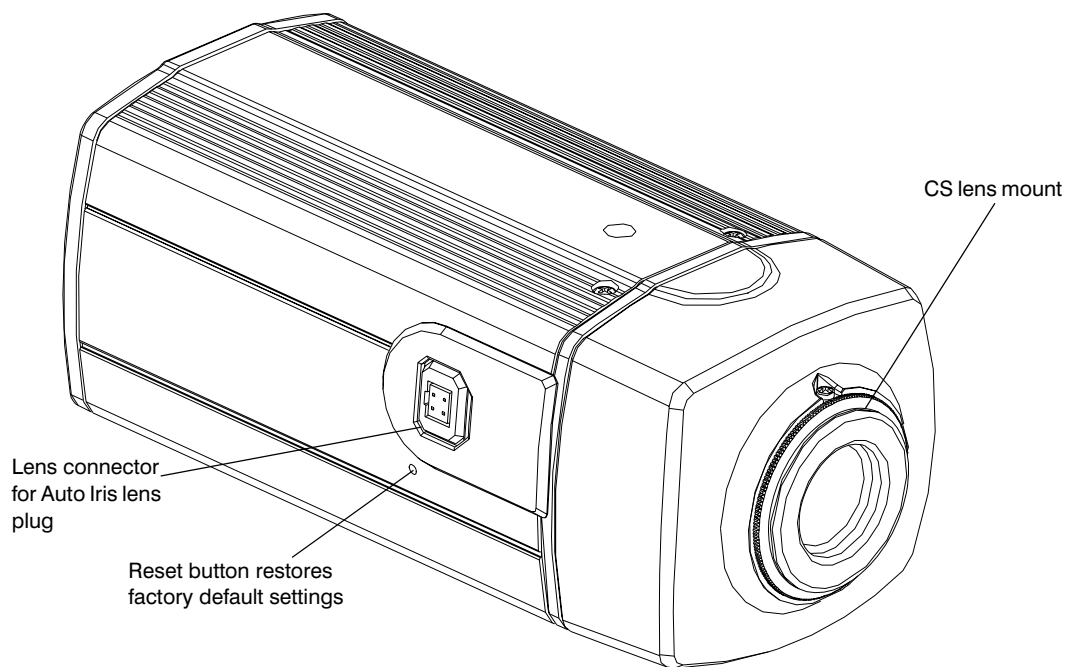

Features

The Honeywell network camera has the following features:

- Built-in high-resolution color video camera with 1/3" IT Super HAD CCD
- CS-mount lens
- Excellent signal-to-noise ratio of more than 50 dB
- Supports Filter moving Day/Night (HCD554IP) and Electronic Day/Night (HCS554IP) function
- Minimum illumination of 0.7 lux color, 0.2 lux B/W (HCD554IP) or 0.5 lux B/W (HCS554IP)
- Compatible with Manual Iris lens or DC Iris lens
- True color reproduction from various light sources
- All camera functions including ELC, ALC, AGC, BLC, Day/Night, White balance can be controlled by remote site through Ethernet
- Real-time encoding 25/30 FPS (PAL/NTSC) in all resolutions
- Supports MPEG4 encoding
- Bi-directional audio communication
- One alarm input (NO/NC) and one alarm output (Relay)
- 12 VDC, 24 VAC and PoE (IEEE 802.3 af) power supply, automatically detected by the camera

Installation and Setup

This chapter describes how to:

- Mount the camera(s)
- Adjust the camera(s) for the clearest image
- Set up cameras in a network system

Before you Begin

Please read this guide carefully before you install the network camera.

Keep this guide for future reference.

Before installing the camera, Honeywell recommends that you check www.honeywellvideo.com/products/cameras/ to find your camera and download the latest manuals and software updates.

Unpack Everything

Check that the items received match those listed on the order form and packing slip. The packing box should include, in addition to this User Guide:

- One fully-assembled network camera
- 3-pin terminal block for Power input
- 4-pin terminal block for Alarm input/output
- One product warranty
- One CD containing the software

If any parts are missing or damaged, contact the dealer you purchased the camera from or call Honeywell Customer Service (see *Warranty and Service* on page 9).

Overview of Installation Procedure

Note Please familiarize yourself with the installation procedure and complete each step in the sequence given.

The initial installation of a network camera consists of the following steps:

Step		See ...
1	Select the lens.	<i>page 14</i>
2	Adjust the back focus.	<i>page 15</i>
3	Mount the camera.	<i>page 15</i>
4	Connect the camera.	<i>page 16</i>
5	Program the camera.	<i>page 37</i>

Camera Components and Functions

The network camera is intended for indoor use only. If you choose to mount the camera outdoors, you must employ a suitable weatherproof enclosure (such as Honeywell's HHC12 camera housing) with your network camera. See www.honeywellvideo.com for information on Honeywell weatherproof enclosures and mounting brackets.

Installation

Selecting the Lens

The network camera supports the use of a manual iris lens or DC (Direct Drive) iris lens. When using a DC iris lens, it should be connected to the camera through the 4-pin square socket located at the side of the camera (see *Figure 2-1*).

Adjusting the Back Focus

The back focus adjustment is accessible at the front end of the camera housing to adjust the back focal length or picture focus.

The range of adjustment allows the CS-mount lenses to be used without the need for a spacer ring.

Figure 2-1 Back Focus Adjustment

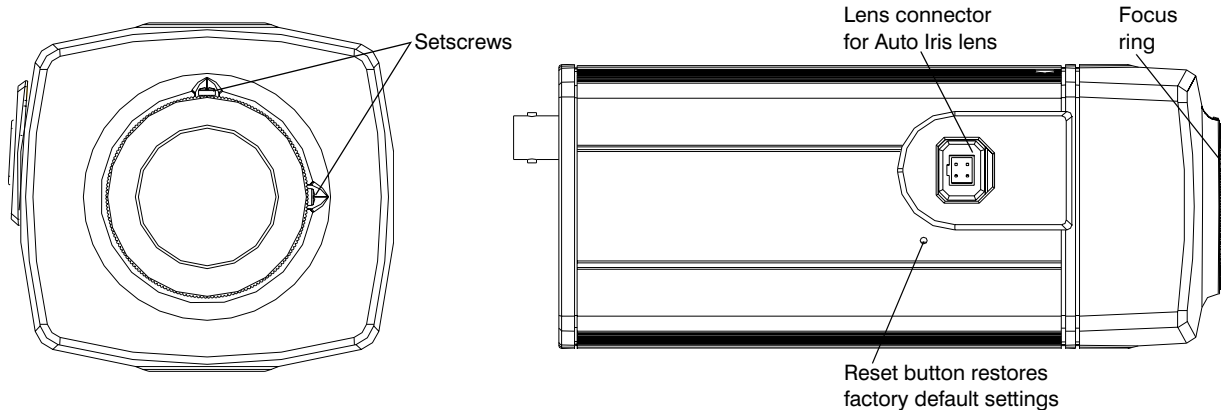

1. Loosen the setscrews with a Phillips screwdriver.
2. Adjust the focus ring at the front end of the camera housing to focus the picture.
3. Re-tighten the setscrews.

Mounting the Camera

Mounting points are provided on the top and bottom of the camera and are used to mount the camera on a bracket or tripod for indoor applications. They are designed to accept standard sized mounting bolts (1/4 x 20). The mounting bracket must be capable of supporting the weight of the camera and its lens.

Caution Some installation codes state that the mounting bracket must be capable of supporting up to four times the combined weight of the camera and lens.

For outdoor applications, mount the camera inside a weatherproof enclosure. See www.honeywellvideo.com for information on Honeywell weatherproof enclosures.

Figure 2-2 Camera Mount

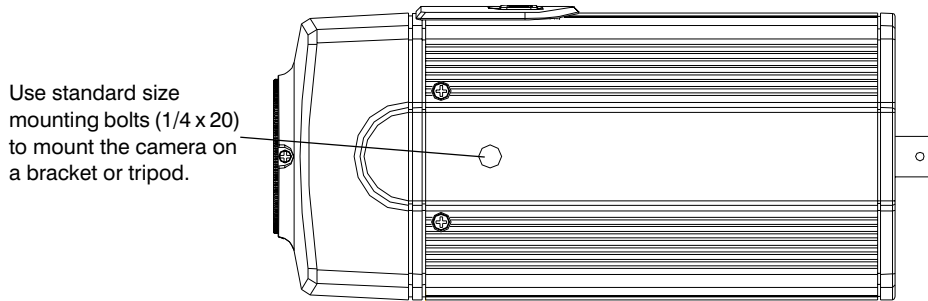

Wiring

Figure 2-3 Camera Connections

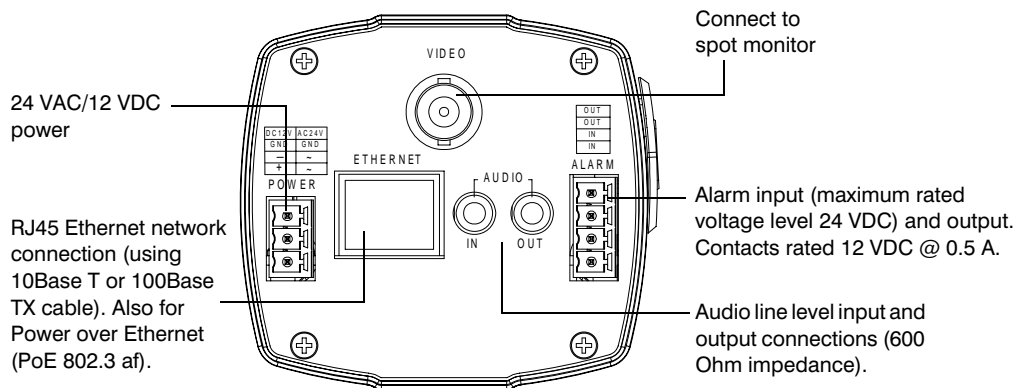

Caution Installation must be performed by a qualified service technician and must be in accordance with all national and local mechanical and electrical codes.

Connecting Video

Spot Monitor

The analog video connection is available as a test output and should be used during installation to position and aim the camera as needed.

Connect the **VIDEO** connector on the rear of the camera to the video input connector on your spot monitor.

Network RJ-45 Ethernet Connection

The main video connection for your network camera will be made through your Ethernet network connection. Connect the **Ethernet** connector on the rear of the camera to your network using an Ethernet (10Base-T, 100Base-TX) cable.

Note You can connect your camera to a network or connect it directly to a PC or laptop using a crossover cable.

Connecting Power

Caution When connecting a power supply, use either a 12 VDC or 24 VAC power plug or use a PoE IEEE 802.3 (Power over Ethernet) compatible hub. To avoid damage to the camera, never connect more than one type of power supply at the same time.

WARNING! The use of a CSA Certified/UL Listed Class 2 power supply is required to ensure compliance with electrical safety standards.

Note Check the power source from the external power supply before applying power to the camera.

1. Connect the camera to a power supply appropriate for your installation:
 - 12 VDC or 24 VAC power supply (proceed to *step 2*)
 - Power over Ethernet (PoE IEEE 802.3 af) 48 VDC power supply

Note If you are using PoE (802.3 af), power will automatically be supplied to the camera through the network cable.

2. Plug in the power supply. Use a screwdriver to first loosen the ~AC24V/DC12V terminal screws on the terminal block.

The RJ-45 jack LED briefly illuminates to show that the camera is receiving power. If it does not illuminate, check the connections and the power source.

Note To ease installation, the terminal block can be removed. The power connections of the removable terminal block are not polarity-sensitive. Connect either power lead to either connector terminal.

3. Secure the power leads by retightening the terminal screws until snug.
 4. Plug the power supply into an appropriate power source. The LED on the RJ-45 jack illuminates to show that the camera is receiving power. If it does not illuminate, check the removable terminal block connections and the power source.
-

Note For secure installations, surface mounted cables should be protected by plastic or metal cable covers.

Caution Installation must be performed by a qualified service technician. The proper wire gauge for the distance and number of cameras must be determined to maintain 12 VDC/24 VAC at each camera.

Caution When powering the camera from 24 VAC, a UPS source should be considered to ensure satisfactory performance.

Caution Connect power either from a 24 VAC/12 VDC source or CAT5 Ethernet connector (PoE); never both at the same time.

Connecting Alarms

WARNING! Do not exceed the maximum rating of 12 VDC, 0.5 A on alarm output connections.

The network camera has one alarm input and one alarm output available to connect to peripheral devices (*Figure 2-4*).

Figure 2-4 Alarm Connections



Connect mechanical or electrical switches to the alarm input connection to allow event-triggered recording. When alarm inputs are configured, the camera triggers an alarm only when the normal state (open or closed) changes (see *Figure 2-5*). See *Device Settings* on page 37 to configure the alarm inputs.

The network camera has a LAMP setting which allows control of the moving IR cut filter when there is a change in state from Normally Open to Normally Closed (see *Device Settings* on page 37 for more information). In this way, the moving IR cut filter and the day/night operation of the camera can be synchronized with external lighting changes using a common controller such as a photocell or timer.

Figure 2-5 Normal Alarm States

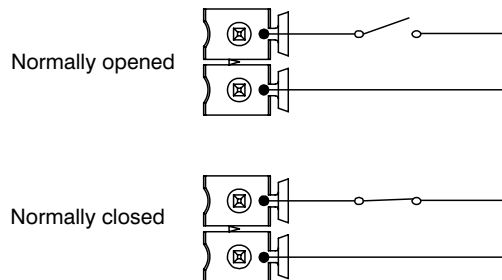

Connect external devices such as sirens or flashing lights to the alarm output connector to signal users of the camera that an alarm is activated. See *Figure 2-6* for alarm connection.

Figure 2-6 Alarm Output Connection

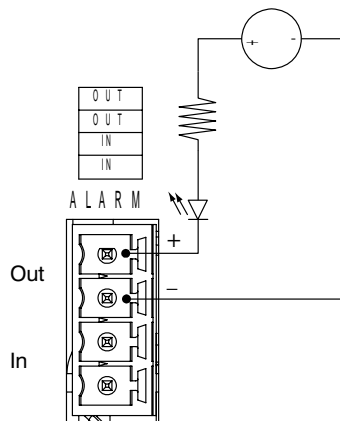

The alarm output can be configured to provide normally open or normally closed contacts (see *Device Settings* on page 37 to configure the alarm output). Contacts will be rated for 12 VDC @ 0.5 A.

Connecting Audio

The network camera supports bi-directional audio. There are two supported voice band channels that function in full duplex mode. The camera can transmit audio from the camera to the client (PC) using any audio source that provides an industry standard line level input (3.5 mm jack). The camera can also receive audio from the client (PC) and provide an industry standard line level output (3.5 mm jack) suitable to connect to audio devices. Audio input and output have 600 Ohm impedance. See *Audio Settings* on page 40 to configure audio options.

Restore Factory Defaults

Your network camera has a Factory Reset switch on the side of the camera (see *Figure 2-1*). Use this switch to restore your camera options and passwords to their default settings. Use a pin or straightened paperclip to press and hold the Reset switch for three seconds.

Configuring Network Settings

The Honeywell IP Utility is used to provide the network connectivity for the network camera system. The IP Utility automatically discovers Honeywell IP devices on the network and enables you to configure the device settings. Using the IP Utility, you can configure the IP network settings, name the camera(s), upgrade the firmware, and change the user passwords of the device.

Preparing the Honeywell IP Utility

To perform the tasks required to discover the network cameras and configure their settings, you must first install the IP Utility. After installing and logging on you can set the passwords for users in order to control access to the IP Utility.

Note Before installing and using the Honeywell IP Utility, make sure that your camera is connected to your network through an Ethernet cable (see *Network RJ-45 Ethernet Connection* on page 17).

System Requirements

The Honeywell IP Utility should be installed on a work station that meets the following minimum requirements:

Table 3-1 PC Minimum System Requirements

Component	Requirement
Operating System	Windows® 2000/XP®
Processor	Intel® Pentium® IV, 3.0 GHz or faster
RAM	512 MB or higher
Web Browser	Microsoft® Internet Explorer®, V6.0 or later

Installing the IP Utility

Note You must have Windows administrator privileges for the work station on which the Honeywell IP Utility is being installed.

To Install the IP Utility

1. Insert the CD into your CD-ROM drive and the **Honeywell IP Utility InstallShield** wizard appears.
OR
If InstallShield does not begin automatically, use Windows Explorer to navigate to the CD drive and double-click **Honeywell IP Utility Setup.exe**.
2. Follow the steps in the InstallShield wizard.
3. Click **Finish** to close the InstallShield wizard and complete the installation process.
4. Once the installation is complete, a Honeywell IP Utility icon () appears on your desktop. Double-click the icon to launch the IP Utility.

Note If Bonjour is not detected on the target computer then it will also be installed during the IP Utility installation.

Uninstalling the IP Utility

The IP Utility can be removed:

- Using the Start menu
- Using the Control Panel

Note When removing the IP Utility, you are given the option to uninstall Bonjour with the IP Utility.

Removing the IP Utility Using the Start menu

1. Click **Start**, and then choose **All Programs** ► **Honeywell Video Systems** ► **EQUIP Series** ► **IP Utility** ► **Uninstall Honeywell IP Utility**. A confirmation message appears.
2. Click **Yes**. The IP Utility is removed.

Removing the IP Utility Using the Control Panel

1. Click **Start**, and then choose **Settings** ► **Control Panel**. The **Control Panel** window appears.

2. Open Add or Remove Programs and then select **Honeywell IP Utility** in the Currently installed programs list.
3. Click **Change**. The **IP Utility Installation Wizard** screen appears.
4. Click **Next**, and then click **Remove**. The Honeywell IP Utility is removed.
5. Click **Finish** to close the wizard.

User Profiles

Once installed, the IP Utility provides two default users: Administrator and Guest. When using the IP Utility to access a device on the network, only one Administrator can connect to a specific device at a time, however, as Guest users are limited to viewing network settings, there are no such restrictions. The following table describes the roles and privileges for these users:

Table 3-2 User Roles and Privileges

User Role	Privileges
Administrator	<ul style="list-style-type: none"> • View the list of devices available on the network • Connect to the devices • Configure the IP network settings • Upgrade the firmware version • Change the password for the IP Utility application • Change the password for the Web-Client applications • Only one Administrator can be logged in at a time • Can enable/disable a device's Web-Client
Guest	<ul style="list-style-type: none"> • View the list of devices available on the network and their system settings, such as IP address

Logging On to the IP Utility

To Log On to the IP Utility

1. Click **Start**, and then select **Programs** ► **Honeywell Video Systems** ► **EQUIP Series** ► **IP Utility**.

OR



Double-click  on the desktop. The logon screen appears (*Figure 3-1*).

Figure 3-1 IP Utility Login Screen

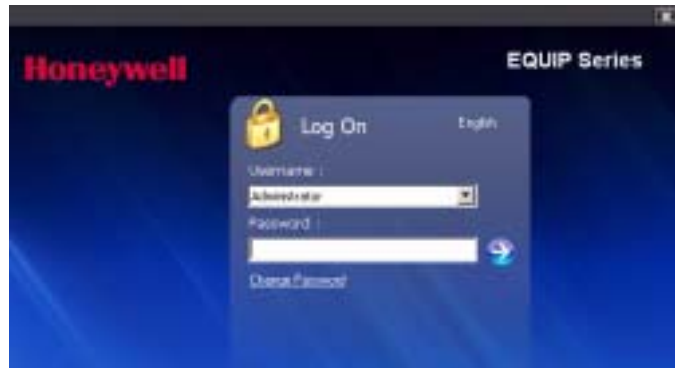

2. From the **Username** list, select **Administrator** or **Guest**.
3. Type the case-sensitive **Password** and click . The **Honeywell IP Utility** appears.

Note The default Administrator password is **1234** and the default Guest password is **guest**.

Changing the User Password

To Change a User's Password

1. Click **Start**, and then select **Programs** ► **Honeywell Video Systems** ► **EQUIP Series** ► **IP Utility**.
OR
Double-click the IP Utility icon () on your desktop.
2. The logon dialog box appears (see *Figure 3-1*).
3. Click **Change Password**. The **IP Utility** password dialog box (*Figure 3-2*) appears.

Figure 3-2 IP Utility Change Password Dialog Box



Passwords are hidden and replaced with '*' characters.

4. Select the **Username**.
5. Type the current password in the **Old Password** field.

6. Type the case-sensitive **New Password**, and then re-type the password in the **Verify Password** field.
7. Click **Apply**. The password is changed.

Note You must click **Apply** for your changes to take effect. If you close the screen before clicking **Apply**, all your new settings will be lost.

User Interface

The user interface of the Honeywell IP Utility provides access to network configuration and user settings through the Title bar, Discovery pane, Tabs and Status bar (see *Figure 3-3*).

Figure 3-3 IP Utility User Interface

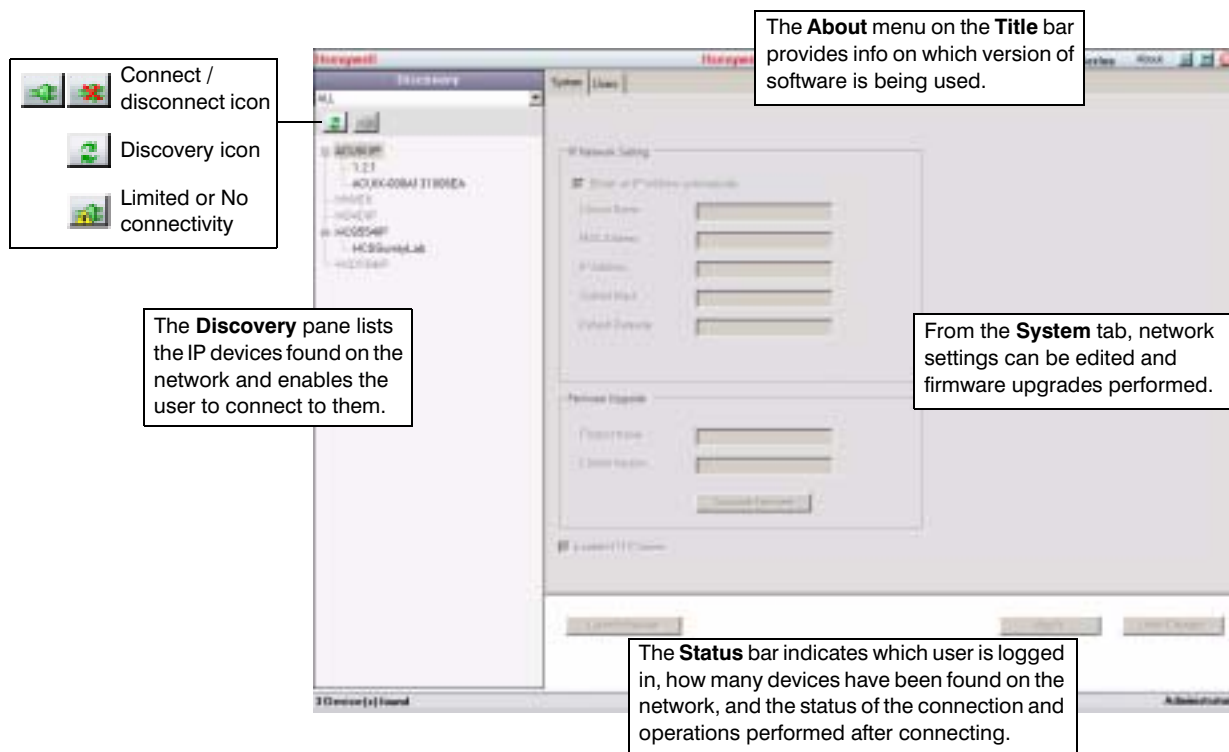

IP Camera Network Configuration

Discovering Devices

When you log on to the IP Utility, the devices on the network—including the devices on other subnets—are automatically discovered and listed in the **Discovery** pane. After the initial discovery, auto-refresh continues to discover devices that are newly added or removed from the network.

You can also manually refresh the device discovery by clicking the Discovery icon (), located near the top of the **Discovery** pane.

Note The Multicast protocol needs to be enabled in the LAN (router/switch) to discover the devices beyond the subnet.

Note Contact your network administrator if you have any questions regarding your local area network (LAN) or any other network related issues.

Connecting to Devices

Before configuring the IP network settings, you must connect to the IP device.

To Connect to a Device

- In the **Discovery** pane, double-click the device.
- OR
- Select the device and click . The network settings for the connected device are displayed in the **System** pane.

To Disconnect from a Device

- In the **Discovery** pane, select the device, and click .

Note When you see the Limited/No connectivity icon (), you cannot fully connect to the device because of network related issues. Check your network settings to resolve the issue.

Configuring IP Network Settings

The IP network setting details such as device name, IP address, and subnet mask can be configured for each connected device.

Updating IP Network Settings Automatically

To update the IP network settings of a device automatically:

1. In the **Discovery** pane, select the device and click .
2. On the **System** tab, select **Obtain an IP Address automatically**. Enter the **Device Name**.
3. Click **Apply**. The available IP address, subnet mask and default gateway are assigned to the device from the network server automatically.

Note You must click **Apply** for your changes to take effect. If you close the screen before clicking **Apply**, all your new settings will be lost.

Figure 3-4 IP Network Settings Obtained Automatically



IP Network Setting

Obtain an IP Address automatically

Device Name:

MAC Address:

IP Address: (DHCP)

Subnet Mask:

Default Gateway:

Note When you obtain an IP address automatically, the network supplies the camera with a DHCP address. If no DHCP server is present in the network, the camera will default to an APIPA address (169.254.x.x).

Updating IP Network Settings Manually

To configure the IP network settings of a device manually:

1. In the **Discovery** pane, select the device and click .
2. Click the **System** tab.
3. Make sure the **Obtain an IP Address automatically** check box is not selected.

- Under **IP Network Setting**, enter the following details:

Table 3-3 IP Network Setting Options of the Device

Option	Description
Obtain an IP Address automatically	This option must NOT be checked to assign a static IP address to the device.
Device Name	The name of the device
MAC Address	The preset, unique MAC address of the device is used to identify specific devices.
IP Address	The IP address of the device on the network
Subnet Mask	The subnet mask value of the device on the network
Default Gateway	The default gateway address that connects the device to the static network.

Note Changing the network (IP) settings except for the Device Name will cause the device to restart.

Caution Check the values for the IP network settings before applying them. Incorrect values might cause a failure when connecting to the network camera.

- Click **Apply**. The network settings are updated and a message appears in the status bar, confirming the update.

Note You must click **Apply** for your changes to take effect. If you close the screen before clicking **Apply**, all your new settings will be lost.

Figure 3-5 IP Network Settings Obtained Manually

IP Network Setting

Obtain an IP Address automatically

Device Name: HCSumLab

MAC Address: 88A17394C3

IP Address: 192.168.45.126 (STATIC)

Subnet Mask: 255.255.255.0

Default Gateway: 192.168.45.1

Upgrading the Firmware

To Upgrade the Firmware of the Network Camera

1. Check www.honeywellvideo.com/support/downloads/downloads_cam.html and find your camera in the list. Click the firmware link to download the file.
2. In the **Discovery** pane, select the device to upgrade and click .

Figure 3-6 IP Utility Firmware Upgrade



3. Click **Upgrade Firmware**. Follow the upgrade wizard steps to complete the upgrade.
4. Click **OK** when the upgrade is complete. The device is rebooted. It takes about 3 minutes to complete the upgrade process.

Note The network camera rebooting after the upgrade will result in a temporary loss of connection with the camera.

Launching the Web-Client Application

You can open individual Web-Client applications for each discovered device from the IP Utility. To launch the Web-Client application:

1. From the **Discovery** pane, select the device you want to launch and click .
2. From the **System** tab, click **Launch Browser**. The Web-Client application of the selected network camera opens in Internet Explorer.

Note To enable or disable the HTTP server, select or clear the **Enable HTTP Server** check box. By default, the check box is enabled.

3. Select the user name and enter the password to log on to the application.

Note You can also launch the Web-Client application by opening your web browser and enter the URL (network camera IP address) in the Address bar.

Changing Web-Client Application Password

The IP Utility enables you to change the password for the network camera Web-Client.

To Change the Password of the Web-Client Application

1. Select the device from the **Discovery** pane and click .
2. Click the **Users** tab.

Figure 3-7 Changing Web-Client User Passwords



3. Select the **Username**.
4. Type the **Old Password**.
5. Type the case-sensitive **New Password** and then re-type it in the **Verify Password** field.
6. Click **Apply**. The password is changed.

Note You must click **Apply** for your changes to take effect. If you close the screen before clicking **Apply**, all your new settings will be lost.

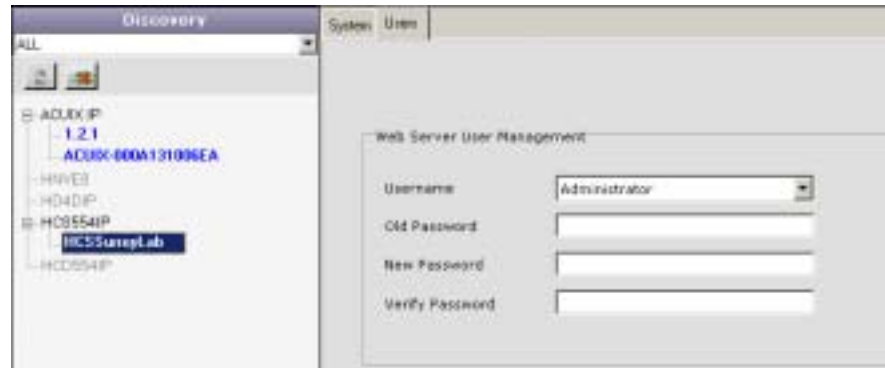
IP Camera Web-Client

Overview

The network camera Web-Client is a web-based application that enables you to view video, listen to audio, and configure camera and sabotage detection settings for the network camera.

Note Certain features of the IP Camera Web-Client are user-based and are available only to the administrator. Guest users are limited to the Live View tab. Only one Administrator can be logged on at a time, while up to four Guest users can logon at the same time.

User Profiles

The following table describes the roles and privileges for the network camera Web-Client application users:

Table 4-1 User Roles and Privileges

User Role	Privileges
Administrator	<ul style="list-style-type: none"> View video and network settings Configure the alarm settings Set up the video compression and audio settings Configure auto exposure and white balance for the camera Set up camera sabotage detection settings Only 1 Administrator can be logged in at a time
Guest Operator	<ul style="list-style-type: none"> View video Up to 4 Guests can be logged in at a time

Accessing the IP Camera Web-Client

First Time Setup Requirements

Live images can be viewed from an internet browser with the Web-Client interface. An ActiveX® control must be downloaded to your computer before you will be able to view video. The security settings on your browser may need to be modified to allow ActiveX controls to be downloaded. Configure your browser security settings as follows:

1. Open Internet Explorer on your PC.
2. On your web browser, select the **Tools** drop-down menu, then **Internet Options**.
3. Select the **Security** tab (see *Figure 4-1*).

Figure 4-1 Internet Options

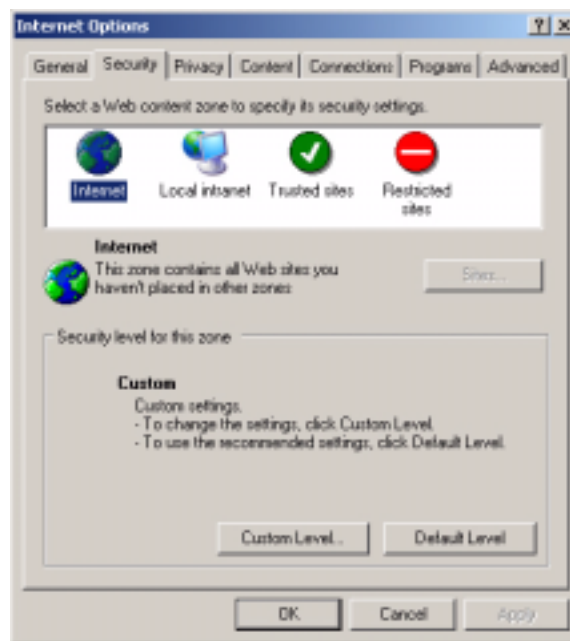

4. Select **Internet** and click the **Custom Levels** security button.
5. Scroll down the list to the **ActiveX controls and plug-ins** options and enable all ActiveX control functions on the list (see *Figure 4-2*):
 - Download signed ActiveX controls
 - Download unsigned ActiveX controls
 - Initialize and script ActiveX controls not marked as safe
 - Run ActiveX controls and plug-ins
 - Script ActiveX controls marked as safe for scripting

Figure 4-2 Security Settings

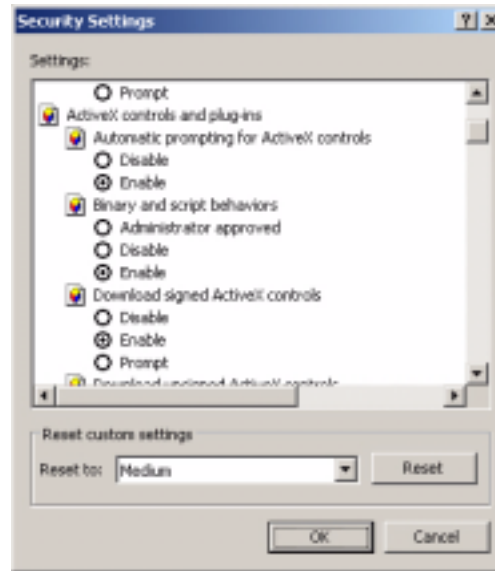

6. Click **OK** on the **Security Settings** dialog box.
7. Select **Local Intranet** and click the **Custom Levels** security button.
8. Scroll down the list to the **ActiveX controls and plug-ins** options and enable all ActiveX control functions on the list (see [step 5](#)).
9. Click **OK** on the **Security Settings** dialog box.
10. Click **Apply**, then **OK** on the **Internet Options** dialog box.

Logging On

Note Only 1 Administrator user and 4 Guest users can log on to the Web-Client application at one time.

To log on to the Web-Client

1. From the IP Utility, see [Launching the Web-Client Application](#) on page [29](#).

OR

From Internet Explorer (v6.0+), enter the URL (IP address of the device) in the Address bar to display the logon screen ([Figure 4-3](#)).

Figure 4-3 Logon Screen

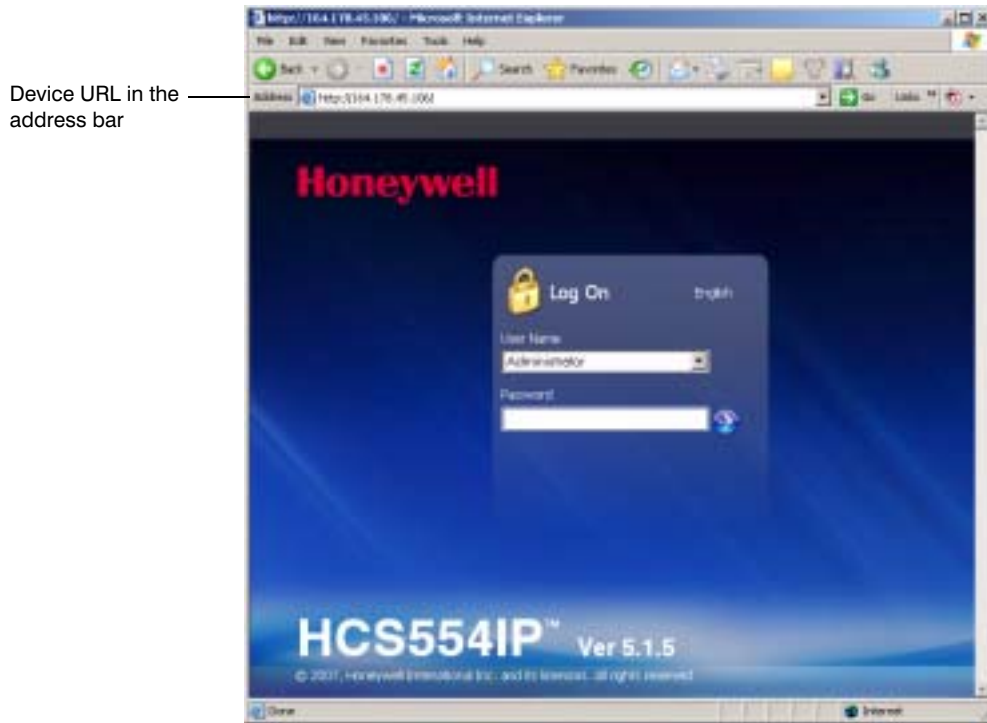

Device URL in the address bar

2. Select either **Administrator** or **Guest** from the list, enter the case-sensitive password and press **Enter**.

Note The default password for the Administrator is **1234** and for the Guest user it is **guest**.

3. The Web-Client appears.

Installing Honeywell IP (ActiveX Plug-in)

If this is the first time you've logged on, you may have to install the Honeywell IP ActiveX control. If the InstallShield Wizard opens (*Figure 4-4*), click **Next** and follow the rest of the InstallShield Wizard instructions to complete the installation. When the installation is complete, you will observe live streaming video.

Note If you are using the Web-Client on a PC that does not have the Honeywell IP Utility installed, the Honeywell IP Adapter will be installed along with the Honeywell IP ActiveX. The Honeywell IP Adapter is required to run the Web-Client application.

Figure 4-4 Honeywell IP Installation (ActiveX Plug-in)

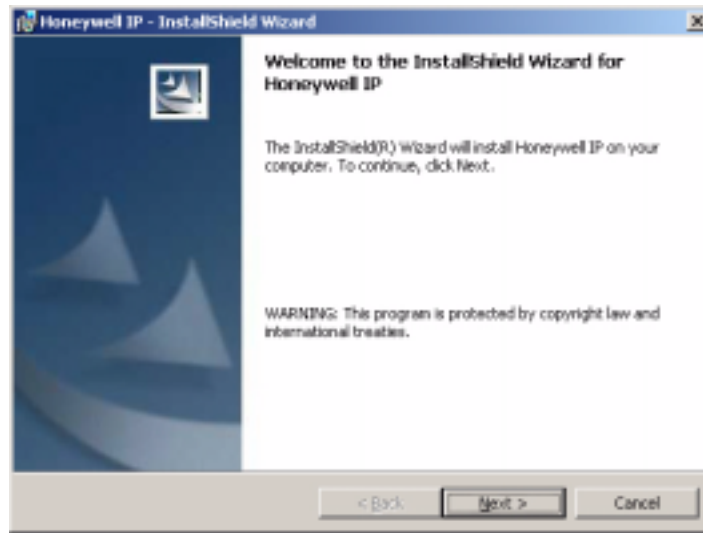

Logging Off

To log off from the Web-Client application, click **Logout** at the top of the page. The Logon screen appears.

Uninstalling Honeywell IP (ActiveX Plug-in)

1. Click **Start**, and then choose **Control Panel**. The **Control Panel** window appears.
2. Double-click **Add or Remove Programs** and then select **Honeywell IP** from the **Currently installed programs** list.
3. Click **Change/Remove** to remove the component.
4. Follow the Uninstallshield wizard instructions to completely remove the application.

Navigating the User Interface

The user interface of the Web-Client application consists of multiple user-friendly views organized by functionality. Access to the views is user controlled.

Table 4-2 Tabs/Views in the Web-Client Application

Tab	Enables you to...
Live View	View video.
Device Information	View the network settings and firmware details of the camera. Configure the alarm settings.
Compression Settings	Configure the compression and audio settings.
Camera Setup	Configure auto exposure and white balance for the camera.
Video Analytics	Configure the camera sabotage detection settings and view video display.

Figure 4-5 Web-Client: Administrator User

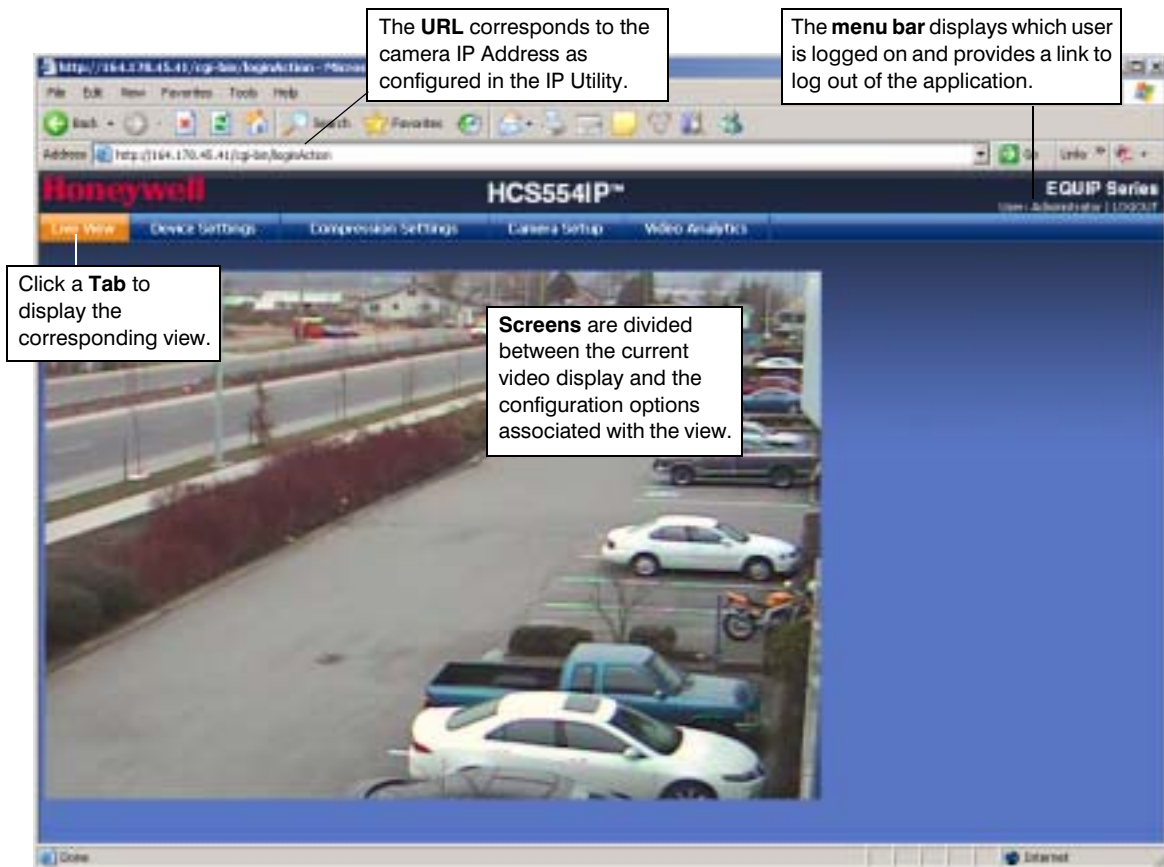
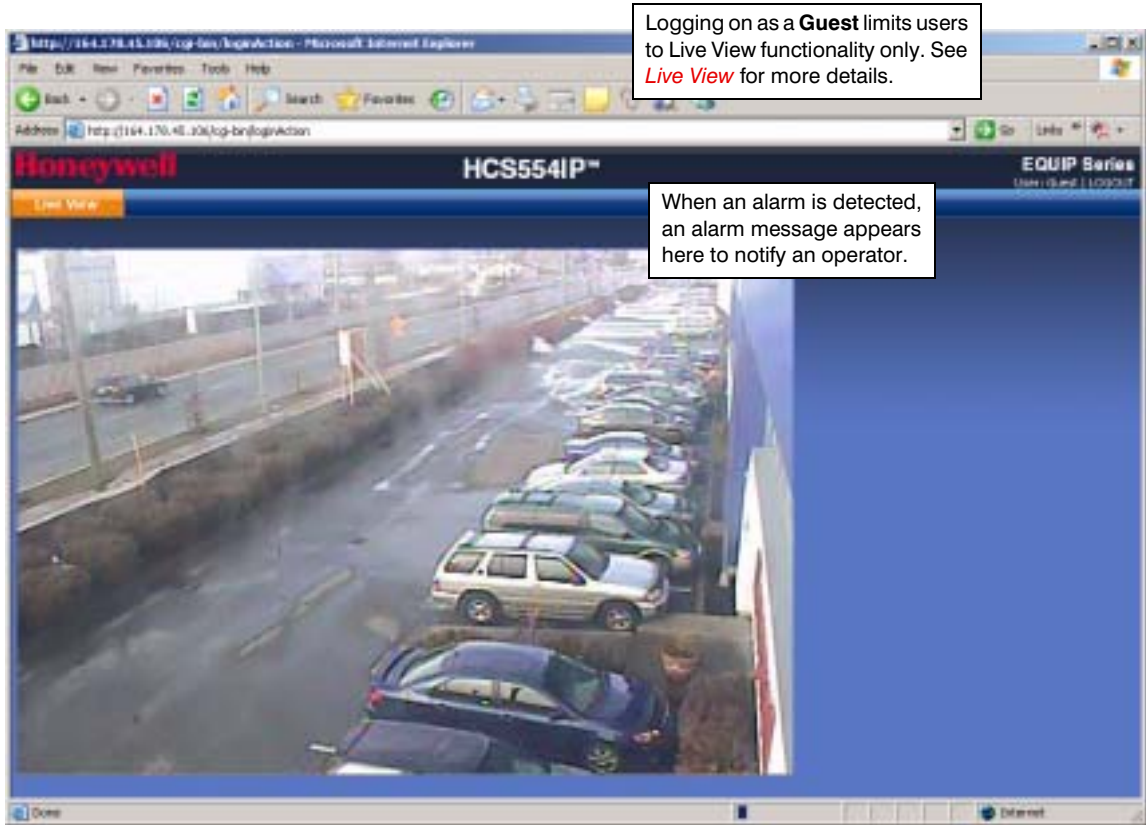

Figure 4-6 Web-Client: Guest User



Live View

Live View provides the user with the ability to view live video as currently viewed by the camera (see [Figure 4-5](#) and [Figure 4-6](#)).

Device Settings

The Device Settings view mirrors the information that is available in the Honeywell IP Utility. It provides network and firmware settings without having to access the IP Utility.

The device Alarm Settings are also configurable in this view. Set the **Alarm Input** as **Normally Open**, **Normally Close**, **LAMP** (HCD554IP/X only) or **Disable**. When alarm inputs are connected, the camera triggers an alarm only when the normal state (open or

closed) changes. The **LAMP** setting allows control of the moving IR cut filter and day/night operation to be synchronized with a common controller. See *Connecting Alarms* on page 18 for more information.

Connect external devices such as sirens or flashing lights to the alarm output connector to signal users of the camera that an alarm is activated. Set the **Alarm Output** as **Normally Open** or **Normally Close**. The camera triggers the alarm output only when the normal state (open or closed) changes. See *Connecting Alarms* on page 18 for more information.

When an alarm input event is detected, an alarm message appears on the Web-Client screen (see *Figure 4-6*) to notify the operator.

Note You must click **Apply** for your changes to take effect. If you close the screen before clicking **Apply**, all your new settings will be lost.

Figure 4-7 Device Settings

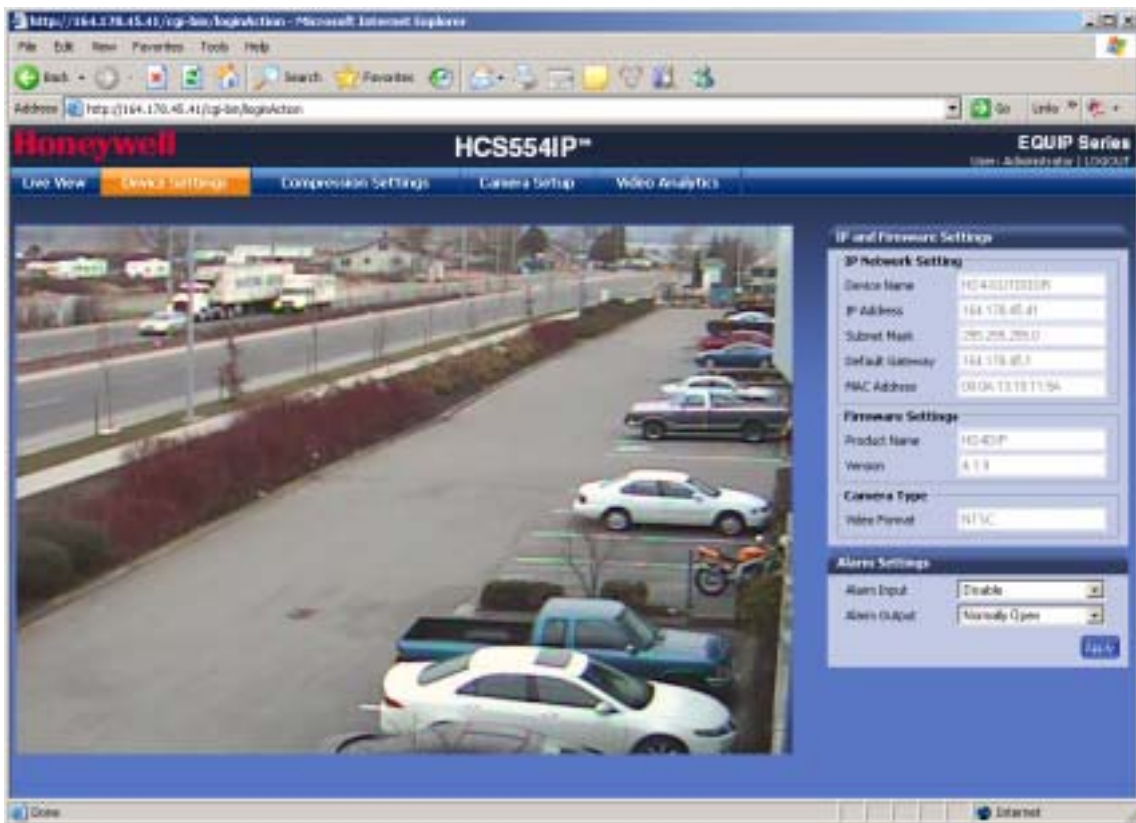

Compression Settings

The video signal sent to the Web-Client from the camera has a number of settings that can be edited which effect the video as it's displayed in the Web-Client. The Compression Settings view enables you to configure settings such as Resolution, Frame Rate and Picture Quality.

Note You must click **Apply** for your changes to take effect. If you close the screen before clicking **Apply**, all your new settings will be lost.

Figure 4-8 Compression Settings

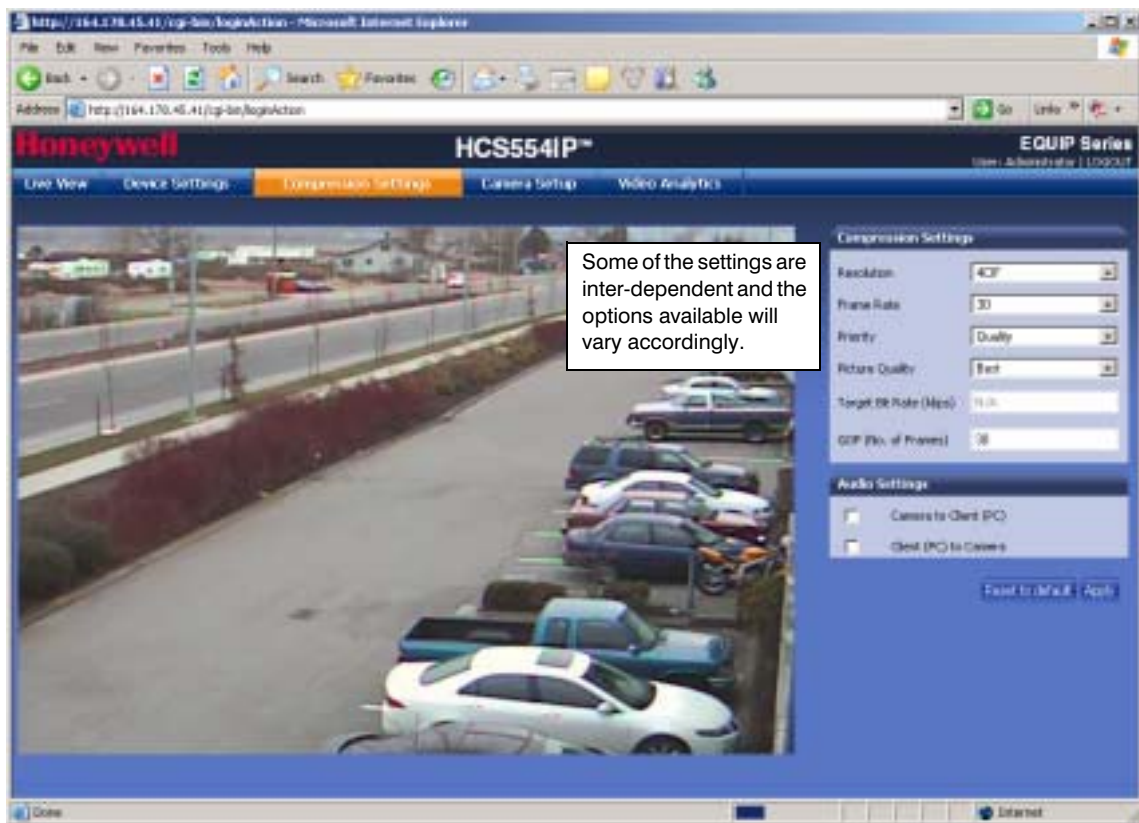

Compression Settings

The quality of the video displayed can be configured as needed using the Compression Settings. Use the following table to set up video compression.

Table 4-3 Compression Settings

Setting	Options	Description
Resolution	4CIF, 2CIF, CIF	4CIF is the highest resolution and CIF is the lowest resolution.
Frame Rate	1–30	The frame rate that is displayed per second. For NTSC, select from 1 fps (lowest) to 30 fps (highest). For PAL, select from 1 fps (lowest) to 25 fps (highest).
Priority	Quality, Bit Rate	Choose the Priority selection based on user requirements. If you select Quality , Target Bit Rate is greyed out and Picture Quality is activated. If you select Bit Rate , Picture Quality is greyed out and Target Bit Rate is activated.
Picture Quality	Best, Better, Good	When Quality is selected as the Priority, select the Picture Quality as Good (lowest visual quality), Better , or Best (highest visual quality).
Target Bit Rate (kbps)	400–5000 kbps	Enter the Target Bit Rate in kbps (kilobits per second) which represents the amount of data processed per second.
GOP (No. of Frames)	1–100	Select the GOP (Group of pictures) number from 1 to 100 .

Audio Settings

The network camera supports bi-directional audio. There are two supported voice band channels that function in full duplex mode. Connect industry standard line level audio input and output to the back of your camera. See *Connecting Audio* on page 20 for more information.

Audio configuration for your network camera is straightforward. To listen to or capture audio from the camera, enable the **Camera to Client (PC)** check box (Camera to Client (PC)). To listen to audio from the client (PC), enable the **Client (PC) to Camera** check box.

Camera Setup

The Camera Setup view provides access to the settings used to configure the camera functionality. The following section explains Auto Exposure and White Balance setup.

Note You must click **Apply** for your changes to take effect. If you close the screen before clicking **Apply**, all your new settings will be lost.

Figure 4-9 Camera Setup

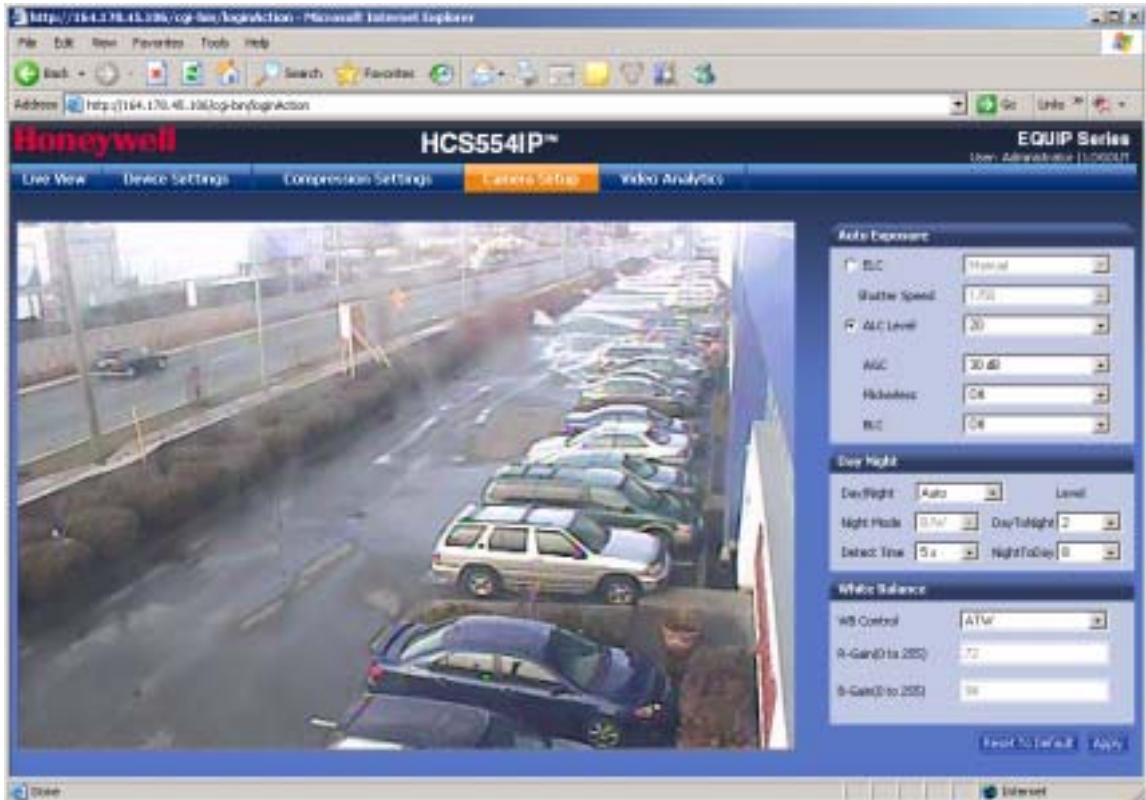

Auto Exposure

The camera lens, lighting and true day/night options can be configured as needed using the Auto Exposure settings. Use the following table to set up Auto Exposure options.

Note You must click **Apply** for your changes to take effect. If you close the screen before clicking **Apply**, all your new settings will be lost.

Table 4-4 Auto Exposure Settings

Setting	Options	Description
ELC (Electronic Light Control)	Auto, Manual Shutter Speed: 1/60–1/100000 (NTSC) 1/50–1/100000 (PAL)	For a manual iris lens: Auto: Camera will perform electronic exposure automatically. Manual: Adjust the iris by changing the shutter speed manually.
ALC (Automatic Light Compensation)	DC Iris Level: 1–25	For an automatic iris lens. Adjust the DC Iris Level until the image is neither too bright nor too dark.
AGC (Automatic Gain Control)	Off, 10 dB–30 dB	Adjust the maximum value of AGC gain. AGC can be Off , or set from 10 dB–30 dB .
BLC (Backlight Compensation)	Off, Low, Mid, High	Prevents the object in the center of the image from darkening when there is excessive light from behind.
Flicker Less	Off, On	Eliminates the “flicker” that can appear in an image under certain lighting conditions (for example, fluorescent lighting).
Day/Night	Auto, Manual On, Manual Off	Set the moving, mechanical IR filter within the camera to ensure true 24 hour surveillance (HCD554IP/X only).
Detect Time	5–60 seconds	Sets the time (5–60 seconds) before the camera switches to Day or Night mode after detecting a low light condition. Day/Night must be set to Auto .
DayToNight	1–7	Determines the low light detection level (1–7) when the camera switches to Night mode. The lower the value, the darker the lighting conditions before the camera switches. Day/Night must be set to Auto . Note The DayToNight threshold must be set at least 2 less than the NightToDay threshold setting.
NightToDay	3–9	Determines the low light detection level (3–9) when the camera switches to Day mode. The higher the value, the brighter the lighting conditions before the camera switches. Day/Night must be set to Auto .
Night Mode	B/W or Color	Sets the color mode as B/W (monochrome) or Color in Night Mode. Day/Night must be set to Manual On .

White Balance

White Balance ensures that color integrity is maintained in the camera image by compensating for the temperature color “casts” that different light sources can cause. Use the following table to set up White Balance options.

Note You must click **Apply** for your changes to take effect. If you close the screen before clicking **Apply**, all your new settings will be lost.

Table 4-5 White Balance Settings

Option	Description
ATW (Auto Trace White Balance Mode)	Feedback system that automatically aligns the white balance (2800°K to 8000°K).
User Fixed	Preset (4700°K)
AWC Auto (Auto White Balance Control Mode)	Performs faster action than ATW mode without an operating range. When set to Auto, AWC operates all the time.
Fluorescent	For office environments with fluorescent or tungsten lighting. Provides the lowest dynamic range of all presets (4200°K).
MWB (Manual Mode)	Manual white balance mode. Set the Red and Blue gains from 0–255.
Indoor	General indoor scenes preset (3200°K).
AWC Manual (Auto White Balance Control Mode)	Operates AWC mode manually. When the AWC operation starts, click Lock to set the present scene's white balance.
Outdoor	Preset for outside environments and high-contrast scenes where the camera is focused on the darker areas (6300°K).

Video Analytics

The network camera can be configured to detect three types of sabotage detection via the Video Analytics view (see [Figure 4-10](#)): blinding the camera, blurring the video display, and tampering with the camera field of view. Alarm messages appear above the video display when camera sabotage is detected (see [Figure 4-11](#)).

The user must note that when the following conditions are applicable, the tamper detection features must be manually disabled to avoid raising false alarms:

- during the configuration of the video display
- while text is overlaid on the video
- if the video display becomes too dark

Figure 4-10 Video Analytics

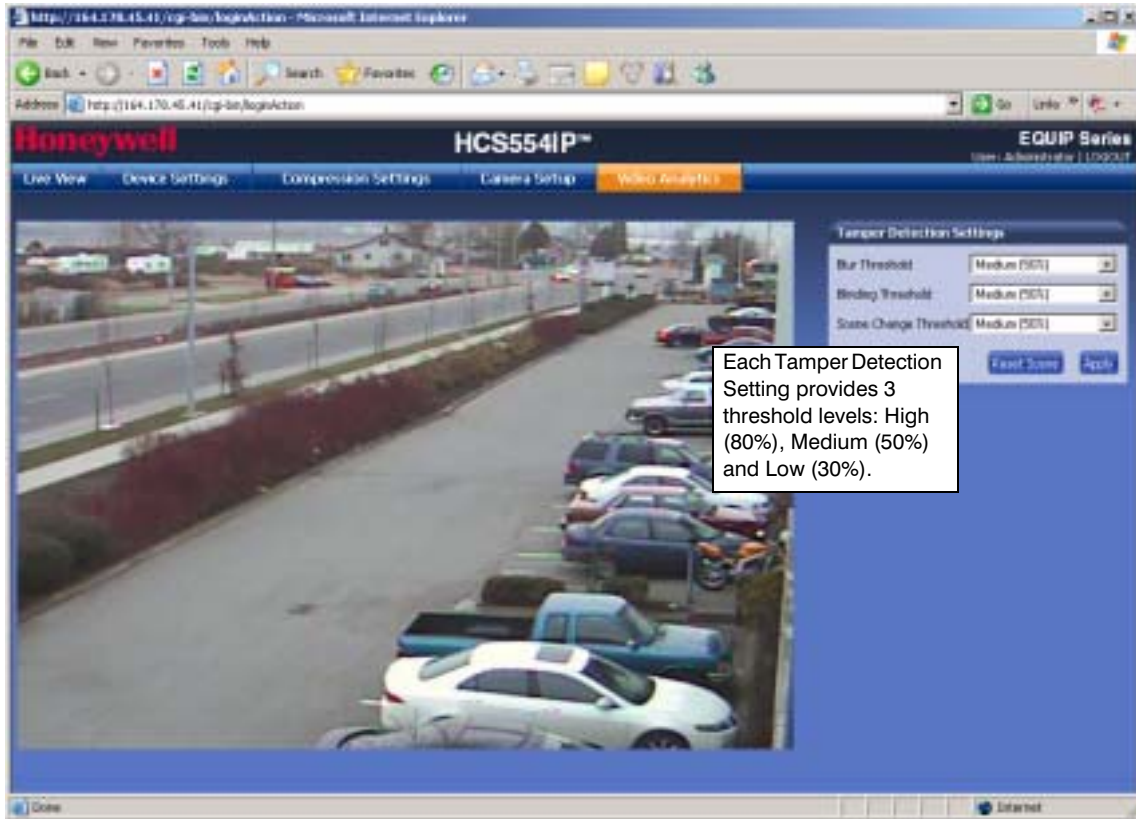

Figure 4-11 Video Analytics Message



Video Blurring

The video appears blurred when the camera is exposed to elements such as water. When this occurs, video blurring in the field of view is detected and shows an alarm message (see [Figure 4-11](#)) above the video display. To detect video blurring:

1. Click the **Video Analytics** tab.

- In the **Blur Threshold** list, select one of the following options:

Table 4-6 **Blur Threshold Values**

Value	To detect ...
High (80%)	Maximum video blurring. The alarm message appears when the video display is blurred by 80% and above.
Medium (50%)	Medium video blurring. The alarm message appears when the video display is blurred by 50% and above.
Low (30%)	Minimum video blurring. The alarm message appears when the video display is blurred by 30% and above.

- Click **Apply**.

Note To turn off video blur detection, select **Disable** in the **Blur Threshold** list. **Disable** is the default value.

Note You must click **Apply** for your changes to take effect. If you close the screen before clicking **Apply**, all your new settings will be lost.

Camera Blinding

An obstacle in front of the camera lens can blind the camera. When this occurs, camera blinding is detected and shows an alarm message above the video display (see [Figure 4-11](#)). To detect camera blinding:

- Click the **Video Analytics** tab.
- In the **Blinding Threshold** list, select one of the following options:

Table 4-7 **Blinding Threshold Values**

Value	To detect ...
High (80%)	Maximum blinding. The alarm message appears when the camera is blinded by 80% and above.
Medium (50%)	Medium blinding. The alarm message appears when the camera is blinded by 50% and above.
Low (30%)	Minimum blinding. The alarm message appears when the camera is blinded by 30% and above.

- Click **Apply**.

Note To turn off camera blind detection, select **Disable** in the **Blinding Threshold** list. **Disable** is the default value.

Note You must click **Apply** for your changes to take effect. If you close the screen before clicking **Apply**, all your new settings will be lost.

Camera Field of View Change

The Web-Client application can detect tampering of the camera field of view and show an alarm message above the video display (see [Figure 4-11](#)). To detect a camera field of view change:

1. Click the **Video Analytics** tab.
2. In the **Scene Change Threshold** list, select one of the following options:

Table 4-8 Scene Change Threshold Values

Value	To detect ...
High (80%)	Maximum change in the camera field of view. The alarm message appears when tampering causes 80% and above change in the camera field of view.
Medium (50%)	Medium change in the camera field of view. The alarm message appears when tampering causes 50% and above change in the camera field of view.
Low (30%)	Minimum change in the camera field of view. The alarm message appears when tampering causes 30% and above change in the camera field of view.

3. Click **Apply**.

Note To turn off camera field of view change detection, select **Disable** in the **Scene Change Threshold** list. **Disable** is the default value.

Note You must click **Apply** for your changes to take effect. If you close the screen before clicking **Apply**, all your new settings will be lost.

A

Troubleshooting

Technical Support

Prior to calling Honeywell technical support, refer to the following topics for possible solutions to problems with your network camera. To contact the Honeywell Video Systems technical support team, call 1-800-796-2288 (North America only) or send an e-mail to HVSsupport@honeywell.com.

Any equipment returned to Honeywell Video Systems for warranty or service repair must have a Return Merchandise Authorization (RMA) number. The RMA number must be clearly marked on all return packages and internal paperwork.

Problem: Web-Client Does Not Display the Expected Video

Possible solutions:

1. Ensure that your web browser settings have been configured to allow ActiveX controls (if you see the message in *Figure A-1*, your web browser settings have not been configured). See *First Time Setup Requirements* on page 32 for information on setting up your browser.

Figure A-1 ActiveX Control Failed Message



If your internet security settings are set to “Prompt” you to install ActiveX controls, you may see a warning similar to *Figure A-2*. Click **Install** to install the ActiveX control. See *Installing Honeywell IP (ActiveX Plug-in)* on page 34 for the installation procedure.

Figure A-2 Install Unknown Software Prompt

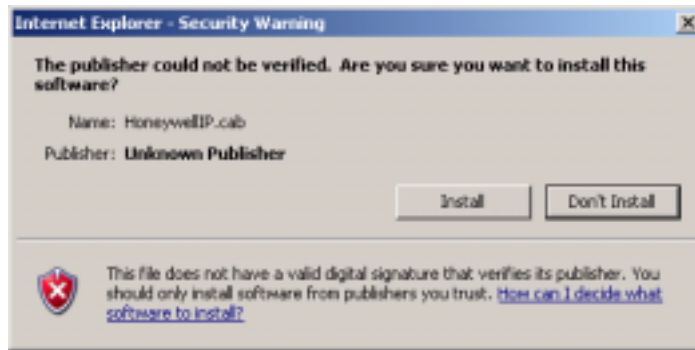

2. Ensure that the network cable from the camera is connected to both the camera and the network.

Problem: Cannot Connect to a Device

When the following message (*Figure A-3*) displays in the status bar of the IP Utility, your device connection is limited. Usually this warning state indicates that your PC and the device you are connecting to are on different subnets. Contact your network administrator for help to resolve your network issue(s).

Figure A-3 Limited or No Connection Message



Specifications

Note These specifications refer to all models, except where otherwise noted. Specifications are subject to change without notice.

Table B-1 Camera Specifications

Specification	HCD554IP	HCS554IP
Operational		
Image Sensor	1/3" CCD	
Lens Mount	CS Lens Mount	
Video Standard	NTSC or PAL	
Scanning System	525/60 lines (NTSC), 625/50 lines (PAL)	
Minimum Illumination	0.7 lux color / 0.2 lux B/W	0.7 lux color / 0.5 lux B/W
Horizontal Resolution	540 TVL	
Video Output (BNC)	1.0 Vp-p @ 75 Ohms (test only)	
S/N Ratio	50 dB or more (AGC off)	
Auto Gain Control (AGC)	Off/On, selectable (10–30 dB)	
ALC	DC Iris Level 1–25	
Automatic Electronic Shutter (ELC)	1/60–1/100,000 sec (NTSC) 1/50–1/100,000 sec (PAL)	
White Balance (AWB)	ATW, User Fixed, AWC (Auto or Manual), Fluorescent, MWB (Manual Mode), Indoor, Outdoor	
BLC	Off/On, selectable (Low, Mid, High)	
Gamma	0.45	
Electrical		
Input Voltage	12 VDC / 24 VAC, PoE IEEE 802.3 af	
Input Voltage Range	11–16 VDC, 17–28 VAC	
Surge Suppression	1.5 kW transient	
Power Consumption	8 W (max)	

Table B-1 Camera Specifications (cont'd)

Specification	HCD554IP	HCS554IP
IP Specifications		
Video Compression	MPEG-4 Part 2 (ISO/IEC 14496-2) SP level 0–3	
Resolutions	4CIF, 2CIF, CIF, 704x480 (NTSC), 704x576 (PAL)	
Frame Rate (NTSC/PAL)	Up to 30/25 fps video in all resolutions	
Video Streaming	MPEG-4 controllable frame rate and bandwidth. Constant and variable bit rate (MPEG-4).	
Security	Multiple user access levels with password protection	
Users	1 Administrator, 4 Guests	
Video access from web browser	Camera live view for up to 5 clients. Full control of all camera settings available to administrator.	
Minimum web browsing requirements	Pentium IV CPU 3.0 GHz or equivalent AMD 512 MB RAM AGP graphics card (32 MB RAM) Windows 2000/XP, Internet Explorer 6.0 or later	
Supported Protocols	IPv4, HTTP, TCP, RTSP, RTP, UDP, IGMP, RTCP, FTP, ICMP, DHCP, Bonjour, ARP, DNS	
Mechanical		
Dimensions (W x H x D)	See diagram (<i>Figure B-1</i>)	
Weight	1.1 lb (0.5 kg) camera only	
Construction	Housing: Aluminum Finish: Cool gray powder coat	
Connector	Video Output: BNC connector Lens: 4 Pin connector Power Input: Removable screw terminal block Alarm I/O: Removable screw terminal block Network: RJ45 connector	
Environmental		
Temperature	Operating: 14°F to 122°F (-10°C to +50°C) Storage: -4° to 140°F (-20°C to 60°)	
Relative Humidity	0% to 85%, non-condensing	
Regulatory		
Emissions	FCC, CE (EN55022)	
Immunity	CE (EN50130-4)	
Safety	EU: 73/23/EEC LVD UL Listed (file E319174)	

Figure B-1 Network Camera Dimensions

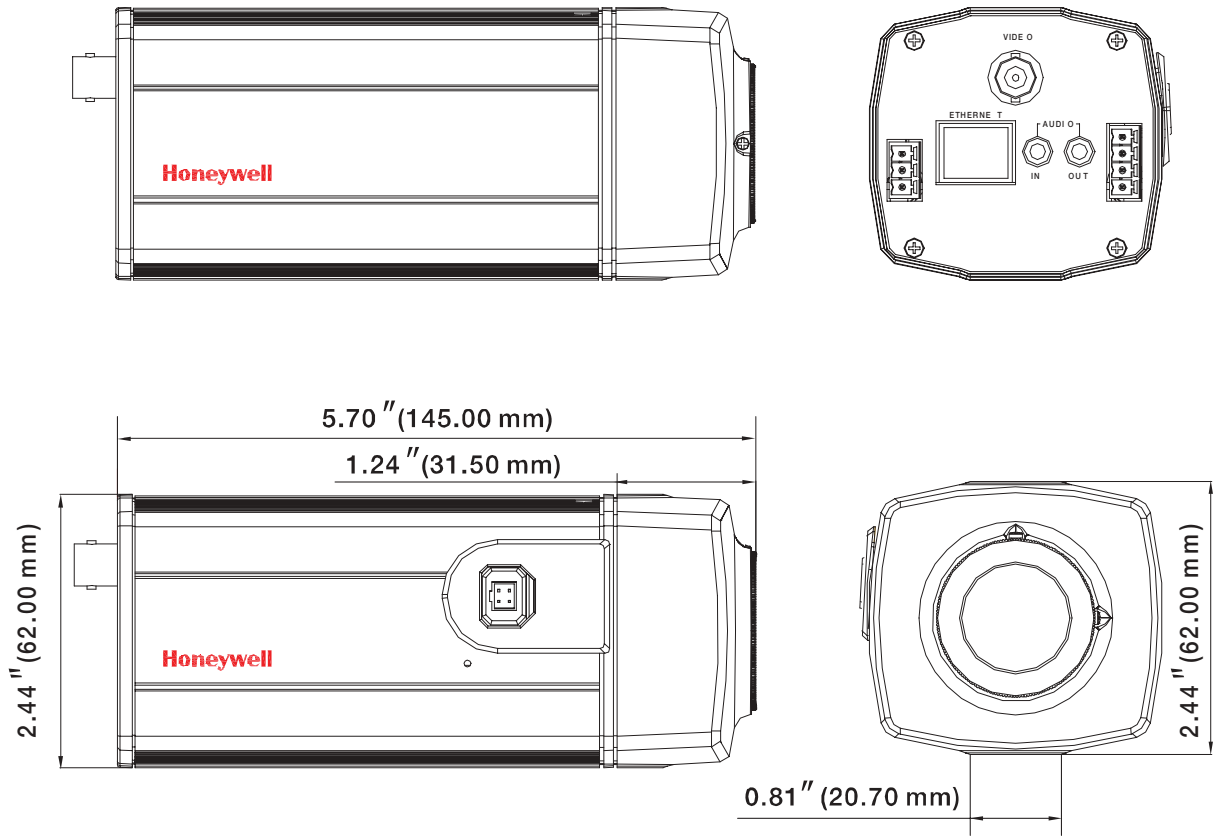

Honeywell Video Systems (Head Office)

2700 Blankenbaker Pkwy, Suite 150
Louisville, KY 40299, USA
www.honeywellvideo.com
☎ +1.800.796.2288

Honeywell Security Australia Pty Ltd.

Unit 5, Riverside Center, 24-28 River Road West
Parramatta, NSW 2150, Australia
www.honeywellsecurity.com.au
☎ +61.2.8837.9300

Honeywell Security Asia Pacific

33/F Tower A, City Center, 100 Zun Yi Road
Shanghai 200051, China
www.asia.security.honeywell.com
☎ +86 21.5257.4568

Honeywell Security Asia

Flat A, 16/F, CDW Building, 388 Castle Peak Road
Tsuen Wan, N.T., Hong Kong
www.asia.security.honeywell.com
☎ +852.2405.2323

Honeywell Security South Africa

Honeywell House, Bekker Street
Truer Close, Waterfall Park
Midrand 1685, South Africa
www.honeywell.com/security/za
☎ +27.11.695.8000

Honeywell Security Middle East

Honeywell Middle East FZE
Post Office Box 18530
LOB Building 08, Office 199
Jebel Ali, Dubai U.A.E.
www.honeywell.com/security/me
☎ +971.04.881.5506

Honeywell Security UK

Aston Fields Road, Whitehouse Ind Est
Runcorn, Cheshire, WA7 3DL, UK
www.honeywell.com/security/uk
☎ +44.1928.756.999

Honeywell Video Systems Northern Europe

Netwerk 121
1446 WV Purmerend, The Netherlands
www.honeywell.com/security/nl
☎ +31.299.410.200

Honeywell Security Deutschland

Johannes-Mauthe-Straße 14
D-72458 Albstadt, Germany
www.honeywell.com/security/de
☎ +49.74 31.8 01.0

Honeywell Security France

Parc Gutenberg, 8, Voie La Cardon
91120, Palaiseau, France
www.honeywell.com/security/fr
☎ +33.01.64.53.80.40

Honeywell Security Italia SpA

Via della Resistenza 53/59
20090 Buccinasco
Milan, Italy
www.honeywell.com/security/it
☎ +39.02.4888.051

Honeywell Security España

Mijancas 1. 3a planta
P.Ind. Las Mercedes
28022 Madrid, Spain
www.honeywell.com/security/es
☎ +34.902.667.800

Honeywell

www.honeywellvideo.com
+1.800.796.CCTV (North America only)
HVSsupport@honeywell.com

Document 800-00250 – Rev C – 08/08

© 2008 Honeywell International Inc. All rights reserved. No part of this publication may be reproduced by any means without written permission from Honeywell Video Systems. The information in this publication is believed to be accurate in all respects. However, Honeywell Video Systems cannot assume responsibility for any consequences resulting from the use thereof. The information contained herein is subject to change without notice. Revisions or new editions to this publication may be issued to incorporate such changes.

Free Manuals Download Website

<http://myh66.com>

<http://usermanuals.us>

<http://www.somanuals.com>

<http://www.4manuals.cc>

<http://www.manual-lib.com>

<http://www.404manual.com>

<http://www.luxmanual.com>

<http://aubethermostatmanual.com>

Golf course search by state

<http://golfingnear.com>

Email search by domain

<http://emailbydomain.com>

Auto manuals search

<http://auto.somanuals.com>

TV manuals search

<http://tv.somanuals.com>