

MONITOR WITH DVD RECEIVER INSTRUCTION MANUAL

JVCKENWOOD Corporation

DDX395 (Region 1 – DVD Region Code 1 Area)

DDX375BT (Region 1 – DVD Region Code 1 Area)

DDX350BT (Region 1 – DVD Region Code 1 Area)

DDX25BT (Region 1 – DVD Region Code 1 Area)

DDX418BT (Region 4 – DVD Region Code 4 Area)

This instruction manual is used to describe the models listed above. Model availability and features (functions) may differ depending on the country and sales area.

Take the time to read through this instruction manual.

Familiarity with installation and operation procedures will help you obtain the best performance from your new DVD-receiver.

For your records

Record the serial number, found on the back of the unit, in the spaces designated on the warranty card, and in the space provided below. Refer to the model and serial numbers whenever you call upon your Kenwood dealer for information or service on the product.

Model DDX395/DDX375BT/DDX350BT/DDX25BT/DDX418BT Serial number _____

US Residents Only

Register Online

Register your Kenwood product at www.kenwood.com/usa/

Important Notice

To ensure proper use, please read through this manual before using this product. It is especially important that you read and observe **WARNINGS** and **CAUTIONS** in this manual. Please keep the manual in a safe and accessible place for future reference.

⚠ WARNINGS

To prevent accidents and damages

- DO NOT install any unit or wire any cable in a location where;
 - it may obstruct the steering wheel and gearshift lever operations.
 - it may obstruct the operation of safety devices such as air bags.
 - it may obstruct visibility.
- DO NOT raise the volume level too much, as this will make driving dangerous by blocking outside sounds, and may cause hearing loss.
- DO NOT operate the unit while driving. If you need to operate the unit while driving, be sure to look around carefully.
- Stop the car before performing any complicated operations.
- The driver must not watch the monitor while driving.

⚠ CAUTIONS

To care for the unit

- If you have parked the car for a long time in hot or cold weather, wait until the temperature in the car becomes normal before operating the unit.

To care for the monitor

- The monitor built into this unit has been produced with high precision, but it may have some ineffective dots. This is inevitable and is not considered defective.
- Do not expose the monitor to direct sunlight.
- Do not operate the touch panel using a ball-point pen or similar tool with a sharp tip. Touch the keys on the touch panel with your finger directly (if you are wearing a glove, take it off).
- When the temperature is very cold or very hot...
 - Chemical changes occur inside, causing malfunction.
 - Pictures may not appear clearly or may move slowly. Pictures may not be synchronized with the sound or picture quality may decline in such environments.

On the volume setting

- Digital devices produce very little noise compared with other sources. Lower the volume before playing these digital sources to avoid damaging the speakers by sudden increase of the output level.

For DDX418BT:



The marking of products using lasers

The label is attached to the chassis/case and says that the component uses laser beams that have been classified as Class 1. It means that the unit is utilizing laser beams that are of a weaker class. There is no danger of hazardous radiation outside the unit.

For DDX395/DDX375BT/DDX350BT/DDX25BT:

⚠ CAUTION

Use of controls or adjustments or performance of procedures other than those specified herein may result in hazardous radiation exposure. In compliance with Federal Regulations, the following are reproductions of labels on, or inside the product relating to laser product safety.

JVC KENWOOD Corporation
2967-3, ISHIKAWA-MACHI, HACHIOJI-SHI, TOKYO, JAPAN

THIS PRODUCT COMPLIES WITH DHHS RULES 21CFR
SUBCHAPTER J IN EFFECT AT DATE OF MANUFACTURE.

Location : Top plate

Important Notice

For DDX395/DDX375BT/DDX350BT/DDX25BT:

CAUTION

This equipment complies with FCC/IC radiation exposure limits set forth for an uncontrolled environment and meets the FCC radio frequency (RF) Exposure Guidelines and RSS-102 of the IC radio frequency (RF) Exposure rules. This equipment has very low levels of RF energy that is deemed to comply without maximum permissive exposure evaluation (MPE). But it is desirable that it should be installed and operated keeping the radiator at least 20 cm or more away from person's body.

- Contains Transmitter Module
FCC ID: ZWY8811X
- Contains Transmitter Module
IC: 12033A-8811X

For DDX395/DDX375BT/DDX350BT/DDX25BT:

FCC WARNING

This equipment may generate or use radio frequency energy. Changes or modifications to this equipment may cause harmful interference unless the modifications are expressly approved in the instruction manual. The user could lose the authority to operate this equipment if an unauthorized change or modification is made.

FCC NOTE

This equipment has been tested and found to comply with the limits for a Class B digital device, pursuant to Part 15 of the FCC Rules. These limits are designed to provide reasonable protection against harmful interference in a residential installation.

This equipment may cause harmful interference to radio communications, if it is not installed and used in accordance with the instructions. However, there is no guarantee that interference will not occur in a particular installation. If this equipment does cause harmful interference to radio or television reception, which can be determined by turning the equipment off and on, the user is encouraged to try to correct the interference by one or more of the following measures:

- Reorient or relocate the receiving antenna.
- Increase the separation between the equipment and receiver.
- Connect the equipment into an outlet on a circuit different from that to which the receiver is connected.
- Consult the dealer or an experienced radio/TV technician for help.

This transmitter must not be co-located or operated in conjunction with any other antenna or transmitter.

For DDX395/DDX375BT/DDX350BT/DDX25BT:

IC (Industry Canada) Notice

This device complies with Industry Canada's licence-exempt RSSs. Operation is subject to the following two conditions:

- (1) This device may not cause interference; and
 - (2) This device must accept any interference, including interference that may cause undesired operation of the device.
-

About this manual

The displays and panels shown in this manual are examples used to provide clear explanations of the operations. For this reason, they may be different from the actual displays or panels.

Illustrations of **DDX395** are mainly used for explanation.

This manual mainly explains operations using the buttons on the monitor panel and keys on the touch panel. For operations using the remote controller, see page 48.

< > indicates the various screens/menus/operations/settings that appear on the touch panel.

[] indicates the keys on the touch panel.

Indication language: English indications are used for the purpose of explanation. You can select the indication language from the <Setup> menu. (Page 45)

Contents

Component Names and Operations	3	Using an external component via ADS adapter— OEM Features	33
Basic Operations	4	Bluetooth®	34
How to reset your unit	4	Information	34
Turning on the power	4	Preparation	34
Turning off the power	4	Connection	34
Putting the unit in standby	4	Bluetooth mobile phone	36
Turning off the screen	4	Bluetooth audio player	38
Adjusting the volume	5	KENWOOD Music Mix	38
Attenuating the sound	5	Bluetooth settings	39
Getting Started	5	Settings	40
Initial settings	5	Audio settings	40
Setting the security function	6	Display settings	43
Clock settings	6	Input settings	45
Various Screens and Operations	7	System settings	45
Home screen	7	Remote Controller	48
Source control screen	8	Preparation	49
List/setting screen	9	Basic operations for RC-DV340 (supplied)	49
Disc	10	Basic operations for KNA-RCDV331 (optionally purchased)	51
Video	11	KENWOOD Remote APP	53
USB	13	Installation and Connection	53
Android	15	Before installation	53
iPod/iPhone	16	Installing the unit	55
Radio	17	Removing the unit	55
SiriusXM® Satellite Radio	19	Wiring connection	56
Pandora®	26	Connecting external components	57
iHeartRadio	28	References	57
Spotify	30	Maintenance	57
Other External Components	32	More information	57
AV-IN	32	Troubleshooting	61
Rear view camera	32	Specifications	64
		Trademarks and licenses	67

Component Names and Operations

DDX395/DDX375BT

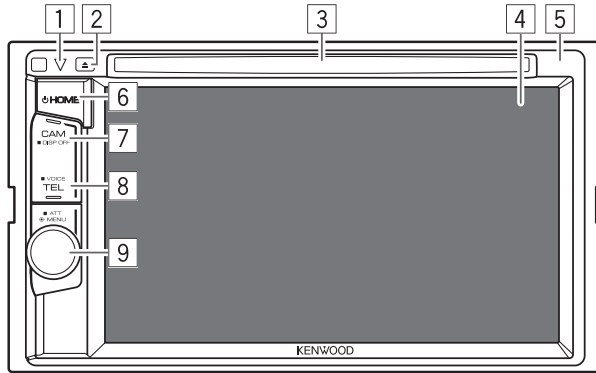

- 1 Reset button/Power indicator/Security indicator
 - Resets the unit.
 - Lights up while the unit is turned on.
 - Flashes when the security function is activated.
- 2 ▲ button
- 3 Loading slot
- 4 Screen (touch panel)
- 5 Monitor panel
- 6 **HOME** button
 - **HOME** (Press): Turns on the power.
 - **HOME** (Hold): Turns off the power.
 - **HOME** (Press): Displays the Home screen while the power is on.

- 7 **CAM/DISP OFF** button
 - **CAM** (Press): Displays the picture from the connected rear view camera.
 - **DISP OFF** (Hold): Turns off the screen.
- 8 **TEL/VOICE** button
 - **TEL** (Press): Displays the phone control screen.
 - **VOICE** (Hold): Activates voice dialing.
- 9 **Volume/MENU/ATT** knob
 - **Volume** (Turn): Adjusts the audio volume.
 - **MENU** (Press): Pops up the short-cut menu.
 - **ATT** (Hold) Attenuates the sound.

DDX350BT/DDX25BT/DDX418BT

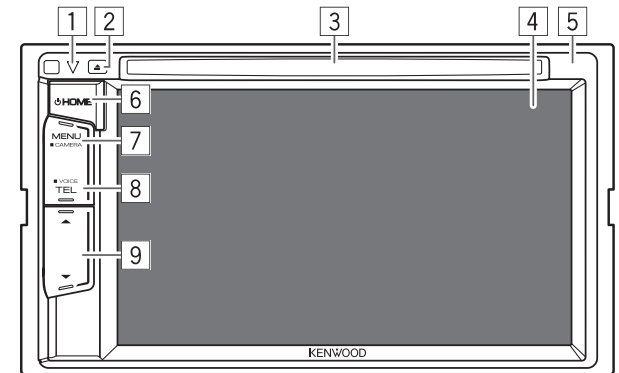

- 1 Reset button/Power indicator/Security indicator
 - Resets the unit.
 - Lights up while the unit is turned on.
 - Flashes when the security function is activated.
- 2 ▲ button
- 3 Loading slot
- 4 Screen (touch panel)
- 5 Monitor panel
- 6 **HOME** button
 - **HOME** (Press): Turns on the power.
 - **HOME** (Hold): Turns off the power.
 - **HOME** (Press): Displays the Home screen while the power is on.
- 7 **MENU/CAMERA** button
 - **MENU** (Press): Pops up the short-cut menu.
 - **CAMERA** (Hold): Displays the picture from the connected rear view camera.
- 8 **TEL/VOICE** button
 - **TEL** (Press): Displays the phone control screen.
 - **VOICE** (Hold): Activates voice dialing.
- 9 Volume ▲/▼ buttons

Basic Operations

How to reset your unit

If the unit fails to operate properly, press the reset button.



Turning on the power



Turning off the power



Putting the unit in standby

1 Display the source/option selection screen.

On the Home screen, touch as follows:



2 Put the unit in standby.

On the source/option selection screen, touch as follows:



Turning off the screen

■ On the pop-up short-cut menu

1 Display the pop-up short-cut menu.

DDX395/DDX375BT DDX350BT/DDX25BT/
DDX418BT



2 On the pop-up short-cut menu, touch as follows:

[Display OFF]



To turn on the screen: Touch the screen.

■ On the monitor panel

(Only for DDX395/DDX375BT)

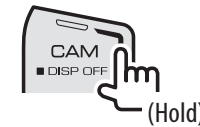

To turn on the screen: Press and hold **DISP OFF** on the monitor panel or touch the screen.

Basic Operations

Adjusting the volume

DDX395/DDX375BT

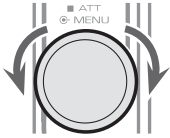

You can adjust the volume (00 to 35) by turning the knob to the right to increase and to the left to decrease.

DDX350BT/DDX25BT/DDX418BT

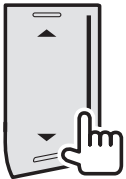

You can adjust the volume (00 to 35) by pressing ▲ to increase and pressing ▼ to decrease.

- Holding ▲ increases the volume continuously to level 15.

Attenuating the sound

(Only for DDX395/DDX375BT)

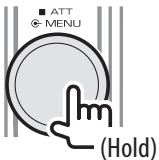

The ATT indicator lights up.

To cancel attenuation: Press the same button again.

Getting Started

Initial settings

When you power on the unit for the first time or reset the unit, the <Initial Setup> screen appears.

Perform the initial settings.

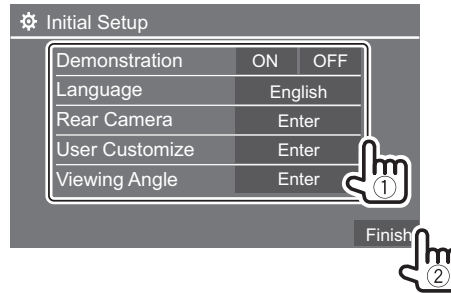

E.g. Initial settings screen for DDX395

Once completed, Home screen appears.

<Demonstration>

- **ON** (Initial): Activates the display demonstration.
- **OFF**: Deactivates the display demonstration.

<Language>

Select the text language used for on-screen information.

- **English** (Initial)/**Español**/**Français**/**Deutsch**/**Italiano**/**Nederlands**/**Ελληνικά**/**Português**/**Türkçe**/**Čeština**/**Polski**/**Magyar**/**Русский**/**עברית**/**فارسی**/**العربية**/**ភាសាខ្មែរ**/**简体中文**/**繁體中文**/**Bahasa Malaysia**/**Bahasa Indonesia**/**한국어**
 - For external monitors, only English/Spanish/French/German/Italian/Dutch/Russian/Portuguese are available. If another language has been selected, the text language for external monitors will be set to English.

- **GUI Language (Local** (the language selected above)/**English** (Initial)): Selects the language used for displaying operation keys and menu items.

“Please Power Off” appears when the setting is changed. Turn off the power, then turn on to enable the change.

<Rear Camera> (Page 45)

Make the settings to display the picture from the connected rear view camera.

<User Customize> (Page 43)

Change the display design.

<Viewing Angle>

Select the viewing angle in relation to the monitor panel to make the panel easier to see.

- **Under 0°** (Initial)/**5°**/**10°**/**15°**/**20°**

Getting Started

Setting the security function

■ Registering a security code

(Only for DDX418BT)

1 Display the Home screen.



2 Display the <Security Code Set> screen.

On the Home screen, touch as follows:



Then, on the <Setup> screen, touch as follows:

[System] → <Security Code> : [Set]

3 Enter a four-digit number (①), then confirm the entry (②).

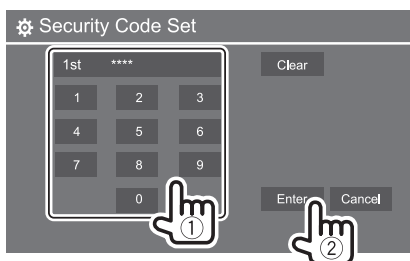

- To delete the last entry, touch [Clear].
- To cancel the setting, touch [Cancel].

4 Repeat step 3 to confirm your security code.

Now, your security code is registered.

To clear the registered security code: touch [CLR] for <Security Code> in step 2.

Then, enter the current security code to clear and touch [Enter].

- When the unit has been reset or disconnected from the battery, you are required to enter the security code. Enter the correct security code, then touch [Enter].

■ Activating the security function

You can activate the security function to protect your receiver system against theft.

1 Display the <Setup> setting screen.

On the Home screen, touch as follows:



2 Activate the security function.

On the <Setup> setting screen, touch as follows: [System] → <SI>: [ON]

The security function is activated.

The security indicator on the monitor panel flashes when the vehicle ignition is off.

To deactivate the security function: Touch [OFF] in step 2.

Clock settings

1 Display the Home screen.



2 Display the <Clock> screen.

On the Home screen, touch as follows:



Then, on the <Setup> screen, touch as follows:

[System] → <Clock> : [Enter]

- You can also display the <Clock> screen by touching the clock area on the Home screen.

3 Set the clock time.

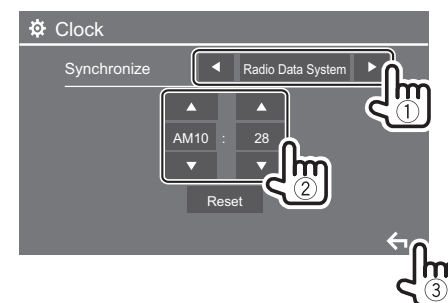

E.g. Clock settings screen for DDX395

<Synchronize>

- **Radio Data System:** Synchronizes the clock time with FM RBDS.
- **OFF:** Sets the clock manually. Touch [▲]/[▼] to adjust the hour, then minute.
 - Touching [Reset] will set the minute to "00".

Various Screens and Operations

You can display or change to other screens at any time to show information, change the AV source, change the settings, etc.

Home screen

When you turn on the power for the first time, the Home screen appears.

- You can customize the Home screen. (Page 44)
- To display the Home screen from other screens, press **HOME**.

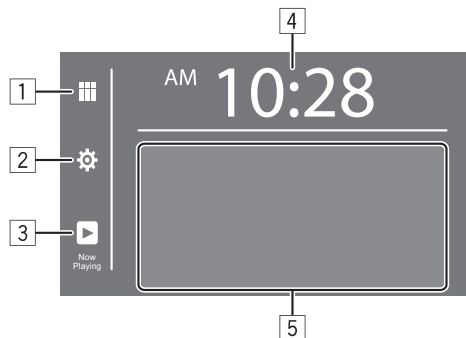

Touching the operation keys performs the following actions:

- 1 Displays all playback sources and options.
- 2 Displays the **<Setup>** screen.
- 3 Displays the current playing source control screen.
- 4 Displays the **<Clock>** screen.
- 5 Selects or changes the playback source.

Available playback sources and options

Touch **1** to display the source/option selection screen.

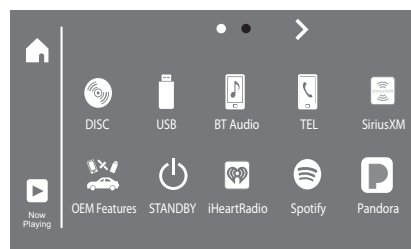

E.g. Source/option selection screen for DDX395

Touching the operation keys performs the following actions:

[DISC]	Plays a disc.
[USB]	Plays files on a USB device.
[BT Audio]	Plays a Bluetooth audio player.
[TEL]	Displays the phone control screen.
[AV-IN]*1	Switches to an external component connected to the AV-IN input terminal.
[SiriusXM]*2	Switches to the SiriusXM® radio broadcast.
[OEM Features]*3	Switches to the source connected via ADS adapter.
[STANDBY]	Puts the unit in standby.
[iHeartRadio]*4	Switches to the iHeartRadio broadcast.
[Spotify]	Switches to the Spotify application.
[Pandora]*4	Switches to the Pandora broadcast.

[Android™] Plays an Android device.

[iPod] Plays an iPod/iPhone.

[Radio] Switches to the radio broadcast.

To change the page: Touch **[>]/[<]**. Current page is shown by the page indication on the top of the screen.

To return to the Home screen: Touch **[HOME]** on the source/option selection screen.

*1 Only for DDX418BT.

*2 Only for DDX395/DDX375BT/DDX25BT.

*3 Only for DDX395/DDX375BT.

*4 Only for DDX395/DDX375BT/DDX350BT/DDX25BT.

Various Screens and Operations

Source control screen

You can perform the playback operation from the source control screen during playback.

- The operation keys and information displayed vary depending on the selected source/disc type/file type being played.
- If the operation keys are not displayed on the screen, touch the screen to show them.

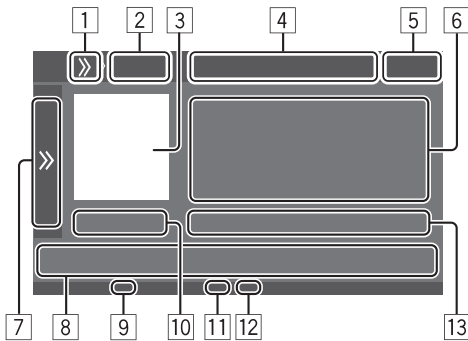

E.g. Common audio playback source screen for DDX395

- 1 Displays/hides short-cut source selection keys.
- 2 Playback source or media type
- 3 Picture/artwork (shown if the file contains the information)
- 4 Short-cut source selection keys
 - Touching [>>] on 1 to display the keys, or [≪≪] to hide them.
- 5 Clock display
- 6 Track/file/song/video information
 - Touching [←] scrolls the text if not all of the text is shown.

- 7 Displays/hides other available operation keys*
- 8 Operation keys*
- 9 IN indicator (lights up while a disc is inserted)
- 10 Playing time/playback status
- 11 Playback mode indicator (Repeat/Random)
- 12 File type indicator
- 13 Current playback item information (folder no./file no./track no./total track no./playback file type)

* See the following “Common operation keys on source control screen”.

Common operation keys on source control screen

- The appearance of the operation keys may differ, however the similar operation keys have the same operations.
- Available operation keys differ depends on the selected source or connected device.

Touching the operation keys performs the following actions:

- 7
 - [>>] Displays other available operation keys besides those shown on 8.
 - To hide the window, touch [≪≪].
 - [≡][+]
 - [↻]
 - [■]
 - [MODE]

- 8
 - [≡] Displays the <Equalizer> screen.
 - [Q] Displays the folder list/track list/audio menu/video menu.
 - [≪≪]/[≻≻]
 - (Touch) Selects an item (chapter/folder/track/audio file/video file).
 - (Hold) Reverses/forwards search.
 - (Hold) Plays in slow-motion while paused for video playback.
 - [▶||] Starts/pauses playback.
 - [X] Selects random playback mode.*

* About playback mode:

- Available playback mode differs depending on the source, disc type, connected device, etc.
- You cannot activate repeat playback mode and random playback mode at the same time.
- To cancel the playback mode, touch repeatedly until the indicator disappears.

Various Screens and Operations

■ Using the pop-up short-cut menu

While displaying the source control screen, you can jump to another screen by touching the operation keys on the pop-up short-cut menu.

1 Display the pop-up short-cut menu.

DDX395/DDX375BT



DDX350BT/DDX25BT/
DDX418BT



2 Select an item to jump to by touching as follows.

[TEL]	Displays the phone control screen.
[Screen Adjustment]	Displays the picture adjustment screen.
[Display OFF]	Turns off the screen.
[Camera]	Displays the picture from the connected rear view camera.
[SETUP]	Displays the <Setup> screen.
[Current Source]	Displays the current source control screen.

To close the pop-up menu: Touch the screen anywhere other than the pop-up short-cut menu.

■ Using touch screen operation during playback

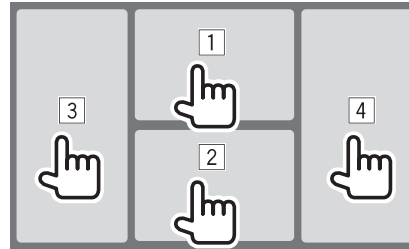

Touching the areas performs the following actions:

- 1 Displays the video control menu while playing a video.
- 2 While playing a video: Displays the source control screen.
While playing an audio file: Displays the playback operation keys.
- 3 Goes to the previous chapter/track.*
- 4 Goes to the next chapter/track.*

* Not available for video from an external component (AV-IN) (for DDX418BT only).

List/setting screen

Below are the common operation keys which appear on the list/setting screen.

- The appearance of the operation keys may differ, however the similar operation keys have the same operations.
- Available operation keys differ depends on the setting screens. Not all these operation keys are shown on every screen.

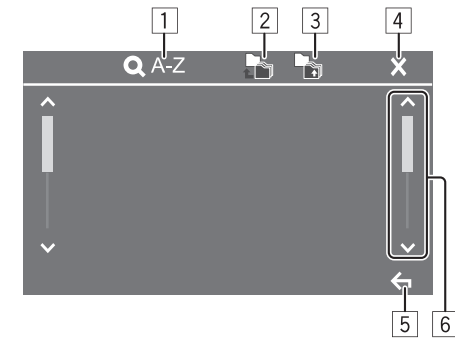

Touching the operation keys performs the following actions:

- 1 Enters alphabet search* to list the items in alphabetical order. When a keypad appears, touch the first letter you want to search for.
- 2 Returns to the root folder.
- 3 Returns to the upper layer.
- 4 Closes the current screen.
- 5 Exits from the current screen or returns to the previous screen.
- 6 Changes the page to display more items.

* Alphabet search is not available when the playlist is selected.

Disc

- If a disc does not have a disc menu, all tracks on it will be played repeatedly until you change the source or eject the disc.
- For playable disc types, file types and other information, see pages 57 and 58.
- If “⊘” appears on the screen, the unit cannot accept the operation you have tried to do.
 - In some cases, without showing “⊘”, operations will not be accepted.
- When playing back a multi-channel encoded disc, the multi-channel signals are downmixed.

Inserting a disc

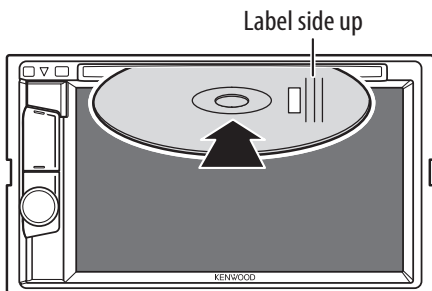

E.g. Inserting a disc for DDX395

- The source changes to “DISC” and playback starts.
- The IN indicator lights up while a disc is inserted.

Ejecting a disc



- When removing a disc, pull it out horizontally.
- You can eject a disc while playing another AV source.
- If the ejected disc is not removed within 15 seconds, the disc is automatically inserted again into the loading slot to protect it from dust.

Playback operations

Audio playback information and key operation

- For playback information, see “Source control screen” on page 8.
- For key operations on the touch panel, see “Common operation keys on source control screen” on page 8.

Selecting a folder/track on the list

1 Display the folder/track list.

On the source control screen, touch as follows:



2 Select the folder (①), then the item (②) in the selected folder.

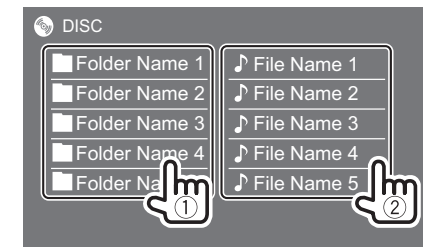

Select an item in each layer until you reach and select the desired file.

Settings for disc playback

- Available items shown on the <DISC Mode> screen differ depending on the type of disc/file being played back.

1 Display the <DISC Mode> screen.

On the source control screen, touch as follows:



Disc

2 Make the settings.

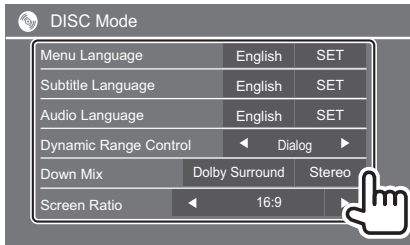

<Menu language>*1

Select the initial disc menu language. (Initial: **English**)

<Subtitle language>*1

Select the initial subtitle language or turn subtitles off (**Off**). (Initial: **English**)

<Audio language>*1

Select the initial audio language. (Initial: **English**)

<Dynamic Range Control>

You can change the dynamic range while playing Dolby Audio encoded discs.

- **Wide**: Reproduces powerful sound at a low volume level with its full dynamic range.
- **Normal**: Reduces the dynamic range a little.
- **Dialog** (Initial): Reproduces movie dialog more clearly.

<Down Mix>

When playing back a multi-channel disc, this setting affects the signals reproduced through the front and/or rear speakers.

- **Dolby Surround**: Reproduces multi-channel surround sound by connecting an amplifier compatible with Dolby Surround.
- **Stereo** (Initial): Reproduces stereo playback sound.

<Screen Ratio>

Select the monitor type to watch a wide screen picture on the external monitor.

16:9 (Initial) 4:3 LB 4:3 PS



<File Type>*2

Select the playback file type when a disc contains different types of files.

- **Audio**: Plays back audio files.
- **Still image**: Plays back still picture files.
- **Video**: Plays back video files.
- **Audio&Video** (Initial): Plays back audio files and video files.

*1 For list of language codes, see page 59.

*2 For playable file types, see page 57.

If the disc contains no files of the selected type, the existing files are played in the following priority: audio, video, then still picture. You can change these settings only while playback is stopped.

Video

Playback operations

■ Video playback information on the source control screen

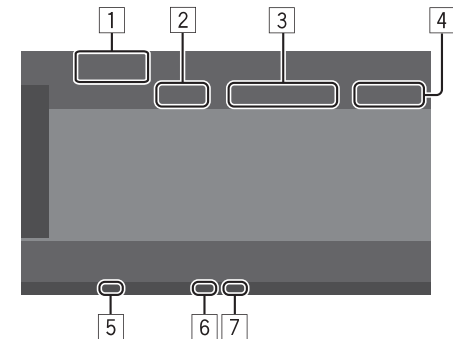

E.g. Video playback source control screen for DDX395

- 1 Media type
- 2 Playback status
- 3 Current playback item information (title no./chapter no./folder no./file no./track no.)
- 4 Playing time
- 5 IN indicator (lights up while a disc is inserted)
- 6 Playback mode indicator (Repeat/Random)
- 7 File type indicator

Video

Video menu control operations

You can display the video menu control during video playback.

- Available operation keys differ depend on the selected disc type and file type.

Video playback except VCD

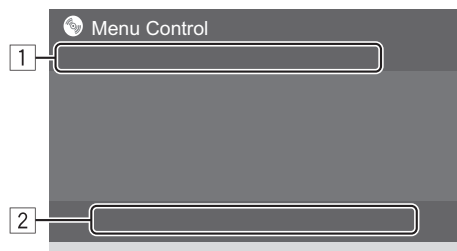

E.g. Video menu control screen for DDX395

Touching the operation keys performs the following actions:

1

- [ZOOM]*1** Displays the picture size selection screen.
- ① Touch [**+** Zoom] to change the magnification level of the picture (**Zoom1, Zoom2, Zoom3, Full:** Initial).
 - ② Touch [**▲**] [**▼**] [**◀**] [**▶**] to move the zooming frame.

- [Aspect]** Displays the aspect ratio selection screen.
Touch [**■** Aspect] to select the aspect ratio.

<Full>*2: For 16:9 original pictures

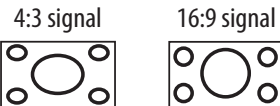

<Just>: For viewing 4:3 pictures naturally on the wide screen

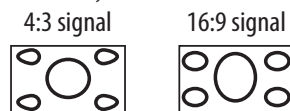

<Normal>*2: For 4:3 original pictures

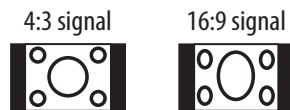

<Auto>: For "DISC" source and "USB" source only. The aspect ratio is automatically selected to match the incoming signals.

- [Picture Adjust]** Displays the picture adjustment screen.
- ① Touch [**DIM ON**] or [**DIM OFF**] to turn on or off the dimmer.
 - ② Touch [**+**]/[**-**] to adjust the other items.
 - **<Bright>**: Adjusts the brightness (-15 to +15).
 - **<Contrast>**: Adjusts the contrast (-10 to +10).
 - **<Black>**: Adjusts the blackness (-10 to +10).
 - **<Color>**: Adjusts the color (-10 to +10).
 - **<Tint>**: Adjusts the tint (-10 to +10).
 - **<Sharpness>**: Adjusts the sharpness (-2 to +2).

[Audio] Selects the audio type.

[Subtitle] Selects the subtitle type.

[Angle] Selects the view angle.

*1 When [Aspect] is set to <Just> or <Auto>, the picture is zoomed with the aspect ratio of the <Full> setting. This feature may not be used for some video sources.

*2 While DivX is played back with <Screen Ratio> set to [16:9] (Page 11 for discs/Page 14 for USB), the aspect ratio may not be set correctly.

Video

2

[MENU]	Displays the disc menu (DVD).
[T MENU]	Displays the disc menu (DVD).
[Highlight]	Switches to the direct disc menu mode. Touch the target item to select.
[CUR]	Displays the menu/scene selection screen. <ul style="list-style-type: none">• [▲] [▼] [◀] [▶]: Selects an item.• [Enter]: Confirms the selection.• [Return]: Returns to the previous screen.

Video playback for VCD

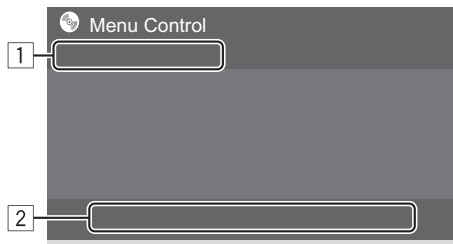

E.g. Video menu control screen for DDX395

Touching the operation keys performs the following actions:

1

[ZOOM]	
[Aspect]	Refer to “Video playback except VCD” on page 12.
[Picture Adjust]	

2

[MENU]	Displays the disc menu.
[Audio]	Selects the audio channel (ST : stereo, L : left, R : right).
[Direct]*	Displays or hides the direct selection buttons. <ol style="list-style-type: none">① Touch [DIR/CLR] to select a track directly on a VCD.② Touch the numbers ([0], [1] to [9]) to select the desired track.③ Touch [Enter] to confirm. To delete the last entry, touch [DIR/CLR] .
[Return]	Displays the previous screen or menu.

* You need to stop playback to deactivate the PBC function when playing a VCD with PBC activated.

USB

You can connect a USB mass storage class device such as a USB memory, digital audio player, etc. to the unit.

- For playable file types and other information, see pages 57 and 60.
- You cannot connect a PC or portable HDD to the USB input terminal.
- You cannot connect a USB device via a USB hub.

Connecting a USB device

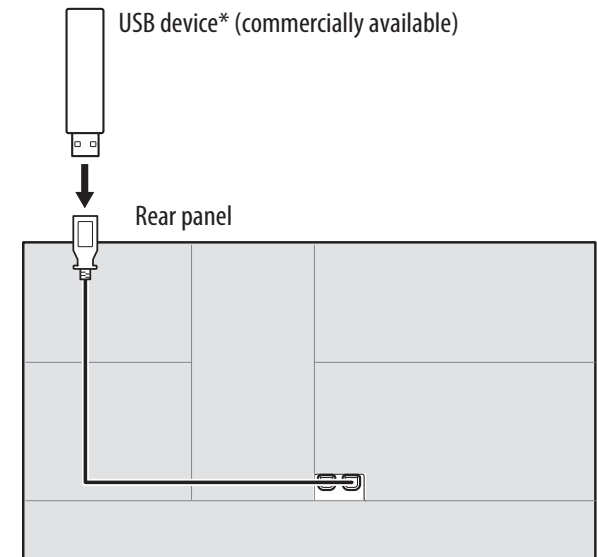

The source changes to “USB” and playback starts.

- All tracks in the USB device will be played repeatedly until you change the source or disconnect the USB device.

* Use CA-U1EX for extending the cable if necessary. (Max 500 mA, 5V)

USB

Playback operations

■ Playback information and key operation

- For playback information, see “Source control screen” on page 8.
- For key operations on the touch panel, see “Common operation keys on source control screen” on page 8.

■ Selecting the file type to play

You can specify the file type to play.

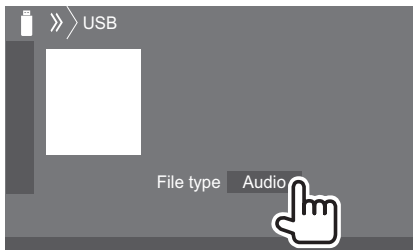

E.g. USB source control screen for DDX395

Select the file type as follows:

[Audio]	Plays back audio files.
[Video]	Plays back video files.
[Photo]	Plays back still picture files.

If the USB contains no files of the selected type, the existing files are played in the following priority: audio, video, then still picture. You can change these settings only while playback is stopped.

■ Selecting a folder/track on the list

1 Display the folder/track list.

On the source control screen, touch as follows:



2 Select the folder (①), then the item (②) in the selected folder.



Select an item in each layer until you reach and select the desired file.

Settings for USB playback

1 Display the <USB Mode> screen.

On the source control screen, touch as follows:



2 Make the settings.

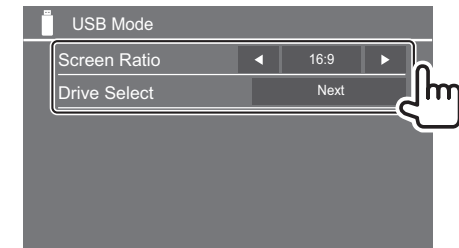

<Screen Ratio>

Select the monitor type to watch a wide screen picture on the external monitor.

16:9 (Initial) **4:3 LB** **4:3 PS**



<Drive Select>

- **Next:** Switch between internal memory and the memory source of the connected device (such as a mobile phone).

Android

This unit supports the Android™ application, KENWOOD Music Play. When you use KENWOOD Music Play via this unit, you can search for audio files by genre, artist, album, playlist and song.

- For more information about KENWOOD Music Play, visit <www.kenwood.com/cs/ce/>.

Preparation

■ Installing KENWOOD Music Play

Install the Android™ application, KENWOOD Music Play, on your Android device beforehand.

- When a compatible Android device is connected, “Press [VIEW] to install KENWOOD MUSIC PLAY APP” is shown on the Android device. Follow the instructions to install the application.
- You can also install the latest version of KENWOOD Music Play on your Android device before connecting.

■ Connecting an Android device

This unit supports Android OS 4.1 and above.

- Some Android devices (with OS 4.1 and above) may not fully support Android Open Accessory (AOA) 2.0.
- If the Android device supports both mass storage class device and AOA 2.0, this unit always plays back via AOA 2.0 as priority.

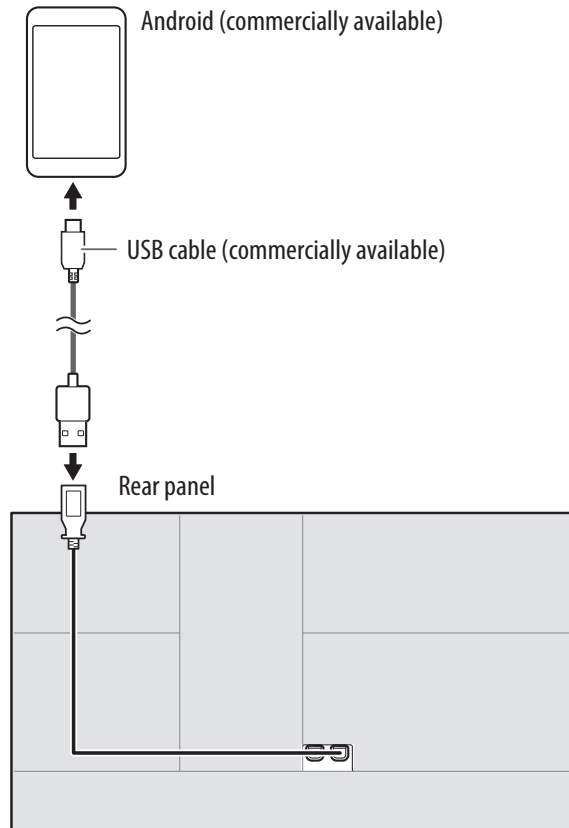

Start playback

- 1 Turn on KENWOOD Music Play on your Android device.
- 2 Select “Android” as the source.

Playback operations

■ Playback information and key operation

- For playback information, see “Source control screen” on page 8.
- For key operations on the touch panel, see “Common operation keys on source control screen” on page 8.

■ Selecting a track from the menu

1 Display the audio menu.

On the source control screen, touch as follows:



2 Select a category (①), then select a desired item (②).

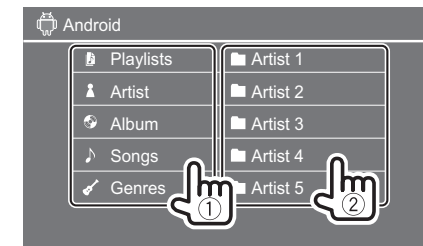

Select an item in each layer until you reach and select the desired file.

Android

Settings for Android playback

1 Display the <Android MODE> screen.

On the source control screen, touch as follows:



2 Make the settings.

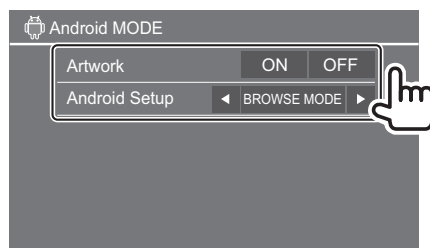

<Artwork>

- **ON** (Initial): Shows the artworks of the playing files.
- **OFF**: Hides the artworks of the playing files.

<Android Setup>

- **BROWSE MODE** (Initial): Controls from the unit (using the KENWOOD Music Play application).
- **HAND MODE**: Controls other media player applications from the Android device (without using the KENWOOD Music Play application).
 - You can play/pause or skip files from the unit.

iPod/iPhone

Connecting an iPod/iPhone

- For playable iPod/iPhone types and other information, see page 60.
- You cannot watch video.

Wired connection

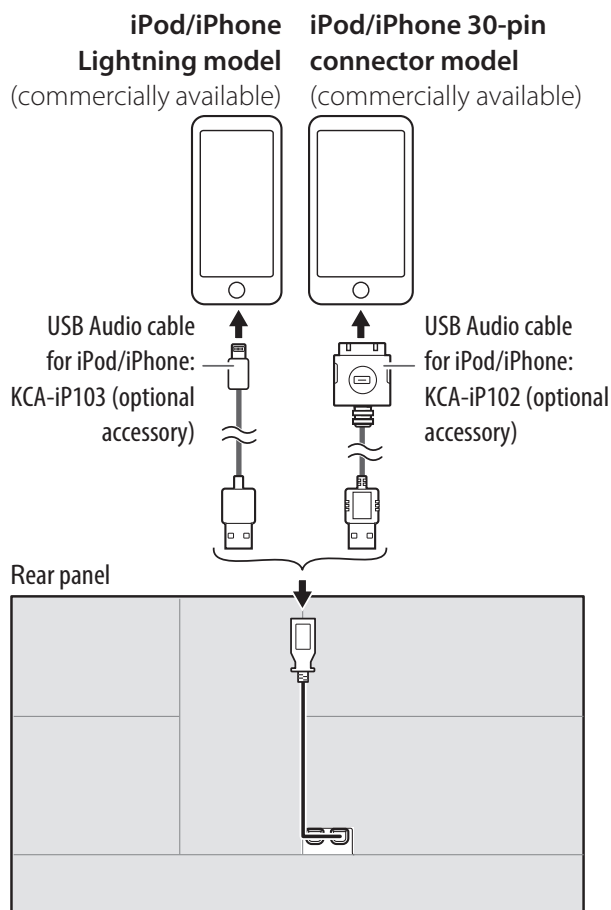

Bluetooth connection

Pair the iPod/iPhone with this unit via Bluetooth. (Page 34)

Selecting the playback device via the connection method

See <Smartphone Setup> on page 46 for more information.

Playback operations

■ Playback information and key operation

- For playback information, see “Source control screen” on page 8.
- For key operations on the touch panel, see “Common operation keys on source control screen” on page 8.

Additional keys operations. Touching the operation keys performs the following actions:

[🔊/🔇] Switches the device on <Smartphone Setup> screen. (Page 46)

■ Selecting an audio file from the menu

1 Display the audio menu.

On the source control screen, touch as follows:



iPod/iPhone

- 2 Select a category (①), then select a desired item (②).



Select an item in each layer until you reach and select the desired file.

- Available categories differ depending on the type of iPod/iPhone.

Settings for iPod/iPhone playback

- 1 Display the <iPod Mode> screen.

On the source control screen, touch as follows:



- 2 Make the settings.

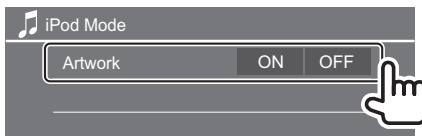

<Artwork>

- **ON** (Initial): Shows the artworks of the playing files.
- **OFF**: Hides the artworks of the playing files.

Radio

Listening to the radio

Playback information on the source control screen

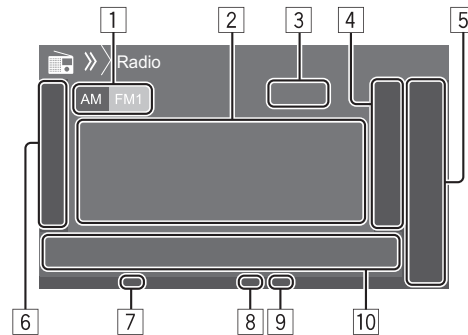

- 1 Selects the band (AM/FM1/FM2/FM3)
- 2 Text information
 - Touching [**<**] scrolls the text if not all of the text is shown.
 - Touching [**Radio Text**] switches the information between Radio Text, Radio Text Plus and PTY code.
- 3 Current station frequency
- 4 Displays the preset stations window (Page 18)
- 5 [**P1**] – [**P5**]
 - (Touch) Selects a preset station.
 - (Hold) Presets the current station.
- 6 Displays/hides other available operation keys*
- 7 TI indicator
- 8 ST/MONO indicator
- 9 Seek mode indicator
- 10 Operation keys*

* See the following “Operation keys on source control screen”.

Operation keys on source control screen

- The appearance of the operation keys may differ, however the similar operation keys have the same operations.
- See also “Common operation keys on source control screen” on page 8.

Touching the operation keys performs the following actions:

- 6
 - [**AME** ↓]* (Hold) Presets stations automatically.
 - [**MONO**]* Activates monaural mode for better FM reception (stereo effect will be lost).
 - The MONO indicator lights up while monaural mode is activated.
 - To deactivate, touch [**MONO**] again.
 - [**TI**]* (For FM RBDS features) Activates TI standby reception mode.
 - When TI is activated, the unit is ready to switch to traffic information if available. The TI indicator lights up in white.
 - If the TI indicator lights up in orange, tune into another station providing Radio Broadcast Data System signals.
 - The volume adjustment for Traffic Information is automatically memorized. The next time the unit switches to Traffic Information, the volume is set to the memorized level.
 - To deactivate, touch [**TI**] again.

Radio

10

[PTY]* (For FM RBDS features)
Enters PTY search mode.
① Touch **[PTY]**.
② Touch and hold a PTY code to search for.

If there is a station broadcasting a program of the same PTY code as you have selected, that station is tuned in.

[SEEK] Changes the seek mode for **[◀◀]/[▶▶]**.
• **AUTO1** (Initial): Auto search
• **AUTO2**: Tunes in preset stations one after another
• **MANU**: Manual search

[◀◀]/[▶▶] Searches for a station.
• The search method differs according to the selected seek mode (see above).

* Appears only when FM is selected as the source.

Presetting stations in the memory

You can preset five stations for each band.

Automatic presetting — AME (Auto Memory) (for FM only)

On the source control screen, touch as follows:



The local stations with the strongest signals are found and stored automatically.

Manual presetting

1 Tune in to a station you want to preset.



2 Select a preset number to store into.

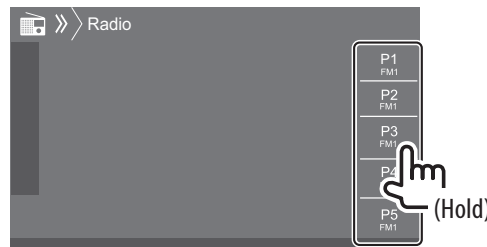

E.g. Radio source control screen for DDX395

The station selected in step 1 is stored into the preset number **[P1]** to **[P5]** you have selected.

Selecting a preset station

1 Select the band, then display the preset station window.

On the source control screen, touch as follows:



2 Select a preset station.

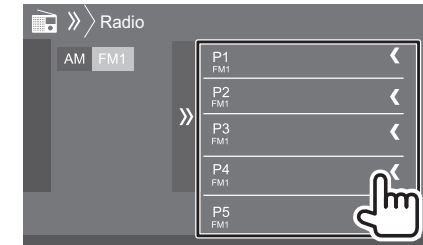

E.g. Preset station window for DDX395

To hide the window: Touch **[>>]**.

SiriusXM® Satellite Radio (Only for DDX395/DDX375BT/DDX25BT)

Only SiriusXM® brings you more of what you love to listen to, all in one place. Get over 140 channels, including commercial-free music plus the best sports, news, talk, comedy and entertainment. Welcome to the world of satellite radio. A SiriusXM Connect Vehicle Tuner and subscription are required. For more information, visit <www.siriusxm.com>.

Preparation

■ Connecting the SiriusXM Connect Vehicle Tuner

Perform this installation when you install the unit for the first time.

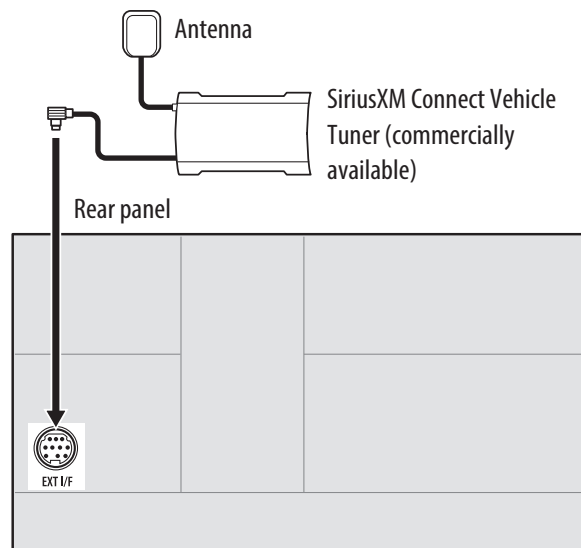

■ Activating subscription

1 Check your Radio ID.

The SiriusXM Satellite Radio ID is required for activation and can be found by tuning to Channel 0 as well as on the label found on the SiriusXM Connect Vehicle Tuner and its packaging.

- The Radio ID does not include the letters I, O, S or F.

2 Activate the subscription.

For users in the U.S.A:

- Online: Visit <www.siriusxm.com/activatenow>
- Phone: Call SiriusXM Listener Care at 1-866-635-2349

For users in Canada:

- Online: Visit <www.siriusxm.ca/activatexm>
- Phone: Call XM Customer Care at 1-877-438-9677

3 Confirm the activation.

A confirmation message appears. Touch **[Return]**.

■ Listening to the SiriusXM® Satellite Radio

■ Playback information on the source control screen

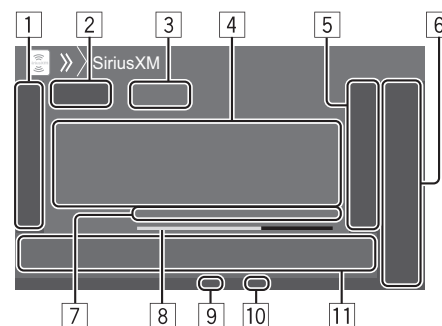

- 1 Displays/hides other available operation keys*
- 2 Selects the band (SXM1/SXM2/SXM3/SXM4)
- 3 Channel number
- 4 Text information
 - Touching **[<]** scrolls the text if not all of the text is shown.
 - Touching **[Song Title]/[Info]/[Category]** switches the information.
- 5 Displays the preset channel window
 - To hide the window, touch **[>>]**.
- 6 **[P1] – [P5]**
 - (Touch) Selects a preset channel.
 - (Hold) Presets the current channel.
- 7 Playback status and time code for the buffered data and replay mode
 - The time code shows you the point in the Replay buffer you are listening to. (E.g. “-5:00” means that you are listening to audio that is 5 minutes behind the current broadcast.)
- 8 Replay time bar for replay mode
 - Black: The remaining capacity
 - Blue: The amount of buffered contents
- 9 Signal strength indicator
- 10 Seek mode indicator
- 11 Operation keys*

* See “Operation keys on source control screen” on page 20.

SiriusXM® Satellite Radio

Operation keys on source control screen

- See also “Common operation keys on source control screen” on page 8.

Touching the operation keys performs the following actions:

[1]	
[MODE]	Displays the <SiriusXM Mode> screen.
[⊕+]	(Hold) Registers the current artist to the alert contents.
[♪+]	(Hold) Registers the current song to the alert contents.
[☀]	Activates or deactivates the content alert for traffic and weather.
[SEEK]	Changes the seek mode for [CH▲]/[CH▼] . <ul style="list-style-type: none"> • SEEK1 (Initial): Skips to another available channel. • SEEK2: Skips to another preset channel.
[SCAN]	Starts TuneScan™.
[◀◀]/[▶▶]/[Live]	Performs playback operations during content replay.
[•••]	Changes the page in the window to display other operation keys.

[11]

[Q]	Displays the <Channel List> screen.
[▶II]	Starts/pauses the content replay.
[CH▲]/[CH▼]	Selects the channel. <ul style="list-style-type: none"> • To select a channel, make sure “SEEK1” is selected as the seek mode. • To select a preset channel, make sure “SEEK2” is selected as the seek mode.

Selecting a channel on the list

You can obtain information on channels or select a channel to listen to.

1 Display the <Channel List> screen.

On the source control screen, touch as follows:



2 Select a category (①), and then select a channel (②).

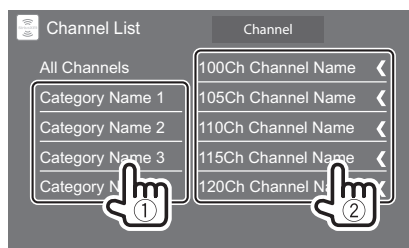

- To list all the channels, touch **[All Channels]**.
- Touch the info change key above the list (**[Channel]/[Artist]/[Song Title]/[Info]**) to display other information in the following order: Channel, Artist, Song Title, Content Info.

Presetting channels in the memory

You can preset five channels for each band.

1 Tune in to a channel you want to preset.

[CH▲]/[CH▼]



2 Select a preset number to store into.



The channel selected in step 1 is stored into the preset number **[P1]** to **[P5]** you have selected.

SiriusXM® Satellite Radio

Selecting a preset channel

1 Select the band, then display the preset channel window.

On the source control screen, touch as follows:



2 Select a preset channel.

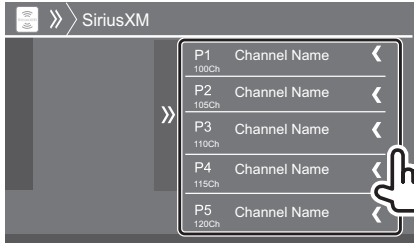

- You can also select a preset channel by touching [P1]–[P5].

To hide the window: Touch [>>>].

3 Select “SEEK2” as the seek mode to jump to the selected preset channel.

Replaying content

You can pause, rewind and replay the contents from the currently tuned channel.

- The SiriusXM Connect Vehicle Tuner continually buffers up to 60 minutes of audio.
- If you change to another channel during playback, the buffered contents will be lost.
- The time code is updated every second.

1 Display the operation keys for replay.

On the source control screen, touch as follows:



2 Perform the replay operations.

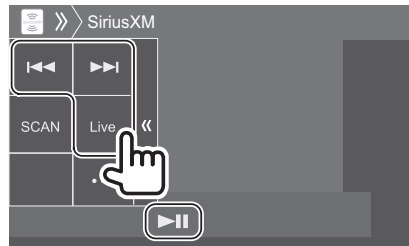

Starts/pauses playback.



Skips the current track/segment.

- Touching [⏮] within 2 seconds of the beginning of the current track/segment returns to the previous track.
- Touching [⏮] after 2 seconds or more of the current track returns to the beginning of the track.

(Hold) Reverses/forwards search.



Returns to the live position.

SiriusXM Satellite Radio features

SmartFavorites

User stored channels (P1 to P5) of the current band are recognized as SmartFavorites channels. SiriusXM Connect Vehicle Tuner automatically buffers their broadcast content in the background. When you select a SmartFavorite channel, you can rewind and replay up to 30 minutes of any of the missed news, talk, sports or music content.

- SmartFavorites is available only when you connect an SXV200 or later SiriusXM Connect Vehicle Tuner.
- If you change to another band, the buffered content is cleared and new channels in the current band will start buffering.

SiriusXM® Satellite Radio

TuneStart™

When you select a SmartFavorites channel, you can listen to the current song from the beginning.

1 Display the <SiriusXM Mode> screen.

On the source control screen, touch as follows:



2 Activate TuneStart™.

On <SiriusXM Mode> screen, touch as follows:
<TuneStart> : [ON]

To deactivate TuneStart: Touch [OFF] in step 2.

TuneScan™

You can get a short preview of the songs you have missed on each of your SmartFavorites music channels and the currently tuned music channel.

Activate TuneScan™ to start scanning the first 6 seconds of the recorded music contents.

On the source control screen, touch as follows:



The unit starts scanning.

- To select the previous/next content, touch [◀◀] or [▶▶].
- To end scanning and continue listening to the current song/content, touch [SCAN] again.
- To exit scanning, touch and hold [SCAN].

Content Alert

The unit informs you when receiving the content you are interested in, such as music, information about a sports team, weather and traffic information.

Registering items for Contents Alert

You can register your favorite artists, songs or teams. Up to 50 contents can be registered.

For artists/songs

While listening to your favorite artist/song:

On the source control screen, touch as follows:



Touching the operation keys performs the following actions:

[👤+] (Hold) Registers the artist of the current song.

[🎵+] (Hold) Registers the current song.

For teams

1 Display the <Alert Team Select> screen.

On the source control screen, touch as follows:



Then, on the <SiriusXM Mode> screen, touch as follows:

<Alert Team Select> : [Enter]

2 Select the league (①) and the team (②), then register into the content alert (③).

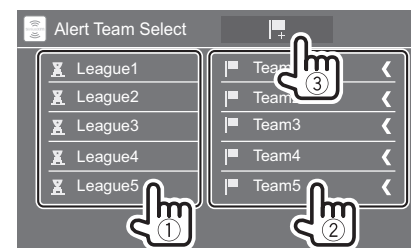

SiriusXM® Satellite Radio

■ Selecting items for Content Alert

You can select items (artists/songs/teams) from the registered items on the list to inform you once the unit receives the information.

For artists/songs/teams

1 Display the <Content Alerts Contents Set> screen.

On the source control screen, touch as follows:



Then, on the <SiriusXM Mode> screen, touch as follows:

<Content Alerts Contents Set> : [Set]

2 Select the category (①), then the item (②).

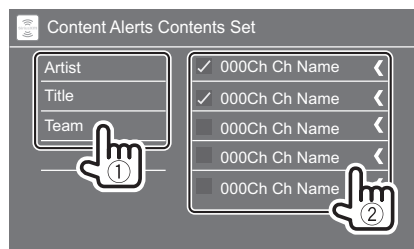

A check mark appears beside the selected item.

- To show the details of the item, touch [<].

To delete the registered items: Touch and hold the item you want to delete in step 2.

The [🗑️] icon and a check mark appear beside the selected item. Touch the [🗑️] icon to delete.

To delete all registered contents: Touch and hold [All Clear ⚡] for <Content Alerts Contents Set> in step 1.

For traffic and weather information

1 Display the <SiriusXM Mode> screen.

On the source control screen, touch as follows:



2 Select the city you desire traffic and weather information for.

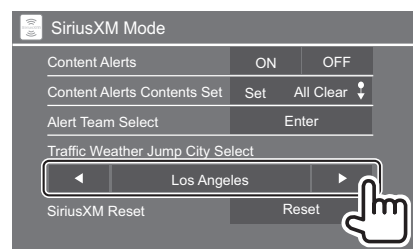

- When traffic and weather broadcast is received, the unit automatically switches the channel.

■ Activating Content Alert

For artists/songs/teams

1 Display the <SiriusXM Mode> screen.

On the source control screen, touch as follows:



2 Activate Content Alert.

On <SiriusXM Mode> screen, touch as follows:
<Content Alerts> : [ON]

To deactivate Content Alert: Touch [OFF] in step 2.

For traffic and weather information

On the source control screen, touch as follows:

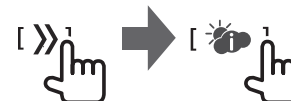

- When a traffic and weather broadcast for the selected city is received, the unit automatically switches the channel.

To deactivate the Content Alert: Touch [🔴] again.

SiriusXM® Satellite Radio

Switching to registered content

When an artist/song/team registered for Content Alert is being broadcasted, an alert appears on the screen.

Touch **[Jump]**, then select the item to jump to on the **<Content Alerts>** screen.

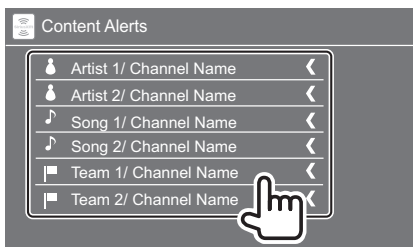

- To show the details of the item, touch **[<]**.

Setting reception restrictions

You can limit access to SiriusXM channels, such as those with mature content.

Setting or changing the parental code

- The initial setting is "0000".
- Changing the code does not change the **<Parental Lock>/<Parental Lock Channel Selection>** settings.

1 Display the **<Parental Code Check>** screen.

On the source control screen, touch as follows:



Then, on the **<SiriusXM Mode>** screen, touch as follows:

<Parental Code> : **[Change]**

2 Enter the initial four-digit code (0000) (①), and then touch **[Enter]** (②) to confirm.

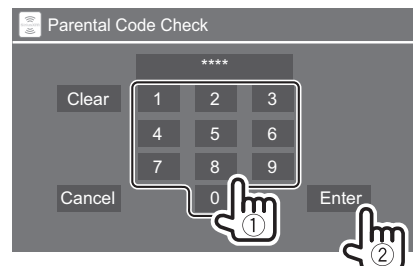

- To clear the last entry, touch **[Clear]**.
- To cancel setting the code, touch **[Cancel]**.

3 Enter a new four-digit code, then touch **[Enter]** to confirm.

4 Repeat step 3 above to confirm the new code.

Activating parental control

You can set the parental control feature to lock any SiriusXM channels or automatically lock all channels classified as "mature" by SiriusXM®.

1 Display the **<SiriusXM Mode>** screen.

On the source control screen, touch as follows:



2 Select the desired mode for **<Parental Control>**.

[OFF]	Deactivates parental control.
[Mature]	Locks channels classified as "mature" by SiriusXM®.
[User]	Locks selected channels.

3 Enter the parental code to confirm your selection.

SiriusXM® Satellite Radio

■ Parental Lock channel selection

This option allows you to manually select the channels to be locked by the parental control feature.

- You can only change the setting if **<Parental Control>** is set to **[User]**.

1 Display the **<Parental Lock Channel Selection>** screen.

On the source control screen, touch as follows:



Then, on the **<SiriusXM Mode>** screen, touch as follows:

<Parental Lock Channel Selection> : **[SET]**

2 Enter the parental code.

The **<Parental Lock Channel Selection>** screen appears.

3 Select a category (①), then a channel (②).

A check mark appears beside the selected channel.

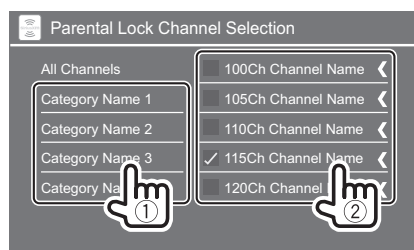

- To list all the channels, select **[All Channels]**.

4 Repeat step 3 to set the parental lock on multiple channels.

To deactivate parental lock for all locked channels:

Select **[All Clear]** for **<Parental Lock Channel Selection>** in step 1, then enter the parental code.

■ Skipping unwanted channels

If you do not want to receive some channels, you can skip them.

1 Display the **<Skip Channel Selection>** screen.

On the source control screen, touch as follows:



Then, on the **<SiriusXM Mode>** screen, touch as follows:

<Skip Channel Selection> : **[SET]**

2 Select a category (①), then a channel (②).

A check mark appears beside the selected channel.

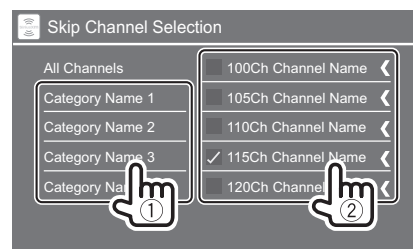

- To list all the channels, select **[All Channels]**.

3 Repeat step 2 to skip multiple channels.

To clear the channel skipping for all skipped channels: Touch and hold **[All Clear ↓]** for **<Skip Channel Selection>** in step 1.

Resetting the SiriusXM Satellite Radio settings

You can reset all the SiriusXM settings you made and restore the initial settings.

1 Display the **<SiriusXM Mode>** screen.

On the source control screen, touch as follows:



2 Reset the setting.

On the **<SiriusXM Mode>** screen, touch and hold as follows:

<SiriusXM Reset> : **[Reset ↓]**

Pandora® (Only for DDX395/DDX375BT/DDX350BT/DDX25BT)

You can stream Pandora from iPhone/iPod touch or Android devices.

- Pandora is only available in certain countries. For more information, visit <www.pandora.com/legal>.
- Because Pandora is a third-party service, the specifications are subject to change without prior notice. Accordingly, compatibility may be impaired or some or all of the services may become unavailable.
- Some functions of Pandora cannot be operated from this unit.
- For issues using the application, contact Pandora at <pandora-support@pandora.com>.

Preparation

■ Installing the application

Your smartphone must have built-in Bluetooth and the following profiles must be supported:

- SPP (Serial Port Profile)
- A2DP (Advanced Audio Distribution Profile)

Establish an Internet connection using LTE, 3G, EDGE, or WiFi.

Ensure you are logged in to your smartphone application. If you do not have a Pandora account, you can create one for free from your smartphone or at <www.pandora.com>.

Install the latest version of the Pandora application on your smartphone.

- For Android devices: Search for “Pandora” in Google play to find and install the most recent version.
- For iPhone/iPod touch: Search for “Pandora” in the Apple iTunes App Store to find and install the most recent version.

■ Connecting the device

For Android devices

Pair the Android device with this unit via Bluetooth. (Page 34)

For iPhone/iPod touch

- Via USB input terminal: Connect iPhone/iPod touch with the cable. (Page 16)
 - For Lightning models: Use KCA-iP103 (optional accessory).
 - For 30-pin connector models: Use KCA-iP102 (optional accessory).
- Via Bluetooth: Pair the iPhone/iPod touch with this unit. (Page 34)

■ Selecting the device

For selecting the playback device via the connection method to use, see <Smartphone Setup> on page 46.

Playback operations

■ Playback information and key operation

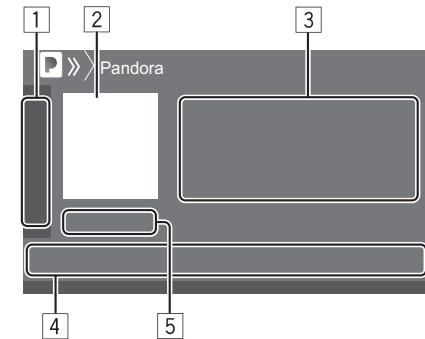

You can also operate Pandora with optional remote controller, KNA-RCDV331.

You can only control play, pause and skip with the remote controller.

- 1 Displays/hides other available operation keys*
- 2 Picture data
- 3 Track information
 - Touching [<] scrolls the text if not all of the text is shown.
- 4 Operation keys*
- 5 Playing time/playback status

* See “Operation keys on source control screen” on page 27.

Pandora®

Operation keys on source control screen

- The appearance of the operation keys may differ, however the similar operation keys have the same operations.
- See also “Common operation keys on source control screen” on page 8.

Touching the operation keys performs the following actions:

1

- | | |
|--------------------|---|
| [+] | Adds the current artist to the station list. |
| [+] | Adds the current track to the station list. |
| [✓] | Bookmarks the current track. |
| [Smartphone Setup] | Switches the device on <Smartphone Setup> screen. (Page 46) |

4

- | | |
|-------|---|
| [Q] | Displays the list selection screen. |
| [⬇️] | Thumbs down to the current track and skips to the next track. |
| [👍] | Registers the current track as a favorite. |
| [▶] | Starts/pauses playback. |
| [▶▶] | Skips the current track. <ul style="list-style-type: none">• Not available when the Pandora skip reaches its limit. |

■ Selecting a station from the list

1 Display the list selection screen.

On the source control screen, touch as follows:



2 Select the list type.

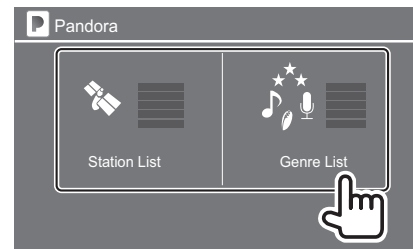

[Station List] Selects from the station names.

[Genre List] Selects from the genres.

3 Select a station from the list.

On the station list

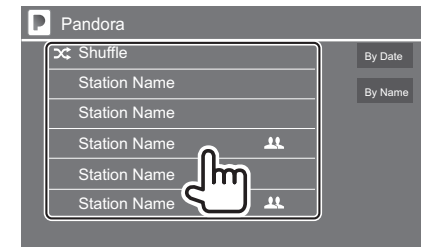

- To play all the songs in the registered stations randomly, touch **[Shuffle]**.
- To sort the list in reverse chronological order, touch **[By Date]**.
- To sort the list in alphabetical order, touch **[By Name]**.
- The 👤 indicator appears on the right of the item when the station is shared.

On the genre list

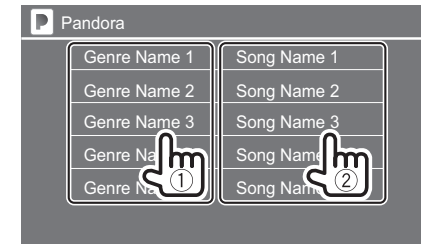

① Select a genre.

② Select a station.

The selected station is added to the station list.

iHeartRadio (Only for DDX395/DDX375BT/DDX350BT/DDX25BT)

iHeartRadio is a free, all-in-one digital radio service that lets you listen to your favorite live stations or create commercial-free, all-music custom stations featuring songs from the artists you select and similar music.

You can stream iHeartRadio from iPhone/iPod touch or Android devices.

- Because iHeartRadio is a third-party service, the specifications are subject to change without prior notice. Accordingly, compatibility may be impaired or some or all of the services may become unavailable.
- Some functions of iHeartRadio cannot be operated from this unit.
- For issues using the application, contact iHeartRadio at <<http://www.iheart.com/>>.

Preparation

■ Installing the application

Your smartphone must have built-in Bluetooth and the following profiles must be supported:

- SPP (Serial Port Profile)
- A2DP (Advanced Audio Distribution Profile)

Establish an Internet connection using LTE, 3G, EDGE, or WiFi.

Ensure you are logged in to your smartphone application. If you do not have an iHeartRadio account, you can create one for free from your smartphone or at <<http://www.iheart.com/>>.

Install the latest version of the iHeartRadio application on your smartphone.

- For Android devices: Search for “iHeartRadio for Auto” in Google Play to find and install the most recent version.
- For iPhone/iPod touch: Search for “iHeartRadio for Auto” in the Apple iTunes App Store to find and install the most recent version.

■ Connecting the device

For Android devices

Pair the Android device with this unit via Bluetooth. (Page 34)

For iPhone/iPod touch

- Via USB input terminal: Connect iPhone/iPod touch with the cable. (Page 16)
 - For Lightning models: Use KCA-iP103 (optional accessory).
 - For 30-pin connector models: Use KCA-iP102 (optional accessory).
- Via Bluetooth: Pair the iPhone/iPod touch with this unit. (Page 34)

■ Selecting the device

For selecting the playback device via the connection method to use, see <**Smartphone Setup**> on page 46.

Playback operations

■ Playback information and keys operation

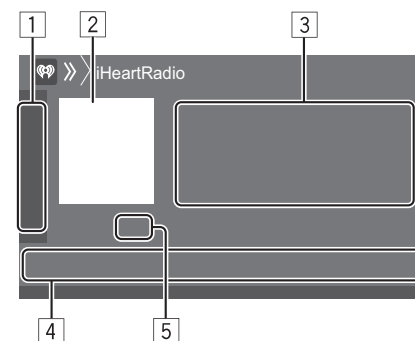

You can also operate iHeartRadio with an optional remote controller, KNA-RCDV331.

You can only control play, pause, and skip with the remote controller.

- 1 Displays/hides other available operation keys*
- 2 Picture data
- 3 Track information
 - Touching [**<**] scrolls the text if not all of the text is shown.
- 4 Operation keys*
- 5 Playback status

* See “Operation keys on source control screen” on page 29.

iHeartRadio

Operation keys on source control screen

- The appearance of the operation keys may differ, however the similar operation keys have the same operations.
- See also “Common operation keys on source control screen” on page 8.

Touching the operation keys performs the following actions:

[1]	
[🎵]	Creates a custom station from the currently playing track content information.
[❤️]	Saves the current station to the <Favorites> list.
[🎛️]*1	Displays the variety level selection screen.
[📱/📱]	Switches the device on <Smartphone Setup> screen. (Page 46)
[4]	
[🔍]	Displays the <Station Search> screen or the station list.
[👎]	Dislikes the currently playing content.
[👍]	Likes the currently playing content.
[▶️/⏸️]*2	Starts/stops playback.
[▶️]*1	Starts/pauses playback.
[SCAN]*2	Scans stations randomly.
[▶️▶️]*1	Skips the current track.

*1 Appears only for the custom station screen.

*2 Appears only for the live station screen.

Selecting the variety level for your custom station

1 Display the variety level selection screen.

On the source control screen, touch as follows:

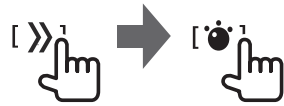

2 Select the variety type.

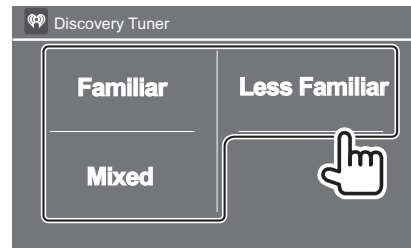

[Familiar] Distributes well-known tracks.

[Mixed] Distributes a mix of artists and track names.

[Less Familiar] Distributes a wide variety of tracks including lesser-known ones.

Searching for a station

1 Display the <Station Search> screen.

On the source control screen, touch as follows:



2 Select a station.

- The items displayed on the <Station Search> screen differ depending on the information sent from iHeartRadio.

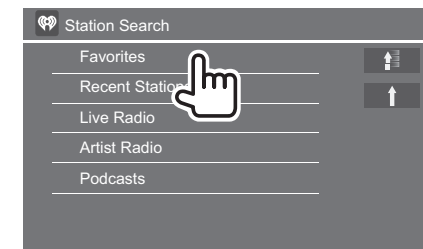

- To return to the top layer, touch [⏮️].
- To return to the upper layer, touch [⏪].

iHeartRadio

■ Editing the <Favorites> list

1 Display the <Station Edit> screen.

On the source control screen, touch as follows:



Then, on the <Station Search> screen, touch as follows:



2 Select stations (①), then delete the selected stations (②).

- A check mark appears beside the selected station.

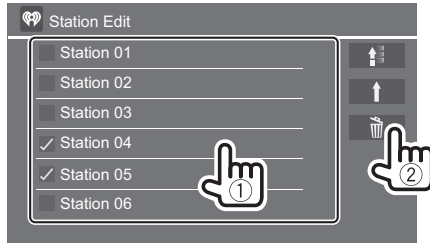

- To return to the top layer, touch [⏮].
- To return to the upper layer, touch [⏪].

Spotify

With Spotify, your music is everywhere. Working out, partying or relaxing, the right music is always at your fingertips. There are millions of songs on Spotify—from old favorites to the latest hits. Just choose the music you love, or let Spotify surprise you.

You can stream Spotify from iPhone/iPod touch or Android devices.

- Because Spotify is a third-party service, the specifications are subject to change without prior notice. Accordingly, compatibility may be impaired or some or all of the services may become unavailable.
- Some functions of Spotify cannot be operated from this unit.
- For issues using the application, contact Spotify at <www.spotify.com>.

Preparation

■ Installing the application

Your smartphone must have built-in Bluetooth and the following profiles must be supported:

- SPP (Serial Port Profile)
- A2DP (Advanced Audio Distribution Profile)

Establish an Internet connection using LTE, 3G, EDGE, or WiFi.

Ensure you are logged in to your smartphone application. If you do not have a Spotify account, you can create one for free from your smartphone or at <www.spotify.com>.

Install the latest version of the Spotify application on your smartphone.

- For Android devices: Search for “Spotify” in Google play to find and install the most recent version.
- For iPhone/iPod touch: Search for “Spotify” in the Apple iTunes App Store to find and install the most recent version.

■ Connecting the device

For Android devices

Pair the Android device with this unit via Bluetooth. (Page 34)

For iPhone/iPod touch

- Via USB input terminal: Connect iPhone/iPod touch with the cable. (Page 16)
 - For Lightning models: Use KCA-iP103 (optional accessory).
 - For 30-pin connector models: Use KCA-iP102 (optional accessory).
- Via Bluetooth: Pair the iPhone/iPod touch with this unit. (Page 34)

■ Selecting the device

For selecting the playback device via the connection method to use, see <**Smartphone Setup**> on page 46.

Playback operations

■ Playback information and key operation

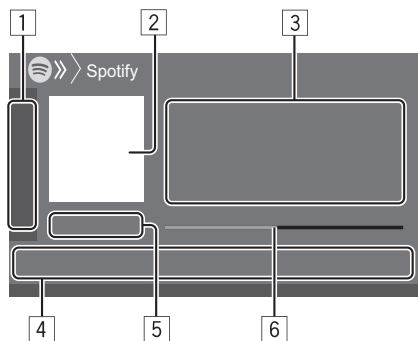

You can also operate Spotify with a remote controller, RC-DV340*1.

You can only control play, pause and skip with the remote controller.

- 1 Displays/hides other available operation keys*2
- 2 Picture data
- 3 Track information
 - Touching [◀] scrolls the text if not all of the text is shown.
 - Touching [👤]/[🎵] changes the displayed information between artist (👤) and album (🎵).
- 4 Operation keys*2
- 5 Playing time/playback status
- 6 Progress bar

Operation keys on source control screen

- The appearance of the operation keys may differ, however the similar operation keys have the same operations.
- See also “Common operation keys on source control screen” on page 8.

Touching the operation keys performs the following actions:

- 1
 - [👎]*3 Thumbs down to the current track and skips to the next track.
 - [👍]*3 Registers the current track as a favorite.
 - [🔀]*4 *5 Activates/deactivates the shuffle playback mode.
 - [🔄]*4 Repeats all tracks/cancels the repeat playback.
 - [🔁]*4 *5 Repeats the current track/cancels the repeat playback.
 - [((+)) Creates a new station.
 - [📱/📲] Switches the device on <Smartphone Setup> screen. (Page 46)
- 4
 - [☰] Displays the Spotify menu screen.
 - [⏪]*5 [⏩] Selects a track.
 - [▶][⏸] Starts (▶)/pauses (⏸) playback.
 - [+] Saves the current track/artist to <Your Music>.

- *1 For DDX395/DDX375BT/DDX350BT/DDX255BT: Purchase optional remote controller, KNA-RCDV331.
- *2 See “Operation keys on source control screen” above.
- *3 Not available for tracks in a playlist.
- *4 Not available for tracks in the Radio.
- *5 Available only for premium account users.

■ Creating your station (Start Radio)

Start Radio is to start a radio channel based on the currently played track.

Create your station.

On the source control screen, touch as follows:



Station is created and playback starts automatically.

- You can personalize your station using thumb up ([👍]) or thumb down ([👎]).
 - You cannot thumb up or down while playing tracks in a playlist.
 - Personalizing stations may not be available depending on the track.

Spotify

■ Selecting a track

1 Display the Spotify menu screen.

On the source control screen, touch as follows:



2 Select the list type, then select a desired item.

- The list types displayed differ depending on the information sent from Spotify.

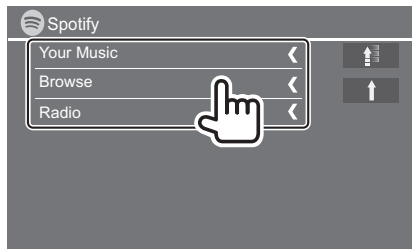

- To return to the top layer, touch [≡].
- To return to the upper layer, touch [↑].

Other External Components

AV-IN

(Only for DDX418BT)

■ Connecting an external component

See page 57 for more information.

■ Starting playback

1 Select “AV-IN” as the source.

2 Turn on the connected component and start playing the source.

■ Changing the AV-IN name

You can change the AV-IN name displayed on the source control screen.

- This setting does not affect the source name displayed on the Home screen.

1 Display the <VIDEO Mode> screen.

On the source control screen, touch as follows:



2 Select an AV-IN name

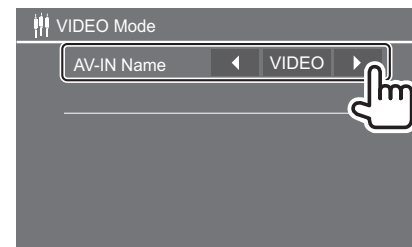

■ Rear view camera

Install the rear view camera (separately purchased) in the appropriate position according to the instructions supplied with the rear view camera.

■ Connecting a rear view camera

See page 57 for more information.

- To use the rear view camera, a reverse lead (REVERSE) connection is required. (Page 56)

■ Using the rear view camera

- For rear camera settings, see <Rear Camera> on page 45.

To display the rear view camera screen

The rear view screen is displayed by shifting the gear to the reverse (R) position when <Rear Camera Interruption> is set to [ON]. (Page 45)

- A caution message appears on the screen. To remove the caution message, touch the screen.

You can also display the picture from the rear view camera manually without shifting the gear to the reverse (R) position.

On the pop-up short-cut menu, touch as follows:



Other External Components

Operations while the camera screen is displayed

To adjust the picture

Touch the area shown below.



Video menu control is shown. For details, see “Video menu control operations” on page 12.

- To exit video menu control, touch the same area again.

To display parking guide line

Set <Parking Guidelines> to [ON] (Page 45) or touch the area shown below.



- To close the parking guidelines, touch the same area again.

To exit the camera screen

Press **HOME** on the monitor panel or touch the area shown below.



Using an external component via ADS adapter—OEM Features (Only for DDX395/DDX375BT)

By connecting this unit to the bus system of the vehicle using iDataLink (commercially available), this unit can access the satellite radio source provided for the vehicle and vehicle information can be displayed on this unit.

- Displayable screens, button names, and screen names vary depending on the type of the connected iDataLink and the model of the vehicle.
- For details, visit <www.idatalink.com/>.

Connecting an ADS adapter

See page 57 for more information.

Using an external component via an ADS adapter

- For settings to use an ADS adapter, see page 45.

1 Select “OEM Features” as the source.

On the Home screen, touch as follows:



2 Turn on the connected component and start playing the source.

[Satellite Radio]	Displays the control screen of the satellite radio source provided for the vehicle.
[Media Player]	Displays the control screen of the media player source provided for the vehicle.
[TEL]	Displays the control screen of the Bluetooth Hands Free function provided for the vehicle.
[BT Streaming]	Displays the control screen of the Bluetooth streaming function provided for the vehicle.
[Gauges]	Displays the information about the instruments such as a speedometer.
[Climate]	Displays the information about the air conditioner of the vehicle.
[Parking Assist]	Displays the information about the Parking Distance Sensor of the vehicle.
[Vehicle Info]	Displays the information about the tire pressures of the vehicle.
[Radar Detector]	Displays the information about the Radar Detector.

Bluetooth®

Information

Bluetooth is a short-range wireless radio communication technology for mobile devices such as mobile phones, portable PCs and other devices. Bluetooth devices can be connected without cables and communicate with each other.

Note

- While driving, do not perform complicated operations such as dialing numbers, using the phone book, etc. When you perform these operations, stop your car in a safe place.
- Some Bluetooth devices may not connect to this unit depending on the Bluetooth version of the device.
- This unit may not work for some Bluetooth devices.
- Connecting conditions may vary depending on your environment.
- For some Bluetooth devices, the device is disconnected when the unit is turned off.
- If your mobile phone supports PBAP (Phone Book Access Profile), you can display the following items on the touch panel when the mobile phone is connected.
 - Phone book
 - Dialed calls, received calls, and missed calls (up to 10 entries in total)

Preparation

Connect and install the microphone beforehand. For details, see page 56.

Connection

When you connect a Bluetooth device to the unit for the first time:

- ① Register the device by pairing the unit and the device.
- ② Connect the device to the unit. (Page 35)

■ Registering a new Bluetooth device

Pairing allows Bluetooth devices to communicate with each other.

- The pairing method differs depending on the Bluetooth version of the device.
 - For devices with Bluetooth 2.1:
You can pair the device and the unit using SSP (Secure Simple Pairing) which only requires confirmation.
 - For devices with Bluetooth 2.0:
You need to enter a PIN code both on the device and unit for pairing.
- Once the connection is established, it is registered in the unit even if you reset the unit. Up to five devices can be registered in total.
- Two devices for Bluetooth phone and one for Bluetooth audio can be connected at a time. However, when “BT Audio” is selected as the source, you can connect up to five Bluetooth audio devices and switch between these five devices.
- To use the Bluetooth function, you need to turn on the Bluetooth function of the device.

Auto pairing

When <Auto Pairing> is set to [ON], Android or iOS (such as iPhone) devices are automatically paired when connected via USB. (Page 39)

Pairing a Bluetooth device using SSP (for Bluetooth 2.1)

When the Bluetooth device is compatible with Bluetooth 2.1, a pairing request is sent from the available device.

1 Search for the unit (“DDX3eX”/“DDX3”/“DDX4”) from your Bluetooth device.

2 Confirm the request both on the device and the unit.

On the device:



On the unit:

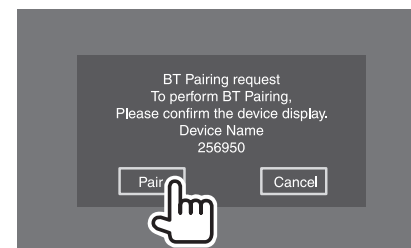

To reject the request: Touch [Cancel].

Bluetooth®

Pairing a Bluetooth device using a PIN code (for Bluetooth 2.0)

1 Display the <PIN Code Set> screen.

On the Home screen, touch as follows:



Then, on the <Setup> screen, touch as follows:

[System] → <Bluetooth Setup> : [Enter]

On the <Bluetooth Setup> screen, touch as follows:

<PIN Code> : [0000]

2 Change the PIN code.

If you wish to skip changing the PIN code, go to step 3.

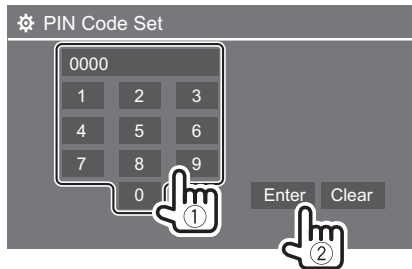

- To delete the last entry, touch [Clear].
- To delete the PIN code, touch and hold [Clear].

3 Search for the unit ("DDX3eX"/"DDX3"/"DDX4") from your Bluetooth device.

4 Select the unit ("DDX3eX"/"DDX3"/"DDX4") on your Bluetooth device.

- If a PIN code is required, enter "0000" (initial) or new PIN code you have entered in step 2.
- When pairing is completed, the device is registered on the <Paired Device List> screen.

Note

- The PIN code is initially set to "0000".
- The maximum number of digits in the PIN code is 15.

Connecting/disconnecting a registered Bluetooth device

1 Display the <Paired Device List> screen.

On the Home screen, touch as follows:



Then, on the <Setup> screen, touch as follows:

[System] → <Bluetooth Setup> : [Enter]

On the <Bluetooth Setup> screen, touch as follows:

<Paired Device List> : [Enter]

2 Select the device (①) you want to connect, then select [Connection] (②).

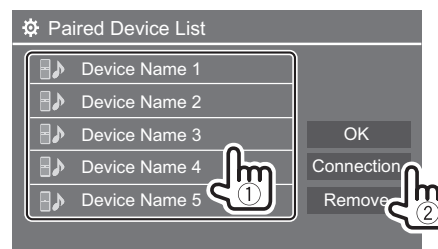

3 Select the device (①) to connect, then return to the <Paired Device List> (②).

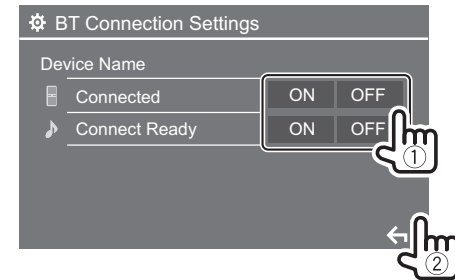

Select [ON] (to connect) or [OFF] (to disconnect).

📱: Mobile phone

🎵: Audio device

4 Connect the selected device.

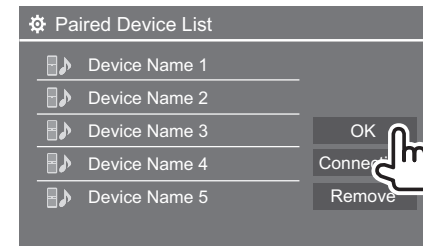

- The status is shown as follows:
 - <Connecting>: Connection is in progress.
 - <Connected>: A connection has been established.
 - <Connect Ready>: A connection can be established.
 - <Disconnecting>: Disconnection is in progress.
 - <Disconnected>: No connection is established.
- When a Bluetooth mobile phone is connected, the signal strength and battery level are displayed when the information is acquired from the device.

Bluetooth®

To delete the registered device: Perform step 1, select the device you want to delete in step 2, then touch **[Remove]**.

- A confirmation message appears. Touch **[Yes]**.

Bluetooth mobile phone

When a call comes in...



Touching the operation keys performs the following actions:

[Answer] Answers a call.

[Reject] Rejects a call.

- Call information is displayed if acquired.
- Phone operation is not available while the picture from the rear view camera is displayed.

During a call...



Touching the operation keys performs the following actions:

[End Call] Ends a call.

[Switch Modes] Switches between handsfree mode and phone mode.

[DTMF] Enters DTMF (Dual Tone Multi Frequency), then sends text using the keypad.

NR LEVEL Adjusts the noise reduction level. [-] / [+] (-5 to 5, initial 0)

EC LEVEL Adjusts the echo volume level. [-] / [+] (-5 to 5, initial 0)

MIC LEVEL Adjusts the volume level of the microphone. (-10 to 10, initial -4)

- Press + / - buttons on the monitor panel to adjust the volume of the call or earpiece.

Making a call

1 Display the phone control screen.

On the Home screen, touch as follows:

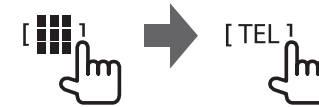

2 Select a method to make a call.

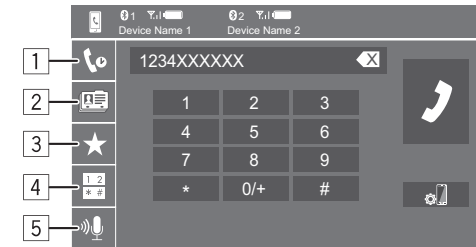

- 1 From the call history* (missed calls/received calls/dialed calls)
- 2 From the phone book*
- 3 From the preset list (Page 38)
- 4 Use direct number entry
- 5 Use voice dialling

* Applicable only for mobile phone compatible with PBAP (Phone Book Access Profile).

3 Select a contact (①), then make a call (②).

When item [1], [2] or [3] is selected in step 2:

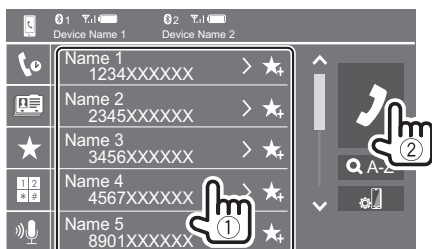

To use alphabet search in the phone book

- ① Touch [Q A-Z].
- ② Touch the first letter you want to search for on the keypad.
To search for a number, touch [1,2,3...].
- ③ Select a contact you want call from the list.

To display other phone numbers in the same contact

You can store up to 10 phone numbers per contact.

- ① Touch [>].
- ② Select a contact you want call from the list.

When item [4] is selected in step 2:

Enter the phone number (①), then make a call (②).

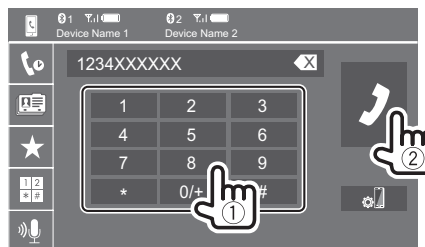

- To enter "+", touch and hold [0/+].
- To delete the last entry, touch [X].

When item [5] is selected in step 2:

Say the name of the person you want to call.

- Available only when the connected mobile phone has a voice recognition system.
- If the unit cannot find the target, "Please speak into the microphone" appears. Touch [Start], then say the name again.
- To cancel voice dialling, touch [Cancel].

Switching between two connected devices

You can change the device to use when 2 devices are connected.

On the phone control screen:

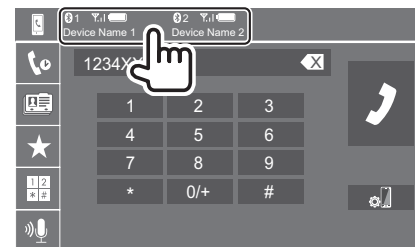

The active device is highlighted.

Bluetooth®

■ Presetting phone numbers

You can preset up to five phone numbers.

1 Display the phone control screen.

On the Home screen, touch as follows:



2 Select call history or phone book calling method (1), then select a contact (2) to preset.

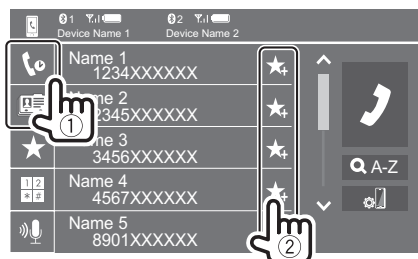

3 Select a preset number to store into.

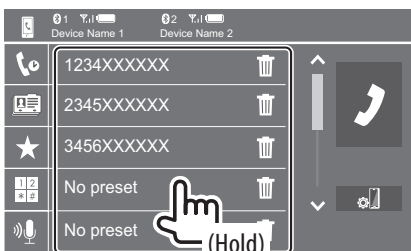

To delete the contact in the preset number: Touch [🗑️] besides the contact on the preset list.

Bluetooth audio player

KENWOOD Music Mix

When "BT Audio" is selected as the source, you can connect up to five Bluetooth audio devices at the same time. You can easily switch between these five devices by playing music from the device.

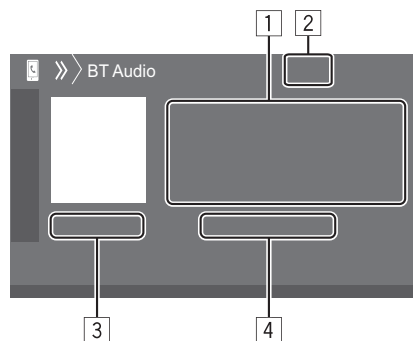
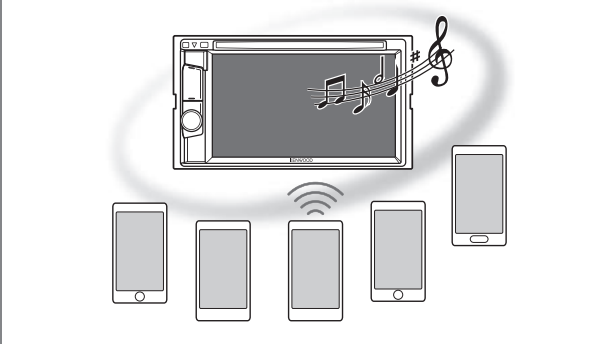

- 1 Tag data* (current track title/artist name/album title)
 - Pressing [←] scrolls the text if not all of the text is shown.
- 2 Signal strength and battery level (Appear only when the information is acquired from the device.)
- 3 Playing time*/playback status*
- 4 Connected device name
 - Touching the device name switches to another connected Bluetooth audio device.

* Available only for devices compatible with AVRCP 1.3.

■ Playback information and key operation

- For playback information, see "Source control screen" on page 8.
- For key operations on the touch panel, see "Common operation keys on source control screen" on page 8.

Additional keys operations. Touching the operation keys performs the following actions:

[⚙️] Displays <Bluetooth Setup> screen.

Bluetooth®

Selecting an audio file from the menu

1 Display the audio menu.

On the source control screen, touch as follows:



2 Select a category (①), then select a desired item (②).

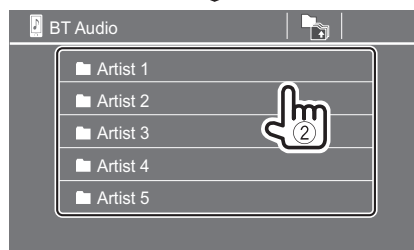
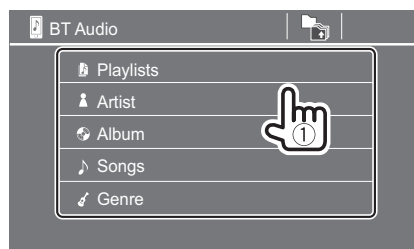

Select an item in each layer until you reach and select the desired file.

Bluetooth settings

You can change various settings for using Bluetooth devices on the <Bluetooth Setup> screen.

1 Display the <Bluetooth Setup> screen.

On the Home screen, touch as follows:



Then, on the <Setup> screen, touch as follows:
[System] → <Bluetooth Setup> : [Enter]

2 Make the settings.

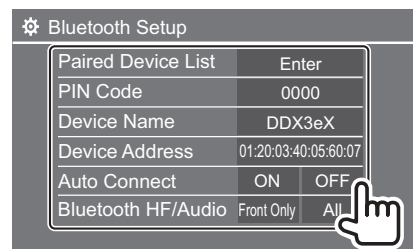

<Paired Device List>

Display the list of registered devices. You can connect a device or delete registered devices.

<PIN Code>

Change the PIN code of the unit.

<Device Name>

Show the device name of this unit to be shown on the Bluetooth device — “DDX3eX”/“DDX3”/“DDX4”.

<Device Address>

Show the device address of the unit.

<Auto Connect>

- **ON** (Initial): Automatically establishes a connection with the last connected Bluetooth device when the unit is turned on.
- **OFF**: Cancels.

<Bluetooth HF/Audio>

Select the speakers used for Bluetooth mobile phones and Bluetooth audio players.

- **Front Only**: Front speakers only.
- **All** (Initial): All speakers.

<Auto Response>

- **ON**: The unit answers the incoming calls automatically in 5 seconds.
- **OFF** (Initial): The unit does not answer the calls automatically. Answer the calls manually.

<Auto Pairing>

- **ON** (Initial): Establishes pairing automatically with the Android or iOS device (such as iPhone) connected via USB. (Auto pairing may not work for some devices depending on the Android/iOS version.)
- **OFF**: Cancels.

<Initialize>

Touch and hold [Enter] to reset all settings you have made for using Bluetooth mobile phones and Bluetooth audio players.

Settings

Audio settings

Display the <Audio> screen.

On the Home screen, touch as follows:



Then, on the <Setup> screen, touch **[Audio]**.

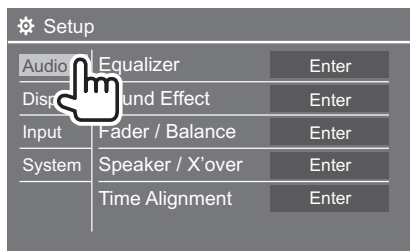

E.g. Audio settings screen for DDX395

You cannot change the <Audio> screen in the following situations:

- When the AV source is turned off.
- When the Bluetooth phone is used (making or receiving a call, during a call, or while voice dialling).

<Equalizer>

The following adjustments are memorized for each source until you adjust the sound again. If the source is a disc, the adjustments are stored for each of the following categories.

- DVD/VCD
 - CD
 - DivX*1/MPEG1/MPEG2/MP3/WMA/WAV/AAC/FLAC
- You cannot adjust the sound when the unit is in standby.

Selecting a preset sound mode

Select a preset sound mode on the <Equalizer> screen.

- **Natural** (Initial)/**Rock/Pops/Easy/Top40/Jazz/Powerful/User**



- To apply the adjusted equalizer to all playback sources, touch **[ALL SRC]**, then touch **[OK]** to confirm.

Store your own sound adjustments

- 1 Select a preset sound mode.
- 2 Select a band (①) and adjust the level (②), then adjust the sound (③).

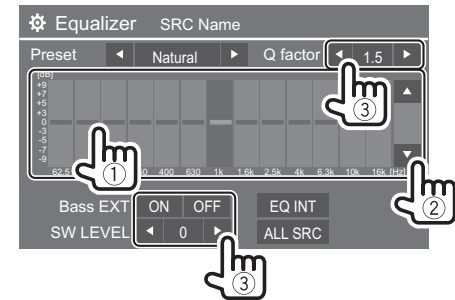

Adjust the sound as follows:

<Q factor>

Adjusts the width of the frequency.

- **1.35/1.5** (Initial)/**2.0**

<Bass EXT>

Activates/deactivates bass.

- **ON/OFF** (Initial)

<SW LEVEL>

Adjusts the subwoofer level.*2

- **-50 to +10** (Initial: 0)

- To clear the adjustment, touch **[EQ INIT]**.

- 3 Repeat step 2 to adjust the level of other bands.

*1 Only for DDX418BT.

*2 Not adjustable when <None> is selected for subwoofer on the <Speaker Select> screen. (Page 41)

Settings

<Sound Effect>

Adjust the sound effect.

<Loudness>

Adjusts loudness.

- OFF (Initial)/Low/High

<Bass Boost>

Selects the bass boost level.

- OFF (Initial)/Level 1/Level 2/Level 3/Level 4/Level 5

<Drive Equalizer>

Reduces the driving noise by raising the bandwidth.

- OFF (Initial)/ON

<Space Enhancer>*1

Virtually enhances the sound space using the Digital Signal Processor (DSP) system. Select the enhance level.

- OFF (Initial)/Small/Medium/Large

<Supreme>*2

Restores the sound lost due to audio compression to a realistic sound.

- OFF/ON (Initial)

<Realizer>

Virtually makes the sound more realistic using the Digital Signal Processor (DSP) system. Select the sound level.

- OFF (Initial)/Level 1/Level 2/Level 3

<Stage EQ>

Moves the center of the sound to the lower or higher point. Select the height.

- OFF (Initial)/Low/Middle/High

*1 You cannot change the setting when "Radio" is selected as the source.

*2 This function works only when "DISC"/"USB"/"iPod"/"Android™" is selected as the source.

<Fader/Balance>

Touch [▲]/[▼]/[◀]/[▶] or drag the  mark to adjust.

<Fader>

Adjusts the front and rear speaker output balance.

When using a two-speaker system, set the fader to the center (0).

- F15 to R15 (Initial: 0)

<Balance>

Adjusts the left and right speaker output balance.

- L15 to R15 (Initial: 0)

To clear the adjustment: Touch [Center].

<Speaker/X'over>

■ Setting the speakers and crossover frequency

- 1 Select a car type (①), select the location of the speakers (②), then display the <Speaker Select> screen (③).

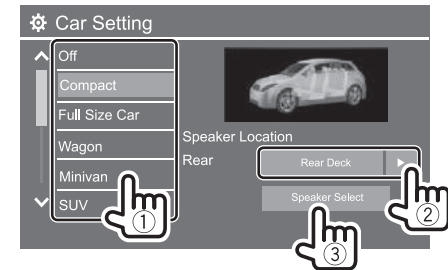

- 2 Select the speaker type (①), select the size of the selected speaker (②), then display the <X'over> screen (③).

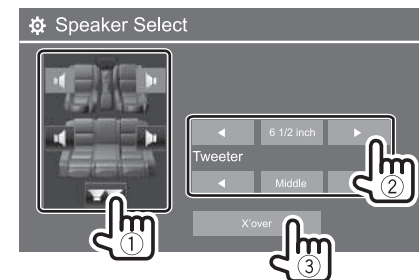

- If a speaker is not connected, select <None>.
- When setting the front speakers, also select the speaker size for <Tweeter>.

Settings

3 Adjust the crossover frequency of the selected speaker.

- Adjustable items vary depending on the selected speaker type/speaker size/crossover settings.

<TW Gain (L)>/<TW Gain (R)>

Adjusts the output volume of the tweeter (left/right).

<TW FREQ>

Adjusts the crossover frequency for the tweeter.

<Gain>

Adjusts the output volume of the selected speaker.

<HPF FREQ>

Adjusts the crossover frequency for the front or rear speakers (high pass filter).

<LPF FREQ>

Adjusts the crossover frequency for the speaker (low pass filter).

<Slope>

Adjusts the crossover slope.

<Phase>

Selects the phase for the speaker.

<Time Alignment>

Make fine adjustments to the delay time of the speaker output to create a more suitable environment for your car.

Select the listening position (①), select [Distance] or [Gain](②) to make an adjustment, then adjust each speaker setting (③).

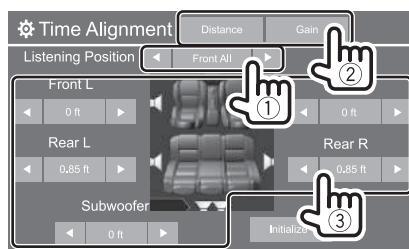

- Select from <All>, <Front L>, <Front R> or <Front All>.

- Select an item to adjust.

[Distance] Adjusts the digital time alignment value.

[Gain] Adjusts the output volume of the selected speaker.

- To determine the adjustment value, see the following "Determining the value for <Position DTA> adjustment".

To initialize the setting value: Touch [Initialize].

Determining the value for <Position DTA> adjustment

If you specify the distance from the center of the currently set listening position to every speaker, the delay time will be automatically computed and set.

- Determine the center of the currently set listening position as the reference point.
- Measure the distances from the reference point to the speakers.
- Calculate the differences between the distance of the furthest speaker and other speakers.
- Set the DTA value calculated in step ③ for individual speakers.
- Adjust gain for individual speakers.

E.g. When <Front All> is selected as the listening position

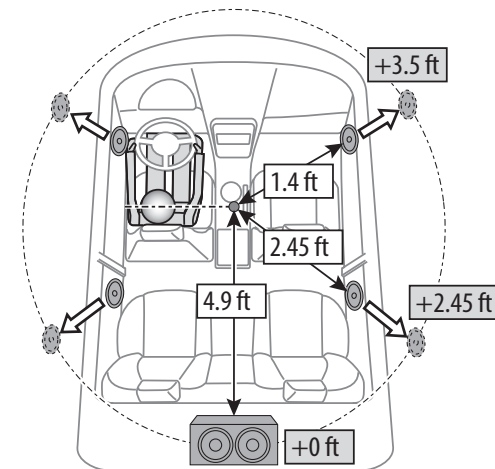

Settings

<Volume Offset>

Adjust and store the auto-adjustment volume level for each source. If the source is a disc, the adjustment is stored for each of the following categories:

- DVD/VCD
- CD
- DivX*/MPEG1/MPEG2/MP3/WMA/WAV/AAC/FLAC

The volume level will automatically increase or decrease when you change the source.

- **-15 to +6** (Initial: **00**)

* Only for DDX418BT.

Display settings

Display the <Display> screen.

On the Home screen, touch as follows:



Then, on the <Setup> screen, touch [Display].

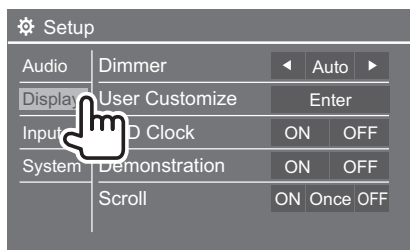

E.g. Display settings screen for DDX395

<Dimmer>

- **Auto** (Initial): Dims the screen and button illumination when you turn on the headlights.
 - The ILLUMI lead connection is required. (Page 56)
- **ON**: Activates dimmer.
- **OFF**: Deactivates dimmer.

<User Customize>

You can change the display design. While playing a video or picture, you can capture an image and use the captured image as a background.

- You cannot capture copyrighted content and images from iPod/iPhone.
- When using a JPEG file as the background, make sure that the resolution is 800 x 480 pixels.
- The color of the captured image may look different from that of the actual scene.

<Background>: Change the background design.

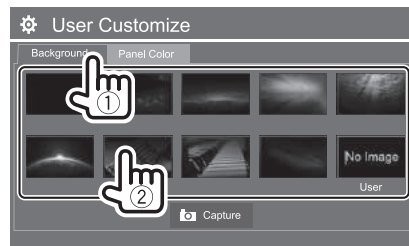

Only for DDX395/DDX375BT/DDX418BT:

<Panel Color>: Change the illumination color of the buttons on the monitor panel.

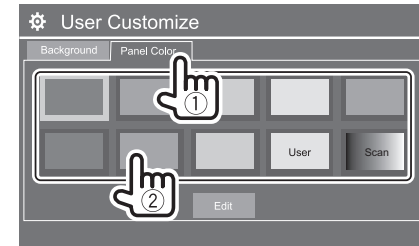

- You can also adjust the illumination color yourself. Touch [Edit] to display the illumination color adjustment screen, then select the dimmer setting and adjust the color. The adjustment is saved in [User].
- Selecting [Scan] changes the illumination color gradually.

■ Storing your own scene for the background image

- 1 While playing a video or picture, display the <User Customize> screen. On the <Display> screen, touch as follows: <User Customize>: [Enter]
- 2 Display the background design selection screen, then touch [Capture].

Settings

3 Adjust the image (①), then capture the image (②).

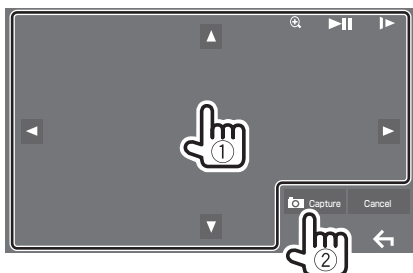

E.g. Image adjustment screen for DDX395

[▲][▼][◀][▶] Moves the zooming frame.

Magnifies the scene.

[+]
• <OFF>/<Zoom1>/<Zoom2>/<Zoom3>

[▶||]* Starts/pauses playback.

[▶▶]* Advances scenes frame by frame.

A confirmation message appears. Touch [Yes] to store the newly captured image. (The existing image is replaced with the new one.)

- To return to the previous screen, touch [No].
- To cancel the capture, touch [Cancel].

* Not displayed when playing an external component connected to the AV-IN input terminal (for DDX418BT only).

<OSD Clock>

- **ON**: Displays the clock while a video source is playing.
- **OFF** (Initial): Cancels.

<Demonstration>

- **ON** (Initial): Activates the display demonstration.
- **OFF**: Deactivates the display demonstration.

<Scroll>

- **ON** (Initial): Scrolls the displayed information repeatedly.
- **Once**: Scrolls the displayed information once.
- **OFF**: Cancels.

Touching [<] scrolls the text regardless of this setting.

<Home Customize>

Arrange the items to display on the Home screen.

Select an item (①) to replace, then select the item (②) you want to display in the selected position.

Repeat this step to place icons for other items.

- Only selectable sources are shown.

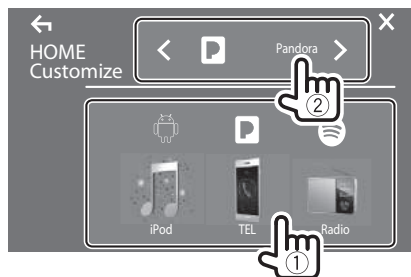

E.g. Home customize screen for DDX395

<Screen Adjustment>

Adjust the brightness and blackness of the screen. Select [DIM ON] (dimmer on) or [DIM OFF] (dimmer off), then change the following settings:

<Bright>

Adjusts brightness.

- **-15** to **+15** (Initial: **0** for dimmer on, **+15** for dimmer off)

<Black>

Adjusts blackness.

- **-10** to **+10** (Initial: **0**)

<Video Output>

Select the color system of the external monitor.

- **NTSC** (Initial)/**PAL**

"Please Power Off" appears when the setting is changed. Turn off the power, then turn on to enable the change.

<Viewing Angle>

Select the viewing angle in relation to the monitor panel to make the panel easier to see.

- **Under 0°** (Initial)/**5°/10°/15°/20°**

Settings

Input settings

Display the <Input> screen.

On the Home screen, touch as follows:



Then, on the <Setup> screen, touch [Input].

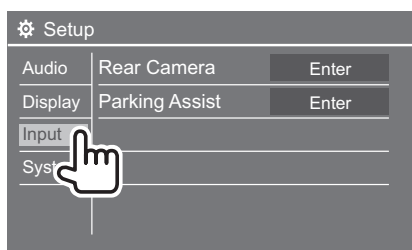

E.g. Input settings screen for DDX395

<Rear Camera>

Configure the rear view camera settings.

<Rear Camera Interruption>

- **ON:** Displays the picture from the rear view camera when you shift the gear to the reverse (R) position.
 - A caution message appears on the screen. To remove the caution message, touch the screen.
- **OFF** (Initial): Select this when no camera is connected.

<Parking Guidelines>

- **ON** (Initial): Displays the parking guidelines.
- **OFF:** Hides the parking guidelines.

<Guidelines Setup>

Adjust the parking guidelines according to the size of the car, parking space and so on.

When adjusting the parking guidelines, make sure to use the parking brake to prevent the car from moving.

Select the mark (①), then adjust the position of the selected mark (②).

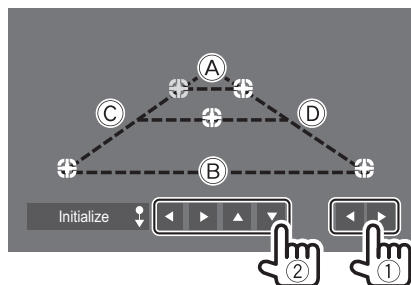

Make sure that ① and ② are horizontally parallel, and that ③ and ④ are the same length.

- Touch and hold [Initialize ↓] for 2 seconds to set all the marks to the initial default position.

<Parking Assist>

(Only for DDX395/DDX375BT)

Configure settings for using the ADS adapter.

<Parking Assist Display>

When an ADS adapter is connected, you can display information about obstacles around the car.

- **ON:** Always displays information.
- **Dyn.** (Initial): Displays information when the sensor detects obstacles.
- **OFF:** Cancels.

<Parking Assist Position>

Select where information about obstacles is displayed on the screen.

- **Left/Right** (Initial)

System settings

Display the <System> screen.

On the Home screen, touch as follows:



Then, on the <Setup> screen, touch [System].

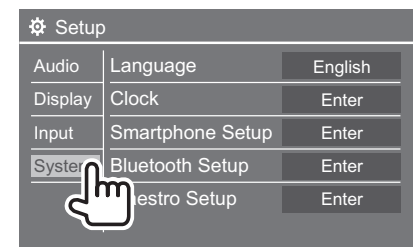

E.g. System settings screen for DDX395

<Language>

Select the text language used for on-screen information. For details, see "Initial settings" on page 5.

<Clock>

Set the clock. For details, see "Clock settings" on page 6.

Settings

<Smartphone Setup>

Specify the connection method of Android/iPod/iPhone.

- 1 Select the device type (①), then touch [Change] (②).



- 2 Select the connection method (①), then confirm the selection ([OK] or [Next]) (②).

If [iPod/iPhone] is selected in step 1:

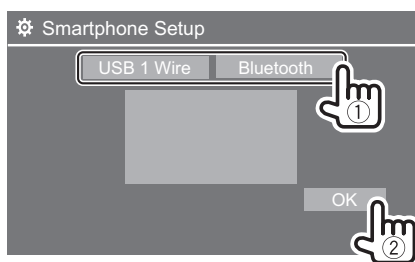

[USB 1 Wire] Select this when the device is connected via the USB input terminal (cable from the rear panel).

[Bluetooth] Select this when the device is connected via Bluetooth. (Go to step 3.)

If **[Android/Other]** is selected in step 1:

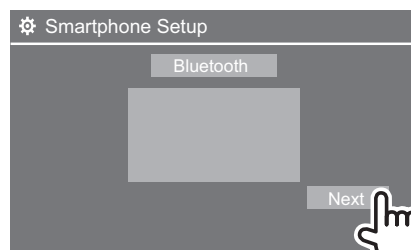

The <Paired Device List> screen appears. Go to step 3.

- 3 When selecting [Bluetooth] as the connection method: Select the device (①), then press [OK] (②) to connect.

• If the device is already connected, skip step ①.

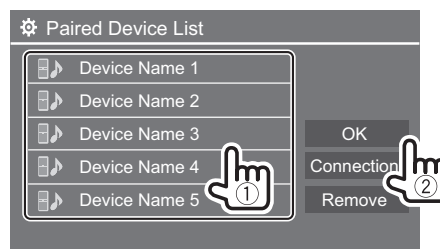

<Bluetooth Setup>

Configure settings for using a Bluetooth device, such as connection and other general operations. For details, see "Bluetooth settings" on page 39.

<OEM Setup>

(Only for DDX395/DDX375BT)

Get information, and change the settings for using the ADS adapter.

<Beep>

- **ON** (Initial): Activates the key-touch tone.
- **OFF**: Deactivates the key-touch tone.

<SETUP Memory>

Memorize, recall, or clear the settings you have made.

- The memorized settings are kept even when the unit is reset.

Touch **[Yes]** to display the setting screen, then select an operation:

- **Recall**: Recalls the memorized settings.
- **Memory**: Memorizes the current settings.
- **Clear**: Clears the currently memorized settings.
- **Cancel**: Cancels.

A confirmation message appears. Touch **[Yes]**.

Settings

<DivX(R) VOD>

(Only for DDX418BT)

This unit has its own Registration Code. Once you have played back a file with the Registration Code recorded, this unit's Registration Code is overwritten for copyright protection.

- Touch **[Enter]** to display the information.
- To return to the previous screen, touch **[OK]**.

<Security Code>

(Only for DDX418BT)

Register the security code for the unit. (Page 6)

<SI>

Activate or deactivate the security function.
(Page 6)

<Serial Number>

(Only for DDX395/DDX375BT/DDX25BT)

Displays the serial number.

<Touch Panel Adjust>

Adjust the touch positions of the buttons on the screen.

Touch the center of the marks at the upper left (①), the lower center (②), then the upper right (③) as instructed.

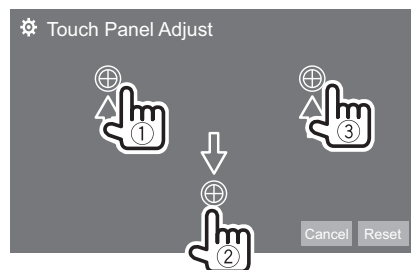

- To reset the touch position, touch **[Reset]**.
- To cancel the current operation, touch **[Cancel]**.

<Steering Remote Control Setting>

(Only for DDX418BT)

Assign functions to the keys of the remote controller on the steering wheel.

- This function is available only when your car is equipped with the electrical steering remote controller.
- You can only register/change the functions while you are parked.
- If your steering remote controller is not compatible, learning may not be completed and an error message may appear.

1 Touch **[Set]** for <Steering Remote Control Setting> to display the setting screen.

2 Press and hold a button on the steering remote controller to register or change.

3 Select a function to assign to the selected button.

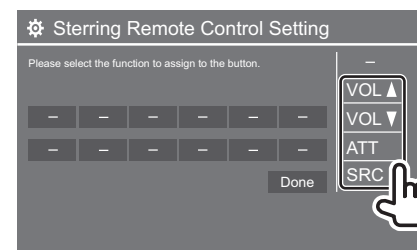

4 Repeat steps 2 and 3 to register other buttons.

5 Touch **[Done]** to finish procedure.

- The unit can register/change all of the buttons' functions at the same time. To do this, press all buttons in turn and after pressing all of them, touch **[Done]** on the <Steering Remote Control Setting> screen. However, new functions cannot be learned after this operation.
- When changing the functions already learned, touch the assigned function you want to change in step 3 and then touch to select the new function from the function list.
- Confirm the contents of the settable functions in the function list. You cannot edit the function list.

To initialize the setting: Touch **[Initialize]** for <Steering Remote Control Setting>.

- A confirmation message appears. Touch **[Yes]**.
 - To cancel the initialization, touch **[No]**.

Settings

<System Information>

Update the system by connecting a USB device containing an update file.

- To obtain the update file, visit <www.kenwood.com/cs/ce/>.

Connect a USB device with the update file to the unit.

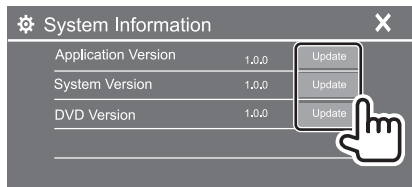

<Application Version>

Updates the system application.

<System Version>

Updates the system.

<DVD Version>

Updates the DVD system application.

The system update starts. It may take a while. If the update has been completed successfully, "Update Completed" appears, then reset the unit.

- Do not disconnect the USB device while updating.
- If the update has failed, turn the power off and then on, and retry the update.
- Even if you have turned off the power during the update, you can restart the update after the power is turned on. The update will be performed from the beginning.

<Open Source Licenses>

Shows the Open Source Licenses.

Remote Controller

- For DDX418BT: This unit can be operated using the remote controller (RC-DV340) supplied with this unit.
- For DDX395/DDX375BT/DDX350BT/DDX25BT: Optional remote controller KNA-RCDV331 is designed for controlling this unit. Refer to the instruction manual that comes with the remote controller.

Remote sensor*

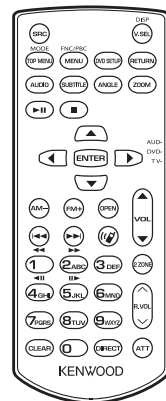
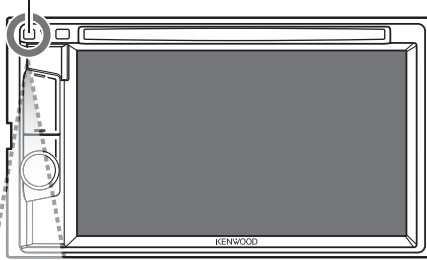

* DO NOT expose the remote sensor to bright light (direct sunlight or artificial lighting).

RC-DV340

⚠ CAUTION

- Put the Remote Controller in a place where it will not move during braking or other operations. A dangerous situation could result if the Remote Controller falls down and gets wedged under the pedals while driving.
- Do not leave the battery near fire or under direct sunlight. A fire, explosion or excessive heat generation may result.
- Do not recharge, short, break up or heat the battery, or place it in an open fire. Such actions may cause the battery to leak fluid. If spilled fluid comes in contact with your eyes or clothing, immediately rinse with water and consult a physician.
- Place the battery out of reach of children. In the unlikely event that a child swallows the battery, immediately consult a physician.

Remote Controller

Preparation

Battery installation

Use two “AAA”/“R03”-size batteries. Insert the batteries with the + and – poles aligned properly, following the illustration inside the case.

- Always insert batteries from – poles to avoid bending the springs.
- If the Remote Controller operates only over shorter distances or does not operate at all, it is possible that the batteries are depleted. In such instances, replace both batteries with new ones.

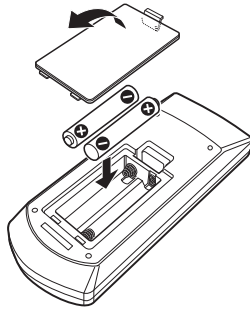

Remote Controller mode switch

The functions operated from the remote controller differ depending on the position of the mode switch.

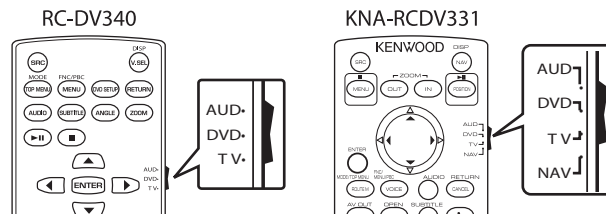

- **AUD mode:** Switch to this mode when controlling a selected source or tuner source, etc.
- **DVD mode:** Switch to this mode when playing DVDs or CDs etc. with the player integrated in this unit.
- **TV mode:** Not used.
- **NAV mode:** Not used.
- The position of the remote control mode switch is indicated in the title of each mode, e.g., “AUD mode”.
- When controlling a player that is not integrated in the unit, select “AUD” mode.

Basic operations for RC-DV340 (supplied)

Common operations (AUD mode)

SRC	<ul style="list-style-type: none">• Selects the source.• Hangs up the incoming/current call.
▲/▼ VOL	Adjusts the volume level.
ATT	Attenuates/restores the sound.
DISP/V.SEL	Switches to the current source control screen.
ENTER	Enters options.
	Answers incoming calls.
FNC/PBC/MENU	Switches the control screen.
MODE/TOP MENU	Changes the aspect ratio. <ul style="list-style-type: none">• The aspect ratio changes each time you press this key.
OPEN	Not used for this unit.

Remote Controller

DVD/VCD (DVD mode)

	Moves the cursor when displaying a menu.
	Selects a track.
	Starts/pauses playback.
	Stops and memorizes the point where the disc stops.
0 – 9	<ul style="list-style-type: none"> Specifies the number to search for in direct search. 1/2: Fast forwards/backwards. <ul style="list-style-type: none"> – Fast forward/backward speed changes each time you press this key. 4/5: Slow forwards/backwards during pause.
MODE/TOP MENU	Shows the disc top menu.
FNC/PBC/MENU	Shows the disc menu.
SUBTITLE	Changes the subtitle language.
ZOOM	Changes the zoom ratio. <ul style="list-style-type: none"> The zoom ratio changes each time you press this key.
ANGLE	Changes the picture angle. <ul style="list-style-type: none"> The picture angle changes each time you press this key.
AUDIO	Changes the voice language. <ul style="list-style-type: none"> The voice language changes each time you press this key.

DIRECT Enters direct search mode.

CLEAR Deletes a character while in direct search mode.

Music Disc/Audio file/Video file/Picture file (AUD mode)

AM –/FM + Selects a folder.

Selects a track/file.

Starts/pauses playback.

0 – 9 Specifies the number to search for in direct search.

DIRECT Enters direct search mode.

Radio/SiriusXM*1 (AUD mode)

AM –/FM + Selects the band.

Searches for stations.*2

Changes the seek mode (AUTO1, AUTO2, MANU).

0 – 9

- Specifies preset number. (1-5)
- Specifies the frequency of the station to receive to search for in direct search.

DIRECT Enters direct search mode.

*1 Only for DDX395/DDX375BT/DDX25BT.

*2 The search method differs according to the selected seek mode.

iPod/Android (AUD mode)

Selects music/videos.

Starts/pauses playback.

USB (AUD mode)

AM –/FM + Selects a folder.

Selects a file.

Starts/pauses playback.

Searching for an item directly

While listening to the radio or during disc playback, you can search for a station frequency/chapter/title/folder/file/track directly using the number buttons.

- To search for a track from the VCD menu, perform during PBC playback.

1 Press DIRECT to enter the search mode.

- Each time you press **DIRECT**, the item to search for changes.

2 Press a number button to select a desired item (station frequency/chapter/title/folder/file/track).

- To erase a misentry, press **CLEAR**.

3 Confirm the selection.

- For station frequency: Press .
- For others: Press **ENTER**.

To exit the search mode: Press **DIRECT**.

Remote Controller

Basic operations for KNA-RCDV331 (optionally purchased)

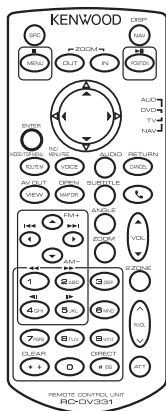



Common operations (AUD/DVD mode)

SRC*	<ul style="list-style-type: none"> • Selects the source. • Hangs up the incoming/current call.
VOL ▲/▼	Adjusts the volume level.
ATT	Attenuates/restores the sound.
VOICE/FNC/ MENU/PBC*	For discs/USB/iPod: Switches to the current source control screen.
ENTER	Enters options.
	Answers incoming calls.
ROUTE M/ MODE/ TOP MENU*	Changes the aspect ratio. <ul style="list-style-type: none"> • The aspect ratio changes each time you press this key.
VIEW/AV OUT	Switches the AV source to be output.

MAP DIR/OPEN	Not used for this unit.
NAV/DISP	Not used for this unit.
ZOOM OUT/IN	Not used for this unit.
2 ZONE	Not used for this unit.
R.VOL 	Not used for this unit.

* Available only when the AUD mode is selected.

DVD/VCD (DVD mode)

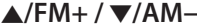
	Moves the cursor when displaying a menu.
	Selects a track.
	Selects a folder.
POSITION/▶ 	Starts/pauses playback.
MENU/■	Stops and memorizes the point where the disc stops.
0 – 9	<ul style="list-style-type: none"> • Specifies the number to search for in direct search. • 1/2: Fast forwards/backwards. • 4/5: Slow forwards/backwards. (For DVD only) <ul style="list-style-type: none"> – Slow forward/backward speed changes each time you press this key.

* +/CLEAR	Deletes a character while in direct search mode.
# BS/DIRECT	Enters direct search mode.
ROUTE M/ MODE/ TOP MENU	Shows the disc top menu.
VOICE/FNC/ MENU/PBC	<ul style="list-style-type: none"> • Shows the disc menu. • Turns the playback control on or off while playing VCD.
CANCEL/ RETURN	Displays previous screen.
AUDIO	Changes the voice language. <ul style="list-style-type: none"> • The voice language changes each time you press this key.
SUBTITLE	Changes the subtitle language.
ANGLE	Changes the picture angle. <ul style="list-style-type: none"> • The picture angle changes each time you press this key.
ZOOM	Changes the zoom ratio. <ul style="list-style-type: none"> • The zoom ratio changes each time you press this key.

Remote Controller

■ Music Disc/Audio file/Video file/Picture file (AUD mode)

▲/FM+ / ▼/AM-	Selects a folder.
◀/ ◀◀ / ▶▶ /▶	Selects a track/file.
POSITION/▶	Starts/pauses playback.
0 - 9	Specifies the number to search for in direct search.
# BS/DIRECT	Enters direct search mode.

■ Radio/SiriusXM*1 (AUD mode)

▲/FM+ / ▼/AM-	Selects the band.
◀/ ◀◀ / ▶▶ /▶	Searches for stations.*2
POSITION/▶	Changes the seek mode (AUTO1, AUTO2, MANU).
0 - 9	Specifies the frequency of the station to receive to search for in direct search.
# BS/DIRECT	Enters direct search mode.

*1 Only for DDX395/DDX375BT/DDX25BT.

*2 The search method differs according to the selected seek mode.

■ iPod/Android (AUD mode)

◀/ ◀◀ / ▶▶ /▶	Selects music/videos.
POSITION/▶	Starts/pauses playback.

■ USB (AUD mode)

▲/FM+ / ▼/AM-	Selects a folder.
◀/ ◀◀ / ▶▶ /▶	Selects a file.
POSITION/▶	Starts/pauses playback.

■ Searching for an item directly

While listening to the radio or during disc playback, you can search for a station frequency/chapter/title/folder/file/track directly using the number buttons.

- To search for a track from the VCD menu, perform during PBC playback.

- 1 Press # BS/DIRECT to enter the search mode.**
 - Each time you press # BS/DIRECT, the item to search for changes.
- 2 Press a number button to select a desired item (station frequency/chapter/title/folder/file/track).**
 - To erase a misentry, press * +/CLEAR.
- 3 Confirm the selection.**
 - For station frequency: Press ◀/|◀◀ / ▶▶|/▶.
 - For others: Press ENTER.

To exit the search mode: Press # BS/DIRECT.

Remote Controller

KENWOOD Remote APP

KENWOOD Remote is an application that connects and controls compatible KENWOOD car receivers via Bluetooth® like a wireless remote control.

You can also operate this unit from a Smartphone using KENWOOD Remote APP.

This application can display the source information of this unit on the smartphone's screen, and enables the user to make an audio setting using the graphic user interface of this application.

This application also works as a free standalone music player application, when your Smartphone is not connected to this unit.

- For details, visit <www.kenwood.com/car/app/kenwood_remote/eng/>.

Installation and Connection

⚠ WARNINGS

- DO NOT connect the ignition wire (red) and the battery wire (yellow) to the car chassis (ground), you may cause a short circuit, that in turn may start a fire.
- DO NOT cut out the fuse from the ignition wire (red) and the battery wire (yellow). The power supply must be connected to the wires via the fuse.
- Always connect the ignition wire (red) and the battery wire (yellow) to the power source running through the fuse box.

⚠ CAUTIONS

- Install this unit in the console of your car.
- Do not touch the metal parts of this unit during and shortly after the use of the unit. Metal parts such as the heat sink and enclosure become hot.
- When parking at a low ceiling area, turn off the unit to store the antenna. As when the unit is installed in the car with the function of auto antenna; the radio antenna extends automatically when you turn on the unit with the antenna control wire (ANT. CONT) connected. (Page 56)

Before installation

■ Precautions on installation and connection

- Mounting and wiring this product requires skills and experience. For best safety, leave the mounting and wiring work to professionals.
- Mount the unit so that the mounting angle is 30° or less.
- Make sure to ground the unit to a negative 12 V DC power supply.
- Do not install the unit in a location exposed to direct sunlight or excessive heat or humidity. Also avoid places with too much dust or the possibility of water splashing.
- Do not use your own screws. Use only the screws provided. If you use the wrong screws, you could damage the unit.
- After the unit is installed, check whether the brake lamps, blinkers, wipers, etc. on the car are working properly.
- Do not press hard on the panel surface when installing the unit to the car. Otherwise scratches, damage, or failure may result.
- If the power is not turned on ("Miswiring DC Offset Error", "Warning DC Offset Error" is displayed), the speaker wire may have a short circuit or have touched the chassis of the car and the protection function may have been activated. In this case, the speaker wire should be checked.
- Keep all cables away from heat dissipating metal parts.

Installation and Connection

- If your car's ignition does not have an ACC position, connect the ignition wires to a power source that can be turned on and off with the ignition key. If you connect the ignition wire to a power source with a constant voltage supply, such as with battery wires, the battery may be drained.
- If the fuse blows, first make sure the wires are not touching to cause a short circuit, then replace the old fuse with one with the same rating.
- Insulate unconnected wires with vinyl tape or other similar material. To prevent a short circuit, do not remove the caps and do not let the cable out at the ends of the unconnected wires or the terminals.
- Secure the wires with cable clamps and wrap vinyl tape around the wires that comes into contact with metal parts to protect the wires and to prevent short circuit.
- Connect the speaker wires correctly to the terminals to which they correspond. The unit may be damaged or fail to work if you share the ⊖ wires or ground them to any metal part in the car.
- When only two speakers are being connected to the system, connect both connectors either to the front output terminals or to the rear output terminals (do not mix front and rear). For example, if you connect the ⊕ connector of the left speaker to a front output terminal, do not connect the ⊖ connector to a rear output terminal.

Parts list for installation

Note: This parts list does not include all the package contents.

- 1 Wiring harness (× 1)
- 2 Extension wire, 2 m (× 1)
- 3 Flat head screws, M5 × 8 mm (× 6)
- 4 Round head screws, M5 × 8 mm (× 6)
- 5 Microphone, 3 m (× 1)

Only for DDX395/DDX418BT

- 6 Trim plate (× 1)

Only for DDX395

- 7 Mounting sleeve (× 1)
- 8 Extraction keys (× 2)

Only for DDX418BT

- 9 Steering remote cable (× 1)
- 10 Audio and video cable (× 1)

Installation procedure

- 1 **Remove the key from the ignition and disconnect the ⊖ battery.**
- 2 **Make the proper input and output wire connections for each unit.**
- 3 **Connect the speaker wires of the wiring harness.**
- 4 **Connect the wires of the wiring harness in the following order: ground, battery, ignition.**
- 5 **Connect the wiring harness to the unit.**
- 6 **Install the unit in your car.**
Make sure that the unit is installed securely in place. If the unit is unstable, it may malfunction (e.g., the sound may skip).
- 7 **Reconnect the ⊖ battery.**
- 8 **Press the reset button on the monitor panel. (Page 4)**
- 9 **Configure <Initial Settings>. (Page 5)**

Installation and Connection

Installing the unit

■ Installing the unit using the mounting bracket removed from the car

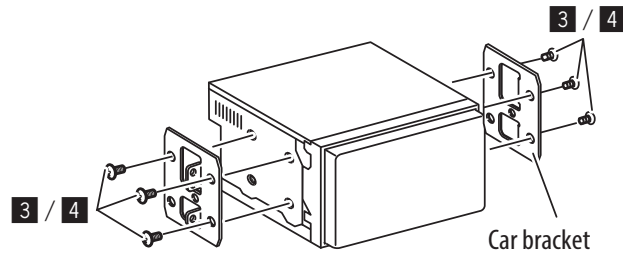

Note: Select the appropriate screws (supplied) for the mounting bracket.

■ Installing the unit using the mounting sleeve

(Only for DDX395)

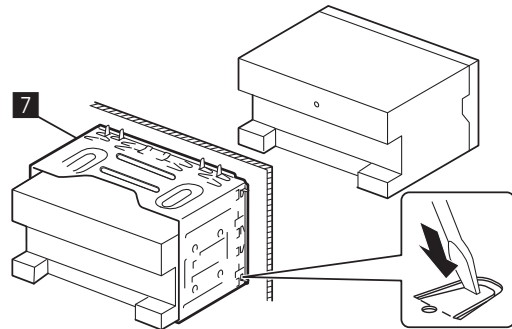

Bend the tabs of the mounting sleeve with a screwdriver or similar utensil and attach it in place.

■ Installing the trim plate

(Only for DDX395/DDX418BT)

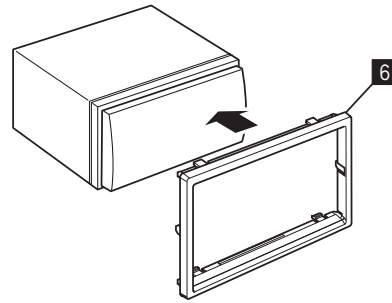

Removing the unit

(Only for DDX395)

1 Engage the catch pins on the extraction keys (8) and remove the two locks on the lower part of the trim plate (6).

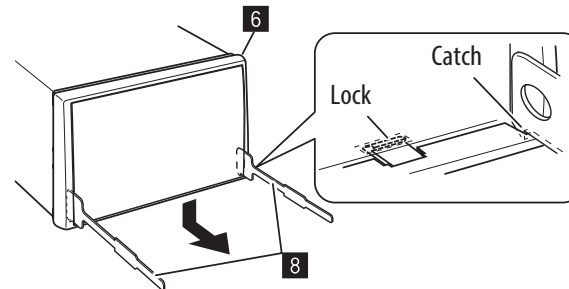

2 Remove from the upper two catches of the trim plate (6).

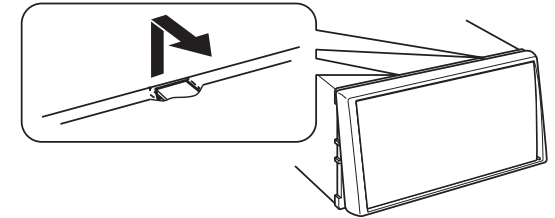

The frame can be removed from the top side in the same manner.

3 Remove the unit by inserting the two extraction keys (8), then pulling them as illustrated.

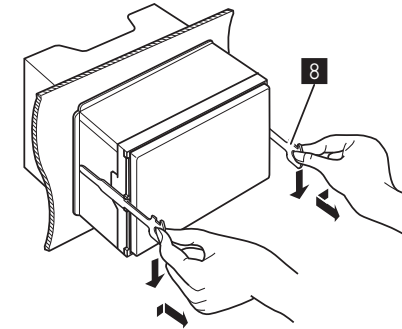

Be careful to avoid injury from the catch pins on the extraction key.

Installation and Connection

Wiring connection

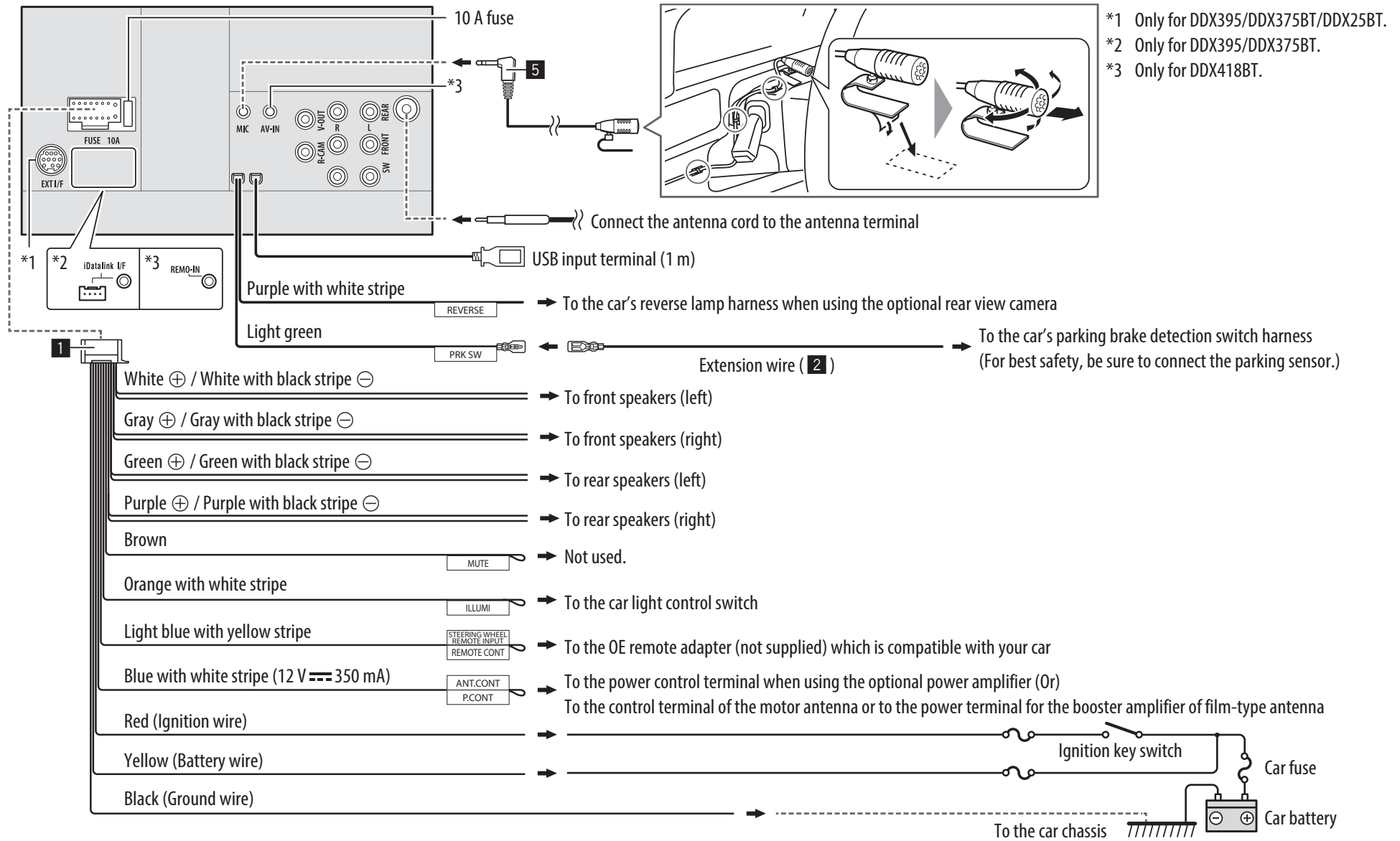

Installation and Connection

Connecting external components

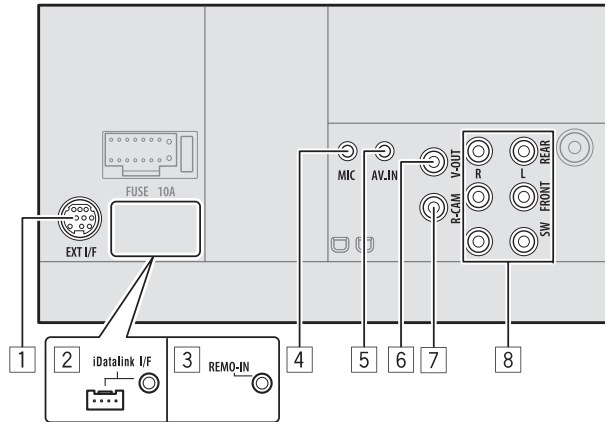

- 1 Expansion port for connecting SiriusXM Connect Vehicle Tuner (EXT I/F) (commercially available)*1
- 2 iDataLink input for connecting an ADS adapter (commercially available)*2
- 3 Steering wheel remote controller input (REMO-IN)*3
 - Connect to the car's steering remote harness using the steering remote cable (9). Contact your KENWOOD dealer for details.
- 4 Microphone input (MIC) (Page 56)
- 5 Audio video input (AV-IN)*3*4
Connect the following type of 4-pole mini plug:

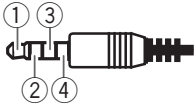

- 1 Left audio
 - 2 Right audio
 - 3 Ground
 - 4 Composite video
- 6 Video output (V-OUT)

- 7 Rear view camera input (R-CAM)
- 8 Output terminals*5
 - Left output (White)
 - Right output (Red)
 REAR: Rear speaker preouts
 FRONT: Front speaker preouts
 SW: Subwoofer preouts

- *1 Only for DDX395/DDX375BT/DDX25BT.
 *2 Only for DDX395/DDX375BT.
 *3 Only for DDX418BT.
 *4 Use the audio and video cable (10) to connect an external component.
 *5 When connecting an external amplifier, connect its ground wire to the chassis of the car; otherwise the unit may be damaged.

References

Maintenance

Cleaning the unit

- Do not use any solvent (for example, thinner, benzine, etc.), detergent, or insecticide. This may damage the monitor or the unit.
- Gently wipe the panel with a soft, dry cloth.

Handling discs

- Do not touch the recording surface of the disc.
- Do not stick tape etc. on the disc, or use a disc with tape stuck on it.
- Do not use any accessories for the disc.
- Clean from the center of the disc and move outward.
- Clean the disc with a dry silicone or soft cloth. Do not use any solvents.
- When removing discs from this unit, pull them out horizontally.
- Remove burrs from the center hole and disc edge before inserting a disc.

More information

About playable files

Audio files

- This unit can play back the following files with following codec and extension code:
 - For disc: MP3 (.mp3), WMA (.wma), WAV (.wav), AAC (.m4a)
 - For USB mass storage class device: MP3 (.mp3), WMA (.wma), WAV (.wav), AAC (.aac, .m4a), FLAC (.flac)

References

- This unit can play back files that meet the conditions below:
 - Bit rate:
 - MP3: 8 kbps – 320 kbps
 - WMA: For disc: 5 kbps – 320 kbps
For USB : 32 kbps – 192 kbps
 - AAC: 16 kbps – 320 kbps
 - Sampling frequency:
 - MP3: 16 kHz – 48 kHz
 - WMA: 8 kHz – 48 kHz
 - WAV: 44.1 kHz
 - AAC: 32 kHz – 48 kHz
 - FLAC: 8 kHz – 96 kHz
 - Files recorded in VBR (variable bit rate), and have a discrepancy in elapsed time indication
- This unit can show or display the following:
 - Tag:
 - MP3: ID3 Tag (version 1.0/1.1/2.2/2.3/2.4)
 - WMA Tag
 - WAV Tag
 - AAC Tag
 - FLAC Tag
 - Jacket picture:
 - Picture size: 32 × 32 to 1 232 × 672 resolution
 - Data size: less than 500 KB
 - File type: JPEG
- This unit cannot play back the following files:
 - MP3 files encoded with MP3i and MP3 PRO format.
 - MP3 files encoded with Layer 1/2.
 - WMA files encoded with lossless, professional, and voice format.
 - WMA files which are not based upon Windows Media® Audio.
 - WMA/AAC files copy-protected with DRM.

- AAC files copy-protected with FairPlay (except those stored on an iPod/iPhone).
- Files which have data such as AIFF, ATAC3, etc.

Video files

- This unit can play back the following files with following codec and extension code:
 - DivX* (.divx, .div, .avi) regardless of the letter case—upper/lower
 - MPEG1/MPEG2 (.mpg, .mpeg)
- Streams that conform to:
 - DivX*:
 - Audio: MP3 or Dolby Audio
 - MPEG1/MPEG2:
 - Audio: MPEG1 Audio Layer-2 or Dolby Audio
 - Video: MPEG system/program stream
 - Other playable conditions:
 - DivX*: Bit rate: 8 Mbps (maximum for average video signals)
 - MPEG1/MPEG2: File format: MP@ML (Main Profile at Main Level)/SP@ML (Simple Profile at Main Level)/MP@LL (Main Profile at Low Level)
 - This unit cannot play back the following files:
 - DivX files encoded in the interlaced scanning mode.

* **Only for DDX418BT.**

Picture files

- This unit can play back the following files with following codec and extension code:
 - JPEG (.jpg, .jpeg)
- Other playable conditions:
 - Resolution: 32 × 32 to 8 192 × 7 680 (It may take time to display the file depending on its resolution.)
 - Baseline JPEG files
- This unit cannot play back the following files:
 - Progressive JPEG files
 - Lossless JPEG files

About disc playback

Playable disc types

- CD-DA: Audio CD, CD Text
- DVD Video: Region code: 1 or 4 (depending on the country and sales area)
- Dual Disc: DVD side
- VCD: Video CD (PBC compatible)
- DVD Recordable/Rewritable (DVD-R/-RW, +R/+RW)
 - DVD Video: UDF bridge
 - ISO 9660 level 1, level 2, Romeo, Joliet
 - Other playable formats:
 - DVD-R recorded in multi-border format (except for dual layer discs)
 - Finalized +R/+RW (Video format only)
- CD Recordable/Rewritable (CD-R/-RW):
 - ISO 9660 level 1, level 2, Romeo, Joliet
- Other informations:
 - While playing a DVD Video, DTS sound cannot be reproduced or emitted from this unit.

References

- This unit can recognize a total of 5 000 files and 250 folders (a maximum of 999 files per folder) in a recordable/rewritable disc.
- Use only “finalized” recordable/rewritable discs.
- This unit can play back multi-session recordable/rewritable discs; however, unclosed sessions will be skipped while playing.

Unplayable disc types and formats

- DVD-Audio/DVD-ROM discs
- SVCD (Super Video CD), CD-ROM, CD-I (CD-I Ready), DTS-CD
- MPEG4/DivX*/AAC (.aac)/FLAC/MKV/DVD–VR/ DVD+VR/DVD-RAM recorded on DVD-R/RW or +R/+RW
- MPEG4/DivX*/AAC (.aac)/FLAC/MKV recorded on CD-R/RW
- DVD-RW dual layer discs
- +RW double layer discs
- Non-DVD side of a “DualDisc” which does not comply with the “Compact Disc Digital Audio” standard
- Discs that are not round.
- Discs with coloring on the recording surface or discs that are dirty.
- Recordable/Rewritable discs that have not been finalized.
- 3 inch discs. Attempting to insert these discs using an adapter may cause a malfunction.
- Some recordable/rewritable discs or files may not be played back due to their characteristics or recording conditions.

* Only for DDX395/DDX375BT/DDX350BT/DDX25BT.

Language codes (for DVD language selection)

AA	Afar	GD	Scots Gaelic
AB	Abkhazian	GL	Galician
AF	Afrikaans	GN	Guarani
AM	Ameharic	GU	Gujarati
AR	Arabic	HA	Hausa
AS	Assamese	HI	Hindi
AY	Aymara	HR	Croatian
AZ	Azerbaijani	HU	Hungarian
BA	Bashkir	HY	Armenian
BE	Byelorussian	IA	Interlingua
BG	Bulgarian	IE	Interlingue
BH	Bihari	IK	Inupiak
BI	Bislama	IN	Indonesian
BN	Bengali, Bangla	IS	Icelandic
BO	Tibetan	IW	Hebrew
BR	Breton	JA	Japanese
CA	Catalan	JI	Yiddish
CO	Corsican	JW	Javanese
CS	Czech	KA	Georgian
CY	Welsh	KK	Kazakh
DZ	Bhutani	KL	Greenlandic
EL	Greek	KM	Cambodian
EO	Esperanto	KN	Kannada
ET	Estonian	KO	Korean (KOR)
EU	Basque	KS	Kashmiri
FA	Persian	KU	Kurdish
FI	Finnish	KY	Kirghiz
FJ	Fiji	LA	Latin
FO	Faroese	LN	Lingala
FY	Frisian	LO	Laothian
GA	Irish	LT	Lithuanian

LV	Latvian, Lettish	SM	Samoan
MG	Malagasy	SN	Shona
MI	Maori	SO	Somali
MK	Macedonian	SQ	Albanian
ML	Malayalam	SR	Serbian
MN	Mongolian	SS	Siswati
MO	Moldavian	ST	Sesotho
MR	Marathi	SU	Sundanese
MS	Malay (MAY)	SW	Swahili
MT	Maltese	TA	Tamil
MY	Burmese	TE	Telugu
NA	Nauru	TG	Tajik
NE	Nepali	TH	Thai
NO	Norwegian	TI	Tigrinya
OC	Occitan	TK	Turkmen
OM	(Afan) Oromo	TL	Tagalog
OR	Oriya	TN	Setswana
PA	Panjabi	TO	Tonga
PL	Polish	TR	Turkish
PS	Pashto, Pushto	TS	Tsonga
QU	Quechua	TT	Tatar
RM	Rhaeto-Romance	TW	Twì
RN	Kirundi	UK	Ukrainian
RO	Rumanian	UR	Urdu
RW	Kinyarwanda	UZ	Uzbek
SA	Sanskrit	VI	Vietnamese
SD	Sindhi	VO	Volapuk
SG	Sangho	WO	Wolof
SH	Serbo-Croatian	XH	Xhosa
SI	Singhalese	YO	Yoruba
SK	Slovak	ZU	Zulu
SL	Slovenian		

References

■ About USB playback

Important

Make sure all important data has been backed up to avoid losing the data.

We bear no responsibility for any loss of data stored in the devices while using this unit.

Playable files on a USB device

- This unit can play the following types of files stored in a USB mass storage class device.
 - JPEG/Divx*/MPEG1/MPEG2/MP3/WMA/WAV/AAC (.aac/.m4a)/FLAC
- This unit can recognize:
 - A total of 5 000 files
 - 250 folders for video files and a maximum of 999 files per folder
 - 250 folders for photo files and a maximum of 999 files per folder
 - 999 folders for audio files and a maximum of 999 files per folder
- The maximum number of characters (when the characters are 1 byte):
 - Folder names: 50 characters
 - File names: 50 characters

* Only for DDX418BT.

Notes on using a USB device

- Avoid using the USB device if it might affect driving safety.
- When connecting with a USB cable, use a USB 2.0 cable.

- Electrostatic shock at connecting a USB device may cause abnormal playback of the device. In this case, disconnect the USB device then reset this unit and the USB device.
- Do not pull out and connect the USB device repeatedly while “Reading” is shown on the screen.
- Operation and power supply may not work as intended for some USB devices.
- Do not leave a USB device in the car, or expose to direct sunlight or high temperatures to prevent deformation or damage to the device.

Unplayable USB device

- This unit may not play back files in a USB device properly when using a USB extension cable.
- USB devices equipped with special functions such as data security functions cannot be used with the unit.
- Do not use a USB device with 2 or more partitions.
- Depending on the shape of the USB devices and connection ports, some USB devices may not be attached properly or the connection might be loose.
- This unit may not recognize a memory card inserted into a USB card reader.

■ About iPod/iPhone

Important

Make sure all important data has been backed up to avoid losing the data.

We bear no responsibility for any loss of data stored in the devices while using this unit.

iPod/iPhone that can be connected

- Via the USB terminal:
 - Made for
 - iPod nano (7th Generation)
 - iPod touch (6th Generation)
 - iPod touch (5th Generation)
 - iPhone 7 Plus
 - iPhone 7
 - iPhone SE
 - iPhone 6S Plus
 - iPhone 6S
 - iPhone 6 Plus
 - iPhone 6
 - iPhone 5S
 - iPhone 5C
 - iPhone 5
 - iPhone 4S
- Via Bluetooth:
 - Made for
 - iPod touch (6th Generation)
 - iPod touch (5th Generation)
 - iPhone 7 Plus
 - iPhone 7
 - iPhone SE
 - iPhone 6S Plus
 - iPhone 6S
 - iPhone 6 Plus
 - iPhone 6
 - iPhone 5S
 - iPhone 5C
 - iPhone 5
 - iPhone 4S

References

Notes on using an iPod/iPhone

- When operating an iPod/iPhone, some operations may not be performed correctly or as intended. In this case, visit the following KENWOOD web site: <www.kenwood.com/cs/ce/>
- When you turn on this unit, the iPod/iPhone is charged through the unit.
- The text information may not be displayed correctly.
- For some iPod/iPhone models, the performance may be abnormal or unstable during operation. In this case, disconnect the iPod/iPhone device, then check its condition.
If the performance is not improved or slow, reset your iPod/iPhone.

Troubleshooting

What appears to be trouble is not always serious. Check the following points before calling a service center.

- For operations with external components, refer also to the instructions supplied with the adapters used for connection (as well as the instructions supplied with the external components).

General

No sound comes out of the speakers.

- Adjust the volume to the optimum level.
- Check the cords and connections.

No picture is displayed on the screen.

- Turn on the screen. (Page 4)

The unit does not work at all.

- Reset the unit. (Page 4)

The remote controller* does not work.

- Replace the battery.

* For DDX395/DDX375BT/DDX350BT/DDX25BT: Purchase optional remote controller, KNA-RCDV331.

“No Signal”/“No Video Signal” appears.

- Start playback on the external component connected to the AV-IN input terminal.
- Check the cords and connections.
- Signal input is too weak.

“Miswiring DC Offset Error”/“Warning DC Offset Error” appears.

- A speaker cord has shorted or it has come into contact with the car chassis. Wire or insulate the speaker cord as appropriate, then reset the unit.

“Parking off” appears.

- No playback picture is shown when the parking brake is not engaged.

“Learning Process Failed” appears.

- Your steering remote controller is not compatible, learning may not be completed. Consult your car audio dealer for details.

Discs

Recordable/Rewritable discs cannot be played back.

- Insert a finalized disc.
- Finalize the discs with the component which you used for recording.

Tracks on the Recordable/Rewritable discs cannot be skipped.

- Insert a finalized disc.
- Finalize the discs with the component which you used for recording.

Playback does not start.

- The format of files is not supported by the unit.

No picture appears on the external monitor.

- Connect the video cord correctly.
- Select the correct input on the external monitor.

DivX*/MPEG1/MPEG2/MP3/WMA/WAV/AAC discs cannot be played back.

- Record the tracks using a compatible application on the appropriate discs. (Page 58)
 - Add appropriate extension codes to the file names.
- * Only for DDX418BT.

Tracks on the recordable/rewritable discs are not played back as you have intended them to play.

- Playback order may differ from the one played back using other players.

Troubleshooting

“Region Code Error” appears.

- You have inserted a DVD Video disc of an incorrect region code. Insert a correct region code disc.

USB

“Reading” does not disappear from the screen.

- Turn the power off and on again.

While playing a track, sound is sometimes interrupted.

- The tracks are not properly copied into the USB device. Copy the tracks again, and try again.

Tracks are not played back as you have intended them to play.

- Playback order may differ from the one played back using other players.

The source does not change to “USB” when you connect a USB device while listening to another source or “USB Device Error” appears when you connect a USB device.

- The USB port is drawing more power than the design limit.
- Turn the power off and unplug the USB device. Then, turn on the power and reattach the USB device.
- If the above does not solve the problem, turn the power off and on (or reset the unit) before replacing with another USB device.

Android

Sound cannot be heard during playback.

- Reconnect the Android device.
- When **<Android Setup>** is set to **[HAND MODE]**, launch any media player application on the Android device and start playback.

Sound output only from the Android device.

- When **<Android Setup>** is set to **[HAND MODE]**, relaunch the current media player application or use another media player application.
- Restart the Android device.
- If this does not solve the problem, the connected Android device is unable to route the audio signal to unit.

Cannot play back when <Android Setup> is set to [BROWSE MODE].

- Make sure KENWOOD Music Play APP is installed on the Android device.
- Reconnect the Android device and select the appropriate control mode.
- If this does not solve the problem, the connected Android device does not support the Browse Mode.

“NO DEVICE” or “READING” keeps flashing.

- Switch off the developer options on the Android device.
- Reconnect the Android device.
- If this does not solve the problem, the connected Android device does not support the Browse Mode.

iPod/iPhone

No sound comes out of the speakers.

- Disconnect the iPod/iPhone, then connect it again.
- Select another source, then reselect “iPod”.

The iPod/iPhone does not turn on or does not work.

- Check the connection.
- Update the firmware version.
- Charge the battery.
- Reset the iPod/iPhone.

Sound is distorted.

- Deactivate the equalizer either on this unit or the iPod/iPhone.

A lot of noise is generated.

- Turn off (uncheck) “VoiceOver” on the iPod/iPhone. For details, visit <http://www.apple.com>.

No operations are available when playing back a track containing artwork.

- Operate the unit after the artwork has loaded.

“Authorization Error” appears.

- Check whether the connected iPod/iPhone is compatible with this unit. (Page 60)

Radio

AME automatic presetting does not work.

- Store stations manually. (Page 18)

Static noise while listening to the radio.

- Connect the antenna firmly.

AV-IN

(Only for DDX418BT)

No picture appears on the screen.

- Turn on the video component if it is not on.
- Connect the video component correctly.

Troubleshooting

Pandora*/iHeartRadio*/Spotify

The application does not work.

→ The application on your iPod touch/iPhone/Android is not the latest version. Update the application.

“Please update Pandora App” appears.

→ The Pandora application on your iPod touch/iPhone/Android is not the latest version. Update the application.

“Please check device.” appears.

- The Pandora application on your iPod touch/iPhone/Android has not started up.
- The Pandora application is not installed on the connected device.
- An error has occurred on the Pandora application.

“Login Error” appears.

→ You have not been signed into Pandora.

“No skips remaining” appears.

→ No more songs can be skipped.

“Failed to save your thumb rating” appears.

→ Thumb-up/down is prohibited.

“No Station” appears.

→ No station is available.

“No Active Station” appears.

→ No station is being played.

“Station limit reached” appears.

→ The station list is full and no more stations can be registered.

“Failed to save your bookmark” appears.

→ The unit has failed to save a bookmark. Try the operation again.

“Limited Connectivity” appears.

→ The connection with the Pandora application cannot be established.

“Pandora not available” appears.

→ You cannot use the Pandora application from the area where you are currently trying to access Pandora.

“Try again later” appears.

→ The Pandora server is under maintenance.

“Station does not exist” appears.

→ The selected station has been deleted by another device or has expired.

“Cannot create a Station” appears.

→ You cannot create a station during the read-only mode or when network connection is not established.

* Only for DDX395/DDX375BT/DDX350BT/DDX25BT.

SiriusXM Satellite Radio

“SXM No Signal” appears.

→ Make sure the SiriusXM Satellite Radio antenna is mounted outside the car. Move the car to an area with a clear view of the sky.

“SXM Check Antenna” appears.

- Check the SiriusXM Satellite Radio antenna connection, and make sure the antenna is firmly attached to the tuner.
- Check whether the SiriusXM Satellite Radio antenna cable is bent or broken. If it is damaged, replace the whole antenna unit.

“SXM Check Tuner” appears.

→ Make sure the SiriusXM Connect Vehicle Tuner is connected to the unit.

“SXM Chan Unavailable” appears.

(Appears on the screen for about 5 seconds, then returns to the previous channel):
→ The selected channel is no longer available. Select another channel or continue listening to the previous channel.

“SXM Ch Unsubscribed” appears.

(Appears on the screen for about 5 seconds, then returns to the previous channel)
→ The selected channel is not part of your current subscription plan. Call 1-866-635-2349 to subscribe.

“SXM Subscription Updated – Press Return to Continue” appears.

→ Your subscription has been updated. Press the appropriate button to continue.

“SXM Channel Locked” appears.

→ The selected channel has been locked by the parental controls. Enter the unlock code when you are asked.

“SXM Incorrect Lock Code” appears.

→ The selected channel is a mature or parental lock channel, and locked by the parental lock or user lock code. Enter the correct lock code.

Troubleshooting

Bluetooth

Phone sound quality is poor.

- Reduce the distance between the unit and the Bluetooth mobile phone.
- Move the car to a place where you can get a better signal reception.

The sound is interrupted or skipped while using a Bluetooth audio player.

- Reduce the distance between the unit and the Bluetooth audio player. Disconnect the device connected for Bluetooth phone.
- Turn off, then turn on the unit.
(When the sound is not yet restored) connect the player again.

The connected audio player cannot be controlled.

- Check whether the connected audio player supports AVRCP (Audio/Video Remote Control Profile).

The Bluetooth device does not detect the unit.

- Search from the Bluetooth device again.

The unit does not pair with the Bluetooth device.

- For devices compatible with Bluetooth 2.1:
Register the device using a PIN code. (Page 35)
- For devices compatible with Bluetooth 2.0:
Enter the same PIN code for both the unit and target device. If the PIN code of the device is not indicated in its instructions, try "0000" or "1234."
- Turn off, then turn on the Bluetooth device.

Echo or noise occurs.

- Adjust the microphone unit position.
- Adjust the echo volume or noise reduction volume.
(Page 36)

The unit does not respond when you try to copy the phone book to the unit.

- You may have tried to copy the same entries (as stored) to the unit.

"Connection Error" appears.

- The device is registered but the connection has failed. Connect the registered device. (Page 35)

"Please Wait..." appears.

- The unit is preparing to use the Bluetooth function. If the message does not disappear, turn off and turn on the unit, then connect the device again (or reset the unit).

"No Voice Device" appears.

- The connected mobile phone does not have a voice recognition system.

"No Data" appears.

- No phone book data is contained in the connected Bluetooth phone.

"Initialize Error" appears.

- The unit has failed to initialize the Bluetooth module. Try the operation again.

"Dial Error" appears.

- Dialing has failed. Try the operation again.

"Hung Up Error" appears.

- The call has not ended yet. Park your car, and use the connected mobile phone to end the call.

"Pick Up Error" appears.

- The unit has failed to receive a call.

Specifications

■ Monitor section

Picture Size (W × H)	6.2 inches (diagonal) wide 137.5 mm × 77.2 mm (5-7/16" × 3-1/16")
Display System	Transparent TN LCD panel
Drive System	TFT active matrix system
Number of Pixels	1 152 000 (800H × 480V × RGB)
Effective Pixels	99.99%
Pixel Arrangement	RGB striped arrangement
Back Lighting	LED

■ USB interface section

USB Standard	USB 2.0 Full Speed/High Speed
Compatible Device	Mass Storage Class
File System	FAT 16/32
Maximum Power Supply Current	DC 5 V  1.5 A
D/A Converter	24 bit
Audio Decoder	MP3/WMA/AAC (.aac/.m4a)/WAV/FLAC
Video Decoder	DivX*/MPEG1/MPEG2/JPEG

* Only for DDX418BT.

Specifications

DVD player section

D/A Converter	24 bit
Audio Decoder	Linear PCM/Dolby Audio/ MP3/WMA/WAV/AAC (.m4a)
Video Decoder	DivX*/MPEG1/MPEG2/JPEG
Wow & Flutter	Below Measurable Limit
Frequency Response	96 kHz Sampling: 20 Hz to 22 000 Hz 48 kHz Sampling: 20 Hz to 22 000 Hz 44.1 kHz Sampling: 20 Hz to 20 000 Hz
Total Harmonic Distortion	0.010% (1 kHz)
Signal to Noise Ratio	99 dB (DVD-Video 96 kHz)
Dynamic Range	99 dB (DVD-Video 96 kHz)
Disc Format	DVD-Video/VIDEO-CD/CD-DA
Sampling Frequency	44.1 kHz/48 kHz/96 kHz
Quantifying Bit Number	16 bit/20 bit/24 bit

* Only for DDX418BT.

Bluetooth section

Technology	Bluetooth 3.0
Frequency	2.402 GHz to 2.480 GHz
Output Power	+4 dBm (MAX), 0 dBm (AVE), Power Class 2
Maximum Communication Range	Line of sight approx. 10 m (32.8 ft)
Audio Codec	SBC/AAC
Profile	HFP (Hands Free Profile) 1.6 A2DP (Advanced Audio Distribution Profile) 1.3 AVRCP (Audio/Video Remote Control Profile) 1.5 GAP (Generic Access Profile) PBAP (PhoneBook Access Profile) 1.2 SDP (Service Discovery Profile) SPP (Serial Port Profile) 1.2

DSP section

Equalizer	Band: 13 Band Frequency (Hz) (BAND1-13): 62.5/100/160/250/400/630/ 1k/1.6k/2.5k/4k/6.3k/10k/ 16k Gain (dB): -9/-8/-7/-6/-5/-4/-3/-2/ -1/0/1/2/3/4/5/6/7/8/9 Q factor: 1.35/1.5/2.0
-----------	--

2 Way X'Over

Tweeter:	Frequency (Hz): 1k/1.6k/2.5k/4k/5k/6.3k/8k/ 10k/12.5k Gain (dB): -8/-7/-6/-5/-4/-3/-2/-1/0
Front/Rear (HPF):	Frequency (Hz): Through/30/40/50/60/70/ 80/90/100/120/150/180/ 220/250 Slope (dB/Oct.): -6/-12/-18/-24 Gain (dB): -8/-7/-6/-5/-4/-3/-2/-1/0
Subwoofer (LPF):	Frequency (Hz): 30/40/50/60/70/80/90/100/ 120/150/180/220/250/ Through Slope (dB/Oct.): -6/-12/-18/-24 Phase: Normal/Reverse Gain (dB): -8/-7/-6/-5/-4/-3/-2/-1/0
Position	Front/Rear/Subwoofer Delay: 0 ft to 20.0 ft (0.07 ft Step) Gain: -8 dB to 0 dB
Subwoofer Level	-50 dB to +10 dB

Specifications

FM tuner section

Frequency Range	DDX395/DDX375BT/ DDX350BT/DDX25BT: 87.9 MHz to 107.9 MHz (200 kHz)
	DDX418BT: 87.5 MHz to 108.0 MHz (50 kHz)
Usable Sensitivity (S/N: 30 dB)	7.2 dBf (0.63 μ V/75 Ω)
Quieting Sensitivity (S/N: 50 dB)	15.2 dBf (1.58 μ V/75 Ω)
Frequency Response (\pm 3.0 dB)	30 Hz to 15 kHz
Signal to Noise Ratio	68 dB (MONO)
Selectivity (\pm 400 kHz)	> 80 dB
Stereo Separation	40 dB (1 kHz)

AM tuner section

Frequency Range	530 kHz to 1 700 kHz (10 kHz)
Usable Sensitivity	29 dB μ

Video section

Color System of External Video Input	NTSC/PAL
External Video Input Level (mini jack)*	1 Vp-p/75 Ω
External Audio Max Input Level (mini jack)*	2 V/25 k Ω
Video Input Level for Rear Camera (RCA jack)	1 Vp-p/75 Ω
Video Output Level (RCA jack)	1 Vp-p/75 Ω

* Only for DDX418BT.

Audio section

Maximum Power (Front & Rear)	50 W \times 4
Full Bandwidth Power (Front & Rear)	22 W \times 4 (at less than 1% THD)
Preout Level	DDX395: 5 V/10 k Ω
	DDX375BT: 4 V/10 k Ω
	DDX350BT/DDX25BT/ DDX418BT: 2.5 V/10 k Ω
Preout Impedance	\leq 600 Ω
Speaker Impedance	4 Ω to 8 Ω

General

Operating Voltage	14.4 V (10.5 V to 16 V allowable)
Maximum Current Consumption	10 A
Installation Dimensions (W \times H \times D)	DDX395: With sleeve: 182 mm \times 111 mm \times 160 mm (7-3/16" \times 4-3/8" \times 6-5/16") Without sleeve: 178 mm \times 100 mm \times 162 mm (7" \times 3-15/16" \times 6-3/8") DDX375BT/DDX350BT/ DDX25BT/DDX418BT: 178 mm \times 100 mm \times 162 mm (7" \times 3-15/16" \times 6-3/8")
Operational Temperature Range	-10°C to +60°C
Weight (Main Unit)	DDX395: 2.0 kg (4.4 lbs) (including trim plate and sleeve) DDX375BT/DDX350BT/ DDX25BT: 1.7 kg (3.8 lbs) DDX418BT: 1.8 (4.0 lbs) (including trim plate)

Design and specifications are subject to change without notice.

Specifications

Trademarks and licenses

- Dolby, Dolby Audio and the double-D symbol are trademarks of Dolby Laboratories.
- “DVD Logo” is a trademark of DVD Format/Logo Licensing Corporation registered in the US, Japan and other countries.
- The “AAC” logo is a trademark of Dolby Laboratories.
- Microsoft and Windows Media are either registered trademarks or trademarks of Microsoft Corporation in the United States and/or other countries.
- “Made for iPod,” and “Made for iPhone” mean that an electronic accessory has been designed to connect specifically to iPod, or iPhone, respectively, and has been certified by the developer to meet Apple performance standards.
Apple is not responsible for the operation of this device or its compliance with safety and regulatory standards. Please note that the use of this accessory with iPod, or iPhone may affect wireless performance. iPhone, iPod, iPod classic, iPod nano, and iPod touch are trademarks of Apple Inc., registered in the U.S. and other countries.
- Lightning is a trademark of Apple Inc.
- This item incorporates copy protection technology that is protected by U.S. patents and other intellectual property rights of Rovi Corporation. Reverse engineering and disassembly are prohibited.
- Font for this product is designed by Ricoh.
- Android is a trademark of Google Inc.
- The Bluetooth® word mark and logos are registered trademarks owned by Bluetooth SIG, Inc. and any use of such marks by JVC KENWOOD Corporation is under license. Other trademarks and trade names are those of their respective owners.

- THIS PRODUCT IS LICENSED UNDER THE AVC PATENT PORTFOLIO LICENSE FOR THE PERSONAL USE OF A CONSUMER OR OTHER USES IN WHICH IT DOES NOT RECEIVE REMUNERATION TO
(i) ENCODE VIDEO IN COMPLIANCE WITH THE AVC STANDARD (“AVC VIDEO”) AND/OR (ii) DECODE AVC VIDEO THAT WAS ENCODED BY A CONSUMER ENGAGED IN A PERSONAL ACTIVITY AND/OR WAS OBTAINED FROM A VIDEO PROVIDER LICENSED TO PROVIDE AVC VIDEO. NO LICENSE IS GRANTED OR SHALL BE IMPLIED FOR ANY OTHER USE. ADDITIONAL INFORMATION MAY BE OBTAINED FROM MPEG LA, L.L.C. SEE [HTTP://WWW.MPEGLA.COM](http://www.mpegla.com)
- Sirius, XM and all related marks and logos are trademarks of Sirius XM Radio Inc. All rights reserved.
- Pandora, the Pandora logo, and the Pandora trade dress are trademarks or registered trademarks of Pandora Media, Inc., used with permission.
- SPOTIFY and the Spotify logo are among the registered trademarks of Spotify AB.
- iHeartRadio® and iHeartAuto™ are trademarks owned by iHeartMedia, Inc. All uses are authorized under license.
- libFLAC
Copyright (C) 2000,2001,2002,2003,2004,2005,2006, 2007,2008,2009 Josh Coalson
Redistribution and use in source and binary forms, with or without modification, are permitted provided that the following conditions are met:
 - Redistributions of source code must retain the above copyright notice, this list of conditions and the following disclaimer.
 - Redistributions in binary form must reproduce the above copyright notice, this list of conditions and the following disclaimer in the documentation

and/or other materials provided with the distribution.

- Neither the name of the Xiph.org Foundation nor the names of its contributors may be used to endorse or promote products derived from this software without specific prior written permission. THIS SOFTWARE IS PROVIDED BY THE COPYRIGHT HOLDERS AND CONTRIBUTORS “AS IS” AND ANY EXPRESS OR IMPLIED WARRANTIES, INCLUDING, BUT NOT LIMITED TO, THE IMPLIED WARRANTIES OF MERCHANTABILITY AND FITNESS FOR A PARTICULAR PURPOSE ARE DISCLAIMED. IN NO EVENT SHALL THE FOUNDATION OR CONTRIBUTORS BE LIABLE FOR ANY DIRECT, INDIRECT, INCIDENTAL, SPECIAL, EXEMPLARY, OR CONSEQUENTIAL DAMAGES (INCLUDING, BUT NOT LIMITED TO, PROCUREMENT OF SUBSTITUTE GOODS OR SERVICES; LOSS OF USE, DATA, OR PROFITS; OR BUSINESS INTERRUPTION) HOWEVER CAUSED AND ON ANY THEORY OF LIABILITY, WHETHER IN CONTRACT, STRICT LIABILITY, OR TORT (INCLUDING NEGLIGENCE OR OTHERWISE) ARISING IN ANY WAY OUT OF THE USE OF THIS SOFTWARE, EVEN IF ADVISED OF THE POSSIBILITY OF SUCH DAMAGE.
- **DIVX**
 - This DivX Certified® device has passed rigorous testing to ensure it plays DivX® video. To play purchased DivX movies, first register your device at vod.divx.com. Find your registration code in the DivX VOD section of your device setup menu. (Page 47)
 - DivX Certified® to play DivX® video, including premium content.
 - DivX®, DivX Certified® and associated logos are trademarks of DivX, LLC and are used under license.

For updated information (the latest Instruction Manual, system updates, new functions, etc.),
please visit the following website:

www.kenwood.com/cs/ce/

pandora[®]

iHeartRADIO

Spotify[®]

DivX[®]

DVD
VIDEO[™]



SiriusXM[®]
READY



Made for
iPod iPhone

DOLBY AUDIO[™]

Bluetooth[®]

MILITARY

Units purchased through the U.S.A. military exchange service overseas may be serviced under warranty in the continental U.S.A. subject to the following conditions.

- 1) The original warranty is in effect.
- 2) Proof of purchase is provided to the servicer.

WARRANTY FOR MILITARY MARKET

JVC KENWOOD Corporation is proud of the quality and workmanship of its audio equipment. This unit has been properly designed, tested and inspected before it was shipped to you. If properly installed and operated in accordance with instructions furnished, it should give you an optimum reliable performance.

WARRANTY PERIOD

This product is warranted for a period of (1) year from the date of the original purchase.

SCOPE OF WARRANTY

Except as specified below, this warranty covers all defects in materials and workmanship of the Kenwood brand products.

During the warranty period, any authorized Kenwood Service Center in the military market listed in the back of this warranty card will provide you free of charge both parts and labor required to correct any defect in materials or workmanship.

The following are not covered by this warranty.

1. Voltage conversions.
2. Periodic check-ups which do not disclose any defect covered by the warranty.
3. Cabinets, grilles, other exterior finishes, bells, tape heads, and other non-durable parts and accessories.
4. Units on which the serial number has been etched, modified or removed.
5. Installation and/or removal charges.
6. Damaged magnetic tapes.
7. House call charges for any repairs.
8. Shipping or delivery charges to or from an authorized Kenwood Service Center.
9. This warranty will not cover any failure that is due to any of the following conditions in accordance with the visual inspection of the authorized Kenwood Service Center:
 - * Improper maintenance or repair, including the installation of parts or accessories that do not conform to the quality and specifications of the original parts.
 - * Misuse, abuse, neglect, unauthorized product modification or failure to follow instructions contained in the Owner's Manual.
 - * Accidental or intentional damages.
 - * Repairs or attempted repairs by an unauthorized agency. (All repairs must be performed at an authorized Kenwood Service Center.)
 - * Damages or deteriorations caused during shipment. (Claims must be presented to the carrier.)
 - * Damages or deteriorations resulting from removal and/or replacement.

PURCHASER'S RESPONSIBILITIES

As the purchaser of a new Kenwood brand product, you are requested to do the following in order to obtain Kenwood warranty service:

1. Retain your sales slip or other evidence of purchase for proving your eligibility for requesting Kenwood warranty service.
2. Make your unit available to an authorized Kenwood Service Center in the military market for inspection and approved warranty service, or ship your unit in its original carton box or equivalent, fully insured and shipping charges prepaid, to the authorized Kenwood Service Center.

LIMITATION OF IMPLIED WARRANTIES

Any and all implied warranties, including warranties of merchantability and fitness for a particular purpose, shall be limited in duration to the length of this warranty.

EXCLUSION OF CERTAIN DAMAGES

KENWOOD's liability for any defective product is limited to the repair or replacement of said product, at our option, and shall not include damages of any kind, whether incidental, consequential or otherwise, except to the extent prohibited by applicable law.

KENWOOD AUTHORIZED SERVICE CENTERS IN MILITARY MARKET

JAPAN:

Yokota
Kenwood Rep.; c/o
Yokota BX, JAAX AAFES-PAC,
APO San Francisco 96328

Zama

Kenwood Rep.; c/o
Zama PX, JAAX AAFES-PAC,
APO San Francisco 96343

Misawa

Kenwood Rep.; c/o
Misawa BX, JAAX AAFES-PAC,
APO San Francisco 96519

Yokosuka

Kenwood Rep.; c/o
A-33, Yokosuka NEX No. 260-010
FPO Seattle 98760

Atsugi

Kenwood Rep.; c/o
Atsugi NEX No. 260-020 FPO Seattle
98767

Iwakuni

Kenwood Rep.; c/o
Marine Corps Exchange, Marine Corps
Air Station,
FPO Seattle 98764

Sasebo

Sasebo NEX:
Navy Exchange 260-040
F.A. Box 115 FPO Seattle 98765

Okinawa

Kenwood Rep.; c/o
OWAX, AAFES-PAC, APO San Francisco
96230

KOREA:

Kenwood Rep.; c/o
KOAX Repair Shop, AAFES-PAC
DD-Camp Market, APO San Francisco
96488

GUAM:

Kenwood Rep.; c/o
Guam NEX No. 230-010,
FPO San Francisco 96630
Kenwood Rep.; c/o
GUAX, AAFES-PAC, APO San Francisco
96334

U.S.A.:

In The Continental U.S.A.
For Nearest Authorized Service Center,
Tel: 1-800-536-9663
www.us.jvckenwood.com

EUROPE:

Please inquire at the military resale
outlets where you bought your
Kenwood products, or
JVCKENWOOD DEUTSCHLAND GMBH:
Konrad-Adenauer Allee 1-11, 61118 Bad
Vilbel, Germany

KENWOOD

Warranty Card

Identification du produit
Modelo do aparelho e número de série
Model number & serial number

Revendeur & cachet
Nome da loja e carimbo
Dealer & stamp

Date d'achat
Data da compra
Purchase date

Nom & adresse du client
Nome e endereço do cliente
Name & address of customer

Attention:

This card and receipt (or invoice) are necessary to purchase a new panel in case of theft or damage.

Attention:

Vous aurez besoin de cette carte et du reçu (ou de la facture) pour acheter un nouveau panneau en cas de vol ou d'endommagement.

Atenção:

Em caso de dano ou perda do painel frontal, este Certificado de Garantia e a Nota Fiscal de compra serão requisitados para a aquisição de um novo painel.

© B46-0824-00/04 (K) (15/11)

Dear Customer,

Thank you for purchasing this Kenwood product. As mentioned in the pages of this booklet, our warranty is only valid in the countries listed. If your country is not listed please contact your retailer for information on warranty procedure, or write to:

JVC KENWOOD Customer Information Center

3-12, Moriyacho, Kanagawa-ku, Yokohama-shi, Kanagawa 221-0022, Japan

Free Manuals Download Website

<http://myh66.com>

<http://usermanuals.us>

<http://www.somanuals.com>

<http://www.4manuals.cc>

<http://www.manual-lib.com>

<http://www.404manual.com>

<http://www.luxmanual.com>

<http://aubethermostatmanual.com>

Golf course search by state

<http://golfingnear.com>

Email search by domain

<http://emailbydomain.com>

Auto manuals search

<http://auto.somanuals.com>

TV manuals search

<http://tv.somanuals.com>