

KENWOOD

DDX6023BT
DDX6053BT
DDX4023BT
DDX4053BT
DDX3023
DDX3053
DDX42BT
DDX35

MONITOR WITH DVD RECEIVER
INSTRUCTION MANUAL

JVC KENWOOD Corporation



Contents

Before use	3
How to reset your unit	3

INTRODUCTIONS

Initial Settings	5
Initial setup	5
Updating the system	6
Setting the security function	7

Component names and functions...8

Setting the clock..... 10

Common operations 11

Turning on the power	11
Turning off the power	11
Adjusting the panel angle	11
Adjusting the volume	11
Putting the unit in standby	12
Turning off the screen	12

Switching screens 13

AV SOURCE OPERATIONS

Selecting the playback source 14

Displaying the source control screen	14
Displaying all sources and items	15
Customizing the <Top Menu> screen	15

Disc operations..... 16

Playing a disc	16
Playable disc types.....	17
Playback operations	18
<DISC Mode> settings	22

USB operations..... 23

Playing a USB device	23
----------------------------	----

Listening to the iPod/iPhone device..... 25

iPod/iPhone playback operations from the unit	26
Selecting an audio/video file from the menu	27
Controlling playback from the iPod/iPhone	27

Using the smartphone — MirrorLink..... 28

Listening to the radio..... 30

Using other external components..... 35

AV-IN	35
Using the external navigation unit	36

Sound adjustment..... 37

Using the sound equalization	37
Adjusting the crossover frequency	38

Changing the display design..... 39

Setting for video playback 41

Picture adjustment	41
Changing the aspect ratio	42
Zooming picture.....	42

Using a rear view camera..... 43

Setting menu items..... 44

Memorizing/recalling the settings.....	48
Locking the settings	48
Adjusting the touch position.....	48

BLUETOOTH OPERATIONS

(Only for DDX6023BT/DDX6053BT/
DDX4023BT/DDX4053BT/DDX42BT)

Information for using Bluetooth® devices 49

Bluetooth operations..... 49

Connecting Bluetooth devices	50
Setting up Bluetooth.....	52
Using the Bluetooth mobile phone	53
Settings for Bluetooth mobile phone.....	58
Using the Bluetooth audio player	59

USING THE REMOTE CONTROLLER

Overview 60

Operations from the remote controller 61

REFERENCE

Maintenance 65

More about this unit 66

Troubleshooting..... 68

Accessories/Installation Procedure 72

Connecting Wires to Terminals..... 74

Connecting a USB device/iPod/iPhone..... 75

Connecting Other Products..... 76

Installing/Removing the Unit..... 77

Specifications 79

KS-UBT1 (USB Bluetooth adapter) 82

Before use

⚠ WARNINGS:

(To prevent accidents and damage)

- DO NOT install any unit or wire any cable in a location where;
 - it may obstruct the steering wheel and gearshift lever operations.
 - it may obstruct the operation of safety devices such as air bags.
 - it may obstruct visibility.
- DO NOT operate the unit while driving. If you need to operate the unit while driving, be sure to look around carefully.
- The driver must not watch the monitor while driving.

⚠ Cautions on the monitor:

- The monitor built in this unit has been produced with high precision, but it may have some ineffective dots. This is inevitable and is not considered defective.
- Do not expose the monitor to direct sunlight.
- Do not operate the touch panel using a ball-point pen or similar tool with the sharp tip. Press the buttons on the touch panel with your finger directly (if you are wearing a glove, take it off).
- When the temperature is very cold or very hot...
 - Chemical changes occur inside, causing malfunction.
 - Pictures may not appear clearly or may move slowly. Pictures may not be synchronized with the sound or picture quality may decline in such environments.

For safety...

- Do not raise the volume level too much, as this will make driving dangerous by blocking outside sounds, and may cause hearing loss.
- Stop the car before performing any complicated operations.

Temperature inside the car...

If you have parked the car for a long time in hot or cold weather, wait until the temperature in the car becomes normal before operating the unit.

■ How to reset your unit

DDX6023BT/DDX6053BT



DDX4023BT/DDX4053BT/DDX3023/DDX3053



DDX42BT/DDX35



If the unit fails to operate properly, press the Reset button. The unit returns to factory settings when the Reset button is pressed (except the registered Bluetooth devices).

How to read this manual:

- Illustrations of DDX6023BT are mainly used for explanation.
- This manual mainly explains operations using the buttons on the monitor panel and touch panel. For operations using the remote controller (RC-DV340: supplied only for DDX6023BT/DDX6053BT), see page 60.
- < > indicates the variable screens/ menus/operations/settings that appear on the touch panel.
- [] indicates the buttons on the touch panel.
- **Indication language:** English indications are used for the purpose of explanation. You can select the indication language from the <Setup> menu. (see page 46)

The displays and panels shown in this manual are examples used to provide clear explanations of the operations. For this reason, they may be different from the actual displays or panels.

Information on Disposal of Old Electrical and Electronic Equipment and Batteries (applicable for EU countries that have adopted separate waste collection systems)



Products and batteries with the symbol (crossed-out wheeled bin) cannot be disposed as household waste.



Old electrical and electronic equipment and batteries should be recycled at a facility capable of handling these items and their waste byproducts.

Pb

Contact your local authority for details in locating a recycle facility nearest to you.

Proper recycling and waste disposal will help conserve resources whilst preventing detrimental effects on our health and the environment.

Notice: The sign "Pb" below the symbol for batteries indicates that this battery contains lead.

The marking of products using lasers



The label is attached to the chassis/case and says that the component uses laser beams that have been classified as Class 1. It means that the unit is utilizing laser beams that are of a weaker class. There is no danger of hazardous radiation outside the unit.



Declaration of Conformity with regard to the EMC Directive 2004/108/EC

Manufacturer:

JVC KENWOOD Corporation
3-12 Moriya-cho, Kanagawa-ku, Yokohama-shi, Kanagawa, 221-0022, Japan

EU Representative's:

Kenwood Electronics Europe BV
Amsterdamseweg 37, 1422 AC UITHOORN,
The Netherlands

For Turkey

Bu ürün 28300 sayılı Resmî Gazete'de yayımlanan Atık Elektrikli ve Elektronik Eşyaların Kontrolü Yönetmeliğe uygun olarak üretilmiştir.

Eski Elektrik ve Elektronik Ekipmanların İmha Edilmesi Hakkında Bilgi (ayrı atık toplama sistemlerini kullanan ülkeleri için uygulanabilir)



Sembollü (üzerinde çarpı işareti olan çöp kutusu) ürünler ev atıkları olarak atılamaz.

Eski elektrik ve elektronik ekipmanlar, bu ürünleri ve ürün atıklarını geri dönüştürebilecek bir tesiste değerlendirilmelidir.

Yaşadığınız bölgeye en yakın geri dönüşüm tesisinin yerini öğrenmek için yerel makamlara müracaat edin.

Uygun geri dönüşüm ve atık imha yöntemi sağlığımız ve çevremiz üzerindeki zararlı etkileri önlerken kaynakların korunmasına da yardımcı olacaktır.

INTRODUCTIONS

Initial Settings

Initial setup

When you power on the unit for the first time or reset the unit, the initial setting screen appears.

- You can also change the settings on the <Setup> screen. (☞ page 44)

1 For DDX6023BT/DDX6053BT:



For DDX4023BT/DDX4053BT/
DDX3023/DDX3053/DDX42BT/
DDX35:



Language	Select the text language used for on-screen information. (☞ page 46) <ul style="list-style-type: none">Set <GUI Language> to display the operation buttons and menu items in the selected language ([Local]: initially selected) or English ([English]).
Angle *2	Adjust the panel angle. (☞ page 11)
AV Input	Select an external component to play — [AV-IN2] or [iPod] (☞ page 46)
NAV I/F Input *1	Select navigation or Mirror Link to use. (☞ page 46)
R-CAM Interrupt	Select [ON] when connecting the rear view camera. (☞ page 46)
Panel Color	Select the color of the buttons on the monitor panel. (☞ page 39)

2 Finish the procedure.



*1 Only for DDX6023BT/DDX6053BT/DDX4023BT/DDX4053BT/DDX3053/DDX42BT/DDX35.

*2 Only for DDX6023BT/DDX6053BT.

Updating the system

You can update the system by connecting a USB device containing the update file.

1 Create an update file, copy it to a USB device, and connect it to the unit.

To connect a USB device, see page 75.

2 On <Top Menu>:



3



4



Application Version	Updates the System application.
DVD Version	Updates the DVD System application.

It may take a while.

If the update has been complete successfully, "Update Completed" appears. Reset the unit.

- If the update has failed, turn the power off and then on, and retry the update.
- Even if you have turned off the power during update, you can restart the update after the power is turned on. The update will be performed from the beginning.

Setting the security function

You can set a security code to protect your receiver system against theft.

■ Registering the security code

1 Display the security code setting screen.

On <Top Menu>:



- To clear the registered security code, perform step 1 and press [CLR] in <Security Code>.

2 Enter a four-digit number (①), then confirm the entry (②).



3 Repeat step 2 to confirm your security code.

Now, your security code is registered.

- When the unit is being reset or disconnected from battery, you are required to enter the security code. Enter the correct security code, then press [Enter].

■ Activating the security function

You can activate security function to protect your receiver system against theft.

On <Setup>:







The security indicator on the monitor panel flashes when the vehicle ignition is off.

To cancel, select [OFF].

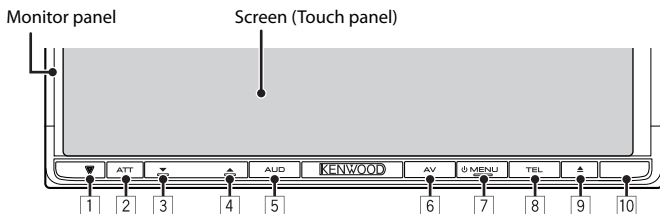
Component names and functions

DDX6023BT/DDX6053BT



- 1 Reset button/Power indicator/Security indicator
 - Resets the unit. (☞ page 3)
 - Lights up while the unit is turned on.
 - Flashes when the security function is activated. (☞ page 7)
- 2 ATT button (Press)
 - Attenuates the sound.V.OFF button (Hold)
 - Turns off/on the screen. (☞ page 12)
- 3 VOLUME  (down) button (☞ page 11)
 - Decreases the volume.
- 4 VOLUME  (up) button (☞ page 11)
 - Increases the volume.
- 5 AUD button (Press)
 - Displays the <Tone> screen. (☞ page 37)R-CAM button (Hold)
 - Displays the picture from the rear view camera.
- 6 AV button (Press)
 - Displays the current source screen.AV OUT button (Hold)
 - Selects the AV source for external monitor or amplifier.
- 7  MENU button
 - Turns off the power. (Hold)
 - Turns on the power. (Press)
 - Displays the <Top Menu> screen. (Press) (☞ page 13)
- 8 TEL button (Press)
 - Displays the <Handsfree> screen. (☞ page 54)VOICE button (Hold)
 - Activates voice dialing. (☞ page 54)
- 9  (Eject) button
 - Ejects the disc (Tilts the monitor panel fully).
 - Opens/Closes the monitor panel.
- 10 Remote sensor

Caution on the volume setting:

Digital devices produce very little noise compared with other sources. Lower the volume before playing these digital sources to avoid damaging the speakers by sudden increase of the output level.

You can change the color of the buttons on the monitor panel. (☞ page 39)

**DDX4023BT/DDX4053BT/
DDX3023/DDX3053**

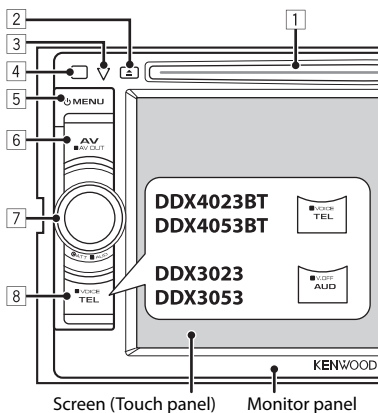

- 1 Loading slot
- 2 ▲ (Eject) button
- Ejects the disc.
- 3 Reset button/Power indicator/Security indicator
- Resets the unit. (☞ page 3)
 - Lights up while the unit is turned on.
 - Flashes when the security function is activated. (☞ page 7)
- 4 Remote sensor
- 5 MENU button
- Turns off the power. (Hold)
 - Turns on the power. (Press)
 - Displays the <Top Menu> screen. (Press) (☞ page 13)
- 6 AV/AV OUT button
- Displays the current source screen. (Press)
 - Selects the AV source for external monitor or amplifier. (Hold)
- 7 **For DDX4023BT/DDX4053BT:**
VOL/ATT/AUD knob (☞ page 11)
- Attenuates the sound. (Press)
 - Adjusts the audio volume. (Turn)
 - Displays the <Tone> screen. (Hold) (☞ page 37)

DDX42BT/DDX35

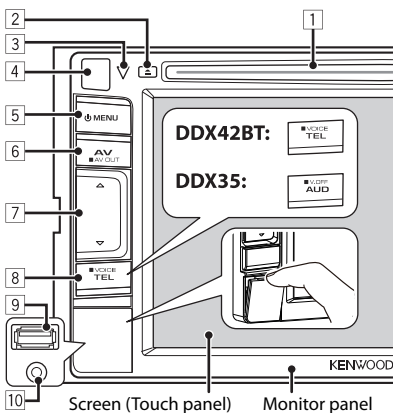

- For DDX3023/DDX3053:**
VOL/ATT knob (☞ page 11)
- Attenuates the sound. (Press)
 - Adjusts the audio volume. (Turn)
- For DDX42BT/DDX35:**
Volume ▲ (up)/ ▽ (down) buttons (☞ page 11)
- Increases/decreases the volume. (Press)
- 8 **For DDX4023BT/DDX4053BT/
DDX42BT:**
TEL/VOICE button
- Displays the <Handsfree> screen. (Press) (☞ page 54)
 - The function of the button when held varies depending on the <TEL Key Long Press> setting (☞ page 47).
- For DDX3023/DDX3053/DDX35:**
AUD/V.OFF button
- Displays the <Tone> screen. (Press) (☞ page 37)
 - The function of the button when held varies depending on the <AUD Key Long Press> setting (☞ page 47).
- 9 **For DDX42BT/DDX35 only:**
USB input terminal
- 10 **For DDX42BT/DDX35 only:**
iPod/AV-IN2 input terminal

Setting the clock

1 Display the <Top Menu> screen.

On the source control screen:



2 Display the <Setup> screen.



3 Display the <Clock> screen.



4 Set the clock time.



NAV*	Synchronizes the clock time with the connected navigation unit.
Radio Data System	Synchronizes the clock time with FM Radio Data System.
OFF	Sets the clock manually. (See below)

When selecting <OFF>:

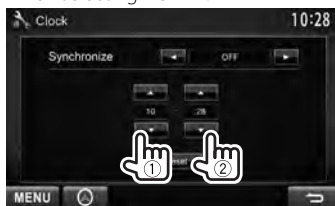

- ① Adjust the hour
- ② Adjust the minute

[Reset]: Sets the minute to "00."

Example:

3:00 – 3:29 → 3:00

3:30 – 3:59 → 4:00

5 Finish the procedure.



* Appears only when the navigation unit is connected.

Common operations

Turning on the power

DDX6023BT/DDX6053BT



DDX4023BT/DDX4053BT/
DDX3023/DDX3053



DDX42BT/DDX35



Turning off the power

DDX6023BT/DDX6053BT



DDX4023BT/DDX4053BT/
DDX3023/DDX3053



DDX42BT/DDX35

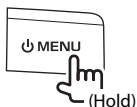

Adjusting the panel angle

(Only for DDX6023BT/DDX6053BT)

You can change the panel angle.

1 Select an angle (0 – 6).



To set the current position as the power off position, select [**Memory**].

Adjusting the volume

To adjust the volume (00 to 35)
DDX6023BT/DDX6053BT



DDX4023BT/DDX4053BT/DDX3023/
DDX3053



DDX42BT/DDX35

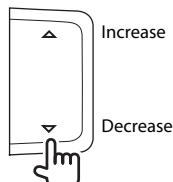

To attenuate the sound

Only for DDX6023BT/
DDX6053BT



Only for DDX4023BT/
DDX4053BT/DDX3023/
DDX3053



The ATT indicator lights up.

To cancel the attenuation, press the same button again.

Putting the unit in standby

1



2

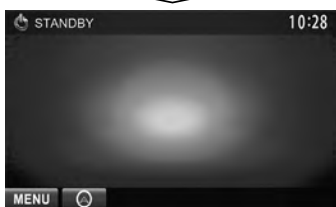

Turning off the screen

DDX6023BT/DDX6053BT

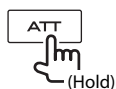

DDX4023BT/
DDX4053BT*1



DDX3023/DDX3053*2



DDX42BT*1



DDX35*2

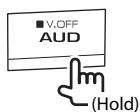

The screen is turned off.

To turn on the screen, press  MENU.

- You can also turn on the screen by touching the display.

*1 This operation works only when <TEL Key Long Press> is set to [V-OFF]. (✎ page 47)

*2 This operation works only when <AUD Key Long Press> is set to [V-OFF]. (✎ page 47)

Switching screens

Source control screen

- Pressing  MENU on the monitor panel also displays **<Top Menu>**.



Displays the navigation screen.*1
( page 36)

*1 Appears only when a navigation unit is connected.

<Top Menu>

- Changes the AV source.
- Displays the **<Setup>** screen.



 page 15

- You can arrange the items to display on the **<Top Menu>** screen on **<Menu Customize>** in **<Display>** setting. ( page 45)

<Setup>

Changes the detailed settings.



Changes the page

Press [] to return to the previous screen.

Touch screen operation

Displays the video control menu while playing a video.

Goes to the previous chapter/track.*2

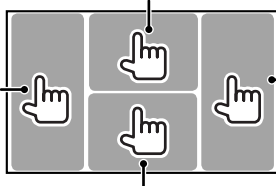

Goes to the next chapter/track.*2

Displays the source control screen while playing a video.

- The operation buttons disappear by touching the screen or when no operation is done for about 5 seconds.

*2 Not available for video from an external component and rear view camera.

AV SOURCE OPERATIONS

Selecting the playback source



- To display all sources and items, see page 15.
- You can change the items (other than **[SETUP]**) to display on the **<Top Menu>** screen. (see page 15)

NAV *1*2 (see page 36)	Displays the navigation screen when a navigation unit is connected.
MirrorLink *2*3 (see page 28)	Displays your smartphone screen on the touch panel.
DISC (see page 16)	Plays a disc.
TUNER (see page 30)	Switches to the radio broadcast.
iPod *4 (see page 25)	Plays an iPod/iPhone.
USB (see page 23)	Plays files on a USB device.
TEL *5 (see page 54)	Displays the phone control screen.
Bluetooth *5 (see page 59)	Plays a Bluetooth audio player.
AV-IN 1/AV-IN 2 *4 (see page 35)	Switches to an external component connected to AV-IN1 and iPod/AV-IN2 input terminals.

*1 When no navigation unit is connected, "No Navigation" appears.

*2 Select an appropriate input setting on **<NAV I/F Input>**. (see page 46).

*3 Only for DDX6023BT/DDX6053BT/DDX4023BT/DDX4053BT/DDX3053/DDX428T/DDX35.

*4 Select an appropriate input setting on **<AV Input>**. (see page 46)

*5 Only for DDX6023BT/DDX6053BT/DDX4023BT/DDX4053BT/DDX428T.

Displaying the source control screen

On video playback screen

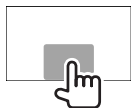

- The operation buttons disappear by touching the screen or when no operation is done for about 5 seconds.

Displaying all sources and items

On <Top Menu>:



DDX6023BT/DDX6053BT/
DDX4023BT/DDX4053BT/DDX42BT



DDX3023/DDX3053/DDX35



Customizing the <Top Menu> screen

You can arrange the items to display on the <Top Menu> screen.

1 On <Top Menu>:



2

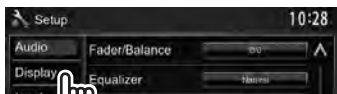

3 Select the position to place the icon (①), then select the item you want to display on the selected position (②).



4 Repeat step 3 to place icons for other items.

Disc operations

Playing a disc

- If a disc does not have a disc menu, all tracks on it will be played repeatedly until you change the source or eject the disc.

■ Inserting a disc

DDX6023BT/DDX6053BT

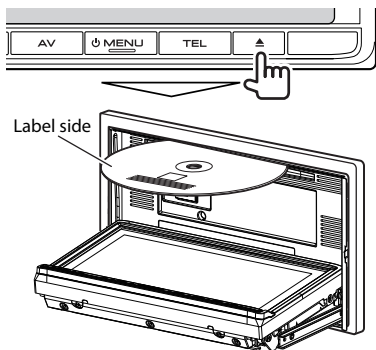

DDX4023BT/DDX4053BT/DDX3023/
DDX3053/DDX42BT/DDX35

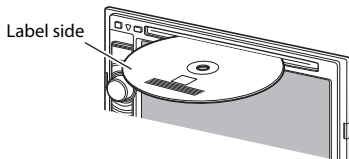

The source changes to **"DISC"** and playback starts.

- The IN indicator lights up while a disc is inserted.
- If "⊘" appears on the screen, the unit cannot accept the operation you have tried to do.
 - In some cases, without showing "⊘", operations will not be accepted.
- When playing back a multi-channel encoded disc, the multi-channel signals are downmixed to stereo.

■ Ejecting a disc

DDX6023BT/DDX6053BT



DDX4023BT/DDX4053BT/DDX3023/
DDX3053



DDX42BT/DDX35

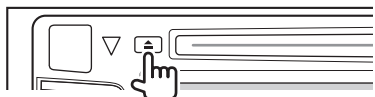

- You can eject a disc when playing another AV source.
- If the ejected disc is not removed within 15 seconds, the disc is automatically inserted again into the loading slot to protect it from dust.

When removing a disc, pull it horizontally.

Closing the monitor panel **(Only for DDX6023BT/DDX6053BT)**

After removing the disc, press ▲ (eject) button again. The monitor panel closes.

Playable disc types

Disc type	Recording format, file type, etc.	Playable
DVD	DVD-Video *1 Region Code: • For DDX6023BT/DDX4023BT/DDX3023/ DDX42BT: 2 • For DDX6053BT/DDX4053BT/DDX3053/ DDX35: 5	✓OK
	DVD-Audio/DVD-ROM	✗NO
DVD Recordable/ Rewritable (DVD-R/-RW *2, +R/+RW *3) • DVD Video: UDF bridge • DVD-VR • DivX/MPEG1/MPEG2/ JPEG/MP3/WMA/WAV/ AAC: ISO 9660 level 1, level 2, Romeo, Joliet	DVD-Video	✓OK
	DVD-VR *4	
	DivX/MPEG1/MPEG2	
	JPEG	
	MP3/WMA/WAV/AAC	
	MPEG4/DVD+VR/DVD-RAM	✗NO
Dual Disc	DVD side	✓OK
	Non-DVD side	✗NO
CD/VCD	DTS-CD/Audio CD/CD Text (CD-DA)	✓OK
	VCD (Video CD)	
	SVCD (Super Video CD)/CD-ROM/CD-I (CD-I Ready)	✗NO
CD Recordable/ Rewritable (CD-R/-RW) • ISO 9660 level 1, level 2, Romeo, Joliet	CD-DA	✓OK
	VCD (Video CD)	
	DivX/MPEG1/MPEG2	
	JPEG	
	MP3/WMA/WAV/AAC	
	MPEG4	✗NO

*1 If you insert a DVD Video disc of an incorrect Region Code, "Region code error" appears on the screen.

*2 DVD-R recorded in multi-border format is also playable (except for dual layer discs). DVD-RW dual layer discs are not playable.

*3 It is possible to play back finalized +R/+RW (Video format only) discs. "DVD" is selected as its disc type when a +R/+RW disc is loaded. +RW double layer discs are not playable.

*4 This unit cannot play back contents protected with CPRM (Content Protection for Recordable Media).

Caution for DualDisc playback

The Non-DVD side of a "DualDisc" does not comply with the "Compact Disc Digital Audio" standard. Therefore, the use of Non-DVD side of a DualDisc on this product may not be recommended.





Playback operations



To display the source control screen,  page 14.

For DVD/DVD-VR/VCD/DivX/MPEG1/MPEG2/JPEG



- DVD Video: Title no./Chapter no.
- DVD-VR: Program no. (or Playlist no.)/Chapter no.*¹
- DivX/MPEG1/MPEG2: Folder no./Track no.
- JPEG: Folder no./File no.
- VCD: Track no.

	Selects playback mode. ( page 21)
	Starts/pauses playback.
	Stops playback.
	<ul style="list-style-type: none">• Selects a chapter/track. (Press)• Reverse/forward search.*⁴ (Hold)

	<ul style="list-style-type: none">• Reverse/forward search during playback.*⁴• Plays back in slow-motion during pause.
[MODE] * ⁵	Enters the <DISC Mode> settings. ( page 22)
[MENU]	Displays the <Top Menu> screen.

- For DivX/MPEG1/MPEG2/JPEG, the following buttons also appear:

	Selects a folder.
---	-------------------

	Displays the folder/track list. ( page 19)
---	--

*¹ To display the Original Program/Playlist screen,  page 20.

*² Does not appear for DVD/DVD-VR/JPEG.

*³ Appears only for DVD/DVD-VR/VCD.

*⁴ Search speed varies depending on the type of disc or file.

*⁵ Does not appear for VCD.

For CD/MP3/WMA/WAV/AAC

While playing, the jacket picture is shown if the file has the tag data including the jacket picture.

- MP3/WMA/WAV/AAC: Folder no./Track no.
- CD: Track no.

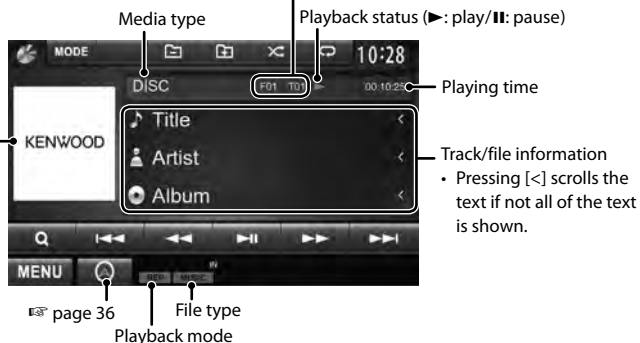

[REPEAT] [SHUFFLE]	Selects playback mode. (page 21)
[SEARCH] *1	Displays the folder/track list. (page below)
[PLAY/PAUSE]	Starts/pauses playback.
[FOLDER] *1	Selects a folder.

[PREV] [NEXT]	Selects a track.
[REVERSE] [FORWARD]	Reverse/forward search.*2
[MODE] *1	Enters the <DISC Mode> settings. (page 22)
[MENU]	Displays the <Top Menu> screen.

*1 Does not appear for CD.

*2 Search speed varies depending on the type of disc or file.

Selecting folder/track on the list

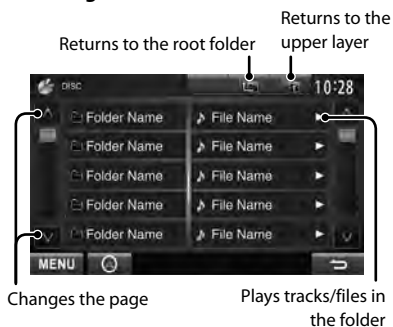

Playing Recordable/Rewritable discs

- This unit can recognize a total of 5 000 files and 250 folders (a maximum of 999 files per folder).
- Use only "finalized" discs.
- This unit can play back multi-session discs; however, unclosed sessions will be skipped while playing.
- Some discs or files may not be played back due to their characteristics or recording conditions.

■ Video menu operations

You can display the video menu screen during video playback.

- Available items on the screen differ depending on the types of the loaded disc and playback files.
- The operation buttons disappear by touching the screen or when no operation is done for about 5 seconds.



- The screen for MPEG1/MPEG2 differs from the above.



ZOOM	Displays the picture size selecting screen. (Ⓜ page 42)
Aspect	Selects the aspect ratio. (Ⓜ page 42)
Picture Adjust	Displays the picture adjustment screen. (Ⓜ page 41)
Audio	Selects the audio type. <ul style="list-style-type: none"> • For DVD-VR: Selects the audio channel (ST: stereo, L: left, R: right).
Subtitle	Selects the subtitle type.
Angle	Selects view angle.
MENU	Displays the disc menu (DVD)/playlist (DVD-VR).
T MENU	Displays the disc menu (DVD)/original program (DVD-VR).
Highlight	Switches to the direct disc menu mode. Press the target item to select. <ul style="list-style-type: none"> • To restore the screen, press AV on the monitor panel.
CUR	Displays the menu/playlist/original program item selecting screen. <ul style="list-style-type: none"> • [▲] [▼] [◀] [▶]: Selects an item. <ul style="list-style-type: none"> – For DivX only [◀] [▶]: Skips back or forward by about 5 minutes. • [ENTER]: Confirms the selection. • [RETURN]: Returns to the previous screen.

Only for VCD

1



2



Direct selecting buttons (see below)

ZOOM	Displays the picture size selecting screen. (see page 42)
Aspect	Selects the aspect ratio. (see page 42)
Picture Adjust	Displays the picture adjustment screen. (see page 41)
MENU	Displays the disc menu.
Audio	Selects the audio channel (ST: stereo, L: left, R: right).
Direct	Displays/hides the direct selecting buttons. (see below)
Return	Displays the previous screen or the menu.

- To select a track directly



- When you enter a wrong number, press [**Direct/CLR**] to delete the last entry.

- To deactivate the PBC function, press [] then the direct selecting buttons to select a track number.

Selecting playback mode

For DVD/DVD-VR

Selects Repeat playback mode



For VCD (without PBC)/CD/DivX/MPEG1/MPEG2/MP3/WMA/WAV/AAC

Selects Repeat playback mode*

Selects Random playback mode*



- * You cannot activate the repeat mode and the random mode at the same time.



- Each time you press the button, the playback mode changes. (The corresponding indicator lights up.)
 - Available items differ depending on the types of loaded disc and playback file.

Indicator	Playback mode
C-REP	Repeats current chapter.
T-REP	Repeats current title/program.
REP	Repeats current track.
FO-REP	Repeats all tracks of the current folder.
RDM	Randomly plays all tracks.
FO-RDM	Randomly plays all tracks of current folder, then tracks of next folders.

To cancel, press the button repeatedly until the indicator disappears.

<DISC Mode> settings



Disc Setup items		Selectable setting/item	Initial: <u>Underlined</u>
For DVD/DVD-VR	Menu Language	Select the initial disc menu language; Initial English (page 67).	
	Subtitle Language	Select the initial subtitle language or erase the subtitle (OFF); Initial English (page 67).	
	Audio Language	Select the initial audio language; Initial English (page 67).	
	Down Mix	When playing back a multi-channel disc, this setting affects the signals reproduced through the front and/or rear speakers. ◆ Dolby Surround : Select this to enjoy multi-channel surround audio with Dolby Surround. ◆ Stereo : Normally select this.	
	Dynamic Range Control	You can change the dynamic range while playing Dolby Digital software. ◆ Wide : Select this to enjoy a powerful sound at a low volume level with its full dynamic range. ◆ Normal : Select this to reduce the dynamic range a little. ◆ Dialog : Select this to reproduce the movie dialog more clearly.	
For discs except VCD/CD	Screen Ratio	Select the monitor type to watch a wide screen picture on the external monitor. ◆ 16:9  ◆ 4:3 LB (Letterbox)  ◆ 4:3 PS (PanScan) 	
For discs containing audio/video/picture files	File Type	Select the playback file type when a disc contains different types of files. ◆ Audio : Plays back audio files. ◆ Still Image : Plays back JPEG files. ◆ Video : Plays back DivX/MPEG1/MPEG2 files. ◆ Audio&Video : Plays back audio files and DivX/MPEG1/MPEG2 files. • For playable file types, (page 17). • If the disc contains no files of the selected type, the existing files are played in the following order: audio, video, then still image.	

USB operations

Playing a USB device

- This unit can play JPEG/DivX/MPEG1/MPEG2/MP3/WMA/WAV/AAC files stored in a USB mass storage class device.
- This unit can recognize a total of 5 000 files and 250 folders (a maximum of 999 files per folder).
- Make sure all important data has been backed up to avoid losing the data.

■ Connecting a USB device

You can connect a USB mass storage class device such as a USB memory, Digital Audio Player etc. to the unit.

- You cannot connect a computer or portable HDD to the USB input terminal.
- To connect a USB device, see page 75.

When a USB device is connected...

The source changes to **"USB"** and playback starts.

- All tracks in the USB device will be played repeatedly until you change the source.

To disconnect the USB device safely

Press **[▲]**, then disconnect the USB device after "No Device" appears.

Cautions:

- This unit may not play back files in a USB device properly when using a USB extension cable.
- USB devices equipped with special functions such as data security functions cannot be used with the unit.
- Do not use a USB device with 2 or more partitions.
- Depending on the shape of the USB devices and connection ports, some USB devices may not be attached properly or the connection might be loose.
- This unit may not recognize a memory card inserted into the USB card reader.
- When connecting with a USB cable, use the USB 2.0 cable.
- The maximum number of characters:
 - Folder names : 50 characters
 - File names : 50 characters
- Avoid using the USB device if it might affect driving safety.
- Do not pull out and connect the USB device repeatedly while "Reading..." is shown on the screen.
- Electrostatic shock at connecting a USB device may cause abnormal playback of the device. In this case, disconnect the USB device then reset this unit and the USB device.
- Operation and power supply may not work as intended for some USB devices.
- Do not leave a USB device in the car, or expose to direct sunlight or high temperature to avoid deformation or damage to the device.

- To display the source control screen, page 14.
- To change settings for video playback, page 20.

• DivX/MPEG1/MPEG2/MP3/WMA/WAV/AAC: Folder no./Track no.
• JPEG: Folder no./File no.

Only for MP3/WMA/WAV/AAC: While playing, the jacket picture is shown if the file has the tag data including the jacket picture.

Playback status
(▶: play/⏸: pause)

Playing time

Track/file information (for MP3/WMA/WAV/AAC)

• Pressing [◀] scrolls the text if not all of the text is shown.

page 36

Playback mode File type

	Selects repeat playback mode. *1*2 • REP : Repeats the current track. • FO-REP : Repeats all tracks in the current folder.		Displays the folder/track list. (page 19)
	Selects random playback mode. *1*2 • RDM : Randomly plays all tracks. • FO-RDM : Randomly plays all tracks in the folder.		Starts/pauses playback.
	Press this button before disconnecting. (page 23)		Selects a track.
			Reverse/forward search.*3
			Selects a folder.
		[MODE]	Enters the <USB Mode> settings. (below)
		[MENU]	Displays the <Top Menu> screen.

- Available items differ depending on the types of playback file.

*1 To cancel random or repeat mode, press the button repeatedly until the indicator disappears.

*2 You cannot activate the repeat mode and the random mode at the same time.

*3 Search speed varies depending on the type of disc or file.

■ <USB Mode> settings

Setting <Screen Ratio>

Select the monitor type to watch a wide screen picture on the external monitor.

16:9	4:3 LB (Letterbox)	4:3 PS (PanScan)

Setting <Drive Select>

Press **[Next]**. Switches between internal and external memory source of the connected device (such as mobile phone).

Setting <File Type>

Audio	Plays back audio files.
Still Image	Plays back JPEG files.
Video	Plays back DivX/MPEG1/MPEG2 files.
Audio&Video	Plays back audio files and DivX/MPEG1/MPEG2 files.

- If the USB device contains no files of the selected type, the existing files are played in the following order: audio, video, then still image.

Listening to the iPod/iPhone device

■ Preparation

- Connect iPod/iPhone. (☞ page 75)
 - When connecting iPhone/iPod touch, turn off App beforehand; otherwise the playback may not be started after connection.
- Use the following cables:
 - **To watch the video and to listen to the music (analog):** USB Audio and Video cable for iPod/iPhone—KCA-iP22F/KCA-iP202 (optional accessory)
 - **To listen to the music (digital):** USB Audio cable for iPod/iPhone—KCA-iP102 (optional accessory)
- Select appropriate input settings on **<AV Input>** according to the connection method (☞ the right column)
- Do not use extension cables.

iPod/iPhone that can be connected to this unit:

Made for

- iPod with video
- iPod classic
- iPod nano (6th Generation)
- iPod nano (5th Generation)
- iPod nano (4th Generation)
- iPod nano (3rd Generation)
- iPod touch (4th Generation)
- iPod touch (3rd Generation)
- iPod touch (2nd Generation)
- iPod touch (1st Generation)
- iPhone 4S
- iPhone 4
- iPhone 3GS
- iPhone 3G
- iPhone

Settings for iPod playback

When the source is "iPod"...

1



2



Audiobooks	Selects the speed of audio books.
Artwork	Shows/hides the iPod artwork.

Setting <AV Input> for iPod/iPhone playback

You can change the setting only when [STANDBY] is selected on <Top Menu>. (☞ page 12)

1 On <Top Menu>:



2



AV-IN2	Select this when connecting the iPod/iPhone using the USB Audio cable for iPod/iPhone.
iPod	Select this when connecting the iPod/iPhone using the USB Audio and Video cable for iPod/iPhone

iPod/iPhone playback operations from the unit

- To display the source control screen, page 14.
- To change settings for video playback, page 20.

Current track number/total track number

Playback status (▶: play/⏸: pause)

While playing, Artwork (the picture displayed on the screen of iPod/iPhone) is shown if the song contains the Artwork.*1

Playing time

Song/video information

- Pressing [<] scrolls the text if not all of the text is shown.

⏸ page 36 Playback mode

[MODE]	Enter the <iPod Mode> settings. (page 25)	[Q]	Displays the audio/video file list. (page 27)
[▶/⏸]	Starts/pauses playback.	[◀◀]	Selects an audio/video file.*3
[↺]	Selects Repeat playback mode.*2	[◀◀]	Reverse/forward search.
	• REP : Functions the same as "Repeat One."	[▶▶]	
[X]	Selects Random playback mode.*2	[APP]	Select to control playback from the iPod/iPhone—iPod/iPhone control mode.*4 (page 27)
	• RDM : Functions the same as "Shuffle Songs."	[MENU]	Displays the <Top Menu> screen.
	• A-RDM : Functions the same as "Shuffle Albums."		

*1 For changing the Artwork display setting, page 25.

*2 To cancel random or repeat mode, press the button repeatedly until the indicator disappears. Not available in iPod control mode. (page 27)

*3 Resume playback is unavailable for video files.

*4 When using iPod with video, you can control playback only from the unit.

- When you turn on this unit, the iPod/iPhone is charged through the unit.
- The text information may not be displayed correctly.

- For some iPod/iPhone models, the performance may be abnormal or unstable during operation. In this case, disconnect the iPod/iPhone device, then check its condition. If the performance is not improved or is slow, reset your iPod/iPhone.
- For the latest compatible list and software version of iPod/iPhone, see: www.kenwood.com/cs/ce/ipod

Selecting an audio/video file from the menu

1

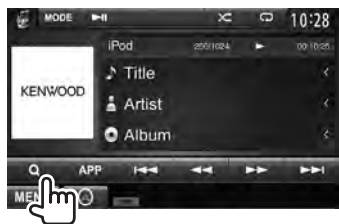

2 Select the menu (audio or video) (1), a category (2), then a desired item (3).

- Select the item in the selected layer until a desired file starts playing.

Audio menu:

Returns to the top layer

Switches between audio (🎵) and video (📺) Returns to the previous layer

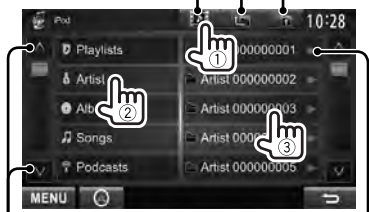

Changes the page

Starts folder playback

Video menu:

Switches between audio (🎵) and video (📺)

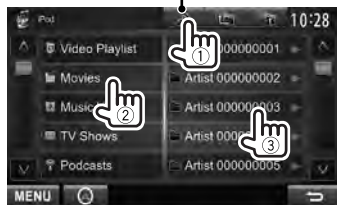

- Available categories differ depending on the type of your iPod/iPhone.

Controlling playback from the iPod/iPhone

You can play back the audio/video files or use App by operating iPod/iPhone itself instead of the unit.



- When you are using Garmin StreetPilot® Onboard, the screen appears. For Garmin StreetPilot® Onboard for iPhone, visit the Garmin web site: www.garmin.com

Garmin App:

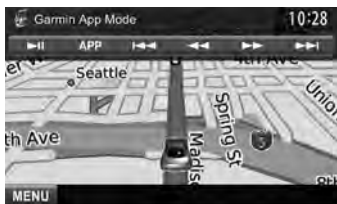

- The current position of your vehicle appears on the map. When the vehicle runs, the map scrolls.
- The screens of the iPhone and unit are not the same.
- To return to the normal mode, press [APP].

Using the smartphone — MirrorLink

(Only for DDX6023BT/DDX6053BT/
DDX4023BT/DDX4053BT/DDX3053/
DDX42BT/DDX35)

You can connect the SMARTPHONE ADAPTER unit (KCA-ML100: optional accessory) to the NAV I/F input terminal, and a smartphone (not supplied) to the SMARTPHONE ADAPTER unit so that you can view the smartphone screen. (☞ page 76)

This product offers the "MirrorLink" function that virtually "mirrors" applications on your smartphone screen directly on the touch panel screen.

- Only MirrorLink-compatible smartphones are available. For compatible smartphones, visit the following website:
<http://kenwood.com/cs/ce/>
- To use MirrorLink, the specialized application must be installed in the compatible smartphone.
- After connecting to a smartphone that is compatible with this unit, the application's home screen will appear on the touch panel screen.
- MirrorLink will be unavailable if you start another application on the smartphone while the specialized application is used. To use the specialized application in MirrorLink again, remove and insert the micro-USB cable connected to the smartphone.

Preparation: Select <MirrorLink> for <NAV I/F Input> while the [STANDBY] is selected on <Top Menu> so that <MirrorLink> is selectable as the source on <Top Menu> (☞ page 46).

Basic MirrorLink operations

- 1 Connect your smartphone to the SMARTPHONE ADAPTER unit (KCA-ML100).

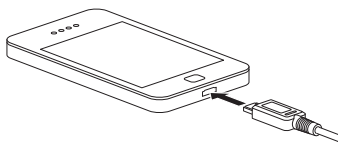





- 2 On <Top Menu>:

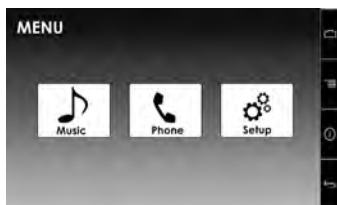

A combination of your smartphone screen and control buttons appears as follows:



	Displays the home screen of your specialized application.
	Displays the menu option of your specialized application.
	Displays the information on the firmware (the version and GPS status). (☞ page 29)
	Returns to the previous screen.

- An unavailable button is disabled.

You can operate the applications on the touch panel screen as well as on your smartphone screen.

■ Updating the firmware

Check the firmware version, and if necessary, update the firmware. (You do not need to connect your smartphone.)

- Do not turn off the power during update.

- 1 Visit the website (<http://kenwood.com/cs/ce/>), download the update data, and save it to the root folder of an SD or SDHC card.**
- 2 Use a ball-point pen or the like to remove the SD cover. While the power is on, insert the SD or SDHC card containing the update data.**

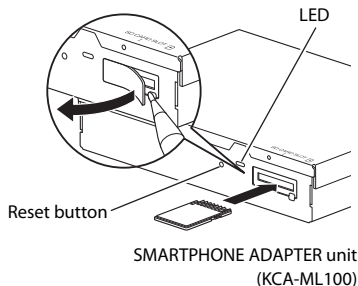

- 3 Press the reset button of the SMARTPHONE ADAPTER unit.**

The update is completed successfully when the green LED lights up. (It takes approximately 30 seconds.) If the update fails, the red LED lights up.

- 4 Remove the SD or SDHC card.**

- 5 Place the SD cover over the slot.**
- 6 Press the reset button of the SMARTPHONE ADAPTER unit.**
- 7 Display the firmware information screen to confirm that it has been updated successfully.** (See page 28)



Listening to the radio

Press to switch the information between Radio Text, Radio Text Plus, and PTY code.

Band no./preset no./the station frequency currently tuned in



ST/MONO indicator (page 36)

AF indicator (page 34)

RDS indicator

LO.S indicator (page 31)

Seek mode indicator

Text information

- Pressing [<] scrolls the text if not all of the text is shown.

Standby reception indicators (page 33)

EON indicator:

Lights up when a Radio Data System station is sending EON signals.

- The ST indicator lights up when receiving an FM stereo broadcast with sufficient signal strength.

[P1] – [P6]	<ul style="list-style-type: none"> Selects a stored station. (Press) Stores the current station. (Hold)
[MODE]	Enters the <Tuner Mode> settings. (page 31)
[TI]	Activates/deactivates TI standby reception mode. (page 33)
[MONO]*	Activates/deactivates monaural mode for better FM reception. (Stereo effect will be lost.) <ul style="list-style-type: none"> The MONO indicator lights up while monaural mode is activated.
[TEXT]	Displays/hides the information of the current station (page 31).

[PTY]*	Enters the PTY search mode. (page 32)
[AM]	Selects AM band.
[FM]	Selects FM band. → FM1 → FM2 → FM3
[SEEK]	Changes the seek mode. <ul style="list-style-type: none"> AUTO1: Auto Search AUTO2: Tunes in stations in memory one after another. MANU: Manual Search
[<<<]	Searches for a station.
[>>>]	The search method differs according to the selected seek mode (above)
[MENU]	Displays the <Top Menu> screen.

* Appears only when FM is selected as the source.

Changing the display information



PS (station name) for FM Radio Data System when PS signal is coming in

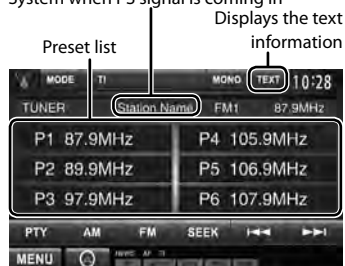

Tuning in FM stations only with strong signals—Local Seek



ON Select this to tune in only to stations with sufficient signal strength. The LOS indicator lights up.

OFF Deactivate the function.

Storing stations in memory

You can preset six stations for each band.

Automatic presetting—AME (Auto Memory)



Local stations with the strongest signals are searched and stored automatically.

Manual presetting

1 Tune in to a station you want to preset. (see page 30)

2 Select a preset number.



The station selected in step 1 is stored.

■ Selecting a preset station



The following features are available only for FM Radio Data System stations.

■ Searching for FM Radio Data System program—PTY Search

You can search for your favorite programs being broadcast by selecting the PTY code.

1



2 Select a PTY code.

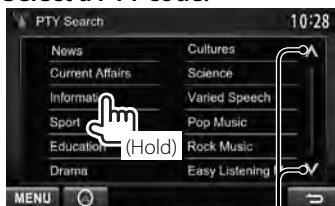

Changes the page

PTY Search starts.

If there is a station broadcasting a program of the same PTY code as you have selected, that station is tuned in.

- Only English/Spanish/French/German/Dutch/Portuguese are available for the text language here. If another language has been selected in **<Language>** (page 46), the text language is set to English.

■ Activating/deactivating TI/News Standby Reception

TI Standby Reception



TI indicator

TI indicator	TI Standby Reception
Lights in white	The unit will temporarily switch to Traffic Information (TI) if available.
Lights in orange	Not yet activated. Tune in to another station providing the Radio Data System signals.
Goes off	Deactivated.

- The volume adjustment for Traffic Information is automatically memorized. The next time the unit switches to Traffic Information, the volume is set to the previous level.

News Standby Reception

1



NEWS indicator

2



00min – 90min	Activates News Standby Reception (the NEWS indicator lights up). Select the period of time to disable interruption.
OFF	Deactivates News Standby Reception.

- The volume adjustment while receiving News is automatically memorized. The next time the unit switches to News, the volume is set to the previous level.

■ Tracing the same program— Network-Tracking Reception

When driving in an area where FM reception is not sufficient enough, this unit automatically tunes in to another FM Radio Data System station of the same network, possibly broadcasting the same program with stronger signals.

When shipped from the factory, Network-Tracking Reception is activated.

To change the Network-Tracking Reception setting

1

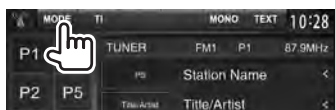

2



AF	Switches to another station. The program may differ from the one currently received (the AF indicator lights up).
AF Reg	Switches to another station broadcasting the same program (the AF indicator lights up).
OFF	Cancels.

- The RDS indicator lights up when the Network-Tracking Reception is activated and an FM Radio Data System station is found.

■ Automatic TI station seek— Auto TP Seek

When traffic information station reception is poor, the unit automatically searches for another station that can be received better.

To activate Auto TP Seek

1

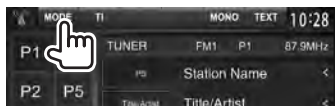

2

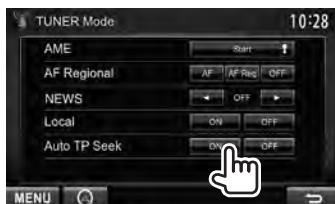

To deactivate, select <OFF>.

Using other external components



AV-IN

To display the source control screen,  page 14.

AV-IN name ( below)



 page 36

[MODE]	Changes the AV-IN name. <ul style="list-style-type: none">• Press [] or [] to select an AV-IN name.• This setting does not affect the source name "AV-IN 1" / "AV-IN 2" displayed on <Top Menu>.
[MENU]	Displays the <Top Menu> screen.



You can connect external components to the AV-IN1 and iPod/AV-IN2 input terminals.

Preparation:

If you want to use "**AV-IN2**", select [**AV-IN2**] for <AV Input> setting. ( page 46)

- No preparation is required for "**AV-IN1**".

- 1 Connect external components to AV-IN1 and iPod/AV-IN2 input terminals.**

To connect external components,  pages 75 and 76.
- 2 Select "AV-IN 1" or "AV-IN 2" as the source.** ( page 14)
- 3 Turn on the connected component and start playing the source.**

Using the external navigation unit

You can connect a navigation unit (KNA-G620T; optional accessory) to the navigation input terminal so that you can view the navigation screen. (☞ page 76)

The navigation guidance comes out of the front speakers even when you listen to an audio source.

Preparation: Select <NAV> for <NAV IF Input> while [STANDBY] is selected on <Top Menu> so that <NAV> is selectable as the source on <Top Menu> (☞ page 46).

■ To view the navigation screen

On <Top Menu>:



or

On any screen:



The navigation screen is activated.

- While the navigation screen is displayed, the touch panel operations are available only for using navigation function.
- The aspect ratio of the navigation screen is fixed to <FULL> regardless of the <Aspect> setting (☞ page 42).

To cancel the navigation screen

DDX4023BT/
DDX4053BT/
DDX6023BT/
DDX6053BT DDX3023/
DDX3053 DDX42BT/
DDX35



■ Settings for navigation unit

1 On <Top Menu>:



2

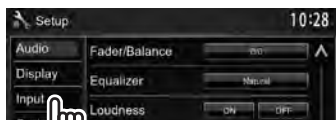

3



Guidance	Select front speakers used for the navigation guidance.
Volume	Adjust the volume of the navigation guidance. (0 to 35)
NAV Mute	Select [ON] to attenuate the sound coming out of speakers other than the front speakers during navigation guidance.
NAV Setup	Press [Enter] to display the setup screen for the navigation unit. See the instruction manual supplied for the navigation unit.

Sound adjustment

Using the sound equalization

- The adjustment is memorized for each source until you adjust the sound again. If the source is a disc, the adjustment is stored for each of the following categories.
 - DVD/DVD-VR/VCD
 - CD
 - DivX/MPEG1/MPEG2/MP3/WMA/WAV/AAC
- **You cannot adjust the sound when the unit is in standby.**

■ Selecting a preset sound mode

1 On <Top Menu>:



2

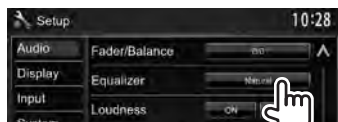

3 Select a sound mode.



Changes the page

■ Storing your own adjustment

Customizing preset sound mode

1 Select a sound mode. (E³)

“Selecting a preset sound mode”

2 Set <SystemQ- Ex> to [OFF] (①), then press [Tone] (②).



3 Adjust the level of each band (①), then select the subwoofer level* (②).

Selects the band

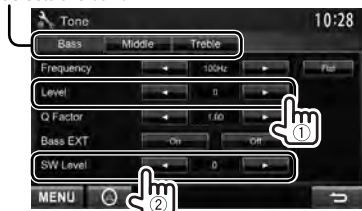

The adjustments are stored and <User> is activated.

- You can also display the <Tone> screen by pressing AUD (only for DDX6023BT/DDX6053BT/DDX3023/DDX3053/DDX35) or VOL/ATT/AUD knob (only for DDX4023BT/DDX4053BT) on the monitor panel.

* Adjustable only when the subwoofer is activated. (E³ page 44)

Adjusting the sound precisely

- 1 Perform steps 1 and 2 of "Selecting a preset sound mode," then...



2



- 3 Adjust the sound of each band.

Selects the band



Flat	Changes level of Bass/Middle/Treble to 0.
Frequency	Selects frequency.
Level	Adjusts level.
Q Factor	Adjusts the width of the frequency.
Bass EXT	Activates/deactivates bass.
SW Level	Adjusts subwoofer level.*

The adjustments are stored and <User> is activated.

* Adjustable only when the subwoofer is activated. (☞ page 44)

Adjusting the crossover frequency

- 1 On <Top Menu>:



2



- 3 Select the item to adjust, then make adjustment.

Adjusts the crossover for front or rear speakers (high pass filter).



Adjusts the crossover for subwoofer (low pass filter).*1

Adjusts the subwoofer level.



Adjusts the cross over frequency.

Selects the phase for the subwoofer.*2

*1 Adjustable only when the subwoofer is activated. (☞ page 44)

*2 Not selectable when <Freq> is set to <Through>.

Changing the display design

You can change the background and panel color.

1 On <Top Menu>:



2

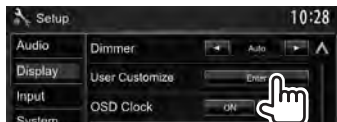
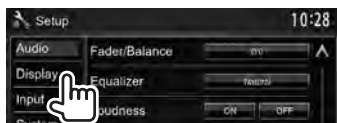

3 Select an item to change ([Background] or [Panel Color]).



4 Select a background/panel color.

To select a background



For setting your favorite scene as the background, see page 40

To select a panel color

Variable color illumination

- Illumination color changes gradually.



For making your own color adjustment, see below

Making your own color adjustment

- You can make your own color adjustment only when <User> is selected.

1



2



3

User color adjuster: You can make your own color adjustment stored in <User>.



Dimmer setting: You can make the color adjustment for each dimmer setting.

Using your favorite scene as the background

While playing a video or JPEG, you can capture an image and use the captured image as a background.

- You cannot capture copyrighted content and images from iPod/iPhone, or videos/JPEG from smartphone.
- When using a JPEG file as the background, make sure that the resolution is 800 x 600 pixels.
- The color of the captured image may look different from that of the actual scene.

1 Play a video or JPEG.

2 Display the <User Customize> screen. (☞ page 39)

3



4 Adjust the image.



- [▶||]* Starts/Pauses playback.
- [▶]* Advances scenes frame-by-frame.
- [🔍] Magnifies the scene. (<OFF>, <Zoom1> – <Zoom3>)
- [▲] [▼] Moves the zooming frame.
- [◀] [▶]

- To cancel the capture screen, press [Cancel].

* Not displayed when playing an external component connected to AV-IN1 or iPod/AV-IN2 input terminal.

5 Capture the image displayed on the screen.



A confirmation message appears. Press [Yes] to store the newly captured image. (The existing image is replaced with the new one.)

- Press [No] to return to the previous screen.

Setting for video playback

You can change the setting for video playback.

Picture adjustment

You can adjust the picture quality.

1 Display the adjustment menu.

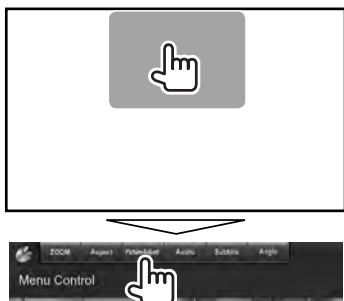

2 Select [DIM ON] (dimmer on) or [DIM OFF] (dimmer off).



3 Adjust the picture (-15 to +15).

- Adjusts the brightness—Bright
- Adjusts the contrast—Contrast
- Adjusts the blackness—Black
- Adjusts the color—Color
- Adjusts the tint*—Tint
- Adjusts the sharpness—Sharpness



* Adjustable only when the incoming signal is NTSC.

Changing the aspect ratio

You can change the aspect ratio for video playback.

1

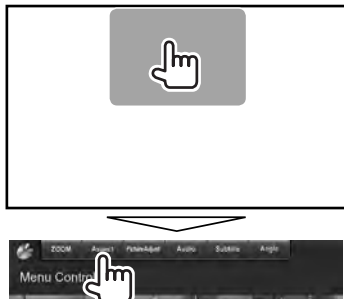

2



	4:3 signal	16:9 signal
FULL*: For 16:9 original pictures		
JUST: For 4:3LB original pictures		
Normal*: For 4:3 original pictures		
Auto:	• For "DISC"/"USB" only: The aspect ratio is automatically selected to match to the incoming signals.	

* While DivX is played back with <Screen Ratio> set to <16:9> (for disc: page 22/ for USB: page 24), the aspect ratio is not set correctly.

Zooming picture

You can zoom the picture (<Zoom1> to <Zoom3>).

- When <Aspect> is set to <JUST> or <Auto> (the left column), the picture is zoomed with the aspect ratio of the <FULL> setting.

1

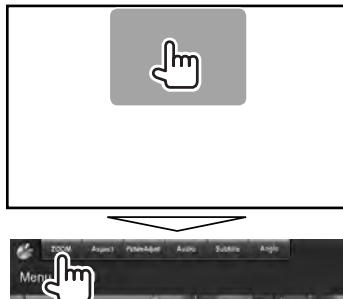

2



[▲] [▼] [◀] [▶]: Moves the zooming frame.

Using a rear view camera

- To use a rear view camera, the REVERSE lead connection is required. For connecting a rear view camera, see page 76.

■ Activating the rear view camera

- 1 On <Top Menu>:



2



To deactivate, select [OFF].

■ Displaying the picture from the rear view camera

The rear view screen is displayed when you shift the gear to the reverse (R) position.

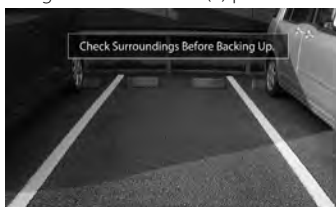

- To erase the caution message, touch the screen.

To display the picture from the rear view camera manually

DDX6023BT/DDX6053BT



DDX4023BT/
DDX4053BT*1



DDX3023/
DDX3053*2

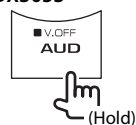

DDX42BT*1



DDX35*2

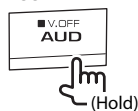

When displaying the picture from the rear view camera manually, you can change the setting of the picture. (see pages 41 and 42)

To erase the rear view screen, press and hold the same button again.

*1 This operation works only when <TEL Key Long Press> is set to <R-CAM>. (see page 47)

*2 This operation works only when <AUD Key Long Press> is set to <R-CAM>. (see page 47)

Setting menu items



- You cannot change <Audio> settings when [STANDBY] is selected on <Top Menu>. (ⓘ page 12)

Menu item	Selectable setting/item	Initial: <u>Underlined</u>
Audio	Fader/Balance	<p>Fader : Adjust the front and rear speaker output balance.</p> <ul style="list-style-type: none"> ◆ F6 to R6; Initial 0 • When using a two-speaker system, set the fader to the center (0). <p>Balance : Adjust the left and right speaker output balance.</p> <ul style="list-style-type: none"> ◆ L6 to R6; Initial 0 <p>Press [▲/▼/◀/▶] or drag [+] to adjust.</p> <ul style="list-style-type: none"> • To clear the adjustment, press [Center].
	Equalizer	<p>Change the sound mode or adjust and store the equalization for each source. (ⓘ page 37)</p> <ul style="list-style-type: none"> ◆ Natural/Rock/Pops/Easy/Top40/Jazz/User
	Loudness	<p>You can activate/deactivate the loudness function.</p> <ul style="list-style-type: none"> ◆ ON : Boost low and high frequencies to produce a well-balanced sound at a low volume level. The LOUD indicator lights up. ◆ OFF : Cancels.
	X'over	Adjust the crossover frequency. (ⓘ page 38)
	Volume Offset	<p>Adjust and store the auto-adjustment volume level for each source. (For discs, the adjustment is stored for each of the following categories: DVD/DVD-VR/VCD, CD, and DivX/MPEG1/MPEG2/MP3/WMA/WAV/AAC.) The volume level will automatically increase or decrease when you change the source.</p> <ul style="list-style-type: none"> ◆ -15 to +6; Initial 0
	Subwoofer	<ul style="list-style-type: none"> ◆ ON : Activates the subwoofer. ◆ OFF : Cancels.
	Speaker Select	<p>Select the size of the connected speaker.</p> <ul style="list-style-type: none"> ◆ Standard/Narrow/Middle/Wide

Menu item		Selectable setting/item	Initial: <u>Underlined</u>
Display	Dimmer	<ul style="list-style-type: none"> ◆ <u>Auto</u> : Dims the screen and button illumination when you turn on the headlights. ◆ ON : Activates dimmer. ◆ OFF : Cancels. ◆ NAV : Activates or deactivates dimmer according to the day/night display setting of the connected navigation unit. 	
	User Customize	Change the display design (background and panel color). (☞ page 39)	
	OSD Clock	<ul style="list-style-type: none"> ◆ ON : Displays the clock while a video source is played back. ◆ OFF : Cancels. 	
	Scroll	<ul style="list-style-type: none"> ◆ <u>ON</u> : Repeats scrolling. ◆ Once : Scrolls the displayed information once. ◆ OFF : Cancels. • Pressing [<] scrolls the text regardless of the setting. 	
	Menu Customize	Change the items to display on the <Top Menu> screen. (☞ page 15)	
	Screen Adjust	Adjust the brightness and blackness of the screen. Select the dimmer mode (<DIM ON> or <DIM OFF>) for adjustment, then change the following settings: <ul style="list-style-type: none"> ◆ Bright : Adjusts brightness (-15 to +15; Initial 0 for <DIM ON>/+15 for <DIM OFF>). ◆ Black : Adjusts blackness (-15 to +15; Initial 0). 	
	Video Output*	Select the color system of the external monitor. <ul style="list-style-type: none"> ◆ <u>NTSC/PAL</u> 	
	Angle Only for DDX6023BT/ DDX6053BT	Adjust the panel angle. (☞ page 11)	

* "Please power off" appears when the setting is changed. Turn off the power, then turn on to enable the change.

Menu item		Selectable setting/item	Initial: <u>Underlined</u>
Input	AV Input	You can determine the use of the iPod/AV-IN2 input terminal. ◆ AV-IN2 : Select to play an AV component connected to the iPod/AV-IN2 input terminal. ◆ iPod : Select when connecting the iPod/iPhone using the USB Audio and Video cable for iPod/iPhone. (☞ page 75)	
	R-CAM Interrupt	◆ ON : Displays the picture from the rear view camera when you shift the gear to the reverse (R) position. ◆ OFF : Select this when no camera is connected.	
	NAV I/F Input *1 Only for DDX6023BT/ DDX6053BT/ DDX4023BT/ DDX4053BT/DDX3053/ DDX42BT/DDX35	◆ NAV : Enables to select " NAV " as the source. ◆ MirrorLink : Enables to select " MirrorLink " as the source.	
	NAV Mute *2	Attenuate the sound coming out of speakers other than the front speakers during navigation guidance.	
	Navigation *3	Change the navigation settings. (☞ page 36)	
System	Language *1	Select the text language used for on-screen information. ◆ English/Spanish/French/German/Italian/Dutch/Russian/Portuguese/Chinese-Simplified/Chinese-Traditional/Thai/Turkish/Arabic/Persian/Hebrew/Greek/Indonesia/Korean ; Initial for DDX6023BT/ DDX4023BT/DDX3023/DDX42BT: English , for DDX6053BT/ DDX4053BT/DDX3053/DDX35: Russian <ul style="list-style-type: none"> For external monitors, only English/Spanish/French/German/Italian/Dutch/Russian/Portuguese are available. If another language has been selected, the text language for external monitors will be set to English. ◆ GUI Language : Select a language (< English > or < Local >: the language selected above) used for displaying operation buttons and menu items.	

*1 "Please power off" appears when the setting is changed. Turn off the power, then turn on to enable the change.

*2 Appears when <NAV I/F Input> is set to [**MirrorLink**].

*3 Appears when <NAV I/F Input> is set to [**NAV**].

Menu item	Selectable setting/item Initial: <u>Underlined</u>
Clock	Adjust the clock time. (☞ page 10)
Beep	◆ ON : Activates the key-touch tone. ◆ OFF : Cancels.
Remote Sensor	◆ ON : Activates the remote sensor. ◆ OFF : Cancels.
SETUP Memory	You can memorize, recall, clear, or lock the settings you have made. (☞ page 48)
Bluetooth Setup Only for DDX6023BT/ DDX6053BT/ DDX4023BT/ DDX4053BT/DDX42BT	Configures settings for using a Bluetooth device, such as connection and other general operations. (☞ page 52)
TEL Key Long Press Only for DDX4023BT/ DDX4053BT/DDX42BT	Assigns the function of the TEL button when held. ◆ V-OFF : Turns off the screen. (☞ page 12) ◆ VOICE : Activates voice dialing. (☞ page 54) ◆ R-CAM : Displays the picture from the rear view camera. (☞ page 43)
AUD Key Long Press Only for DDX3023/ DDX3053/DDX35	Assigns the function of the AUD button when held. ◆ V-OFF : Turns off the screen. (☞ page 12) ◆ R-CAM : Displays the picture from the rear view camera. (☞ page 43)
DivX(R) VOD	This unit has its own Registration Code. Once you have played back a file with the Registration Code recorded, this unit's Registration Code is overwritten for copyright protection. <ul style="list-style-type: none"> • Press [Enter] to display the information. • To return to the previous screen, press [OK].
Security Code	Register the security code for the unit. (☞ page 7)
SI	Activate or deactivate the security function. (☞ page 7)
Serial Number	Displays the serial number.
Touch Panel Adjust	Adjust the touch position of the buttons on screen. (☞ page 48)
System Information	Displays the version information on the software. You can update the software. (☞ page 6)

Memorizing/recalling the settings

You can memorize the settings changed in the <Setup> menu and recall the memorized settings anytime.

- The memorized settings are kept even when the unit is reset.

1 On <Setup>:



2



- To cancel, press [No].

3 Select an operation.



[Recall]: Recalls the memorized settings.

[Memory]: Memorizes the current settings.

[Clear]: Clears the currently memorized settings.

- To cancel, press [Cancel].

Confirmation message appears. Press [Yes].

Locking the settings

You can lock the settings to prevent them from being changed.

-  is shown beside the settings that can be locked.

1 On <Setup>:

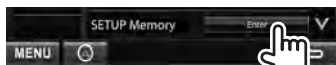

2

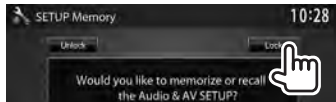

To unlock the setting, press [Unlock].

Adjusting the touch position

You can adjust the touch position on the touch panel if the position touched and the operation performed do not match.

1 On <Setup>:



2 Touch the center of the marks at the lower left and at the upper right as instructed.



- To reset the touch position, press [Reset].
- To cancel the current operation, press [Cancel].

BLUETOOTH OPERATIONS

(Only for DDX6023BT/DDX6053BT/DDX4023BT/DDX4053BT/DDX42BT)

Information for using Bluetooth® devices

- While driving, do not perform complicated operations such as dialing the numbers, using phonebook, etc. When you perform these operations, stop your car in a safe place.
- Some Bluetooth devices may not be connected to this unit depending on the Bluetooth version of the device.
- This unit may not work for some Bluetooth devices.
- Connecting condition may vary depending on circumstances around you.
- When the unit is turned off, the device is disconnected.

Bluetooth operations



Bluetooth is a short-range wireless radio communication technology for the mobile device such as mobile phones, portable PCs, and other devices. The Bluetooth devices can be connected without cables and communicate with each other.

Preparation:

Bluetooth adapter KS-UBT1 has been attached. Connect the microphone (supplied) beforehand. (See pages 74 and 78)

DDX6023BT/DDX6053BT

Bluetooth adapter (KS-UBT1)

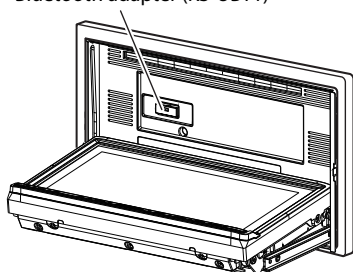

DDX4023BT/DDX4053BT/DDX42BT

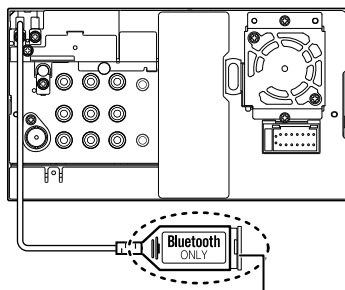

Bluetooth adapter (KS-UBT1)

Connecting Bluetooth devices

■ Registering a new Bluetooth device

When you connect a Bluetooth device to the unit for the first time, make pairing between the unit and the device for registration.

Pairing allows Bluetooth devices to communicate each other.

- The pairing method differs depending on the Bluetooth version of the device.
 - For the device with Bluetooth 2.1: You can pair the device and the unit using SSP (Secure Simple Pairing) which only requests confirmation.
 - For the device with Bluetooth 2.0: You need to enter a PIN code both on the device and unit for pairing.
- Once the pairing is complete, it is registered in the unit even if you reset the unit. Up to 5 devices can be registered in total.
- Only one device for Bluetooth phone and one for Bluetooth audio can be connected at a time.
- To use the Bluetooth function, you need to turn on Bluetooth function of the device.
- To use the registered device, you need to connect the device to the unit. (☞ page 51)

Pairing a Bluetooth device using SSP (for Bluetooth 2.1)

When the Bluetooth device is compatible with Bluetooth 2.1, pairing request is sent from the available device. Confirm the request both on the device and the unit.

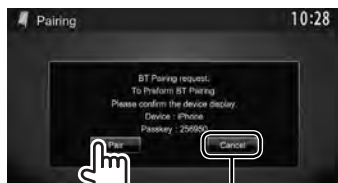

Rejects the request

Pairing a Bluetooth device using a PIN code (for Bluetooth 2.0)

- The maximum digit of the PIN code that can be set is 16.

1 On <Top Menu>:



2 Display the <Bluetooth Setup> screen.

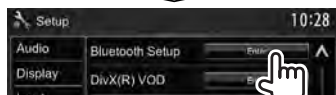
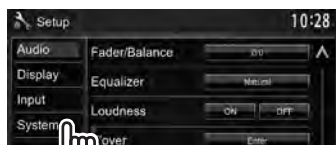

3 Change the PIN code.

- If you skip changing the PIN code, go to step 4.



Deletes last entry

4 Operate the Bluetooth device to complete pairing.

When pairing is complete, the device is listed on <Paired Device List>. To use the paired device, connect the device on <Paired Device List> (see below).

■ Connecting a registered Bluetooth device

1 Display the <Bluetooth Setup> screen. (see page 50)

2

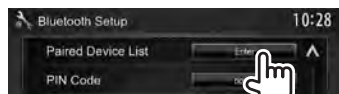

Select the device you want to connect (1), then select the usage of the device ([TEL (HFP)] for mobile phone and [Audio (A2DP)] for Bluetooth audio player) (2).



- Selectable items depend on the device you are operating.
- If you connect a device while another device is connected, the device previously connected is disconnected and the connection for the recently connected is established.

■ Deleting a registered Bluetooth device

1 Display the <Bluetooth Setup> screen. (see page 50)

2

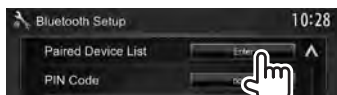

3 Select a device to delete (1), then delete the registration (2).



Confirmation message appears. Press [Yes].

Setting up Bluetooth

You can perform general operations such as connection and initialization through <Bluetooth Setup> on the <Setup> menu.

■ Displaying the <Bluetooth Setup> screen

1 On <Top Menu>:



3

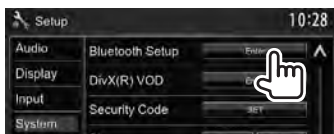

2

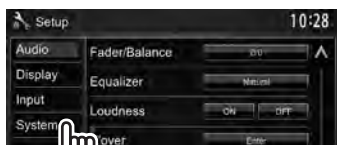

■ <Bluetooth Setup> menu items

Menu items	Selectable setting/item	Initial: <u>Underlined</u>
Paired Device List	Press [Enter] to show the list of the registered devices. You can connect the device or delete the registration (☞ page 51).	
PIN Code	Changes the PIN code of the unit. • Enter a new PIN code, then press [Enter].	
Device Name	Shows the device name to be shown on the Bluetooth device — “KENWOOD BT MM-7U2.”	
Device Address	Shows the device address of the unit.	
Auto Connect	<p>◆ <u>ON</u> : The connection is automatically established with the last connected Bluetooth device when the unit is turned on.</p> <p>◆ OFF : Cancels.</p>	
Bluetooth HF/Audio	<p>Select the speakers used for Bluetooth (both phone and audio player).</p> <p>◆ <u>Front Only</u> : From front speakers only.</p> <p>◆ All : From all speakers.</p>	
Auto Pairing	<p>◆ <u>ON</u> : Establishes the pairing automatically with the connected iOS device (such as iPhone) even if the Bluetooth function is deactivated on the device. (Auto pairing may not work for some devices depending on the iOS version.)</p> <p>◆ OFF : Cancels.</p>	
Initialize	Hold [Enter] to initialize all settings you have made for using Bluetooth mobile phone and Bluetooth audio player.	

Using the Bluetooth mobile phone

■ Receiving a call

When a call comes in...

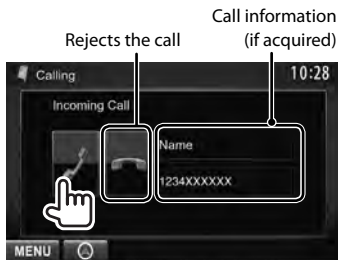

- Phone operation is not available while the picture from the rear view camera is displayed. (☞ page 43)

When <Auto Response> is set to [On]

The unit answers the incoming call automatically. (☞ page 58)

■ Ending a call

While talking...



■ Adjusting the volume of microphone

While talking...





- This adjustment does not affect the volume level of the other sources.
- To adjust the volume of calls/earpiece, use VOLUME \downarrow / \uparrow (for DDX6023BT/DDX6053BT), VOL/ATT/AUD knob (for DDX4023BT/DDX4053BT), or Δ / ∇ (for DDX42BT) on the monitor panel.

■ Switching between handsfree mode and phone mode

While talking...



Each time you press the button, the talking method is switched ( : handsfree mode /  : phone mode).

■ Notifying SMS reception

If the mobile phone is compatible with SMS (Short Message Service), the unit tells you a message has been received. (☞ page 58)

To read a received message, operate the mobile phone after stopping the car in a safe place.

- You cannot read, edit, or send a message through the unit.

■ Adjusting the echo cancel level

While talking...



■ Making a call

1 On <Top Menu>:



2 Select a method to make a call.

Phonebook/Call lists (☞ page 55)

Direct number entry (☞ the right column)



Preset list (For presetting, ☞ page 56)

Voice dialing (☞ the right column)

Direct number entry



Hold: Adds "+"

Presets the entered phone number on the preset list (☞ page 56)

- You can enter up to 32 numbers.

Voice dialing

- Available only when the connected mobile phone has the voice recognition system.



Or

DDX6023BT/
DDX6053BT



DDX4023BT/
DDX4053BT*

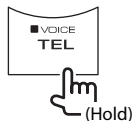

DDX42BT*

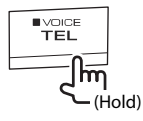

Speak the name you want to call.

To cancel, press [Cancel].

* This operation works only when <TEL Key Long Press> is set to <VOICE>. (☞ page 47)

Using the phonebook/call lists

1



Outgoing	From dialled call list.
Incoming	From received call list.
Missed	From missed call list.
Phonebook	From phonebook. • For copying the phonebook, see page 56.



2



To use the A-Z search on the phonebook

When <Phonebook> is selected, you can search by initial.

1

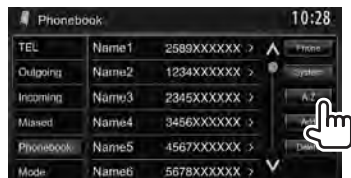

2 Select the initial.

- If the initial is not a letter or number, press **[Others]**.



3 Select a phone number from the list.



To display the details of an entry

When <Phonebook> is selected...

1 Display the details of the desired entry.



2 Select a phone number to call.



■ Presetting the phone numbers

You can preset up to 6 phone numbers.

1 On <Top Menu>:



2 Select an item from phonebook/call lists.



3 Select a phone number.



4 Select a preset number to store into.



- You can also preset the phone number entered on <Direct Number> screen by pressing [Preset]. (☞ page 54)

To delete the preset phone numbers, initialize the settings from <Initialize> in <Bluetooth Setup>. (☞ page 52)

■ Copying the phonebook

You can copy the phonebook memory of a mobile phone into the unit (up to 400 entries).

1 On <Top Menu>:



2



3

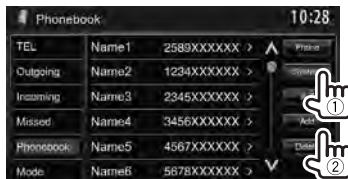

PIN code (initial: 0000)



Numbers of the phonebook entries copied

4 Operate the target mobile phone.

- Refer to the instruction manual supplied with your mobile phone.
- To cancel the transfer, press [Finish].

5 Finish the procedure.



The phonebook memory is copied from the mobile phone.

■ Deleting the phone number entries in the unit

1 Display the phonebook/call list you want to delete. (see page 55)

2



- You cannot delete data when [Phone] is selected.

3 Select the item you want to delete.



Deletes all the numbers/names in the selected item

A confirmation message appears. Press [Yes].

About mobile phones compatible with Phone Book Access Profile (PBAP)

If your mobile phone supports PBAP, you can display the phonebook and call lists on the touch panel screen when the mobile phone is connected.

- Phonebook: up to 5 000 entries
- Dialed calls, received calls, and missed calls: up to 50 entries each

To display the phonebook/call lists of the mobile phone or the unit

Connected mobile phone

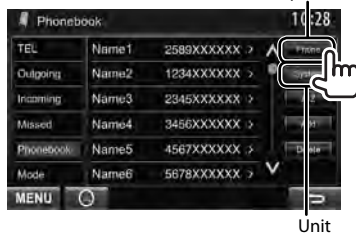

Settings for Bluetooth mobile phone

1 On <Top Menu>:



2



3



Menu items	Selectable setting/item	Initial: <u>Underlined</u>
Phone Device	Shows the connected phone device name.	
Auto Response	<ul style="list-style-type: none"> ◆ ON : The unit answers the incoming calls automatically in 5 seconds. ◆ OFF : The unit does not answer the calls automatically. Answer the calls manually. 	
SMS Notify	<ul style="list-style-type: none"> ◆ ON : The unit informs you of the arrival of a message by ringing and displaying "Receiving Message." ◆ OFF : The unit does not inform you of the arrival of a message. 	
Ring Mode	<ul style="list-style-type: none"> ◆ System : The ring tone set on the unit is used. ◆ Phone : The ring tone set on the mobile phone is used. (This function may not work depending on the mobile phone.) 	
Ring Tone Change	When <Ring Mode> is set to <System>, press [Enter], then select the ring tone for received calls and SMS from <Tone1>, <Tone2>, <Tone3>. <ul style="list-style-type: none"> ◆ Call Tone : Selects the ring tone for phone calls. ◆ Message Tone : Selects the ring tone for SMS. 	

Using the Bluetooth audio player

- To register a new device, [page 50](#).
- To connect/disconnect a device, [page 51](#).



The screenshot shows a car stereo's Bluetooth audio player interface. At the top, it displays 'Bluetooth' and the time '10:28'. Below this, the track information is shown: 'Title', 'Artist', and 'Album', each with a left-pointing arrow for scrolling. The track is currently playing, as indicated by the play button icon. At the bottom, there are playback controls: a 'MENU' button, a play/pause button, and skip buttons. Annotations with arrows point to the play/pause button (labeled 'Playback status*'), the playing time '00:10:28' (labeled 'Playing time*'), the track information area (labeled 'Tag data (current track title/artist name/album title)*'), and the 'MENU' button (labeled 'page 36').

Playback status* (▶: play/⏸: pause)

Playing time*

Tag data (current track title/artist name/album title)*

- Pressing [←] scrolls the text if not all of the text is shown.

[page 36](#)

- The operation buttons, indications and information displayed on the screen differ depending on the connected device.

[▶]	Starts playback.
[⏸]	Pauses.
[◀▶]	<ul style="list-style-type: none">• Selects a track. (Press)• Reverse/forward search* (Hold)
[MENU]	Displays the <Top Menu> screen.

* Available only for the devices compatible with AVRCP 1.3.

USING THE REMOTE CONTROLLER

Overview

DDX6023BT/DDX6053BT:

This unit can be operated using the Remote Controller (RC-DV340) supplied with this unit.

DDX4023BT/DDX4053BT/DDX3023/DDX3053/DDX42BT/DDX35:

Optional Remote Controller KNA-RCDV331 is designed for controlling this unit. Refer to the instruction manual that comes with the remote controller.

⚠ CAUTION

- Put the Remote Controller in a place where it will not move during braking or other operations. A dangerous situation could result, if the Remote Controller falls down and gets wedged under the pedals while driving.
- Do not leave the battery near fire or under direct sunlight. A fire, explosion or excessive heat generation may result.
- Do not recharge, short, break up or heat the battery or place it in an open fire. Such actions may cause the battery to leak fluid. If spilled fluid comes in contact with your eyes or on clothing, immediately rinse with water and consult a physician.
- Place the battery out of reach of children. In the unlikely event that a child swallows the battery, immediately consult a physician.

Battery installation

Use two "AAA"/"R03"-size batteries. Insert the batteries with the + and - poles aligned properly, following the illustration inside the case.

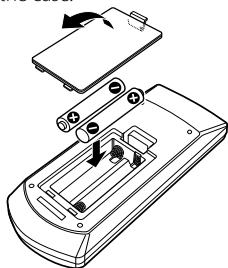

- If the Remote Controller operates only over shorter distances or does not operate at all, it is possible that the batteries are depleted. In such instances, replace the both batteries with new ones.

Remote Controller mode switch

The functions operated from the remote controller differ depending on the position of the mode switch.

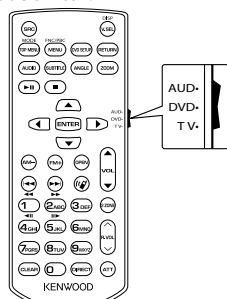

AUD mode: Switch to this mode when controlling a selected source or tuner source, etc.

DVD mode: Switch to this mode when playing DVDs or CDs etc. with the player integrated in this unit.

TV mode: Not used.

- The position of the remote control mode switch is indicated in the title of each mode, e.g., "(AUD mode)".
- When controlling a player that is not integrated in the unit, select "AUD" mode.

Operations from the remote controller

Common operations (AUD mode)

Source switching

Switches to the source to be played.
Hangs up the incoming/current call.

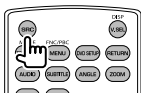

Volume control

Adjusts the volume.

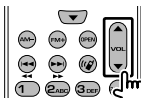

Volume attenuating

Press the key once to lower the volume. Press again to restore the previous volume.

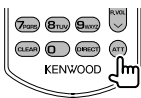

NAV/V.SEL

Switches to the navigation screen.

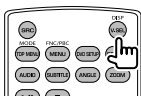

Cursor key

Moves the cursor when displaying menu.

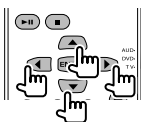

ENTER

Enters options.

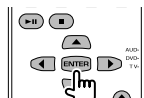

Hands-free communication

When a call comes in, it answers the call.

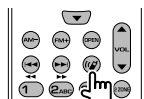

Function

Switches the control screen.

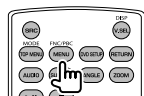

MODE

Switches the aspect ratio.

Aspect ratio changes each time you press this key.

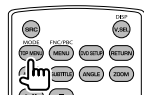

OPEN

(Only for DDX6023BT/DDX6053BT)

Adjusts the panel angle.

The panel angle changes each time you press this key.

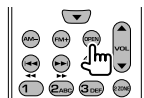

DVD/VCD (DVD mode)

Track search and file search

Selects the track or file to be played.

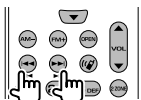

Play/Pause

Pauses the track.

Press again to resume playing.



Stop

Memorizes the last point where the disc stopped.



Direct search

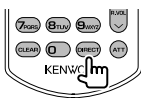

Pressing this key switches the features that can be searched directly.

DVD-VIDEO

Chapter number
Title number
Cancel

DVD-VR

Chapter number
Program/Playlist
Cancel

VCD 1.X, VCD 2.X (PBC OFF)

Track number
Cancel

VCD 2.X (PBC ON)

Track number
Cancel

Once you have switched to the direct search feature, specify the search number from the numeric keypad, and then press [ENTER] key.

Numeric keypad

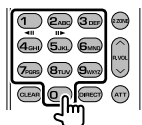

- Specify the number to search in direct search.
- Press **1** **2ABC** to fast forward/backward. Switches the fast forward/backward speed each time you press this key.
- Press **1** **2ABC** to slow forward/backward during pause.

DVD Top Menu

Returns to the DVD top menu.

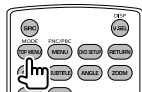

DVD Menu

Displays the DVD menu.

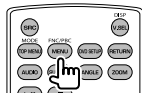

SUBTITLE

Switches the subtitle language.

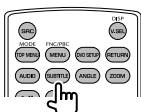

ZOOM

Switches the zoom ratio each time you press this key.

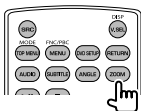

Picture Angle

Switches the picture angle each time you press this key.

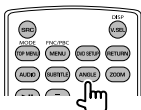

AUDIO

Switches the voice language each time you press this key.



Music Disc/Audio file/Video file/ Picture file (AUD mode)

Folder search

Selects the folder to be played.



Track search and file search

Selects the track or file to be played.

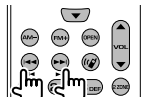

Play/Pause

Pauses the track.

Press again to resume playing.



Direct search

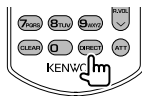

Pressing this key switches the features that can be searched directly.

Music Disc

Track number

Cancel

Audio files in DVD/CD disc

Folder number

File number

Cancel

Once you have switched to the direct search feature, specify the search number from the numeric keypad, and then press [ENTER] key.

Numeric keypad

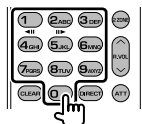

- Specify the number to search in direct search.

Radio (AUD mode)

Band switching

Switches to bands received by the unit.

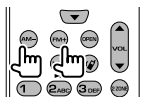

Station selection

Switches to broadcast stations received by the unit.

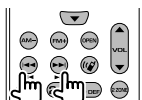

Seek mode switching

Switches the Seek mode (AUTO1, AUTO2, MANU).



Direct tuning

After pressing this key, use the keypad to specify the broadcast station you wish to receive.

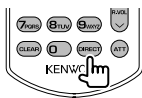

Example: 92.1MHz (FM)



Example: 810kHz (AM)



Numeric keypad

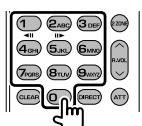

- To use preset tuning, press the number of a programmed broadcast station. (1) – (6) (Pres)
- Press the direct tuning key first, then specify the frequency of the station to receive.

iPod (AUD mode)

Music/Video search

Selects the music/video to be played.

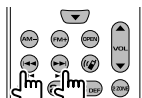

Play/Pause

Pauses the music/video.

Press again to resume playing.



USB (AUD mode)

Folder search

Selects the folder to be played.

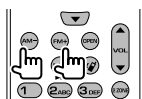

File search

Selects the file to be played.

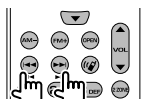

Play/Pause

Pauses the file.

Press again to resume playing.



Maintenance

Caution on cleaning the unit

Do not use any solvent (for example, thinner, benzine, etc.), detergent, or insecticide. This may damage the monitor or the unit.

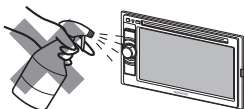

Recommended cleaning method:

Gently wipe the panel with a soft, dry cloth.

Moisture condensation

Moisture may condense on the lens inside the unit in the following cases:

- After starting the heater in the car.
 - If it becomes very humid inside the car.
- Should this occur, the unit may malfunction. In this case, eject the disc and leave the unit turned on for a few hours until the moisture evaporates.

How to handle discs

When removing a disc from its case,

press down the center holder of the case and lift the disc out, holding it by the edges.



- Always hold the disc by the edges. Do not touch its recording surface.

When storing a disc in its case, gently insert the disc around the center holder (with the printed surface facing up).

- Make sure to store discs in their cases after use.

To keep discs clean

A dirty disc may not play correctly. If a disc does become dirty, wipe it with a soft cloth in a straight line from center to edge.



- Do not use any solvents (for example, conventional record cleaner, spray, thinner, benzine, etc.) to clean discs.

To play new discs

New discs may have some rough spots around the inner and outer edges. If such a disc is used, this unit may reject the disc.



To remove these rough spots, rub the edges with a pencil or ball-point pen, etc.

Do not use the following discs:

8 cm CD



Warped disc



Sticker and sticker residue



Stick-on label



Unusual shape



C-thru Disc (semi-transparent disc)



Transparent or semi-transparent parts on its recording area



More about this unit

■ File playback

Playing DivX files

- This unit can play back DivX files with the extension code <.divx>, <.div>, or <.avi> (regardless of the letter case—upper/lower).
- Audio stream should conform to MP3 or Dolby Digital.
- The file encoded in the interlaced scanning mode may not be played back correctly.

Playing MPEG1/MPEG2 files

- This unit can play back MPEG1/MPEG2 files with the extension code <.mpg>, <.mpeg>, or <.mod>.
- The stream format should conform to MPEG system/program stream. The file format should be MP@ML (Main Profile at Main Level)/SP@ML (Simple Profile at Main Level)/MP@LL (Main Profile at Low Level).
- Audio streams should conform to MPEG1 Audio Layer-2 or Dolby Digital.

Playing JPEG files

- This unit can play back JPEG files with the extension code <.jpg> or <.jpeg>.
- This unit can play back JPEG files that are at 32 x 32 to 8 192 x 7 680 resolution. It may take time to display the file depending on its resolution.
- This unit can play back baseline JPEG files. Progressive JPEG files or lossless JPEG files cannot be played.

We bear no responsibility for any loss of data in an iPod/iPhone and USB mass storage class device while using this unit.

Playing MP3/WMA/WAV/AAC files

- This unit can play back files with the extension code <.mp3>, <.wma>, <.wav>, or <.m4a> (regardless of the letter case—upper/lower).
- This unit can play back the files meeting the conditions below:
 - Bit rate:
 - MP3: 8 kbps – 320 kbps
 - WMA: 5 kbps – 320 kbps
 - AAC: 16 kbps – 320 kbps
 - Sampling frequency:
 - 8 kHz – 48 kHz (for MP3/WMA)
 - 44.1 kHz (for WAV)
 - 32 kHz – 48 kHz (for AAC)
- This unit can show ID3 Tag Version 1.0/1.1/2.2/2.3/2.4 (for MP3).
- This unit can also show WAV/WMA/AAC Tag.
- This unit can play back files recorded in VBR (variable bit rate).
- Files recorded in VBR have a discrepancy in elapsed time indication.
- This unit cannot play back the following files:
 - MP3 files encoded with MP3i and MP3 PRO format.
 - MP3 files encoded with Layer 1/2.
 - WMA files encoded with lossless, professional, and voice format.
 - WMA files which are not based upon Windows Media® Audio.
 - WMA/AAC files copy-protected with DRM.
 - AAC files encoded by using any other application than iTunes.
 - AAC files copy-protected with FairPlay (except those stored on an iPod).
 - Files which have the data such as AIFF, ATRAC3, etc.

■ Sound signals emitted through the rear terminals

Through the analog terminals (Speaker out/Front Preout/Rear Preout)

2-channel signal is emitted. When playing multi-channel encoded disc, multi-channel signals are downmixed.

■ Language codes (for DVD/DivX language selection)

Code	Language	Code	Language	Code	Language	Code	Language
AA	Afar	GL	Galician	MI	Maori	SO	Somali
AB	Abkhazian	GN	Guarani	MK	Macedonian	SQ	Albanian
AF	Afrikaans	GU	Gujarati	ML	Malayalam	SR	Serbian
AM	Ameharic	HA	Hausa	MN	Mongolian	SS	Siswati
AR	Arabic	HI	Hindi	MO	Moldavian	ST	Sesotho
AS	Assamese	HR	Croatian	MR	Marathi	SU	Sundanese
AY	Aymara	HU	Hungarian	MS	Malay (MAY)	SW	Swahili
AZ	Azerbaijani	HY	Armenian	MT	Maltese	TA	Tamil
BA	Bashkir	IA	Interlingua	MY	Burmese	TE	Telugu
BE	Byelorussian	IE	Interlingue	NA	Nauru	TG	Tajik
BG	Bulgarian	IK	Inupiak	NE	Nepali	TH	Thai
BH	Bihari	IN	Indonesian	NO	Norwegian	TI	Tigrinya
BI	Bislama	IS	Icelandic	OC	Occitan	TK	Turkmen
BN	Bengali, Bangla	IW	Hebrew	OM	(Afan) Oromo	TL	Tagalog
BO	Tibetan	JA	Japanese	OR	Oriya	TN	Setswana
BR	Breton	JI	Yiddish	PA	Panjabi	TO	Tonga
CA	Catalan	JW	Javanese	PL	Polish	TR	Turkish
CO	Corsican	KA	Georgian	PS	Pashto, Pushto	TS	Tsonga
CS	Czech	KK	Kazakh	QU	Quechua	TT	Tatar
CY	Welsh	KL	Greenlandic	RM	Rhaeto-Romance	TW	Twi
DZ	Bhutani	KM	Cambodian	RN	Kirundi	UK	Ukrainian
EL	Greek	KN	Kannada	RO	Rumanian	UR	Urdu
EO	Esperanto	KO	Korean (KOR)	RW	Kinyarwanda	UZ	Uzbek
ET	Estonian	KS	Kashmiri	SA	Sanskrit	VI	Vietnamese
EU	Basque	KU	Kurdish	SD	Sindhi	VO	Volapuk
FA	Persian	KY	Kirghiz	SG	Sangho	WO	Wolof
FI	Finnish	LA	Latin	SH	Serbo-Croatian	XH	Xhosa
FJ	Fiji	LN	Lingala	SI	Singhalese	YO	Yoruba
FO	Faroese	LO	Laothian	SK	Slovak	ZU	Zulu
FY	Frisian	LT	Lithuanian	SL	Slovenian		
GA	Irish	LV	Latvian, Lettish	SM	Samoan		
GD	Scots Gaelic	MG	Malagasy	SN	Shona		

Troubleshooting

What appears to be trouble is not always serious. Check the following points before calling a service center.

- For operations with the external components, refer also to the instructions supplied with the adapters used for the connections (as well as the instructions supplied with the external components).

■ If the following messages appear

General

Message	Remedy/Cause
"No Signal"	<ul style="list-style-type: none">• Start the playback on the external component connected to AV-IN1 or iPod/AV-IN2 input terminal.• Check the cords and connections.• Signal input is too weak.
<ul style="list-style-type: none">• "Miswiring DC Offset Error"• "Warning DC Offset Error"	A speaker cord has shorted or it has come in to contact with the car chassis. Wire or insulate the speaker cord as appropriate, then reset the unit. (☞ pages 3 and 74).
"Parking off"	No playback picture is shown when the parking brake is not engaged.
"Authorization Error"	Check whether the connected iPod/iPhone is compatible with this unit. (☞ page 25)
"USB Device Error"	<ul style="list-style-type: none">• The USB power voltage is abnormal.• Turn off and turn on the unit.• Connect another USB device.
"Panel Mecha Error"	The panel does not work properly. Reset the unit.
"No Navigation"	No navigation unit is connected.

Bluetooth (Only for DDX6023BT/DDX6053BT/DDX4023BT/DDX4053BT/DDX42BT)

Message	Remedy/Cause
"No BT Dongle"	The Bluetooth adapter (KS-UBT1) is removed.
"Connection Error"	The device is registered but the connection has failed. Connect the registered device. (☞ page 51)
"Please Wait..."	The unit is preparing to use the Bluetooth function. If the message does not disappear, turn off and turn on the unit, then connect the device again (or reset the unit).
"No Voice Device"	The connected mobile phone does not have the voice recognition system.
"No Data"	No phonebook data is contained in the connected Bluetooth phone.
"Initialize Error"	The unit has failed to initialize the Bluetooth module. Try the operation again.
"Dial Error"	Dialing has failed. Try the operation again.
"Hung Up Error"	The call has not ended yet. Park your car, and use the connected mobile phone to end the call.
"Pick Up Error"	The unit has failed to receive a call.

■ If there seems to be a problem

	Symptom	Remedy/Cause
General	No sound comes out of the speakers.	<ul style="list-style-type: none"> Adjust the volume to the optimum level. Check the cords and connections.
	No picture is displayed on the screen.	Turn on the screen. (☞ page 12)
	The unit does not work at all.	Reset the unit. (☞ page 3)
	The remote controller* does not work.	Replace the battery.
TUNER	AME automatic presetting does not work.	Store stations manually. (☞ page 31)
	Static noise while listening to the radio.	Connect the aerial firmly.
Disc in general	<ul style="list-style-type: none"> Recordable/Rewritable discs cannot be played back. Tracks on the Recordable/Rewritable discs cannot be skipped. 	<ul style="list-style-type: none"> Insert a finalized disc. Finalize the discs with the component which you used for recording.
	Playback does not start.	The format of files is not supported by the unit.
	No picture appears on the external monitor.	<ul style="list-style-type: none"> Connect the video cord correctly. Select the correct input on the external monitor.
DivX/MPEG1/MPEG2/ JPEG/MP3/WMA/WAV/AAC	Disc cannot be played back.	<ul style="list-style-type: none"> Record the tracks using a compliant application on the appropriate discs. (☞ page 17) Add appropriate extension codes to the file names.
	Tracks are not played back as you have intended them to play.	Playback order may differ from the one played back using other players.
AV-IN1/ AV-IN2	No picture appears on the screen.	<ul style="list-style-type: none"> Turn on the video component if it is not on. Connect the video component correctly. When "AV-IN2" is selected as the source, set <AV Input> to [AV-IN].

* For DDX4023BT/DDX4053BT/DDX3023/DDX3053/DDX42BT/DDX35, purchase KNA-RCDV331 separately.

	Symptom	Remedy/Cause
iPod/iPhone	No sound comes out of the speakers.	<ul style="list-style-type: none"> • Disconnect the iPod/iPhone, then connect it again. • Select another source and then reselect "iPod".
	The iPod/iPhone does not turn on or does not work.	<ul style="list-style-type: none"> • Check the connecting cable and its connection. • Update the firmware version. • Charge the battery. • Check whether the iPod/iPhone control mode is correctly selected. (☞ page 27) • Reset the iPod/iPhone.
	Sound is distorted.	Deactivate the equalizer either on this unit or the iPod/iPhone.
	A lot of noise is generated.	Turn off (uncheck) the "VoiceOver" feature of the iPod. For details, visit < http://www.apple.com >.
	No operations are available when playing back a track containing Artwork.	Operate the unit after the Artwork is loaded. (☞ page 25)
	Sound does not synchronize with the video.	Select < iPod > for < AV Input >. (☞ page 46)
	<ul style="list-style-type: none"> • Videos cannot be played. • No sound of videos comes out. 	<ul style="list-style-type: none"> • Connect USB Audio and Video cable KCA-iP202/ KCA-iP22F. Other cables cannot be used. • Select <iPod> for <AV Input>. (☞ page 46)
USB	"Reading..." keeps flashing on the screen.	Turn off the power and on again.
	While playing a track, sound is sometimes interrupted.	The tracks are not properly copied into the USB device. Copy tracks again, and try again.

	Symptom	Remedy/Cause
Bluetooth (only for DDX6023BT/DDX6053BT/ DDX4023BT/DDX4053BT/DDX42BT)	Phone sound quality is poor.	<ul style="list-style-type: none"> Reduce the distance between the unit and the Bluetooth mobile phone. Move the car to place where you can get a better signal reception.
	The sound is interrupted or skipped while using a Bluetooth audio player.	<ul style="list-style-type: none"> Reduce the distance between the unit and the Bluetooth audio player. Disconnect the device connected for Bluetooth phone. Turn off, then turn on the unit. (When the sound is not yet restored) connect the player again.
	The connected audio player cannot be controlled.	Check whether the connected audio player supports AVRCP (Audio Video Remote Control Profile).
	Bluetooth device does not detect the unit.	<ul style="list-style-type: none"> Check whether the Bluetooth adapter (KS-UBT1) is inserted correctly. Search from the Bluetooth device again.
	The unit does not make pairing with the Bluetooth device.	<ul style="list-style-type: none"> For the device compatible with Bluetooth2.1: Register the device by using a PIN code. (page 50) For the device compatible with Bluetooth 2.0: Enter the same PIN code for both the unit and target device. If the PIN code of the device is not indicated on its instructions, try "0000" or "1234."
	Echo or noise occurs.	Adjust the microphone unit position.
	The unit does not respond when you try to copy the phonebook to the unit.	You may have tried to copy the same entries (as stored) to the unit.

Accessories/Installation Procedure

Accessories

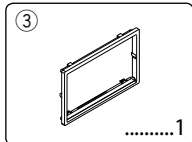
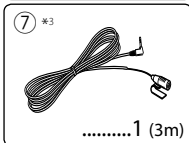
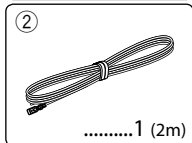
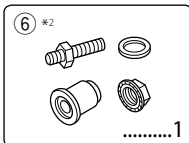
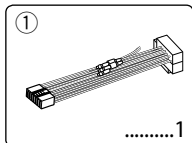

*1 DDX4023BT/
DDX4053BT/
DDX3023/DDX3053/
DDX42BT/DDX35 only.

*2 DDX6023BT/
DDX6053BT only.

*3 DDX6023BT/
DDX6053BT/
DDX4023BT/
DDX4053BT/DDX42BT
only.

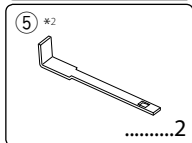
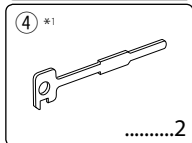

- 6 Connect the wiring harness connector to the unit.
- 7 Install the unit in your car.
- 8 Reconnect the \ominus battery.
- 9 Press the reset button.
- 10 Perform the Initial Setup.

⚠ WARNING

- If you connect the ignition wire (red) and the battery wire (yellow) to the car chassis (ground), you may cause a short circuit, that in turn may start a fire. Always connect those wires to the power source running through the fuse box.
- Do not cut out the fuse from the ignition wire (red) and the battery wire (yellow). The power supply must be connected to the wires via the fuse.



- Mounting and wiring this product requires skills and experience. For best safety, leave the mounting and wiring work to professionals.
- Make sure to ground the unit to a negative 12V DC power supply.
- Do not install the unit in a spot exposed to direct sunlight or excessive heat or humidity. Also avoid places with too much dust or the possibility of water splashing.
- Do not use your own screws. Use only the screws provided. If you use the wrong screws, you could damage the unit.
- If the power is not turned ON ("Miswiring DC Offset Error", "Warning DC Offset Error" is displayed), the speaker wire may have a short-circuit or touched the chassis of the vehicle and the protection function may have been activated. Therefore, the speaker wire should be checked.
- If your car's ignition does not have an ACC position, connect the ignition wires to a power source that can be turned on and off with the ignition key. If you connect the ignition wire to a power source with a constant voltage supply, such as with battery wires, the battery may be drained.
- Only for DDX6023BT/DDX6053BT: If the console has a lid, make sure to install the unit so that the faceplate will not hit the lid when closing and opening.

Installation Procedure

- 1 To prevent a short circuit, remove the key from the ignition and disconnect the \ominus battery.
- 2 Make the proper input and output wire connections for each unit.
- 3 Connect the speaker wires of the wiring harness.
- 4 Take Connector B on the wiring harness and connect it to the speaker connector in your vehicle.
- 5 Take Connector A on the wiring harness and connect it to the external power connector on your vehicle.

- If the fuse blows, first make sure the wires are not touching to cause a short circuit, then replace the old fuse with one with the same rating.
- Insulate unconnected wires with vinyl tape or other similar material. To prevent a short circuit, do not remove the caps on the ends of the unconnected wires or the terminals.
- Connect the speaker wires correctly to the terminals to which they correspond. The unit may be damaged or fail to work if you share the \ominus wires or ground them to any metal part in the car.
- When only two speakers are being connected to the system, connect the connectors either to both the front output terminals or to both the rear output terminals (do not use one from each). For example, if you connect the \oplus connector of the left speaker to a front output terminal, do not connect the \ominus connector to a rear output terminal.
- After the unit is installed, check whether the brake lamps, blinkers, wipers, etc. on the car are working properly.
- Mount the unit so that the mounting angle is 30° or less.
- Do not press hard on the panel surface when installing the unit to the vehicle. Otherwise scars, damage, or failure may result.
- This unit has the cooling fan to decrease the internal temperature. Do not mount the unit in a place where the cooling fan of the unit is blocked. Blocking these openings will prevent the cooling of the internal temperature and result in malfunction.

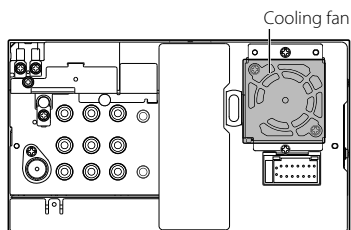

⚠ CAUTION

Install this unit in the console of your vehicle.

Do not touch the metal part of this unit during and shortly after the use of the unit. Metal part such as the heat sink and enclosure become hot.

DDX6023BT/DDX6053BT only

- 1 Before installation, remove the screws.

Do not use the removed screws for installation.

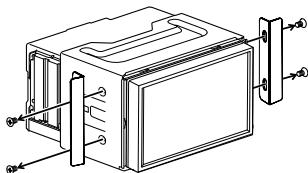

- 2 Detach the sleeve using the two extraction keys (5) then slide off the mounting sleeve.

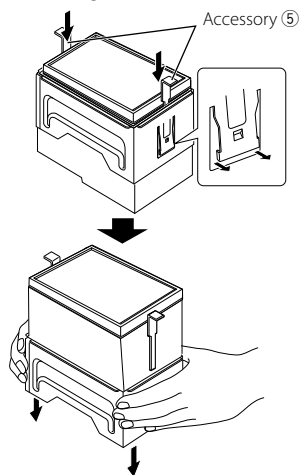

DDX4023BT/DDX4053BT/DDX42BT only

- Install the Bluetooth adapter (KS-UBT1) besides the place enclosed by the metal.

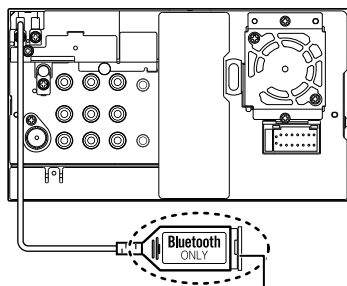

Bluetooth adapter (KS-UBT1)

Connecting Wires to Terminals

Bluetooth Microphone (Accessory ⑦)
DDX6023BT/DDX6053BT/DDX4023BT/
DDX4053BT/DDX42BT only

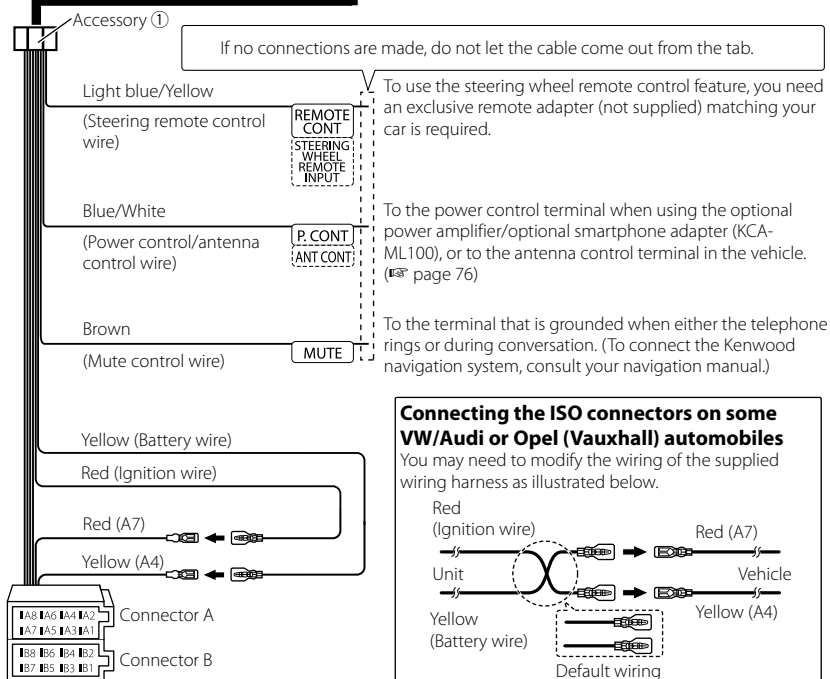
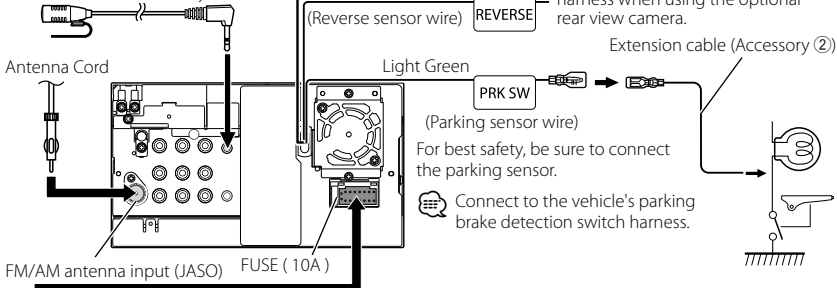

Pin	Colour and functions	
A4	Yellow	Battery
A5	Blue/White	Power Control
A6	Orange/White	Dimmer
A7	Red	Ignition (ACC)
A8	Black	Earth (Ground) Connection

Pin	Colour and functions	
B1/B2	Purple ⊕ / Purple/Black ⊖	Rear Speaker (Right)
B3/B4	Gray ⊕ / Gray/Black ⊖	Front Speaker (Right)
B5/B6	White ⊕ / White/Black ⊖	Front Speaker (Left)
B7/B8	Green ⊕ / Green/Black ⊖	Rear Speaker (Left)

Connecting a USB device/iPod/iPhone

For DDX6023BT/DDX6053BT

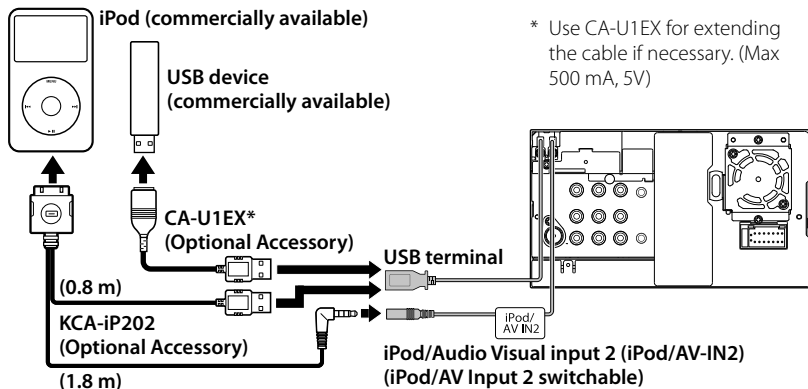

For DDX4023BT/DDX4053BT

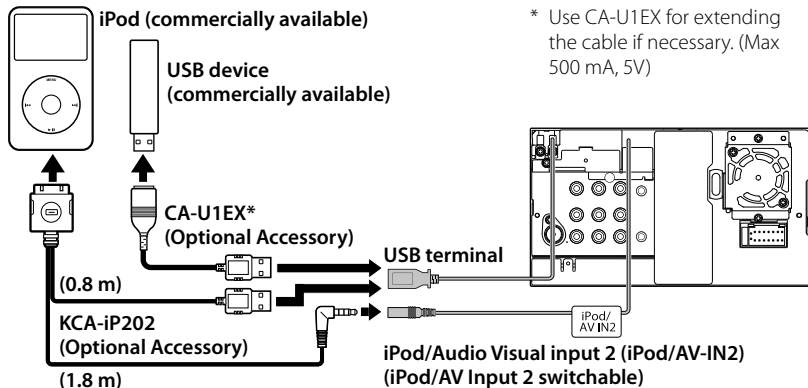

For DDX42BT/DDX35

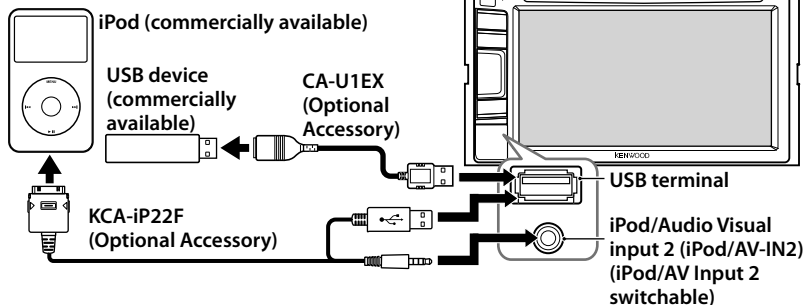

Connecting Other Products

Navigation System (Optional Accessory)



Navigation units that can be connected to this unit (as of December, 2012): KNA-G620T
For latest information, access the www.kenwood.com/cs/ce/.

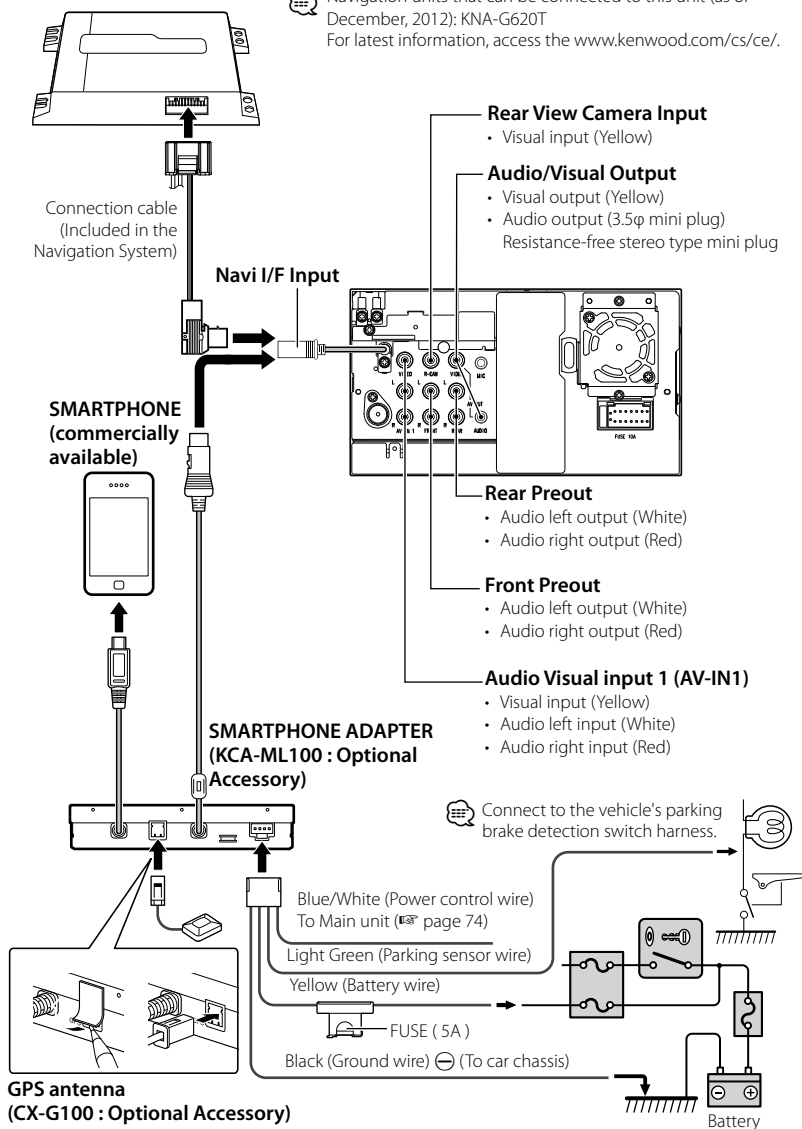

Installing/Removing the Unit

Installing the Trim Plate

- 1 Attach accessory ③ to the unit.

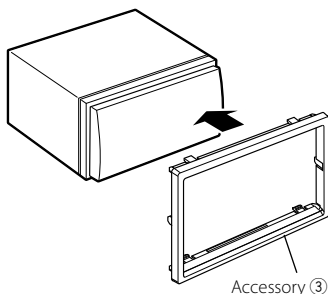

Installing the Unit

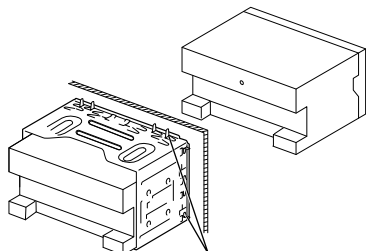

Bend the tabs of the mounting sleeve with a screwdriver or similar utensil and attach it in place.

For more stable attachment the unit (DDX6053BT/ DDX6023BT only)

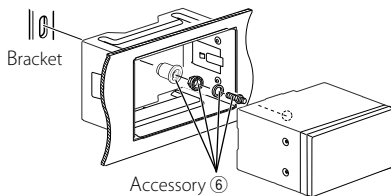

- Make sure that the unit is installed securely in place. If the unit is unstable, it may malfunction (eg, the sound may skip).

Removing the Trim Plate (DDX4023BT/DDX4053BT/ DDX3023/DDX3053/ DDX42BT/DDX35 only)

- 1 Engage the catch pins on the extraction key ④ and remove the two locks on the lower part. Lower the frame and pull it forward as shown in the figure.

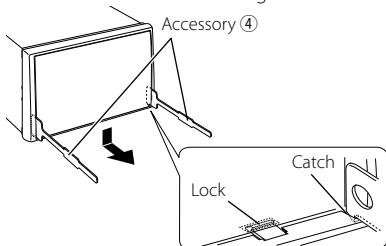

- The frame can be removed from the top side in the same manner.
- 2 When the lower part is removed, remove the upper two locations.

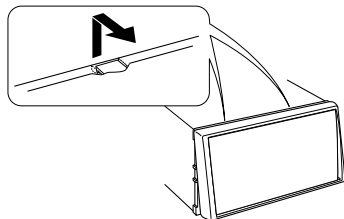

Removing the Unit (DDX4023BT/DDX4053BT/ DDX3023/DDX3053/ DDX42BT/DDX35 only)

• For removing DDX6023BT/DDX6053BT, see page 73.

- 1 Remove the trim plate by referring to the removal procedure in the section "Removing the Trim Plate".
- 2 Insert the two extraction keys (4) deeply into the slots on each side, as shown.

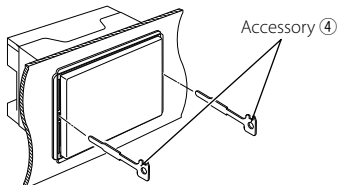

- 3 Lower the extraction key toward the bottom, and pull out the unit halfway while pressing towards the inside.

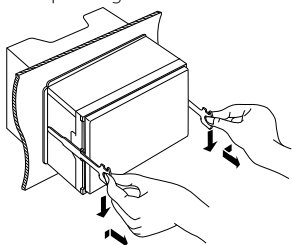

• Be careful to avoid injury from the catch pins on the removal tool.

- 4 Pull the unit all the way out with your hands, being careful not to drop it.

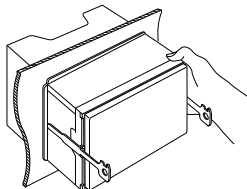

Installing the Microphone Unit (DDX6023BT/ DDX6053BT/ DDX4023BT/ DDX4053BT/DDX42BT only)

- 1 Check the installation position of the microphone (accessory 7).
- 2 Remove oil and other dirt from the installation surface.
- 3 Install the microphone.
- 4 Wire the microphone cable up to the unit with it secured at several positions using tape or the like.



• Install the microphone as far as possible from the mobile phone.

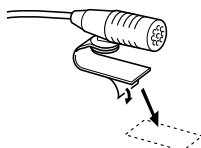
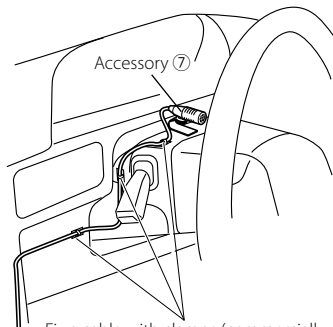

Peel the release coated paper of double-face adhesive tape to fix on the place shown above.



Adjust the direction of the microphone to the driver.

Specifications

Monitor section

Picture Size

- : 6.95 inches (diagonal) wide
156.6 mm (W) × 81.6 mm (H)
(DDX6023BT/DDX6053BT)
- : 6.1 inches (diagonal) wide
136.2 mm (W) × 72 mm (H)
(DDX4023BT/DDX4053BT/DDX3023/
DDX3053/DDX42BT/DDX35)

Display System

- : Transparent TN LCD panel

Drive System

- : TFT active matrix system

Number of Pixels

- : 1,152,000 (800H × 480V × RGB)

Effective Pixels

- : 99.99%

Pixel Arrangement

- : RGB striped arrangement

Back Lighting

- : LED

DVD player section

D/A Converter

- : 24 bit

Audio Decoder

- : Linear PCM/Dolby Digital/dts/MP3/
WMA/AAC/WAV

Video Decoder

- : MPEG1/MPEG2/DivX

Wow & Flutter

- : Below Measurable Limit

Frequency Response

- : Sampling frequency;
96 kHz: 20 Hz – 22,000 Hz
48 kHz: 20 Hz – 22,000 Hz
44.1 kHz: 20 Hz – 20,000 Hz

Total Harmonic Distortion

- : 0.010% (1 kHz)

S/N Ratio (dB)

- : 99 dB (DVD-Video 96 kHz)

Dynamic Range

- : 98 dB (DVD-Video 96 kHz)

Disc Format

- : DVD-Video/DVD-VR/VIDEO-CD/CD-DA

Sampling frequency

- : 44.1/48/96 kHz

Quantifying Bit Number

- : 16/20/24 bit

USB interface section

USB Standard

- : USB 2.0 Full Speed

File System

- : FAT 16/32

Maximum Power Supply Current

- : DC 5 V $\overline{\text{max}}$ 1 A

D/A Converter

- : 24 Bit

Video Decoder

- : MPEG1/MPEG2/DivX

Audio Decoder

- : MP3/WMA/AAC/WAV (Linear PCM)

Bluetooth section

(DDX6023BT/DDX6053BT/ DDX4023BT/DDX4053BT/ DDX42BT)

Technology

- : Bluetooth 2.1 + EDR

Frequency

- : 2.402 GHz – 2.480 GHz

Output Power

- : +4 dBm (MAX), 0 dBm (AVE), Power
Class 2

Maximum Communication range

- : Line of sight approx. 10m

Profile

- : HFP (Hands Free Profile),
OPP (Object Push Profile),
PBAP (Phonebook Access Profile),
A2DP (Advanced Audio Distribution
Profile),
AVRCP (Audio/Video Remote Control
Profile),
GAP (Generic Access Profile),
SDP (Service Discovery Profile),

FM tuner section

Frequency Range (50 kHz)	: 87.5 MHz – 108.0 MHz
Usable Sensitivity (S/N: 26 dB)	: 0.7 μ V/75 Ω
Quieting Sensitivity (S/N: 46 dB)	: 1.6 μ V/75 Ω
Frequency Response (\pm 3.0 dB)	: 30 Hz – 15 kHz
S/N Ratio (dB)	: 65 dB (MONO)
Selectivity (\pm 400 kHz)	: \geq 65 dB
Stereo Separation	: 35 dB (1 kHz)

LW tuner section

Frequency Range (9 kHz)	: 153 kHz – 279 kHz
Usable Sensitivity	: 45 μ V

MW tuner section

Frequency Range (9 kHz)	: 531 kHz – 1611 kHz
Usable Sensitivity	: 25 μ V

Video section

Color System of External Video Input	: NTSC/PAL
External Video Input Level (RCA/mini jack)	: 1 V _{p-p} /75 Ω
External Audio Max Input Level (RCA/mini jack)	: 2 V/25 k Ω
Video Output Level (RCA jack)	: 1 V _{p-p} /75 Ω
Audio Output Level (mini jack)	: 1.2 V/10 k Ω
Analog RGB input	: 0.7 V _{p-p} /75 Ω

Audio section

Maximum Power (Front & Rear)	: 50 W \times 4
Full Bandwidth Power (Front & Rear) (PWR DIN 45324, +B=14.4V)	: 30 W \times 4
Preout Level (V)	: 4 V/10 k Ω
Preout Impedance	: \leq 600 Ω
Speaker Impedance	: 4 Ω – 8 Ω
Tone	
Bass:	100 Hz \pm 8 dB
Middle:	1 kHz \pm 8 dB
Treble:	12.5 kHz \pm 8 dB

General

Operating Voltage	: 14.4 V (10.5 V – 16 V allowable)
Maximum Current Consumption	: 10 A
Dimensions (W \times H \times D)	
:	182 \times 111 \times 160 mm (DDX6023BT/DDX6053BT)
:	182 \times 112 \times 163 mm (DDX4023BT/DDX4053BT/DDX3023/ DDX3053/DDX42BT/DDX35)
Operational Temperature Range	: -10°C – +60°C
Weight	
:	2.5 kg (DDX6023BT/DDX6053BT)
:	2.1 kg (DDX4023BT/DDX4053BT)
:	2.0 kg (DDX3023/DDX3053/DDX42BT/ DDX35)

- Although the effective pixels for the liquid crystal panel is given as 99.99% or more, 0.01% of pixels may not light or may light incorrectly.
- Specifications are subject to change without notice.

- “DVD Logo” is a trademark of DVD Format/Logo Licensing Corporation registered in the US, Japan and other countries.
- The “AAC” logo is a trademark of Dolby Laboratories.
- Microsoft and Windows Media are either registered trademarks or trademarks of Microsoft Corporation in the United States and/or other countries.
- Manufactured under license from Dolby Laboratories. Dolby and the double-D symbol are trademarks of Dolby Laboratories.
- Manufactured under license under U.S. Patent Nos: 5,956,674; 5,974,380; 6,487,535 & other U.S. and worldwide patents issued & pending. DTS, the Symbol, & DTS and the Symbol together are registered trademarks & DTS 2.0 Channel is a trademark of DTS, Inc. Product includes software. © DTS, Inc. All Rights Reserved.
- “Made for iPod,” and “Made for iPhone” mean that an electronic accessory has been designed to connect specifically to iPod, or iPhone, respectively, and has been certified by the developer to meet Apple performance standards. Apple is not responsible for the operation of this device or its compliance with safety and regulatory standards. Please note that the use of this accessory with iPod or iPhone may affect wireless performance.
iPod, iPod classic, iPod nano, and iPod touch are trademarks of Apple Inc., registered in the U.S. and other countries.
- iTunes is a trademark of Apple Inc.
- DivX®, DivX Certified® and associated logos are trademarks of Rovi Corporation or its subsidiaries and are used under license.
ABOUT DIVX VIDEO: DivX® is a digital video format created by DivX, LLC, a subsidiary of Rovi Corporation. This is an official DivX Certified® device that plays DivX video. Visit divx.com for more information and software tools to convert your files into DivX videos.
ABOUT DIVX VIDEO-ON-DEMAND: This DivX Certified® device must be registered in order to play purchased DivX Video-on-Demand (VOD) movies. To obtain your registration code, locate the DivX VOD section in your device setup menu. Go to vod.divx.com for more information on how to complete your registration.
- This item incorporates copy protection technology that is protected by U.S. patents and other intellectual property rights of Rovi Corporation. Reverse engineering and disassembly are prohibited.
- MirrorLink Certified™, the Design Only™ Certification Logo, MirrorLink™ and the MirrorLink™ Logo are certification marks and trademarks of the Car Connectivity Consortium LLC. Unauthorized use is strictly prohibited.

KS-UBT1 (USB Bluetooth adapter)

Instruction Manual

⚠ CAUTION

Changes or modifications not approved by us could void the user's authority to operate the equipment.

- This adapter has been designed exclusively for use with Kenwood car receivers. Do not use this adapter with any other car receiver.
- The Bluetooth® word mark and logos are registered trademarks owned by Bluetooth SIG, Inc. and any use of such marks by JVC KENWOOD Corporation is under license. Other trademarks and trade names are those of their respective owners.

Specifications

Bluetooth Version:	Bluetooth Ver. 2.1 +EDR
Power Class:	Class2 Radio
Service Area:	10 m (10.9 yd)
USB Standards:	USB V1.1 (Full Speed)
Power Consumption:	54.3 mA/5 V (max.)
Dimensions (L x W x H):	15 mm x 19 mm x 5.6 mm (5/8" x 3/4" x 1/4")

Keep the Bluetooth adapter inserted when using the Bluetooth function.

When the adapter is removed, store it in a safe place.

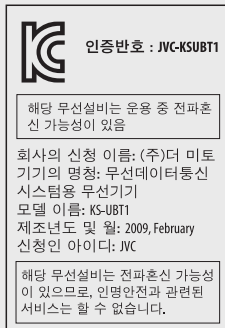
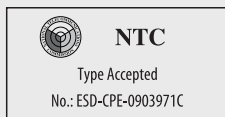

Distributor name: JVC KENWOOD DO BRASIL COMERCIO DE ELETRONICOS LTDA
CNPJ of distributor: JVC KENWOOD DO BRASIL COMERCIO DE ELETRONICOS LTDA
Manufacturer: JVC KENWOOD Corporation
Model no.: KS-UBT1
Brand: JVC



0168-12-5373



(01)07898929117502

"Este equipamento opera em caráter secundário, isto é, não tem direito à proteção contra interferência prejudicial, mesmo de estações do mesmo tipo, e não pode causar interferência a sistemas operando em caráter primário."



Approved by TRA

MTC:OFICIO No 8396-2008-MTC/29

CONATEL certificate No: 001516

SUBTEL: 30234/DFRS00045/F-49

Complies with
IDA Standards
DB102150

"This telecommunication equipment conforms to NTC technical requirement"

23260/SDPPI/2012
2354

TEC/WR/1/MOD-08/02/135.APR 08

URSEC 365/FR/2010

CNC 16-9371

COFETEL : RCPJVKS12-0646



Declaration of Conformity with regard to the R&TTE Directive 1999/5/EC

Manufacturer:

JVC KENWOOD Corporation

3-12 Moriya-cho, Kanagawa-ku, Yokohama-shi, Kanagawa, 221-0022, Japan

EU Representative's:

Kenwood Electronics Europe BV

Amsterdamseweg 37, 1422 AC UITHOORN, The Netherlands

English

Hereby, JVC KENWOOD declares that this unit KS-UBT1 is in compliance with the essential requirements and other relevant provisions of Directive 1999/5/EC.

Français

Par la présente JVC KENWOOD déclare que l'appareil KS-UBT1 est conforme aux exigences essentielles et aux autres dispositions pertinentes de la directive 1999/5/CE.

Par la présente, JVC KENWOOD déclare que ce KS-UBT1 est conforme aux exigences essentielles et aux autres dispositions de la directive 1999/5/CE qui lui sont applicables.

Deutsch

Hiermit erklärt JVC KENWOOD, dass sich dieser KS-UBT1 in Übereinstimmung mit den grundlegenden Anforderungen und den anderen relevanten Vorschriften der Richtlinie 1999/5/EG befindet. (BMW)

Hiermit erklärt JVC KENWOOD die Übereinstimmung des Gerätes KS-UBT1 mit den grundlegenden Anforderungen und den anderen relevanten Festlegungen der Richtlinie 1999/5/EG. (Wien)

Nederlands

Hierbij verklaart JVC KENWOOD dat het toestel KS-UBT1 in overeenstemming is met de essentiële eisen en de andere relevante bepalingen van richtlijn 1999/5/EG.

Bij deze verklaart JVC KENWOOD dat deze KS-UBT1 voldoet aan de essentiële eisen en aan de overige relevante bepalingen van Richtlijn 1999/5/EC.

Italiano

Con la presente JVC KENWOOD dichiara che questo KS-UBT1 è conforme ai requisiti essenziali e alle altre disposizioni pertinenti stabilite dalla direttiva 1999/5/CE.

Español

Por medio de la presente JVC KENWOOD declara que el KS-UBT1 cumple con los requisitos esenciales y cualesquiera otras disposiciones aplicables o exigibles de la Directiva 1999/5/CE.

Português

JVC KENWOOD declara que este KS-UBT1 está conforme com os requisitos essenciais e outras disposições da Directiva 1999/5/CE.

Polska

JVC KENWOOD niniejszym oświadcza, że KS-UBT1 spełnia zasadnicze wymogi oraz inne istotne postanowienia dyrektywy 1999/5/EC.

Český

JVC KENWOOD tímto prohlašuje, že tento KS-UBT1 je ve shodě se základními požadavky a dalšími příslušnými ustanoveními směrnice 1999/5/ES.

Magyar

Alulírott, JVC KENWOOD, kijelenti, hogy a jelen KS-UBT1 megfelel az 1999/5/EC irányelvben meghatározott alapvető követelményeknek és egyéb vonatkozó előírásoknak.

Svenska

Härmed intygar JVC KENWOOD att denna KS-UBT1 står i överensstämmelse med de väsentliga egenskapskrav och övriga relevanta bestämmelser som framgår av direktiv 1999/5/EG.

Suomi

JVC KENWOOD vakuuttaa täten että KS-UBT1 tyypinen laite on direktiivin 1999/5/EY oleellisten vaatimusten ja sitä koskevien direktiivin muiden ehtojen mukainen.

Slovensko

S tem JVC KENWOOD izjavlja, da je ta KS-UBT1 v skladu z osnovnimi zahtevami in ostalimi ustreznimi predpisi Direktive 1999/5/EC.

Slovensky

Spoločnosť JVC KENWOOD týmto vyhlasuje, že KS-UBT1 spĺňa základné požiadavky a ďalšie príslušné ustanovenia Direktívy 1999/5/EC.

Dansk

Undertegnede JVC KENWOOD erklærer herved, at følgende udstyr KS-UBT1 overholder de væsentlige krav og øvrige relevante krav i direktiv 1999/5/EF.

Ελληνικά

ΜΕ ΤΗΝ ΠΑΡΟΥΣΑ JVC KENWOOD ΔΗΛΩΝΕΙ ΟΤΙ ΚΣ-UBT1 ΣΥΜΜΟΡΦΩΝΕΤΑΙ ΠΡΟΣ ΤΙΣ ΟΥΣΙΩΔΕΙΣ ΑΠΑΙΤΗΣΕΙΣ ΚΑΙ ΤΙΣ ΛΟΙΠΕΣ ΣΥΧΕΤΙΚΕΣ ΔΙΑΤΑΞΕΙΣ ΤΗΣ ΟΔΗΓΙΑΣ 1999/5/ΕΚ.

Eesti

Sellega kinnitab JVC KENWOOD, et see KS-UBT1 vastab direktiivi 1999/5/EC põhilistele nõudmistele ja muudele asjakohastele määrustele.

Latviešu

Ar šo, JVC KENWOOD, apstiprina, ka KS-UBT1 atbilst Direktīvas 1999/5/EK galvenajām prasībām un citiem tās nosacījumiem.

Lietuviškai

Šiuo, JVC KENWOOD, pareiškia, kad šis KS-UBT1 atitinka pagrindinius Direktyvos 1999/5/EB reikalavimus ir kitas svarbias nuostatas.

Malti

Hawnhekk, JVC KENWOOD, jiddikaria li dan KS-UBT1 jikkonforma mal-ħtiġijiet essenzzjali u ma provvedimenti oħrajn rilevanti li hemm fid-Direttiva 1999/5/EC.

Українська

Компанія JVC KENWOOD заявляє, що цей виріб КС-UBT1 відповідає ключовим вимогам та іншим пов'язаним положенням Директиви 1999/5/EC.

Türkçe

Bu vesileyle JVC KENWOOD, KS-UBT1 ünitesinin, 1999/5/EC Direktifinin başlıca gereksinimleri ve diğer ilgili hükümleri ile uyumlu olduğunu beyan eder.

KENWOOD

Free Manuals Download Website

<http://myh66.com>

<http://usermanuals.us>

<http://www.somanuals.com>

<http://www.4manuals.cc>

<http://www.manual-lib.com>

<http://www.404manual.com>

<http://www.luxmanual.com>

<http://aubethermostatmanual.com>

Golf course search by state

<http://golfingnear.com>

Email search by domain

<http://emailbydomain.com>

Auto manuals search

<http://auto.somanuals.com>

TV manuals search

<http://tv.somanuals.com>