

# KENWOOD

## DNN992 DNN9150BT

CONNECTED NAVIGATION SYSTEM

### Quick Start Guide

SISTEMA DE NAVEGACIÓN CONECTADO

### Guía de inicio rápido

JVCKENWOOD Corporation

You can update the system by connecting a USB device containing an update file. For updating the system, visit <<http://www.kenwood.com/cs/ce/>>.

Puede actualizar el sistema conectando un dispositivo USB que incluya un archivo de actualización.

Para actualizar el sistema, visite <<http://www.kenwood.com/cs/ce/>>.

**Take the time to read through this instruction manual.**

**Familiarity with installation and operation procedures will help you obtain the best performance from your new GPS Navigation System.**

#### **For your records**

Record the serial number, found on the back of the unit, in the spaces designated on the warranty card, and in the space provided below. Refer to the model and serial numbers whenever you call upon your Kenwood dealer for information or service on the product.

Model DNN992/ DNN9150BT Serial number \_\_\_\_\_

**US Residence Only**

**Register Online**

Register your Kenwood product at [www.Kenwoodusa.com](http://www.Kenwoodusa.com)

## Contents

About the Quick Start Guide .....	2
Precautions .....	3
Safety Precautions and Important Information .....	5
Features of Connected systems .....	6
First Step.....	7
Functions of the Buttons on the Front Panel.....	10
Common Operation.....	11
Login.....	12
Operation on the Home Screen .....	12
How to Use the Navigation System .....	13
How to Play Music.....	15
How to Play Movie.....	17
How to Listen to the Radio/ HD Radio™ tuner/ SiriusXM® .....	17
How to Make a Phone Call.....	18
Installation.....	19
iPod/ iPhone/ Android setup .....	27
About this Unit.....	30

## About the Quick Start Guide

This Quick Start Guide describes basic functions of this unit.

For functions not described in this Guide, refer to the Instruction Manual on the following website:

<http://manual.kenwood.com/edition/im387/>



To refer to the Instruction Manual, a PC loaded with Microsoft® Windows XP/Vista/7/8 or Mac OS X® 10.4 or later is required in addition to Adobe® Reader™ 7.1 or Adobe® Acrobat® 7.1 or later.

The Instruction Manual is subject to change for modification of specifications and so forth. Be sure to download the latest edition of the Instruction Manual for reference.

### NOTE

- The panels shown in this guide are examples used to provide clear explanations of the operations. For this reason, they may be different from the actual panels.
- In operation procedures, bracket shape indicates the key or button you should control.
  - < >: indicates the name of panel buttons.
  - [ ]: indicates the name of touch keys

## Precautions

### ▲WARNING

#### ■ To prevent injury or fire, take the following precautions:

- To prevent a short circuit, never put or leave any metallic objects (such as coins or metal tools) inside the unit.
- Do not watch or fix your eyes on the unit's display when you are driving for any extended period.
- If you experience problems during installation, consult your Kenwood dealer.

#### ■ Precautions on using this unit

- When you purchase optional accessories, check with your Kenwood dealer to make sure that they work with your model and in your area.
- You can select language to display menus, audio file tags, etc. See **Language setup (P.130)** in the Instruction Manual.
- The Radio Data System or Radio Broadcast Data System feature won't work where the service is not supported by any broadcasting station.

#### ■ Protecting the monitor

To protect the monitor from damage, do not operate the monitor using a ballpoint pen or similar tool with the sharp tip.

#### ■ Lens fogging

When you turn on the car heater in cold weather, dew or condensation may form on the lens in the disc player of the unit. Called lens fogging, this condensation on the lens may not allow discs to play. In such a situation, remove the disc and wait for the condensation to evaporate. If the unit still does not operate normally after a while, consult your Kenwood dealer.

#### ■ Precautions on handling discs

- Do not touch the recording surface of the disc.
- Do not stick tape etc. on the disc, or use a disc with tape stuck on it.
- Do not use disc type accessories.
- Clean from the center of the disc and move outward.
- When removing discs from this unit, pull them out horizontally.
- If the disc center hole or outside rim has burrs, use the disc only after removing the burrs with a ballpoint pen etc.
- Discs that are not round cannot be used.

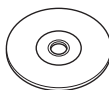

- 8-cm (3 inch) discs cannot be used.
- Discs with coloring on the recording surface or discs that are dirty cannot be used.
- This unit can only play the CDs with



This unit may not correctly play discs which do not have the mark.

- You cannot play a disc that has not been finalized. (For the finalization process see your writing software, and your recorder instruction manual.)

#### ■ Erase the personal information

Before giving or selling this unit to others, be sure to delete the information (mail, search logs, etc.) stored in this unit by yourself and confirm that the data has been deleted.

We shall not be liable for any damage caused by leakage of undeleted data.

1. Press the <HOME> button.
2. Press the <MENU> button.
3. Touch [Settings].
4. Touch [Backup & Reset].
5. Touch [Factory data reset].
6. Enter owner password. Touch [Reset].
7. Touch [ERASE].

## ■ Acquiring GPS signal

The first time you turn on this unit, you must wait while the system acquires satellite signals for the first time. This process could take up to several minutes. Make sure your vehicle is outdoors in an open area away from tall buildings and trees for fastest acquisition.

After the first time, the system acquires satellites for the first time, it will acquire satellites quickly each time thereafter.

## ■ About the front panel

When removing the product from the box or installing it, the front panel may be positioned at the angle shown in (Fig. 1). This is due to the characteristics of mechanism the product is equipped with.

When the product is first powered on works properly, the front panel will automatically move into the position (initial setting angle) shown in (Fig. 2).

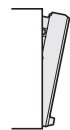

(Fig. 1)



(Fig. 2)

## ■ Cleaning the Unit

If the faceplate of this unit is stained, wipe it with a dry soft cloth such as a silicon cloth. If the faceplate is stained badly, wipe the stain off with a cloth moistened with neutral cleaner, then wipe it again with a clean soft dry cloth.

## ⚠ CAUTION

- Applying spray cleaner directly to the unit may affect its mechanical parts. Wiping the faceplate with a hard cloth or using a volatile liquid such as thinner or alcohol may scratch the surface or erase screened print.

## ■ How to reset your unit

If the unit or the connected unit fails to operate properly, reset the unit.

### 1 Press the <Reset> button.

The unit returns to factory settings.

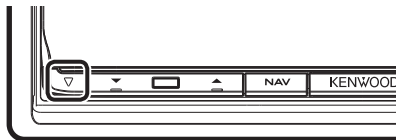

#### NOTE

- Disconnect the USB device before pressing the <Reset> button. Pressing the <Reset> button with the USB device connected can damage the data stored in the USB device. For how to disconnect the USB device, see **How to Play Music (P.15)**.
- When the unit is turned on after resetting, the Initial SETUP screen appears. See **First Step (P.7)**.

## Safety Precautions and Important Information

Read this information carefully before starting to operate the Kenwood Car Navigation System and follow the instructions in this manual. Neither Kenwood nor Garmin shall be liable for problems or accidents resulting from failure to observe the instructions in this manual.

### ▲ WARNINGS

**Failure to avoid the following potentially hazardous situations could result in an accident or collision resulting in death or serious injury.**

When navigating, carefully compare information displayed on the navigation system to all available navigation sources, including information from street signs, visual sightings, and maps. For safety, always resolve any discrepancies or questions before continuing navigation.

Always operate the vehicle in a safe manner.

Do not become distracted by the navigation system while driving, and always be fully aware of all driving conditions. Minimize the amount of time spent viewing the screen of the navigation system while driving, and use voice prompts when possible.

Do not enter destinations, change settings, or access any functions requiring prolonged use of the navigation system controls while driving. Stop your vehicle in a safe and legal manner before attempting such operations.

Keep the system volume at a low enough level to be able to hear outside noises while driving. If you can no longer hear outside noises, you may be unable to react adequately to the traffic situation. This may cause accidents.

The navigation system will not display the correct current position of the vehicle the first time it is used after purchase, or if the vehicle battery is disconnected. GPS satellite signals will soon be received, however, and the correct position will be displayed.

Be careful of the ambient temperature. Using the navigation system at extreme temperatures can lead to malfunction or damage. Also note that the unit can be damaged by strong vibration, by metal objects, or by water getting inside the unit.

### ▲ CAUTIONS

**Failure to avoid the following potentially hazardous situations may result in injury or property damage.**

The navigation system is designed to provide you with route suggestions. It does not reflect road closures or road conditions, weather conditions, or other factors that may affect safety or timing while driving.

Use the navigation system only as a navigational aid. Do not attempt to use the navigation system for any purpose requiring precise measurement of direction, distance, location, or topography.

The Global Positioning System (GPS) is operated by the United States government, which is solely responsible for its accuracy and maintenance. The government system is subject to changes that could affect the accuracy and performance of all GPS equipment, including the navigation system. Although the navigation system is a precision navigation device, any navigation device can be misused or misinterpreted and, therefore, become unsafe.

### IMPORTANT INFORMATION

#### ■ Vehicle Battery Preservation

This navigation system can be used when the ignition key is turned to ON or ACC. To preserve the battery, however, it should be used with the engine running whenever possible. Using the navigation system for a long time with the engine switched off can cause the battery to run down.

#### ■ Map Data Information

One of the goals of Garmin is to provide customers with the most complete and accurate cartography that is available to us at a reasonable cost. We use a combination of governmental and private data sources, which we identify in product literature and copyright messages displayed to the consumer. Virtually all data sources contain some inaccurate or incomplete data. In some countries, complete and accurate map information is either not available or is prohibitively expensive.

## Features of Connected systems

By connecting this unit to Internet, you can use various services.



### ■ Cooperation with Route Collector site

- Destinations and routes specified on the PC can be input to this navigation system.
- The routes you have traveled and the songs you have listened to can be logged.
- By uploading music files to Dropbox and creating a play list on Route Collector site, you can listen to music anywhere through streaming without music files on this unit.
- Speech to Text (STT) and Text to Speech (TTS).

### ■ Use of internet service

- Streaming service such as Aupeol, iHeartRadio\*.
- Internet service such as email, and social networking service such as Facebook and Twitter.
- Information (weather\*, traffic\*, RSS, etc.) service.

### 4G, 3G, LTE or EDGE

#### ■ 4G/ 3G Dongle (DNN992)

- Connect to the Internet directly with 4G/3G Dongle. The Internet device like smartphone is not necessary.

#### ■ Wi-Fi access point

- Connect to Internet using the tethering function of your smartphone or an Internet device.

#### Wi-Fi (11n/g/b)

#### ■ About the account

- To use internet services via this system, you need to create an account in the Route Collector site.
- In addition to the owner account, you can register up to four user accounts.
- You can use a guest account as well.
- By switching among accounts, you can secure the privacy when using the mail feature or social media.

#### ■ Wi-Fi hotspot

- This unit becomes the Wi-Fi access point and you can enjoy music and video in a smartphone Wi-Fi connected by Kenwood Wireless Link.

### Notes

You can use following feature for 2 years after registration of the owner account. To use it continuously, a usage fee is required. For details, see web site of Route Collector.

<http://www.route-collector.com/>

- Weather (by INRIX)\*
- Traffic (by INRIX)\*
- Dynamic Parking (by INRIX)\*
- Fuel Prices (by INRIX)\*
- Real-Time Traffic Camera (by INRIX)\*
- Movie Show Times (by WWM)\*
- TTS (by Nuance)
- STT (by Nuance)

To use the following services, you need to register the corresponding free or paid accounts.

- Aupeol!
- Facebook
- Twitter
- Dropbox
- iHeartRadio\*

\* DNN992 only

## First Step

Power on the unit and perform some setup steps before using.

### 1 Press the <⏻HOME> button.

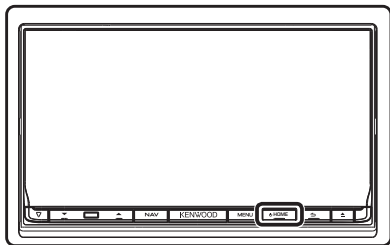

The unit is turned on.

- **To turn off the unit:**

Press the <⏻HOME> button for 1 second.

#### NOTE

- "Initial setup" also appears when the unit is reset.

### 2 Touch the corresponding key and set the item.

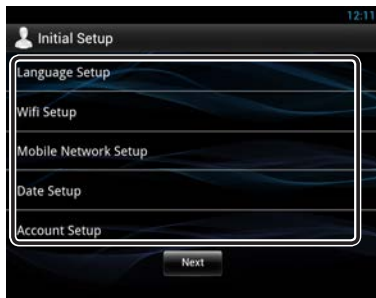

#### Language Setup

Select the language used for the GUI and input methods. Default is "English (United States)".

- 1) Touch [Language Setup].
- 2) Select a language from the list.

#### WiFi Setup

Configure settings for connection to Wi-Fi.

- 1) Touch [WiFi Setup].
- 2) Slide Wi-Fi to ON.
- 3) Touch [Wi-Fi].
- 4) Select the Wi-Fi access point to register from the list.
- 5) Enter the Password.
- 6) Touch [Connect].

After setting, press the <⏻> button.

#### Mobile Network Setup (DNN992)

Set the direct Internet connection with 4G/3G Dongle.

- 1) Touch [Mobile Network Setup].
  - 2) Touch [Mobile Network configuration].
  - 3) Enter the network information.
  - 4) Touch [Save].
  - 5) Touch [Mobile Network].
- After setting, press the <⏻> button.

#### Date Setup

Set the date and time.

- 1) Touch [Date Setup].

After setting, press the <⏻> button.

#### Account Setup

Set the information about the user of this unit.

- 1) Touch [Account Setup].

See **Types of accounts**, **Create User Account** and **Set Owner Account**.

## • Types of accounts

### Administrator

As Administrator, you can create an owner account and perform initial setup.

You can log in to the system if you have not created an owner account.

### Guest

An account for guests such as your friends.

The guest can operate this unit, but cannot use the functions related to mail, social media, and Route Collector site.

### Owner

The account for the person who manages this unit.

The owner can use the functions related to mail, social media, and Route Collector site.

You can register users such as your family.

### User

The account for the user of this unit.

The user can use the functions related to mail, social media, and Route Collector site.

You can register up to 4 user accounts.

## • Create User Account

### Preparation

- To register yourself in the Route Collector site as a user, you need a mail address.
- You can register yourself via the Web.  
<http://www.route-collector.com/>
- This step may be skipped if you have already registered yourself in the Route Collector site.
  - 1) Touch [Create Account].
  - 2) Enter account information.  
You cannot register an account which has already been used. Register another account name.
  - 3) Touch [OK].  
The account is temporarily registered in the Route Collector site.
  - 4) Activate the account.  
A confirmation mail is sent to the registered mail address. Open the indicated URL to complete account registration.
- **Set Owner Account**
  - 1) Touch [Set Owner Account].
  - 2) Enter account information.  
Enter the information registered in the Route Collector site.
  - 3) Touch [OK].

## 3 Touch [Next].

## 4 Touch the corresponding key and set the item.



### Locale

Select the country for the navigation system. The language, the distance unit, and the gasoline unit are set.

### Language

Select the language used for the control screen and setting items. Default is "American English (en)". After setting, touch [Enter].

### Angle

Adjust the position of the monitor. Default is "0". After setting, touch [].

### Color

Set the screen and button illumination color. You can select whether to perform color scan and adjust scanning color. After setting, touch [].

### EXT SW

Control the external devices. After setting, touch [].

### Camera

Set the parameters for the camera. After setting, touch [].



## OEM SETUP (North America Sales area only)

This function requires a commercial adaptor.

Consult your Kenwood dealer for details.

## DEMO

Set the demonstration mode. Default is "ON".

## 5 Touch [Finish].

### NOTE

- For details on operations of each setting, refer to the Instruction Manual.

## 6 Touch [Administrator] or [Owner].



## How to prepare the remote control

Insert two "AAA"/"R03"-size batteries with the ⊕ and ⊖ poles aligned properly, following the illustration inside the case.

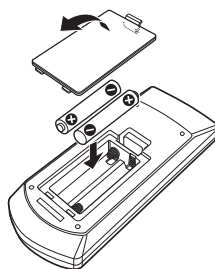

## CAUTION

- Put the remote controller in a place where it will not move during braking or other operations. A dangerous situation could result, if the remote controller falls down and gets wedged under the pedals while driving.
- Do not leave the battery near fire or under direct sunlight. A fire, explosion or excessive heat generation may result.
- Do not recharge, short, break up or heat the battery or place it in an open fire. Such actions may cause the battery to leak fluid. If spilled fluid comes in contact with your eyes or on clothing, immediately rinse with water and consult a physician.
- Place the battery out of reach of children. In the unlikely event that a child swallows the battery, immediately consult a physician.

## Functions of the Buttons on the Front Panel

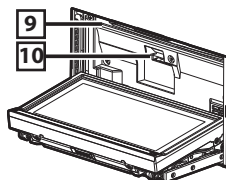
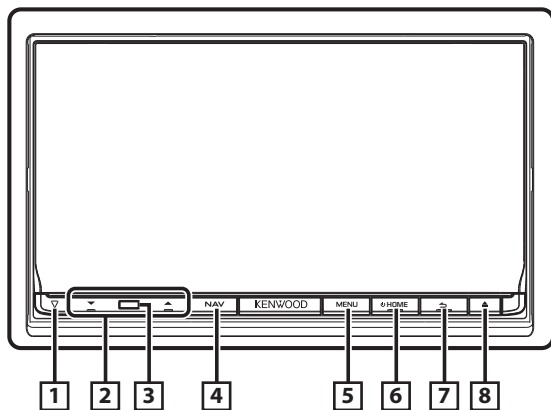

No.	Name/ Motion
1	<b>▽ (Reset)</b> <ul style="list-style-type: none"> <li>If the unit or the connected unit fails to operate properly, the unit returns to initial settings when this button is pressed (<b>Instruction Manual P.157</b>).</li> <li>If the SI function is turned on, this indicator flashes when the vehicle ignition is off (<b>Instruction Manual P.130</b>).</li> </ul>
2	<b>▲, ▼ (Vol)</b> <ul style="list-style-type: none"> <li>Adjusts volume.</li> </ul>
3	<b>Remote Sensor</b> <ul style="list-style-type: none"> <li>Receives the remote control signal.</li> </ul>
4	<b>NAV</b> <ul style="list-style-type: none"> <li>Displays the navigation screen.</li> <li>Pressing for 1 second switches camera view display on/off.*</li> </ul>
5	<b>MENU</b> <ul style="list-style-type: none"> <li>Displays the option menu screen.</li> <li>Pressing for 1 second switches AV out sources.</li> </ul>
6	<b>HOME</b> <ul style="list-style-type: none"> <li>Displays the Home screen (<b>P.12</b>).</li> <li>Pressing for 1 second turns the power off.</li> <li>When the power off, turns the power on.</li> </ul>

No.	Name/ Motion
7	<b>↶ (Back)</b> <ul style="list-style-type: none"> <li>Return to the previously viewed screen.</li> <li>Pressing for 1 second displays the Hands Free screen (<b>Instruction Manual P.120</b>).</li> </ul>
8	<b>▲ (Eject)</b> <ul style="list-style-type: none"> <li>Ejects the disc.</li> <li>When the panel is opened, pressing closes the panel and pressing for 1 second ejects the disc forcibly.</li> <li>When the panel is closed, pressing for 1 second fully opens the panel to the location of the SD card slot.</li> </ul>
9	<b>Disc insert slot</b> <ul style="list-style-type: none"> <li>A slot to insert a disc media.</li> </ul>
10	<b>SD card slot</b> <ul style="list-style-type: none"> <li>DNN992: A slot to insert an SD card.</li> <li>DNN9150BT: An SD card slot for upgrading the map. For how to upgrade the map, refer to the instruction manual of the navigation system.</li> </ul>

\* The function of the [NAV] button can be changed to the display off function. (**Instruction Manual P.129**)

## How to insert an SD card

- 1) Press **8** <▲> button for 1 second.  
The panel fully opens.
- 2) Hold the SD card as the illustration in the right and insert it into the slot until it clicks.

### To eject the card:

Push the card until it clicks and then remove your finger from the card.

The card pops up so that you can pull it out with your fingers.

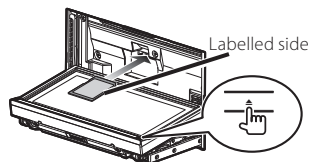

## Common Operation

### General

There are some functions which can be operated from most screens.

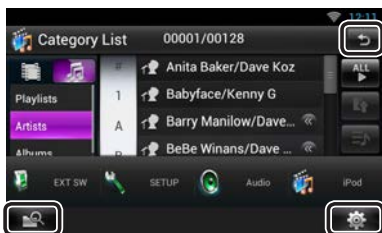

#### (Mixed Media Search)

Touch to display the Mixed Media Search screen.

#### (Quick menu)

Touch to display the quick menu. The content of the menu are as follows.

- : Touch to turn on or off the external device power supply.
- : Displays the SETUP Menu screen.
- : Displays the Audio Control Menu screen.
- : Displays the control screen of current source.  
Icon feature differs depending on the source.

#### (RETURN)

Returns to previous screen.

## List screen

There are some common function keys in the list screens of most sources.

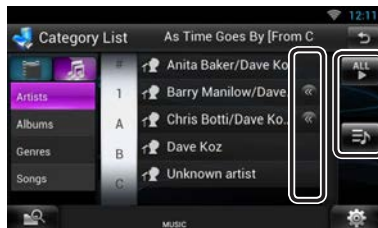

#### (Scroll)

Touch to scroll through texts on the display.

#### ALL etc.

Touch keys with various functions are displayed here.

Displayed keys differ depending on the current audio source, status, etc.

For examples, see **List screen (P.24)** in the Instruction Manual.

## Flick scrolling

You can scroll the list screen by flicking the screen up/down or right/left.

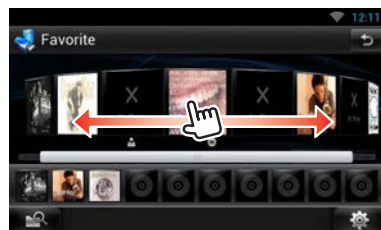
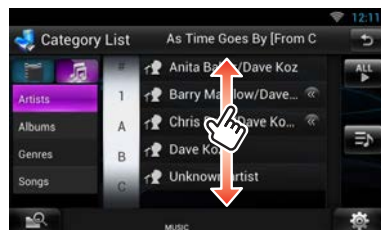

## Login

- 1 Press the <HOME> button to turn the power on.
- 2 Select the login user.
- 3 Enter the password.



### (Password)

Enter the registered password.

If you selected Administrator or Guest, this screen is not displayed.

### [Auto Login?]

Checking this checkbox allows you to log in to the system automatically from the next time.

### [Login]

Log in to the system.

### NOTE

- If you forgot your password, create your new password on the Route Collector site. <http://www.route-collector.com/>

## Operation on the Home Screen

- 1 Press the <HOME> button to display the Home screen.
- 2 Flick the screen left or right to select the Service panel, Media panel, Source launcher panel, or Network contents panel.



### 1 Service panel

Weather widget: Displays the weather forecast for the selected region.

Network widget: Displays the SNS, or RSS.

### 2 Media panel

Now playing: Displays the title of the song being played or the name of the station you are listening to, and allows you to perform simple operations.

Photo Frame Widget: Displays the Photo frame that shows photos.

### 3 Source launcher panel

Allows you to select a source.

### 4 Network contents panel

Allows you to select a network-related application.

## Source launcher panel



### (Shortcut)

You can register sources you use frequently so that you can start them quickly.

### (All source list)

Displays all sources.

#### • All source list

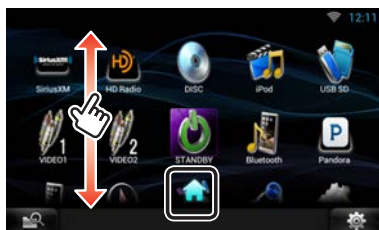

### (All source list)

You can scroll the list screen by flicking the screen up/down.

### (Home)

Returns to the Source launcher panel.

#### • Moving or deleting of an icon on the Source launcher panel

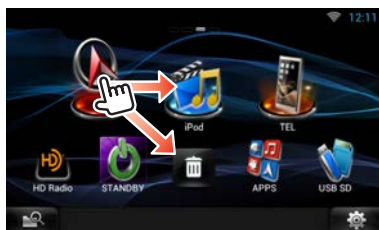

- 1) Touch and hold the icon.
- 2) Drag the icon to the desired position or Recycle Bin.

#### • Adding of a shortcut icon to Source launcher panel

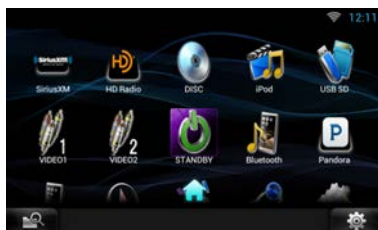

- 1) Touch  in Source launcher panel.
- 2) Touching the icon continuously to display the Source launcher panel screen.
- 3) Drag the icon to an empty space.

## How to Use the Navigation System

**1** Press the <NAV> button to display the navigation screen.

**2** Operate the desired function from the Main Menu screen.

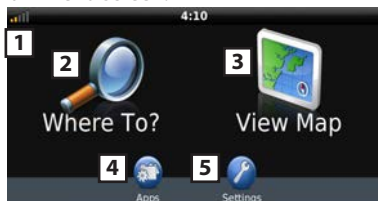

- 1) GPS satellite strength.
- 2) Finds a destination.
- 3) Views the map.
- 4) Uses the Apps such as ecoRoute and Help.
- 5) Adjusts the settings.

## NOTE

- You can get additional information about using the navigation system from Help. To display Help, touch [Apps] and then touch [Help].

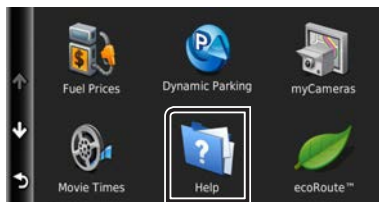

- For more information about your navigation system, download the latest version of the Owner's Manual from [manual.kenwood.com/edition/im387](http://manual.kenwood.com/edition/im387)

## 3 Enter your destination and start the guidance.

### Finding points of interest

- Touch [Where To?].
- Select a category and a subcategory.
- Select a destination.
- Touch [Go].

## NOTE

- To enter letters contained in the name, touch the Search bar and enter the letters.

## 4 Follow your route to the destination.

### NOTICE

- The speed limit icon feature is for information only and does not replace the driver's responsibility to abide by all posted speed limit signs and to use safe driving judgment at all times. Garmin and JVC KENWOOD will not be responsible for any traffic fines or citations that you may receive for failing to follow all applicable traffic laws and signs.

Your route is marked with a magenta line. As you travel, your navigation system guides you to your destination with voice prompts, arrows on the map, and directions at the top of the map. If you depart from the original route, your navigation system recalculates the route.



1	Views the Next Turn page or the junction view page, when available.
2	Views the Turn List page.
3	Views the Where Am I? page.
4	Stops the current route.
5	Displays traffic information on the route.
6	Returns to the Main Menu.
7	Displays a different data field.
8	Views the Trip Computer.
9	Displays more options.

## NOTE

- Touch and drag the map to view a different area of the map.
- A speed limit icon could appear as you travel on major roadways.

### Adding a stop

- While navigating a route, touch [↶] and then touch [Where To?].
- Search for the extra stop.
- Touch [Go].
- Touch [Add to Active Route] to add this stop before your final destination.

### Taking a detour

- While navigating a route, touch [☰].
- Touch [↔].

### Other Features

#### Manually avoiding traffic on your route

- From the map, touch the traffic icon.
- Touch [Traffic On Route].
- If necessary, touch the arrows to view other traffic delays on your route.
- Touch [☰] > [Avoid].

## • Viewing the traffic map

- 1) The traffic map shows color-coded traffic flow and delays on nearby.

## • About traffic

### NOTICE

- Traffic service is not available in some areas or countries.
- Garmin and JVC KENWOOD are not responsible for the accuracy or timeliness of the traffic information.
- DNN992 can receive traffic information using the built-in traffic receiver or a subscription to INRIX Traffic Service. The traffic receiver must be in data range of a station transmitting traffic data to receive traffic information. The traffic subscription activates automatically after your navigation system acquires satellite signals while receiving traffic signals from the service provider. You can add other subscriptions at any time. For information about traffic receivers and coverage areas, go to **www.garmin.com/kenwood**.
- With an FM traffic receiver, DNN992, DNN9150BT can receive and use traffic information. When a traffic message is received, you can see the event on the map and change your route to avoid the incident. You can purchase traffic subscriptions for regions or countries. Go to **www.garmin.com/kenwood** for more information.

## • Updating the software

To update the navigation system software, you must have an SD card, a USB mass storage device and an internet connection.

- 1) Go to **www.garmin.com/kenwood**.
- 2) Find your model and select [Software Updates] > [Download].
- 3) Read and accept the terms of the Software License Agreement.
- 4) Follow the instructions on the Web site to complete the installation of the software update.

## • Updating maps

You can purchase updated map data from Garmin or ask your Kenwood dealer or Kenwood service center for details.

- 1) Go to **www.garmin.com/kenwood**.
- 2) Select [Order Map Updates] for your Kenwood unit.
- 3) Follow the Web site instructions to update your map.

## How to Play Music

You can play audio files from music CD, disc media, USB storage device and iPod.

### NOTE

- For details on playable file format, media format, iPod model, etc., refer to the Instruction Manual. **(P.158)**
- To connect with iPod/iPhone/Android the setting is necessary. Refer to **iPod/ iPhone/ Android setup (P.27)**.

## 1 Connect the media you want to play as shown below.

### Disc

- 1) Press the <▲> button to open the front panel.
- 2) Insert the disc into the slot.  
The panel closes automatically and playback starts.

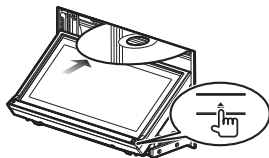

### • To eject the disc:

- 1) Press the <▲> button.

### iPod, USB device

- 1) Connect the device with each cable.  
Playback starts.

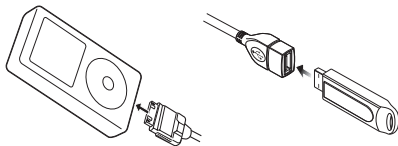

### • To disconnect the device:

- 1) Touch [▲] on the screen and disconnect the device from the cable.

### NOTE

- It applies when you set the iPod/iPhone connection with cable.

## • SD card (DNN992)

- 1) Press the <◀> button for 1 second to open the front panel.
- 2) Hold the SD card as the diagram below and insert it into the slot until it clicks. Playback starts.

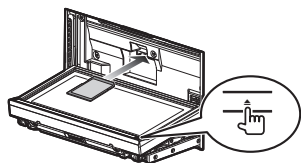

## • To remove:

- 1) Push the card until it clicks and then remove your finger from the card. The card pops up so that you can pull it out with your fingers.

## 2 Control the music you are listening to on the source control screen.

The following symbols indicate the keys on the screen.

The functions of the keys are the same despite the difference of the source you are listening to.



Touch [⏮]

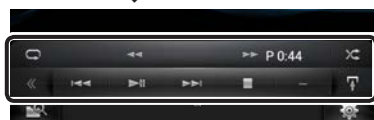

## • Basic operations from this screen



Plays or pauses.



Stops playing.



Disconnects the device.



Searches the previous/next content.

<<>> or move the cursor in the center bar

Fast forwards or Fast backwards (Disc media, CD, USB device, SD card only):



Repeats current content.



Plays all contents in random order.

## NOTE

- For other operations, refer to the Instruction Manual.
- If desired key is not displayed in the multi-function bar, touch the [◀] to switch the menu.

## 3 Search the track/file you want to listen to.

### • List search

- 1) Touch center of the screen. The content list of the media being played is displayed. If the information of the current track only is displayed, touch and hold [⏮] to switch the list display.

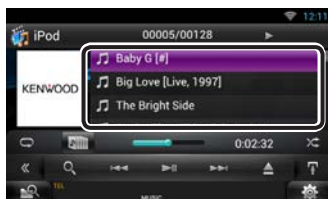

### • Refined search

- 1) Touch [Q].
- 2) Touch the desired refinement method. The list is refined by the item you selected.
- 3) Touch the desired item.

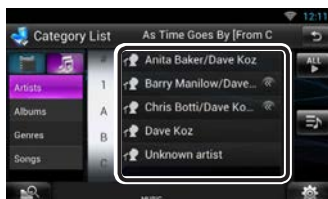

## NOTE

- For details on searching operations, refer to **Search Operation (P.72)** in the Instruction Manual.



## How to Play Movie

You can play DVD video, Video CD (VCD), movie files from disc media, iPod and USB storage device.

### NOTE

For details on playable file format, device format, etc., refer to the Instruction Manual.

## 1 Connect the media you want to play.

For the method of connecting, see **How to Play Music (P.15)**.

## 2 Control the movie by touching the screen.

Each area on the screen has a separate function.

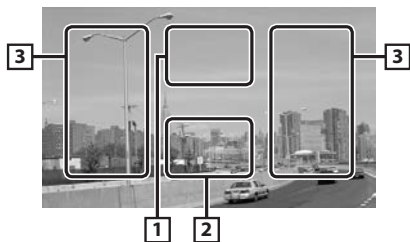

No.	Name/Motion
1	Displays the movie control screen.
2	Displays the Source Control screen.
3	<ul style="list-style-type: none"><li>Searches the next/previous content or file.</li><li>Scrolling from center of display to left or right performs fast backward or fast forward.</li></ul> To stop fast backward/forward, touch center of the display.*1

- \*1 For iPod/USB, this function may be unavailable depending on the playing file format.

### NOTE

- For operations on the source control screen, see **How to Play Music (P.15)**. However, searching by category/link/album artwork is not available.

## How to Listen to the Radio/ HD Radio™ tuner/ SiriusXM®

HD Radio tuner/ SiriusXM only by the DNN992.

## 1 Press the <HOME> button twice to the Source launcher panel.

## 2 Touch [ ] in the Source launcher panel.

## 3 Touch [TUNER], [HD Radio] or [SiriusXM].

The unit switches to the radio/ HD Radio tuner / SiriusXM (sold separately) source.



## 4 Operate on the source control screen.

### • Station search

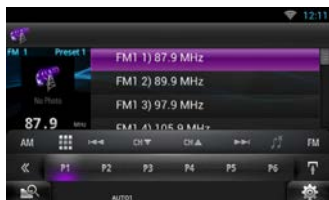
- Touch [  ].  
Sub function menu appears.
- Touch [AM] or [FM] to select the band.  
(Radio/ HD Radio tuner only)
- Radio/ HD Radio reception: Touch [ <<< ] or [ >>> ] to tune in the desired station.  
SiriusXM: Touch [CH ▼] or [CH ▲] to tune in the desired channel.



### • Auto memory (Radio/ HD Radio tuner only)

- Touch [  ].  
Sub function menu appears.
- Touch [AM] or [FM] to select the band.
- Touch [  ].
- Touch [AME].
- Touch [ <<< ] or [ >>> ] in the sub function menu.  
Auto memory starts.

### • Recalling the preset station

- Touch [P#].  
You can also display the preset list by touching the frequency display in the center.

## NOTE



- For other operations, see **Radio, HD Radio™ tuner Operation (P.92)** and **SiriusXM® Satellite Radio Operation (P.100)** in the Instruction Manual.

## How to Make a Phone Call

You can use your Bluetooth cell-phone when paired to this unit.

### 1 Register your cell-phone to the unit.

Follow as the procedures shown below. For detailed operation, see **Registering from this unit (P.117)** in the Instruction Manual.

- Press the <HOME> button twice to the Source launcher panel.
- Touch [  ] in the Source launcher panel.
- Touch [STANDBY].
- Press and hold the < > button.
- Touch [  ].

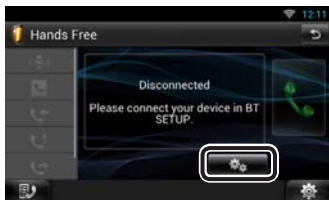

- Touch [Search].  
Searched Device List screen appears.



- Select your cell-phone from the displayed list in the Searched Device List screen.
- Enter PIN code from the cell-phone.  
Registering is completed.  
The PIN code is set to "0000" as default.

### 2 Connect your cell-phone to the unit.

- Touch the device name you want to connect in the Bluetooth SETUP screen.
- Touch [ON] of [TEL(HFP)] in the BT Connection Settings screen.  
The selected device is connected to the unit.



When registration of your cell-phone is completed, the phone book of the cell-phone is automatically downloaded to this unit.

## NOTE



- Touch [Audio(A2DP)] if you want to connect the device as an audio player.

### 3 Make or receive a phone call.





See the table below for each operation method.





#### Call by entering a phone number

- Touch [  ].
- Enter a phone number with number keys.
- Touch [  ].

#### Call using call records

- Touch [  ] (Incoming Calls), [  ] (Outgoing Calls), or [  ] (Missed Calls).
- Select the phone number from the list.
- Touch [  ].

## Call using the phonebook

- 1) Touch .
- 2) Select the name from the list.
- 3) Select the number from the list.
- 4) Touch .

## Call using the preset number

- 1) Touch [Preset #] to start calling the corresponding phone number.

## Call by voice

You can make a voice call using the voice recognition function of the cell-phone.

- 1) Touch .
- 2) Pronounce the name registered in the cell-phone.

### NOTE

- For detailed operation, see **Using Hands-Free Feature (P.120)** in the Instruction Manual.

## Installation

### Before Installation

Before installation of this unit, please note the following precautions.

### WARNINGS

- If you connect the ignition wire (red) and the battery wire (yellow) to the car chassis (ground), you may cause a short circuit, that in turn may start a fire. Always connect those wires to the power source running through the fuse box.
- Do not cut out the fuse from the ignition wire (red) and the battery wire (yellow). The power supply must be connected to the wires via the fuse.

### CAUTION

- Install this unit in the console of your vehicle. Do not touch the metal part of this unit during and shortly after the use of the unit. Metal part such as the heat sink and enclosure become hot.

### NOTES

- Mounting and wiring this product requires skills and experience. For best safety, leave the mounting and wiring work to professionals.
- Make sure to ground the unit to a negative 12V DC power supply.
- Do not install the unit in a spot exposed to direct sunlight or excessive heat or humidity. Also avoid places with too much dust or the possibility of water splashing.
- Do not use your own screws. Use only the screws provided. If you use the wrong screws, you could damage the unit.
- If the power is not turned ON ("PROTECT" is displayed), the speaker wire may have a short-circuit or touched the chassis of the vehicle and the protection function may have been activated. Therefore, the speaker wire should be checked.
- If your car's ignition does not have an ACC position, connect the ignition wires to a power source that can be turned on and off with the ignition key. If you connect the ignition wire to a power source with a constant voltage supply, such as with battery wires, the battery may be drained.
- If the console has a lid, make sure to install the unit so that the faceplate will not hit the lid when closing and opening.
- If the fuse blows, first make sure the wires aren't touching to cause a short circuit, then replace the old fuse with one with the same rating.



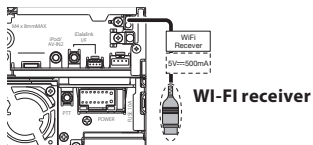
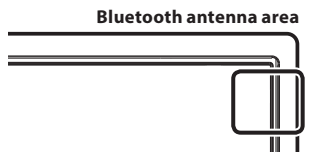



- Insulate unconnected wires with vinyl tape or other similar material. To prevent a short circuit, do not remove the caps on the ends of the unconnected wires or the terminals.
- Connect the speaker wires correctly to the terminals to which they correspond. The unit may be damaged or fail to work if you share the  $\ominus$  wires or ground them to any metal part in the car.
- When only two speakers are being connected to the system, connect the connectors either to both the front output terminals or to both the rear output terminals (do not mix front and rear). For example, if you connect the  $\oplus$  connector of the left speaker to a front output terminal, do not connect the  $\ominus$  connector to a rear output terminal.
- After the unit is installed, check whether the brake lamps, blinkers, wipers, etc. on the car are working properly.
- Mount the unit so that the mounting angle is 30° or less.
- This unit has the cooling fan (**P.24**) to decrease the internal temperature. Do not mount the unit in a place where the cooling fan of the unit is blocked. Blocking these openings will inhibit the cooling of the internal temperature and result in malfunction.
- Do not press hard on the panel surface when installing the unit to the vehicle. Otherwise scars, damage, or failure may result.
- Reception may drop if there are metal objects near the Bluetooth antenna and WI-FI receiver.

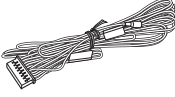
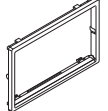
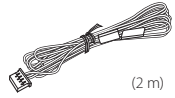
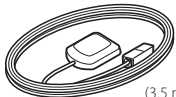
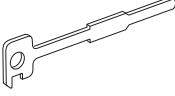
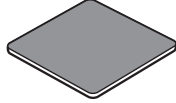
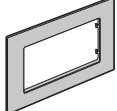

- Install the WI-FI receiver besides the place enclosed by the metal.

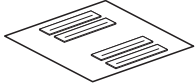
## ■ Supplied accessories

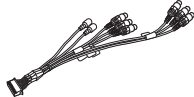
First of all, make sure that all accessories are supplied with the unit.

① ...1 	⑧ ...1 
② ...1  (2 m)	⑨ ...1  (3.5 m)
③ ...2 	⑩ ...1 
④ *1 ...1 	⑪ ...1  (3 m)
⑤ *1 ...1 	⑫ *1 ...1  (3 m)
⑥ ...6  (M5x6mm)	⑬ ...1 
⑦ ...6  (M5x7mm)	*1 DNN992 only

## Unit

- 1) To prevent a short circuit, remove the key from the ignition and disconnect the  $\ominus$  terminal of the battery.
- 2) Make the proper input and output wire connections for each unit.
- 3) Connect the speaker wires of the wiring harness.
- 4) Connect the wiring harness wires in the following order; ground, battery, ignition.
- 5) Connect the wiring harness connector to the unit.
- 6) Install the unit in your car.
- 7) Reconnect the  $\ominus$  terminal of the battery.
- 8) Press the <Reset> button. **(P.4)**
- 9) Perform the Initial Setup.

See **First Step (P.7)**.

### • Non-Japanese cars

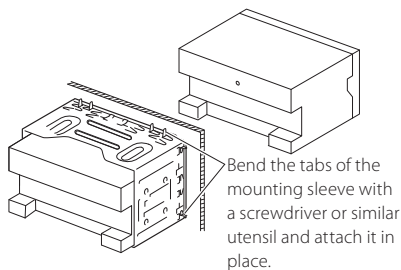

### • Japanese cars

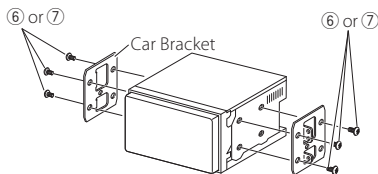

## NOTE

- Make sure that the unit is installed securely in place. If the unit is unstable, it may malfunction (eg, the sound may skip).

## Trim plate

- 1) Attach accessory ⑧ to the unit.

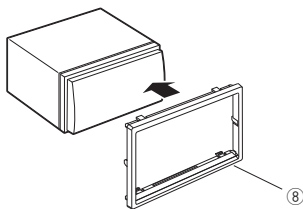

### • General Motors cars (DNN992)

- 1) Cut out accessory ④ to meet the shape of the opening of the center console.
- 2) Attach accessory ④ to the unit.

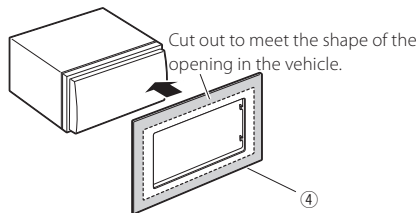

### • Toyota/Scion cars (DNN992)

- 1) Cut out accessory ④ as illustrated.

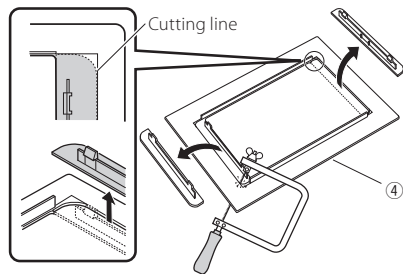

- 2) Fold double-sided adhesive (accessory ⑤) along the slit and attach it to accessory ④ cut-out against the center rib as illustrated. Use 2 pieces of accessory ⑤ for 1 accessory ④ cut-out.

- 3) Attach accessory ④ cut-out to the unit.

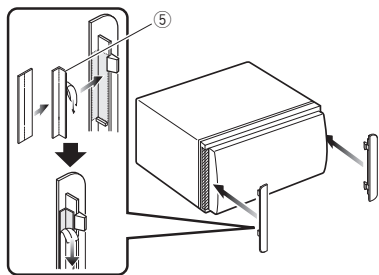

### ■ GPS antenna

GPS antenna is installed inside of the car. It should be installed as horizontally as possible to allow easy reception of the GPS satellite signals.

To mount the GPS antenna inside your vehicle:

- 1) Clean your dashboard or other surface.
- 2) Remove the separator of the metal plate (accessory ⑩).
- 3) Press the metal plate (accessory ⑩) down firmly on your dashboard or other mounting surface. You can bend the metal plate (accessory ⑩) to conform to a curved surface, if necessary.
- 4) Remove the separator of the GPS antenna (accessory ⑨), and stick the antenna to the metal plate (accessory ⑩).

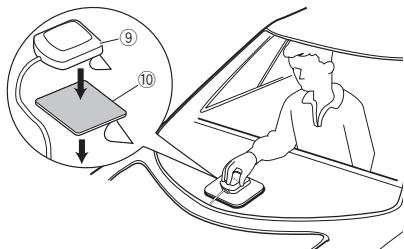

### ✎ NOTE

- Depending on the type of car, reception of the GPS satellite signals might not be possible with an inside installation.
- Please install this GPS antenna in an area away from any antennas that are used with CB radios or satellite televisions.
- The GPS antenna should be installed at a position that is spaced at least 12 inch (30 cm) from cellular phone or other transmitting antennas. Signals from

the GPS satellite may be interfered with by these types of communication.

- Painting the GPS antenna with (metallic) paint may cause a drop in performance.

### ■ Microphone unit and Push-To-Talk Switch

- 1) Check the installation position of the microphone (accessory ⑪) and the Push-To-Talk switch (accessory ⑫ : DNN992 only).
- 2) Clean the installation surface.
- 3) Install the microphone.
- 4) Wire the microphone cable up to the unit with it secured at several positions using tape or other desired method.

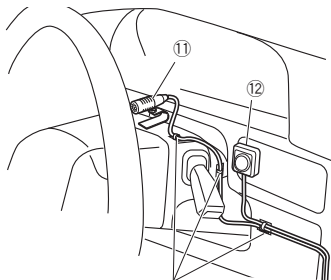

Fix a cable with a commercial item of tape.

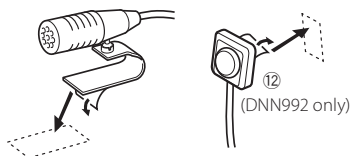

Remove the separator of the microphone, and stick the microphone to the place shown above.



Adjust the direction of the microphone to the driver.

### ✎ NOTE

- Install the microphone as far as possible from the cell-phone.

## ■ Removing the trim plate

- 1) Engage the catch pins on the extraction key (accessory③) and remove the two locks on the lower level.

Lower the trim plate (accessory⑧) and pull it forward as shown in the figure.

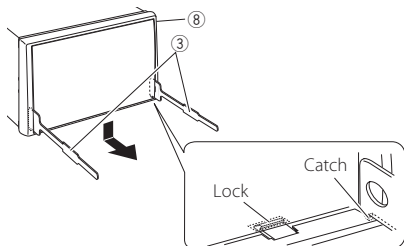

### NOTE

- The trim plate can be removed from the top side in the same manner.
- 2) When the lower level is removed, remove the upper two locations.

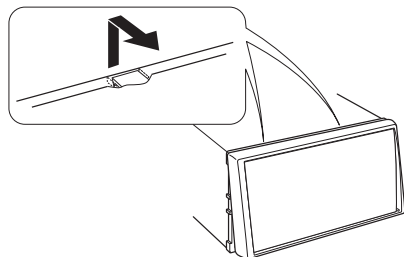

## ■ Removing the unit

- 1) Remove the trim plate by referring to **step 1 in "Removing the trim plate"**.
- 2) Insert the two extraction key (accessory③) deeply into the slots on each side, as shown.

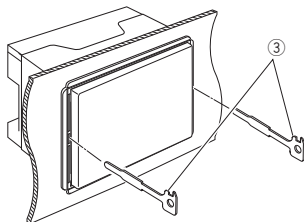

- 3) Lower the extraction key toward the bottom, and pull out the unit halfway while pressing towards the inside.

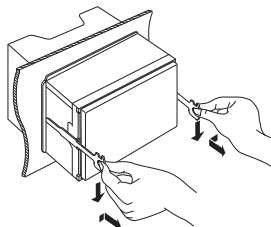

### NOTE

- Be careful to avoid injury from the catch pins on the extraction key.
- 4) Pull the unit all the way out with your hands, being careful not to drop it.

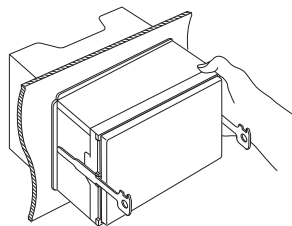

## ■ Connecting wires to terminals

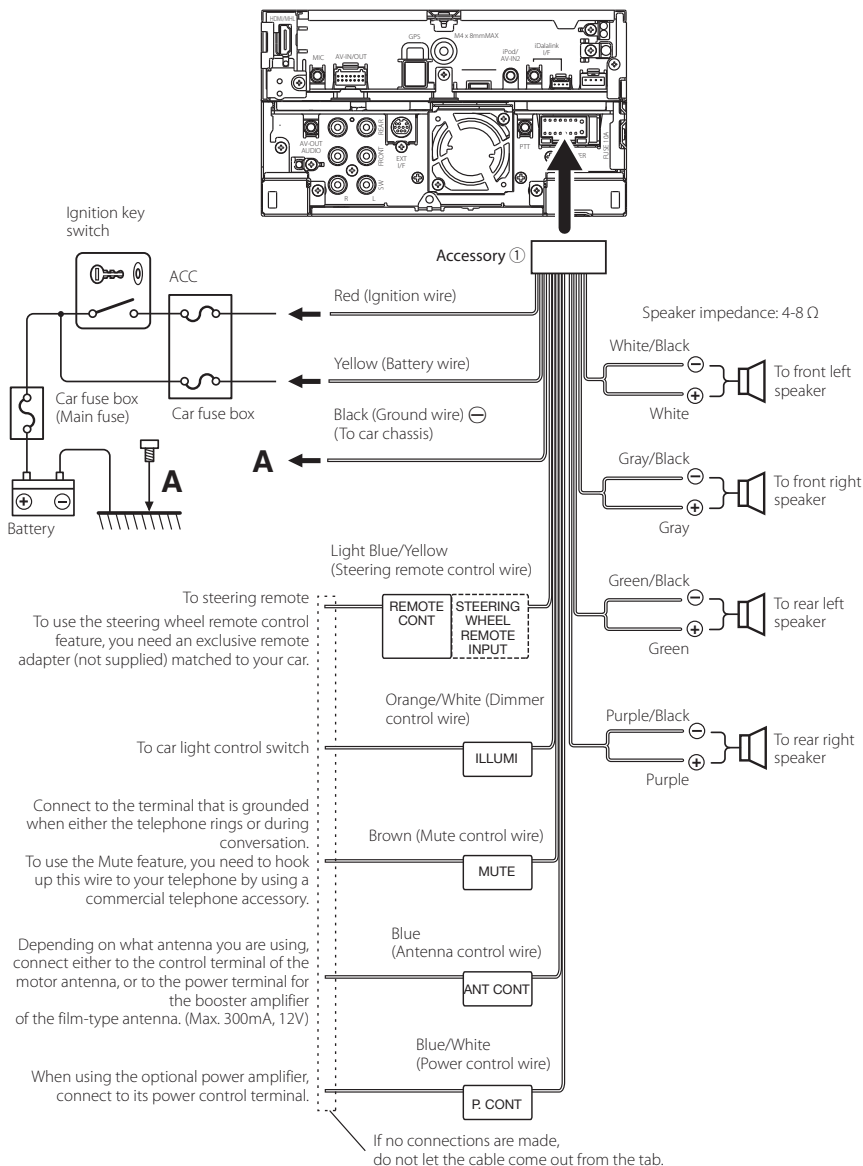



## System connection

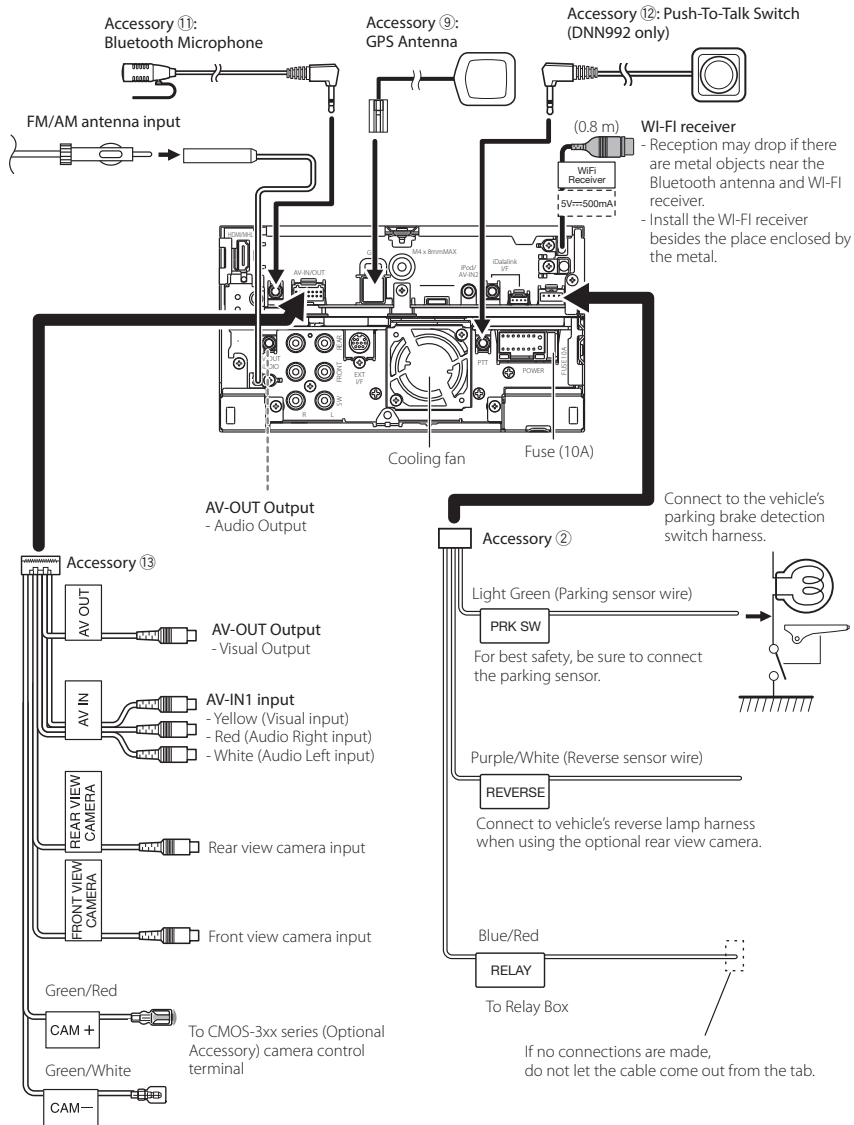

## Optional accessory connection

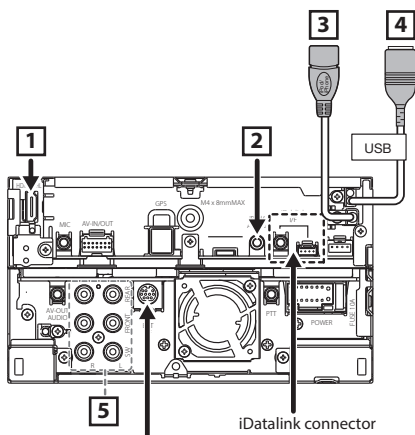

1 SiriusXM Connect Vehicle Tuner (sold separately) (DNN992 only)

2 iDataLink connector (DNN992 only)

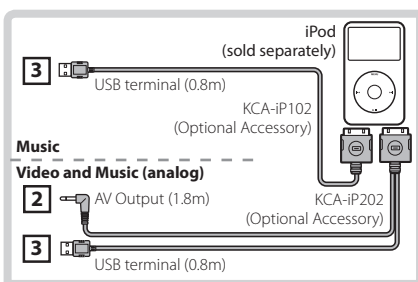
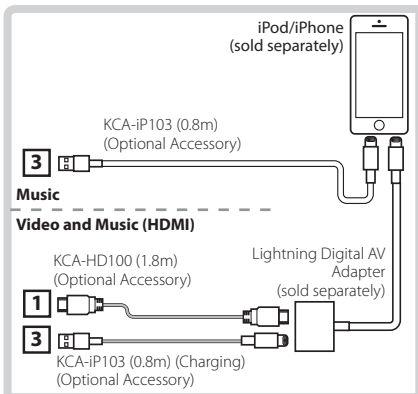

- 1** HDMI/ MHL input  
MHL maximum power supply current :  
5 V  $\overline{\text{---}}$  900 mA

When you connect the cable to HDMI/MHL terminal, remove the fixture. After connecting the cable, put the fixture again.

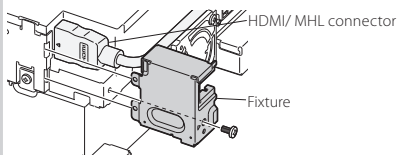

- 2** iPod input / AV-IN2 (CA-C3AV; Optional Accessory) input  
(iPod/ AV-IN2 switchable)

- 3** iPod/ USB terminal (0.8m)  
iPod/ USB maximum power supply current :  
5 V  $\overline{\text{---}}$  1 A

- 4** USB terminal (0.8m)  
USB maximum power supply current :  
5 V  $\overline{\text{---}}$  500 mA

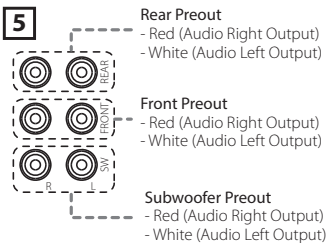

When connecting to an external amplifier, connect its ground wire to the car's chassis to avoid damaging the unit.

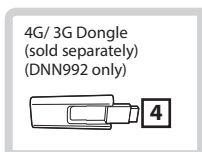
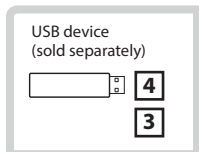
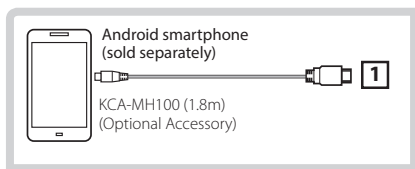

#### NOTE

- For the connection and the setting of iPod/iPhone refer to **iPod/iPhone connection and setting (P.27)**.
- For the connection and the setting of Android smartphone refer to **Android connection (P.27)**.

## iPod/ iPhone/ Android setup

### Android connection

To connect the Android device with this unit, the cable (sold separately) and the profile which your Android device supports are necessary as follows:

- **To listen to music and watch video of APPS source**
  - MHL device
  - KCA-MH100
  - Bluetooth profile: SPP
  - Application link setup: HDMI/MHL + BT (P.29)
- **To listen to music of APPS source**
  - Bluetooth profile: A2DP
  - Bluetooth profile: SPP
  - Application link setup: Bluetooth (P.29)
- **To listen to music of Bluetooth Audio source**
  - Bluetooth profile: A2DP
  - Bluetooth profile: AVRCP

### NOTE

- When you select Pandora source the setting of **Application link setup (P.29)** is also necessary.

- In the APPS source, some functions can be controlled from this unit and they depend on the applications. Refer to **APPS Operation (P.80)** in the Instruction Manual.
- Do not leave the cable or the adapter made by other makers inside the car. It might lead the malfunction caused by heat.

### iPod/iPhone connection and setting

#### • Connectable iPod/iPhone

The following models can be connected to this unit.

Made for

- iPhone 5s
  - iPhone 5c
  - iPhone 5
  - iPhone 4S
  - iPhone 4
  - iPhone 3GS
  - iPhone 3G
  - iPhone
  - iPod touch (5th generation)
  - iPod touch (4th generation)
  - iPod touch (3rd generation)
  - iPod touch (2nd generation)
  - iPod touch (1st generation)
  - iPod classic
  - iPod with video
  - iPod nano (7th generation)
  - iPod nano (6th generation)
  - iPod nano (5th generation)
  - iPod nano (4th generation)
  - iPod nano (3rd generation)
- Latest compatible list of iPod/iPhone. For details, see [www.kenwood.com/cs/ce/ipod/](http://www.kenwood.com/cs/ce/ipod/).

#### • iPod/iPhone connection

To connect the iPod/iPhone with this unit, the cable, adapter (both sold separately), and the profile which your iPod/iPhone supports are necessary as follows:

- **To listen music and watch video with Lightning connector device**
  - Lightning Digital AV Adapter
  - KCA-HD100
  - KCA-iP103
  - Bluetooth profile: SPP
  - iPod connection setup: HDMI + BT (P.28)
- **To listen music with Lightning connector device**
  - KCA-iP103
  - iPod connection setup: USB 1Wire (P.28)

- **To listen music and watch video with 30-pin connector device (analog)**
  - KCA-iP202
  - iPod connection setup: USB + AV-IN (P.28)
- **To listen music with 30-pin connector device**
  - KCA-iP102
  - iPod connection setup: USB 1Wire (P.28)
- **To listen to music via Bluetooth**
  - Bluetooth profile: A2DP
  - Bluetooth profile: SPP
  - iPod connection setup: Bluetooth (P.28)
- **To listen to music of Bluetooth Audio source**
  - Bluetooth profile: A2DP
  - Bluetooth profile: AVRCP

- **iPod/iPhone connection setup**  
When you first select iPod as a source, the setting screen of the iPod/iPhone connection will appear.

**1** Press the <HOME> button twice to the Source launcher panel.

**2** Touch [  ] in the Source launcher panel.

**3** Touch [iPod].

iPod connection setup screen appears.

**4** Touch [CHANGE].

**5** Set each item as follows.



#### USB + AV-IN

Select when connecting with KCA-iP202.

#### USB 1Wire

Select when connecting with KCA-iP103 or KCA-iP102.

#### HDMI + BT

Select when connecting with KCA-HD100 and Lightning Digital AV Adapter.

#### Bluetooth

Select when connecting via Bluetooth only.

**6** Touch [Next].

Confirmation screen appears.

**7** Touch [Done].

#### NOTE

- When you select "HDMI + BT" or "Bluetooth" in step 5, Bluetooth device selection screen will appear. Select the iPod/iPhone to be connected.

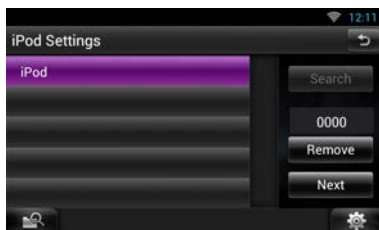

If a connectable Bluetooth device is not displayed, touch [Search] and do the pairing of the devices.

- "iPod connection setup" also appears when the unit is reset.
- The setting of "iPod connection setup" is just for the unit and regardless of the account.

### Application link setup

When you first select Apps as a source, the setting screen for the connection with the device installed the apps will appear.

**1** Press the <HOME> button twice to the Source launcher panel.

**2** Touch [ ] in the Source launcher panel.

**3** Touch [APPS].

Application link setup screen appears.

**4** Touch [CHANGE].

**5** Select the device installed the apps.



**6** Select the way to connect the device with this unit.

• When selecting [iPod/iPhone]



For the setting items refer to **iPod/iPhone connection setup (P.28)**.

• When selecting [Android/Other]

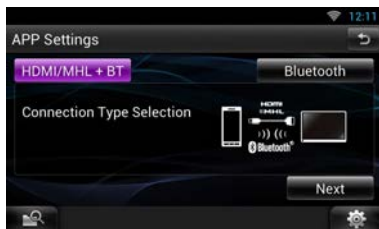

**HDMI/MHL + BT**

Select when connecting with KCA-MH100.

**Bluetooth**

Select when connecting via Bluetooth only.

**7** Touch [Next].

Confirmation screen appears.

**8** Touch [Done].

### NOTE

- For the details of the necessary cable and adapter to connect with iPod/iPhone and Android, refer to **iPod/iPhone connection and setting (P.27)** and **Android connection (P.27)**.

- When you select "HDMI + BT", "HDMI/MHL + BT" or "Bluetooth" in step 6, Bluetooth device selection screen will appear. Select the device to be connected.

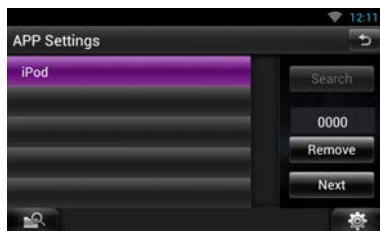

If a connectable Bluetooth device is not displayed, touch [Search] and do the pairing of the devices.

- "Application link setup" also appears when the unit is reset.
- The setting of "Application link setup" is just for the unit and regardless of the account.

## About this Unit

### Requirements Pandora®:

Requirements for listening to the Pandora® are as follows:

- A smartphone with the latest Pandora application installed.
- A Pandora account (if you do not have an account, create one for free using the mobile app or on [www.pandora.com](http://www.pandora.com)).
- An active internet connection.

### iPhone or iPod touch

- Apple iPhone or iPod touch with iOS 3 or later installed.
- Latest version of the Pandora application (search App Store for Pandora and install).

### Android™

- Latest version of the Pandora Android application (search Google Play for Pandora and install).

### BlackBerry®

- Visit [www.pandora.com](http://www.pandora.com) from the built in browser to download the Pandora application.
- Bluetooth must be built in and the following profiles must be supported.
  - SPP (Serial Port Profile)

- A2DP (Advanced Audio Distribution Profile)

### NOTE

- The Pandora service is available only in the U.S, Australia and New Zealand.
- Because Pandora® internet radio is a third-party service, the specifications are subject to change without prior notice. Accordingly, compatibility may be impaired or some or all of the services may become unavailable.
- Some Pandora® functionality cannot be operated from this unit.
- For issues using the Pandora® application, please contact Pandora at [pandora-support@pandora.com](mailto:pandora-support@pandora.com)

### Requirements iHeartRadio™:

Requirements for listening to iHeartRadio™ are as follows:

- In the application on your device, log in and create a free account with iHeartRadio.
- An active internet connection.

### NOTE

- Because iHeartRadio™ is a third-party service, the specifications are subject to change without prior notice. Accordingly, compatibility may be impaired or some or all of the services may become unavailable.
- Some iHeartRadio™ functionality cannot be operated from this unit.

### Copyrights

- The Bluetooth word mark and logos are owned by the Bluetooth SIG, Inc. and any use of such marks by JVC KENWOOD Corporation is under license. Other trademarks and trade names are those of their respective owners.
- The "AAC" logo is a trademark of Dolby Laboratories.
- "Made for iPod" and "Made for iPhone" mean that an electronic accessory has been designed to connect specifically to iPod, or iPhone, respectively, and has been certified by the developer to meet Apple performance standards. Apple is not responsible for the operation of this device or its compliance with safety and regulatory standards. Please note that the use of this accessory with iPod, or iPhone may affect wireless performance.
- iPhone, iPod, iPod classic, iPod nano, and iPod touch are trademarks of Apple Inc., registered in the U.S. and other countries. Lightning is a trademark of Apple Inc.
- Sirius, XM and all related marks and logos are trademarks of Sirius XM Radio Inc. All rights reserved.

- HD Radio Technology manufactured under license from iBiquity Digital Corporation. U.S. and Foreign Patents. HD Radio™ and the HD, HD Radio, and “Arc” logos are proprietary trademarks of iBiquity Digital Corp.
- PANDORA, the PANDORA logo, and the Pandora trade dress are trademarks or registered trademarks of Pandora Media, Inc., used with permission.
- iHeartRadio® is a registered mark of Clear Channel Broadcasting, Inc. in the United States and other countries. Such marks are used under license.
- “aupeo” is a trade mark of Aupeo GmbH.
-  is a trademark of DVD Format/Logo Licensing Corporation registered in the U.S., Japan and other countries.
- This item incorporates copy protection technology that is protected by U.S. patents and other intellectual property rights of Rovi Corporation. Reverse engineering and disassembly are prohibited.
- QR Code ® is registered trademarks of DENSO WAVE INCORPORATED in JAPAN and other countries.
- The aptX® software is copyright CSR plc or its group companies. All rights reserved. The aptX® mark and the aptX logo are trade marks of CSR plc or one of its group companies and may be registered in one or more jurisdictions.
- Manufactured under license from Dolby Laboratories. Dolby and the double-D symbol are trademarks of Dolby Laboratories.
- Adobe, Acrobat and Reader are either registered trademarks or trademarks of Adobe Systems Incorporated in the United States and/or other countries.
- SDHC Logo is a trademark of SD-3C, LLC.
- Twitter is a registered trademark of Twitter, Inc.
- Facebook® is a registered trademark of Facebook Inc.
- INRIX is a registered trademark of INRIX, Inc.
- Nuance is a registered trademark of Nuance Communications, Inc.
- Dropbox is a trademark of Dropbox Inc.
- The terms HDMI and HDMI High-Definition Multimedia Interface, and the HDMI logo are trademarks or registered trademarks of HDMI Licensing LLC in the United States and other countries.
- MHL and the MHL logo are a trademark or registered trademark of MHL, LLC.
  - Incorporates MHL 2
- Android is a trademark of Google Inc.
- BlackBerry®, RIM®, Research In Motion® and related trademarks, names and logos are the property of Research In Motion Limited and are registered and/or used in the U.S. and countries around the world. Used under license from Research In Motion Limited.
- ABOUT DIVX VIDEO: DivX® is a digital video format created by DivX, LLC, a subsidiary of Rovi Corporation. This is an official DivX Certified® device that plays DivX video. Visit divx.com for more information and software tools to convert your files into DivX videos.
- ABOUT DIVX VIDEO-ON-DEMAND: This DivX Certified® device must be registered in order to play purchased DivX Video-on-Demand (VOD) movies. To obtain your registration code, locate the DivX VOD section in your device setup menu. Go to vod.divx.com for more information on how to complete your registration.
- DivX®, DivX Certified® and associated logos are trademarks of Rovi Corporation or its subsidiaries and are used under license.
- AVC  
THIS PRODUCT IS LICENSED UNDER THE AVC PATENT PORTFOLIO LICENSE FOR THE PERSONAL USE OF A CONSUMER OR OTHER USES IN WHICH IT DOES NOT RECEIVE REMUNERATION TO (i) ENCODE VIDEO IN COMPLIANCE WITH THE AVC STANDARD (“AVC VIDEO”) AND/OR (ii) DECODE AVC VIDEO THAT WAS ENCODED BY A CONSUMER ENGAGED IN A PERSONAL ACTIVITY AND/OR WAS OBTAINED FROM A VIDEO PROVIDER LICENSED TO PROVIDE AVC VIDEO. NO LICENSE IS GRANTED OR SHALL BE IMPLIED FOR ANY OTHER USE. ADDITIONAL INFORMATION MAY BE OBTAINED FROM MPEG LA, L.L.C. SEE [HTTP://WWW.MPEGLA.COM](http://www.mpegla.com)
- MPEG-4 Visual  
THIS PRODUCT IS LICENSED UNDER THE MPEG-4 VISUAL PATENT PORTFOLIO LICENSE FOR THE PERSONAL AND NON-COMMERCIAL USE OF A CONSUMER FOR (i) ENCODING VIDEO IN COMPLIANCE WITH THE MPEG-4 VISUAL STANDARD (“MPEG-4 VIDEO”) AND/OR (ii) DECODING MPEG-4 VIDEO THAT WAS ENCODED BY A CONSUMER ENGAGED IN A PERSONAL AND NON-COMMERCIAL ACTIVITY AND/OR WAS OBTAINED FROM A VIDEO PROVIDER LICENSED BY MPEG LA TO PROVIDE MPEG-4 VIDEO. NO LICENSE IS GRANTED OR SHALL BE IMPLIED FOR ANY OTHER USE. ADDITIONAL INFORMATION INCLUDING THAT RELATING TO

PROMOTIONAL, INTERNAL AND COMMERCIAL USES AND LICENSING MAY BE OBTAINED FROM MPEG LA, LLC. SEE [HTTP://WWW.MPEGLA.COM](http://www.mpegla.com).

• libFLAC

Copyright (C) 2000,2001,2002,2003,2004,2005,2006,2007,2008,2009 Josh Coalson

Redistribution and use in source and binary forms, with or without modification, are permitted provided that the following conditions are met:

- Redistributions of source code must retain the above copyright notice, this list of conditions and the following disclaimer.
  - Redistributions in binary form must reproduce the above copyright notice, this list of conditions and the following disclaimer in the documentation and/or other materials provided with the distribution.
  - Neither the name of the Xiph.org Foundation nor the names of its contributors may be used to endorse or promote products derived from this software without specific prior written permission.
- THIS SOFTWARE IS PROVIDED BY THE COPYRIGHT HOLDERS AND CONTRIBUTORS "AS IS" AND ANY EXPRESS OR IMPLIED WARRANTIES, INCLUDING, BUT NOT LIMITED TO, THE IMPLIED WARRANTIES OF MERCHANTABILITY AND FITNESS FOR A PARTICULAR PURPOSE ARE DISCLAIMED. IN NO EVENT SHALL THE FOUNDATION OR CONTRIBUTORS BE LIABLE FOR ANY DIRECT, INDIRECT, INCIDENTAL, SPECIAL, EXEMPLARY, OR CONSEQUENTIAL DAMAGES (INCLUDING, BUT NOT LIMITED TO, PROCUREMENT OF SUBSTITUTE GOODS OR SERVICES; LOSS OF USE, DATA, OR PROFITS; OR BUSINESS INTERRUPTION) HOWEVER CAUSED AND ON ANY THEORY OF LIABILITY, WHETHER IN CONTRACT, STRICT LIABILITY, OR TORT (INCLUDING NEGLIGENCE OR OTHERWISE) ARISING IN ANY WAY OUT OF THE USE OF THIS SOFTWARE, EVEN IF ADVISED OF THE POSSIBILITY OF SUCH DAMAGE.

### ■ KENWOOD Route Network Service "Route Collector" User's Agreement

This KENWOOD Route Network Service "Route Collector" User's Agreement ("Agreement") sets forth the terms and conditions for use of the KENWOOD Route Network Service "Route Collector" provided by JVCENWOOD Corporation ("Service") to the users who fulfill the requirements for "Conditions of Use" in the paragraph 1 ("User(s)"), and the rules for handling User's information necessary for use this Service.

#### 1. Conditions of Use

Users who desire to take advantage of this Service must however first register themselves upon agreeing to the terms of this Agreement. This Service may only be used by Users for personal use, not for commercial use.

The terms of this Agreement may be revised or modified as necessary at our option without prior notice. In such event, Users shall hereby agree to the application of any such revisions or modifications as a condition to continued use of the Service.

Also, Users shall be solely responsible for managing and using their registered user account names and passwords. In no event can we accept any responsibility for any problems or damages resulting from the User's management and usage of its user account name and password management.

#### 2. Period for the Service

Users may in principal continue to use the Service as long as it is being provided by us. However, the Service may be changed, suspended or cancelled at our option without prior notice.

#### 3. Disclaimer

The User shall undertake use of the Service at its own individual responsibility, and accordingly we shall not assume any responsibility for usage of the Service by the User, including but not limited to the examples as follows.

- (1) We shall make no warranty as to completeness, legality, moral correctness, recentness, and appropriateness of the Service and the User shall assume full risk and individual responsibility for using the Service.
- (2) We shall assume no responsibility for any loss or damage that may be incurred by the User due to its use of or inability to use the Service, regardless of whether such loss or damage is direct or indirect, foreseeable or unforeseeable, including but not limited to special damages.
- (3) We shall not be involved in nor assume responsibility for any acts, problems, and other issues between Users.
- (4) Should any third parties suffer losses or damages as a result of the User's use of the Service, we shall assume no responsibility therefor.
- (5) Should the User suffer losses or damages from misuse by any third parties of the User's registered user account name or password for the Service, we shall assume no responsibility therefor.



#### 4. Prohibited Matters

Concerning the use of the Service, the following or similar acts by the User are prohibited. Further, should we determine that the User has violated the terms of this Agreement, we reserve the right to suspend use of the Service by the User without prior notice, or take other necessary measures as we may deem necessary. In such case, we bear no obligation to disclose our reasons therefor.

- (1) Acts for commercial purposes or gain
- (2) Use of the account name or password of his own or any third parties for improper purposes
- (3) Infringement or acts that may likely infringe on the intellectual property rights of third parties (including but not limited to copyrights, design rights, patent, utility model rights, trademark, trade secrets, and know-how)
- (4) Infringement or acts that may likely infringe on the proprietary rights, honor, trustworthiness, portrait rights, privacy, publicity rights, and other rights or profits
- (5) Dissemination or distribution or acts that may likely constitute dissemination or distribution of contents that may be offensive to public morals and ethics, or defamatory to third parties
- (6) Criminal acts, acts associated with criminal acts, or acts that may likely be criminal
- (7) Dissemination or distribution of junk mail, spam or malicious programs such as the computer viruses
- (8) Dissemination or distribution of false information
- (9) Obstruction or acts that may likely constitute obstruction of the operation of the Service
- (10) Acts that cause or that may likely cause trouble, disadvantages or damages to us or third parties
- (11) Use of the Service for illegal purposes
- (12) Other acts deemed inappropriate by us

#### 5. Compensation Claim

Should any complaints, lawsuits or similar claims be asserted against us by other Users or third parties for any reasons attributable to the User in connection with the Service, we reserve the right to claim from the concerned User any damages, costs and expenses which we may incur (including compensation, attorney fees and legal costs).

#### 6. Ownership of Intellectual Property Rights

All intellectual property rights (including but not limited to copyrights, design rights, patent, utility model rights, trademark, trade secrets, and know-

how), the portrait rights, privacy, publicity rights and other personal rights, and proprietary rights or other property rights of the information, text, image, program, layout, design, architecture, and others related to the Service are owned by us, or provided to us under license from the rights holder except for the rights of the thing which are made by User. The unauthorized copying, alteration, or sublicensing of such intellectual property rights, in whole or in part, without our consent may be prohibited by applicable law.

Further, our trade names, trademarks, logo marks and product names, some of which are registered, are used as names and symbols for commercial purposes. Also, trademarks, service names, symbols and other marks belonging to other parties, such as companies and individuals, are also included in the Service.

#### 7. Use of Public Information

We may save and store all information (including but not limited to text information, image information, and others) that were released, posted, uploaded, or saved by User via the Service. Furthermore, User shall agree that we may use such information as described previously in every possible condition toward smooth operation and improvement of the Service.

#### 8. Usage Fee

The Service shall be offered without charge to the User. However, the environment that is necessary for use this Service shall be prepared by User on his own responsibility and liability including any miscellaneous expenses such as provider, electricity, packet communication, and others.

#### 9. User Information

In order to take advantage of the Service, the User must first register user account name, password, the User's valid e-mail address and arbitrary User's information via the next page (collectively "Information"). We shall properly manage and keep Information as important data in conformity with our "Privacy Policy" and shall only use Information for issuing notices regarding completion of registration, maintenance of Service, suspension of Service, and procedures for reissuance of passwords. We shall not disclose Information for any purposes other than the foregoing without the prior consent of the User.

#### 10. Governing Law

The Agreement shall be governed by and construed in accordance with the laws of Japan.

## ■ FCC WARNING

This equipment may generate or use radio frequency energy. Changes or modifications to this equipment may cause harmful interference unless the modifications are expressly approved in the instruction manual. The user could lose the authority to operate this equipment if an unauthorized change or modification is made.

### NOTE

This equipment has been tested and found to comply with the limits for a Class B digital device, pursuant to Part 15 of the FCC Rules. These limits are designed to provide reasonable protection against harmful interference in a residential installation.

This equipment may cause harmful interference to radio communications, if it is not installed and used in accordance with the instructions. However, there is no guarantee that interference will not occur in a particular installation. If this equipment does cause harmful interference to radio or television reception, which can be determined by turning the equipment off and on, the user is encouraged to try to correct the interference by one or more of the following measures:

- Reorient or relocate the receiving antenna.
- Increase the separation between the equipment and receiver.
- Connect the equipment into an outlet on a circuit different from that to which the receiver is connected.
- Consult the dealer or an experienced radio/TV technician for help.

- Contains Transmitter Module  
FCC ID : YZP-RBFAC21XX
- Contains Transmitter Module  
IC: 7414A-RBFAC21XX

## ■ IC (Industry Canada) Notice

This device complies with Industry Canada licence-exempt RSS standard(s).

Operation is subject to the following two conditions:

- (1) This device may not cause interference, and
- (2) this device must accept any interference, including interference that may cause undesired operation of the device.

The term "IC:" before the certification/ registration number only signifies that the Industry Canada technical specification were met.

## ▲ CAUTION

This equipment complies with FCC/IC radiation exposure limits set forth for an uncontrolled environment and meets the FCC radio frequency (RF) Exposure Guidelines in Supplement C to OET65 and RSS-102 of the IC radio frequency (RF) Exposure rules. This equipment has very low levels of RF energy that it deemed to comply without maximum permissive exposure evaluation (MPE). But it is desirable that it should be installed and operated keeping the radiator at least 20cm or more away from person's body (excluding extremities: hands, wrists, feet and ankles).

Under Industry Canada regulations, this radio transmitter may only operate using an antenna of a type and maximum (or lesser) gain approved for the transmitter by Industry Canada. To reduce potential radio interference to other users, the antenna type and its gain should be so chosen that the equivalent isotropically radiated power (e.i.r.p.) is not more than that necessary for successful communication.

## ▲ CAUTION

Use of controls or adjustments or performance of procedures other than those specified herein may result in hazardous radiation exposure.

In compliance with Federal Regulations, following are reproductions of labels on, or inside the product relating to laser product safety.

JVC KENWOOD Corporation  
2967-3, ISHIKAWA-MACHI,  
HACHIOJI-SHI, TOKYO, JAPAN

THIS PRODUCT COMPLIES WITH DHHS  
RULES 21 CFR SUBCHAPTER J IN EFFECT AT  
DATE OF MANUFACTURE.

Location: Top plate

### About QAU0568 (USB Wi-Fi® Adapter) (DNN992)

### About QAU0569 (USB Wi-Fi® Adapter) (DNN9150BT)

The Wi-Fi Adapter is attached to this unit when shipped from the factory. When the adapter is removed, store it in a safe place.

### Acerca de QAU0568 (adaptador USB-Wi-Fi®) (DNN992)

### Acerca de QAU0569 (adaptador USB-Wi-Fi®) (DNN9150BT)

El adaptador Wi-Fi viene acoplado a esta unidad cuando se envía de fábrica. Cuando retire el adaptador, guárdelo en un lugar seguro.

DNN9150BT:

■ The marking of products using lasers

**CLASS 1  
LASER PRODUCT**

The label is attached to the chassis/case and says that the component uses laser beams that have been classified as Class 1. It means that the unit is utilizing laser beams that are of a weaker class. There is no danger of hazardous radiation outside the unit.

■ La marca para los productos que utilizan láser

**CLASS 1  
LASER PRODUCT**

Esta etiqueta está colocada en el chasis e indica que el componente funciona con rayos láser de clase 1. Esto significa que el aparato utiliza rayos láser considerados como de clase débil. No existe el peligro de que este aparato emita al exterior una radiación peligrosa.

### Información acerca de la eliminación de equipos eléctricos y electrónicos al final de la vida útil (aplicable a los países que hayan adoptado sistemas independientes de recogida de residuos)



Los productos con el símbolo de un contenedor con ruedas tachado no podrán ser desechados como residuos domésticos.

Los equipos eléctricos y electrónicos al final de la vida útil, deberán ser reciclados en instalaciones que puedan dar el tratamiento adecuado a estos productos y a sus subproductos residuales correspondientes. Póngase en contacto con su administración local para obtener información sobre el punto de recogida más cercano. Un tratamiento correcto del reciclaje y la eliminación de residuos ayuda a conservar los recursos y evita al mismo tiempo efectos perjudiciales en la salud y el medio ambiente.

### Para cumplimiento de la COFETEL:

“La operación de este equipo esta sujeta a las siguientes dos condiciones:

- (1) es posible que este equipo o dispositivo no cause interferencia perjudicial y
- (2) este equipo o dispositivo debe aceptar cualquier interferencia, incluyendo la que pueda causar su operación no deseada.”

### Informação sobre a eliminação de pilhas

Este produto não deve ser eliminado como lixo doméstico geral. Devolva a pilha usada ao revendedor ou entidade autorizada para que a mesma seja devolvida ao fabricante ou importador.

A reciclagem e a eliminação de lixo de maneira apropriada ajudarão a conservar os recursos naturais ao mesmo tempo que prevenirão os efeitos prejudiciais à nossa saúde e ao meio ambiente.



**HD Radio®**

This HD Radio receiver enables:

PSD)

HD2/HD3)

Bookmark)

Digital Sound)

Artist Experience)

**KENWOOD**

## DNN992 DNN9150BT

### CONNECTED NAVIGATION SYSTEM INSTRUCTION MANUAL

JVC KENWOOD Corporation

Before reading this manual, click the button below to check the latest edition and the modified pages.

<http://manual.kenwood.com/edition/im387/>

**Take the time to read through this instruction manual.**

**Familiarity with installation and operation procedures will help you obtain the best performance from your new Navigation System.**

**For your records**

Record the serial number, found on the back of the unit, in the spaces designated on the warranty card, and in the space provided below. Refer to the model and serial numbers whenever you call upon your Kenwood dealer for information or service on the product.

Model DNN992/ DNN9150BT Serial number \_\_\_\_\_

***US Residence Only***

**Register Online**

Register your Kenwood product at [www.Kenwoodusa.com](http://www.Kenwoodusa.com)



# What Do You Want To Do?

Thank you for purchasing the KENWOOD CONNECTED SYSTEM.  
In this manual, you will learn various convenient functions of the system.

**Click the icon of the media you want to play.**

With one-click, you can jump to the section of each media!

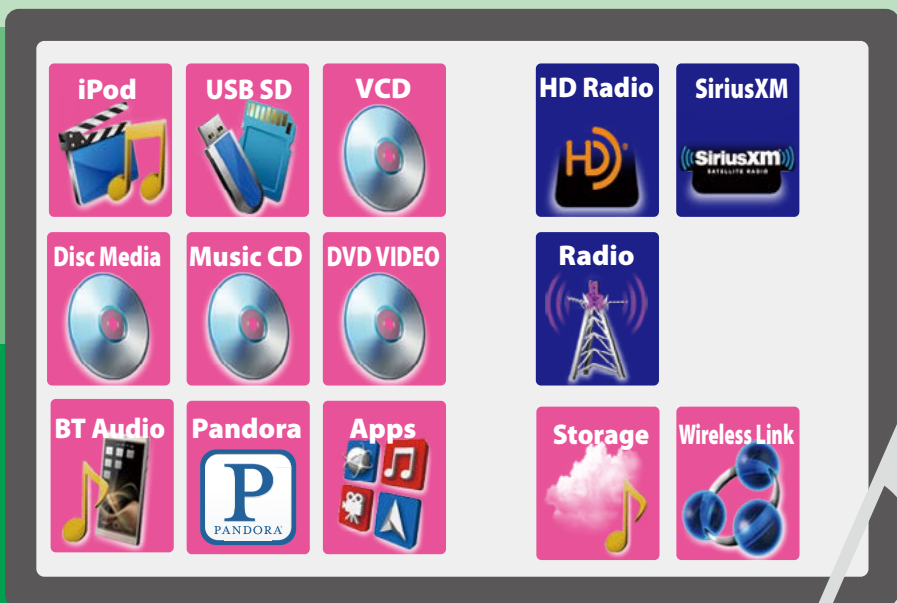

# Contents

<b>Before Use</b>	<b>4</b>	<b>Widget and Application</b>	<b>42</b>
▲ WARNING _____	4	<b>Operation</b>	<b>42</b>
<b>How to Read this Manual</b>	<b>6</b>	Weather Widget (DNN992) _____	42
<b>Features of Connected systems</b>	<b>8</b>	Weather Application (DNN992) _____	43
<b>Basic Operations</b>	<b>10</b>	SNS Widget _____	45
Functions of the Buttons		RSS Widget _____	45
on the Front Panel _____	10	Facebook (SNS Application) _____	46
Turning on the Unit _____	12	Twitter (SNS Application) _____	48
How to Play Media _____	18	E-mail (SNS Application) _____	50
Operation on the Home Screen _____	20	RSS Application _____	52
Common Operation _____	24	Now playing Widget _____	54
Navigation Operation _____	26	Photo Frame Widget _____	56
OEM Feature Operation (DNN992) _____	30	Mixed Media Search _____	57
<b>Network Setup</b>	<b>32</b>	<b>DVD/Video CD (VCD)</b>	
Wi-Fi Setup _____	32	<b>Operation</b>	<b>58</b>
Wi-Fi Hotspot Setup _____	34	DVD/VCD Basic Operation _____	58
4G/ 3G Dongle Setup (DNN992) _____	35	DVD Disc Menu Operation _____	61
<b>Clock and Date Setup</b>	<b>36</b>	Zoom Control for DVD and VCD _____	62
Clock and Date Setup _____	36	DVD Setup _____	63
<b>Account Setup</b>	<b>38</b>	<b>CD/Audio and Visual Files/iPod/</b>	
About Account _____	38	<b>Apps Operation</b>	<b>66</b>
Create User Account _____	38	Music/Video Basic Operation _____	66
Set Owner Account _____	39	Search Operation _____	72
Set User Account _____	40	Movie Control _____	76
Switch the User Login _____	40	Pandora® Operation _____	77
Delete User Account _____	41	Apps Operation _____	80
Reset Owner Account _____	41	USB/SD/iPod/App/DivX Setup _____	81
		<b>Cloud Storage Operation</b>	<b>86</b>
		Starting procedure _____	86
		Music Basic Operation _____	86
		Category search _____	87
		<b>Kenwood Wireless Link</b>	
		<b>Operation</b>	<b>88</b>
		Starting procedure _____	88
		Media Server function _____	89
		Media Player function _____	89
		Media Controller function _____	90
		Media Renderer function _____	91

<b>Radio, HD Radio™ tuner</b>	<b>92</b>
<b>Operation</b>	
About HD Radio™ Technology _____	92
Radio/ HD Radio tuner Basic Operation _	93
Memory Operation _____	95
Selecting Operation _____	95
Traffic Information (HD Radio tuner only) _	97
Receive Mode (HD Radio tuner only) ____	98
Bookmark _____	98

<b>SiriusXM® Satellite Radio</b>	<b>100</b>
<b>Operation (DNN992)</b>	
SiriusXM® Basic Operation _____	100
Memory Operation _____	103
Selecting Operation _____	103
Content Alert _____	105
Replay _____	106
Smart Favorites, TuneStart™ _____	107
TuneScan™ _____	107
SiriusXM Setup _____	108

<b>Streaming Service Application</b>	<b>112</b>
AUPEO! Application _____	112
AV Browser Application _____	114

<b>Bluetooth Control</b>	<b>116</b>
Registering and Connecting Bluetooth Unit _____	116
Playing Bluetooth Audio Device _____	119
Using Hands-Free Feature _____	120
Hands-Free Setup _____	124

<b>Voice Control (DNN992)</b>	<b>126</b>
Voice Control _____	126

<b>Camera Control</b>	<b>127</b>
Camera Control _____	127
Switching the View Camera _____	127

<b>Setting Up</b>	<b>128</b>
Monitor Screen Setup _____	128
System Setup _____	129
Display Setup _____	132
Navigation Setup _____	134
Camera Setup _____	134
Software Information _____	136
AV Input Setup _____	137
AV Output Interface Setup _____	137
External Device Control _____	138

<b>Controlling Audio</b>	<b>140</b>
Setting Audio _____	140
Controlling General Audio _____	143
Equalizer Control _____	144
Zone Control _____	145
Sound Effect _____	146
Listening Position _____	148

<b>Remote Control</b>	<b>150</b>
Battery Installation _____	150
Functions of the Remote Control Buttons _	151

<b>Troubleshooting</b>	<b>154</b>
Problems and Solutions _____	154
Error Messages _____	155
Resetting the Unit _____	157

<b>Appendix</b>	<b>158</b>
Playable Media and Files _____	158
Status Bar Indicator Items _____	161
Region Codes in the World _____	163
DVD Language Codes _____	164
Specifications _____	165
Trademarks _____	168
Safety precaution _____	171



## Before Use

### ⚠ WARNING

#### ■ To prevent injury or fire, take the following precautions:

- To prevent a short circuit, never put or leave any metallic objects (such as coins or metal tools) inside the unit.
- Do not watch or fix your eyes on the unit's display when you are driving for any extended period.
- If you experience problems during installation, consult your Kenwood dealer.

#### ■ Precautions on using this unit

- When you purchase optional accessories, check with your Kenwood dealer to make sure that they work with your model and in your area.
- You can select language to display menus, audio file tags, etc. See [Language setup \(P.130\)](#).
- The Radio Data System or Radio Broadcast Data System feature won't work where the service is not supported by any broadcasting station.

#### ■ Protecting the monitor

To protect the monitor from damage, do not operate the monitor using a ball point pen or similar tool with the sharp tip.

#### ■ Cleaning the unit

If the faceplate of this unit is stained, wipe it with a dry soft cloth such as a silicon cloth. If the faceplate is stained badly, wipe the stain off with a cloth moistened with neutral cleaner, then wipe it again with a clean soft dry cloth.



- Applying spray cleaner directly to the unit may affect its mechanical parts. Wiping the faceplate with a hard cloth or using a volatile liquid such as thinner or alcohol may scratch the surface or erase screened print.

#### ■ Lens fogging

When you turn on the car heater in cold weather, dew or condensation may form on the lens in the disc player of the unit. Called lens fogging, this condensation on the lens may not allow discs to play. In such a situation, remove the disc and wait for the condensation to evaporate. If the unit still does not operate normally after a while, consult your Kenwood dealer.

#### ■ Precautions on handling discs

- Do not touch the recording surface of the disc.
- Do not stick tape etc. on the disc, or use a disc with tape stuck on it.
- Do not use disc type accessories.
- Clean from the center of the disc and move outward.
- When removing discs from this unit, pull them out horizontally.
- If the disc center hole or outside rim has burrs, use the disc only after removing the burrs with a ballpoint pen etc.
- Discs that are not round cannot be used.

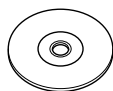

- 8-cm (3 inch) discs cannot be used.
- Discs with coloring on the recording surface or discs that are dirty cannot be used.
- This unit can only play the CDs with . This unit may not correctly play discs which do not have the mark.
- You cannot play a disc that has not been finalized. (For the finalization process see your writing software, and your recorder instruction manual.)

## Erase the personal information

Before giving or selling this unit to others, be sure to delete the information (mail, search logs, etc.) stored in this unit by yourself and confirm that the data has been deleted.

We shall not be liable for any damage caused by leakage of undeleted data.

### 1 Press the <HOME> button.



### 2 Press the <MENU> button.



### 3 Touch [Setting].



### 4 Touch [Backup & Reset].

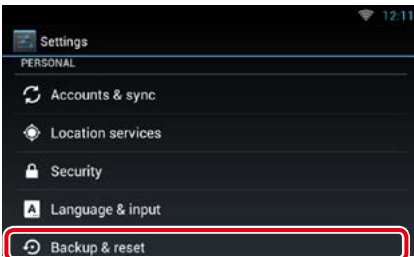

### 5 Touch [Factory data reset].

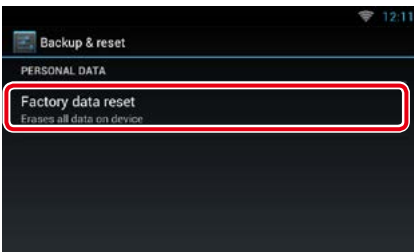

### 6 Enter owner password. Touch [Reset].



### 7 Touch [ERASE].

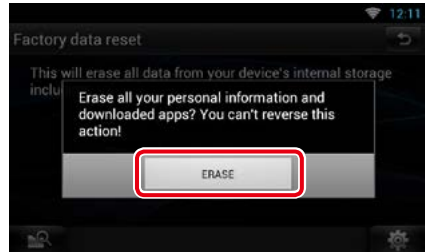

# How to Read this Manual

[Return to the Top page](#)

[CD/Audio and Visual Files/iPod/Apps Operation](#)

## Search Operation

You can search music, video or picture files by the following operations.

### NOTE

- If you use a remote controller, you can jump directly to the desired track/file with entering the track/folder/file number, play time, etc. For details, see [Direct search mode \(P.155\)](#).

### List search

You can search tracks, folders, and files according to hierarchy.

#### 1 Touch illustrated area.

List Control screen appears.

#### 2 Touch desired track/file.

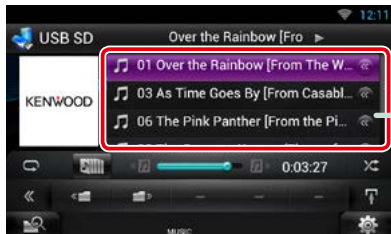

Playback starts.

### Other search

When you want to narrow the list down, there are other search ways.

This function is not available when music CD is the current source.

#### 1 Touch [ ] in the control screen.

The search type screen appears.

#### 2 Touch desired search way.

### Link header

You can refer each section or top page with one-click.

### Operation title

Introduces the function.

### NOTE

Introduces some tips, notes, etc.

### Reference mark

Displayed in blue notes.

With one-click, you can jump to the article related to the current section.

### Operation procedure

Explains necessary procedures to achieve the operation.

< >: Indicates the name of panel buttons.

[ ]: Indicates the name of touch keys.

### Screen shot

Shows some screen shots displayed during operation for reference.

The area or keys to touch are surrounded with a red frame.

### NOTE

- The screens and panels shown in this manual are examples used to provide clear explanations of the operations. For this reason, they may be different from the actual screens or panels used, or some display patterns may be different.



## Features of Connected systems

By connecting this unit to Internet, you can use various services.

### Cooperation with Route Collector site

- Destinations and routes specified on the PC can be input to this navigation system.
- The routes you have traveled and the songs you have listened to can be logged. [\(P.27\)](#)
- By uploading music files to Dropbox and creating a play list on Route Collector site, you can listen to music anywhere through streaming without music files on this unit. [\(P.86\)](#)
- Speech to Text (STT) and Text to Speech (TTS).

### Use of internet service

- Streaming service such as Aupeo!, iHeartRadio\*.
- Internet service such as email, and social networking service such as Facebook and Twitter.
- Information (weather\*, traffic\*, RSS, etc.) service.

### About the account

- To use internet services via this system, you need to create an account in the Route Collector site.
- In addition to the owner account, you can register up to four user accounts.
- You can use a guest account as well.
- By switching among accounts, you can secure the privacy when using the mail feature or social media.

For details, see [About Account \(P.38\)](#).  
<http://www.route-collector.com/>

### Notes

You can use following feature for 2 years after registration of the owner account. To use it continuously, a usage fee is required. For details, see web site of Route Collector.

<http://www.route-collector.com/>

- Weather (by INRIX)\*
- Traffic (by INRIX)\*
- Dynamic Parking (by INRIX)\*
- Fuel Prices (by INRIX)\*
- Real-Time Traffic Camera (by INRIX)\*
- Movie Show Times (by WWM)\*
- TTS (by Nuance)
- STT (by Nuance)

To use the following services, you need to register the corresponding free or paid accounts.

- Aupeo!
- Facebook
- Twitter
- Dropbox
- iHeartRadio\*

\* DNN992 only

### Wi-Fi access point

- Connect to Internet using the tethering function of your smartphone or an Internet device. [\(P.32\)](#)

### Wi-Fi hotspot

- This unit becomes the Wi-Fi access point and you can enjoy music and video in a smartphone Wi-Fi connected by Kenwood Wireless Link. [\(P.34\)](#)

### 4G, LTE, 3G or EDGE

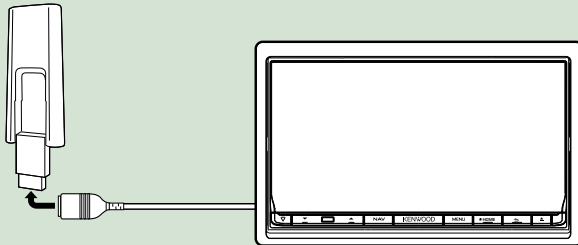
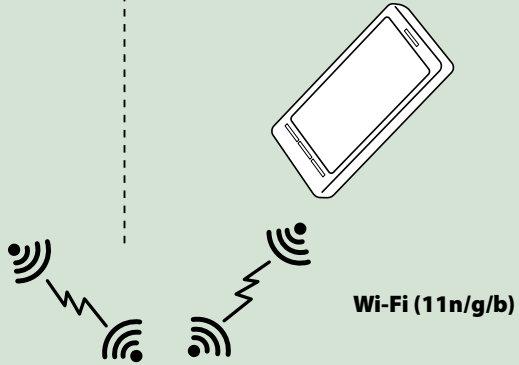
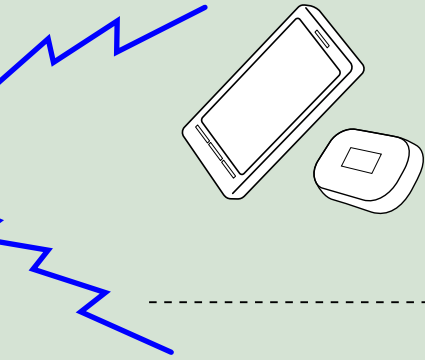

### 4G/ 3G Dongle (DNN992)

- Connect to the Internet directly with 4G/3G Dongle. The Internet device like smartphone is not necessary. [\(P.35\)](#)
- You can also connect to the Internet while using the Wi-Fi Hotspot mode.

- Media player for DVD video, CD, USB memory, SD card\*, iPod, etc.
- HD Radio Technology and SiriusXM Satellite Radio. (DNN992)
- Radio
- Navigation

## Basic Operations

### Functions of the Buttons on the Front Panel

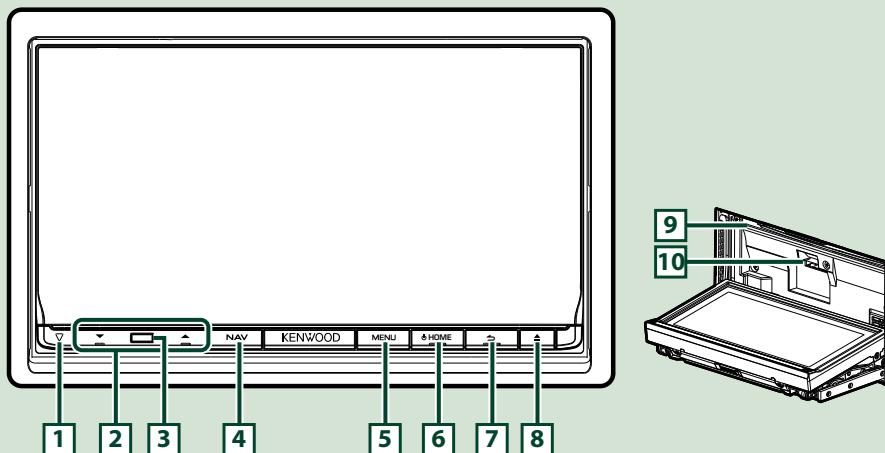

#### NOTE

- The panels shown in this guide are examples used to provide clear explanations of the operations. For this reason, they may be different from the actual panels.

### How to insert an SD Card

- 1) Press **[8] <▲>** button for 1 second.  
The panel fully opens.
- 2) Hold the SD card as the illustration in the right and insert it into the slot until it clicks.

#### ● To eject the card:

Push the card until it clicks and then remove your finger from the card.

The card pops up so that you can pull it out with your fingers.

Labelled side

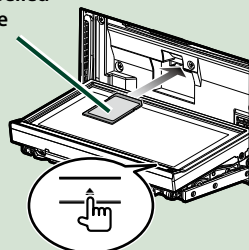

Number	Name	Motion
<b>1</b>	▽ (Reset)	<ul style="list-style-type: none"> <li>If the unit or the connected unit fails to operate properly, the unit returns to initial settings when this button is pressed <a href="#">(P.157)</a>.</li> <li>If the SI function is turned on, this indicator flashes when the vehicle ignition is off <a href="#">(P.130)</a>.</li> </ul>
<b>2</b>	▼, ▲ (Vol)	Adjusts volume.
<b>3</b>	Remote Sensor	Receives the remote control signal.
<b>4</b>	NAV	<ul style="list-style-type: none"> <li>Displays the navigation screen.</li> <li>Pressing for 1 second switches camera view display on/off.*1</li> </ul>
<b>5</b>	MENU	<ul style="list-style-type: none"> <li>Displays the option menu screen.</li> <li>Pressing for 1 second switches AV out sources.</li> </ul>
<b>6</b>	HOME	<ul style="list-style-type: none"> <li>Displays the Home screen <a href="#">(P.20)</a>.</li> <li>Pressing for 1 second turns the power off.</li> <li>When the power off, turns the power on.</li> </ul>
<b>7</b>	↶ (Back)	<ul style="list-style-type: none"> <li>Return to the previously viewed screen.</li> <li>Pressing for 1 second displays the Hands Free screen <a href="#">(P.120)</a>.</li> </ul>
<b>8</b>	▲ (Eject)	<ul style="list-style-type: none"> <li>Ejects the disc.</li> <li>When the panel is opened, pressing closes the panel and pressing for 1 second ejects the disc forcibly.</li> <li>When the panel is closed, pressing for 1 second fully opens the panel to the location of the SD card slot.</li> </ul>
<b>9</b>	Disc insert slot	A slot to insert a disc media.
<b>10</b>	SD card slot	<ul style="list-style-type: none"> <li>A slot to insert an SD card.</li> <li>An SD card slot for upgrading the map. For how to upgrade the map, refer to the instruction manual of the navigation system.</li> <li>DNN992: You can play audio/visual file in the card. *2</li> </ul>

\*1 The function of the [NAV] button can be changed to the display off function. See [User interface \(P.129\)](#).

\*2 If the map update file remains in the SD card, you cannot play audio/visual file.



## Turning on the Unit

- 1 Press the <HOME> button.

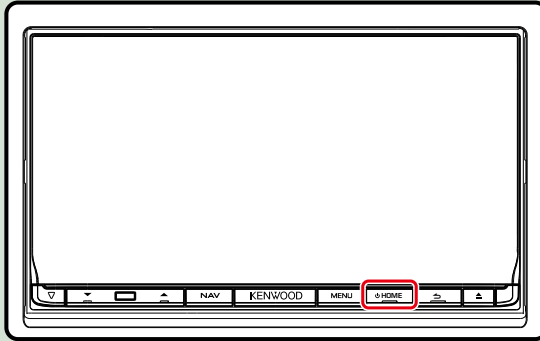

The unit is turned on.

- **To turn off the unit:**  
Press the <HOME> button for 1 second.

If it is your first time turning the unit on after installation, it will be necessary to perform [Initial setup \(P.14\)](#).

## Login

### 1 Select the login user.

#### *When the owner has not been registered*



#### *When the owner has been registered*



### 2 Enter the password.

When you selected Administrator or Guest, you do not need to enter a password.



[Auto Login?]: Checking this checkbox allows you to log in to the system automatically from the next time.

### 3 Touch [Login].

#### **NOTE**

- If you forgot your password, create your new password on the Route Collector site.  
<http://www.route-collector.com/>

## Initial setup

Perform this setup when you use this unit for the first time or when you reset the unit. See [Resetting the Unit \(P.157\)](#).

### 1 Set each item as follows.

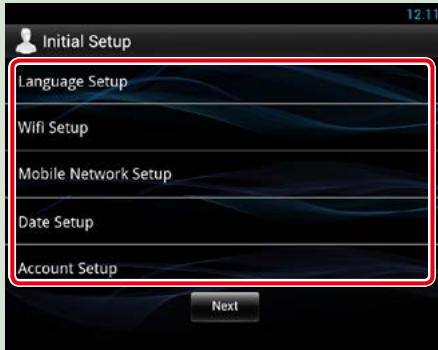

#### Language Setup

Select the language used for the GUI and input methods. Default is "English (United States)".

- ① Touch [Language Setup].
- ② Select a language from the list.

#### WiFi Setup

Configure settings for connection to Wi-Fi.

- ① Touch [WiFi Setup].
- ② Slide Wi-Fi to ON.
- ③ Touch [Wi-Fi].
- ④ Select the Wi-Fi access point to register from the list.
- ⑤ Enter the Password.
- ⑥ Touch [Connect].
- ⑦ After setting, press the < ↩ > button.

For details on operation, see [Wi-Fi Setup \(P.32\)](#).

#### Mobile Network Setup (DNN992)

Set the direct Internet connection with 4G/3G Dongle.

- ① Touch [Mobile Network Setup].
- ② Touch [Mobile Network configuration].
- ③ Enter the network information.
- ④ Touch [Save].
- ⑤ Touch [Mobile Network].
- ⑥ After setting, press the < ↩ > button.

For details on operation, see [4G/3G Dongle Setup \(P.35\)](#).

### Date Setup

Set the date and time.

- ① Touch [Date Setup].
- ② After setting, press the < ⏪ > button.

For details on operation, see [Clock and Date Setup \(P.36\)](#).

### Account Setup

Set the information about the user of this unit.

- ① Touch [Account Setup].

For details on operation, see [About Account \(P.38\)](#).

## 2 Touch [Next].

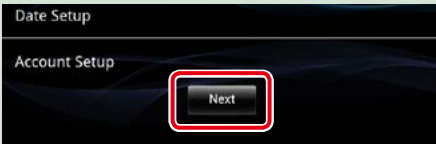

*Continued*

### 3 Set each item as follows.



#### Locale

Select the country for the navigation system.  
The language, the distance unit, and the gasoline unit are set.

- ① Touch [SET].
- ② Select the desired country.

#### Language

Select the language used for the control screen and setting items. Default is "American English (en)".

- ① Touch [SET].
- ② Touch [◀] or [▶] to select the desired language.
- ③ Touch [Enter].

For details on operation, see [Language setup \(P.130\)](#).

#### Angle

Adjust the position of the monitor. Default is "0".

- ① Touch [SET].
- ② Touch desired angle number and [↔].

For details on operation, see [Monitor angle control \(P.132\)](#).

## Color

Set the screen and button illumination color. You can select whether to allow color scan operation or select a fixed color for operation.

- ① Touch [SET].
- ② Touch [ON] or [OFF] of [Panel Color Scan].
- ③ If you want to change color, touch [SET] of [Panel Color Coordinate].
- ④ Touch your desired color and [↔].

For details on operation, see [Panel color coordinate \(P.133\)](#).

## EXT SW

Control the external devices.

- ① Touch [SET].
- ② Set output pattern, and pulse set for device. Then, touch [↔].

For details on operation, see [EXT SW setup \(P.131\)](#).

## Camera

Set the parameters for the camera.

- ① Touch [SET].
- ② Set each item and touch [↔].

For details on operation, see [Camera Setup \(P.134\)](#).

## OEM SETUP (North America Sales area only)

This function requires a commercial adaptor.  
Consult your Kenwood dealer for details.

## DEMO

Set the demonstration mode. Default is "ON".

- ① Touch [ON] or [OFF].

## 4 Touch [Finish].



## NOTE

- These settings can be set from the SETUP menu. See [Setting Up \(P.128\)](#).

## How to Play Media

### Music CD and disc media

- 1 Press the <▲> button.

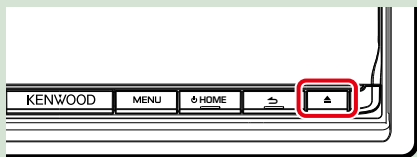

The panel opens.

- 2 Insert the disc into the slot.

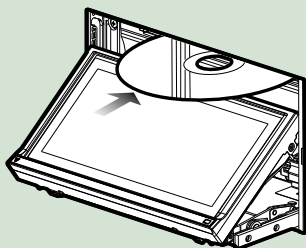

The panel closes automatically.

The unit loads the disc and playback starts.

- **To eject the disc:**  
Press the <▲> button.

### USB device

- 1 Connect the USB device with the USB cable.

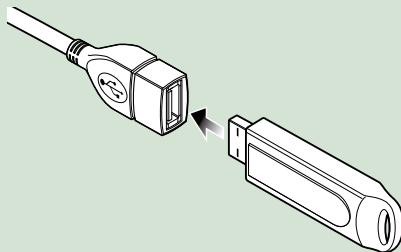

The unit reads the device and playback starts.

- **To disconnect the device:**  
Touch [▲] on the screen and disconnect the device from the cable.

## iPod

### 1 Connect the iPod.

#### NOTE

- For the details of the necessary cable and adapter to connect with iPod/iPhone, refer to [Music/Video Basic Operation \(P.66\)](#).

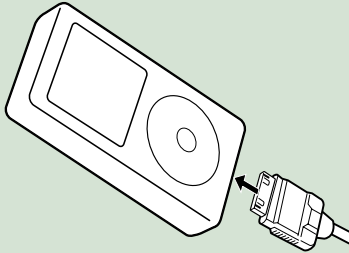

The unit reads the iPod and playback starts.

- **To disconnect the iPod/iPhone connected with the cable:**  
Touch [▲] on the screen and disconnect the device from the cable.

## SD card (DNN992)

### 1 Press the <▲> button for 1 second to open the front panel.

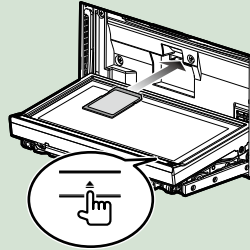

The panel fully opens.

### 2 Hold the SD card as the diagram below and insert it into the slot until it clicks.



The unit loads the card and playback starts.

- **To remove:**  
Push the SD card until it clicks and then remove your finger from the card.  
The card pops up so that you can pull it out with your fingers.



## Operation on the Home Screen

Most functions can be operated on the Home screen.

- 1 Press the <HOME> button.

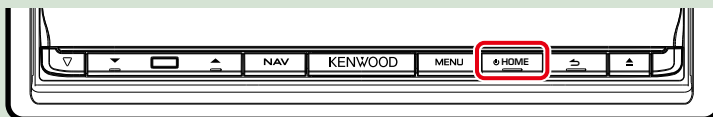

Home screen appears.

- 2 Flick the screen left or right to select the Service panel, Media panel, Source launcher panel, or Network contents panel.

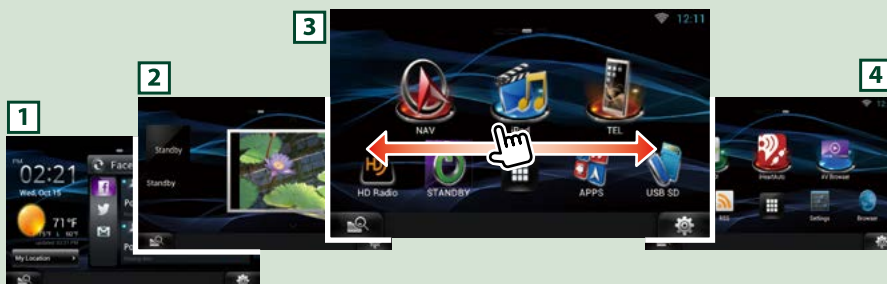

Panel	Description
1 Service panel	Weather widget: Displays the weather forecast for the selected region. Network widget: Displays the SNS, or RSS.
2 Media panel	Now playing: Displays the title of the song being played or the name of the station you are listening to, and allows you to perform simple operations. Photo Frame Widget: Displays the Photo frame that shows photos.
3 Source launcher panel	Allows you select a source.
4 Network contents panel	Allows you to select a network-related application.

## Source launcher panel and Network contents panel



### (Shortcut)

You can register sources and applications you use frequently so that you can start them quickly.

### (All source list/ All apps list)

Displays all sources and applications.

### All source list/ All apps list

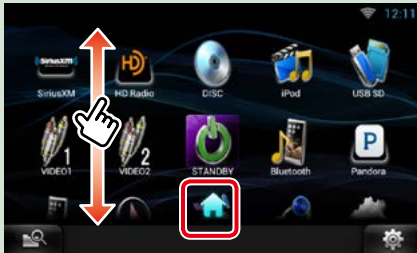

### (All source list/ All apps list)

You can scroll the list screen by flicking the screen up/down.

### (Home)

Returns to the Source launcher panel or the Network contents panel.

From All source list, you can perform the following functions.

Function	Icon	Operation
Switch the audio source	  etc.	Touch the icon of the desired source.
Switch the video source	  etc.	Touch the icon of the desired video source.
Display navigation screen	 or 	Touch [NAV] or navigation information.
Turn off all audio function		Touch [STANDBY].
Vehicle information display		Touch [OEM].

### Moving or deleting of an icon on the Source launcher panel and Network contents panel

- 1 Touch and hold the icon.
- 2 Drag the icon to the desired position or Recycle Bin.

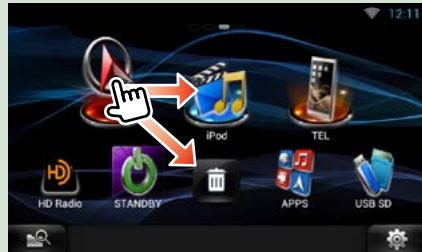

### Adding of a shortcut icon to Source launcher panel or Network contents panel

- 1 Touch [  ] in Source launcher panel or Network contents panel.
- 2 Touching the icon continuously to display the Source launcher panel or Network contents panel screen.
- 3 Drag the icon to an empty space.

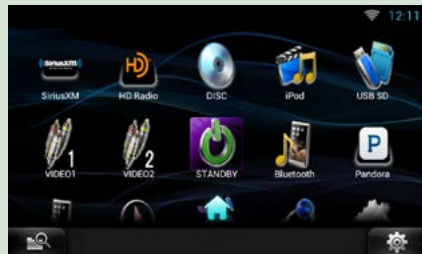

### Media panel

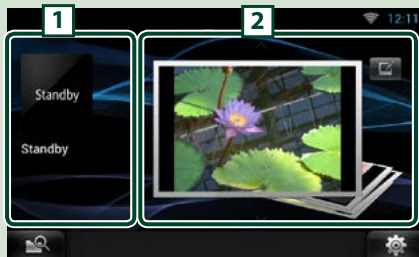

#### 1 Now playing widget

Displays the title of the song being played or the name of the station you are listening to, and allows you to perform simple operations. See [Now playing Widget \(P.54\)](#).

#### 2 Photo Frame Widget

Displays the Photo frame that shows photos. See [Photo Frame Widget \(P.56\)](#).

### Service panel



#### 1 Weather widget

DNN992: Displays the today's weather forecast. See [Weather Widget \(P.42\)](#).  
DNN9150BT: Displays the clock and date.

#### 2 Network widget

Touching [  ] allows you to switch between RSS, and SNS. See [SNS Widget \(P.45\)](#), [RSS Widget \(P.45\)](#).

## Change the skin for home screen

---

You can select a home screen skin from 3 types.

**1** Press the <MENU> button.

**2** Touch [  Theme ].

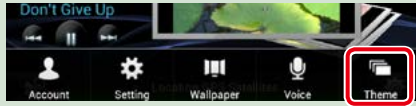

**3** Select a skin.

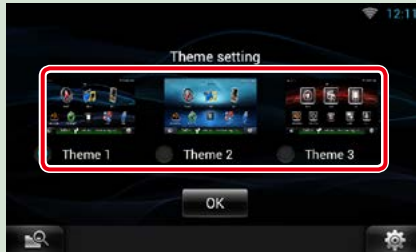

**4** Touch [OK].

# Common Operation

Introduces the common operation.

## General

There are some functions which can be operated from most screens.



### Quick menu screen



#### (Mixed Media Search)

Touch to display the Mixed Media Search screen. [\(P.57\)](#)



#### (Quick menu)

Touch to display the quick menu. The content of the menu are as follows.



: Touch to turn on or off the external device power supply.



: Displays the SETUP Menu screen.



: Displays the Audio Control Menu screen.



: Displays the control screen of current source. Icon feature differs depending on the source.

## List screen

There are some common function keys in the list screens of most sources.

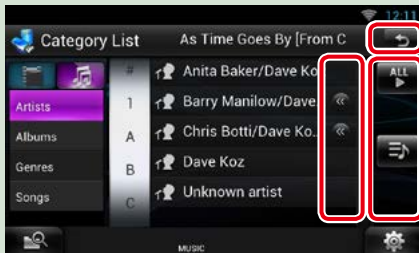

#### (Scroll)

Touch to scroll through texts on the display.



#### etc.

Touch keys with various functions are displayed here.

Displayed keys differ depending on the current audio source, status, etc.

For examples of functions of each key, refer to the table below.



Returns to previous screen.

Key	Function
	Lists all the music in the lower hierarchy.
	Moves to the upper hierarchy.
	Displays current category folder.
	Displays music/movie file list.

## Flick scrolling

You can scroll the list screen by flicking the screen up/down or right/left.

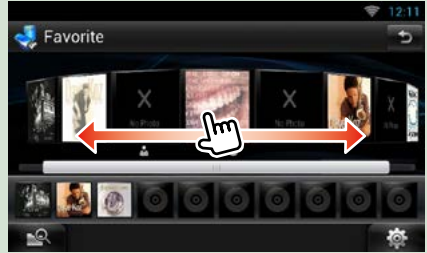
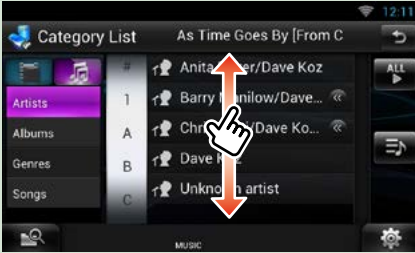

## Navigation Operation

For details on the navigation function, please refer to the Navigation Instruction Manual.

### Display the navigation screen

- 1 Press the <NAV> button.

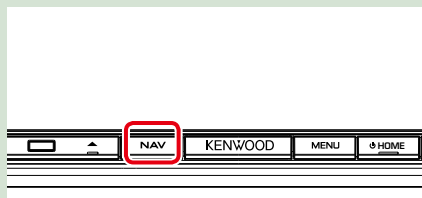

The navigation screen appears.

### Control audio from the navigation screen

You can control audio sources while the navigation screen is displayed.

Also, you can view the navigation information while the source control screen is displayed.

- 1 Touch the information bar.

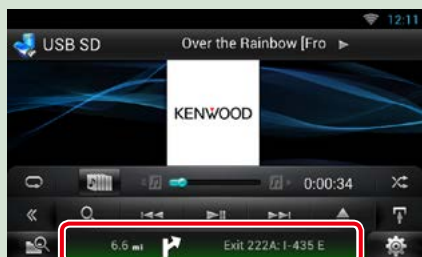

The navigation screen with audio information appears.

- 2 Touch [ ] or [ ] in the navigation screen.



Touching this area displays the audio screen.

: Displays the navigation and control keys of the current source.



: Displays the navigation and current video playback display.



#### NOTE

- The screen switches between playback screen and camera view each time the viewing area is touched.
- Touching the source icon in the bottom of the screen displays the full audio screen.
- AUPEO! just plays music. You cannot control it.

● **To return to the full navigation screen:**

Touch [  ].

**NOTE**

- For details on control keys, refer to the instructions in each section.

## Trip log function

You can upload the routes you traveled and the songs you listened to the Route Collector site so that you can confirm them later.

**Precaution**

- Trip log function can be used to log information such as routes you have traveled and songs you have listened to. Such information is uploaded to our Route Collector site, for later access by you through your computer. Non-personal data from this log is also kept and used by us for statistical purposes to improve the quality of our products. By selecting to use this function, you are accepting use of the data for such statistical purposes. This is an optional function that can be activated at your sole option and responsibility the procedures set forth in the left column.

**1 Press the <MENU> button in the navigation screen or source control screen.**

**2 Touch [  TripLog On].**

**3 Touch [Yes].**

When the Trip log is active, "" appears in the status bar.

**NOTE**

- You must have a connection with the internet.
- You can use the Trip log function when you have logged in the system as Owner or User.

## Where To function

You can set the destination of the navigation easily by setting the destination of the Route Collector site from your PC or your smartphone.

**1 Log in to Route Collector site by the owner account.**

<http://www.route-collector.com/>

**2 Set the destination in the Route Collector site.**

**3 You will be notified by "" icon on the status bar.**

**4 Drag the status bar downward. Touch [  ].**

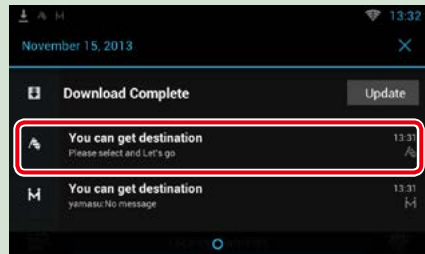

It will be set as the destination of the navigation.

**5 Touch [GO] to start the route guide.**







**NOTE**

- You can set a user account when you have logged in the Owner.
- You must have a connection with the internet.
- For the operation of the Route Collector site refer to the instruction in its website.



## Come Here function

When you go to pick up your family or friends, send them the mail to decide the meeting point. After they enter the meeting point you can easily set it as the destination of your navigation.

- 1 Press the <HOME> button.
- 2 Flick the screen left or right to select the Network contents panel.
- 3 Touch [  ].
- 4 Touch [  SNS ].
- 5 Touch [  (mail) ].
- 6 Touch [  ].

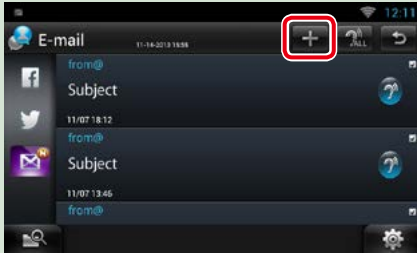

- 7 Touch [  ].

The address for setting the meeting point is added in the text part.



- 8 Enter the address, subject, etc. to complete the mail and send it.
- 9 Your family or friend will enter the meeting point.

Check the address in the mail, register as the meeting point and press Send.



- 10 You will be notified by the "M" icon on the status bar when they enter the meeting point.

- 11 Drag the status bar downward. Touch [  ].

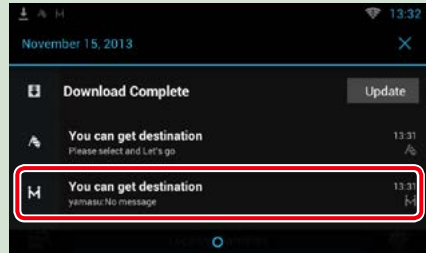

It will be set as the destination of the navigation.

- 12 Touch [GO] to start the route guide.

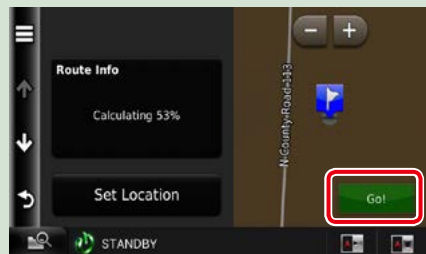

#### **NOTE**

- You must have a connection with the internet.
- The address of the meeting point is effective only 2 hours after adding the address. After that you can not enter it.
- Come Here function can be used for one person (one meeting point) at a time.

## **Tracking function**

---

**When you upload the location of your car to the Route Collector site, you can check it in case your car is stolen.**

#### **Precaution**

- Tracking function is a handy function to be used for the primary purpose of tracking the location of your vehicle. This function can also be used for secondary purposes, at your sole option and responsibility. In any event, we cannot accept any responsibility for any results of your use of the function, for whatever purpose. Should you select to use this option, please activate the function through the procedures set forth in the left column.

### **1 Log in to Route Collector site by the owner account.**

<http://www.route-collector.com/>

### **2 Set to ON the Tracking function in the Route Collector site.**



**You can check the location of your car in the Route Collector site.**

#### **NOTE**

- You must have a connection with the internet.
- You can set this function and check the location of you car only when you log in by the owner account.
- To get the correct information we recommend using 4G/3G Dongle. (DNN992 only)
- For the operation of the Route Collector site refer to the instruction in its website.

## OEM Feature Operation (DNN992)

By connecting this unit to the bus system of the vehicle using an iDataLink (commercially available), this unit can access the satellite radio source provided for the vehicle and vehicle information can be displayed on this unit.

- 1** Press the <HOME> button.
- 2** Flick the screen left or right to select the Source launcher panel.
- 3** Touch [  ].
- 4** Touch [  OEM Features].

OEM Features screen appears.

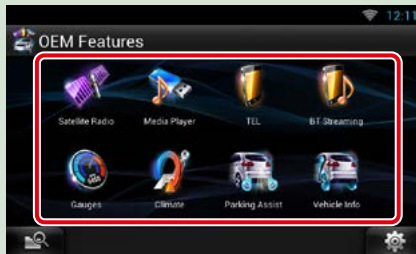

 : Displays the control screen of the satellite radio source provided for the vehicle.

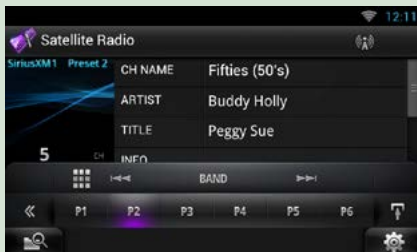

 : Displays the control screen of the media player source provided for the vehicle.



 : Displays the control screen of the Bluetooth Hands Free function provided for the vehicle.



 : Displays the control screen of the Bluetooth streaming source provided for the vehicle.



 : Displays information about the instruments such as a speedometer.



 : Displays information about the air conditioner of the vehicle.



 : Displays information about the Parking Distance Sensor of the vehicle.



 : Displays information about the tire pressures of the vehicle.



#### NOTE

- Displayable screens, button names, and screen names vary depending on the type of the connected iDataLink and the model of the vehicle. For more details, access the following URL:

[www.idatalink.com/](http://www.idatalink.com/)

# Network Setup

You can not use Wi-Fi setup and Wi-Fi Hotspot, 4G/3G Dongle setup at the same time. You can make it effective either Wi-Fi or Wi-Fi Hotspot, 4G/3G Dongle.

- [Wi-Fi Setup \(P.32\)](#)
- [Wi-Fi Hotspot Setup \(P.34\)](#)
- [4G/3G Dongle Setup \(P.35\)](#)  
(DNN992)

## Wi-Fi Setup

You can connect to a Wi-Fi access point to connect to Internet.

### Preparation

- Make preparations for using the Wi-Fi access point for Internet connection through use of the tethering function of the smartphone.
- Set to OFF the Wi-Fi Hotspot in [Wi-Fi Hotspot Setup \(P.34\)](#) and 4G/3G Dongle in [4G/3G Dongle Setup \(P.35\)](#).

- 1 Press the <HOME> button to display the Home screen.
- 2 Press the <MENU> button.
- 3 Touch [Setting].



### 4 Slide Wi-Fi to ON.

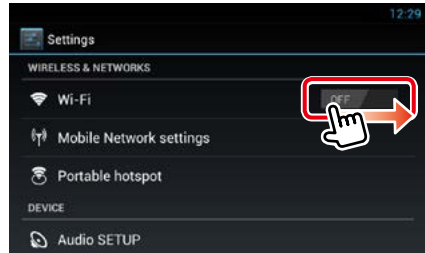

### 5 Touch [Wi-Fi].

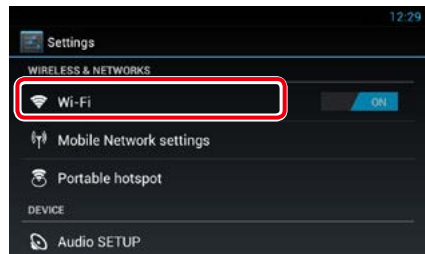

### 6 Select the Wi-Fi access point to register from the list.

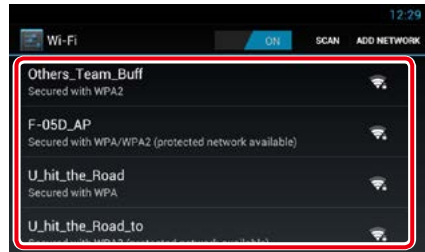

### 7 Enter the Password.

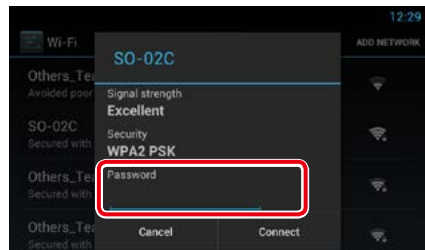

### 8 Touch [Connect].

## Register the Wi-Fi access point manually

**1 Touch [ADD NETWORK].**



**2 Enter the SSID code.**

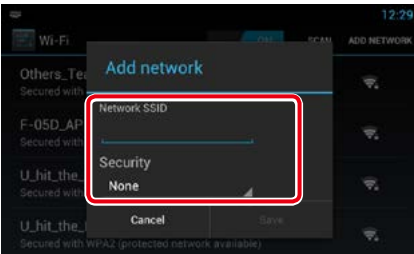

**3 Select the security.**

**4 Enter the security code.**

**5 Touch [SAVE].**

## Confirm the MAC address

**1 Press the <MENU> button.**

**2 Touch [Advanced].**

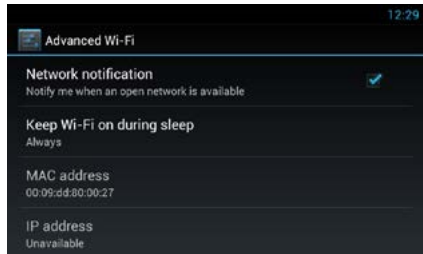
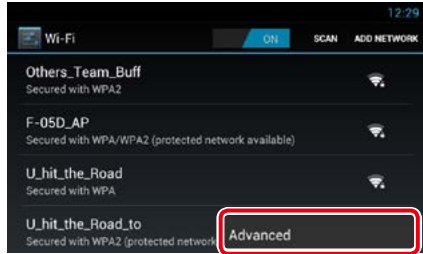

**3 Press the <↩> button.**

## Wi-Fi Hotspot Setup

If there is no Wi-Fi access point, this unit becomes a Wi-Fi access point. You can connect your smartphone and your tablet PC, and enjoy Kenwood Wireless Link function. [\(P.88\)](#)

### Preparation

- When Wi-Fi Hotspot is in use you can not connect to the Internet via Wi-Fi. To connect to the Internet, 4G/3G Dongle (sold separately) is necessary. [\(P.35\)](#)
- Set to OFF the Wi-Fi in [Wi-Fi Setup \(P.32\)](#).

**1 Press the <HOME> button to display the Home screen.**

**2 Press the <MENU> button.**

**3 Touch [Setting].**



**4 Touch [Portable hotspot].**

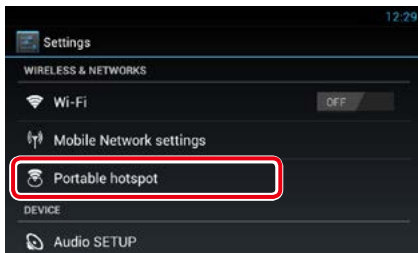

**5 Touch [Configure Wi-Fi hotspot].**



**6 Enter the SSID code. Select the security. Enter the password.**



When you check Show password, the password that you set is displayed.

**7 Touch [Save].**

**8 Touch [Portable Wi-Fi hotspot].**



This unit works as the Wi-Fi access point.

## 4G/ 3G Dongle Setup (DNN992)

This unit is designed to work with 4G/3G Dongle by Verizon (sold separately). You can connect to the Internet without a smartphone. With 4G/3G Dongle you can use the following functions.

- Internet connection while using Wi-Fi Hotspot.
- Certain update of the information of your car location in the Tracking function.

### Preparation

- Set to OFF the Wi-Fi in [Wi-Fi Setup \(P.32\)](#).

**1 Press the <HOME> button to display the Home screen.**

**2 Press the <MENU> button.**

**3 Touch [Setting].**



**4 Touch [Mobile Network setting].**

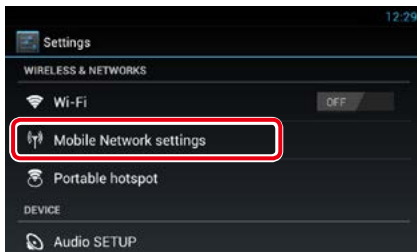

**5 Touch [Mobile Network configuration].**

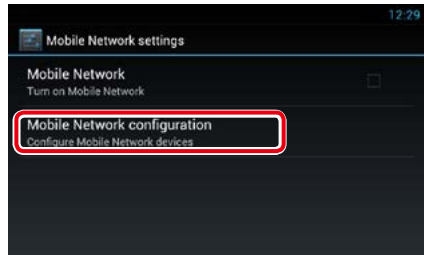

**6 Enter the network information.**

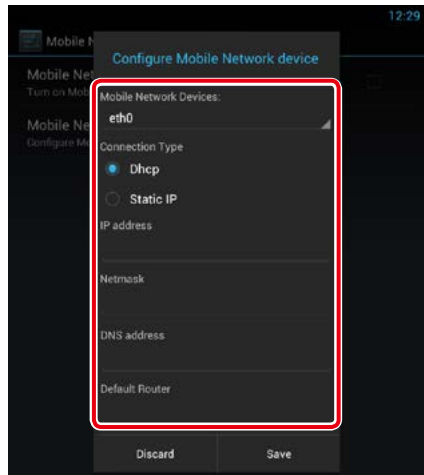

**7 Touch [Save].**

**8 Touch [Mobile Network].**

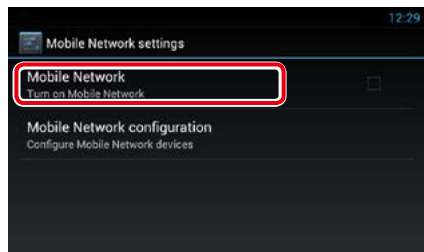

Connect to the Internet.



# Clock and Date Setup

## Clock and Date Setup

- 1 Press the <HOME> button to display the Home screen.
- 2 Press the <MENU> button.
- 3 Touch [Setting].



- 4 Touch [Date & time].

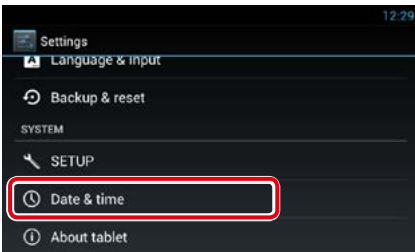

- 5 Set each item as follows.

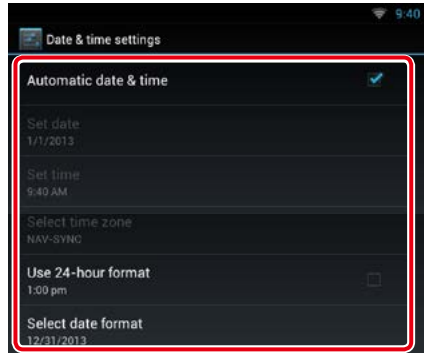

- 6 Press the <↩> button.

## Adjust the date and time manually.

- 1 Touch [Automatic date & time] to remove the check.

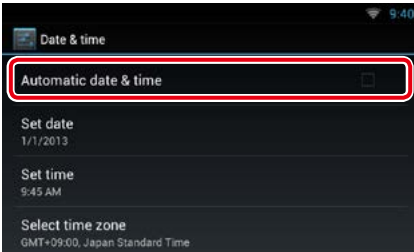

- 2 Touch [Select time zone].

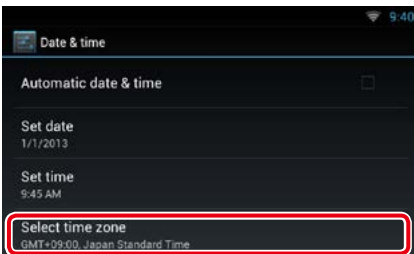

- 3 Select a time zone.

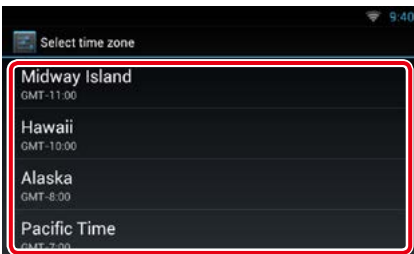

- 4 Touch [Set date].

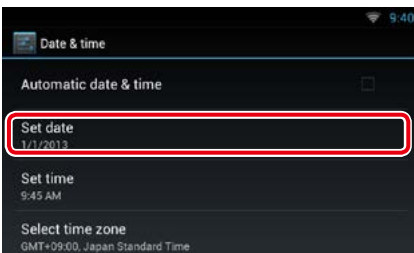

- 5 Adjust the date.

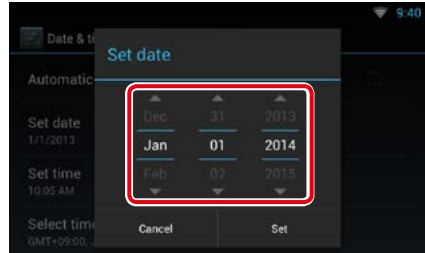

- 6 Touch [Set].

- 7 Touch [Set time].

- 8 Adjust the time.

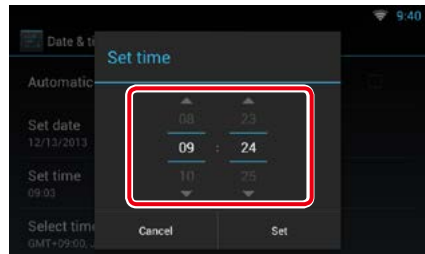

- 9 Touch [Set].

- 10 Press the < > button.

# Account Setup

## About Account

To use this unit, you must register an account.

### Types of accounts

You can create accounts to maintain privacy when using the mail feature or social media.

#### Administrator

As Administrator, you can create an owner account and perform initial setup. You can log in to the system if you have not created an owner account.

#### Guest

An account for guests such as your friends. The guest can operate this unit, but cannot use the functions related to mail, social media, and Route Collector site.

#### Owner

The account for the person who manages this unit.

The owner can use the functions related to mail, social media, and Route Collector site. You can register users such as your family.

#### User

The account for the user of this unit. The user can use the functions related to mail, social media, and Route Collector site. You can register up to 4 user accounts.

## Account registration procedure

### 1 Create an account in the Route Collector site.

Create an account referring to [Create User Account \(P.38\)](#) or the Route Collector site.

<http://www.route-collector.com/>

### 2 Register the account in this unit.

To register an Owner account, refer to [Set Owner Account \(P.39\)](#).

To register an User account, refer to [Set User Account \(P.40\)](#).

### 3 Switch between login accounts.

See [Switch the User Login \(P.40\)](#).

## Create User Account

To use this unit, you need to create an account in the Route Collector site.

### Preparation

- To register yourself in the Route Collector site as a user, you need a mail address.
- You can register yourself via the Web. <http://www.route-collector.com/>
- This step may be skipped if you have already registered yourself in the Route Collector site.

### 1 Press the <HOME> button to display the Home screen.

### 2 Press the <MENU> button.

### 3 Touch [Account].



#### 4 Touch [Create Account].



#### 5 Enter account information.

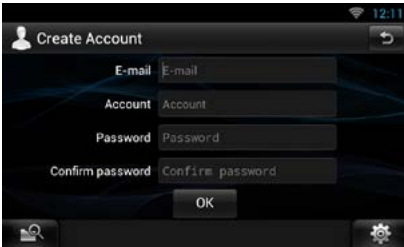

You cannot register an account which has already been used. Register another account name.

#### 6 Touch [OK].

The account is temporarily registered in the Route Collector site.

#### 7 Activate the account.

A confirmation mail is sent to the registered mail address. Open the indicated URL to complete account registration.

## Set Owner Account

You can register an owner account for the person who manages this system.

### Preparation

- You must have a connection with the internet. See [Network Setup \(P.32\)](#).
- First create an account in the Route Collector site. See [Create User Account \(P.38\)](#).
- If you have not created an owner account, log in to the system as Administrator.
- If you have created an owner account, log in to the system after account resetting.

1 Press the <HOME> button to display the Home screen.

2 Press the <MENU> button.

3 Touch [Account].



4 Touch [Set Owner Account].



5 Enter account information.



Enter the information registered in the Route Collector site.

6 Touch [OK].

## Set User Account

You can register a user account for the user of this unit.

### Preparation

- You must have a connection with the internet. See [Network Setup \(P.32\)](#).
- First create an account in the Route Collector site. See [Create User Account \(P.38\)](#).
- You can set a user account when you have logged in the Owner.

**1 Press the <HOME> button to display the Home screen.**

**2 Press the <MENU> button.**

**3 Touch [Account].**



**4 Touch [Set Account].**



**5 Enter account information.**



Enter the information registered in the Route Collector site.

**6 Touch [OK].**

## Switch the User Login

You can switch to a different account from the one currently logged in.

**1 Press the <HOME> button to display the Home screen.**

**2 Press the <MENU> button.**

**3 Touch [Account].**



**4 Touch [Login User select].**



**5 Select an account.**



**6 Enter the password.**



## Delete User Account

You can delete a previously registered user account.

### Preparation

- You can set a user account when you have logged in the Owner.

- 1 Press the <HOME> button to display the Home screen.
- 2 Press the <MENU> button.
- 3 Touch [Account].



- 4 Touch [Delete Account].



- 5 Select an account.

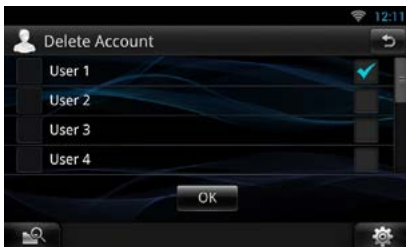

- 6 Touch [OK].  
Confirmation screen appears.
- 7 Touch [Yes].

## Reset Owner Account

You can delete previously registered owner and user accounts.

### Preparation

- You can set a user account when you have logged in the Owner.

- 1 Press the <HOME> button to display the Home screen.
- 2 Press the <MENU> button.
- 3 Touch [Account].



- 4 Touch [Reset Account].



- 5 Enter the owner account's password.



- 6 Touch [OK].  
Confirmation screen appears.
- 7 Touch [Yes].

### Note

- The data, log, and settings used in the account are deleted.

# Widget and Application Operation

## Weather Widget (DNN992)

Displays the weather forecast for the selected region.

### Preparation

- You must have a connection with the internet. See [Network Setup \(P.32\)](#).
- You can use this feature for 2 years after registration of the owner account. To use it continuously, a usage fee is required. For details, see web site of Route Collector.  
<http://www.route-collector.com/>

**1 Press the <HOME> button.**

**2 Flick the screen left or right to select the Service panel.**

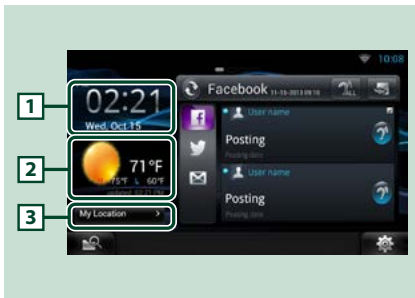

### 1 Time & Date

Displays the current time and date.

### 2 Weather information

Displays the weather forecast for the selected region.

Touching this starts the weather application.

### 3 City information

Displays the selected region.

Touching this displays a region selection screen. See [City select \(P.42\)](#).

## City select

**1 Touch [(City name)] in the Weather Widget.**



### 1 City list

Displays a region list.

Touching this displays the selected region.

### 2 [Add City]



Starts the weather application to add the region. See [Add a City \(P.43\)](#).

## Weather Application (DNN992)

Displays the weather forecast for the selected region.

### Preparation

- You must have a connection with the internet. See [Network Setup \(P.32\)](#).
- You can use this feature for 2 years after registration of the owner account. To use it continuously, a usage fee is required. For details, see web site of Route Collector.  
<http://www.route-collector.com/>

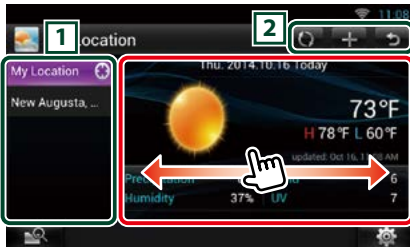

- 1 Press the <HOME> button.
- 2 Flick the screen left or right to select the Network contents panel.
- 3 Touch [  ].
- 4 Touch [  Weather].
- 5 Perform desired operation as follows.



### 1 City list

Displays a region list.  
Touching this displays the selected region.

2

-  : Reads information again.
-  : Adds a region.
-  : Terminates the application.

### (Weather information)

Displays the today's weather forecast and the weather forecast for the next 6 days.

## Menu

- 1 Press the <MENU> button.

### Delete

Deletes a region from the City list. See [Delete City \(P.44\)](#).

### Setting

Allows you to set the information update interval, etc. See [Weather setup \(P.44\)](#).

## Add a City

Adds a region to the City list.

- 1 Touch [  ].
- 2 Search for a region.

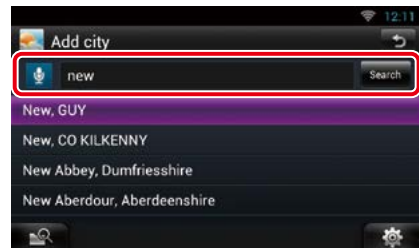

### (Voice recognition)

You can enter a region using the voice recognition function. When "Speak now" is displayed, pronounce the region name.

### [Search]

Search starts.

- 3 Select a region.

Touching the region adds it to the list, and displays the weather forecast.



## Delete City

You can delete a region from the City list.

- 1 Press the <MENU> button.
- 2 Touch [Delete] in the Menu.
- 3 Delete the region.

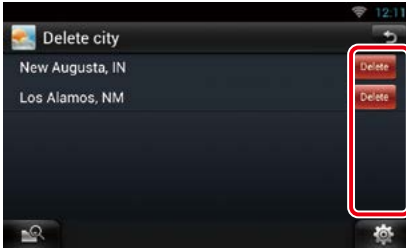

- 4 Touch [Yes].
- 5 Touch [↩].

## Weather setup

Performs setup when using Weather Application.

- 1 Press the <MENU> button.
- 2 Touch [Setting] in the Menu.
- 3 Select an option as follows.

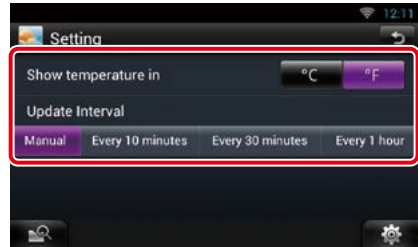

### Show temperature in

Select a temperature scale.

### Update interval

Set an information update interval.



- 4 Touch [↩].

## SNS Widget

You can use Facebook, Twitter, and email (IMAP).



### Preparation

- To use each service, the Facebook, Twitter or email account is required.
- You can use a user account when you have logged in the Owner or User.

- 1 Press the <HOME> button.
- 2 Flick the screen left or right to select the Service panel.
- 3 Touch [  /  ].
- 4 Select the SNS Widget.



1

- : Starts the SNS application.
- : Reads out all contents in an auditory fashion.
- : Switches to the RSS.

### 2 Category

Select a service category.

### 3 SNS article list

Displays the contents selected in Category in a new order.

Touching this starts the SNS application and displays its contents.

When the latest information is displayed at the top, sliding the list allows you to update the information.

- : Reads out the SNS contents in an auditory fashion.



## RSS Widget

Displays the RSS news.

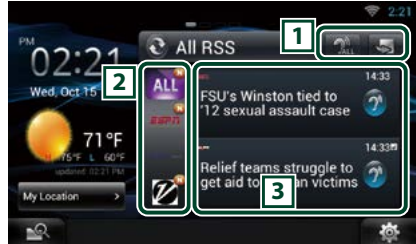
- 1 Press the <HOME> button.
- 2 Flick the screen left or right to select the Service panel.
- 3 Touch [  /  ].
- 4 Select the RSS Widget.



1

- : Starts the RSS application.
- : Reads out all the contents in an auditory fashion.
- : Switches to the SNS.

### 2 Category

Select a service category.

### 3 RSS article list

Displays the contents selected in Category in a new order.

Touching this starts the RSS application and displays its contents.

When the latest information is displayed at the top, sliding the list allows you to update the information.

- : Reads out the RSS contents in an auditory fashion.

## Facebook (SNS Application)

Displays the screen for using Facebook.

### Preparation

- You must have a connection with the internet.  
See [Network Setup \(P.32\)](#).
- To use a Facebook service, the corresponding account is required.
- You can use a user account when you have logged in the Owner or User.

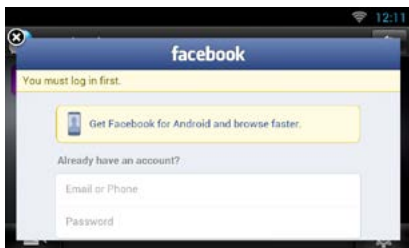

### Register an account

- 1 Press the <HOME> button.
- 2 Flick the screen left or right to select the Network contents panel.
- 3 Touch [  ].
- 4 Touch [  SNS].
- 5 Touch [  (Facebook)].
- 6 Touch [Sign in].
- 7 Enter the Email address/Phone and Password.





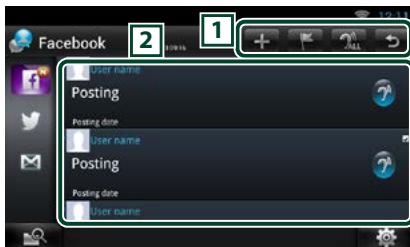

- 8 Touch [Log in].

### Operation

- 1 Press the <HOME> button.
- 2 Flick the screen left or right to select the Network contents panel.
- 3 Touch [  ].
- 4 Touch [  SNS].
- 5 Touch [  (Facebook)].
- 6 Perform desired operation as follows.



1

-  : Create a new article.
-  : Posting the current place.
-  : Reads out all articles by voice.
-  : Terminates the application.

### 2 Article list

Displays an article or message.

Touching this displays details.

While the latest information is displayed at the top, sliding the list down updates the information.

-  : Reads out the article by voice.

## 7 Detailed article or message view.

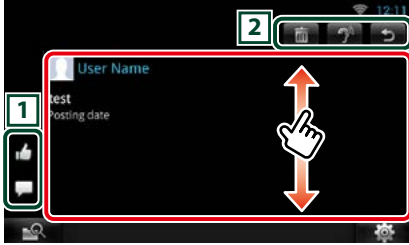

1

- : Votes as "Like".
- : Posts a comment.

2

- : Deletes an article written by you. When the confirmation screen appears, touch "Ok".
- : Reads the content of the comment by voice.
- : Returns to previous screen.

### Menu

#### 1 Press the <MENU> button.

##### **Article list view**

###### **Setting**

Set an update interval.

###### **Sign out**

Logs out from the current account.

### Add to post

Create an article to be posted to the SNS service of the selected category.

#### 1 Touch [] in the SNS application.

#### 2 Create an article to post.



1

Enter an article to post.

- : Enter a comment using the voice recognition function. When "Speak now" appears, speak the comment.

[Post] : Posts the article.

2

- : Post photo.
- : Returns to previous screen.

3

Select a fixed phrase.

## Twitter (SNS Application)

Displays the screen for using Twitter.

### Preparation

- You must have a connection with the internet.  
See [Network Setup \(P.32\)](#).
- To use a Twitter service, the corresponding account is required.
- You can use a user account when you have logged in the Owner or User.

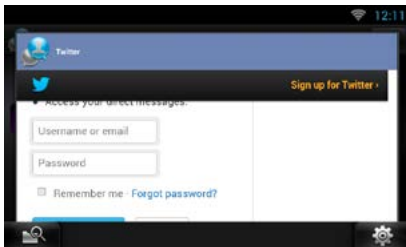

### Register an account

- 1 Press the <HOME> button.
- 2 Flick the screen left or right to select the Network contents panel.
- 3 Touch [  ].
- 4 Touch [  SNS].
- 5 Touch [  (Twitter)].
- 6 Touch [Sign in].
- 7 Enter the Username/email and Password.





- 8 Touch [Authorize app].

### Operation

- 1 Press the <HOME> button.
- 2 Flick the screen left or right to select the Network contents panel.
- 3 Touch [  ].
- 4 Touch [  SNS].
- 5 Touch [  (Twitter)].
- 6 Perform desired operation as follows.



1

-  : Create a new article.
-  : Posting the current place.
-  : Reads out all articles by voice.
-  : Terminates the application.

2 Article list

Displays an article or message.

Touching this displays details.

While the latest information is displayed at the top, sliding the list down updates the information.

-  : Reads out the article by voice.

## 7 Detailed article or message view.

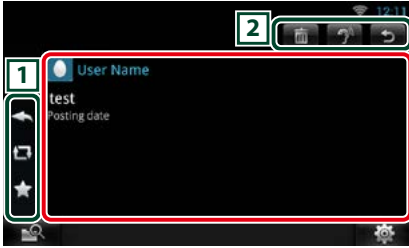

1

- : Create a reply.
- : Create a ReTweet.
- : Adds to Favorites.

2

- : Delete the Tweet written by you.
- : Reads the content of the comment by voice.
- : Returns to previous screen.

### Menu

#### 1 Press the <MENU> button.

##### **Article list view**

###### **Setting**

Set an update interval.

###### **Sign out**

Logs out from the current account.

### Add to post

Create an article to be posted to the SNS service of the selected category.

#### 1 Touch [] in the SNS application.

#### 2 Create an article to post.



1

Enter an article to post.

- : Enter a comment using the voice recognition function. When "Speak now" appears, speak the comment.

[Post] : Posts the article.

2

- : Post current location.
- : Returns to previous screen.

3

Select a fixed phrase.

## E-mail (SNS Application)

Displays the screen for using E-mail (IMAP).

### Preparation

- You must have a connection with the internet.  
See [Network Setup \(P.32\)](#).
- To use a email service, the corresponding account is required.
- You can use a user account when you have logged in the Owner or User.

### Register an account

- 1 Press the <HOME> button.
- 2 Flick the screen left or right to select the Network contents panel.
- 3 Touch [  ].
- 4 Touch [  SNS].
- 5 Touch [  (mail)].
- 6 Touch [Sign in].
- 7 Enter the Email and Password.



- 8 Touch [Next].
- 9 Enter the IMAP server ,Port and Security type.

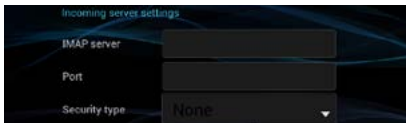

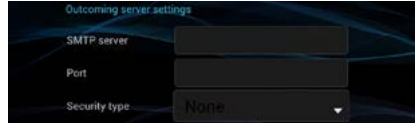

- 10 Touch [Next].

- 11 Enter the SMTP server ,Port and Security type.





- 12 Touch [Done].

### Operation

- 1 Press the <HOME> button.
- 2 Flick the screen left or right to select the Network contents panel.
- 3 Touch [  ].
- 4 Touch [  SNS].
- 5 Touch [  (mail)].
- 6 Perform desired operation as follows.



1

-  : Create a new article.
-  : Reads out all articles by voice.
-  : Terminates the application.

2 Inbox list

- Displays an article or message.
- Touching this displays details.
- While the latest information is displayed at the top, sliding the list down updates the information.
-  : Reads out the article by voice.

## 7 Detailed article or message view.



1

- : Creates a reply mail.
- : Creates a reply mail for all.
- : Creates a forwarded mail.

2

- : Deletes an article. When the confirmation screen appears, touch "Ok".
- : Reads the content of the comment by voice.
- : Returns to previous screen.

### Menu

#### 1 Press the <MENU> button.

##### ***Inbox list view***

###### **Setting**

Set an update interval.

###### **Account**

Select the account and label to be displayed.

- ① Select an account.
- ② Select a label.

###### **Add account**

Register a new account.

###### **Delete account**

Delete a registered account.

Select the account to delete by putting a checkmark, and then touch [OK].

### Add to post

Create an article to be posted to the SNS service of the selected category.

#### 1 Touch [ + ] in the SNS application.

#### 2 Create an article to post.

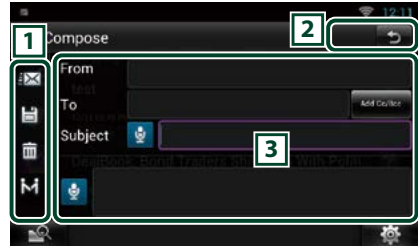

1

- : Sends the mail.
- : Stores the mail temporarily.
- : Deletes the mail.
- : Enters the address of the meeting point for Come Here function. See [Come Here function \(P.28\)](#).

2

- : Returns to previous screen.

3

Create a mail message to send.

- : Enter a comment using the voice recognition function. When "Speak now" appears, speak the comment.

[Add Cc/Bcc] : Displays cc and Bcc.





## RSS Application



Displays an RSS feed.

### Preparation

- You must have a connection with the internet.  
See [Network Setup \(P.32\)](#).
- You can use a user account when you have logged in the Owner or User.

- 1 Press the <HOME> button.
- 2 Flick the screen left or right to select the Network contents panel.
- 3 Touch [  ].
- 4 Touch [  (RSS) ].
- 5 Perform desired operation as follows.



- 1
  - : Adds an RSS feed. See [Add RSS feed \(P.53\)](#)
  - : Reads out all articles by voice.
  - : Terminates the application.

### 2 Category

Select the RSS feed to be displayed.

### 3 Article list

Display the article.



Touching this displays details.

While the latest information is displayed at the top, sliding the list down updates the information.

- : Reads out the article by voice.

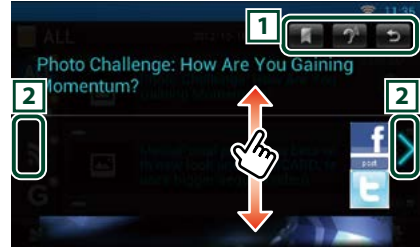
## 6 Detailed article view.



- 1
  - : Registers the RSS feed in the bookmark of the Route Collector site. You can read it later in the Route Collector site.
  - : Reads the content by voice.
  - : Returns to previous screen.

- 2
  - Moves to the previous or next article.

## Menu

- 1 Press the <MENU> button.

### Article list view

#### Delete

Delete an RSS feed. See [Delete RSS feed \(P.53\)](#)

#### Setting

Set the update interval. See [RSS setup \(P.53\)](#)

## Add RSS feed

Add an RSS feed.

- 1 Touch [**+**] in the RSS application.
- 2 Select a category.

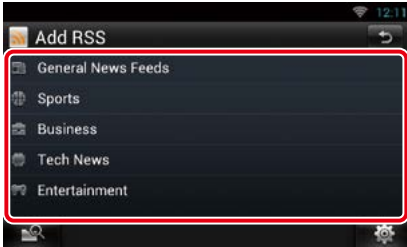

- 3 Touch [Add].

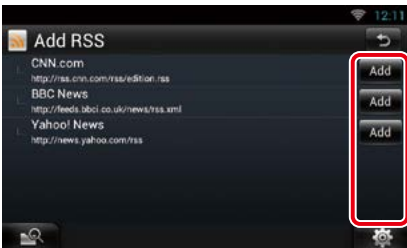

### Note

- In order to add an selectable RSS feed, you need to edit it in the Route Collector site. See [www.route-collector.com/](http://www.route-collector.com/)

## Delete RSS feed

Delete an RSS feed.

- 1 Press the <MENU> button.
- 2 Touch [Delete].



- 3 Touch [Yes] to confirm.

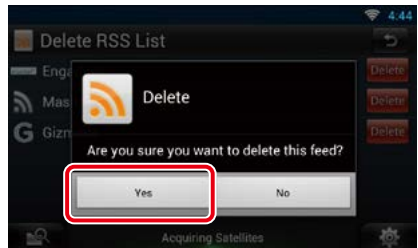

## RSS setup

Performs setup when using RSS Application.

- 1 Press the <MENU> button.
- 2 Touch [Setting] in the Menu.
- 3 Select an option as follows.

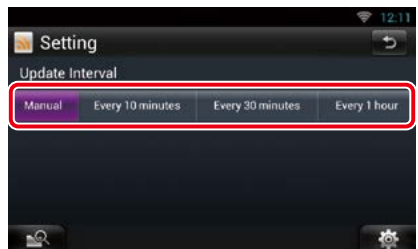

### Update interval

Set the information update interval.

## Now playing Widget

Displays the information about the song or station you are listening to, and allows you to perform simple operations.

- 1 Press the <HOME> button.
- 2 Flick the screen left or right to select the Media panel.

**Media source such as CD or USB**

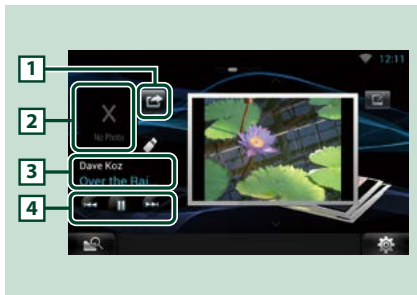

### 1 (I'm listening)

You can post the information about the song you are listening to, on twitter, Facebook. See [Posting the information about the song you are listening to \(P.55\)](#).

### 2 **Album art**

Touching Album art displays the Source control screen.

### 3 **Information display**

Displays the information (title, etc.) about the song being played.

### 4

Allow you to stop playback temporarily and select songs.

## Radio source such as Radio, HD Radio Technology or SiriusXM



### 1 (I'm listening)

You can post the information about the song you are listening to, on twitter, Facebook. See [Posting the information about the song you are listening to \(P.55\)](#).

The mark does not appear if there is no information of the song.

### 2 **Artwork**

Touching artwork displays the Source control screen.

### 3 **Information display**

Displays the band, frequency, etc.  
Touching this displays the Preset list screen. See [Preset select \(P.55\)](#).

### 4

Allows you to select a band and a station.

## Posting the information about the song you are listening to

You can post the information about the song you are listening to, on Twitter, Facebook, or Route Collector site.

### 1 Touch [ ].



### 2 Create the information you want to post.

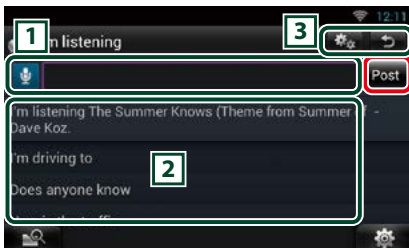

1

Enter the information you want to post.

 : Enter a comment using the voice recognition function. When "Speak now" is displayed, pronounce the comment.

[Post] : Posts the information.

### 2 Fixed phrase

Select the information about the song you are listening to and a fixed phrase.

3

 : Select the service on which you want to post the information.

Select the service, and then touch [OK].

 : Returns to previous screen.

## Preset select

### 1 Touch illustrated area.

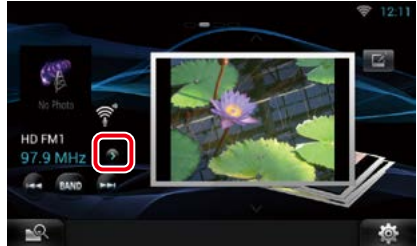

### 2 Select a station or channel from the list.

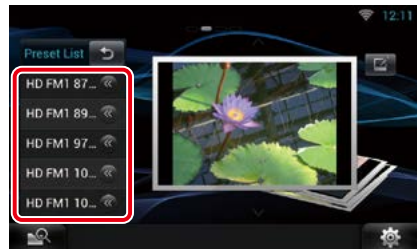

## Photo Frame Widget

You can display the photos stored in the USB memory or SD card as a slide show.

- 1 Press the <HOME> button.
- 2 Flick the screen left or right to select the Media panel.



### 1 Edit

Edit the photo to be displayed.

### 2 Picture

Sliding the photo vertically scrolls through photos.

Select the photo you want to display.

- 1 Touch [  ].

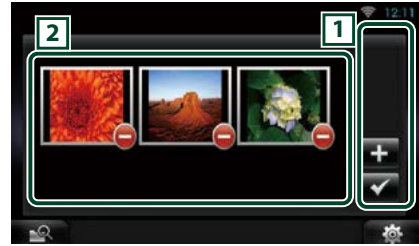

### 1

 : Displays the screen for selecting the photo to be added.

 : Ends editing, and returns to the Photo frame screen.

### 2 Thumbnail

Touch and hold the photo. When the photo shaking, drag the photo to change the order.

 : Deletes the photo from the list.

- 2 Touch [  ].



- 3 Select a picture.



- 4 Touch [  ].

## Mixed Media Search

You can search media like USB,iPod for the song by artist or album name and play it.

- 1 Touch [  ].
- 2 Select whether you search for the song by artist name  or album name  .
- 3 Enter the Artist or Album.

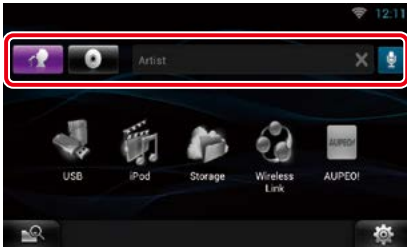

Enter the keyword using the voice recognition function. When "Speak now" is displayed, pronounce the keyword.

\* You cannot use this function if you have not registered the Owner account.

- 4 Select a Source.



The source changes and playback starts.

# DVD/Video CD (VCD) Operation

## DVD/VCD Basic Operation

Most functions can be controlled from the source control screen and playback screen.

### NOTE

- Set the remote controller mode switch to DVD mode before starting operation, see [Switching the operation mode \(P.151\)](#).
- The screen shot below is for DVD. It may be different from the one for VCD.

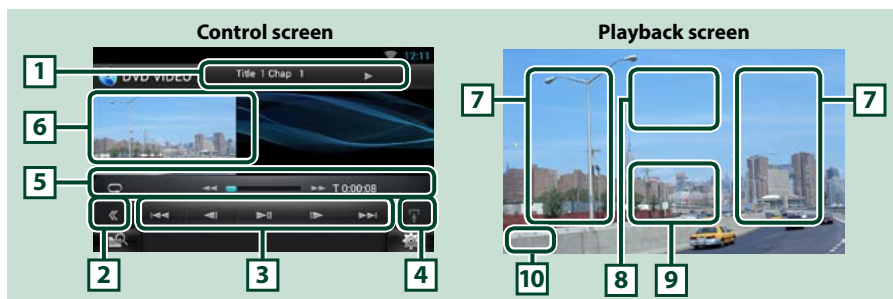

### 1 Information display

Displays the following information.

- **Title #, Chap #:** DVD title and chapter number display
- **Track #/Scene #:** VCD track or scene number display  
\*Scene # is displayed only when PBC is on.
- **▶, ▶▶, ▶▶▶, ■, etc.:** Current play mode display  
The meanings of each icon are as follows; ▶ (play), ▶▶ (fast forward), ◀◀ (fast backward), ▶▶▶ (search up), ◀◀◀ (search down), ■ (stop), ■R (resume stop), || (pause), |▶ (slow playback), ◀| (slow reverse playback).

Touch this area to display the disc label name.

### 2 Multi function key

Touch to switch the multi function menu. For details on the menu, see [Multi function menu \(P.60\)](#).

### 3 Multi function menu







Various functions can be operated using keys in this menu. For details on the keys, see [Multi function menu \(P.60\)](#).

### 4 Control switching key

Unavailable in DVD/VCD source.

## 5 Sub function menu

The following functions can be performed by using keys in this area.

- **Repeats the current content:** Touch [  ]. Each time you touch the key, repeat mode switches in the following sequence:  
DVD: "title repeat"  "chapter repeat"  "function off"  
VCD (PBC On): Does not repeat  
VCD (PBC Off): "track repeat"  "function off"
- **Fast forward or fast backward:** Touch [  ] or [  ]. Each time you touch the key, the speed changes; standard, 2 times, 3 times.
- **For confirmation of play time:** See ###:##.  
DVD: You can switch the time display between title play time, chapter play time, and title remaining time. Each time you touch, the display switches between "T ###:##" (title play time display), "C ###:##" (chapter play time display), and "R ###:##" (title remaining time display).  
As well as the time display, the bar indicating current location appears.  
VCD (PBC off): You can also confirm disc remaining time by touching time display.  
Each time you touch, the display switches between "P ###:##" (play time display) and "R ###:##" (disc remaining time).
- **For confirmation of current playing position:**  
See the bar in center (DVD only). The bar does not appear while the remaining time is being displayed.

## 6 Movie display area

Touch to display Video screen.

## 7 Searching area

Touch to search the next/previous content.

Scrolling from center of display to left or right performs fast backward or fast forward. Each time you touch each area, the speed changes; standard, 2 times, 3 times. To stop fast backward/forward, touch center of the display.

## 8 Menu display area

This area functions differently depending on the current status.

- **During DVD playback:** Displays the Movie control screen. During the menu display, displays the highlight control screen. See [DVD Disc Menu Operation \(P.61\)](#).
- **During VCD playback:** Displays the Movie control screen. See [Zoom Control for DVD and VCD \(P.62\)](#).

## 9 Key display area

Touch to display the last control screen.

## 10 Screen setup display area

Touch and hold to display the screen control screen. See [Monitor Screen Setup \(P.128\)](#).

### NOTE

- If you use a remote controller, you can jump directly to the desired video scene by entering the chapter number, scene number, play time, etc [Direct search mode \(P.151\)](#).



## Multi function menu

### DVD

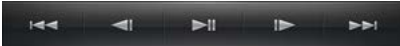

### VCD



The functions of each key are as follows.

**[<<<] [>>>]**

Searches the previous/next content.

**[>||]**

Plays or pauses.

**[<|] or [|>] (DVD only)**

Plays in slow motion forward or backward.

**[■]**

Stops playback. When touched twice, the disc is played from the beginning when you play it the next time.

**[PBC] (VCD only)**

Turn PBC on or off.

## DVD Disc Menu Operation

You can set up some items in the DVD-VIDEO disc menu.

### 1 Touch illustrated area during playback.



Movie control screen appears.

### 2 Touch [Disc CTRL].



Menu Control screen appears.

### 3 Perform desired operation as follows.



#### Displays the top menu

Touch [Top].\*

#### Displays the menu

Touch [Menu].\*

#### Displays the previous menu

Touch [Return].\*

#### Enters selected item

Touch [Enter].

#### Enables direct operation

Touch [Highlight] to enter the highlight control mode. See [Highlight control \(P.61\)](#).

#### Moves the cursor

Touch [▲], [▼], [◀], [▶].

\*These keys may not function depending on the disc.

### Highlight control

Highlight control lets you control the DVD menu by touching the menu key directly on the screen.

### 1 Touch [Highlight] in the Menu Control screen.

### 2 Touch desired item on the screen.



#### NOTE

- The highlight control is cleared automatically if you do not operate for a constant time.

## DVD Play Mode Setting

You can select DVD play mode.

- 1 Touch [Next] in the Menu Control screen.



Menu Control 2 screen appears.

- 2 Touch the key which corresponds to desired setting item.



### Switches the subtitle language

Touch [Subtitle]. Each time you touch this key, language is switched.

### Switches the audio language

Touch [Audio]. Each time you touch this key, language is switched.

### Controls zoom ratio

Touch [Zoom]. For details, see [step2 in Zoom Control for DVD and VCD \(P.62\)](#).

### Switches the picture angle

Touch [Angle]. Each time you touch this key, picture angle is switched.

### Exits menu control

Touch [Exit].

### Displays the Menu Control 1 screen

Touch [Previous].

## Zoom Control for DVD and VCD

You can enlarge Playback screen for DVD and VCD.

- 1 For VCD, touch illustrated area during playback.



Movie control screen appears.

- 2 Touch [Disc CTRL].



Zoom Control screen appears.

### NOTE

- For DVD, please refer to [DVD Play Mode Setting \(P.62\)](#) to display the Zoom Control screen.

- 3 Perform desired operation as follows.



### Switches zoom ratio

Touch [Zoom].

For DVD, changes the zoom ratio at 4 levels;  
Off, 2 times, 3 times, 4 times.

For VCD, changes the zoom ratio at 2 levels;  
Off, 2 times.

### Scrolls the screen

Touch [▲], [▼], [◀], or [▶] to scroll the screen  
in the direction you touch.

### Exits menu control

Touch [Exit].

### Displays the previous menu\*

Touch [Return].

\*This function may not be performed  
depending on the disc.

#### NOTE

- You cannot touch the menu keys directly on the screen when zooming.

## DVD Setup

You can set up the DVD playback functions.

### 1 Touch [ ].

Quick menu appears.

### 2 Touch [SETUP].

SETUP Menu screen appears.

### 3 Touch [Source].



Source SETUP Menu screen appears.

### 4 Touch [DVD SETUP] in the list.

DVD SETUP screen appears.

## 5 Set each item as follows.



### Menu/Subtitle/Audio Language\*

See [Language setup \(P.64\)](#).

### Dynamic Range Control\*

Set the dynamic range.

**Wide:** The dynamic range is wide.

**Normal:** The dynamic range is normal.

**Dialog (Default):** Makes the total sound volume larger than other modes. This is effective only when you are using Dolby Digital software.

### Angle Mark

Set an angle mark display.

**ON (Default):** An angle mark appears.

**OFF:** An angle mark does not appear.

### Screen Ratio\*

Set the screen display mode.

**16:9 (Default):** Displays wide pictures.

**4:3 LB:** Displays wide pictures in the Letter Box format (having black stripes at the top and bottom of screen).

**4:3 PS:** Displays wide pictures in the Pan & Scan format (showing pictures cut at the right and left ends).

**Continued**

### Parental Level\*

See [Parental level \(P.65\)](#).

### DISC SETUP

See [Disc setup \(P.65\)](#).

### Stream Information

Displays the present source information.

The stream (Dolby Digital, Linear PCM, MPEG, WMA or AAC) appears.

\*These items are disabled when a DVD is being played.

## Language setup

This setting is for the language used in the menu, subtitle, and voice. You cannot setup these items during DVD playback.

### 1 Touch [SET] of the desired item; [Menu Language], [Subtitle Language], [Audio Language].

Language Set screen appears.

### 2 Enter the desired language code and touch [Enter].



For language code, refer to [DVD Language Codes \(P.164\)](#).

Sets the entered language and returns to the DVD SETUP screen.

#### NOTE

- To cancel the setup and return to the previous screen, touch [Cancel].
- To clear the entered code, touch [Clear].
- To set the DVD's original language for audio language, touch [Original].

## Parental level

Set a parental lock level to prohibit children to watch video. You cannot set a parental lock level during DVD playback.

**1 Touch [SET] of [Parental Level].**  
Parental Pass screen appears.

**2 Enter the parental code and touch [Enter].**  
Parental Level screen appears.

### NOTE

- To cancel the setup and return to the previous screen, touch [Cancel].
- To clear the entered code, touch [Clear].
- Current parental lock level appears as [Level#].

**3 Touch [◀] or [▶] to select a parental lock level.**



### NOTE

- If a disc has higher parental lock level, you need to enter the code number.
- The parental lock level varies depending on a loaded disc.
- If a disc has no parental lock, anybody can play it even though you have set the parental lock.

## Disc setup

Performs setup when using disc media.

**1 Touch [SET] of [DISC SETUP].**  
DISC SETUP screen appears.

**2 Select an option as follows.**

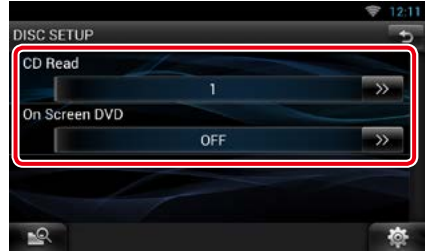

### CD Read

Sets the motion of this unit when a music CD is played.

**1 (Default):** Automatically recognizes and plays an audio file disc, a DVD or a music CD.

**2:** Forcibly plays a disc as a music CD. Select [2] if you wish to play a music CD having a special format or if you cannot play a disc with the option [1] set.

### On Screen DVD

Sets an on-screen display.

**Auto:** When updated, information appears for 5 seconds.

**OFF (Default):** Information does not appear.

### NOTE

- [CD Read] is disabled when a disc is already in the unit.
- You cannot play an audio file/VCD disc with the option [2] set. Also, you may not play some music CDs with the option [2] set.

# CD/Audio and Visual Files/iPod/Apps Operation

## Music/Video Basic Operation

Most functions can be controlled from the source control screen and playback screen.

### NOTE

• Set the remote controller mode switch to AUD mode before starting operation, see [Switching the operation mode \(P.151\)](#).

• To connect the Android device with this unit, the cable (sold separately) and the profile which your Android device supports are necessary as follows:

Ⓐ To listen to music and watch video of APPS source

- MHL device
- KCA-MH100
- Bluetooth profile: SPP
- Application link setup: HDMI/MHL + BT

Ⓑ To listen to music of APPS source

- Bluetooth profile: A2DP
- Bluetooth profile: SPP
- Application link setup: Bluetooth

Ⓒ To listen to music of Bluetooth Audio source [\(P.119\)](#)

- Bluetooth profile: A2DP
- Bluetooth profile: AVRCP

• To connect the iPod/iPhone with this unit, the cable, adapter (both sold separately), and the profile which your iPod/iPhone supports are necessary as follows:

Ⓐ To listen music and watch video with Lightning connector device

- Lightning Digital AV Adapter
- KCA-HD100
- KCA-iP103
- Bluetooth profile: SPP
- iPod connection setup: HDMI + BT

Ⓑ To listen music with Lightning connector device

- KCA-iP103
- iPod connection setup: USB 1Wire

Ⓒ To listen music and watch video with 30-pin connector device (analog)

- KCA-iP202
- iPod connection setup: USB + AV-IN

Ⓓ To listen music with 30-pin connector device

- KCA-iP102
- iPod connection setup: USB 1Wire

Ⓔ To listen to music via Bluetooth

- Bluetooth profile: A2DP
- Bluetooth profile: SPP
- iPod connection setup: Bluetooth

Ⓕ To listen to music of Bluetooth Audio source [\(P.119\)](#)

- Bluetooth profile: A2DP
- Bluetooth profile: AVRCP

• When connecting with Lightning Digital AV Adapter or Apple 30-pin Digital AV Adapter some applications can be controlled from this unit. The operable functions depend on the application.

• Do not leave the cable or the adapter made by other makers inside the car. It might lead the malfunction caused by heat.

• Some settings are necessary to meet the connected iPod/iPhone or Android device. See [iPod/iPhone connection setup \(P.83\)](#) or [Application link setup \(P.84\)](#).

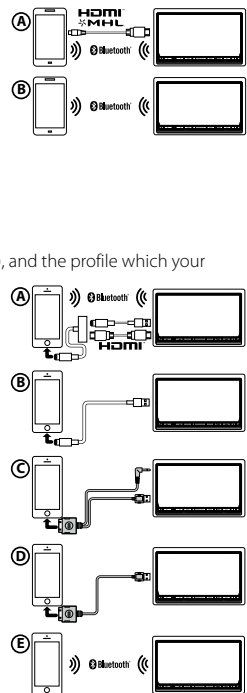

See the following sections for each source operation.

- **Music CD** ([P.67](#))
- **USB device** ([P.69](#))
- **Pandora** ([P.77](#))
- **Disc media** ([P.67](#))
- **SD Card** ([P.69](#))
- **Apps** ([P.80](#))
- **iPod** ([P.69](#))

## Music CD and disc media

### NOTE

- In this manual, "Music CD" will be referred to as the general CDs which include music tracks in. "Disc media" will be referred to as CD/DVD disc which includes audio, picture or video files.
- The screen shot below is for CD. It may be different from the one for disc media.

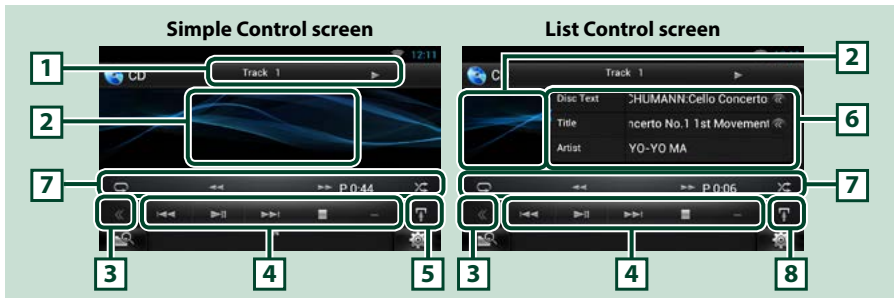

### 1 Information display

Displays the following information.

- **Track #:** Each time you touch this area, display switches between current track number, text, etc.
- **▶, ▶▶, ▶▶|, ■, etc.:** Current play mode display  
The meanings of each icon are as follows; ▶ (play), ▶▶ (fast forward), ◀◀ (fast backward), ▶▶| (search up), |◀◀ (search down), ■ (stop), ■R (resume stop), || (pause).

### 2 Movie display area/Control switching area

Touch to switch between the Simple Control and List Control screen. (Only for Music file)  
Touch to display Video screen. (Only for Video file)

### 3 Multi function key

Touch to switch the multi function menu. For details on the menu, see [Multi function menu \(P.70\)](#).

### 4 Multi function menu

Various functions can be performed by using keys in this area. For details on the menu, see [Multi function menu \(P.70\)](#).

### 5 Sub function key

Touch to display "Sub function menu" (7 in this table).

### 6 Track information

Displays the information of the current track.

For disc media, you can switch the current track information and the current folder list by touching the list switching key (8 in this table).

*Continued*



### 7 Sub function menu

Various functions can be performed by using keys in this area. For details on the keys, see [Sub function menu \(P.71\)](#).

### 8 Sub function/ List switching key

Touch to display "Sub function menu" (7 in this table).

Touch and hold to switch between the track list and the ID3 tag information (disc media only).

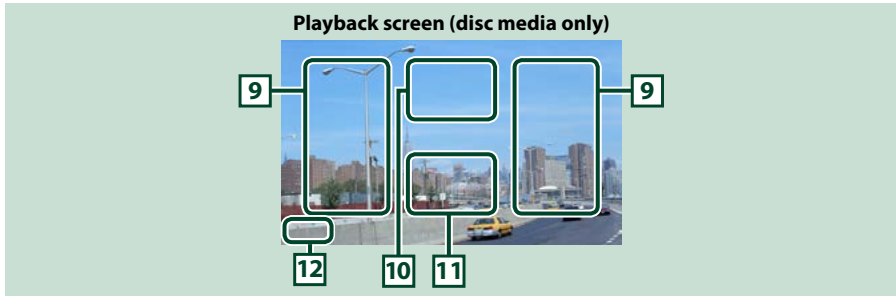

### 9 Searching file area (disc media only)

Touch to search the next/previous file.

Scrolling from center of display to left or right performs fast backward or fast forward. Each time you touch each area, the speed changes; standard, 2 times, 3 times. To stop fast backward/forward, touch center of the display.

### 10 Menu display area (disc media only)

Touch to display the Control screen. For details, see [Movie Control \(P.76\)](#).

### 11 Key display area (disc media only)

Touch to display the last control screen.

### 12 Screen setup display area

Touch and hold to display the screen control screen. See [Monitor Screen Setup \(P.128\)](#).

## USB device, SD card and iPod

### NOTE

- SD card is for DNN992 only.
- The screen shot below is for USB device. It may be different from the one for iPod and SD card.

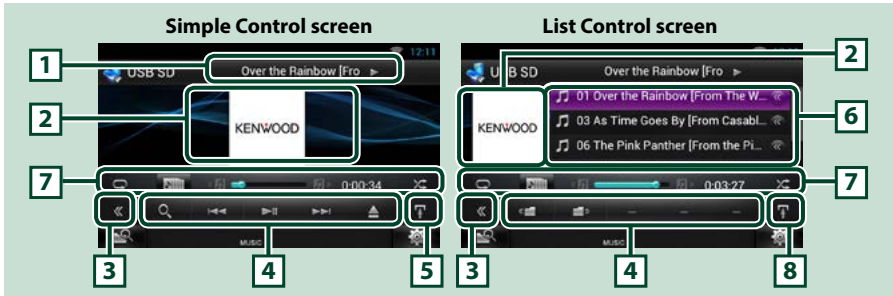

### 1 Information display

Displays the following information.

- **Current file name:** Each time you touch this area, display switches between file number/folder number and file name.
- **▶, ▶▶, etc.:** Current play mode display  
The meanings of each icon are as follows; ▶ (play, searching), || (pause), ▶▶ (forward manual search), ◀◀ (reverse manual search).

### 2 Artwork/Control switching area

Touch to switch between the Simple Control and List Control screen. (Only for Music file)

Touch to display Video screen. (Only for Video file)

### 3 Multi function key

Touch to switch the multi function menu. For details on the menu, see [Multi function menu \(P.70\)](#).

### 4 Multi function menu

Various functions can be performed by using keys in this area. For details on the keys, see [Multi function menu \(P.70\)](#).

### 5 Sub function key

Touch to display "Sub function menu" (7 in this table).

### 6 Content list

Displays the list and content. The content of the list differ depending on the playback status and source.

When you select the video source on the device connected with the Lightning connector, the source is switched to Apps ([P.80](#)) automatically.

### 7 Sub function menu

Various functions can be performed by using keys in this area. For details on the keys, see [Sub function menu \(P.71\)](#).

### 8 Sub function/ List switching key

Touch to display "Sub function menu" (7 in this table).

Touch and hold to switch between the file list and the current file information.

**Continued**

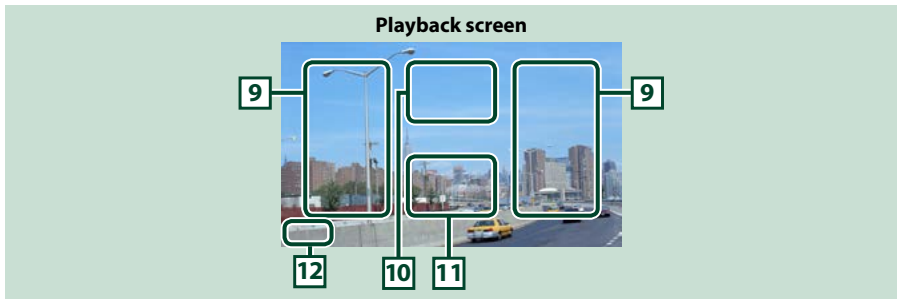

### 9 Searching file area (Video file only)

- Touch to search the next/previous file.
- Scrolling from center of display to left or right performs fast backward or fast forward. To stop fast backward/forward, touch center of the display. This function is not available when there is no music file in the current folder.

### 10 Movie control display area

Touch to display the Movie control screen. For details, see [Movie Control \(P.76\)](#).

### 11 Key display area (Video file only)

Touch to display the last control screen.

### 12 Screen setup display area

Touch and hold to display the screen control screen. See [Monitor Screen Setup \(P.128\)](#).

## Multi function menu

### Music CD



### iPod



### Disc media



### USB device and SD card



The following functions can be performed by using keys in this area.

### [ ] (Only for disc media, iPod, USB device, and SD card)

Searches track/file. For details on search operation, see [Search Operation \(P.72\)](#).

### [ ] [ ]

Searches the previous/next track/file.

### [ ]

Plays or pauses.

### [ ] (Only for music CD and disc media)

Stops playback.

### [ ] (Only for iPod, USB device, and SD card)

Touch to disconnect the device. For details, see [How to Play Media \(P.18\)](#).

### [ ] [ ] (Only for disc media, USB device, and SD card)

Searches previous/next folder.

## Sub function menu

### Music CD



### Disc media



### iPod



### USB device and SD card



The following functions can be performed by using keys in this area.



Repeats the current track/folder. Each time you touch the key, repeat mode switches in the following sequence;

CD: "track repeat" "repeat off"

iPod: "song repeat" "all songs repeat" "repeat off"

Disc media, USB device, SD card: "file repeat" "folder repeat" "repeat off"

### (Only for iPod, USB device, and SD card)

Searches track from the album artwork list. For details on search operation, see [Search from album artwork \(P.74\)](#).

### (Only for music CD and disc media)

Fast forward or fast backward.

### (Only for iPod, USB device, and SD card)

Plays the previous or next album in [Favorite list \(P.75\)](#).

### #:##:## or ##:##

For confirmation of play time.

During music CD playback, you can also confirm disc remaining time by touching time display. Each time you touch, the display switches between "P #:##" (track play time display) and "R #:##" (disc remaining time).



Randomly plays all tracks in current folder/disc or in current playlist in the connected iPod.

Each time you touch the key, random mode switches in the following sequence;

CD: "track random" "random off"

Disc media, USB device, SD card: "file random" "random off"

iPod: "track random" "album random" "random off"

### Status bar in center (Only for iPod, USB device, and SD card)

For confirmation of current playing position.

During USB device and iPod playback, you can drag the circle left or right to change the playing position.

## Search Operation

You can search music or video files by the following operations.

### NOTE

- If you use a remote controller, you can jump directly to the desired track/file with entering the track/folder/file number, play time, etc. For details, see [Direct search mode \(P.151\)](#).

## List search

You can search tracks, folders, and files according to hierarchy.

### 1 Touch illustrated area.



List Control screen appears.

### 2 Touch desired track/file.



Playback starts.

### NOTE

- For disc media, you can switch the file list and folder list by touching [Q].
- For disc media, you cannot display the list during random play and stop.

## Other search

There are other search methods in order to narrow search for a song.

This function is not available when music CD is the current source.

### 1 Touch [Q] in the control screen.

The search type screen appears.

### 2 Touch desired search method.

USB device and SD card



iPod

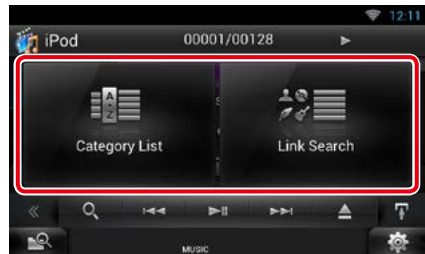

The list sorted in the way you selected appears.

See the following sections for each operation.

- [Category List]: You can search a file by selecting category [\(P.73\)](#).
- [Link Search]: You can search a file of same artist/album/genre/composer as the current track [\(P.73\)](#).
- [Folder List]: You can search a file according to hierarchy [\(P.74\)](#).

### NOTE

- For disc media, you can display the folder list directly by touching [Q].

### **Category search (Only for iPod, USB device, and SD card)**

- 1 Touch the desired category from the left part of the screen.**

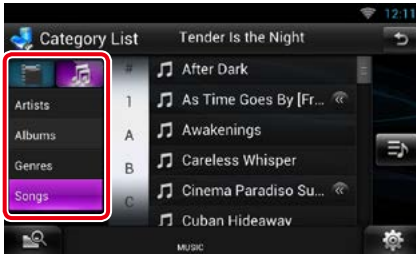

- 2 The list is sorted by selected category.**
- 3 Touch desired song.**  
Playback starts.

#### **NOTE**

- To narrow the search you can select a letter from the alphabet list in the center of the display.
- For operations in the list screen, see [Common Operation \(P.24\)](#).

### **Link search (Only for iPod, USB device, and SD card)**

- 1 Touch the desired link from the left part of the screen. You can select from artist, album, genre and composer.**

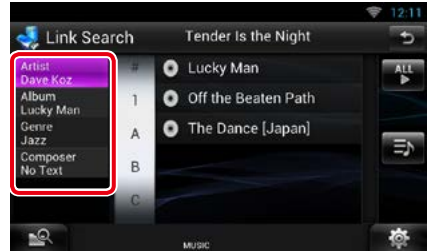

The link list corresponding to your selection appears.

#### **NOTE**

- The list is sorted by the way you selected.
  - **Artist:** Displays the album list of the artist.
  - **Album:** Displays all tunes of the current album.
  - **Genre:** Displays the artists list in which artists belong to the same genre.
  - **Composer:** Displays the album list of the composer of the current file.

- 2 Touch to select desired item in the list. Repeat this step until you find the desired file.**

#### **NOTE**

- To narrow the search you can select a letter from the alphabet list in the center of the display.
- For operations in the list screen, see [Common Operation \(P.24\)](#).

## Folder search (Only for disc media, USB device, and SD card)

1 Touch the desired folder.



Folders in the selected source are displayed in the center.

When you touch a folder its contents are displayed.

The hierarchy till the current folder is displayed on the left.

2 Touch desired item from the content list.

Playback starts.

### NOTE

- For operations in the list screen, see [Common Operation \(P.24\)](#).

## Search from album artwork (Only for iPod, USB device, and SD card)

You can search music files by selecting the album artwork.

1 Touch [  ].

Sub function menu appears.

2 Touch [  ].

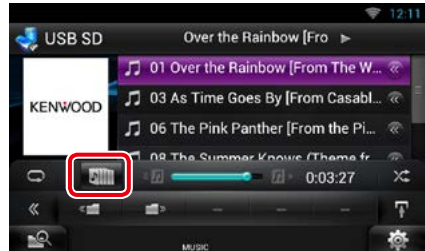

Favorite screen appears.

3 Touch desired artwork in the upper line.

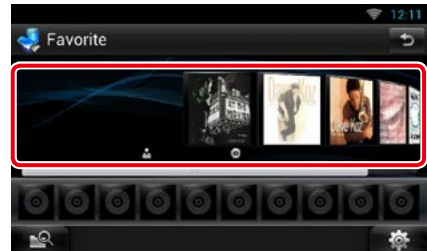

### NOTE

- The key in the upper side of the screen functions differently depending on the status.
  - When [Load Albums] appears:  
You have not yet loaded any artwork. Touch the key to start loading.
  - When [Load More Albums] appears:  
Some artwork are not loaded. Touch the key to load all artwork. If you touch the key, the track being played may stop and another track may start playback.
  - When the key does not available:  
All artwork are already loaded.

#### 4 Touch [▶] on the selected artwork.

The first song in the album is played.  
In addition, you can create your original playlist from this screen. For details, see [Favorite list \(P.75\)](#).

##### NOTE

- After all tracks in the album are played, the same album is played again from the first track.
- The albums with no photo are not displayed.

#### ***Favorite list***

You can create an original playlist of your favorite 10 albums by selecting album artworks.

#### 1 Touch and drag the desired album artwork in the upper line to the lower line.

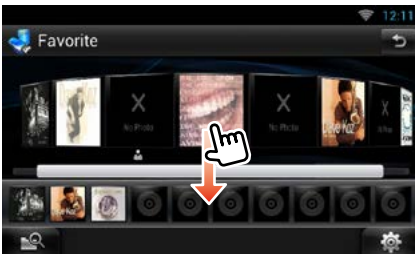

Selected album is registered to the favorite list.

##### NOTE

- The added album is placed on farthest right.
- You cannot register the same album already registered to the favorite list.
- Up to 10 albums can be registered to the list.

#### 2 Touch the desired artwork in the favorite list.

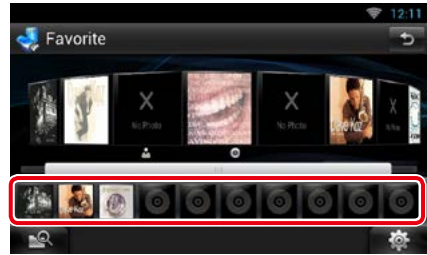

The selected album is played and the control screen appears.

##### NOTE

- The favorite list is played to the right starting with the selected album.
- To delete the album from the favorite list, touch and drag it to the upper line.
- You can change the playing order of the favorite list by dragging the artwork in the list.
- The favorite list mode is canceled in the following situations.
  - Playing another album from other list (folder list, category list, etc.)
  - Playing another album by touching the artwork in the upper line in the artwork list screen.
- The favorite list mode resumes after disconnecting/connecting the device or turning on/off. File being played, playing time code, favorite list content, favorite list order, etc. resumes if file configuration of the device is not changed.



## Movie Control

You can adjust the movie playback.

- 1 In the playback screen, touch illustrated area.**



Movie control screen appears.

- 2 Touch [Disc CTRL]. (Disc media only)**



Movie Control screen appears.

- 3 Perform desired operation as follows.**



### Changes subtitle language

Touch [Subtitle].

### Changes audio language

Touch [Audio].

### Exits the menu



Touch [Exit].

## Pandora® Operation

You can listen to the Pandora® on this unit by controlling the application installed in the iPhone, Android or BlackBerry.

### NOTE

- Install the latest version of the Pandora® application on your iPhone, Android or BlackBerry. ([P.170](#))  
**iPhone:** Search for "Pandora" in the Apple App Store to find and install the most current version.  
**Android:** Visit the Google Play and search for Pandora to install.  
**BlackBerry:** Visit [www.pandora.com](http://www.pandora.com) from the built in browser to download the Pandora application.
- When you first select Pandora as a source, the setting screen for the connection with the device installed the apps will appear. For the details, refer to [Application link setup \(P.84\)](#).

- 1 Press the <HOME> button.**
- 2 Flick the screen left or right to select the Source launcher panel.**
- 3 Touch [  ].**
- 4 Touch [  Pandora ].**

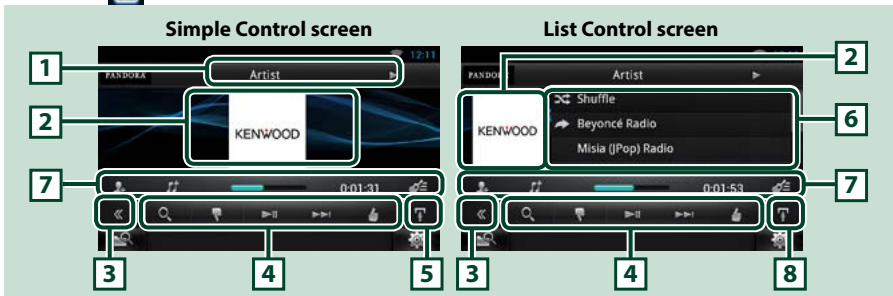

### 1 Information display

Displays text information of current content that is being played.

### 2 Artwork/Control switching area

The artwork is displayed if available from current content. When the artwork is not available, "No Photo" is displayed.

Touch to switch between the Simple Control and List Control screen.

### 3 Multi function key

Touch to switch the multi function menu. For details on the menu, see [Multi function menu \(P.78\)](#).

### 4 Multi function menu

Various functions can be performed by using the keys in this area. For details on the keys, see [Multi function menu \(P.78\)](#).

### 5 Sub function key

Touch to display "Sub function menu" (7 in this table).

### 6 Content information

Displays the information of the current content being played.

*Continued*

## 7 Sub function menu

Various functions can be performed by using keys in this area. For details on the keys, see [Sub function menu \(P.78\)](#).

## 8 Sub function/ List switching key

Touch to display “Sub function menu” (7 in this table).

Touch and hold to switch between the content list and the current content information.

### Multi function menu

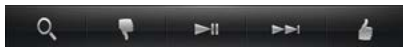

The following functions can be performed by using keys in this area.



Searches the station. For details on searching, see [Station list screen \(P.79\)](#).



Thumbs down to the current track and skip to the next track.



Plays or pauses the content of the current station/channel.



Skips the current track.

(Note this function is disabled when the Pandora skip limitation is exceeded.)

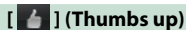

Registers the current content as favorite content.



Bookmark an artist in the current content.



Bookmark a track in the current content.

### Sub function menu

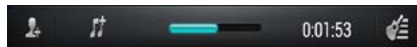

The following functions can be performed by using keys in this area.

#### Status bar in center

Displays the elapsed time since when you select the station and status bar which shows current location.



Creates a new station based on an artist being played.



Creates a new station based on a track being played.



Displays the genre list screen. For details on searching, see [Genre list screen \(P.79\)](#).

## Genre list screen

You can perform the following functions from this screen.



The selected genre is created as a new station.

## Station list screen

You can perform the following functions from this screen.

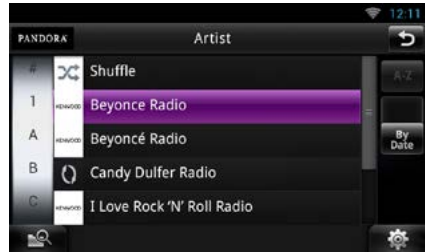

### Selects the station

Touch the station name in the list.

### Sort the list in alphabetical order

You can select the desired letter from the list which corresponds to the station name to help narrow the search.

### Display the genre list

Displays the genre list.

### Sort the list by date

Touch [ByDate]. The list is sorted to begin with the last registered station.

#### NOTE

- You can operate Pandora by using the remote controller. However, only playing, pausing, and skipping are available.
- You cannot select iPod as rear source when you select Pandora as main source in dual zone function.



## Apps Operation

You can listen to music or watch video from the Apps operating on iPod touch/iPhone or Android.

### NOTE

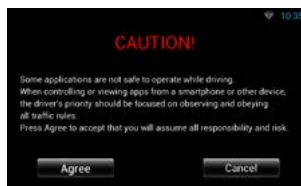
- When you first select APPS as a source, the setting screen for the connection with the device installed the apps will appear. For the details, refer to [Application link setup \(P.84\)](#).
- If the conditions below are satisfied, the touch keys will not appear, but the touch operation from the screen of the unit to the Android device becomes possible.
  - The unit and the Android device are connected with KCA-MH100 (sold separately) and over Bluetooth profile HID and SPP.
  - To enable the touch operation on this unit, install "Kenwood Smartphone Control" and start it. Search for "Kenwood Smartphone Control" in Google play to find and install the most current version. For details, see web site. [http://www.kenwood.com/products/car\\_audio/app/kenwood\\_smartphone\\_control/eng/index.html](http://www.kenwood.com/products/car_audio/app/kenwood_smartphone_control/eng/index.html)
  - If you drive using an app that is prohibited from using while driving, the confirmation screen appears. As you select [Yes], the launcher of "Kenwood Smartphone Control" starts.
- Depending on the app, the touch keys may not work or be displayed.
- When you turn on the power and select apps as the source, the caution for the operation, watching video and listening music appears. With your acceptance, you can control apps, listen to music and watch video from apps when you are driving.



- 1 Press the <HOME> button.**
- 2 Flick the screen left or right to select the Source launcher panel.**
- 3 Touch [  ].**
- 4 Touch [  APPS].**

### When the touch keys appear



### When the touch operation is possible



#### **1** [▶] [II] (iPod only) / [▶II]

Plays or pauses.

#### **2** [◀◀] [▶▶]

Searches the previous/next file.

Touch and hold to fast backward/ forward. (iPod/ iPhone only)

#### **3** Key display area

Touch to display the operation buttons. Touch again to erase them.

## USB/SD/iPod/App/DivX Setup

You can perform setup when using USB/SD/iPod/ App/ DivX.

**1 Touch [  ].**

Quick menu appears.

**2 Touch [SETUP].**

SETUP Menu screen appears.

**3 Touch [Source].**



Source SETUP Menu screen appears.

**4 Touch [USB SETUP], [iPod SETUP], [APP SETUP] or [DivX VOD] in the list.**

Each setup screen appears.

See the following section for each setting.

- [USB setup \(P.82\)](#)
- [iPod setup \(P.82\)](#)
- [App setup \(P.84\)](#)
- [DivX® VOD \(P.81\)](#)

## DivX® VOD

**1 Set each item as follows.**



### DivX(R) Registration Code

Checks the registration code. This code is needed when making a disc which has DRM (Digital Rights Management).

### DivX(R) Deactivation

Deregisters the unit which is already registered. After you touch the key, a confirmation message appears. Follow the message and complete the operation.

#### NOTE

- [DivX(R) Registration Code] is disabled when a DVD is being played.
- When downloading a DivX VOD file controlled by DRM, register the code appeared on the screen. Otherwise the file may not be able to play with this unit. Remaining number of viewing is displayed when playing a DivX VOD file with the viewing restriction. When the remaining number of viewing reached 0, a warning message appears and the file cannot be played.

## USB setup

### 1 Set each item as follows.



#### On Screen USB

Set how information from a USB device or SD is displayed.

**Auto (Default):** Information appears for 5 seconds when updated.

**OFF:** Does not display any information.

## iPod setup

### 1 Set each item as follows.

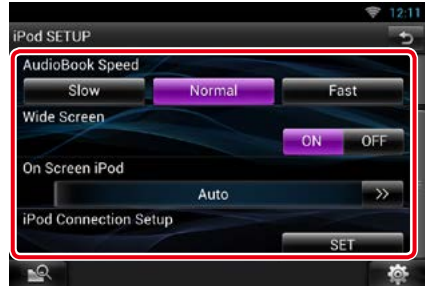

#### AudioBook Speed

Set the audio book playback speed. Select from [Slow], [Normal] (default), and [Fast].

#### Wide Screen\*1

Set Wide Screen. Set [ON] (default) or [OFF].

#### On Screen iPod

Set how to display the information of the iPod.

**Auto (Default):** Information appears for 5 seconds when updated.

**OFF:** Does not display any information.



#### iPod Connection Setup\*2

Sets the way to connect the iPod/iPhone with this unit.

**\*1 This setting is not available when an iPod is connected.**

**\*2 This item can be set when in STANDBY source.**

## iPod/iPhone connection setup

- 1 Press the <HOME> button twice to the Source launcher panel.
- 2 Touch [  ].
- 3 Touch [  STANDBY].
- 4 Touch [  ].
- 5 Touch [SETUP].
- 6 Touch [Source].
- 7 Touch [iPod SETUP].
- 8 Touch [iPod Connection Setup] in the iPod SETUP screen.  
iPod connection setup screen appears.

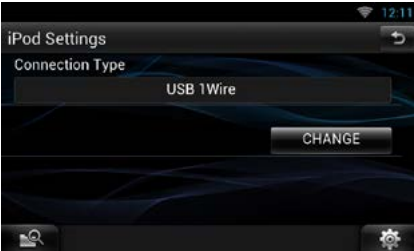

- 9 Touch [CHANGE].

### 10 Set each item as follows.



#### USB + AV-IN

Select when connecting with KCA-iP202.

#### USB 1Wire

Select when connecting with KCA-iP103 or KCA-iP102.

#### HDMI + BT

Select when connecting with KCA-HD100 and Lightning Digital AV Adapter.

## Bluetooth

Select when connecting via Bluetooth only.

### 11 Touch [Next].

Confirmation screen appears.

### 12 Touch [Done].

### 13 Touch [ ].

#### NOTE

- For the details of the necessary cable and adapter to connect with iPod/iPhone, refer to [Music/Video Basic Operation \(P.66\)](#).
- When you select "HDMI + BT" or "Bluetooth" in step 10, Bluetooth device selection screen will appear. Select the iPod/iPhone to be connected.

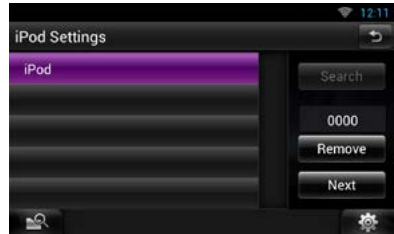

- If a connectable Bluetooth device is not displayed, touch [Search] and do the pairing of the devices.
- The setting of "iPod connection setup" is just for the unit and regardless of the account.



## App setup

### 1 Set each item as follows.



#### APP Settings\*

Makes the detailed setting of the device in which APPS are installed.

#### Screen Control

Touch [SET] to display the screen control screen. See [Monitor Screen Setup \(P.128\)](#).

\*This item can be set when in STANDBY source.

## Application link setup

### 1 Press the <HOME> button twice to the Source launcher panel.

### 2 Touch [ ].

### 3 Touch [ STANDBY ].

### 4 Touch [ ].

### 5 Touch [SETUP].

### 6 Touch [Source].

### 7 Touch [APP SETUP].

### 8 Touch [SET] on [APP Settings] in the APP SETUP screen.

Application link setup screen appears.



### 9 Touch [CHANGE].

### 10 Select the device installed the apps.

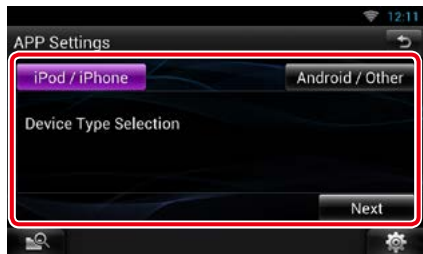

#### iPod/iPhone

Select when using iPod/iPhone.

#### Android/Other

Select when using Android or BlackBerry device.

### 11 Touch [Next].

## 12 Select the way to connect the device with this unit.

### When selecting [iPod/iPhone]

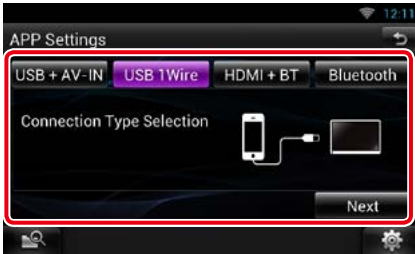

#### USB + AV-IN

Select when connecting with KCA-iP202.

#### USB 1Wire

Select when connecting with KCA-iP103 or KCA-iP102.

#### HDMI + BT

Select when connecting with KCA-HD100 and Lightning Digital AV Adapter.

#### Bluetooth

Select when connecting via Bluetooth only.

### When selecting [Android/Other]

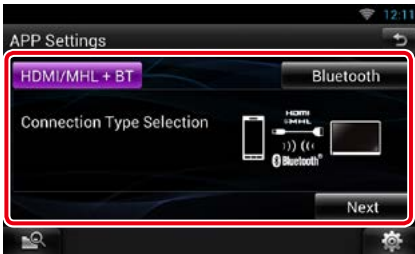

#### HDMI/MHL + BT

Select when connecting with KCA-MH100.

#### Bluetooth

Select when connecting via Bluetooth only.

## 13 Touch [Next].

Confirmation screen appears.

## 14 Touch [Done].

### NOTE

- For the details of the necessary cable and adapter to connect with iPod/iPhone and Android device, refer to [Music/Video Basic Operation \(P.66\)](#).
- When you select "HDMI + BT", "HDMI/MHL + BT" or "Bluetooth" in step 12, Bluetooth device selection screen will appear. Select the device to be connected.

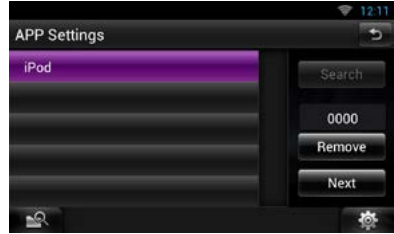

If a connectable Bluetooth device is not displayed, touch [Search] and do the pairing of the devices.

- When you select "iPod/iPhone" in App Setup, select "iPod" as the source, and select App on the iPod, the source of this unit is also changed to App automatically.
- The setting of "Application link setup" is just for the unit and regardless of the account.

# Cloud Storage Operation

## Starting procedure

Make preparations for allowing this unit to play the music files uploaded to Dropbox.

### Preparation

- You must have a connection with the internet. See [Network Setup \(P.32\)](#).
- You can use a user account when you have logged in the Owner or User.
- To use this service, a Dropbox account is required.

### 1 Upload music files to Dropbox.

### 2 In the Route Collector site, create a folder and playlist of the files to be played.

For how to set the folder and playlist of the files to be played, refer to the website.

<http://www.route-collector.com/>

### Available content

Content that can be delivered or played by this unit are as follows:

- Audio file: MP3 (.mp3), AAC-LC (.m4a/.aac), WMA (.wma), WAV (.wav), FLAC (.flac)
- Copyrighted content cannot be played.

## Music Basic Operation

The music files uploaded to Dropbox can be played.

### Preparation

- To play the files uploaded to Dropbox, setting is required. See [Starting procedure \(P.86\)](#).

### 1 Press the <HOME> button.

### 2 Flick the screen left or right to select the Source launcher panel.

### 3 Touch [ ].

### 4 Touch [ Storage].

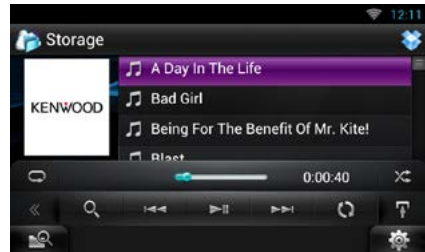

### [ ]

Plays or pauses.

### [ ]

Searches the previous/next file.

### [ ]

Searches file. For details on search operation, see [Category search \(P.87\)](#).

### [ ]

The data base like the song information in the server is reorganized. Press it when you change the file in the Dropbox.

### [ ]

Touch to display "Sub function menu".

Touch and hold to switch between the file list and the current file information.

### [ ]

Repeats the current file. Each time you touch the key, repeat mode switches on or off.



Randomly plays all files in current folder or in current playlist.

Each time you touch the key, random mode switches in the following sequence; "file random" "random off"

#:##:##

For confirmation of play time.

### Status bar in center

For confirmation of current playing position. You can drag the circle left or right to change the playing position.

## Category search

You can search music files by the following operations.

- 1 Touch [ ] in the control screen.**  
The search type screen appears.
- 2 Touch the desired category from the left part of the screen.**

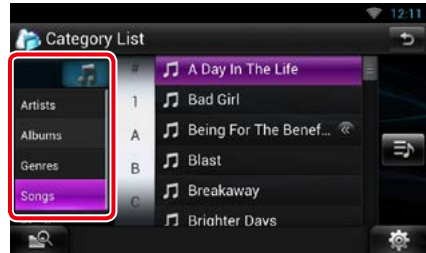

- 3 The list is sorted by selected category.**
- 4 Touch desired music file.**  
Playback starts.

### NOTE

- To narrow the search you can select a letter from the alphabet list in the center of the display.
- For operations in the list screen, see [Common Operation \(P.24\)](#).

# Kenwood Wireless Link Operation

## Starting procedure

By using the Wi-Fi function, media files can be shared with another media server device or client (player) device.

### Preparation

- Turn on the function of Wi-Fi connection to a media server device or client device.

### About Network connection

There are two types of network to connect to the media server device or the client (player) device.

- **Wi-Fi access:** The internet device that becomes the Wi-Fi access point is necessary. Smartphone and tablet PC can be connected through the Wi-Fi access point. See [Wi-Fi Setup \(P.32\)](#).  
– You cannot listen to music or watch video in the smartphone when its tethering function is in use.

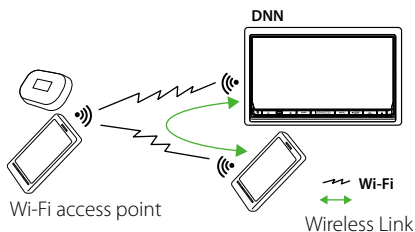

- **Wi-Fi hotspot:** This unit becomes the Wi-Fi access point and can connect with smartphone and tablet PC. See [Wi-Fi Hotspot Setup \(P.34\)](#).

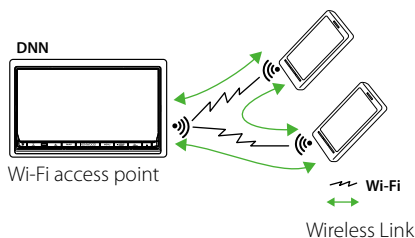

### Media Server function

Plays the content stored in the USB memory or SD card connected to this unit via another network media player (client device).

- We confirmed normal operation using the following network media players (software):
- Windows Media Player 12

### Media Player function

Plays the content stored in another media server device via this unit.

- We confirmed normal operation using the following media servers (software):
- Windows Media Player 12

### Media Controller function

Allows you to handle the content stored in another media server device via this unit and play them on another network media player (client device).

### Media Renderer function

Plays the content being operated on another media controller through this unit.



### Available content

Content that can be delivered or played by this unit are as follows:

- Audio file: MP3 (.mp3), AAC-LC (.m4a/ .aac), WMA (.wma), WAV (.wav), FLAC (.flac)
- Video file: MPEG-1/2 (.mpg/ .mpeg/ .m2p), MPEG-4 (.mp4/ .m4v), WMV (.wmv/ .m2ts), MKV (.mkv)
- Copyrighted content cannot be played.

## Media Server function

Plays the content stored in the USB memory or SD card connected to this unit via another network media player (client device).

- 1 Press the <HOME> button.
- 2 Flick the screen left or right to select the Source launcher panel.
- 3 Touch [  ].
- 4 Touch [  Wireless Link ].
- 5 Touch [DMS].





The server function is turned on.

- 6 **Connect from the client device.**  
Operate the client device to connect to the server.  
Server name: DNN992 or DNN9150BT.

## Media Player function

Plays the content stored in another media server device via this unit.

- 1 Press the <HOME> button.
- 2 Flick the screen left or right to select the Source launcher panel.
- 3 Touch [  ].
- 4 Touch [  Wireless Link ].
- 5 Connect to the media server.



A list of detected media servers is displayed.

Touch the server name of the server to connect.

- 6 **Select the content to play.**



Select the category of the content to play.  
A list of detected content is displayed.

## Plays screen

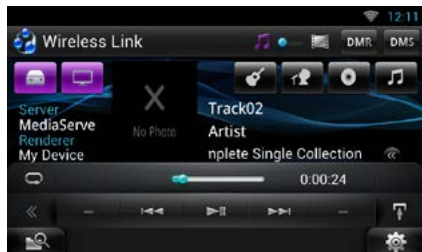

[▶||]

Plays or pauses.

[◀◀] [▶▶]

Searches the previous/next file.

[🔄]

Repeats the current file. Each time you touch the key, repeat mode switches on or off.

[🎵] [📺]

Switches between music and video files.

##:##:## or ##:##

For confirmation of play time.

### Status bar in center

For confirmation of current playing position. You can drag the circle left or right to change the playing position.

[📁]

Touch to display "Sub function menu".

Touch and hold to switch between the file list and the current file information.

## Media Controller function

Allows you to handle the content stored in another media server device via this unit and play them on another network media player (client device).

- 1 Press the <HOME> button.
- 2 Flick the screen left or right to select the Source launcher panel.
- 3 Touch [📁].
- 4 Touch [📁 Wireless Link].
- 5 Connect to the media server.



A list of detected media servers is displayed.

Touch the server name of the server to connect.

- 6 Select a network media player to be used for playback.

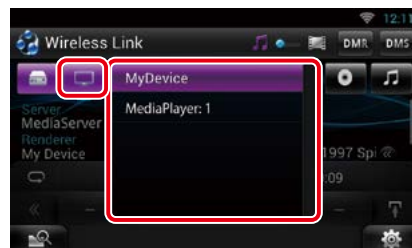



A list of detected network media players is displayed.

Touch the name of the network media player to be used for playback.

## Media Renderer function

Plays the content being operated on another media controller through this unit.

- 1 Press the <HOME> button.**
- 2 Flick the screen left or right to select the Source launcher panel.**
- 3 Touch [  ].**
- 4 Touch [  Wireless Link].**
- 5 Touch [DMR].**



The Rendering function is turned on.

- 6 Establish connection from the media controller.**

Operate the media controller to connect to this unit.  
This unit:DNN992 or DNN9150BT.



# Radio, HD Radio™ tuner Operation

## About HD Radio™ Technology



This HD Radio receiver enables:

**PSD**

**HD2/HD3**

**Bookmark**

**Digital Sound**

**Artist Experience**

### PSD

- Program Service Data provides song name, artist, station ID, and other relevant data streams

### HD2/HD3

- Adjacent to traditional main stations are HD2/HD3 Channels, providing new original formats on the FM dial

### Bookmark

- Bookmark is a music & product discovery feature that enables users to store information about content on the radio and delivers interactive information via QR codes

### Digital Sound

- HD Radio broadcasts deliver crystal clear, CD-like digital audio quality to consumers

### Artist Experience

- Visual images, such as album art of over-the-air broadcasts from HD Radio stations

## Radio/ HD Radio tuner Basic Operation

Most functions can be controlled from the source control screen.

### NOTE

- Set the remote controller mode switch to AUD mode before starting operation, see [Switching the operation mode \(P.151\)](#).
- HD Radio broadcasting can be received only by the DNN992.
- HD Radio broadcasting is for North American sales area only.
- The screen shot below is for tuner. It may be different from the one for HD Radio broadcasting.

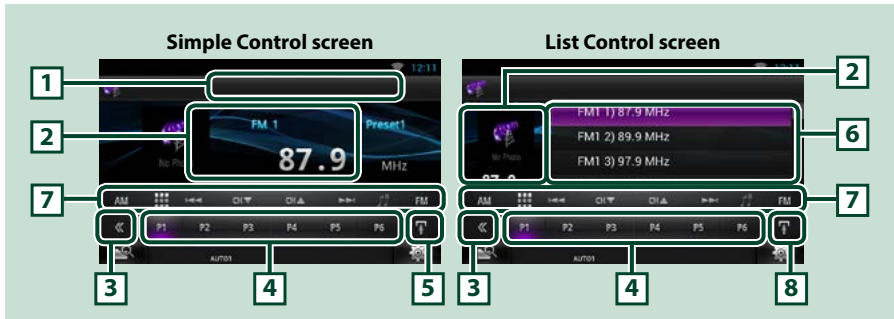

### 1 PS/Station name display

Displays the PS name or station name.

### 2 Information display/Control switching area

Displays the following information.

- **Picture:** The picture data or station Logo data is displayed if available from current content.
- **[FM1] etc.:** Band display
- **MHz/kHz:** Frequency display
- **Preset #:** Preset number
- **HD# (HD Radio tuner only):** Channel display

Touch to switch between the Simple Control and List Control screen.

### 3 Multi function key

Touch to switch the multi function menu. For details on the menu, see [Multi function menu \(P.94\)](#).

### 4 Preset key/Multi function menu

Recalls the memorized station or channel. When touched for 2 seconds, stores the current receiving station or channel in memory.

When switched, various functions can be performed by using keys in this area.

For details on the menu, see [Multi function menu \(P.94\)](#).

### 5 Sub function key

Touch to display "Sub function menu" (7 in this table).

**Continued**

## 6 Preset list

Displays the list of preset stations or channels and the information.

## 7 Sub function menu

The following functions can be performed by using keys in this area.

- **Switches the band:** Touch [AM] or [FM].
- **Tunes in a station:** Touch [◀◀] or [▶▶]. The method of frequency switching can be changed. See Seek mode.
- **Selects a channel (HD Radio tuner only):** Touch [CH ▼] or [CH ▲].
- **Stores the information about the song being received:** Touch [📌]. See [Bookmark \(P.98\)](#).
- **Tunes in by entering direct number (HD Radio tuner only):**  
Touch [🔢] and enter the desired number. For details, see [Direct search \(P.96\)](#).

The bar in center (tuner only) shows the current frequency location.

## 8 Sub function/ List switching key

Touch to display “Sub function menu” (7 in this table).

Touch and hold to switch between the preset list and the information list.

In HD Radio tuner mode, tuned program information will be displayed.

## Multi function menu



The functions of each key are as follows.

### [P1] - [P6]

Select the preset station. Touch for 2 seconds to store the current station into the preset memory.

### [🔍]

Select search method from preset station selection, channel selection or bookmark selection. For details on search operation, see [Selecting Operation \(P.95\)](#), [Bookmark \(P.98\)](#).

### [TI] (FM Tuner and HD Radio tuner only)

Sets the traffic information mode on. For details, see [Traffic Information \(P.97\)](#).

### [SEEK]

Switches the seek mode in the following sequence; [AUTO1], [AUTO2], [MANUAL].

- **AUTO1:** Tunes in a station with good reception automatically.
- **AUTO2:** Tunes in stations in memory one after another.
- **MANUAL:** Switches to the next frequency manually.

### [AME]

Selects the auto memory mode. For details, see [Auto memory \(P.95\)](#).

### [RCV] (HD Radio tuner only)

Switches the receive mode in the following sequence; [AUTO], [DIGITAL], [ANALOG]. For details, see [Receive Mode \(P.98\)](#).

### [PTY] (FM Tuner and HD Radio tuner only)

Searches a program by setting program type. For details, see [Search by program type \(P.96\)](#).

## Memory Operation

### Auto memory

You can automatically store stations with good reception to memory.

#### NOTE

- Auto memory terminates when 6 stations are stored or when all stations are tuned in.
- Auto memory ends automatically if you do not operate within 10 seconds.

**1** Touch [  ].

Sub function menu appears.



**2** Touch desired band key.



**3** Touch [  ] in the control screen.

The multi function menu appears.

**4** Touch [AME] in the multi function menu.

**5** Touch [  ] or [  ] in the sub function menu.

Auto memory starts.

### Manual memory

You can store the current receiving station or channel in memory.

**1** Select a station or channel you wish to store in memory.

**2** Touch [P#] (#:1-6) in which you want to store the station or channel for 2 seconds until a beep sounds.

## Selecting Operation

### Preset select

You can list and select memorized station or channel.

#### Selecting from the multi function menu

**1** Touch the desired number from P1 to P6.

The unit will tune to the selected station or channel.

#### Selecting from the preset list

**1** Touch illustrated area.



List Control screen appears.

**2** Touch and hold [  ].

Preset list appears.

**3** Select a station or channel from the list.



#### NOTE

- Touching [  ] and then [Preset List] displays the preset channel list. You can also select your desired channel from the list.

## Search by program type

You can tune to a station with a specific program type when listening to FM.

- 1 Touch [  ] in the control screen.  
The multi function menu appears.
- 2 Touch [PTY] in the multi function menu.  
TUNER PTY Mode screen appears.
- 3 Select a program type from the list.
- 4 Touch [Search].



You can search a station of the selected program type.

## Direct search (HD Radio tuner only)

You can tune in by entering the desired frequency or channel number.

- 1 Touch [  ].



10Key Direct screen appears.

- 2 Enter the frequency/ channel number and touch [Enter].



### NOTE

- To cancel the direct search, touch [Cancel].
- To clear the number you entered, touch [Clear].
- For HD Radio tuner, you can search by frequency. Each time you touch [Mode] in the left part of the screen, it changes the mode between frequency entering mode and channel entering mode.

## Category/Channel search (HD Radio tuner only)

You can specify the desired category and select a channel.

- 1 Touch [ ] in the control screen.**  
The multi function menu appears.
- 2 Touch [ ] in the multi function menu.**  
The list type screen appears.
- 3 Touch [Preset List] or [Channel List].**

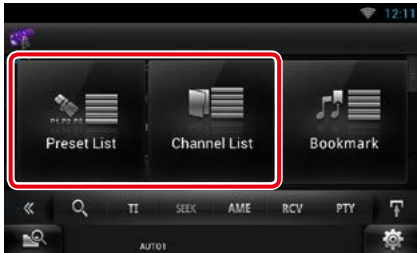

The previously used category or channel list appears.

- 4 Select the desired content from the list.**

### NOTE

- Each time you touch [Info Change] in the channel list, switches the sequence of the list. Song title, artist name, album name

## Traffic Information (HD Radio tuner only)

You can listen and watch the traffic information automatically when a traffic bulletin starts.

However, this feature requires a Radio Broadcast Data System that includes the TI information.

- 1 Touch [ ] in the control screen.**  
The multi function menu appears.
- 2 Touch [TI] in the multi function menu.**  
Traffic information mode is set.

## When the traffic bulletin starts

The Traffic Information screen appears automatically.



### NOTE

- It is necessary to have Traffic Information function set to on in order to have the Traffic Information screen appear automatically.
- The volume setting during reception of traffic information is automatically stored. The next time the traffic information is received, this unit recalls the volume setting automatically.

## Receive Mode (HD Radio tuner only)

You can set the radio broadcasts receive mode.

- 1 Touch [⏪] in the control screen.  
The multi function menu appears.
- 2 Touch [RCV] in the multi function menu.  
HD Radio tuner Mode screen appears.
- 3 Select the receive mode from [Auto], [Digital], and [Analog] using [◀] and [▶].



### NOTE

- If you select [Auto], tunes to analog broadcast automatically when there is no digital broadcast.

## Bookmark

Stores tag information (title, artist, album, URL, and description) about the song you are listening to now.

Detailed information and QR codes can be displayed according to the stored tag information.

### Registering a bookmark

- 1 Touch [📌].  
Sub function menu appears.
- 2 Touch [🎵].  
Registers a bookmark.

### NOTE

- Up to 100 bookmarks can be registered to this unit.

### Bookmark list

Displaying a list of registered bookmarks and detailed information and QR code of the song.

- 1 Touch [⏪] in the control screen.  
The multi function menu appears.
- 2 Touch [🔍] in the multi function menu.  
The list type screen appears.
- 3 Touch [Bookmark].

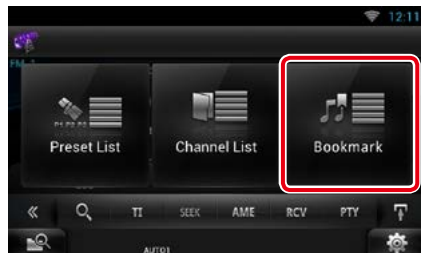

The Bookmark List appears.

**4 Select the desired bookmark from the list.**

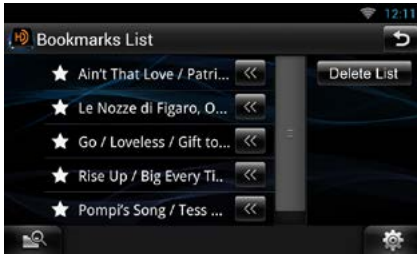

The bookmark information appears.



Deletes the bookmarks being displayed.

**Bookmark delete**

Deleting a bookmark.

**1 Touch [ ] in the control screen.**

The multi function menu appears.

**2 Touch [ ] in the multi function menu.**

The list type screen appears.

**3 Touch [Bookmark].**

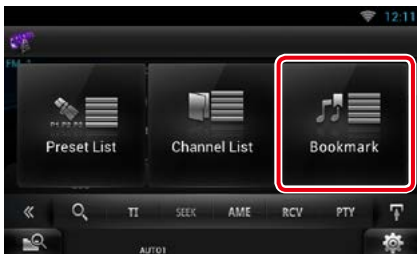

The Bookmark List appears.

**4 Touch [Delete List].**

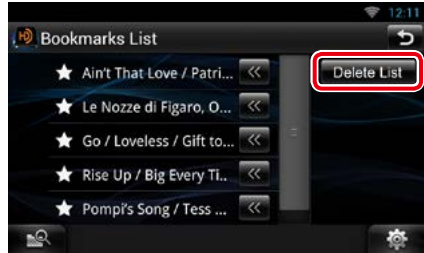

The Bookmark Delete List appears.

**5 Select the bookmark to delete from the list.**

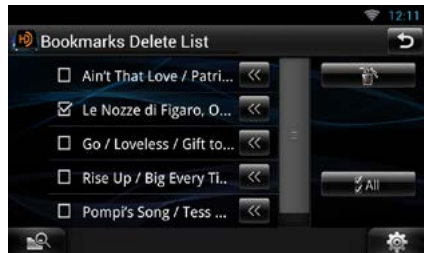

**All**

Select all bookmarks.

**6 Touch [ ].**

Deletes all the selected bookmark(s)



# SiriusXM® Satellite Radio Operation (DNN992)

## SiriusXM® Basic Operation

Most functions can be controlled from the source control screen.

### Before use

- SiriusXM Satellite Radio operation requires the connection of the optional SiriusXM Connect Vehicle Tuner. To activate the SiriusXM Vehicle Connect tuner, you will need the Radio ID.
- **Make a note of your Radio ID:** To confirm your Radio ID, tune to channel 0. The letters I, O, S and F are not used in any Radio ID. The Radio ID is also located on the label of the SiriusXM Connect Vehicle Tuner.
- **How to activate your SiriusXM Service:** Go to [www.siriusxm.com/activatenow](http://www.siriusxm.com/activatenow) or call 1-866-635-2349 to activate your SiriusXM Vehicle Connect Tuner. To activate SiriusXM Canada service go to [www.xmradio.ca](http://www.xmradio.ca) and click on "ACTIVATE RADIO" in the top right corner, or call 1-877-438-9677

### NOTE

- Set the remote controller mode switch to AUD mode before starting operation, see [Switching the operation mode \(P.151\)](#).
- To use SiriusXM® Satellite Radio, the optional accessory is necessary.
- SiriusXM® Satellite Radio are for North American sales area only.

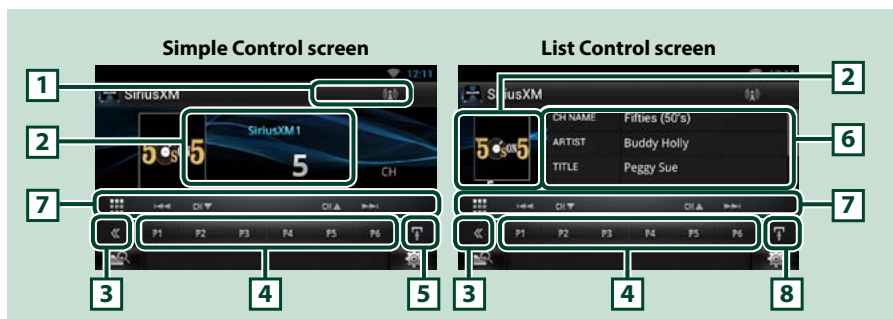

### 1 Signal Strength indication

Displays the received signal strength of the SiriusXM tuner.

### 2 Information display/Control switching area

Displays the following information.

- [SiriusXM1], etc.: Band display
- Preset #: Preset number
- #CH: Channel display
- Logo: Channel logo display

Touch to switch between the Simple Control and List Control screen.

### 3 Multi function key

Touch to switch the multi function menu. For details on the menu, see [Multi function menu \(P.102\)](#).

### 4 Preset key/Multi function menu

Recalls the memorized channel. When touched for 2 seconds, the current channel being received is stored to the memory.

When switched, various functions can be performed by using keys in this area.

For details on the menu, see [Multi function menu \(P.102\)](#).

### 5 Sub function key

Touch to display "Sub function menu" (7 in this table).

### 6 Information list

Displays information about the current music being played: Channel Name, Artist Name, Song Title, Content Info, Category Name, Channel Description, Similar Channels

### 7 Sub function menu

The following functions can be performed by using keys in this area.

- **Tunes in a station:** Touch [CH▼] or [CH▲].
- **Searches the previous/next track:** Touch [◀◀] or [▶▶]. Fast forward/fast backward when keep on touching. See [SiriusXM Replay™ \(P.106\)](#).
- **Tunes in by entering direct number:** Touch [⏏] and enter the desired number. For details, see [Direct search \(P.104\)](#).

### 8 Sub function/ List switching key

Touch to display "Sub function menu" (7 in this table).

Touch and hold to switch between the preset list and the information list.

## Multi function menu

P1 P2 P3 P4 P5 P6

The functions of each key are as follows.

### [P1] - [P6]

Select the preset channel. Touch for 2 seconds to store the current station into the preset memory.

### []

Select search method from preset channel selection or category/channel search. For details on search operation, see [Selecting Operation \(P.103\)](#).

### [▶||]

Plays or pauses. See [Replay \(P.106\)](#).

### [SEEK]

Switches the seek mode in the following sequence; [SEEK1], [SEEK2].



- SEEK1: Tunes channels one after the other.
- SEEK2: Selects channels in preset (memory) one after the other.

### [BAND]

Switches the band.

### []/[]

Touch for 2 seconds to register content as Alert content.

- []: Registers the artist of the song you are listening to now as alert content.
- []: Registers the song you are listening to now as alert content.

For details, see [Content Alert \(P.105\)](#).

### []

Turns the Traffic & Weather Jump function on or off.

For details, see [City select for Traffic & Weather Jump \(P.111\)](#).

### []

Listen to the on-air song (live).

### [TUNE SCAN]

Hear a few seconds of the songs from each of the SmartFavorite music channels on the current preset band. See [TuneScan™ \(P.107\)](#).

## Memory Operation

### Manual memory

You can store the current receiving station or channel in memory.

- 1 **Select a station or channel you wish to store in memory.**
- 2 **Touch [P#] (#:1-6) in which you want to store the station or channel for 2 seconds until a beep sounds.**

## Selecting Operation

### Preset select

You can list and select memorized station or channel.

#### **Selecting from the multi function menu**

- 1 **Touch the desired number from P1 to P6.**  
The unit will tune to the selected station or channel.

### Selecting from the preset list

- 1 **Touch illustrated area.**

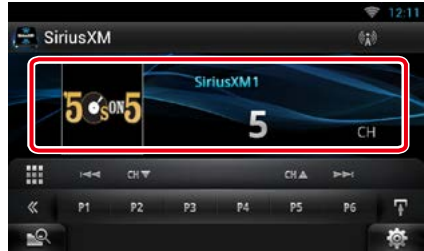

List Control screen appears.

- 2 **Touch and hold [  ].**

Preset list appears.

- 3 **Select a station or channel from the list.**



#### NOTE

- Touching [  ] and then [Preset List] displays the preset channel list. You can also select your desired channel from the list.

## Direct search

You can tune in by entering the desired frequency or channel number.

### 1 Touch [].



10Key Direct screen appears.

### 2 Enter the frequency/ channel number and touch [Enter].



#### NOTE

- To cancel the direct search, touch [Cancel].
- To clear the number you entered, touch [Clear].

## Category/Channel search

You can specify the desired category and select a channel.

### 1 Touch [] in the control screen.

The multi function menu appears.

### 2 Touch [] in the multi function menu.

The list type screen appears.

### 3 Touch [Category List].

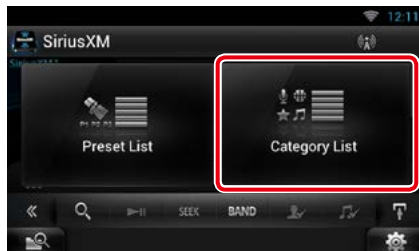

The previously used category or channel list appears.

### 4 Select the desired content from the list.

#### NOTE

- All the channels in the selected category appear.
- Touching [All Channel] displays all the channels.
- Each time you touch [Info Change] in the channel list, switches the sequence of the list.  
Channel name, artist name, song title, category name, content info

## Content Alert

When a broadcast program related to the registered artist, song, team or city starts, a message appears to allow you to switch the current channel to the relevant channel.

### 1 When the broadcast of the registered content starts, an Alert screen appears.



#### Jump

Touch to display the Alert Content List screen.

#### Ignore

Touch to cancel the Content alert.

### 2 Select content from the list.



#### NOTE

- Each time you touched [Type], switches the sequence of the Content alert list as follows; Artist alert, Song alert, GameAlert™.
- For how to register artists and songs and turn on/off the Team alert function, see [Multi function menu \(P.102\)](#).
- For how to set up the Content alert function, see [SiriusXM Setup \(P.108\)](#).

## Replay

You can replay up to the last 60 minutes broadcasting of current channel

### 1 Simple Control screen or List Control screen.



#### **Multi function menu**

[▶||]

Plays or pauses.

[BAND]

Switches the band.

[📺]

Listen to the on-air song (live).

[🔍]

Displays a list of recorded data on a program basis when a broadcast is replaying.

#### **Sub function menu**

[⏮] [⏭]

Searches the previous/next track. Fast forward/ fast backward when keep on touching.

[CH▼] [CH▲]

Tunes in a station.

#### **Replay time bar**

Display recorded capacity and playback position.

### 2 Touch [🔍] to display a program list.



#### **Program list**

Touching this plays back the displayed program.

#### **[Info Change]**

Touching this allows you to switch among the Artist name, Song title, Category name, and Content info cyclically.

## Smart Favorites, TuneStart™

Station memory number 1 through 6 of current band are Smart Favorite channels. SiriusXM Vehicle Tuner automatically buffered the broadcast audio content of the Smart Favorites channels in the background.

You can rewind and replay up to 30 minutes of any of the missed news, talk, sports or music content when you tune to a Smart Favorite channel. (see [Replay \(P.106\)](#))

When tuning Smart Favorites channels, songs will play from the beginning of each track (Tune Start). You can enable/disable Tune Start. (see [TuneStart™ setup \(P.111\)](#))

## TuneScan™

TuneScan™ is a feature that plays samples from the starts of multiple buffered songs from each of the Smart Favorite channels that predominantly play music selections. You have easy access to a large sampling of music content and can enjoy hearing a full song when stopping the scan on a song of interest.

**1 Touch [⏮] in the control screen.**

The multi function menu appears.

**2 Touch [TUNE SCAN] in the multi function menu.**

The introductions of the songs will be played in recorded order.

**3 Touch [TUNE SCAN] while your favorite song is being played.**

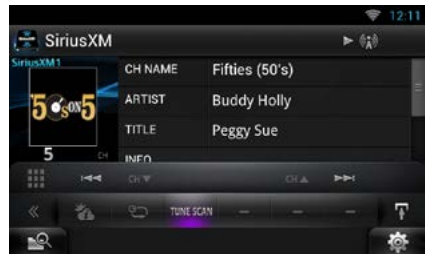

Scan finishes and continues playing the song.

### NOTE

- To cancel Tune Scan, Touch [TUNE SCAN] for 2 seconds.  
After cancel, the channel before starting Tune Scan will be played.



## SiriusXM Setup

- 1 Touch [  ].**  
Quick menu appears.
- 2 Touch [SETUP].**  
SETUP Menu screen appears.
- 3 Touch [Source].**



Source SETUP Menu screen appears.

- 4 Touch [SiriusXM SETUP] in the list.**  
SiriusXM SETUP screen appears.  
See the following section for each setting.
  - **Set up the parental code** ([P.108](#))
  - **Set up the parental control** ([P.109](#))
  - **Set up the skip channel select** ([P.110](#))
  - **Set up the Content alerts** ([P.110](#))
  - **Set up the content for Content alerts** ([P.110](#))
  - **Select the city for Content alerts** ([P.111](#))
  - **Set up the TuneStart™** ([P.111](#))
  - **Reset to the default settings** ([P.111](#))

## Parental code

You can set a SiriusXM parental code.

- 1 Touch [Change] of [Parental Code] in the SiriusXM SETUP screen.**  
Parental Pass Check screen appears.

### NOTE

- The code number is set to "0000" as default.

- 2 Enter the current code number.**  
Parental Pass 1st entering screen appears.
- 3 Enter the new code number and touch [Enter].**  
Parental Pass 2nd entering screen appears.
- 4 Enter the same code number as you input in step 3 and touch [Enter].**  
The code number is confirmed and SiriusXM parental code is now set.

## Parental control

Parental control is a feature that provides the user with the ability to prevent unauthorized access to mature content and user selected channels.

- 1 Touch [ON] or [OFF] of [Parental Lock Mature] in the SiriusXM SETUP screen.**
- 2 Enter the same code number as you originally input in [Parental code \(P.108\)](#) and touch [Enter].**

Turns the Mature on or off.

Default is "OFF".

If you want to separately set the parental lock for each channel, select OFF and proceed to step 3 onward.

- 3 Touch [SET] of [Parental Lock Channel Select] in the SiriusXM SETUP screen.** Parental Pass Check screen appears.

### NOTE

- You need to complete [Parental code \(P.108\)](#) beforehand.
- To delete the parental lock channel setting, touch and hold [Unlock All] for 2 seconds, enter the Parental code number, then touch [Enter].

- 4 Enter the same code number as you originally input in [Parental code \(P.108\)](#) and touch [Enter].**

Parental Lock Category Select screen appears.

- 5 Touch the desired category from the list.**

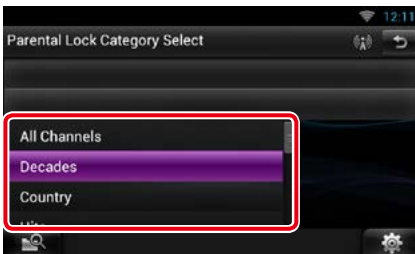

Displays all the channels in the selected category.

### NOTE

- Touch [All Channel] to display all the channels.

- 6 Touch each channel list and set on or off.**

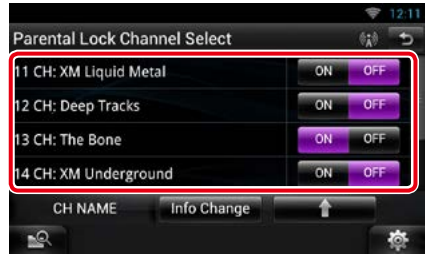

### NOTE

- Each time you touched [Info Change], switches the sequence of the channel list as follows; Channel name, Artist name, Song title, Category name, Content information.
- Touch [↑] to return to Parental Lock Category Select screen.
- Touch [←] to return to SiriusXM SETUP screen.

## Skip channel select

You can set the undesired channels to skip.

- 1 Touch [SET] of [Skip Channel Select].**  
Skip Category Select screen appears.
- 2 Touch the desired category from the list.**  
Displays all the channels in the selected category.
- 3 Touch each channel and set ON or OFF.**

### NOTE

- Operations in each list screen are same as [Parental control \(P.109\)](#).

## Content alerts setup

You can turn on or off the Content alerts function.

- 1 Touch [ON] or [OFF] of [Content alerts] in the SiriusXM SETUP screen.**  
Turns the Content alerts on or off.  
Default is "ON".

## Content alerts Content Set

You can set a content for Content alerts.

- 1 Touch [SET] of [Content alerts Contents Set] in the SiriusXM SETUP screen.**  
Artist list screen appears.

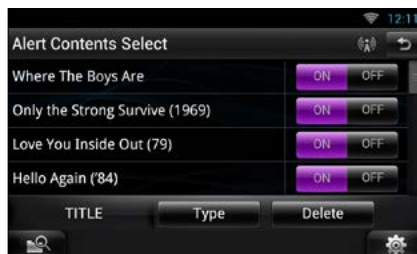

### NOTE

- To set all the content alerts off, touch and hold [Disable All] for 2 seconds.

- 2 Touch [Type] to select the screen of the content you want to set up.**  
Touching this allows you to switch among the Artist list, Song list, and Team list cyclically.
- 3 Touch each content list and set ON or OFF.**

### NOTE

- Touch "Delete" to delete the currently selected content from the Artist list and Song list.
- Available teams were pre-registered in the Team list. Team(s) cannot be registered or deleted manually.

## **City select for Traffic & Weather Jump**

You can select a city for which traffic information or weather forecast is to be received with the Content alerts function.

- 1 Touch [◀] and [▶] of [Traffic Weather Jump City Select] to select a city.**

## **TuneStart™ setup**

- 1 Touch [ON] or [OFF] of [Tune Start] in the SiriusXM SETUP screen.**  
Turns the Tune start on or off.  
Default is "ON".

## **Reset**

- 1 Touch [Reset] of [SiriusXM Reset] for 2 seconds in the SiriusXM SETUP screen.**  
All SiriusXM setting returns to default.



# Streaming Service Application

## AUPEO! Application

You can listen to music on the online radio AUPEO!.

### Preparation

- You need to connect to Internet. See [Network Setup \(P.32\)](#).

- 1 Press the <HOME> button.
- 2 Flick the screen left or right to select the Network contents panel.
- 3 Touch [  ].
- 4 Touch [  Aupeo ].
- 5 Select a genre.

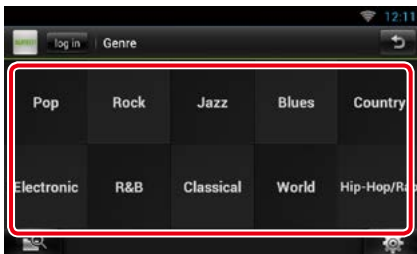

## Log in

By registering an account, you can listen to your favorite songs.

- 1 Touch [log in].
- 2 Enter the User Name and Password.

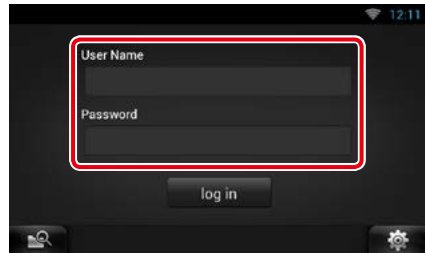

- 3 Touch [log in].

## Play screen

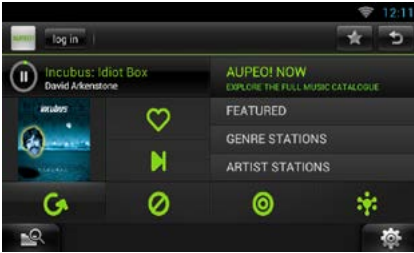

Plays or pauses.



I like this song.

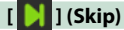

Play the next song.



I do not like this song.



Select a sub genre.

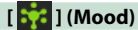

Music matching your mood.



Select a new genre.



Select a Featured Stations



Select a Genre Stations



Create a station of your type by searching stations by the artist name.

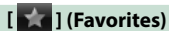

Edit the titles registered in Loves and Bans.  
You can use this button only when you have logged in to this service.

## Editing Favorites

You can edit the titles registered in Loves and Bans.

### Preparation

- You can only use this function when you have logged in this service.

### 1 Touch [★].



Switches between Love and Ban.



Deletes this title.



Registers this artist as Ban.

## AV Browser Application

This app is the dedicated web browser to playback streaming video and audio.

### Preparation

- You need to connect to Internet. See [Network Setup \(P.32\)](#).

- 1 Press the **<HOME>** button.
- 2 Click the screen left or right to select the **Network contents panel**.
- 3 Touch [  ].
- 4 Touch [  AV Browser ].

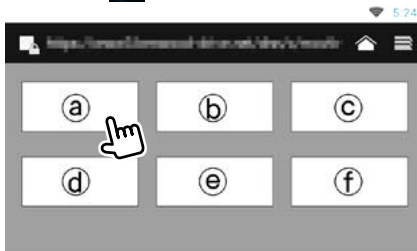

Icons linked with web sites are displayed.



The portal site which shows recommended streaming services is displayed.



The list of tabs is displayed.

## Play video and audio

- 1 Select the content you want to play.

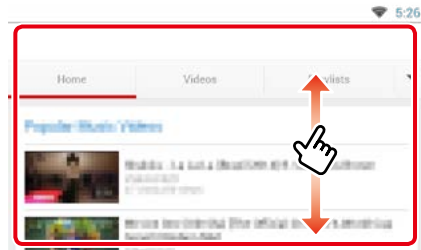

- 2 Play the content.

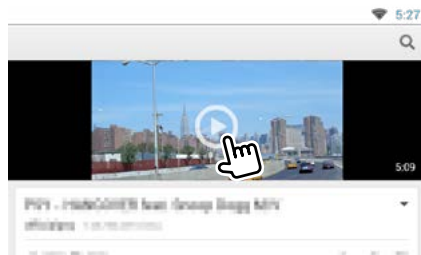

- 3 Press the **<↔>** button to previous screen.

### Note

- The instruction above is an example of operation. Actual operation is depended on the streaming service.





## Bluetooth Control

Using the Bluetooth function, various functions can be used: listening to the audio file, making/receiving a call.

### About the Smartphone/cell-phone and Bluetooth audio player

This unit conforms to the following Bluetooth specifications:

#### Version

Bluetooth Ver. 3.0+EDR Certified

#### Profile

Smartphone/cell-phone:

HFP (V1.6) (Hands Free Profile)

SPP (Serial Port Profile)

PBAP (Phonebook Access Profile)

GAP (Generic Access Profile)

HID (Human Interface Device Profile)

Audio player:

A2DP (Advanced Audio Distribution Profile)

AVRCP (Audio/Video Remote Control Profile)

#### Sound codec

aptX, MP3, AAC, SBC

#### NOTE

- For the smartphones/cell-phones verified for compatibility, access the following URL:  
<http://www.kenwood.com/cs/ce/bt/>.
- The units supporting the Bluetooth function have been certified for conformity with the Bluetooth Standard following the procedure prescribed by Bluetooth SIG.  
However, it may be impossible for such units to communicate with your smartphone/cell-phone depending on its type.



## Registering and Connecting Bluetooth Unit

It is necessary to register the Bluetooth audio player or smartphone/cell-phone to this unit before using the Bluetooth function.

You can register up to 5 Bluetooth units.

### 1 Press and hold the < > button.



Hands Free screen appears.

### 2 Touch [ ].



Bluetooth SETUP screen appears.

See the following section for each setting.

- **Registering from this unit** ([P.117](#))
- **Connecting the Bluetooth unit** ([P.117](#))
- **Registering from the Bluetooth unit** ([P.118](#))
- **Change the PIN code** ([P.118](#))

## Registering from this unit

### Preparation

- You cannot register the Bluetooth unit when you are using the following sources:  
iPod, Bluetooth Audio, APPS, Pandora  
If you want to register the Bluetooth unit while using one of the above mentioned sources, send the connection request from the Bluetooth unit and register it.

### 1 Touch [Search].

Searched Device List screen appears.

#### NOTE

- A new device cannot be registered if there are 5 registered Bluetooth units. Delete unnecessary registration. See [Connecting the Bluetooth unit \(P.117\)](#).
- This unit is compatible with the Apple Easy Pairing function. When an iPod touch or iPhone is connected to this unit using Dock Connector to USB Cable, an authentication dialog appears. Performing operation for authentication on this unit or iOS smartphone registers the smartphone as a Bluetooth device.
- If two Bluetooth units are connected, this unit will not start the search. In this case disconnect one of the Bluetooth units.

### 2 Select the Bluetooth unit to register from the list.



#### NOTE

- If the Bluetooth unit cannot be searched in step 1, you can search it again by touching [Search] in above screen.
- Touch [Cancel] to cancel searching for the Bluetooth unit.

### 3 Enter PIN code form the cell-phone.

## Connecting the Bluetooth unit

### 1 Touch the name of device to connect.

Profile select screen appears.

#### NOTE

- If the icon is lighted, it means that the unit will use that device.

### 2 Set each profile as follows.

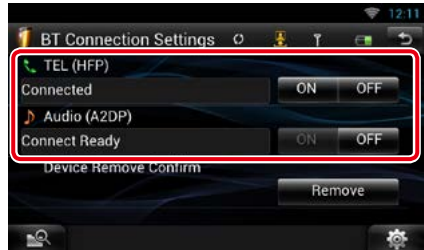

#### TEL (HFP)

Means that the Bluetooth unit is a smartphone/cell-phone.

#### Audio (A2DP)

Means that the Bluetooth unit is an audio player or smartphone/cell-phone with audio player.

#### NOTE

- If a device has been paired, the Bluetooth unit cannot be connected from the paired device.
- Touching [Remove] of [Device Remove Confirm] removes registration information. After you touch the key, a confirmation message appears. Follow the message and complete the operation.

## Registering from the Bluetooth unit

- 1 Search the unit ("DNN\*\*\*\*") from your smartphone/cell-phone.
- 2 Input the PIN code in your smartphone/cell-phone.  
PIN code is set to "0000" as the default.

### **SSP (Secure Simple Pairing of Bluetooth 2.1 or later)**

- 1 Search the unit ("DNN\*\*\*\*") from your smartphone/cell-phone.
- 2 Confirm the request both on the smartphone/cell-phone and the unit.

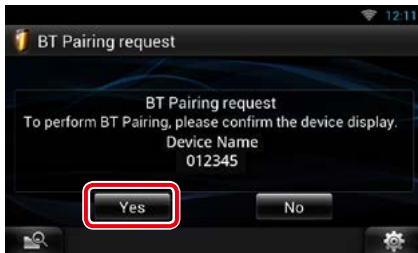

## Change the PIN code

- 1 Touch [PIN Code Set].



PIN Code Set screen appears.

- 2 Input the PIN code



- 3 Touch [Enter].

## Playing Bluetooth Audio Device

### Bluetooth basic operation

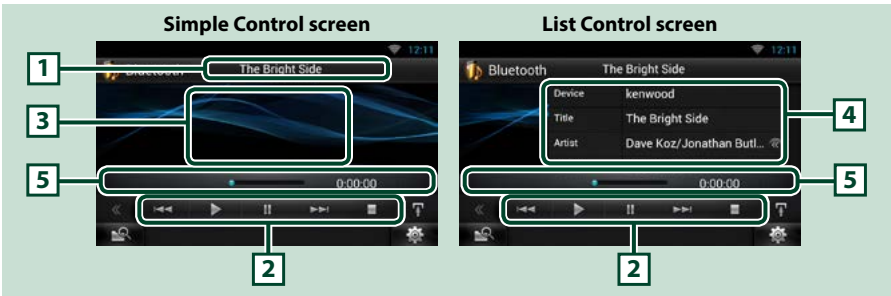

#### 1 Information display

Displays the name of the content information. If the information is not available, Bluetooth unit name is displayed.

#### 2 Multi function menu

The functions of each key are as follows.

- [**◀◀**] [**▶▶**]: Searches the previous/next content.\*
- [**▶**]: Plays.\*
- [**⏸**]: Pauses.\*
- [**■**]: Stops playback.\*

#### 3 Control switching area

Touch to switch between the Simple Control and List Control screen.

#### 4 Content information

Displays the information of the current content.

#### 5 Status bar

Displays the current play location, play time, and play mode.

**\*These items appear only when the audio player which supports AVRCP profile is connected.**

#### NOTE

- If the operation keys do not appear, operate from the player.
- Depending on your smartphone/cell-phone or audio player, audio may be heard and controlled but text information may not appear.
- If the volume is too low, raise it on your smartphone/cell-phone or audio player.

## Using Hands-Free Feature

You can make or answer a call with Hand-Free by connecting a smartphone/cell-phone with built-in Bluetooth connected to this unit.

### Making a call

#### 1 Press and hold the <math>\leftarrow \rightarrow</math> button.

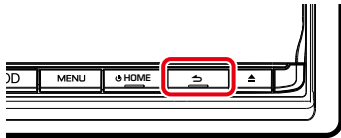

Hands Free screen appears.

#### NOTE

- If your cell-phone supports auto-download of phonebook but not downloaded automatically, follow the procedure above to download manually.
- See the instruction manual of your cell-phone for the operation.
- Up to 600 phone numbers can be registered for each registered cell-phone.
- Up to 30 digits can be registered for each phone number along with up to 50 characters representing a name. (50 is the number of alphabetical characters. Fewer characters can be input depending on the type of characters.)
- Depending on the type of your cell-phone, the following restrictions are placed;
  - The phonebook data cannot be downloaded normally.
  - Characters in the phonebook are garbled.
- To cancel downloading the phonebook data, operate the cell-phone.

#### 2 Select a dialing method.





See the following table for each method.

#### Select the cell-phone to use





When you connect two cell-phones

- ① Touch [  ] to select the phone you want to use.



#### Call by entering a phone number

- ① Touch [  ].
- ② Enter a phone number with number keys.
- ③ Touch [  ].

#### Call using call records

- ① Touch [  ] (Incoming Calls), [  ] (Outgoing Calls), or [  ] (Missed Calls).
- ② Select the phone number from the list.
- ③ Touch [  ].

#### Call using the phonebook

- ① Touch [  ].
- ② Select the name from the list.\*1\*2
- ③ Select the number from the list.
- ④ Touch [  ].

#### Call using the preset number

- ① Touch [Preset #] to start calling the corresponding phone number.

#### Voice Recognition

You can access the voice recognition function of the smartphone/cell-phone connected to this unit.

You can search a phone number in the smartphone/cell-phone phonebook by pronouncing a name. (The functionality depends on the cell-phone.)

- ① Touch [  ] to Voice Recognition screen appears.
- ② Pronounce a name.

\*1 You can sort the list to begin with touched character.

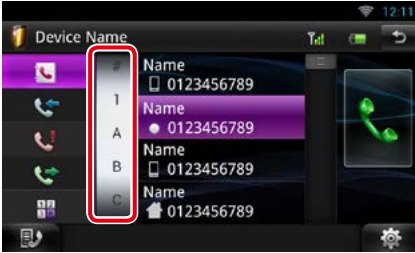

- Characters with no corresponding name will not appear.
- During search, a non-accent character such as “u” is searched for instead of an accent character such as “ü”.

\*2 You can set the list to arrange in the order of last name or first name. For details, see [Hands-Free Setup \(P.124\)](#).

#### NOTE

- If you edited the phonebook in your cell-phone, touch “Download” on top of the phonebook list in this unit to download it from your cell-phone. The phonebook in this unit will be updated with the latest downloaded data.
- The status icons such as battery and antenna displayed may differ from those displayed on the cell-phone.
- Setting the cell-phone in the private mode can disable the hands-free function.

## Voice Recognition

You can access the voice recognition function of the smartphone/cell-phone connected to this unit.

You can search a phone number in the smartphone/cell-phone phonebook by pronouncing a name. (The functionality depends on the cell-phone.)

### 1 Press the <MENU> button.

#### NOTE

- This function is not displayed in the menu when you are operating an application. Press the <HOME> button to use this function.

### 2 Touch [Voice].

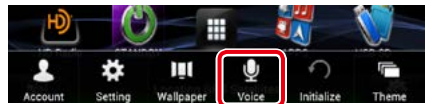

Voice Recognition screen appears.

### 3 Pronounce a name.

## Phone number preset

You can register frequently used phone numbers to this unit.

### 1 Enter the number you want to register in Hands Free screen.



### 2 Touch [Preset 1], [Preset 2], or [Preset 3] for 2 seconds in the Hands Free screen.

## Answering a call

- 1 Touch [  ] to answer a call or [  ] to reject a call.

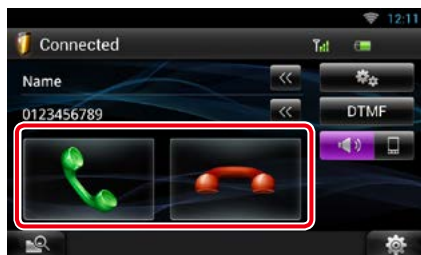

### NOTE

- While monitoring the camera view, this screen does not appear even if a call comes in. To display this screen, press the <TEL> button or return the shift knob of car to the driver position.

## Operation during a call

### Adjust the receiver volume

Press the <▼> or <▲> button.

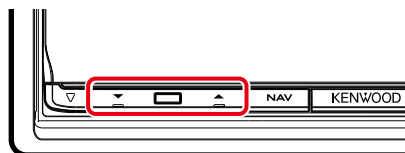

### Switch the voice output

Touch [  ] / [  ] to switch the voice output between phone and speaker.

### Sending DTMF tone signal

Touch [DTMF] to display the tone input screen. You can send tones by touching desired keys on the screen.

## Call waiting

You can answer a second call while talking with the first caller by placing the first call on hold and switching to the second call. You can switch back and forth between first and second caller as well.

### To answer the second call

Touch [  ]. The first call is placed on hold and answers the second waiting call.

### To switch back and forth between the first and second caller

Touch [  ] again.

Each time you touch [  ], the caller is switched.



### To terminate the first call

Touch [  ].

The caller switches to the second caller.

## Phone Number Search

You can search the address book in your cell phone for the number or the name, and make a call.

- 1 Touch [  ].
- 2 Select whether you search by Phonebook name  or Phone number  .
- 3 Enter the Phonebook name or Phone number.

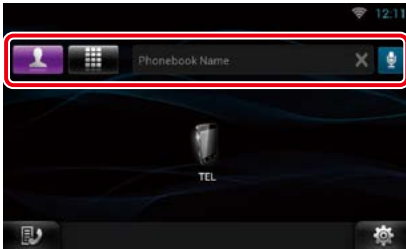

Enter the keyword using the voice recognition function. When "Speak now" is displayed, pronounce the keyword.

\* You can use a user account when you have logged in the Owner or User.

- 4 Touch [TEL].

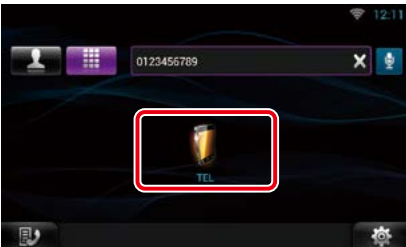

### When searched by Phonebook name

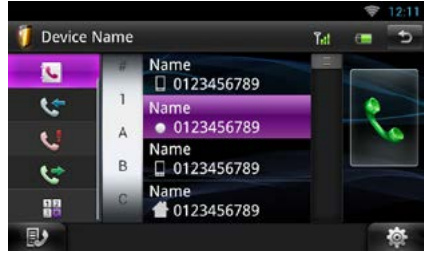

- 5 Touch [  ].

### When searched by Phonebook number

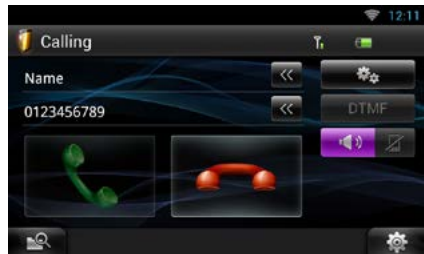

The unit make a call.



## Hands-Free Setup

You can perform various setup about hands-free function.

**1 Touch [  ] on any screen.**

**2 Touch [SETUP].**

SETUP Menu screen appears.

**3 Touch [Bluetooth].**



Bluetooth SETUP screen appears.

**4 Touch [TEL SETUP].**



Hands-free SETUP screen appears.

**5 Set each item as follows.**



### Auto Response\*1

Select the ringing time interval until the system automatically answers a call.

**OFF (Default):** Automatic response is not available.

**0-99:** Set ringing time interval (second).

### Auto Pairing

When set to "ON", the Apple Auto Pairing function is turned on to automatically register the iPod touch or iPhone connected to this unit.

**ON (Default):** Uses Apple Auto Pairing function.

**OFF:** Not uses Apple Auto Pairing function.

### Call Beep

Select whether or not to beep upon receiving a call.

**ON (Default):** Beeps.

**OFF:** Not beeps.

### Phone Information Use

Select whether to download phonebook for outgoing, incoming and missed calls list.

**ON (Default):** Yes.

**OFF:** No.

### **Sort Order**

Set how to arrange the cell-phone phonebook.

**First:** Arranges in the order of first name.

**Last (Default):** Arranges in the order of last name.

### **Echo Cancel Level**

Adjust the level of echo cancellation.

Default is "1".

### **Microphone Level**

Adjust the sensitivity of the telephone microphone. Default is "3".

### **Noise Reduction Level**

Reduces the noises generated by surrounding environment without changing the microphone volume. Use this setting when the voice of caller is not clear. Default is "-10".

### **[Restore]**

Resets the settings to the default settings.

**\*1 Either the time interval for automatic answer set on this unit or the time interval set on your smartphone/cell-phone, whichever is shorter takes effect.**

## Voice Control (DNN992)

The unit is equipped with Advanced Voice Recognition function which allows you to operate it with your voice. The supported languages are US English, UK English, French, German, Dutch, Italian, and Spanish. For information on the voice commands, refer to [<Voice command table> \(separate volume\)](#).

### NOTE

- ASR on the Language Setting screen should be set to "Enabled". See [Language setup \(P.130\)](#).

## Voice Control

- 1 Press the Push-To-Talk switch to enter the Voice control mode.**

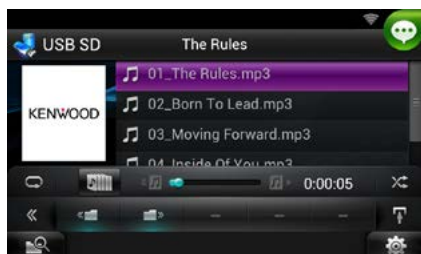

The buttons enclosed in a green square support the voice control.

- 2 Speak the command. (Ex: Speak "HD RADIO".)**

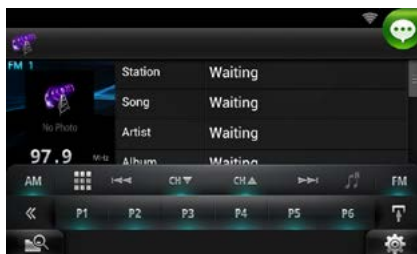

The screen has changed to the HD Radio Control screen.

You will hear a beep again.

- 3 Repeat the same procedure as step 2.**

For information on the voice commands, refer to [<Voice command table> \(separate volume\)](#).

- 4 Press the Push-To-Talk switch to end the voice control mode.**

## Displaying Voice Commands

To display the list of operable voice commands.

- 1 Press and hold the Push-To-Talk switch.**



The list of operable voice commands appears. Pronounce a command.

### NOTE

- To cancel the commands list display, press Push-To-Talk switch or touch the screen.

## Camera Control

When a CMOS-3xx (optional accessory) is connected, the camera can be controlled from this unit.

### Preparation

- [NAV Key Longer than 1 Second] must be set to "CAM". See [User interface \(P.129\)](#).

## Camera Control

You can adjust the camera angle of the camera system and display of the guideline.

### 1 Press the <NAV> button for 1 second.

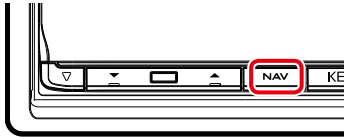

Camera view screen appears.

### 2 Adjust each item as follows.

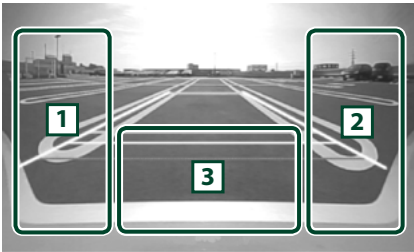

#### 1 Guideline

Pressing each time turns on or off the guideline display alternately. (Rear view camera only)

#### 2 Angle

Pressing each time changes camera angles in the following order:

Super wide view/ Wide view/ Overhead view/  
Wide view + Top view/ Corner view

#### 3

Clearing the Camera View display.

## Switching the View Camera

Switching between the front view camera and the rear view camera.

### 1 Press the <NAV> button for 1 second.

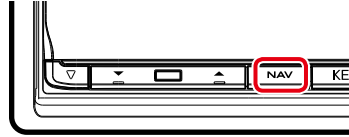

Camera view screen appears.

### 2 Touch illustrated area during Camera view screen.

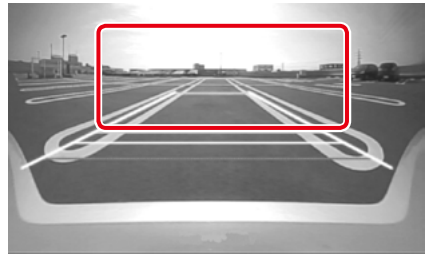

Switches between the front view camera and rear view camera each time you touch the illustrated area.

# Setting Up

## Monitor Screen Setup

You can adjust image quality of playback screen, background screen, etc.

- 1 **Touch and hold the lower left area of any screen.**

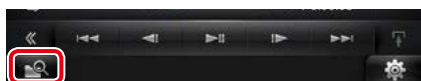

Screen Control screen appears.

- 2 **Adjust each item as follows.**



### Background screen

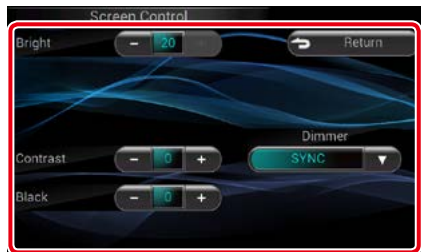

### Bright / Tint / Color / Contrast / Black / Sharpness

Adjusts each item.

### Dimmer

Select dimmer mode.

**ON:** The display and buttons dim.

**OFF:** The display and buttons do not dim.

**SYNC (Default):** Turns the dimmer function on or off when the vehicle light control switch is turned on or off.

**NAV-SYNC:** Turns the dimmer function on or off according to the Navigation Day/Night display setting.

### Mode (Playback screen only)

Select screen mode.

**Full:** Full picture mode

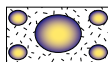

**Just:** Justify picture mode

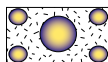

**Zoom:** Zoom picture mode

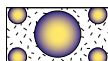

**Normal:** Normal picture mode

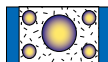

### NOTE

- Adjusting items are different depending on the current source.
- You can perform this function only when you have applied the parking brake.
- The image quality can be set for each source.

## System Setup

### NOTE

- Each operation in this section can be started from the multi function menu.

- 1 Touch [  ] on any screen.  
Quick Menu screen appears.
- 2 Touch [SETUP].
- 3 Touch [System].

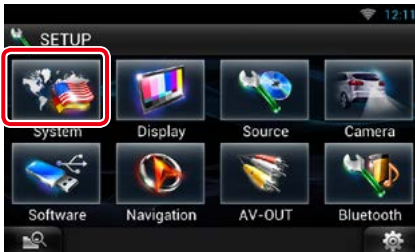

System screen appears.

See the following section for each setting.

- Set up the user interface [\(P.129\)](#)
- Set up security [\(P.130\)](#)
- Set up external switch [\(P.131\)](#)
- Set up memory [\(P.131\)](#)

### User interface

You can setup user interface parameters.

- 1 Touch [User Interface] in the list.  
User Interface screen appears.
- 2 Set each item as follows.



### Beep

Turns the key touch tone on or off.  
Default is "ON".

### Language

Select the language used for the control screen and setting items. See [Language setup \(P.130\)](#).

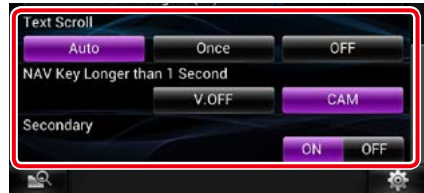

### Text Scroll

Allows scrolling of text display on the source control screen. Select from "Auto"/"Once"/"OFF".

**Auto (Default):** Scrolls the text automatically.

**Once:** Allows you to scroll the text only once automatically when updated.

**OFF:** Does not scroll the text automatically.

### NAV Key Longer than 1 Second

You can set the operation performed when the NAV key is pressed for 1 second. Select from "V.OFF"/"CAM".

**V.OFF:** Turn the display off.

**CAM (Default):** Switches to the front or rear view camera video display.\*

### Secondary

Set whether to display the navigation information in the audio screen or vice versa.  
Default is "ON".

### DEMO

Set the demonstration mode. Default is "ON".

- \* When you set [Front Camera] to OFF, the display will change to the rear view camera and when you set it to "CMOS-3xx"/"Other", the display will change to the front view camera. See [Camera Setup \(P.134\)](#)

## Language setup

### 1 Touch [SET] of [Language] in the User Interface screen.

Language Setting screen appears.

### 2 Set each item as follows.



#### GUI Language Select

Select the language used for the GUI and input methods.

#### ASR (DNN992)

Select the language used for voice control function.

#### Navigation Language Select

Select the language used for navigation.

#### STT

Select the language used for Speech to Text (STT).

#### TTS

Select the language used for Text to Speech (TTS).

### 3 Touch [Enter].

#### NOTE

- To cancel the language setup, touch [Cancel].

## Security setup

A red indicator will blink on the unit after the ACC is set to OFF, warning potential thieves.

If turned to "ON" (default), the security indicator on the front panel flashes when the vehicle ignition is off.

### 1 Touch [Security] in the System Menu screen.

Security screen appears.

### 2 Touch [ON] or [OFF] of [SI].

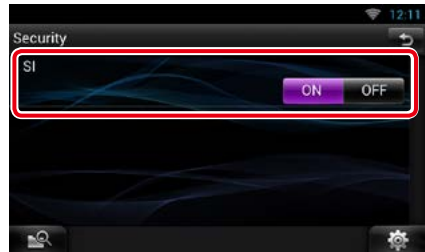

## EXT SW setup

Set up the external switch power mode.

### 1 Touch [EXT SW] in the System Menu screen.

EXT SW screen appears.

### 2 Set each item as follows.

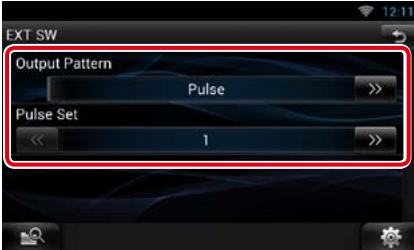

#### Output Pattern

Set the power signal output mode among "Pulse"/"Level". Default is "Pulse".

You can set to turn output on/off each time the button on the EXT SW screen is touched. See [External Device Control \(P.138\)](#).

#### Pulse Set

Set the pulse signal output time.

Outputs 500ms when "1" is set.

Increases by 200ms with each step. Up to 100 steps can be set.

#### NOTE

- You can enter characters only after you have applied the parking brake.
- "Pulse": Generates a single power signal pulse.

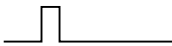

- "Level": Continues output of high power signal.

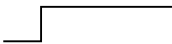

## Setup memory

Audio Control, AV-IN SETUP, Camera, and Audio SETUP settings can be memorized. The memorized settings can be recalled at any time. For example, even when the settings are cleared due to replacement of the battery, the settings can be restored.

### 1 Touch [SETUP Memory] in the System Menu screen.

SETUP Memory screen appears.

### 2 Follow the instruction on the screen.



#### [Lock] / [Unlock]\*

Locks or unlocks the AV-IN SETUP, and Audio SETUP settings.

#### Yes

Memorizes or recalls the settings.

#### No

Cancels the function or memorization. The SETUP Menu screen appears again.

**\* When [Lock] is selected, you cannot change the AV-IN SETUP, and Audio SETUP settings. Also, the locked key mark is displayed under each setting icon in the setup menu.**

**Continued**



### 3 Follow the instruction on the screen.

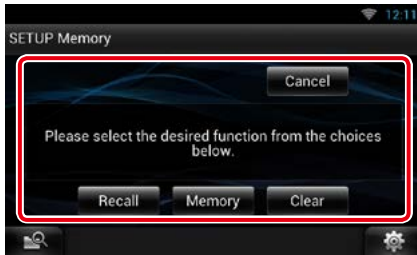

#### Recall

Recalls the memorized settings.

#### Memory

Memorizes the current settings.

#### Clear

Clears the currently memorized settings.

#### Cancel

Cancels memorization/recalling of settings.

## Display Setup

1 Touch [  ] on any screen.

2 Touch [SETUP].  
SETUP Menu screen appears.

3 Touch [Display].



Display screen appears.

See the following section for each setting.

- **Control monitor angle** ([P.132](#))
- **Adjust panel color** ([P.133](#))

### Monitor angle control

You can adjust the angle of the monitor.

1 Touch [Angle] in the Display Menu screen.

Angle setup screen appears.

2 Select a number below an angle that will best suit your monitor viewing.



Default is "0".

#### NOTE

- You can store the current monitor angle as the angle during power off. Touch [Memory] when the desired angle is selected.

## Panel color coordinate

You can set the button illumination color.  
The selectable items differ depending on the unit.

- 1 Touch [Color] in the Display Menu screen.**  
Color screen appears.
- 2 Touch [OFF] of [Panel Color Scan].**
- 3 Touch [SET] of [Panel Color Coordinate].**

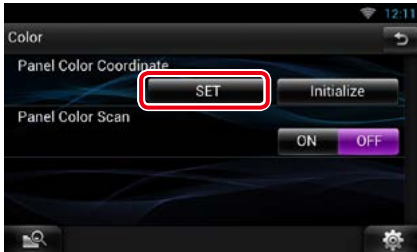

Panel Color Coordinate screen appears.

### NOTE

- You can touch [SET] or [Initialize] when [Panel Color Scan] is set to off.
- Touch [Initialize] to reset the settings to the default settings.

- 4 Touch the desired color.**



## Registering original color

You can register your original color.

- 1 Touch [Adjust] in the Panel Color Coordinate screen.**  
Panel Color RGB Coordinate screen appears.
- 2 Use [◀] and [▶] to adjust each color value.**



- 3 Touch the desired preset key for 2 seconds.**

## Panel color scan

You can set the panel color to continuously scan through the color spectrum.

- 1 Touch [ON] of [Panel Color Scan] in the Color screen.**

Panel Color Scan is set to on.

## Navigation Setup

You can set navigation parameters.

- 1 Touch [  ] on any screen.
- 2 Touch [SETUP].  
SETUP Menu screen appears.
- 3 Touch [Navigation].



Navigation SETUP screen appears.

- 4 Set each item as follows.

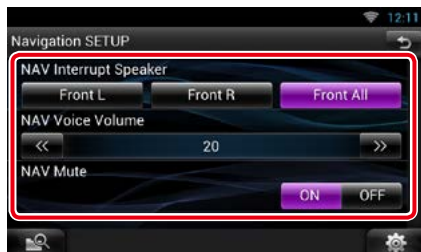

### NAV Interrupt Speaker

Select speaker(s) used for voice guidance of the navigation system.

**Front L:** Uses the front left side speaker for voice guidance.

**Front R:** Uses the front right side speaker for voice guidance.

**Front All (Default):** Uses both front speakers for voice guidance.

### NAV Voice Volume

Adjust the volume for voice guidance of the navigation system. Default is "20".

### NAV Mute

Mutes the volume of rear speakers during voice guidance of the navigation system. Default is "ON".

## Camera Setup

You can set camera parameters.

- 1 Touch [  ] on any screen.
- 2 Touch [SETUP].  
SETUP Menu screen appears.
- 3 Touch [Camera].



Camera SETUP screen appears.

- 4 Set each item as follows.



### Rear Camera\*1

Select the type of rear camera to use.

**CMOS-310:** When the CMOS-3xx series with ID 1 set is connected.

**Other (Default):** When the other camera is connected.

### R-CAM Interruption

Set a method for switching the display. Setting values are ON and OFF.

**ON:** Switches to the rear view camera video display when shifting to reverse or pressing the <NAV>\*5 button for 1 second.

**OFF (Default):** Switches to the rear view camera video display when pressing the <NAV>\*5 button for 1 second.

### R-CAM Settings\*2

Adjust the CMOS-3xx series with ID 1 set. For details, see the instruction manual of your camera.

### Parking Guidelines\*3

You can display parking guidelines to enable easier parking when you shift the gear to the reverse (R) position. Default is "ON".

### Guidelines Setup\*3

Adjust the parking guidelines. See [Adjusting the parking guidelines \(P.135\)](#).

### Front Camera

Select the type of front camera to use.

**CMOS-310:** When the CMOS-3xx series with ID 2 set is connected.

**Other:** When the other camera is connected.

**OFF (Default):** When the front camera is not used.

### F-CAM Settings\*4

Adjust the CMOS-3xx series with ID 2 set. For details, see the instruction manual of your camera.

\*1 These settings become settable only when the parking brake is on.

\*2 This setting becomes settable only when the parking brake is on and "Rear Camera" is set to [CMOS-310].

\*3 This setting becomes settable only when the "Rear Camera" is set to [Other].

\*4 This setting becomes settable only when the parking brake is on and "Front Camera" is set to [CMOS-310].

\*5 [NAV Key Longer than 1 Second] must be set to "CAM". See [User interface \(P.129\)](#).

## Adjusting the parking guidelines

- 1 Touch [ON] of [Parking Guidelines] in the Camera SETUP screen.
- 2 Touch [Adjust] of [Guidelines Setup] in the Camera SETUP screen.
- 3 Adjust the parking guidelines by selecting the  mark.



- 4 Adjusting the position of the selected  mark.

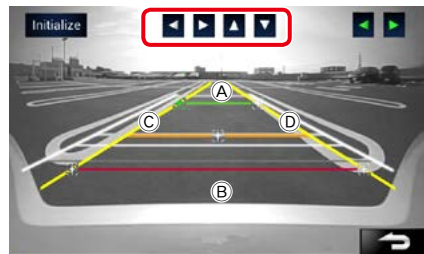

Make sure that (A) and (B) are horizontally parallel, and that (C) and (D) are the same length.

- Touch and hold [Initialize] to set all the  marks to the initial default position. •

## Software Information

Check the software version of this unit.

- 1 Touch [  ] on any screen.
- 2 Touch [SETUP].  
SETUP Menu screen appears.
- 3 Touch [Software].



Software Information screen appears.

- 4 Confirm the software version. Touch [Update] as necessary.

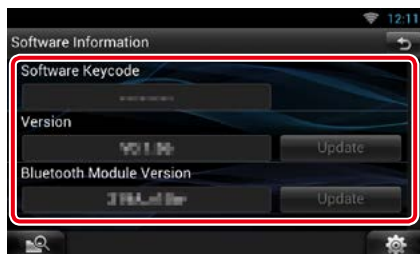

### NOTE

- For how to update the software, see the relevant update procedure manual which comes with the software.

### Notify the update

When the program is updated you will be notified by the  icon on the status bar.

### Preparation

- You need to connect to Internet.

### Minor update

If it is the minor update you can update the program via the Internet.

- 1 Drag the status bar downward.

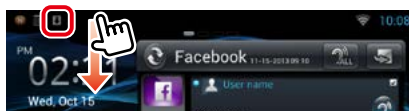

- 2 Touch [Download] to start download.

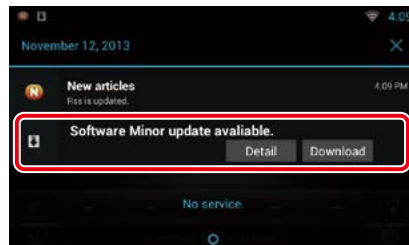

Touch [Detail] to display details.

- 3 Touch [Update].

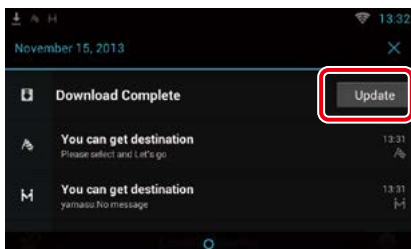

- 4 Touch [Update] to update starts.

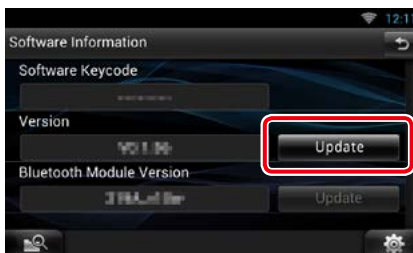

When the update is complete "Update completed" appears.

## AV Input Setup

You can set AV input parameters.

- 1 Touch [  ] on any screen.
- 2 Touch [SETUP].  
SETUP Menu screen appears.
- 3 Touch [Source].



- 4 Touch [AV-IN SETUP] in the list.  
AV-IN SETUP screen appears.
- 5 Set each item as follows.



### AV-IN1 Name / AV-IN2 Name

Set a name to be displayed when you select a system that is connected via the AV INPUT port. Default is "VIDEO".

## AV Output Interface Setup

You can select an AV source to be output at the AV OUTPUT port. Default is "VIDEO1".

- 1 Touch [  ] on any screen.
- 2 Touch [SETUP].  
SETUP Menu screen appears.
- 3 Touch [AV-OUT].



AV-OUT Interface screen appears.

- 4 Touch [◀] or [▶] to set [AV-OUT] to VIDEO, DISC, iPod, or OFF.

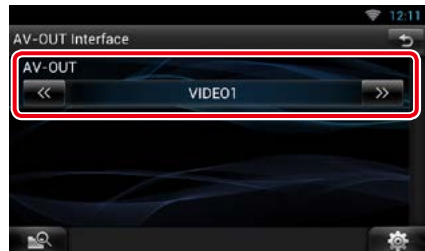

### NOTE

- You can select "iPod" only when iPod is connected to this unit with KCA-iP202. For the connection setting, refer to [iPod/iPhone connection setup \(P.83\)](#).

## External Device Control

Control the external device power supply.

**1** Touch [  ] on any screen.

**2** Touch [EXT SW].

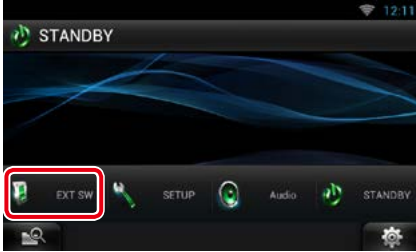

You can turn on or off the external device power supply.

### NOTE

- You must connect a commercially available relay unit in order to use this function. Connect the external device to be controlled to that relay unit.
- See [EXT SW setup \(P.131\)](#) for information on setting the power on or off specification.





# Controlling Audio

## NOTE

- Each operation in this section can be started from the multi function menu.

You can adjust the various settings such as audio balance or subwoofer level.

**1 Touch [  ] on any screen.**

**2 Touch [Audio].**

Audio screen appears.

See the following section for each setting.

- **Setting audio** ([P.140](#))
- **Controlling audio** ([P.143](#))
- **Controlling equalizer** ([P.144](#))
- **Controlling sound effect** ([P.146](#))
- **Performing zone control** ([P.145](#))
- **Set listening position** ([P.148](#))

## Setting Audio

**1 Touch [  ] on any screen.**

**2 Touch [Audio].**

Audio screen appears.

**3 Touch [Audio SETUP].**

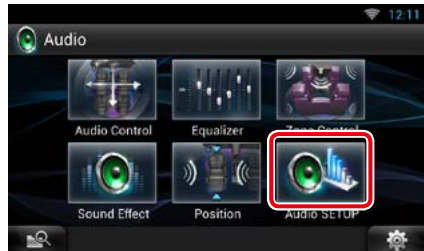

Audio SETUP screen appears.



See the following section for each setting.

- **Set up speakers** ([P.141](#))
- **Set up your car type** ([P.142](#))
- **Select DSP** ([P.143](#))

## Speaker setup

You can select a speaker type and its size to get the best sound effects.

When the speaker type and size are set, the speaker crossover network is set automatically.

### 1 Touch [Speaker Select] in the Audio SETUP screen.

Speaker Select screen appears.



### 2 Touch the speaker you wish to adjust and set each item as follows.



### Tweeter

You can set the tweeter when you are selecting front speakers.

None, Small, Middle, Large

### X'over

Displays the speaker crossover setup screen.

You can adjust the crossover setup that was set automatically when you selected the speaker type.

For details, see [Crossover network setup \(P.142\)](#)

### 3 Select a speaker size using [◀] and [▶]. The speaker size is different depending on the speaker type and the unit.

#### Front

OEM, 3-1/2 inch, 4 inch, 4-3/4 inch, 5 inch, 6-1/2 inch, 6-3/4 inch, 7 inch, 4x6, 5x7, 6x8, 6x9, 7x10

#### Rear

None, OEM, 3-1/2 inch, 4 inch, 4-3/4 inch, 5 inch, 6-1/2 inch, 6-3/4 inch, 7 inch, 4x6, 5x7, 6x8, 6x9, 7x10

#### Subwoofer

None, 6 1/2 inch, 8 inch, 10 inch, 12 inch, 15 inch over

#### NOTE

- Select "None" if you have no speakers.

### Crossover network setup

You can set a crossover frequency of speakers.

- 1 **Touch the speaker to set the crossover in the Speaker Select screen.**
- 2 **Touch [X'over].**  
X'over screen appears.
- 3 **Set each item as follows.**



#### TW (Tweeter) Gain \*1

Adjust the tweeter level. (When front is selected on Speaker Select screen)

#### Gain

Adjust the front speaker, rear speaker, or subwoofer level.

#### Phase \*2

Set the phase of subwoofer output.

The phase is reversed 180 degrees when set to "Reverse". (When subwoofer is selected on Speaker Select screen)

#### HPF FREQ

High Pass Filter adjustment. (When front or rear speaker is selected on Speaker Select screen)

#### LPF FREQ

Low Pass Filter adjustment. (When subwoofer is selected on Speaker Select screen)

#### Slope \*3

Set a crossover slope.

- \*1 Only when "Tweeter" is set to "Small", "Middle", "Large" in <Speaker Setup>.
- \*2 Only when "Subwoofer" is set to a mode other than "None"/"OFF" in <Speaker Setup>.
- \*3 Only when "LPF FREQ"/"HPF FREQ" is set to a mode other than "Through" in <X'over>.

### Car type setup

You can setup the car type and speaker network, etc.

- 1 **Touch [Car Type] in the Audio SETUP screen.**  
Car Type screen appears.
- 2 **Select your car type from the list.**

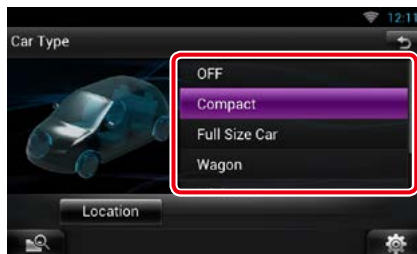

#### NOTE

- If your car type is selected, the Delay Time Alignment is set automatically (for timing adjustment of sound output for each channel) to have the highest surround effects.

### Speaker location setup

- 1 **In the Car Type screen, touch [Location].**  
Speaker Location screen appears.
- 2 **Select the speaker locations using [▶].**



#### Front Speaker

Select the location from "Door"/"On Dash"/"Under Dash".

#### Rear Speaker

Select the location from "Door"/"Rear Deck", "2nd Row"/"3rd Row" (Minivan, Minivan (Long)).

## DSP select

You can select whether using DSP (Digital Signal Processor) System.

### 1 Touch [Bypass] or [Through] of [DSP Select] in the Audio SETUP screen.

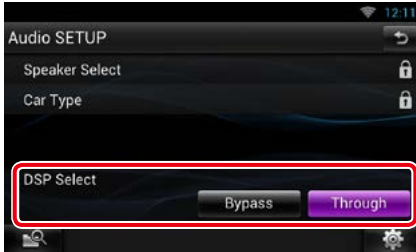

#### Bypass

There is no effect by DSP.

#### Through

There is an effect by DSP.

#### NOTE

- When the mode is set to [Bypass], DSP System cannot be adjusted.

## Controlling General Audio

### 1 Touch [ ] on any screen.

### 2 Touch [Audio].

Audio screen appears.

### 3 Touch [Audio Control].



### 4 Set each item as follows.

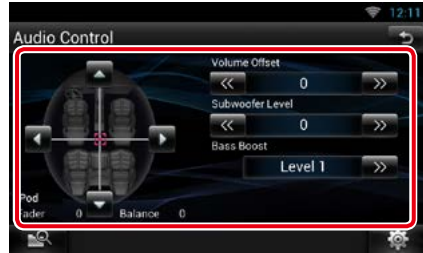

#### Fader # / Balance #

Adjust the volume balance around the touched area.

[◀] and [▶] adjust the right and left volume balance.

[▲] and [▼] adjust the front and rear volume balance.

#### Volume Offset\*

Finely adjust the volume of the current source to minimize the difference in volume between different sources.

#### Subwoofer Level

Adjust the subwoofer volume. This setting is not available when subwoofer is set to "None". See [Speaker setup \(P.141\)](#).

#### Bass Boost

Set the amount of bass boost among "OFF"/"Level1"/"Level2"/"Level3".

\* If you have increased the volume first, then reduced the volume using the "Volume Offset", the sound generated if you suddenly switch to another source may be extremely loud.

## Equalizer Control

You can adjust equalizer by selecting the optimized setting for each category.

- 1 Touch [  ] on any screen.
- 2 Touch [Audio].  
Audio screen appears.
- 3 Touch [Equalizer].

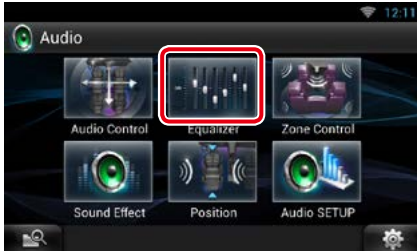

Equalizer screen appears.

### Controlling EQ curves

- 1 Select EQ curve from [Natural], [Rock], [Pops], [Easy], [Top40], [Jazz], [Powerful], [iPod], and [User].



#### NOTE

- [iPod] is available only during iPod source.

### Controlling equalizer manually

The Graphic Equalizer cannot be set when you select [iPod] in the Equalizer screen.

- 1 Touch [EQ] in the Equalizer screen.
- 2 Touch the screen and set the Graphic Equalizer as desired.



#### Gain level (light green boxed area)

Adjust the gain level by touching the each frequency bar.

Touching [◀], [▶], [▲] and [▼] can also adjust the level. Use [◀] and [▶] to select a frequency, and [▲] and [▼] to set the level.

#### EQ INIT

Returns to the previous level which the gain level is adjusted.

#### Flat

Tone curve becomes flat.

#### Bass EXT (Bass Extend Settings)

When turned on, the frequency lower than 62.5 Hz is set to the same gain level as 62.5 Hz.

#### Loudness

Set the amounts of boost of low and high tones. "OFF", "Low", "High"

#### SW Level

Adjust the subwoofer volume. This setting is not available when subwoofer is set to "None". See [Speaker setup \(P.141\)](#).

## Zone Control

You can select different sources for both front and rear positions in the vehicle.

**1 Touch [  ] on any screen.**

**2 Touch [Audio].**

Audio screen appears.

**3 Touch [Zone Control].**

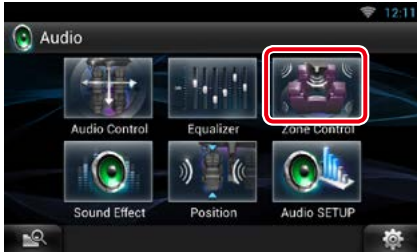

Zone Control screen appears.

**4 Touch [Dual Zone].**



**5 Set each source as follows.**



**[▶] (Front Source, Rear Source)**

Select the audio source for each.

**[▼], [▲] (Rear VOL.)**

Adjust the rear channel volume.

**[Single Zone]**

Touch to turn off the dual zone function.

### NOTE

- When the rear speaker sound is switched, the audio source that is output at the AV OUTPUT terminal is also switched to the same source.
- When the dual zone function is set to on, the following functions are not available.
  - Output from the subwoofer
  - Subwoofer Level/Bass Boost ([P.143](#))
  - Equalizer Control/Sound Effect/Listening Position ([P.144, 146, 148](#))
  - DSP Bypass Control/Speaker Setup/Car Type Setup ([P.143, 141, 142](#))

## Sound Effect

You can set sound effects.

- 1 Touch [  ] on any screen.
- 2 Touch [Audio].  
Audio screen appears.
- 3 Touch [Sound Effect].



Sound Effect screen appears.



See the following section for each setting.

- Set Space Enhancer [\(P.146\)](#)
- Set Drive Equalizer + [\(P.147\)](#)
- Set up Raise the Sound Position [\(P.147\)](#)
- Set up Realizer or Supreme [\(P.147\)](#)

## Space Enhancer

- 1 Touch [Space Enhancer] in the Sound Effect screen.



Space Enhancer screen appears.

- 2 Touch [Small], [Large], or [OFF].  
Each setting value indicates the soundscape level.

### NOTE

- This setting is not available during HD Radio tuner source.

## Drive Equalizer +

The sound quality is automatically optimized to meet the current car speed by GPS.

### 1 Touch [ON] or [OFF] of [Drive EQ+].



## Raise the Sound Position

You can raise the sound position heard from the speakers virtually.

### 1 Touch [Raise the Sound Position] in the Sound Effect screen.

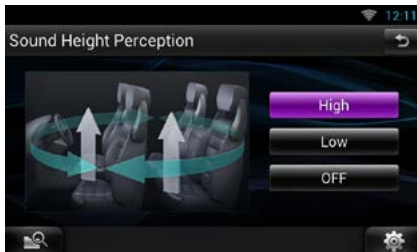

### 2 Select Elevation level from [High], [Low], and [OFF].

## Realizer and Supreme

You can restore the sound lost due to audio compression to a realistic sound.

### 1 Touch the screen in the Sound Effect screen.

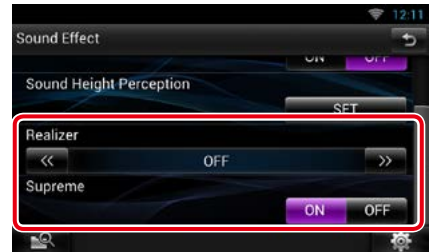

#### Realizer

Realizer is sound enhancement and boosting low frequencies (bass boost).

Select the level from "OFF"/"Level1"/"Level2"/"Level3".

#### Supreme

Turns ON/OFF the Supreme function.

Technology to extrapolate and supplement with proprietary algorithm, the high-frequency range that is cut off when encoding.

This function works on DVD MEDIA, USB, SD and iPod sources.



## Listening Position

You can adjust the sound effects according to your listening position.

**1** Touch [  ] on any screen.

**2** Touch [Audio].

Audio screen appears.

**3** Touch [Position].



Position screen appears.

**4** Select listening position from [Front R] (Right front), [Front L] (Left front), [Front All] (All front), and [All] using [◀] and [▶].

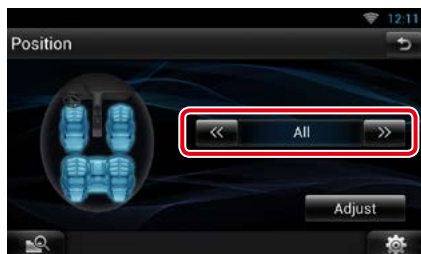

## Position DTA Control

You can fine-adjust your listening position.

**1** In Position screen, touch [Adjust].

**2** Select the speaker you wish to adjust by touching speaker icon.

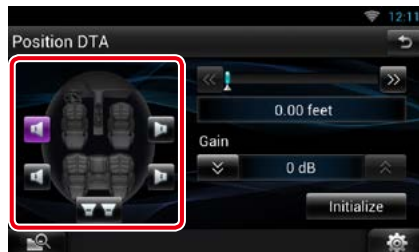

**3** Set DTA as follows.



[◀], [▶]

Adjust the settings of the DTA position.

**Gain**

Touch to adjust the gain of each speaker.

**Initialize**

Initializes the setting values.

**NOTE**

- Make fine adjustment of the delay time of the speaker output specified here to have a more suitable environment for your vehicle.
- If you specify the distance from the center of the currently set listening position to every speaker, the delay time will be automatically computed and set.
  - ① Determine the center of the currently set listening position as the reference point.
  - ② Measure the distances from the reference point to the speakers.
  - ③ Calculate the differences between the distance of the furthest speaker and other speakers.
  - ④ Input the differences calculated in step 3 for individual speakers.
  - ⑤ Adjust gain for individual speakers. A sound image will be shifted to the speaker with increased gain.

Example: When [Front All] is selected as the listening position

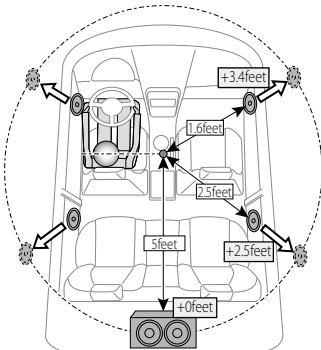

## Remote Control

This unit can be operated using the remote control.

### ▲ CAUTION

- Put the remote control in a place where it will not move during braking or other operations. A dangerous situation could result, if the remote control falls down and gets wedged under the pedals while driving.
- Do not leave the battery near fire or under direct sunlight. A fire, explosion or excessive heat generation may result.
- Do not recharge, short, break up or heat the battery or place it in an open fire. Such actions may cause the battery to leak fluid. If spilled fluid comes in contact with your eyes or on clothing, immediately rinse with water and consult a physician.
- Place the battery out of reach of children. In the unlikely event that a child swallows the battery, immediately consult a physician.

## Battery Installation

If the remote control operates only over shorter distances or does not operate at all, it is possible that the batteries are depleted.

In such instances, replace the both batteries with new ones.

- 1** Insert two "AAA"/"R03"-size batteries with the ⊕ and ⊖ poles aligned properly, following the illustration inside the case.

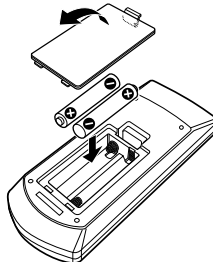

## Functions of the Remote Control Buttons

### Switching the operation mode

The functions operated from the remote control differ depending on the position of the mode switch.

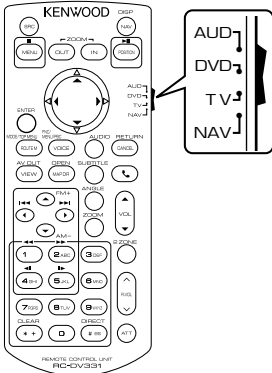

#### AUD mode

Switch to this mode when controlling a selected source or tuner source, etc.

#### DVD mode

Switch to this mode when playing a disc media including DVD, VCD, and CD.

#### NAV mode

Switch to this mode when controlling navigation function.

#### NOTE

- When controlling a player that is not integrated in the unit, select "AUD" mode.

### Direct search mode

Using the remote control, you can jump directly to the desired file, track chapter, etc. with entering the number corresponding to the content.

#### NOTE

- This operation cannot be performed for USB device and iPod.

### 1 Press the <#BS> button several times until the desired content appears.

The available contents are different depending on the source.

#### DVD

Title number/Chapter number/Play time/Item number\*

\* You may not be able to use this function with some discs or scenes.

#### VCD 1.X and 2.X (PBC OFF)

Track number

#### VCD 2.X (PBC ON)

Scene number/number

#### Music CD

Track number/Play time

#### Audio files

Folder number/File number

#### Radio

Frequency value

#### HD Radio tuner

Frequency value/Channel number

#### SiriusXM

Channel number

### 2 Enter the number of the content you want to play using the numeric keypad.

### 3 For DVD or VCD, press the <POSITION> button.



For music CD or audio files, press the <POSITION> button.

For radio, press the <<> or <>> button.

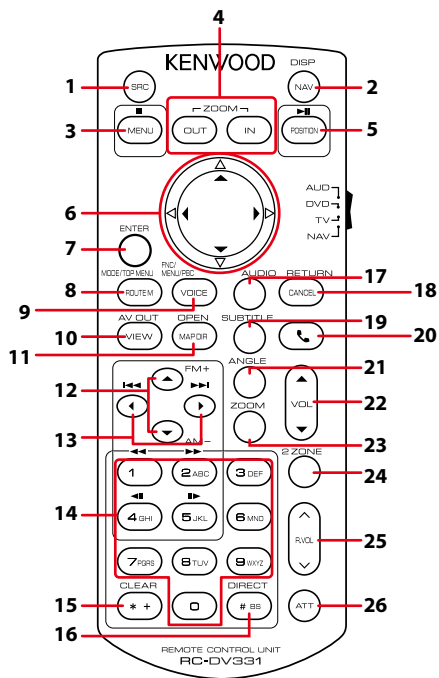
The content you entered is played.



	Key Name	Location of the mode switch	Function
1	SRC	AUD, DVD	Switches to the source to be played. In hands-free mode, hangs up the phone.
2	NAV	—	Switches between the navigation and the source screens.
3	MENU	DVD	Stops playing and memorizes the last point where the disc stopped. The last point is deleted by pressing twice.
		NAV	Displays Main menu.
4	OUT, IN	NAV	Zooms in or out the navigation map.
5	POSITION	AUD, DVD	Pauses the track or file, and resumes playing by pressing twice. During Radio, HD Radio, and SiriusXM source in AUD mode, switches the seek mode.
		NAV	Displays the current position.
6	Cursor Key	DVD	Moves the cursor in the DVD menu.
		NAV	Moves the cursor or scrolls the map.
7	ENTER	DVD	Performs the selected function.
		NAV	<ul style="list-style-type: none"> <li>Registers the selected position.</li> <li>Performs the selected function.</li> </ul>

	Key Name	Location of the mode switch	Function
8	ROUTE M	AUD	Screen mode changes each time you press this key during video playback.
		DVD	Returns to the DVD top menu.
		NAV	Displays Route Option menu.
9	VOICE	AUD	Switches navigation display on/off.
		DVD	Displays the DVD menu. Turns the playback control on or off while playing VCD.
		NAV	Speaks the voice guidance.
10	VIEW	AUD, DVD	Switches the AV source to be output.
		NAV	Switches between 2D and 3D map displays.
11	MAP DIR	AUD, DVD	Switches the display angle each time it is pressed.
		NAV	Switches between the heading up navigation and north up navigation map displays.
12	▲/▼	AUD, DVD	Selects the folder to be played. During Radio, HD Radio, and SiriusXM source in AUD mode, switches the bands to be received.
13	◀/▶	AUD, DVD	Selects the track or file to be played. During Radio, HD Radio, and SiriusXM source in AUD mode, switches to broadcast stations received by the unit.
14	Numeric Keypad	AUD	Specifies the number to search in direct search. For details on the direct search mode, see <a href="#">Direct search mode (P.151)</a> .
		DVD	<ul style="list-style-type: none"> <li>• Press [1] [2] to fast forward/backward. Switches the fast forward/backward speed each time you press this key.*</li> <li>• Press [4] [5] to slow forward/backward. Switches the slow playback speed each time you press this key.*</li> </ul> *DVD only
15	* +	DVD	Clears the number.
16	# BS	AUD, DVD	Switches to the direct search mode. For details on the direct search mode, see <a href="#">Direct search mode (P.151)</a> .
17	AUDIO	DVD	Switches the voice language each time you press this key.
18	CANCEL	DVD	Displays previous screen.
		NAV	Cancels the operations.
19	SUBTITLE	DVD	Switches the subtitle language.
20		–	When a call comes in, answers the call.
21	ANGLE	DVD	Switches the picture angle each time you press this key.
22	Vol ▲▼	–	Adjusts the volume.
23	ZOOM	DVD	Switches the zoom ratio (1, 2, 3, Off) each time you press this key.
24	2 ZONE	AUD, DVD	Switches the Dual Zone function on and off.
25	R.VOL 	–	Adjusts volume at rear when the Dual Zone function is on.
26	ATT	–	Lowers the volume by pressing the key once.
		–	Restores the previous volume by pressing the key twice.

# Troubleshooting

## Problems and Solutions

If any trouble occurs, first check the following table for possible problems.

- Some functions of this unit may be disabled by some settings made on this unit.
- What might seem to be a malfunction in your unit may just be the result of slight misoperation or miswiring.

### About settings

Problem	Reason	Solution
<ul style="list-style-type: none"> <li>• Cannot set up the subwoofer.</li> <li>• Cannot set up subwoofer phase.</li> </ul>	Subwoofer is not set to on.	Set the subwoofer to on. See <a href="#">Speaker setup (P.141)</a> .
<ul style="list-style-type: none"> <li>• No output from the subwoofer.</li> <li>• Cannot set up the low pass filter.</li> <li>• Cannot set up the high pass filter.</li> </ul>	The dual zone function is enabled.	Set the dual zone function to off. See <a href="#">Zone Control (P.145)</a> .
<ul style="list-style-type: none"> <li>• Cannot select the output destination of the subsource in the dual zone.</li> <li>• Cannot adjust the volume of the rear speakers.</li> </ul>	The dual zone function is disabled.	Set the dual zone function to on. See <a href="#">Zone Control (P.145)</a> .
<ul style="list-style-type: none"> <li>• Cannot set up the equalizer.</li> <li>• Cannot set up the crossover network.</li> </ul>	The dual zone function is enabled.	Set the dual zone function to off. See <a href="#">Zone Control (P.145)</a> .
	"DSP Select" is set to "Bypass".	Set "DSP Select" to "Through". See <a href="#">DSP select (P.143)</a> .

### About audio operations

Problem	Reason	Solution
Radio reception is poor.	The car antenna is not extended.	Pull out the antenna all the way.
	The antenna control wire is not connected.	Connect the wire correctly. See "Connection" in the Quick Start Guide.
Cannot play audio files stored in a disc.	"CD Read" is set to "2".	Set "CD Read" to "1". See <a href="#">Disc setup (P.65)</a> .
Cannot select a folder.	The random play function is enabled.	Turn off the random function.
Cannot perform repeat play during VCD playback.	The PBC function is enabled.	Turn off the PBC function.
The specified disc does not play, but another one plays instead.	The disc is quite dirty.	Clean the disc. See <a href="#">Precautions on handling discs (P.4)</a> .
	The disc is severely scratched.	Try another disc instead.

Problem	Reason	Solution
The sound skips when an audio file is being played.	The disc is scratched or dirty.	Clean the disc. See <a href="#">Precautions on handling discs (P.4)</a> .
	The recording condition is bad.	Record the file again or use another disc.
Audio is interrupted on AUPEO!	The communication environment is not stable.	Audio may be interrupted depending on the communication environment and this unit's operation condition.
	Audio is playing in the background.	

## Other

Problem	Reason	Solution
The Touch Sensor Tone doesn't sound.	The preout jack is being used.	The Touch Sensor Tone cannot be output from the preout jack.

## Error Messages

When you fail to operate the unit correctly, the cause of the failure appears as the message on the screen.

Error Message	Cause	Solution
Protect	Protective circuit has been activated because a speaker cord has shorted or it has come in contact with the car chassis.	Wire or insulate the speaker cord as appropriate and then press the <Reset> button <a href="#">(P.157)</a> .
Hot Error	When the internal temperature of this unit rises to 60°C or more, the protection circuit is activated and you may not be able to operate the unit.	Use the unit again after reducing the temperature of the unit.
Mecha Error	The disc player is malfunctioning.	Eject the disc and try inserting it again. Contact the Kenwood dealer if this indicator continues blinking or the disc cannot be ejected.
Disc Error	An unplayable disc is inserted.	Change the disc. See <a href="#">Playable Media and Files (P.158)</a> .
Read Error	The disc is quite dirty.	Clean the disc. See <a href="#">Precautions on handling discs (P.4)</a> .
	Disc is upside down.	Load the disc with the labeled side up.
Region Code Error	The disc you wanted to play has a region code that cannot be played with this unit.	See <a href="#">Region Codes in the World (P.163)</a> or try another disc.
Parental Level Error	The disc you wanted to play has a higher level than the parental level you set.	Set the parental level. See <a href="#">Parental level (P.65)</a> .



Error Message	Cause	Solution
Error 07–67	The unit is not operating correctly due to some reason or other.	Push the unit's Reset button. If the "Error 07–67" message does not disappear, see your nearest Kenwood dealer.
No Device (USB device)	The USB device is selected as a source although no USB device is connected.	Change the source to any source other than USB/iPod. Connect a USB device, and change the source to USB again.
Disconnected (iPod, Bluetooth audio player)	The iPod/Bluetooth audio player is selected as a source although no iPod/Bluetooth audio player is connected.	Change the source to any source other than iPod/Bluetooth. Connect an iPod/Bluetooth audio player, and change the source to iPod/Bluetooth again.
No Media file	The connected USB device contains no playable audio file. Media was played that doesn't have data recorded that the unit can play.	See <a href="#">Playable Media and Files (P.158)</a> and try another USB device.
USB Device Error!!	The connected USB device is rated a current capacity higher than the allowable limit.	Check the USB device. Some trouble may have occurred to the connected USB device. Change the source to any source other than USB. Remove the USB device.
Authorization Error	Connection to the iPod has failed.	<ul style="list-style-type: none"> <li>• Remove the iPod and then reconnect it.</li> <li>• The unit does not support the iPod. See <a href="#">Connectable iPod/iPhone (P.160)</a>.</li> </ul>
Update your iPod	The iPod's software is an older version which the unit can not support.	The unit may not support the connected iPod model. Confirm that the software for the iPod is the latest version. See <a href="#">Connectable iPod/iPhone (P.160)</a> .
Navigation Error. Please turn on power again later.	The communication error has occurred due to severely cold temperature.	Turn on power again after warming your car interior.
Network is disconnected	Not connected to Wi-Fi.	Connect to Wi-Fi.
Your Dropbox and Kenwood accounts are not linked.	Dropbox account information is not registered to the logged in Owner or User account.	Log in Route Collector site and register the Dropbox account

## SiriusXM

Error Message	Cause	Solution
Check Tuner	A SiriusXM tuner is not connected to this navigation system.	Check the connection to the SiriusXM tuner.
Subscription Updated - Press Return To Continue	The SiriusXM subscription has been renewed.	Touch [  ] to clear the error message.
Channel Not Available	The currently selected channel is unavailable.	—
Ch Unsubscribed	The currently selected channel is not subscribed to.	—
Check Antenna	No antenna is connected to the SiriusXM tuner.	Check that an antenna is connected to the SiriusXM tuner.
No Signal	No SiriusXM radio signal is received.	—

## Resetting the Unit

If the unit or the connected device fails to operate properly, reset the unit.

### 1 Press the <Reset> button.

The unit returns to factory settings.

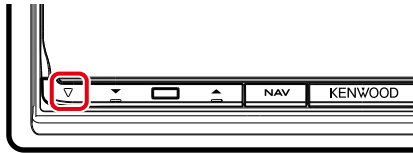

#### NOTE

- Disconnect the USB device before pressing the <Reset> button. Pressing the <Reset> button with the USB device connected can damage the data stored in the USB device. For how to disconnect the USB device, see [How to Play Media \(P.18\)](#).
- When the unit is turned on after resetting, the Initial SETUP screen appears. See [Initial setup \(P.14\)](#).

# Appendix

## Playable Media and Files

You can play various kinds of media and files on this unit.

### List of playable discs

Disc types	Standard	Support	Remark
DVD	DVD Video	○	
	DVD Audio	×	
	DVD-VR	×	
	DVD-R*1	○	<ul style="list-style-type: none"> <li>• MP3/WMA/AAC/MPEG1/MPEG2/DivX playback</li> <li>• Multi-border/Multisession playback (Playback depends on authoring conditions)</li> </ul>
	DVD-RW	○	
	DVD+R	○	
	DVD+RW	○	
	DVD-R DL (Dual layer)	○	Only video format
DVD+R DL (Double layer)	○		
DVD-RAM	×		
CD	Music CD*1	○	CD-TEXT
	CD-ROM	○	<ul style="list-style-type: none"> <li>• MP3/WMA/AAC/MPEG1/MPEG2/DivX playback</li> </ul>
	CD-R	○	<ul style="list-style-type: none"> <li>• Multisession is supported.</li> </ul>
	CD-RW	○	<ul style="list-style-type: none"> <li>• Packet write is not supported.</li> </ul>
	DTS-CD	×	
	Video CD (VCD)	○	
	Super video CD	×	
	Photo CD	×	
	CD-EXTRA	△	Only music CD session can be played.
	HDCD	○	
CCCD	×		
Others	Dualdisc	×	
	Super audio CD	△	Only CD layer can be played.

\*1 Incompatible with 8 cm (3 inch) discs.

○ : Playback is possible.

△ : Playback is partly possible.

×

#### NOTE

- When buying DRM enabled content, check the Registration Code in the [DivX® VOD \(P.81\)](#). Each time a file with the displayed code is played and protected against copying, the code changes.
- DivX can be played only from a DVD disc media.

## ● Use of DualDisc

When playing a "DualDisc" on this unit, the surface of the disc that is not played may be scratched while the disc is inserted or ejected. Since the music CD surface does not conform to the CD standard, playback may be impossible.

(A "DualDisc" is a disc with one surface containing DVD standard signals and the other surface containing music CD signals.)

## ● About disc format

The disc format should be the one of the following.

- ISO 9660 Level 1/2
- Joliet
- Romeo
- Long file name



## About files

The following audio, video, and picture files are supported.

### ● Audio files

- AAC-LC (.m4a)
- MP3 (.mp3)
- WMA (.wma)
- Linear PCM (WAVE) (.wav)  
\*Mass-storage-class USB device only
- FLAC (.flac)  
\*Mass-storage-class USB device only

### NOTE

- If music of normal CD and other playback systems are recorded in the same disc, only the playback system recorded at the first setout is played.
- WMA and AAC of which is covered with DRM cannot be played.
- Although the audio files are complied with the standards listed above, the play may be impossible depending on the types or conditions of media or device.
- An online manual about audio files is posted on the site, [www.kenwood.com/cs/ce/audiofile/](http://www.kenwood.com/cs/ce/audiofile/). On this online manual, detailed information and notes which are not written in this manual are provided. Make sure to read through the online manual as well.

## ● Video files

- MPEG1 (.mpg, .mpeg, .m1v)
- MPEG2 (.mpg, .mpeg, .m2v)
- DivX (.divx, .div, .avi)  
\*Only for DVD
- H.264/MPEG-4 AVC (.mp4, .m4v)  
\*Mass-storage-class USB device only
- WMV 9 (.wmv, .m2ts)  
\*Mass-storage-class USB device only
- MKV (.mkv)  
\*Mass-storage-class USB device only

## ● Picture files

Only picture files in USB device and SD card can be displayed.

Files stored in disc media is not supported.

- JPEG (.jpg, .jpeg)
- PNG (.png)
- BMP (.bmp)

### NOTE

- BMP and PNG can be set only as wallpaper.

## ● Playing order of files

In the example of folder/file tree shown below, the files are played in the order from ① to ⑩.

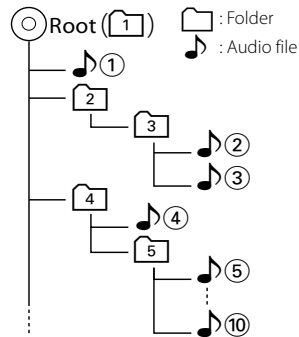

## **Connectable iPod/iPhone**

The following models can be connected to this unit.

Made for

- iPhone 5s
- iPhone 5c
- iPhone 5
- iPhone 4S
- iPhone 4
- iPhone 3GS
- iPhone 3G
- iPhone
- iPod touch (5th generation)
- iPod touch (4th generation)
- iPod touch (3rd generation)
- iPod touch (2nd generation)
- iPod touch (1st generation)
- iPod classic
- iPod with video
- iPod nano (7th generation)
- iPod nano (6th generation)
- iPod nano (5th generation)
- iPod nano (4th generation)
- iPod nano (3rd generation)

### **NOTE**

- For the details of the necessary cable and adapter to connect with iPod/iPhone, refer to [Music/Video Basic Operation \(P.66\)](#).
- Latest compatible list of iPod/iPhone. For details, see [www.kenwood.com/cs/ce/ipod/](http://www.kenwood.com/cs/ce/ipod/).
- By connecting your iPod/iPhone to this unit with an optional accessory iPod connection cable (KCA-iP103, KCA-iP102 or KCA-iP202), you can supply power to your iPod/iPhone as well as charge it while playing music. However, the power of this unit must be on.
- If you start playback after connecting the iPod, the music that has been played by the iPod is played first.  
In this case, "Reading" is displayed without displaying a folder name, etc. Changing the browse item will display a correct title, etc.
- When the iPod is connected to this unit, "KENWOOD" or "✓" is displayed on the iPod to indicate that you cannot operate the iPod.

## **Usable USB device**

You can use a mass-storage-class USB device on this unit.

The word "USB device" appearing in this manual indicates a flash memory device and digital audio players can be recognized as mass-storage.

### **● About file system**

The file system should be the one of the following.

- FAT16
- FAT32

### **NOTE**

- When the USB device is connected to this unit, it can be charged through the USB cable.
- Install the USB device in the place where it will not affect safe driving.
- You cannot connect a USB device via a USB hub and Multi Card Reader.
- Take backups of the audio files used with this unit. The files can be erased depending on the operating conditions of the USB device. We shall have no compensation for any damage arising from any erased data.
- No USB device comes with this unit. You need to purchase a commercially available USB device.
- When connecting the USB device, usage of the CA-U1EX (option) is recommended. (However, maximum supply current of CA-U1EX is 500mA.) Normal playback is not guaranteed when a cable other than the USB compatible cable is used.

## **Usable SD card (DNN992)**

The unit is capable of playback of SD/SDHC memory cards complying with the SD or SDHC standard.

A special adapter is required to use a miniSD card, miniSDHC card, microSD card or microSDHC card.

The MultiMedia Card (MMC) cannot be used.

## Status Bar Indicator Items

Shown below is a list of indicators displayed on the status bar in the screen.  
Current status of this unit is displayed on the bar.



Status bar

### ● General

#### **ATT**

The attenuator is active.

#### **DUAL**

The dual zone function is on.

#### **TEL**

Indicates the connection state of the Bluetooth hands-free unit.

- White: Connected
- Orange: Not connected

#### **LOUD**

The loudness control function is on.

### ● DVD/CD

#### **FO-REP**

Folder repeat function is on.

#### **IN**

A disc is inserted.

- White: A Disc is inside the unit.
- Orange: Error at the disc player

#### **VIDEO**

Identifies the video file.

#### **MUSIC**

Identifies the music file.

#### **RDM**

The random function is on.

#### **REP**

The repeat function is on.

#### **C-REP**

The chapter repeat function is on.

#### **T-REP**

The title repeat function is on.

### ● VCD

#### **1chLL/2chLL**

Identifies the left audio output of channel 1 or 2.

#### **1chLR/2chLR**

Identifies the monaural audio output of channel 1 or 2.

#### **1chRR/2chRR**

Identifies the right audio output of channel 1 or 2.

#### **1chST/2chST**

Identifies the stereo audio output of channel 1 or 2.

#### **LL**

Identifies the left audio output.

#### **LR**

Identifies the monaural audio output.

#### **RR**

Identifies the right audio output.

#### **STEREO**

Identifies the stereo audio output.

#### **PBC**

The PBC function is on.

#### **SVCD**

Identifies the Super Video CD.

#### **VER1**

The VCD version is 1.

#### **VER2**

The VCD version is 2.

#### **REP**

The repeat function is on.

● USB SD

**FO-REP**

The folder repeat function is on.

**VIDEO**

Identifies the video file.

**MUSIC**

Identifies the music file.

**RDM**

The random function is on.

**REP**

The repeat function is on.

**PLST**

The play list mode is selected now.

● iPod

**MUSIC**

Identifies the music file.

**VIDEO**

Identifies the video file.

**RDM**

The random function is on.

**A-RDM**

The album random function is on.

**REP**

The repeat function is on.

● Tuner

**AUTO1**

Seek mode is set to AUTO1.

**AUTO2**

Seek mode is set to AUTO2.

**MANUAL**

Seek mode is set to MANUAL.

**ST**

A stereo broadcast is being received.

**TI**

Indicates the reception state of traffic information.

- White: TP is being received.
- Orange: TP is not being received.

● HD Radio reception

**AUTO1**

Seek mode is set to AUTO1.

**AUTO2**

Seek mode is set to AUTO2.

**MANU**

Seek mode is set to MANUAL.

**HD**

HD Radio station is being received.

**ANALOG**

An analog broadcast is being received.

**DIGITAL**

A digital broadcast is being received.

**ST**

A stereo broadcast is being received.

**TI**

Indicates the reception state of traffic information.

- White: TP is being received.
- Orange: TP is not being received.

● SiriusXM

**SEEK1**

Seek mode is set to SEEK1.

**SEEK2**

Seek mode is set to SEEK2.

## Region Codes in the World

The DVD players are given a region code according to the country or area it is marketed, as shown in the following map.

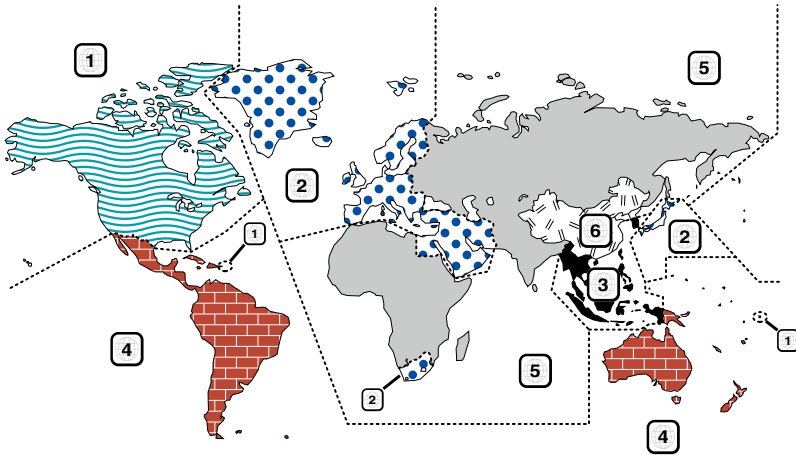

### ● DVD disc marks



Indicates a region number. The discs with this mark can be played with any DVD player.



Indicates the number of audio languages recorded. Up to 8 languages can be recorded in a movie. You can select a favorite language.



Indicates the number of subtitled languages recorded. Up to 32 languages can be recorded.



If a DVD disc has scenes shot from multiple angles, you can select a favorite angle.

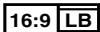

Indicates the type of screen for the image. The left mark indicates that a wide image picture (16:9) is displayed on a standard TV set screen (4:3) with a black band at both the top and bottom of the screen (letter box).

### ● Operation regulatory marks

With this DVD, some functions of this unit such as the play function may be restricted depending on the location where the DVD is playing. In this case, the following marks will appear on the screen. For more information, refer to the disc manual.



### ● Discs with limited period of use

Do not leave discs with a limited period of use in this unit. If you load an already expired disc, you may not be able to remove it from this unit.



## DVD Language Codes

Code	Language
aa	Afar
ab	Abkhazian
af	Afrikaans
am	Amharic
ar	Arabic
as	Assamese
ay	Aymara
az	Azerbaijani
ba	Bashkir
be	Byelorussian
bg	Bulgarian
bh	Bihari
bi	Bislama
bn	Bengali, Bangla
bo	Tibetan
br	Breton
ca	Catalan
co	Corsican
cs	Czech
cy	Welsh
da	Danish
de	German
dz	Bhutani
el	Greek
en	English
eo	Esperanto
es	Spanish
et	Estonian
eu	Basque
fa	Persian
fi	Finnish
fj	Fiji
fo	Faroese
fr	French
fy	Frisian
ga	Irish
gd	Scots Gaelic
gl	Galician
gn	Guarani
gu	Gujarati
ha	Hausa
he	Hebrew
hi	Hindi
hr	Croatian
hu	Hungarian
hy	Armenian

Code	Language
ia	Interlingua
ie	Interlingue
ik	Inupiak
id	Indonesian
is	Icelandic
it	Italian
ja	Japanese
jav	Javanese
ka	Georgian
kk	Kazakh
kl	Greenlandic
km	Cambodian
kn	Kannada
ko	Korean
ks	Kashmiri
ku	Kurdish
ky	Kirghiz
la	Latin
lb	Luxembourgish
ln	Lingala
lo	Laotian
lt	Lithuanian
lv	Latvian, Lettish
mg	Malagasy
mi	Maori
mk	Macedonian
ml	Malayalam
mn	Mongolian
mo	Moldavian
mr	Marathi
ms	Malay
mt	Maltese
my	Burmese
na	Nauru
ne	Nepali
nl	Dutch
no	Norwegian
oc	Occitan
om	(Afan) Oromo
or	Oriya
pa	Punjabi
pl	Polish
ps	Pashto, Pushto
pt	Portuguese
qu	Quechua
rm	Rhaeto-Romance

Code	Language
rn	Kirundi
ro	Romanian
ru	Russian
rw	Kinyarwanda
sa	Sanskrit
sd	Sindhi
sg	Sangho
sh	Serbo-Croatian
si	Singhalese
sk	Slovak
sl	Slovenian
sm	Samoaan
sn	Shona
so	Somali
sq	Albanian
sr	Serbian
ss	Siswati
st	Sesotho
su	Sundanese
sv	Swedish
sw	Swahili
ta	Tamil
te	Telugu
tg	Tajik
th	Thai
ti	Tigrinya
tk	Turkmen
tl	Tagalog
tn	Setswana
to	Tongan
tr	Turkish
ts	Tsonga
tt	Tatar
tw	Twí
uk	Ukrainian
ur	Urdu
uz	Uzbek
vi	Vietnamese
vo	Volapuk
wo	Wolof
xh	Xhosa
yo	Yoruba
zh	Chinese
zu	Zulu

## Specifications

### ● Monitor section

#### Picture Size

: 6.95 inches (diagonal) wide  
: 156.6 mm (W) x 81.6 mm (H)  
6-3/16 x 3-3/16 inch

#### Display System

: Transparent TN LCD panel

#### Drive System

: TFT active matrix system

#### Number of Pixels

: 1,152,000 (800H x 480V x RGB)

#### Effective Pixels

: 99.99 %

#### Pixel Arrangement

: RGB striped arrangement

#### Back Lighting

: LED

### ● DVD player section

#### D/A Converter

: 24 bit

#### Audio Decoder

: Linear PCM/Dolby Digital/MP3/WMA/AAC

#### Video Decoder

: MPEG1/ MPEG2/ DivX

#### Wow & Flutter

: Below Measurable Limit

#### Frequency Response

- 96 kHz : 20 – 20,000 Hz
- 48 kHz : 20 – 20,000 Hz
- 44.1 kHz : 20 – 20,000 Hz

#### Total Harmonic Distortion

: 0.008 % (1 kHz)

#### S/N Ratio (dB)

: 90 dB (DVD-Video 96 kHz)

#### Dynamic Range

: 91 dB (DVD-Video 96 kHz)

#### Disc Format

: DVD-Video/ VIDEO-CD/ CD-DA

#### Sampling Frequency

: 44.1/48/96 kHz

#### Quantifying Bit Number

: 16/20/24 bit

### ● USB interface section

#### USB Standard

: USB 2.0 Full/ High speed

#### File System

: FAT 16/ 32

#### Maximum Power Supply Current

iPod/iPhone: DC 5 V  $\overline{\text{---}}$  1 A  
USB: DC 5 V  $\overline{\text{---}}$  500 mA

#### D/A Converter

: 24 Bit

#### Video Decoder

: MPEG1/MPEG2/MPEG4/WMV/H.264/mkv

#### Audio Decoder

: MP3/ WMA/ AAC/ WAV/ FLAC

### ● SD (DNN992)

#### SD Standard

: SD/ SD-HC

#### Compatible File System

: FAT 16/32

#### Capacity

: Maximum 32G Byte

#### Data Transfer Rate

: Maximum 24MB/sec

#### Video Decoder

: MPEG1/MPEG2/MPEG4/WMV/H.264/mkv

#### Audio Decoder

: MP3/ WMA/ AAC/ WAV/ FLAC

● **Network section**

**uPnP**

: Media Controller/Media Server/Media player/Media  
Renderer

**Video Decoder**

: MPEG1/MPEG2/MPEG4/WMV/H.264/mkv

**Audio Decoder**

: MP3/WMA/ AAC/WAV/FLAC

● **Wi-Fi section**

**IEEE Standard**

: 802.11b/g/n

**Security Support**

: 64/128bit WEP / WPA & WPA2

**Frequency Range**

DNN992: 2.401 – 2.473 GHz

DNN9150BT: 2.401 – 2.483 GHz

**Transfer rates (MAX)**

**DNN992**

: 802.11n(150 Mbps) / 802.11g(54 Mbps) /

802.11b(11 Mbps)

**DNN9150BT**

802.11n(150 Mbps) / 802.11g(54 Mbps) /

802.11b(11 Mbps)

**Output Power**

**DNN992**

: DSSS: 15 – 19dBm,

OFDM (11g): 13 – 17dBm, OFDM (11n): 11 – 15dBm

**DNN9150BT**

: DSSS: 15 – 19dBm,

OFDM (11g): 13 – 17dBm, OFDM (11n): 11 – 15dBm

● **Bluetooth section**

**Technology**

: Bluetooth Ver3.0+EDR

**Frequency**

: 2.402 – 2.480 GHz

**Output Power**

: +4dBm (MAX), 0dBm (AVE), Power Class2

**Maximum Communication Range**

: Line of sight approx. 10m (32.8 ft)

**Audio Codec**

SBC/ AAC/ MP3/ aptX

**Profile**

- HFP (V1.6) (Hands Free Profile)
- SPP (Serial Port Profile)
- A2DP (Advanced Audio Distribution Profile)
- AVRCP (Audio/Video Remote Control Profile)
- HID (Human Interface Device Profile)
- PBAP (Phonebook Access Profile)
- GAP (Generic Access Profile)
- Multi Profile support

● **HDMI/ MHL section**

**HDMI**

: HDMI Type-A

**MHL Supported Version**

: MHL 2

**MHL Maximum Power Supply Current**

: DC 5 V  900 mA

● **DSP section**

**Graphics equalizer**

Band: 13 Band

Frequency (BAND1 – 13)

: 62.5/100/160/250/400/630/1k/1.6k/2.5k/4k/6.3k/  
10k/16k Hz

**Gain**

: -9/-8/-7/-6/-5/-4/-3/-2/-1/0/1/2/3/4/5/6/7/8/9 dB

**X'over**

**Front/ Rear High pass filter**

Frequency: Through, 30/ 40/ 50/ 60/ 70/ 80/ 90/ 100/  
120/ 150 / 180/ 220/ 250 Hz

Slope: -6/-12/-18/-24 dB/Oct.

**Subwoofer Low pass filter**

Frequency: 30/ 40/ 50/ 60/ 70/ 80/ 90/ 100/ 120/  
150/ 180/ 220/ 250 Hz, Through

Slope: -6/-12/-18/-24 dB/Oct.

**Position**

**Front / Rear /Subwoofer Delay**

: 0 – 20.0ft (0.07ft Step)

**Gain**

: -8 – 0 dB

**Subwoofer level**

: -50 – +10 dB

### ● Digital FM tuner section (DNN992)

**Frequency Range**

: 87.9 MHz – 107.9 MHz (200 kHz)

**Frequency Response ( $\pm 3.0$  dB)**

: 20 Hz – 20 kHz

**S/N Ratio (dB)**

: 75 dB (STEREO)

### ● Digital AM tuner section (DNN992)

**Frequency Range (10 kHz)**

: 530 kHz – 1700 kHz

**Frequency Response ( $\pm 3.0$  dB)**

: 40 Hz – 15 kHz

**S/N Ratio (dB)**

: 75 dB (STEREO)

### ● FM tuner section

**Frequency Range**

DNN992 : 87.9 MHz – 107.9 MHz (200 kHz)  
DNN9150BT : 87.5 MHz – 108.0 MHz (50 kHz)

**Usable Sensitivity (S/N : 30 dB)**

DNN992 : 7.2 dBf (0.8  $\mu$ V/75  $\Omega$ )  
DNN9150BT : 0.63  $\mu$ V/75  $\Omega$

**Quieting Sensitivity (S/N : 50 dB)**

DNN992 : 10.2 dBf (1.13  $\mu$ V/75  $\Omega$ )  
DNN9150BT : 15.2 dBf (1.6  $\mu$ V/75  $\Omega$ )

**Frequency Response ( $\pm 3.0$  dB)**

: 30 Hz – 15 kHz

**S/N Ratio (dB)**

: 75 dB (MONO)

**Selectivity ( $\pm 400$  kHz)**

:  $\geq 80$  dB

**Stereo Separation**

: 45 dB (1 kHz)

### ● AM tuner section

**Frequency Range (10 kHz)**

: 530 kHz – 1700 kHz

**Usable Sensitivity**

: 28 dB $\mu$ V

### ● Video section

**Color System of External Video Input**

: NTSC/PAL

**External Video Input Level (RCA jacks)**

: 1 Vp-p/ 75  $\Omega$

**External Audio Max Input Level (RCA jacks)**

: 2 V/ 25 k $\Omega$

**Video Input Level (RCA jacks)**

: 1 Vp-p/ 75  $\Omega$

**Video Output Level (RCA jacks)**

: 1 Vp-p/ 75  $\Omega$

**Audio Output Level (Mini jack)**

: 1.2 V/ 10 k $\Omega$

### ● Audio section

**Maximum Power (Front & Rear)**

: 50 W x 4

**Full Bandwidth Power (Front & Rear) (4  $\Omega$ , 14.4 V, 1 % THD)**

: 22 W x 4

**Preout Level (V)**

: 5 V/ 10 k $\Omega$

**Preout Impedance**

:  $\leq 250 \Omega$

**Speaker Impedance**

: 4 – 8  $\Omega$

### ● External SW

**Maximum Power Supply Current**

: 500 mA

## ● Navigation section

### Receiver

: High-sensitivity GPS receiver

### Reception Frequency

: 1575.42 MHz (C/A code)

### Acquisition Times

Cold : 29 seconds (typ)  
(All satellites at -130 dBm Without aiding)

### Update Rate

: 1/second, continuous

### Accuracy

Position: <2.5 meters, CEP, at -130 dBm  
Velocity: 0.1 meter/sec RMS

### Position Method

: GPS

### Antenna

: External GPS antenna

## ● General

### Operating Voltage

: 14.4 V (10.5 – 16 V allowable)

### Maximum Current Consumption

: 10 A

### Installation Dimensions (W × H × D)

: 182 × 112 × 163 mm  
7-3/16 × 4-7/16 × 6-7/16 inch

### Operational Temperature Range

: -10 °C – +60 °C

### Weight

: 2.5 kg (5.5 lbs)

#### NOTE

- Although the effective pixels for the liquid crystal panel is given as 99.99% or more, 0.01% of pixels may not light or may light incorrectly.

**Specifications subject to change without notice.**

## Trademarks

- The Bluetooth word mark and logos are owned by the Bluetooth SIG, Inc. and any use of such marks by JVC KENWOOD Corporation is under license. Other trademarks and trade names are those of their respective owners.



- The "AAC" logo is a trademark of Dolby Laboratories.



- Microsoft and Windows Media are either registered trademarks or trademarks of Microsoft Corporation in the United States and/or other countries.



- "Made for iPod" and "Made for iPhone" mean that an electronic accessory has been designed to connect specifically to iPod, or iPhone, respectively, and has been certified by the developer to meet Apple performance standards. Apple is not responsible for the operation of this device or its compliance with safety and regulatory standards. Please note that the use of this accessory with iPod, or iPhone may affect wireless performance.



- iPhone, iPod, iPod classic, iPod nano, and iPod touch are trademarks of Apple Inc., registered in the U.S. and other countries. Lightning is a trademark of Apple Inc.



-  is a trademark of DVD Format/Logo Licensing Corporation registered in the U.S., Japan and other countries.



- This item incorporates copy protection technology that is protected by U.S. patents and other intellectual property rights of Rovi Corporation. Reverse engineering and disassembly are prohibited.

- Manufactured under license from Dolby Laboratories. Dolby and the double-D symbol are trademarks of Dolby Laboratories.



- HD Radio Technology manufactured under license from iBiquity Digital Corporation. U.S. and Foreign Patents. HD Radio™ and the HD, HD Radio, and “Arc” logos are proprietary trademarks of iBiquity Digital Corp.



- Sirius, XM and all related marks and logos are trademarks of Sirius XM Radio Inc. All rights reserved.



- PANDORA, the PANDORA logo, and the Pandora trade dress are trademarks or registered trademarks of Pandora Media, Inc., used with permission.



- iHeartRadio® is a registered mark of Clear Channel Broadcasting, Inc. in the United States and other countries. Such marks are used under license.



- “aupeo” is a trade mark of Aupeo GmbH.



- Wi-Fi is a registered trademark of the Wi-Fi Alliance.



- Android is a trademark of Google Inc.
- SDHC Logo is a trademark of SD-3C, LLC.



- Twitter is a registered trademark of Twitter, Inc.
- Facebook® is a registered trademark of Facebook Inc.
- INRIX is a registered trademark of INRIX, Inc.
- Nuance is a registered trademark of Nuance Communications, Inc.
- Dropbox is a trademark of Dropbox Inc.

- The terms HDMI and HDMI High-Definition Multimedia Interface, and the HDMI logo are trademarks or registered trademarks of HDMI Licensing LLC in the United States and other countries.



- MHL and the MHL logo are a trademark or registered trademark of MHL, LLC.
  - Incorporates MHL 2



- BlackBerry®, RIM®, Research In Motion® and related trademarks, names and logos are the property of Research In Motion Limited and are registered and/or used in the U.S. and countries around the world. Used under license from Research In Motion Limited.
- ABOUT DIVX VIDEO: DivX® is a digital video format created by DivX, LLC, a subsidiary of Rovi Corporation. This is an official DivX Certified® device that plays DivX video. Visit [divx.com](http://divx.com) for more information and software tools to convert your files into DivX videos.
- ABOUT DIVX VIDEO-ON-DEMAND: This DivX Certified® device must be registered in order to play purchased DivX Video-on-Demand (VOD) movies. To obtain your registration code, locate the DivX VOD section in your device setup menu. Go to [vod.divx.com](http://vod.divx.com) for more information on how to complete your registration.
- DivX®, DivX Certified® and associated logos are trademarks of Rovi Corporation or its subsidiaries and are used under license.



- QR Code® is registered trademarks of DENSO WAVE INCORPORATED in JAPAN and other countries.
- The aptX® software is copyright CSR plc or its group companies. All rights reserved. The aptX® mark and the aptX logo are trade marks of CSR plc or one of its group companies and may be registered in one or more jurisdictions.



• AVC

THIS PRODUCT IS LICENSED UNDER THE AVC PATENT PORTFOLIO LICENSE FOR THE PERSONAL USE OF A CONSUMER OR OTHER USES IN WHICH IT DOES NOT RECEIVE REMUNERATION TO (i) ENCODE VIDEO IN COMPLIANCE WITH THE AVC STANDARD ("AVC VIDEO") AND/OR (ii) DECODE AVC VIDEO THAT WAS ENCODED BY A CONSUMER ENGAGED IN A PERSONAL ACTIVITY AND/OR WAS OBTAINED FROM A VIDEO PROVIDER LICENSED TO PROVIDE AVC VIDEO. NO LICENSE IS GRANTED OR SHALL BE IMPLIED FOR ANY OTHER USE. ADDITIONAL INFORMATION MAY BE OBTAINED FROM MPEG LA, L.L.C. SEE [HTTP://WWW.MPEGLA.COM](http://www.mpegla.com)

• MPEG-4 Visual

THIS PRODUCT IS LICENSED UNDER THE MPEG-4 VISUAL PATENT PORTFOLIO LICENSE FOR THE PERSONAL AND NON-COMMERCIAL USE OF A CONSUMER FOR (i) ENCODING VIDEO IN COMPLIANCE WITH THE MPEG-4 VISUAL STANDARD ("MPEG-4 VIDEO") AND/OR (ii) DECODING MPEG-4 VIDEO THAT WAS ENCODED BY A CONSUMER ENGAGED IN A PERSONAL AND NON-COMMERCIAL ACTIVITY AND/OR WAS OBTAINED FROM A VIDEO PROVIDER LICENSED BY MPEG LA TO PROVIDE MPEG-4 VIDEO. NO LICENSE IS GRANTED OR SHALL BE IMPLIED FOR ANY OTHER USE. ADDITIONAL INFORMATION INCLUDING THAT RELATING TO PROMOTIONAL, INTERNAL AND COMMERCIAL USES AND LICENSING MAY BE OBTAINED FROM MPEG LA, L.L.C. SEE [HTTP://WWW.MPEGLA.COM](http://www.mpegla.com).

• libFLAC

Copyright (C) 2000,2001,2002,2003,2004,2005,2006,2007,2008,2009 Josh Coalson  
Redistribution and use in source and binary forms, with or without modification, are permitted provided that the following conditions are met:  
- Redistributions of source code must retain the above copyright notice, this list of conditions and the following disclaimer.  
- Redistributions in binary form must reproduce the above copyright notice, this list of conditions and the following disclaimer in the documentation and/or other materials provided with the distribution.  
- Neither the name of the Xiph.org Foundation nor the names of its contributors may be used to endorse or promote products derived from this software without specific prior written permission.  
THIS SOFTWARE IS PROVIDED BY THE COPYRIGHT HOLDERS AND CONTRIBUTORS "AS IS" AND ANY EXPRESS OR IMPLIED WARRANTIES, INCLUDING, BUT NOT LIMITED TO, THE IMPLIED WARRANTIES OF MERCHANTABILITY AND FITNESS FOR A PARTICULAR PURPOSE ARE DISCLAIMED. IN NO EVENT SHALL THE FOUNDATION OR CONTRIBUTORS BE LIABLE FOR ANY DIRECT, INDIRECT, INCIDENTAL, SPECIAL, EXEMPLARY, OR CONSEQUENTIAL DAMAGES (INCLUDING, BUT NOT LIMITED TO, PROCUREMENT OF SUBSTITUTE GOODS OR SERVICES; LOSS OF USE, DATA, OR PROFITS; OR BUSINESS INTERRUPTION) HOWEVER CAUSED AND ON ANY THEORY OF LIABILITY, WHETHER IN CONTRACT,

STRICT LIABILITY, OR TORT (INCLUDING NEGLIGENCE OR OTHERWISE) ARISING IN ANY WAY OUT OF THE USE OF THIS SOFTWARE, EVEN IF ADVISED OF THE POSSIBILITY OF SUCH DAMAGE.

• **Requirements Pandora®:**

Requirements for listening to the Pandora® are as follows:

- A smartphone with the latest Pandora application installed.
- A Pandora account (if you do not have an account, create one for free using the mobile app or on [www.pandora.com](http://www.pandora.com)).
- An active internet connection.

**iPhone or iPod touch**

- Apple iPhone or iPod touch with iOS 3 or later installed.
- Latest version of the Pandora application (search App Store for Pandora and install).

**Android™**

- Latest version of the Pandora Android application (search Google Play for Pandora and install).

**BlackBerry®**

- Visit [www.pandora.com](http://www.pandora.com) from the built in browser to download the Pandora application.
- Bluetooth must be built in and the following profiles must be supported.
  - SPP (Serial Port Profile)
  - A2DP (Advanced Audio Distribution Profile)

**Note**

- Pandora® is available only in the U.S, Australia and New Zealand.
- Because Pandora® is a third-party service, the specifications are subject to change without prior notice. Accordingly, compatibility may be impaired or some or all of the services may become unavailable.
- Some functions of Pandora® cannot be operated from this unit.
- For issues using the application, please contact Pandora® at [pandora-support@pandora.com](mailto:pandora-support@pandora.com)

• **Requirements iHeartRadio™:**

Requirements for listening to iHeartRadio are as follows:

- In the application on your device, log in and create a free account with iHeartRadio.
- An active internet connection.

**Note**

- Because iHeartRadio™ is a third-party service, the specifications are subject to change without prior notice. Accordingly, compatibility may be impaired or some or all of the services may become unavailable.
- Some iHeartRadio™ functionality cannot be operated from this unit.

## Safety precaution

### ● FCC WARNING

This equipment may generate or use radio frequency energy. Changes or modifications to this equipment may cause harmful interference unless the modifications are expressly approved in the instruction manual. The user could lose the authority to operate this equipment if an unauthorized change or modification is made.

### NOTE

This equipment has been tested and found to comply with the limits for a Class B digital device, pursuant to Part 15 of the FCC Rules. These limits are designed to provide reasonable protection against harmful interference in a residential installation. This equipment may cause harmful interference to radio communications, if it is not installed and used in accordance with the instructions. However, there is no guarantee that interference will not occur in a particular installation. If this equipment does cause harmful interference to radio or television reception, which can be determined by turning the equipment off and on, the user is encouraged to try to correct the interference by one or more of the following measures:

- Reorient or relocate the receiving antenna.
- Increase the separation between the equipment and receiver.
- Connect the equipment into an outlet on a circuit different from that to which the receiver is connected.
- Consult the dealer or an experienced radio/TV technician for help.

### ▲CAUTION

Use of controls or adjustments or performance of procedures other than those specified herein may result in hazardous radiation exposure.

In compliance with Federal Regulations, following are reproductions of labels on, or inside the product relating to laser product safety.

JVC KENWOOD Corporation  
2967-3, ISHIKAWA-MACHI,  
HACHIOJI-SHI, TOKYO, JAPAN

THIS PRODUCT COMPLIES WITH DHHS  
RULES 21 CFR SUBCHAPTER J IN EFFECT AT  
DATE OF MANUFACTURE.

Location: Top plate

### ● IC (Industry Canada) Notice

This device complies with Industry Canada licence-exempt RSS standard(s).

Operation is subject to the following two conditions:

- (1) This device may not cause interference, and
- (2) this device must accept any interference, including interference that may cause undesired operation of the device.

The term "IC:" before the certification/ registration number only signifies that the Industry Canada technical specification were met.

### ▲CAUTION

This equipment complies with FCC/IC radiation exposure limits set forth for an uncontrolled environment and meets the FCC radio frequency (RF) Exposure Guidelines in Supplement C to OET65 and RSS-102 of the IC radio frequency (RF) Exposure rules. This equipment has very low levels of RF energy that it deemed to comply without maximum permissive exposure evaluation (MPE). But it is desirable that it should be installed and operated keeping the radiator at least 20cm or more away from person's body (excluding extremities: hands, wrists, feet and ankles).

Under Industry Canada regulations, this radio transmitter may only operate using an antenna of a type and maximum (or lesser) gain approved for the transmitter by Industry Canada. To reduce potential radio interference to other users, the antenna type and its gain should be so chosen that the equivalent isotropically radiated power (e.i.r.p.) is not more than that necessary for successful communication.

- Contains Transmitter Module  
FCC ID : YZP-RBFAC21XX
- Contains Transmitter Module  
IC: 7414A-RBFAC21XX



DNN9150BT :

● The marking of products using lasers

**CLASS 1  
LASER PRODUCT**

The label is attached to the chassis/case and says that the component uses laser beams that have been classified as Class 1. It means that the unit is utilizing laser beams that are of a weaker class. There is no danger of hazardous radiation outside the unit.

● Información acerca de la eliminación de equipos eléctricos y electrónicos al final de la vida útil (aplicable a los países que hayan adoptado sistemas independientes de recogida de residuos)



Los productos con el símbolo de un contenedor con ruedas tachado no podrán ser desechados como residuos domésticos.

Los equipos eléctricos y electrónicos al final de la vida útil, deberán ser reciclados en instalaciones que puedan dar el tratamiento adecuado a estos productos y a sus subproductos residuales correspondientes. Póngase en contacto con su administración local para obtener información sobre el punto de recogida más cercano. Un tratamiento correcto del reciclaje y la eliminación de residuos ayuda a conservar los recursos y evita al mismo tiempo efectos perjudiciales en la salud y el medio ambiente.

● Para cumplimiento de la COFETEL:

“La operación de este equipo esta sujeta a las siguientes dos condiciones:

(1) es posible que este equipo o dispositivo no cause interferencia perjudicial y

(2) este equipo o dispositivo debe aceptar cualquier interferencia,

incluyendo la que pueda causar su operación no deseada.”

● Informação sobre a eliminação de pilhas

Este produto não deve ser eliminado como lixo doméstico geral. Devolva a pilha usada ao revendedor ou entidade autorizada para que a mesma seja devolvida ao fabricante ou importador.

A reciclagem e a eliminação de lixo de maneira apropriada ajudarão a conservar os recursos naturais ao mesmo tempo que prevenirão os efeitos prejudiciais à nossa saúde e ao meio ambiente.

**About QAU0568 (USB Wi-Fi® Adapter)  
(DNN992)**

**About QAU0569 (USB Wi-Fi® Adapter)  
(DNN9150BT)**

The Wi-Fi Adapter is attached to this unit when shipped from the factory. When the adapter is removed, store it in a safe place.

# HD Radio®

This HD Radio receiver enables:

PSD)

HD2/HD3)

Bookmark)

Digital Sound)

Artist Experience)



# KENWOOD

# KENWOOD

CONNECTED NAVIGATION SYSTEM

## DNN992

---

### GPS NAVIGATION INSTRUCTION MANUAL

JVCKENWOOD Corporation

# Contents

## End-User License Agreements 4

## Getting Started 10

Using the Navigation System	10
Help When You Need It	10
Searching Help Topics	10
Status Bar Icons	10
Satellite Signals	11
Viewing GPS Satellite Signals	11
Using the On-Screen Buttons	11
Using the On-Screen Keyboard	11
Adding a Shortcut	11
Removing a Shortcut	11

## Finding Locations 12

Finding a Location by Category	12
Searching Within a Category	12
Finding a Location Using the Search Bar	12
Changing the Search Area	12
Finding Fuel Stations and Prices	13
Finding an Address	13
Finding a City	13
Finding an Intersection	13
Finding a Location Using Coordinates	14
Finding a Location by Browsing the Map	14
Finding a Location Using Quick Search	14
Saving a Home Location	14
Going Home	15
Editing Your Home Location Information	15
Finding Recently Found Places	15
Clearing the List of Recently Found Places	15
Finding Parking	15
Setting a Simulated Location	15
Saving a Location	15
Saving Your Current Location	15
Starting a Route to a Saved Location	16
Editing a Saved Location	16
Assigning Categories to a Saved Location	16
Deleting a Saved Location	16

## Voice Command 17

Voice Command Tips	17
Starting a Route Using Voice Command	17
Finding an Address	17

## Navigation 18

Starting a Route	18
Previewing Multiple Routes	18
Following a Route	18
Using the Navigation Map	18
Using Multi-touch Controls	18
Adding a Point to a Route	19
Taking a Detour	19
Stopping the Route	19
Using Suggested Routes	19
Using Exit Services	19
Finding Exit Services	19
Navigating to an Exit	20
Using Find Ahead	20
Avoiding Road Features	20
Adding a Custom Avoidance Area	20
Avoiding a Road	20
Disabling a Custom Avoidance	20
Deleting Custom Avoidances	21
Enabling Advanced Detours	21
Taking a Detour Around Specified Areas	21

## The Map Pages 22

Customizing the Map Layers	22
Viewing the Trip Log	22
Changing the Map Data Field	22
Changing the Map Perspective	22
Customizing Map Buttons	22
Removing Buttons from the Map	22
Viewing a List of Turns	23
Viewing the Entire Route on the Map	23
Viewing the Next Turn	23
Viewing Junctions	23
Viewing Traffic Alerts	23
Viewing Trip Information	23
Resetting Trip Information	24
Viewing Current Location Information	24
Finding Nearby Services	24
Directions to Your Current Location	24

**Using the Apps 25**

About the Apps	25
About ecoRoute	25
Creating a Vehicle Profile	25
Resetting Your Vehicle Profile	25
Calibrating Fuel Economy	25
Taking the ecoChallenge	25
About ecoChallenge Scores	26
Hiding Your ecoChallenge Score	26
Resetting Your Score	26
Viewing Your Fuel Economy	26
About the Mileage Report	26
Viewing a Mileage Report	26
Exporting a Mileage Report	27
Setting Routes that Use Less Fuel	27
Planning a Trip	27
Editing a Trip Itinerary	27
Navigating to a Saved Trip	27
Editing a Saved Trip	27
Importing Routes	28
Viewing Previous Routes & Destinations	28
Using the World Clock	28
Viewing the World Map	28
Using Dynamic Parking	28
About myCameras	28
Using Movie Time	28

**Customizing the Settings 31**

Customizing the Navigation System	31
Changing the Map Settings	31
Enabling Maps	31
Changing the Navigation Settings	31
Adjusting the Display Settings	31
Route Preferences	31
Updating the Time Settings	32
Setting the Languages	32
Adding Security	32
Device and Privacy Settings	32
Restoring Settings	32

**Appendix 33**

Updating the Software	33
Updating the Map Data	33
Safety Cameras	33
Custom POIs (Points of Interest)	33
Finding Custom POIs	33

**Traffic Information 29**

Traffic Subscription Activation	29
Understanding Traffic	29
Traffic Data Using INRIX Traffic Service	29
About the Traffic Icon	29
Traffic on Your Route	30
Viewing Traffic on Your Route	30
Manually Avoiding Traffic on Your Route	30
Taking an Alternate Route	30
Viewing Traffic on the Map	30
Searching for Traffic Delays	30
Viewing a Traffic Incident on the Map	30
Understanding Traffic Data	30

**Icons Used in This Manual**

Important precautions are described to prevent injuries and potentially dangerous situations.



Special instructions, supplementary explanations, limitations, and reference pages are described.

# End-User License Agreements

## Software License Agreement

---

BY USING THE DNN992, YOU AGREE TO BE BOUND BY THE TERMS AND CONDITIONS OF THE FOLLOWING SOFTWARE LICENSE AGREEMENT. PLEASE READ THIS AGREEMENT CAREFULLY.

Garmin Ltd. and its subsidiaries ("Garmin") grant you a limited license to use the software embedded in this device (the "Software") in binary executable form in the normal operation of the product. Title, ownership rights, and intellectual property rights in and to the Software remain in Garmin and/or its third-party providers.

You acknowledge that the Software is the property of Garmin and/or its third-party providers and is protected under the United States of America copyright laws and international copyright treaties. You further acknowledge that the structure, organization, and code of the Software, for which source code is not provided, are valuable trade secrets of Garmin and/or its third-party providers and that the Software in source code form remains a valuable trade secret of Garmin and/or its third-party providers. You agree not to decompile, disassemble, modify, reverse assemble, reverse engineer, or reduce to human readable form the Software or any part thereof or create any derivative works based on the Software. You agree not to export or re-export the Software to any country in violation of the export control laws of the United States of America or the export control laws of any other applicable country.

## End User License Agreement

---

The Garmin device you have purchased ("Device"), or the download that you are making (the "Download"), may contain an application, content, or both. If a Device, the software embedded in it (the "Software"), or if a Download, the application, including its embedded software (collectively, the "Application") is owned by Garmin Ltd. or its subsidiaries (collectively, "Garmin"). The map data that may be embedded in your Device, the Application or downloaded separately (the "Map Data") is owned by HERE North America LLC and/or its affiliates ("HERE") and is licensed to Garmin. Garmin also owns, or licenses from third party providers, information, traffic data, text, images, graphics, photographs, audio, video, images and other applications and data that may be embedded in the Device or Application, or downloaded separately ("Other Content"). The Map Data and Other Content are collectively the "Content". The Software, Application and Content (collectively, the "Garmin Products") are protected under copyright laws and international copyright

treaties. The Garmin Products are licensed, not sold. The structure, organization and code of the Software and Application are valuable trade secrets of Garmin and/or its third-party providers. The Garmin Products are each provided under this License Agreement and are subject to the following terms and conditions which are agreed to by End User ("you" or "your"), on the one hand, and Garmin and its licensors and affiliated companies of Garmin and its licensors, on the other hand. Garmin's licensors, including the licensors, service providers, channel partners, suppliers and affiliated companies of Garmin and its licensors, are each a direct and intended third party beneficiary of this Agreement and may enforce their rights directly against you in the event of your breach of this Agreement.

**IMPORTANT:** CAREFULLY READ THIS ENTIRE LICENSE AGREEMENT BEFORE PURCHASING OR USING YOUR DEVICE OR DOWNLOADED APPLICATION OR CONTENT. PURCHASING, INSTALLING, COPYING, OR OTHERWISE USING YOUR DEVICE OR DOWNLOADED APPLICATION OR CONTENT INDICATES YOUR ACKNOWLEDGMENT THAT YOU HAVE READ THIS LICENSE AGREEMENT AND AGREE TO ITS TERMS AND CONDITIONS. IF YOU DO NOT AGREE TO THESE TERMS AND CONDITIONS FOR YOUR PRODUCT, RETURN THE COMPLETE DEVICE WITHIN 7 DAYS OF THE DATE YOU ACQUIRED IT (IF PURCHASED NEW) FOR A FULL REFUND TO THE DEALER FROM WHICH YOU PURCHASED THIS DEVICE. IF YOU DO NOT AGREE TO THESE TERMS AND CONDITIONS FOR YOUR DOWNLOAD, DO NOT PURCHASE, INSTALL OR USE THE DOWNLOAD.

## License Terms and Conditions

Garmin ("we" or "us") provides you with the storage media containing the Software and the Content embedded therein, including any "online" or electronic documentation and printed materials in the case of a Device, or in the case of a Download, the Application and the embedded or accompanying Content, including any "online" or electronic documentation and printed materials. Garmin grants you a limited, non-exclusive license to use the applicable Garmin Product in accordance with the terms of this Agreement. You agree to use the applicable Garmin Product for solely personal use, or if applicable, for use in your business' internal operations, and not for service bureau, time-sharing, resale or other similar purposes. Accordingly, but subject to the restrictions set forth in the following paragraphs,

you may copy the applicable Garmin Product only as necessary for your use to (i) view it, and (ii) save it, provided that you do not remove any copyright notices that appear and do not modify the Garmin Product in any way. Your use of the Application must not violate any usage rules of the Application Vendor or any other third party service provider you use to enable the Application. You agree not to otherwise reproduce, archive, copy, modify, decompile, disassemble, reverse engineer or create derivative works of any portion of the Garmin Products, and may not transfer or distribute it in any form, for any purpose, except to the extent permitted by mandatory laws. Garmin also reserves the right to discontinue offering any Content supplied by any third party supplier if such supplier ceases to supply such content or Garmin's contract with such supplier terminates for any reason.

**Restrictions.** Except where you have been specifically licensed to do so by Garmin, and without limiting the preceding paragraphs, you may not use the Garmin Products with any products, systems, or applications installed or otherwise connected to or in communication with vehicles, and which are capable of dispatch, fleet management or similar applications where the Content is used by a central control center in dispatching a fleet of vehicles. In addition, you are prohibited from renting or leasing the Garmin Products to any other person or third party. Only those rental car companies that are specifically authorized by Garmin in writing to rent Garmin products containing the Content to their rental customers are permitted to rent out such products.

You agree to be fully responsible for your own conduct and content while using the Software and for any consequences thereof. You agree to use the Software only for purposes that are legal, proper and in accordance with this Agreement and any applicable policies or guidelines. By way of example, and not as a limitation, you agree that when using the Software, You will not:

- upload, post, email or transmit or otherwise make available content that infringes any patent, trademark, copyright, trade secret or other proprietary right of any party, unless you are the owner of the rights or have the permission of the owner to post such Content;
- use the Software or other content for any illegal or unauthorized purpose; or
- transmit any viruses, worms, defects, Trojan horses, or any items of a destructive nature.

In the event that you are located outside of the United States, you agree to comply with any laws, rules or regulations in your locale or in the location of your web server regarding online conduct and acceptable content, including laws regulating the export of data to the United States or your country of residence.

**Data Transfer.** Certain services in connection with the Application may result in a transfer of data from your device. In that case, additional charges for data transfer may arise, depending on your device data plan. Please contact your data provider for details about any additional charges.

**No Warranty.** The Garmin Products are provided to you "as is," and you agree to use them at your own risk. Garmin and its licensors including the licensors, service providers, channel partners and suppliers, and affiliated companies of Garmin and its licensors, make no guarantees, representations or warranties of any kind, express or implied, arising by law or otherwise, including but not limited to, content, quality, accuracy, completeness, effectiveness, reliability, merchantability, fitness for a particular purpose, usefulness, use or results to be obtained from the Garmin Products, or that the Content or server will be uninterrupted or error-free. The Garmin Products are intended to be used only as supplementary travel aids and must not be used for any purpose requiring precise measurement of direction, distance, location or topography. GARMIN MAKES NO WARRANTY AS TO THE ACCURACY OR COMPLETENESS OF THE MAP DATA OR OTHER CONTENT.

**Disclaimer of Warranty.** GARMIN AND ITS LICENSORS, including the licensors, service providers, channel partners, suppliers and affiliated companies of Garmin and its licensors, DISCLAIM ANY WARRANTIES, EXPRESS OR IMPLIED, OF QUALITY, PERFORMANCE, MERCHANTABILITY, FITNESS FOR A PARTICULAR PURPOSE OR NON-INFRINGEMENT. NO ORAL OR WRITTEN ADVICE OR INFORMATION PROVIDED BY GARMIN OR ITS SUPPLIERS AND LICENSORS SHALL CREATE A WARRANTY, AND YOU ARE NOT ENTITLED TO RELY ON ANY SUCH ADVICE OR INFORMATION. THIS DISCLAIMER OF WARRANTIES IS AN ESSENTIAL CONDITION OF THIS AGREEMENT. Some States, Territories and Countries do not allow certain warranty exclusions, so to that extent the above



exclusion may not apply to you.

**Disclaimer of Liability.** GARMIN AND ITS LICENSORS, including the licensors, service providers, channel partners, suppliers and affiliated companies of Garmin and its licensors, SHALL NOT BE LIABLE TO YOU: IN RESPECT OF ANY CLAIM, DEMAND OR ACTION, IRRESPECTIVE OF THE NATURE OF THE CAUSE OF THE CLAIM, DEMAND OR ACTION ALLEGING ANY LOSS, INJURY OR DAMAGES, DIRECT OR INDIRECT, WHICH MAY RESULT FROM THE USE OR POSSESSION OF THE GARMIN PRODUCTS; OR FOR ANY LOSS OF PROFIT, REVENUE, CONTRACTS OR SAVINGS, OR ANY OTHER DIRECT, INDIRECT, INCIDENTAL, SPECIAL OR CONSEQUENTIAL DAMAGES ARISING OUT OF YOUR USE OF OR INABILITY TO USE THE GARMIN PRODUCTS, ANY DEFECT IN THE CONTENT OR INFORMATION, OR THE BREACH OF THESE TERMS OR CONDITIONS, WHETHER IN AN ACTION IN CONTRACT OR TORT OR BASED ON A WARRANTY AND WHETHER RESULTING FROM THE USE, MISUSE, OR INABILITY TO USE THE GARMIN PRODUCTS OR FROM DEFECTS OR ERRORS IN THE APPLICATION, EVEN IF GARMIN OR ITS LICENSORS HAVE BEEN ADVISED OF THE POSSIBILITY OF SUCH DAMAGES. GARMIN'S AND ITS LICENSORS' TOTAL AGGREGATE LIABILITY WITH RESPECT TO ITS OBLIGATIONS UNDER THIS LICENSE AGREEMENT OR OTHERWISE WITH RESPECT TO THE APPLICATION OR THE CONTENT SHALL NOT EXCEED \$1.00. Some States, Territories and Countries do not allow certain liability exclusions or damages limitations, so to that extent the above may not apply to you. If you purchased your Application from a third party application vendor, THE SOLE AND MAXIMUM RESPONSIBILITY OF THE APPLICATION VENDOR IN THE EVENT OF A WARRANTY FAILURE IS A REFUND OF THE APPLICATION PURCHASE PRICE.

ANY CONTENT OR MATERIAL DOWNLOADED OR UPLOADED OR OTHERWISE OBTAINED THROUGH THE SOFTWARE IS DONE AT YOUR OWN DISCRETION AND RISK. YOU WILL BE SOLELY RESPONSIBLE FOR ANY DAMAGE TO YOUR ELECTRONIC COMMUNICATION DEVICE OR ANY LOSS OF DATA THAT MAY RESULT FROM THE DOWNLOAD OR UPLOAD OF ANY SUCH CONTENT OR MATERIAL OR THE USE OF THE SOFTWARE.

**Predictive Routing.** Your device may have a "predictive routing" feature called myTrends that identifies your driving routines. If it does have this feature, when your device predicts a route, it will display your estimated time to destination and

relevant traffic information regarding the predicted route. Information related to your driving routines would be accessible to any other person who uses your device. If you do not want your device to predict your routes or display information related to predicted routes, you may turn off myTrends by accessing your device's Settings menu.

**Collection of Information.** We may collect information relating to how often you use the Garmin Product or the frequency with which certain applications and features of the Garmin Product are used. This information would be collected anonymously, in a way that does not personally identify you. We may use this information to detect broad user trends and to otherwise enhance our products or applications. The use of location-based services on the Garmin Product, which may include weather, movie times, traffic information, fuel prices, or information regarding local events, will cause the physical location of your device to be collected in order to provide you with such location-based services. This location data is collected anonymously in a form that does not personally identify you. If you provide your consent then Garmin will collect and upload information such as your location, speed, and direction (known as "traffic probe data" or "floating car data") in order to enhance the quality of the traffic data and other content provided by Garmin or other Content providers. If you provide your consent, then Garmin may also share this data with or sell this data to third parties. This data is shared and sold anonymously in a form that does not personally identify you. The collection and use of this location information are described in more detail in the privacy statement for the Garmin Product.

**Disclaimer of Endorsement; Change of Content Providers.** Reference to any products, services, processes, hypertext links to third parties or other Content by trade name, trademark, manufacturer, supplier or otherwise does not necessarily constitute or imply its endorsement, sponsorship or recommendation by Garmin or its licensors. Product and service information are the sole responsibility of each individual vendor. The HERE name and logo, the HERE and HERE ON BOARD trademarks and logos, and other trademarks and trade names owned by HERE North America LLC may not be used in any commercial manner without the prior written consent of HERE. Content providers may be changed by Garmin during the term of this Agreement, and your experience with the Content provided by a new

provider may not duplicate your experience with the previous Content supplier.

**Export Control.** You agree not to export from anywhere any part of the Content or any direct product thereof except in compliance with and with all licenses and approvals required under, applicable export laws, rules and regulations.

**Legal Compliance.** You represent and warrant that (i) you are not located in a country that is subject to a U.S. Government embargo, or has been designated by the U.S. Government as a “terrorist supporting” country, and (ii) you are not listed on any U.S. Government list of prohibited or restricted parties.

**Indemnity.** You agree to indemnify, defend and hold Garmin and its licensors, including the respective licensors, service providers, channel partners, suppliers, assignees, subsidiaries, affiliated companies, and the respective officers, directors, employees, shareholders, agents and representatives of Garmin and its licensors, free and harmless from and against any liability, loss, injury (including injuries resulting in death), demand, action, cost, expense, or claim of any kind or character, including but not limited to attorney’s fees, arising out of or in connection with any use or possession by you of the Garmin Products.

**Map Data.** Use of the Map Data is subject to certain restrictions and/or requirements imposed by third party suppliers and/or governmental or regulatory authorities as further set forth at [http://corporate.navteq.com/supplier\\_terms.html](http://corporate.navteq.com/supplier_terms.html).

**Term.** This Agreement is effective until such time as (i) if applicable, your subscription term is either terminated (by you or by Garmin) or expires, or (ii) Garmin terminates this Agreement for any reason, including, but not limited to, if Garmin finds that you have violated any of the terms of this Agreement. In addition, this Agreement shall terminate immediately upon the termination of an agreement between Garmin and any third party from whom Garmin (a) obtains services or distribution necessary to support the Garmin Products, or (b) licenses Content. You agree, upon termination, to destroy all copies of the Content. The Disclaimers of Warranty and Liability set out above shall continue in force even after any termination.

**Entire Agreement.** These terms and conditions constitute the entire agreement between Garmin and its licensors, including the licensors, service providers, channel partners, suppliers and affiliated companies of Garmin and its licensors, and you pertaining to the subject matter hereof, and supersedes in their entirety any and all written or oral agreements previously existing between us with respect to such subject matter.

### Governing Law.

(a) For European Union HERE Data

The above terms and conditions shall be governed by the laws of the Netherlands, without giving effect to (i) its conflict of laws provisions, or (ii) the United Nations Convention for Contracts for the International Sale of Goods, which is explicitly excluded. You agree to submit to the jurisdiction of the Netherlands for any and all disputes, claims and actions arising from or in connection with the HERE Data provided to you hereunder.

(b) For North American HERE Data and other non-European Union HERE Data

The above terms and conditions shall be governed by the laws of Illinois, without giving effect to (i) its conflict of laws provisions, or (ii) the United Nations Convention for Contracts for the International Sale of Goods, which is explicitly excluded. You agree to submit to the jurisdiction of Illinois for any and all disputes, claims and actions arising from or in connection with the HERE Data provided to you hereunder.

(c) For disputes, claims and actions not related to the HERE Data

The above terms and conditions shall be governed by the laws of Kansas, without giving effect to (i) its conflict of laws provisions, or (ii) the United Nations Convention for Contracts for the International Sale of Goods, which is explicitly excluded. You agree to submit to the jurisdiction of Kansas for any and all disputes, claims and actions arising from or in connection with the Application or Content. Any translation of this Agreement from English is provided as a convenience only. If this Agreement is translated into a language other than English and there is a conflict of terms between the English version and the other language version, the English version will control.

**Government End Users.** If End User is an agency, department, or other entity of the United States Government, or funded in whole or in part by the U.S. Government, then use, duplication, reproduction, release, modification, disclosure or transfer of the Application and accompanying documentation is subject to restrictions as set forth in DFARS 252.227-7014(a)(1) (JUN 1995) (DOD commercial computer software definition), DFARS 27.7202-1 (DOD policy on commercial computer software), FAR 52.227-19 (JUN 1987) (commercial computer software clause for civilian agencies), DFARS 252.227-7015 (NOV 1995) (DOD technical data – commercial items clause); FAR 52.227-14 Alternates I, II, and III (JUN 1987) (civilian agency technical data and noncommercial computer software clause); and/or FAR 12.211 and FAR 12.212 (commercial item acquisitions), as applicable. In case of conflict between any of the FAR and DFARS provisions listed herein and this License Agreement, the construction that provides greater limitations on the Government's rights shall control. The contractor/manufacture is Garmin International, Inc., 1200 East 151st Street, Olathe, Kansas 66062, USA and HERE North America LLC, 425 West Randolph Street, Chicago, Illinois 60606 USA.

Garmin® is a trademark of Garmin Ltd. or its subsidiaries, registered in the USA and other countries. These trademarks may not be used without the express permission of Garmin.

HERE is a trademark in the U.S. and other countries. All other company names and trademarks mentioned or referenced in this documentation are the properties of their respective owners. All rights reserved.

Additional Terms and Privacy Policy for Location Platform Services. If your Application is provided access to Location Platform Services, by accessing such Location Platform Services you agree to application of the Nokia Terms of Service at <http://here.com/services/terms> and the Nokia Privacy Policy at <http://www.nokia.com/global/privacy/privacy/policy/privacy-policy/>.



# Getting Started

The first time you use your Kenwood Navigation System, you need to set up your system. The Help menu provides additional information.

## **⚠ WARNING**

See "Safety Precautions and Important Information" in the *Quick Start Guide* for product warnings and other important information.



- The screenshots shown in this manual may not exactly match the screens on your navigation system. The images used in this manual are intended for reference only.

## **Using the Navigation System**

For complete audio system information, see the other Kenwood system manuals.



- Select ① to access the navigation system.
- When navigating, ② displays Kenwood audio. When using audio, this displays navigation information.

## **Help When You Need It**



**Select Apps > Help to view information about using the device.**

## **Searching Help Topics**

**Select Apps > Help > .**

## **Status Bar Icons**

The status bar is located at the top of the main menu. The status bar icons display information about features on the device. You can select some icons to change settings or view additional information.

	GPS signal status
	Current time

## Satellite Signals







After your vehicle is turned on, the navigation system begins acquiring satellite signals. The system may need a clear view of the sky to acquire satellite signals. When at least one of the  bars is green, your system has acquired satellite signals.

## Viewing GPS Satellite Signals

For more information about GPS, go to [www.garmin.com/aboutGPS](http://www.garmin.com/aboutGPS).

Select .

## Using the On-Screen Buttons





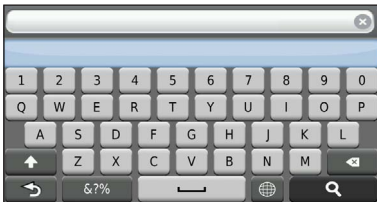

- Select  to return to the main menu.
- Hold  to quickly return to the main menu.
- Select  or  to see more choices.
- Hold  or  to scroll faster.
- Select  to see a menu of options for the current screen.

## Using the On-Screen Keyboard

See Language Settings to change the keyboard layout ([page 32](#)).

**When an on-screen keyboard appears, select a letter or a number to enter it.**



- Select  to add a space.
- Select  to delete a character.
- Select  to erase the entire entry.
- Select  to select the keyboard language mode.
- Select  to enter special characters, such as punctuation marks.
- Select  to change character capitalization.

## Adding a Shortcut

You can add shortcuts to the Where To? menu. A shortcut can point to a location, a category, or a search tool. The Where To? menu can contain up to 36 shortcut icons.

- 1 Select **Where To? > Add Shortcut**.
- 2 Select an item.

## Removing a Shortcut

- 1 Select **Where To >  > Remove Shortcut(s)**.
- 2 Select the shortcut to remove.
- 3 Select the shortcut again to confirm.

# Finding Locations

The navigation system offers many methods for finding locations. The detailed maps loaded in your navigation system contain locations, such as restaurants, hotels, and auto services. You can use categories to browse for nearby businesses and attractions.

## Finding a Location by Category

- 1 Select Where To?.
- 2 Select a category, or select Categories.
- 3 If necessary, select a subcategory.
- 4 Select a location.

## Searching Within a Category

To narrow your search results, you can search within some categories.

- 1 Select Where To?.
- 2 Select a category, or select Categories.
- 3 If necessary, select a subcategory.
- 4 If necessary, enter all or part of the name in the search bar (page 12).

## Finding a Location Using the Search Bar

You can use the search bar to search for locations by entering a category, brand name, address, or city name.

- 1 Select Where To?.
- 2 Select the search bar ①.

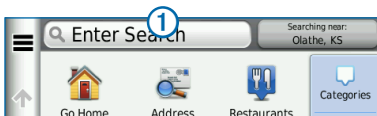

- 3 Enter a search term.

Suggested search terms appear below the search bar as you type.

- 4 Select an option:

- To search for a type of business, enter a category name, such as “movie theaters.”
- To search for a business by name, enter all or part of the name.
- To search for an address near you, enter the street number and street name.
- To search for an address in another city, enter the street number, street name, city, and state.
- To search for a city, enter the city and state.
- To search for coordinates, enter latitude and longitude coordinates.

- 5 Select an option:

- To search using a suggested search term, select the term.
- To search using the text you entered, select .

- 6 If necessary, select a location.

## Changing the Search Area

By default, your device finds locations closest to your current location. You can find a location near another city or location.

- 1 Select Where To? > Searching Near.

- 2 Select an option.

- 3 If necessary, select a location.

## Finding Fuel Stations and Prices

Before you can use this feature, you must subscribe to the Fuel Price service, and your device must be connected via Wi-Fi to access connected services. This feature is not available in all areas.

You can find nearby fuel stations and compare fuel prices.

- 1 Select **Apps > Fuel Prices**.
- 2 If necessary, select  **> Fuel Type**, select a fuel type, and select **Save**.
- 3 Select a fuel station.

## Finding an Address



• The order of the steps may change depending on the map data loaded on your device.

- 1 Select **Where To? > Address**.
- 2 Enter the address number, and select **Done**.
- 3 Enter the street name, and select **Next**.
- 4 If necessary, select **Searching In** to change the city, state, or province.
- 5 If necessary, select the city, the state, or the province.
- 6 If necessary, select the address.

## Finding a City

Before you can find a city, you must add a shortcut to the cities search tool ([page 11](#)).

- 1 Select **Where To? > Cities**.
- 2 Select **Enter Search**.
- 3 Enter a city name, and select .
- 4 Select a city.

## Finding an Intersection

Before you can find an intersection, you must add a shortcut to the intersection search tool ([page 11](#)).

- 1 Select **Where To? > Intersections**.
- 2 Select a state or province.  
  
If necessary, select **State or Country** to change the country, state, or province.
- 3 Enter the first street name, and select **Next**.
- 4 If necessary, select the street.
- 5 Enter the second street name, and select **Next**.
- 6 If necessary, select the street.
- 7 If necessary, select the intersection.



### Finding a Location Using Coordinates

Before you can find a location using coordinates, you must add a shortcut to the coordinates search tool (page 11).

You can find a location using latitude and longitude coordinates. This can be helpful when geocaching.

- 1 Select Where To? > Coordinates.
- 2 If necessary, select  > Format, select the correct coordinate format for the type of map you are using, and select Save.
- 3 Select the latitude coordinate.
- 4 Enter the new coordinate, and select Done.
- 5 Select the longitude coordinate.
- 6 Enter the new coordinate, and select Done.
- 7 Select View on Map.

### Finding a Location by Browsing the Map

Before you can find places included in the map data, such as restaurants, hospitals, and fuel stations, you must enable the map layer for places along the road (page 22).

- 1 Select View Map.
- 2 Drag and zoom the map to display the area to search.
- 3 If necessary, select , and select a category icon to view only a specific category of places.

Location markers  (or a blue dot) appear on the map.

- 4 Select an option:
  - Select a location marker.
  - Select a point, such as a street, intersection, or address location.
- 5 If necessary, select the location description to view additional information.

### Finding a Location Using Quick Search

After you have performed a search for a point of interest, certain categories may display a Quick Search list that displays the last four destinations you selected.

- 1 Select Where To?.
- 2 Select a category, or select Categories.
- 3 If applicable, select a destination from the Quick Search list .



- 4 If necessary, select the appropriate destination.

### Saving a Home Location

You can set your home location for the location you return to most often.

- 1 Select Where To? >  > Set Home Location.
- 2 Select Enter My Address, Use My Current Location, or Choose from Recently Found.

The location is saved as “Home” in the Saved menu.

## Going Home

Select Where To? > Go Home.

## Editing Your Home Location Information

1 Select Where To? > Saved > Home.

2 Select  >  > Edit.

3 Enter your changes.

4 Select Done.

## Finding Recently Found Places

Your device stores the last 50 locations you have found.

1 Select Where To? > Recent.

2 Select a location.

## Clearing the List of Recently Found Places

Select Where To? > Recent >  > Clear > Yes.

## Finding Parking

1 Select Where To? > Categories > Parking.

2 Select a parking location.

## Setting a Simulated Location

If you are not receiving satellite signals, you can use the GPS to set a simulated location.

1 Select Settings > Navigation.

2 Select GPS Simulator.

3 From the main menu, select View Map.

4 Select an area on the map.

The address of the location appears at the bottom of the screen.

5 Select the location description.

6 Select Set Location.

## Saving a Location

1 Search for a location ([page 12](#)).

2 From the search results, select a location.

3 Select .

4 Select  > Save.

5 If necessary, enter a name, and select OK.

## Saving Your Current Location

1 From the map, select the vehicle icon.

2 Select Save.



3 Enter a name, and select Done.

4 Select OK.

### Starting a Route to a Saved Location

- 1 Select **Where To? > Saved**.
- 2 If necessary, select a category, or select **All Saved Places**.
- 3 Select a location.
- 4 Select **Go!**.

### Editing a Saved Location



- 1 Select **Where To? > Saved**.
- 2 If necessary, select a category.
- 3 Select a location.
- 4 Select .
- 5 Select  **> Edit**.
- 6 Select an option:
  - Select **Name**.
  - Select **Phone Number**.
  - To assign categories to the Favorite, select **Categories**.
  - To change the symbol used to mark the Favorite on a map, select **Change Map Symbol**.
- 7 Edit the information.
- 8 Select **Done**.

### Assigning Categories to a Saved Location

You can add custom categories to organize your saved locations.



- Categories appear in the saved locations menu after you have saved more than 12 locations.

- 1 Select **Where To? > Saved**.
- 2 Select a location.
- 3 Select .
- 4 Select  **> Edit > Categories**.
- 5 Enter one or more category names, separated by commas.
- 6 If necessary, select a suggested category.
- 7 Select **Done**.

### Deleting a Saved Location



- Deleted locations cannot be recovered.

- 1 Select **Where To? > Saved**.
- 2 Select  **> Delete Saved Places**.
- 3 Select the box next to the saved locations to delete, and select **Delete**.

# Voice Command

Voice Command allows you to use your device by saying words and commands. The Voice Command menu provides voice prompts and a list of available commands.



- Voice Command is not available for all languages and regions.

## Voice Command Tips

- Speak in a normal voice directed at the device.
- Reduce background noise, such as voices or the radio, to increase the accuracy of the voice recognition.
- Speak commands as they appear on the screen.
- Respond to voice prompts from the device as needed.
- Listen for two tones to confirm when the device enters and exits Voice Command mode.

## Starting a Route Using Voice Command

You can say the names of popular, well-known locations.

- 1 Press the Voice Command button.
- 2 Say Find Place.

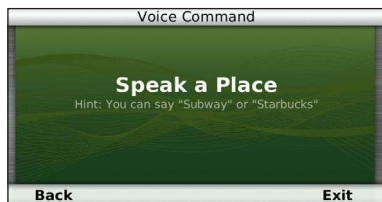

- 3 Listen for the voice prompt, and speak the name of the location.  
A list of locations appears.



- 4 Say the line number.



- 5 Say Navigate.

## Finding an Address

- 1 Press Voice Command button.
- 2 Say Find Address.
- 3 Speak the entire address.

# Navigation

You can create, customize, and edit your routes.

## Starting a Route

- 1 Search for a location (page 12).
- 2 Select a location.
- 3 Select Go!.
- 4 If necessary, select a route.

## Previewing Multiple Routes

- 1 Search for a location (page 12).
- 2 From the search results, select a location.
- 3 Select Routes.
- 4 Use the on-screen buttons to select a route.
- 5 Select Go!.

## Following a Route

The route is marked with a magenta line. A checkered flag marks your destination.

As you travel, the device guides you to the destination with voice prompts, arrows on the map, and directions at the top of the map. If you depart from the original route, the device recalculates the route and provides new directions.



## Using the Navigation Map

- 1 From the main menu, select View Map.
- 2 If the zoom controls are hidden, select the map to display the zoom controls.
- 3 Select the map to switch to browsing mode.

Map buttons appear.

- 4 Select an option:
  - To zoom in or out, select or .
  - To rotate the map view, select .
  - To switch between North Up and 3-D views, select .
  - To add or remove map layers, select .
  - To view specific location categories, select and select a category icon.
  - To center the map on your current location, select .
  - To view shortcuts for map and navigation features, select .

## Using Multi-touch Controls

You can use multi-touch controls to change the map view while using the navigation map.

- Pinch two fingers together on the screen to zoom out.
- Spread two fingers on the screen to zoom in.

## Adding a Point to a Route

- 1 While navigating a route, select  to return to the main menu.
- 2 Select Where To?.
- 3 Search for the location (page 12)
- 4 Select Go!.
- 5 Select Add to Active Route.

## Taking a Detour

While navigating a route, you can use detours to avoid obstacles ahead of you, such as construction zones.



- If the route you are currently navigating is the only reasonable option, your device might not calculate a detour.

From the map, select  > Detour.

## Stopping the Route

From the map, select .

## Using Suggested Routes

Before you can use this feature, you must save at least one location and enable the travel history feature (page 15).

Using the myTrends™ feature, your device predicts your destination based on your travel history, the day of the week, and the time of day. After you have driven to a saved location several times, the location may appear in the navigation bar on the map, along with the estimated time of travel, and traffic information.

Select the navigation bar to view a suggested route to the location.





## Using Exit Services



- You must be on a major highway or road to use Exit Services.

While navigating a route, you can find gas, food, lodging, and restrooms near upcoming exits.



Services are listed under tabs by category.

	Gas
	Food
	Lodging
	Restrooms

## Finding Exit Services



- 1 From the map, select  > Exit Services.
- 2 Use the arrows to select an upcoming exit.
- 3 Select an exit service tab.
- 4 Select a point of interest.

### Navigating to an Exit

- 1 From the map, select  > Exit Services > .
- 2 Select an exit service.
- 3 Select Go!.

### Using Find Ahead

When upcoming exits do not have needed services, you can search farther ahead on your route.

- 1 While navigating a route, from the map, select  > Exit Services.
- 2 Select an exit service tab that does not have an upcoming service match.
- 3 Select Find Ahead.
- 4 Select  >  to see more exits.
- 5 Select a service.
- 6 Select Go!

### Avoiding Road Features

- 1 Select Settings > Navigation > Avoidances.
- 2 Select the road features to avoid on your routes, and select Save.

### Adding a Custom Avoidance Area

Custom avoidances allow you to avoid specific areas and sections of road. You can enable and disable custom avoidances as needed.

- 1 Select Settings > Navigation > Custom Avoidances.
- 2 If necessary, select Add Avoidance.
- 3 Select Add Avoid Area.
- 4 Select the upper-left corner of the area to avoid, and select Next.
- 5 Select the lower-right corner of the area to avoid, and select Next.  
  
The selected area is shaded on the map.
- 6 Select Done.

### Avoiding a Road

- 1 Select Settings > Navigation > Custom Avoidances.
- 2 Select Add Avoid Road.
- 3 Select the starting point of the section of road to avoid, and select Next.
- 4 Select the ending point of the road section, and select Next.
- 5 Select Done.

### Disabling a Custom Avoidance



You can disable a custom avoidance without deleting it.

- 1 Select Settings > Navigation > Custom Avoidances.
- 2 Select an avoidance.
- 3 Select  > Disable.

## Deleting Custom Avoidances

**1** Select **Settings > Navigation > Custom Avoidances**.

**2** Select an option:

- To delete all custom avoidances, select .
- To delete one custom avoidance, select the avoidance, and select  > **Delete**.

## Enabling Advanced Detours

Select **Settings > Navigation > Advanced Detours**.

## Taking a Detour Around Specified Areas

You can take a detour for a specified distance along your route or detour around specific roads. This is useful if you encounter construction zones, closed roads, or poor road conditions.

**1** Select a destination, and select **Go!** ([page 12](#)).

**2** From the map, select  > **Detour**.

**3** Select **Next .5mi on Route, Next 2mi on Route, Next 5mi on Route, or Detour by Road(s) on Route**.

**4** If necessary, select a road to detour around.



# The Map Pages

You can customize which data appear on the map and view upcoming turns and current location information.

## Customizing the Map Layers

You can customize which data appear on the map, such as icons for points of interest and road conditions.

- 1 From the map, select .
- 2 Select Map Layers.
- 3 Select which layers you want to include on the map, and select Save.

## Viewing the Trip Log

Your device keeps a trip log, which is a record of the path you have traveled.

- 1 Select Settings > Map & Vehicle > Map Layers.
- 2 Select the Trip Log check box.

## Changing the Map Data Field

- 1 From the map, select the data field in the lower left-hand corner.
- 2 Select a type of data to display.
- 3 Select Save.

## Changing the Map Perspective

- 1 Select Settings > Map & Vehicle > Driving Map View.
- 2 Select an option:
  - Select Track Up to display the map in two dimensions (2-D), with your direction of travel at the top.
  - Select North Up to display the map in 2-D with North at the top.
  - Select 3-D to display the map in three dimensions.

## Customizing Map Buttons

You can include up to three icons on the right side of the main map.

- 1 Select Settings > Map & Vehicle > Map Buttons.
- 2 Select an icon, and select OK.
- 3 Select .
- 4 Select a different icon.

## Removing Buttons from the Map

You can remove all buttons from the right side of the map.

- 1 Select Settings > Map & Vehicle > Map Buttons.
- 2 Select an icon, and touch OK.
- 3 Select Save.

## Viewing a List of Turns

When you are navigating a route, you can view all of the turns and maneuvers for your entire route and the distance between turns.

- 1 Select the text bar on the top of the map.
- 2 Select a turn.



The details for the turn appear. If available, an image of the junction appears for junction on major roadways.

## Viewing the Entire Route on the Map

- 1 While navigating a route, select the navigation bar at the top of the map.
- 2 Select  > Map.

## Viewing the Next Turn

While navigating a route, a preview of the next turn, lane change, or other maneuver appears in the upper-left corner of the map.

The preview includes the distance to the turn or maneuver and the lane in which you should be traveling, if available.

From the map, select  to view the next turn on the map.

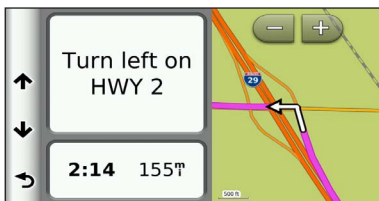

## Viewing Junctions

While navigating a route, you can view the junctions on major roadways. When you approach a junction in a route, the image of that junction appears briefly, if available.

From the map, select  to view the junction, if available.



## Viewing Traffic Alerts

While you navigate a route, a traffic alert may appear.

Select the alert to view more information.

## Viewing Trip Information

The trip information page displays your present speed and provides statistics about your trip.

From the map, select  > Trip Computer.



### Resetting Trip Information

**1** From the map, select  > Trip Computer.

**2** Select  > Reset All.

**3** Select an option:

- When not navigating a route, select **Select All** to reset every data field, except the speedometer, on the page.
- Select **Reset Trip Data** to reset the information on the trip computer.
- Select **Reset Max. Speed** to reset the maximum speed.
- Select **Reset Trip B** to reset the odometer.

### Viewing Current Location Information

You can use the Where Am I? page to view information about your current location. This feature is helpful if you need to tell emergency personnel your location.

From the map, select  > Where Am I?.

### Finding Nearby Services

You can use the Where Am I? page to find nearby services, such as hospitals or police stations.

**1** From the map, select  > Where Am I?.

**2** Select a category.

### Directions to Your Current Location

If you need to tell another person how to get to your current location, your device can give you a list of directions.

**Select Apps > Where Am I? >  > Directions to Me.**

# Using the Apps

The Apps on your navigation system provide access to trip planning, fuel reports, and connected services.

## About the Apps

The Apps on your navigation system provide access to premium connectivity like Real-time Traffic, Fuel Prices, Dynamic Parking, Real-Time Traffic Camera, Movie Times and more. The coverage of these services depends on availability in your region. For details, see other Kenwood system manuals.

## About ecoRoute

The ecoRoute feature calculates your vehicle fuel economy, carbon footprint, and the fuel price of navigating to a destination, and offers tools for improving fuel efficiency.

The data provided by the ecoRoute feature is only an estimate. The data is not actually read from your vehicle. To receive more-accurate fuel reports for your specific vehicle and driving habits, calibrate the fuel economy.

## Creating a Vehicle Profile

The vehicle profile provides a basis for ecoRoute to calculate your vehicle fuel economy.

- 1 **Select Apps > ecoRoute™.**
- 2 **Enter the required information, and select Next.**
- 3 **Select Done.**

## Resetting Your Vehicle Profile

- 1 **Select Apps > ecoRoute™ > Vehicle Profile.**
- 2 **Select Reset.**

## Calibrating Fuel Economy

Use this feature when you refuel to maintain an accurate fuel economy.

- 1 **Select Apps > ecoRoute™ > At the Pump.**
- 2 **Enter the current fuel price.**
- 3 **Enter how much fuel your vehicle has used since the last fill up.**
- 4 **Enter the distance you have traveled since the last fill up.**
- 5 **Select Next.**

## Taking the ecoChallenge

The ecoChallenge helps you maximize your fuel economy by scoring your driving habits. The higher your ecoChallenge scores, the more fuel you save. The ecoChallenge collects data and calculates a score whenever you are moving.

The ecoChallenge  icon displays your current score on the map.

**Select Apps > ecoRoute™ > ecoChallenge.**



- To view detailed ecoChallenge scores, select the icon. The leaf color on the driving challenge icon changes depending on your performance in the challenge.

### About ecoChallenge Scores

- **Overall**—a combination of the speed, acceleration, and braking score.
- **Speed**—gain points for driving at your vehicle optimal speed for conserving fuel (45–60 mph for most vehicles).
- **Acceleration**—gain points for smooth acceleration; lose points for rapid acceleration.
- **Braking**—gain points for smooth braking; lose points for hard braking.

### Hiding Your ecoChallenge Score

- 1 Select **Settings > Map & Vehicle > Map Buttons**.
- 2 Select .
- 3 Select **OK**.

### Resetting Your Score

You can restart your current ecoChallenge.

- 1 Select **Apps > ecoRoute > ecoChallenge**.
- 2 Select  **> Reset**.
- 3 Select **Yes**.

### Viewing Your Fuel Economy

- 1 Select **Apps > ecoRoute™ > Fuel Economy**.

The graph along the bottom shows your average fuel economy for a period of driving time.

- 2 Select a section of the graph to zoom in.
- 3 Select **Reset** to clear the fuel economy data.

### About the Mileage Report

A mileage report tracks the distance, the time, the average fuel economy, and the fuel cost of navigating to a destination.

A mileage report is created for every route that you drive. If you stop a route on the device, a mileage report is created for the distance you traveled.

Mileage reports are created automatically when you stop or complete routes.

### Viewing a Mileage Report

You can view the 20 most-recent mileage reports.

- 1 Select **Apps > ecoRoute™ > Mileage Report**.
- 2 Select a report.

To reset all report data, select **Reset**.

## Exporting a Mileage Report

- 1 Connect a USB mass storage device to your Kenwood unit.
- 2 Select **Apps > ecoRoute > Mileage Report**.
- 3 Select **Export** to export and save the reports to the USB mass storage device.

## Setting Routes that Use Less Fuel

- 1 Select **Settings > Navigation > Calculation Mode**.
- 2 Select **Less Fuel**.

## Planning a Trip

You can use the trip planner to create and save a trip with multiple destinations.

- 1 Select **Apps > Trip Planner**.
- 2 Select **New Trip**.
- 3 Select **Select Start Location**.
- 4 Search for a location ([page 12](#)).
- 5 Select **Select**.
- 6 To add additional locations, select **+**.
- 7 Select **Next**.
- 8 Enter a name, and select **Done**.

## Editing a Trip Itinerary

- 1 Select **Apps > Trip Planner**.
- 2 Select a saved trip.
- 3 Select an option:
  - To change the arrival or departure time, select a location in the trip.
  - To record how long you will stay at a location, select a location in the trip, and select **Duration**.
  - To view the trip on the map, select **Map**.

## Navigating to a Saved Trip

- 1 Select **Apps > Trip Planner**.
- 2 Select a saved trip.
- 3 Select **Go!**.
- 4 If prompted, select a route.

## Editing a Saved Trip

- 1 Select **Apps > Trip Planner**.
- 2 Select a saved trip.
- 3 Select **≡**.
- 4 Select an option:
  - Select **Rename Trip**.
  - Select **Edit Destinations** to add and delete locations, or to change the order of locations.
  - Select **Delete Trip**.
  - Select **Optimize Order** to arrange the stops on your trip in the most-efficient order.

### Importing Routes

Trip Planner and the KENWOOD Route Collector site can share information for up to 10 routes. You must have an active internet connection to share routes.

- 1 With an active internet connection, select Apps > Trip Planner.**
- 2 Select an option.**
  - Select No to use a locally saved route.
  - Select Yes to upload and use a route from the KENWOOD Route Collector site.

### Viewing Previous Routes & Destinations

Before you can use this feature, you must enable the travel history feature ([page 32](#)).

You can view your previous routes and places you have stopped on the map.

Select Apps > Where I've Been.

### Using the World Clock

- 1 Select Apps > World Clock.**
- 2 If necessary, select a city, enter a city name, and select Done.**

### Viewing the World Map

Select Apps > World Clock > .

Nighttime hours appear in the shaded area of the map.

### Using Dynamic Parking

Before you can use this feature, you must subscribe to the Dynamic Parking service, and your device must be connected via Wi-Fi to access connected services. This feature is not available in all areas.

- 1 Select Apps > Dynamic Parking.**
- 2 Select a parking location.**

### About myCameras

Before you can use this feature, you must subscribe to the myCameras service, and your device must be connected via Wi-Fi to access connected services. This feature is not available in all areas.

Traffic cameras provide live images of traffic conditions on major roadways and intersections. You can save cameras that you want to view regularly.

- 1 Select Apps > myCameras.**
- 2 Select Touch to Add.**
- 3 Select a road or an intersection.**
- 4 Select Save.**

### Using Movie Time

Before you can use this feature, you must subscribe to the Movie Time service, and your device must be connected via Wi-Fi to access connected services. This feature is not available in all areas.

- 1 Select Apps > Movie Times.**
- 2 Select  > Select Day.**
- 3 Select a Movie Title or Theater Name.**

# Traffic Information

Using the built-in receiver, the navigation system can receive and use traffic information. When a traffic message is received, you can see the event on the map and change your route to avoid the traffic incident. Traffic information is not available on all models or in all areas.

## NOTICE

Garmin and JVC KENWOOD is not responsible for the accuracy or timeliness of the traffic information.

Traffic information may not be available in all areas or countries.

## Traffic Subscription Activation

You can purchase traffic subscriptions for regions or countries. Go to [www.garmin.com/kenwood](http://www.garmin.com/kenwood) for more information.

## Understanding Traffic

Your navigation system can receive traffic information using the built-in traffic receiver or a subscription to INRIX Traffic Service. The traffic receiver must be in data range of a station transmitting traffic data to receive traffic information. The traffic subscription activates automatically after your navigation system acquires satellite signals while receiving traffic signals from the service provider. You can add other subscriptions at any time. For information about traffic receivers and coverage areas, go to [www.garmin.com/kenwood](http://www.garmin.com/kenwood).

## Traffic Data Using INRIX Traffic Service

You can purchase a traffic subscription to receive traffic data using INRIX Traffic Service. When your navigation system is connected to INRIX and within a traffic coverage area, your system will begin displaying traffic information. Traffic data is not available in all areas or regions.

See the **KENWOOD Route Collector** site for **INRIX traffic subscription information**. Go to [www.kenwood-drive.com](http://www.kenwood-drive.com).

## About the Traffic Icon

When you are receiving traffic information, a traffic icon appears on the Map. The traffic icon changes color to indicate the severity of traffic conditions.

Color	Description	Meaning
Green	Low severity	Traffic is flowing normally.
Yellow	Medium severity	Traffic is slightly congested.
Red	High severity	Traffic is heavily congested or stopped.
Gray	No data	Traffic data has not updated.



### Traffic on Your Route

When calculating your route, the navigation system examines the current traffic and automatically optimizes the route for the shortest time. If a severe traffic delay occurs on your route while you are navigating, your navigation system automatically recalculates the route.

The traffic icon  changes color to indicate the severity of traffic conditions on your route or on the road you are currently traveling.

Your navigation system may route you through a traffic delay if a better alternative route does not exist. The delay time is added into your estimated time of arrival automatically.

### Viewing Traffic on Your Route

1 While navigating a route, select .

2 Select Traffic on Route.

A list of traffic events appears, organized by their location on the route.

3 Select an event.

### Manually Avoiding Traffic on Your Route

1 From the map, select .

2 Select Traffic On Route.

3 If necessary, use the arrows to view other traffic delays on your route.

4 Select  > Avoid.

### Taking an Alternate Route

1 While navigating an automobile route, select .

2 Select Alternate Route.

3 Select a route.

### Viewing Traffic on the Map

The traffic map shows color-coded traffic flow and delays on nearby roads.

1 From the map, select .

2 Select Traffic Conditions.

### Searching for Traffic Delays

1 From the map, select .

2 Select Traffic Conditions > .

3 Select an item in the list.

4 If there is more than one delay, use the arrows to view additional delays.

### Viewing a Traffic Incident on the Map

1 From the map, select .

2 Select Traffic Conditions.

3 Select a traffic icon.

### Understanding Traffic Data

The traffic legend explains the icons and colors used on the traffic map.

1 From the map, select .

2 Select Traffic Legend.

# Customizing the Settings

You can customize the settings of your GPS navigation system.

## Customizing the Navigation System

- 1 **Select Settings.**
- 2 **Select a setting category.**
- 3 **Select the setting to change it.**

## Changing the Map Settings

### Select Settings > Map & Vehicle.

- **Vehicle**—select **Change** to change the icon used to display your position on the map. Select the icon you want to use, and select **Save**.
- **Driving Map View**—select a map perspective.
- **Map Detail**—adjust the amount of detail shown on the map. More detail may cause the map to redraw slower.
- **Map theme**—changes the color of the map data.
- **Map Buttons**—Sets which icons are included on the map. Up to three icons can be included on the map.
- **Map Layers**—Sets the data that appears on the map.
- **Dashboards**—Sets the map dashboard layout.
- **myMaps**—Sets which installed maps the device uses.

## Enabling Maps

- 1 **Select Settings > Map & Vehicle > myMaps.**
- 2 **Select a map.**

## Changing the Navigation Settings

### Select Settings > Navigation.

- **Calculation Mode**—sets route preference.
- **Avoidances**—sets road features to avoid on a route.
- **Custom Avoidances**—allows you to avoid specific roads or areas.
- **Advanced Detours**—sets the length of a detour.
- **Safe Mode**—disables all functions that require significant operator attention and could become a distraction while driving.
- **GPS Simulator**—stops the device from receiving a GPS signal, and saves battery power.

## Adjusting the Display Settings

### Select Settings > Display.

- **Color Mode**—select **Day** for a light background, **Night** for a dark background, or **Auto** to automatically switch between the two.

## Route Preferences

### Select Settings > Navigation > Calculation Mode.

The route calculation is based on road speeds and vehicle acceleration data for a given route.

- **Faster Time**—calculates routes that are faster to drive but can be longer in distance.
- **Shorter Distance**—calculates routes that are shorter in distance but can take more time to drive.
- **Less Fuel**—calculates routes that could use less fuel than other routes.

### Updating the Time Settings

#### Select Settings > Units & Time.

- **Current Time**—select **Automatic** to update the time automatically. When Automatic is not selected, you can adjust the time in 15-minute increments.
- **Time Format**—select a 12-hour, 24-hour, or UTC time format.
- **Units**—sets the unit of measure used for distances.

### Setting the Languages

#### Select Settings > Language & Keyboard.

- **Voice Language**—select a voice for the voice prompts.
- **Keyboard Language**—sets the language for your keyboard.
- **Keyboard Layout**—sets the keyboard layout.

### Adding Security

#### Select Settings > Navigation > Safe Mode.

- **Safe Mode**—turn safe mode on or off. When your vehicle is moving, safe mode disables all functions that require significant operator attention and could become a distraction while driving.

### Device and Privacy Settings

#### Select Settings > Device.

- **About**—displays the software version number, the unit ID number, and information on several other software features.



- You need this information when you update the system software or purchase additional map data ([page 33](#)).
- **Travel History**—allows the device to record information for the myTrends ([page 19](#)), Where I've Been ([page 28](#)) and Trip Log features.
- **Clear Travel History**—clears all travel history for the myTrends ([page 19](#)), Where I've Been ([page 28](#)) and Trip Log features.

### Restoring Settings

You can restore a category of settings or all settings to the factory default values.

- 1 **Select Settings.**
- 2 **If necessary, select a settings category.**
- 3 **Select  > Restore.**

# Appendix

This appendix provides additional information about your navigation system, such as how to update the software and map data.

## Updating the Software

Before you can update the navigation system software, you must have a USB mass storage device and an Internet connection.

- 1 Go to [www.garmin.com/kenwood](http://www.garmin.com/kenwood).
- 2 Select **Update**.
- 3 Follow the on-screen instructions.

## Updating the Map Data

You can purchase updated map data from Garmin or ask your Kenwood dealer or Kenwood service center for details.

- 1 Go to [www.garmin.com/kenwood](http://www.garmin.com/kenwood).
- 2 Select **Update**.
- 3 Follow the on-screen instructions.

## Safety Cameras

### WARNING

Garmin and JVC KENWOOD are not responsible for the accuracy of, or the consequences of using, a safety camera database.

Safety camera information is available in some locations. Go to <http://my.garmin.com> for availability. For these locations, the navigation system includes the locations of hundreds of safety cameras. Your navigation system alerts you when you are approaching a safety camera and can warn you if you are driving too fast. The data is updated at least weekly, so you always have access to the most up-to-date information.

You can purchase a new region or extend an existing subscription at any time. Each region that you purchase has an expiration date.

## Custom POIs (Points of Interest)

You can manually load custom points of interest (POI) databases, available from various companies on the Internet. Some custom POI databases contain alert information for points such as safety cameras and school zones. The navigation system can notify you when you approach one of these points. You are responsible for ensuring that your use of safety camera information is lawful in your area.

### WARNING

Garmin and JVC KENWOOD are not responsible for the consequences of using custom POI databases, or for the accuracy of custom POI databases.

After downloading your POI database, use the Garmin POI Loader to install the POIs onto a USB mass storage device. Use the USB mass storage device to load the POIs. The POI Loader is available at [www.garmin.com/products/poiloader](http://www.garmin.com/products/poiloader). Refer to the POI Loader Help file for more information; click **Help** to open the Help file.



- Each time you load custom POIs to the navigation system, any other custom POIs already saved in the system will be overwritten.

## Finding Custom POIs

- 1 Select **Where To? > Categories > Custom POIs**.
- 2 Select a category.

For the latest free software updates (excluding map data) throughout the life of your Garmin products, visit the Garmin Web site at [www.garmin.com/kenwood](http://www.garmin.com/kenwood).



© 2015 Garmin Ltd. or its subsidiaries

Garmin International, Inc.  
1200 East 151st Street, Olathe, Kansas 66062, USA

Garmin (Europe) Ltd.  
Liberty House, Hounsdown Business Park, Southampton, Hampshire, SO40 9LR, UK

Garmin Corporation  
No. 68, Zhangshu 2<sup>nd</sup> Road, Xizhi Dist., New Taipei City, 221, Taiwan (R.O.C.)

[www.garmin.com](http://www.garmin.com)

Part Number 190-01811-00 Rev. A

Garmin® and the Garmin logo are trademarks of Garmin Ltd. or its subsidiaries, registered in the USA and other countries. ecoRoute™, myTrends™, and trafficTrends™ are trademarks of Garmin Ltd. or its subsidiaries. These trademarks may not be used without the express permission of Garmin. HERE is a trademark in the U.S. and other countries. The Bluetooth® word mark and logos are owned by the Bluetooth SIG, Inc. and any use of such marks by Garmin is under license. All other company names and trademarks mentioned or referenced in this documentation are the properties of their respective owners. All rights reserved.

## IC (Industry Canada) Notice

This device complies with Industry Canada licence-exempt RSS-210 standard(s).

Operation is subject to the following two conditions:

(1) This device may not cause interference, and (2) this device must accept any interference, including interference that may cause undesired operation of the device.

The term "IC:" before the certification/ registration number only signifies that the Industry Canada technical specification were met.

### ▲ CAUTION

This equipment complies with FCC/IC radiation exposure limits set forth for an uncontrolled environment and meets the FCC radio frequency (RF) Exposure Guidelines in Supplement C to OET65 and RSS-102 of the IC radio frequency (RF) Exposure rules. This equipment has very low levels of RF energy that it deemed to comply without maximum permissive exposure evaluation (MPE). But it is desirable that it should be installed and operated keeping the radiator at least 20cm or more away from person's body (excluding extremities: hands, wrists, feet and ankles).

Under Industry Canada regulations, this radio transmitter may only operate using an antenna of a type and maximum (or lesser) gain approved for the transmitter by Industry Canada. To reduce potential radio interference to other users, the antenna type and its gain should be so chosen that the equivalent isotropically radiated power (e.i.r.p.) is not more than that necessary for successful communication.

## Note de l'IC (Industrie Canada)

Le présent appareil est conforme aux CNR-210 d'Industrie Canada applicables aux appareils radio exempts de licence.

L'exploitation est autorisée aux deux conditions suivantes :

(1) l'appareil ne doit pas produire de brouillage, et (2) l'utilisateur de l'appareil doit accepter tout brouillage radioélectrique subi, même si le brouillage est susceptible d'en compromettre le fonctionnement.

L'expression "IC:" avant le numéro d'homologation/ enregistrement signifie seulement que les spécifications techniques d'Industrie Canada ont été respectées.

### ▲ ATTENTION

Cet équipement est conforme aux limites d'exposition aux rayonnements énoncées pour un environnement non contrôlé et respecte les règles d'exposition aux fréquences radioélectriques (RF) CNR-102 de l'IC. Cet équipement émet une énergie RF très faible qui est considérée conforme sans évaluation de l'exposition maximale autorisée. Cependant, cet équipement doit être installé et utilisé en gardant une distance de 20 cm ou plus entre le dispositif rayonnant et le corps (à l'exception des extrémités : mains, poignets, pieds et chevilles).

Conformément à la réglementation d'Industrie Canada, le présent émetteur radio peut fonctionner avec une antenne d'un type et d'un gain maximal (ou inférieur) approuvé pour l'émetteur par Industrie Canada. Dans le but de réduire les risques de brouillage radioélectrique à l'intention des autres utilisateurs, il faut choisir le type d'antenne et son gain de sorte que la puissance isotrope rayonnée équivalente (p.i.r.e.) ne dépasse pas l'intensité nécessaire à l'établissement d'une communication satisfaisante.

# QAU0568 (USB Wi-Fi® adapter)

## Instruction Manual

Either QAU0568 or W02-5613 is connected at Wi-Fi receiver terminal.

### ▲ CAUTION

Changes or modifications not approved by us could void the user's authority to operate the equipment.

- This adapter has been designed exclusively for use with Kenwood car receivers. Do not use this adapter with any other car receiver.
- The Wi-Fi CERTIFIED Logo is a certification mark of the Wi-Fi Alliance.



Keep the Wi-Fi adapter inserted when using the Wi-Fi function.  
When the adapter is removed, store it in a safe place.

## Specifications

### IEEE Standard:

802.11b/g/n

### Security Support:

64/128 bit WEP /WPA & WPA2

### Frequency Range:

2.401 GHz – 2.473 GHz

### Transfer rates (MAX.):

802.11n (150 Mbps)

802.11g (54 Mbps)

802.11b (11 Mbps)

### Output Power:

DSSS: 15 – 19dBm

OFDM (11g): 13 – 17dBm

OFDM (11n): 11 – 15dBm

### Power Consumption:

5 V/305 mA (MAX.)

### Dimensions (L x W x H):

23.5 mm x 14.4 mm x 5.8 mm

(15/16" x 9/16" x 1/4")

Design and specifications are subject to change without notice.

# QAU0568 (adaptateur USB Wi-Fi®)

## MODE D'EMPLOI

### ATTENTION

Tout changement ou toute modification n'ayant pas reçu notre approbation pourrait entraîner l'interdiction d'utiliser l'équipement.

- Cet adaptateur a été conçu exclusivement pour un usage avec les autoradios Kenwood. N'utilisez cet adaptateur avec aucun autre autoradio.
- Le logo Wi-Fi CERTIFIED est une marque de certification de la Wi-Fi Alliance.



## Spécifications

### Norme IEEE :

802.11b/g/n

### Prise en charge de la sécurité :

WPA & WPA2/WEP 64/128 bits

### Bande de fréquences :

2,401 GHz - 2,473 GHz

### Taux de transfert (MAX.) :

802.11n (150 Mbps)

802.11g (54 Mbps)

802.11b (11 Mbps)

### Puissance de sortie :

DSSS: 15 – 19dBm

OFDM (11g): 13 – 17dBm

OFDM (11n): 11 – 15dBm

### Consommation :

5 V/305 mA (MAX.)

### Dimensions (L x l x H) :

23,5 mm x 14,4 mm x 5,8 mm

(15/16" x 9/16" x 1/4")

Les spécifications et le design sont sujets à changements sans notification.

Laissez l'adaptateur Wi-Fi inséré lors de l'utilisation de la fonction Wi-Fi.  
Une fois l'adaptateur retiré, conservez-le dans un endroit sûr.

## FCC WARNING

This equipment may generate or use radio frequency energy. Changes or modifications to this equipment may cause harmful interference unless the modifications are expressly approved in the instruction manual.

The user could lose the authority to operate this equipment if an unauthorized change or modification is made.

## FCC NOTE

This equipment has been tested and found to comply with the limits for a Class B digital device, pursuant to Part 15 of the FCC Rules. These limits are designed to provide reasonable protection against harmful interference in a residential installation. This equipment may cause harmful interference to radio communications, if it is not installed and used in accordance with the instructions.

However, there is no guarantee that interference will not occur in a particular installation. If this equipment does cause harmful interference to radio or television reception, which can be determined by turning the equipment off and on, the user is encouraged to try to correct the interference by one or more of the following measures:

- Reorient or relocate the receiving antenna.
- Increase the separation between the equipment and receiver.
- Connect the equipment into an outlet on a circuit different from that to which the receiver is connected.
- Consult the dealer or an experienced radio/TV technician for help.

This device complies with Part 15 of the FCC Rules. Operation is subject to the following two conditions: (1) This device may not cause harmful interference, and (2) This device must accept any interference received, including interference that may cause undesired operation.

## Para cumplimiento de la COFETEL:

"La operación de este equipo esta sujeta a las siguientes dos condiciones:

(1) es posible que este equipo o dispositivo no cause interferencia perjudicial y  
(2) este equipo o dispositivo debe aceptar cualquier interferencia, incluyendo la que pueda causar su operación no deseada."

# QAU0568 (adaptador USB Wi-Fi®)

## MANUAL DE INSTRUCCIONES

### PRECAUCIÓN

Los cambios o modificaciones no aprobados por nosotros podrían anular la autoridad del usuario para utilizar el equipo.

- Este adaptador ha sido diseñado exclusivamente para utilizarse en los receptores para automóvil de Kenwood. No lo utilice en ningún otro receptor para automóvil.
- El logotipo Wi-Fi CERTIFIED es una marca de certificación de Wi-Fi Alliance.



## Especificaciones

### IEEE estándar:

802.11b/g/n

### Soporte de seguridad:

64/128 bits WEP/WPA & WPA2

### Gama de frecuencias:

2,401 GHz - 2,473 GHz

### Tasas de transferencia (MÁX.):

802.11n (150 Mbps)

802.11g (54 Mbps)

802.11b (11 Mbps)

### Potencia de salida:

DSSS: 15 – 19dBm

OFDM (11g): 13 – 17dBm

OFDM (11n): 11 – 15dBm

### Consumo de potencia:

5 V/305 mA (MÁX.)

### Dimensiones (Lo x An x Al):

23,5 mm x 14,4 mm x 5,8 mm

(15/16" x 9/16" x 1/4")

El diseño y las especificaciones están sujetos a modificaciones sin previo aviso.

Mantenga el adaptador Wi-Fi introducido mientras utilice la función Wi-Fi.  
Cuando retire el adaptador, guárdelo en un lugar seguro.

# DNN992

# DNN9150DAB

## Voice Command Table

JVCKENWOOD Corporation

15DNN\_IM387\_VoiceCommand\_en\_00 (K/E)

© 2014 JVC KENWOOD Corporation

### General operation

Screen	Operation	Voice Command						
		US English	UK English	French	German	Dutch	Italian	Spanish
Any screen	Canceling the voice control mode	Cancel	Cancel	Annuler	Abbr.	Terug	Annulla	Cancelar
	Displays the Top Menu screen	Top menu	Top menu	Menu sup	Hauptmenü	Hoofdmenu	Menu princ.	Menú superior
	Switches to DAB source *1	DAB	DAB	DAB	DAB	DAB	DAB	DAB
	Switches to Wireless Link source	Wireless Link	Wireless Link	Wireless Link	Wireless Link	Wireless Link	Wireless Link	Wireless Link
	Switches to DVD source	DVD	DVD	DVD	DVD	DVD	DVD	DVD
	Switches to HD Radio source *2	HD Radio	HD Radio	Radio HD	HD Radio	HD Radio	HD Radio	HD Radio
	Switches to iPod source	iPod	iPod	iPod	iPod	iPod	iPod	iPod
	Switches to Bluetooth Audio source	Bluetooth audio	Bluetooth audio	Audio Bluetooth	Bluetooth audio	Bluetooth audio	Audio Bluetooth	Audio Bluetooth
	Switches to SiriusXM source *2	SiriusXM	SiriusXM	SiriusXM	SiriusXM	SiriusXM	SiriusXM	SiriusXM
	Switches to STANDBY source	Standby	Standby	Veille	Standby	Stand by	Attesa	En espera
	Switches to Cloud Storage source	Storage	Storage	Storage	Storage	Storage	Storage	Storage
	Switches to Tuner source *1	Tuner	Tuner	Tuner	Tuner	Tuner	Radio	Sintonizador
	Switches to USB source	USB	USB	USB	USB	USB	USB	USB
	Switches to Pandora source *2	Pandora	Pandora	Pandora	Pandora	Pandora	Pandora	Pandora
	Switches to AUPEO! source	AUPEO!	AUPEO!	AUPEO!	AUPEO!	AUPEO!	AUPEO!	AUPEO!
	Switches to iHeart Radio source *2	iHeart Radio	iHeart Radio	iHeart Radio	iHeart Radio	iHeart Radio	iHeart Radio	iHeart Radio
	Switches to APPS source	Apps	Apps	Apps	Apps	Apps	Apps	Apps
	Switches to HDMI source	HDMI	HDMI	HDMI	HDMI	HDMI	HDMI	HDMI
		MHL	MHL	MHL	MHL	MHL	MHL	MHL
	Switches the AV OUT source	AV out	AV out	sortie AV	AV out	AV uit	AV out	salida AV
	Displays Hands Free screen	Hands free	Hands free	Mains libres	Telefon	Handsfree	Vivavoce	Manos libres
	Switches to Mixed Media Search	Media Search	Media Search	Media Search	Media Search	Media Search	Media Search	Media Search
	Switches to Phone Search	Phone Search	Phone Search	Phone Search	Phone Search	Phone Search	Phone Search	Phone Search
	Displays OEM Features screen *2	OEM	OEM	OEM	OEM	OEM	OEM	OEM
	Displays the view from the Front View camera	Front camera	Front camera	Caméra avant	Frontkamera	Vooruitzicht camera	Telecamera frontale	Cámara delantera
	Displays the view from the Rear View camera	Rear camera	Rear camera	Caméra arrière	Rückfahrkamera	Camera achter	Retrocamera	Cámara trasera
	Displays Current Source Control screen	Control screen	Control screen	Écran de commande	Steuerbildschirm	Scherb besturen	Scherb. di controllo	Pantalla de control
	Searches the previous station/channel.	Seek down	Seek down	Rechercher vers le bas	Suche abwärts	Omlaag zoeken	Ricerca giù	Buscar anterior
	Searches the next station/channel.	Seek up	Seek up	Rechercher vers le haut	Suche aufwärts	Omhoog zoeken	Ricerca su	Buscar siguiente
	Searches the previous track/file.	Track down	Track down	Piste précédente	Titel abwärts	Track omlaag	Traccia giù	Pista anterior
	Searches the next track/file.	Track up	Track up	Piste suivante	Titel aufwärts	Track omhoog	Traccia su	Pista siguiente
	Switches to RSS Application	RSS	RSS	RSS	RSS	RSS	RSS	RSS
	Switches to Weather Application	Weather	Weather	Météo	Wetter	weer	Tempo	tiempo
	Switches to Facebook in SNS Application	Facebook	Facebook	Facebook	Facebook	Facebook	Facebook	Facebook
	Create a Facebook Status in SNS Application	Status	Status	Statut	Status	status	Stato	Estatus
	Switches to Twitter in SNS Application	Twitter	Twitter	Twitter	Twitter	twitter	Twitter	Twitter
	Create a Tweet in SNS Application	Tweet	Tweet	Tweet	Twitter-Nachricht	Tweet	Tweet	Tweet
	Switches to email in SNS Application	Mail	Mail	Message	Email	E-mail	Mail	Correo
	Posting the current place.	I'm Here	I'm Here	Je suis ici	Mein Standort	Ik ben hier	Ci sono	Estoy aquí
	Posting the information about the song you are listening to.	I'm Listening	I'm Listening	J'écoute	Ich höre gerade	Ik luister	In ascolto	Escucho
	Displays the Current Location Information	View Map	View Map	View Map	View Map	View Map	View Map	View Map

### Displaying Voice Commands

The available voice commands depend on each screen and you can find them by pressing and holding the Push-To-Talk switch.

### 1 Press and hold the Push-To-Talk switch.



The list of operable voice commands appears. Pronounce a command.

### Note

- About the voice command for navigation system, refer to the instruction manual of the navigation system.
- \*1 DNN9150DAB only
- \*2 DNN992 only



# Software License Agreement

The software embedded in the Product (hereinafter the "Licensed Software") provided by JVC KENWOOD Corporation (hereinafter the "Licensor") is copyrighted to or sublicensable by the Licensor, and this Agreement provides for the terms and conditions which Users shall follow in order to use the Licensed Software.

The User shall use the Licensed Software by agreeing with the terms of this Software License Agreement. This Agreement shall be deemed completed at the time the User (hereinafter the "User") initially used the Product in which the "Licensed Software" is embedded.

The Licensed Software may include the software which has been licensed to the Licensor directly or indirectly from any third party. In such case, some third parties require the Users to follow their conditions for use separately from this Software License Agreement. Such software shall not be subject to this Agreement, and the Users are urged to read the "Important Notice concerning the Software" to be provided separately.

## Article 1 General Provision

The Licensor shall grant to the User a non-exclusive and non-transferable (other than the exceptional case referred to in Article 3, Paragraph 1) licensed to use the Licensed Software within the country of the User.

## Article 2 License

1. The license granted under this Agreement shall be the right to use the Licensed Software in the Product.
2. The User shall not duplicate, copy, modify, add, translate or otherwise alter, or lease the Licensed Software and any related documents, whether in whole or in part.
3. The use of the Licensed Software shall be limited to personal purpose, and the Licensed Software shall not be distributed, licensed or sub-licensed whether it is for commercial purpose or not.
4. The User shall use the Licensed Software according to the directions described in the operation manual or help file, and is prohibited to use or duplicate any data in a manner violating the Copyright Law or any other laws and regulations by applying whole or a part of the Licensed Software.

## Article 3 Conditions for Grant of License

1. When the User transfers the Product, it may also transfer the license to use the Licensed Software embedded in the Product (including any related materials, updates and upgrades) on condition that no original, copies or related materials continue in the possession of the User, and that the User shall cause the transferee to comply with this Software License Agreement.
2. The User shall not carry out reverse engineering, disassembling, decompiling or any other code analysis works in connection with the Licensed Software.

## Article 4 Right Pertaining to the Licensed Software

Any and all copyrights and other rights pertaining to the Licensed Software and related documents shall belong to the Licensor or the original holder of the right who granted to the Licensor the license or sublicense for the Licensed Software (hereinafter the "Original Rightholder"), and the User shall not be entitled to any right other than the license granted hereunder, in respect of the Licensed Software and any related documents.

## Article 5 Indemnification of Licensor

1. Neither the Licensor nor the Original Rightholder shall be liable for any damage incurred by the User or any third party due to the exercise of the license granted to the User under this Agreement, unless otherwise restricted by law.
2. The Licensor will offer no guarantee for the merchantability, convertibility and consistency with certain objective of the Licensed Software.

## Article 6 Liability to Third Party

If any dispute has arisen with any third party due to an infringement upon a copyright, patent or any other intellectual property right that was caused by the User's use of the Licensed Software, the User shall settle such dispute at its own cost and hold the Licensor and the Original Rightholder harmless from any inconvenience it may cause.

## Article 7 Confidentiality

The User shall keep the confidentiality of such portion of the Licensed Software, related documents thereof or any other information to be granted under this Agreement, as well as the conditions of this Agreement as has not yet entered the public domain, and shall not disclose or divulge the same to any third party without approval of the Licensor.

### **Article 8 Termination**

In case the User falls under any of the events described in the following items, the Licensor may immediately terminate this Agreement or claim that the User compensates for the damage incurred by the Licensor due to such event:

1. When the User violated any provision of this Agreement; or
2. When a petition has been filed against the User for an attachment, provisional attachment, provisional disposition or any other compulsory execution.

### **Article 9 Destruction of the Licensed Software**

If this Agreement is terminated pursuant to the provision of Article 8, the User shall destroy the Licensed Software, any related documents and copies thereof within two (2) weeks from such date of termination.

### **Article 10 Protection of Copyright**

1. The copyright and all the other intellectual property rights relating to the Licensed Software shall belong to the Licensor and the Original Rightholder, and in no event shall they be under the ownership of the User.
2. The User shall, whenever it uses the Licensed Software, comply with any laws relating to the copyright and other intellectual property rights.

### **Article 11 Export Restriction**

1. It is prohibited to export the Licensed Software and any related documents outside the country of the User (including transmission thereof outside the country of the User via Internet or other communication tools).
2. The User shall understand that the Licensed Software shall be subject to the export restrictions adopted by the country of User and any other countries.
3. The User shall agree that the software will be subject to any and all applicable international and domestic laws (including the export control regulation of the country of User and any other countries, and any restrictions concerning the end-users, the use by end-users and importing countries to be provided by the country of User and any other countries, and any other governmental authorities).

### **Article 12 Miscellaneous**

1. In the event any part of this Agreement is invalidated by operation of law, the residual provisions shall continue in force.
2. Matters not stipulated in this Agreement or any ambiguity or question raised in the construction of this Agreement shall be provided or settled upon good-faith consultation between the Licensor and the User.
3. The Licensor and the User hereby agree that this Agreement is governed by the laws of Japan, and any dispute arising from, and relating to the rights and obligations under, this Agreement shall be submitted to the exclusive jurisdiction of the Tokyo District Court for its first instance.

# Important Notice Concerning the Software

## Software License Attached to the Product

The Software embedded in the Product is composed of several independent software components, and in each of such individual components, a copyright of either JVC KENWOOD or a third party subsists.

The Product uses the software component designated in the End-User License Agreement that was executed between JVC KENWOOD and a third party (hereinafter "EULA").

"EULA" covers those corresponding to free software, and, as a condition of distribution of the software component in executable format which is based on the license granted under the GNU General Public License or Lesser General Public License (hereinafter "GPL/LGPL"), it requires an availability of the source code for the relevant component. For details of the software component covered by "GPL/LGPL", please visit the following website:

URL : <http://www2.jvckenwood.com/gpl/>

Please note that we are unable to answer any inquiry relating to the contents, etc. of the source code.

In addition, the software component of the Product includes the software developed or created independently by JVC KENWOOD, and there exists an ownership of JVC KENWOOD in such software and any accompanying documents, which is protected by the Copyright Law, any international treaties and other applicable laws.

As to matters concerning the handling of JVC KENWOOD software components, please refer to the "Software License Agreement" attached hereto. Please note that any software component licensed under "EULA" which is not subject to "GPL/LGPL", and those developed or created independently by JVC KENWOOD shall not be subject to the requirement for provision of the source code.

The software component distributed under "GPL/LGPL" shall be licensed to users without charge, and, therefore, no warranty is given for such software component, either express or implied, within the scope of the applicable laws and regulations.

Unless otherwise permitted by applicable laws and regulations or agreed in written form, none of the owners of the copyright or persons entitled to alter or redistribute the software component under the said license shall have any liability for any type of damage or loss resulting from the use of or inability to use such software component. For further details of the conditions of use of such software component or matters required to be complied with, please refer to the relevant "GPL/LGPL".

Users are urged to read the details for the relevant license carefully before using the software component covered by "GPL/LGPL" and embedded in the Product. Since the terms and conditions of individual licenses are provided by parties other than JVC KENWOOD, the original English version will be included.

## MILITARY

Units purchased through the U.S.A. military exchange service overseas may be serviced under warranty in the continental U.S.A., subject to the following conditions.

- 1) The original warranty is in effect.
- 2) Proof of purchase is provided to the servicer.

### WARRANTY FOR MILITARY MARKET

Kenwood corporation is proud of the quality and workmanship of its audio equipment. This unit has been properly designed, tested and inspected before it was shipped to you. If properly installed and operated in accordance with instructions furnished, it should give you an optimum reliable performance.

### WARRANTY PERIOD

This product is warranted for a period of (1) year from the date of the original purchase.

### SCOPE OF WARRANTY

Except as specified below, this warranty covers all defects in materials and workmanship of the Kenwood brand products.

During the warranty period, any authorized Kenwood Service Center in the military market listed in the back of this warranty card will provide you free-of-charge both parts and labor required to correct any defect in materials or workmanship.

The following are not covered by this warranty.

1. Voltage conversions.
2. Periodic check-ups which do not disclose any defect covered by the warranty.
3. Cabinets, grilles, other exterior finishes, belts, tape heads, and other non-durable parts and accessories.
4. Units on which the serial number has been etched, modified or removed.
5. Installation and/or removal charges.
6. Damaged magnetic tapes.
7. House call charges for any repairs.
8. Shipping or delivery charges to or from an authorized Kenwood Service Center.
9. This warranty will not cover any failure that is due to any of the following conditions in accordance with the visual inspection of the authorized Kenwood Service Center:
  - \* Improper maintenance or repair, including the installation of parts or accessories that do not conform to the quality and specifications of the original parts.
  - \* Misuse, abuse, neglect, unauthorized product modification or failure to follow instructions contained in the Owner's Manual.
  - \* Accidental or intentional damages.
  - \* Repairs or attempted repairs by an unauthorized agency. (All repairs must be performed at an authorized Kenwood Service Center.)
  - \* Damages or deteriorations caused during shipment (Claims must be presented to the carrier).
  - \* Damages or deteriorations resulting from removal and/or replacement.

### PURCHASER'S RESPONSIBILITIES

As the purchaser of a new Kenwood brand product, you are requested to do the following in order to obtain Kenwood warranty service.

1. Retain your sales slip or other evidence of purchase for proving your eligibility for requesting Kenwood warranty service.
2. Make your unit available to an authorized Kenwood Service Center in the military market for inspection and approved warranty service, or ship your unit in its original carton box or equivalent, fully insured and shipping charges prepaid, to the authorized Kenwood Service Center.

### LIMITATION OF IMPLIED WARRANTIES

Any and all implied warranties, including warranties of merchantability and fitness for a particular purpose, shall be limited in duration to the length of this warranty.

### EXCLUSION OF CERTAIN DAMAGES

KENWOOD'S liability for any defective product is limited to the repair or replacement of said product, at our option, and shall not include damages of any kind, whether incidental, consequential or otherwise, except to the extent prohibited by applicable law.

### KENWOOD AUTHORIZED SERVICE CENTERS IN MILITARY MARKET

#### JAPAN:

##### Yokota

Kenwood Rep.; c/o  
Yokota BX, JAAX AAFES-PAC,  
APO San Francisco 96328

##### Zama

Kenwood Rep.; c/o  
Zama PX, JAAX AAFES-PAC,  
APO San Francisco 96343

##### Misawa

Kenwood Rep.; c/o  
Misawa BX, JAAX AAFES-PAC,  
APO San Francisco 96519

##### Yokosuka

Kenwood Rep.; c/o  
A-33, Yokosuka NEX No. 260-010  
FPO Seattle 98760

##### Atsugi

Kenwood Rep.; c/o  
Atsugi NEX No. 260-020 FPO Seattle  
98767

##### Iwakuni

Kenwood Rep.; c/o  
Marine Corps Exchange, Marine Corps  
Air Station,  
FPO Seattle 98764

##### Sasebo

Sasebo NEX;  
Navy Exchange 260-040  
F.A. Box 115 FPO Seattle 98766

##### Okinawa

Kenwood Rep.; c/o  
OWAX, AAFES-PAC, APO San Francisco  
96230

#### KOREA:

Kenwood Rep.; c/o  
KOAX Repair Shop, AAFES-PAC  
DD-Camp Market, APO San Francisco  
96488

#### GUAM:

Kenwood Rep.; c/o  
Guam NEX No. 230-010,  
FPO San Francisco 96630  
Kenwood Rep.; c/o  
GUAX, AAFES-PAC, APO San Francisco  
96334

#### U.S.A.:

##### Hawaii

Kenwood Factory Service  
99-994 Iwaena St., Aiea, Hawaii 96701

##### Alaska

Vista Radio TV;  
861 East Loop Road, Anchorage, Alaska  
99501  
Anchorage Commercial Electronics, Inc.;  
1450 East 9th Ave., Anchorage, Alaska  
99501

##### In The Continental U.S.A.

For Nearest Authorized Service Center;  
Tel: 1-800-536-9663

##### Kenwood Service U.S.A.

Kenwood Factory Service;  
P.O. Box 22745, 2201 East Dominguez  
Street,  
Long Beach, California 90801-5745  
Tel: (310) 639-5300

#### EUROPE:

Please inquire at the military resale outlets where you bought your Kenwood products, or  
KENWOOD ELECTRONICS  
DEUTSCHLAND GMBH:  
Rembrücker-Str. 15, 63150 Heusenstamm,  
Germany  
Tel.: 49-06104-69010

# Warranty Card

Identification du produit  
Modelo do aparelho e numero de série  
Model number & serial number

Revendeur & cachet  
Nome da loja e carimbo  
Dealer & stamp

Date d'achat  
Data da compra  
Purchase date

Nom & adresse du client  
Nome e endereço do cliente  
Name & address of customer

### Attention:

This card and receipt (or invoice) are necessary to purchase a new panel in case of theft or damage.

### Attention:

Vous aurez besoin de cette carte et du reçu (ou de la facture) pour acheter un nouveau panneau en cas de vol ou d'endommagement.

### Atenção:

Em caso de dano ou perda do painel frontal, este Certificado de Garantia e a Nota Fiscal de compra serão requisitados para a aquisição de um novo painel.

© B46-0824-00/01 (K) (12/07)

# KENWOOD

Dear Customer,

Thank you for purchasing this Kenwood product. As mentioned in the pages of this booklet, our warranty is only valid in the countries listed. If your country is not listed please contact your retailer for information on warranty procedure, or write to:

### JVC KENWOOD Customer Information Center

3-12, Moriyacho, Kanagawa-ku, Yokohama-shi, Kanagawa 221-0022, Japan

U.S.A.	KENWOOD USA CORPORATION
<p>This warranty will be honored only in the U.S.A.</p>	
<p><b>WHO IS PROTECTED</b> This warranty is enforceable only by the original purchaser.</p>	
<p><b>WHAT WE WILL PAY FOR</b> We will pay for all labor and material expenses for covered items. Payment of shipping charges is discussed in the next section of this warranty.</p>	
<p><b>HOW TO OBTAIN WARRANTY SERVICE</b> If your KENWOOD product ever needs service: 1. Take or ship it to any KENWOOD Authorized Service Center in the U.S.A. along with a complete description of the problem. (If you are uncertain as to whether a Service Center is authorized, please call 1-800-KENWOOD for the nearest Service Center. 1-800-536-9663). 2. Although you must pay any shipping charges if it is necessary to ship the product for warranty service, we will pay the return shipping charges if the repairs are covered by the warranty within the United States. 3. Whenever your units are taken or sent for warranty service, you must include a copy of the original dated sales receipt as proof of warranty coverage.</p>	
<p><b>LIMITATION OF IMPLIED WARRANTIES</b> ALL IMPLIED WARRANTIES, INCLUDING WARRANTIES OF MERCHANTABILITY AND FITNESS FOR A PARTICULAR PURPOSE, ARE LIMITED IN DURATION TO THE LENGTH OF THIS WARRANTY.</p>	
<p><b>EXCLUSION OF DAMAGES</b> KENWOOD'S LIABILITY FOR ANY DEFECTIVE PRODUCT IS LIMITED TO THE REPAIR OR REPLACEMENT OF THE PRODUCT AT OUR OPTION. KENWOOD SHALL NOT BE LIABLE FOR: 1. INSTALLATION OR REMOVAL CHARGES, DAMAGE TO OTHER PROPERTY CAUSED BY ANY DEFECTS IN KENWOOD CAR STEREO COMPONENTS, DAMAGES BASED UPON INCONVENIENCE, LOSS OF USE OF THE PRODUCT; OR 2. ANY OTHER DAMAGES, WHETHER INCIDENTAL, CONSEQUENTIAL OR OTHERWISE. SOME STATES DO NOT ALLOW LIMITATIONS ON HOW LONG AN IMPLIED WARRANTY LASTS AND/OR DO NOT ALLOW THE EXCLUSION OR LIMITATION OF INCIDENTAL OR CONSEQUENTIAL DAMAGES, SO THE ABOVE LIMITATIONS AND EXCLUSIONS MAY NOT APPLY TO YOU.</p>	
<p>This warranty gives you specific legal rights, and you may also have other rights which vary from state to state.</p> <p>If a problem develops during or after the Limited Warranty Period, or if you have any questions regarding the operation of the product, you should contact your KENWOOD Authorized Dealer or Authorized Service Center. If the problem or your question is not handled to your satisfaction, please contact our Customer Relations Department at the address listed below:</p>	
<p><b>KENWOOD USA CORPORATION</b> <b>P.O. Box 22745, 2201 East Dominguez Street, Long Beach, CA 90801-5745</b> <b>Tel: (310) 639-5300</b></p>	

BRASIL	JVC KENWOOD DO BRASIL COMÉRCIO DE ELETRÔNICOS LTDA
<p>O fabricante garante o produto identificado na Nota Fiscal de venda ao consumidor contra qualquer defeito de fabricação ou de matéria-prima durante o período de garantia. Esta garantia é válida no território brasileiro desde que o produto tenha sido adquirido no Brasil e distribuído pela JVC KENWOOD do Brasil Comércio de Eletrônicos Ltda.</p>	
<p><b>PERÍODO DE GARANTIA</b></p>	
<p>Este produto é garantido pelo prazo de 01 (um) ano, incluindo o período estabelecido por lei, a partir da data de aquisição, comprovada mediante a apresentação da respectiva Nota Fiscal de venda ao consumidor final. Eventuais reparos realizados no produto durante o período de garantia não implicam na dilatação do seu prazo.</p>	
<p><b>EXCLUSÃO DA GARANTIA</b></p>	
<p>(a) Produtos com o número de série ou certificado de garantia rasurados, adulterados ou ilegíveis; (b) Defeitos resultantes de acidentes (quedas, batidas e etc), uso em desacordo com o manual de instruções, má utilização, ligação à fonte de tensão diferente da especificada no Manual de Instruções, modificações não autorizadas; (c) Danos causados por agentes da natureza (Ex: chuvas, raios, maresia, enchentes e etc); (d) Defeitos ou danos em decorrência de consertos realizados por pessoas não autorizadas; (e) Defeitos ou danos resultantes do uso de peças ou dispositivos não conformes às especificações da JVC KENWOOD; (f) Danos ou deteriorações aos acabamentos externos, partes cosméticas, cabos, chicotes, parafusos de fixação, luvas, alças, bolsas, estojos, adaptadores, antenas, fitas, cabeças gravadoras, CDs ou danos causados por pilhas defeituosas ou com vazamento; (g) Defeitos ou danos devido ao transporte (reclamações devem ser feitas junto à empresa transportadora); (h) Qualquer outra causa que não esteja relacionada a defeitos de matéria-prima e de fabricação; (i) Danos causados por tentativa de roubo ou furto; (j) Danos causados por uso de CDs de má qualidade; (k) Danos decorrentes do desgaste natural do produto; (l) Danos causados por mau uso, (derramamento de líquidos e/ou alimentos, corrosão, oxidação, exposição à umidade ou situações climáticas extremas, riscos ou quedas).</p>	
<p><b>CONCERTO EM GARANTIA</b></p>	
<p>É indispensável a apresentação deste Certificado de Garantia devidamente preenchido, acompanhado da respectiva Nota Fiscal de compra do produto, desde que não apresente rasuras ou modificações. O consumidor somente terá direito a estes benefícios, quando o produto for entregue diretamente no balcão de um Serviço Autorizado da JVC KENWOOD.</p>	
<p><b>O QUE NÃO É COBERTO PELA GARANTIA</b></p>	
<p>Instalação e remoção do produto, despesas de frete, seguro e embalagem são de responsabilidade do proprietário.</p> <p>Este produto é destinado exclusivamente ao uso doméstico.</p>	
<p><b>IMPORTANTE:</b></p>	
<p>Para qualquer informação sobre seu equipamento JVC KENWOOD, ou para obter o endereço do Serviço Autorizado mais próximo, acesse o site <a href="http://www.kenwood.com.br">www.kenwood.com.br</a>, ou ligue para a Central de Atendimento JVC KENWOOD – Tel.: +55 (11) 3777-6771 com os dados abaixo preenchidos.</p>	
<p><b>JVC KENWOOD DO BRASIL COMÉRCIO DE ELETRÔNICOS LTDA</b> <b>Tel: (11) 3777-6771</b> <b><a href="http://www.kenwood.com.br">www.kenwood.com.br</a></b></p>	
<p>Nome do consumidor: _____</p> <p>Endereço: _____ CEP: _____</p> <p>Cidade: _____ Estado: _____</p> <p>Telefone: _____</p> <p>Data da compra: ____/____/____ Nota Fiscal: _____</p>	

CANADA	KENWOOD ELECTRONICS CANADA INC.
<p><b>KENWOOD WARRANTY</b></p>	
<p>KENWOOD ELECTRONICS CANADA INC. (hereinafter called "KENWOOD"), gives the following written warranty to the original customer of each new Kenwood product distributed in Canada by KENWOOD and purchased from a dealer authorized by KENWOOD.</p> <p>KENWOOD warrants that each new Kenwood product, under normal use, is free from any defects, subject to the terms and conditions set forth below. If a defect should occur within the warranty period, repairs will be made free of charge for parts and labour when such defects are determined by KENWOOD or its' authorized service centres to be attributable to faulty materials or workmanship at time of manufacture. Please contact KENWOOD to confirm if a dealer or service centre is authorized by KENWOOD.</p>	
<p><b>WARRANTY PERIOD</b></p>	
<p>This Kenwood product is warranted for parts and labour for a period of one (1) year from the date of original purchase, lease or rental, except for products which are used in a professional or commercial application, which are warranted for a period of ninety (90) days for parts and labour and are subject to the terms and conditions of the warranty.</p>	
<p><b>WARRANTY EXCLUSIONS</b></p>	
<p>This warranty excludes: (a) Products purchased in a foreign country or purchased in Canada and taken to a foreign country. (b) Products purchased from a dealer not authorized by KENWOOD. (c) Products with the serial number defaced, altered or missing. (d) Periodic check-ups which do not disclose any defects covered by this warranty.</p>	
<p><b>TO OBTAIN WARRANTY SERVICE</b></p>	
<p>Should your Kenwood product require warranty service, deliver it to any authorized KENWOOD service centre and present the original copy of your bill of sale and this warranty card as proof of warranty, or send your product fully insured and freight prepaid to the nearest authorized KENWOOD service centre. To avoid possible shipping damage, make sure the product is properly packed. Include a copy of your original bill of sale and this warranty card as proof of warranty along with your name, home and /or work telephone number(s), a complete return address and a detailed description of the fault(s). Products repaired within warranty will be returned freight prepaid to destinations within Canada. The customer is responsible for all freight and related costs for the return of product(s) to destinations outside Canada.</p>	
<p><b>ENTIRE WARRANTY</b></p>	
<p>This warranty constitutes the entire written warranty given by KENWOOD. No person, party, dealer or service centre or their agents or employees are authorized to extend or enlarge this warranty on behalf of KENWOOD by any written or verbal statement or advertisement or promotion, including any extended warranty program or plan that may be offered by the dealer or service centre, unless approved in writing by KENWOOD.</p>	
<p><b>DISCLAIMER</b></p>	
<p>KENWOOD disclaims any responsibility for loss of time or use of the product or any other indirect, incidental or consequential damage to other products or goods, inconvenience or commercial loss.</p>	
<p><b>NOTICE TO CONSUMER</b></p>	
<p>The provisions contained in this written warranty are not intended to limit, modify, take away, disclaim or exclude any warranties or rights you may have which are set forth in any applicable provincial or federal laws or legislation.</p>	
<p><b>IMPORTANT</b></p>	
<p>This warranty card by itself is not considered by KENWOOD as a valid proof of purchase. When applying for warranty repairs, you must present the original copy of your bill of sale and this warranty card as proof of warranty, so we recommend that they be kept in a safe place, should they be required in the future.</p>	
<p><b>KENWOOD ELECTRONICS CANADA INC.</b> <b>6070 Kestrel Road, Mississauga, Ontario, Canada L5T 1S8</b> <b>Tel.: (905) 670-7211</b> <b>Fax: (905) 670-7248</b></p>	

GARANTIE KENWOOD	L'ENTIERE GARANTIE
<p>KENWOOD ELECTRONICS CANADA INC. (ci-après appelée "KENWOOD"), donne par écrit la garantie suivante à l'acheteur original de chaque nouveau produit Kenwood distribué au Canada par KENWOOD et acheté à un concessionnaire autorisé par KENWOOD.</p> <p>KENWOOD garantit, sous réserve des termes et des conditions énoncés ci-dessous, que chaque nouveau produit Kenwood, dans des conditions d'emploi normales, est exempt de tous défauts. Si l'un d'eux se produit pendant la période de garantie, KENWOOD s'engage à assumer le coût des pièces défectueuses et de la main-d'oeuvre nécessaires pour effectuer les réparations pourvu que de tels défauts sont attribuables à des pièces défectueuses employées lors de la fabrication du produit Kenwood ou à la main-d'oeuvre tel qu'établi par KENWOOD ou par l'un de ses centres de service autorisés. Appelez KENWOOD pour vérifier si un concessionnaire ou un centre de service est autorisé par KENWOOD.</p>	
<p><b>PÉRIODE DE GARANTIE</b></p>	
<p>Les pièces et la main-d'oeuvre nécessaires pour la réparation des produits Kenwood sont garanties pendant la période d'un (1) an à compter de la date d'achat, de bail ou de location originale, sauf dans les cas où les produits Kenwood sont employés dans un but professionnel ou commercial, où la garantie des pièces et de la main-d'oeuvre demeure en vigueur pendant une période de quatre-vingt-dix (90) jours sous réserve des termes et des conditions de la garantie.</p>	
<p><b>EXCLUSIONS DE GARANTIE</b></p>	
<p>Cette garantie ne couvre pas: (a) les produits achetés à l'étranger ou achetés au Canada et transportés à l'étranger, (b) les produits achetés à un concessionnaire non autorisé par KENWOOD; (c) les produits dont le numéro de série manque, a été effacé ou modifié; (d) les services d'entretien périodiques qui n'indiquent aucun défaut couvert par cette garantie.</p>	
<p><b>COMMENT OBTENIR DU SERVICE SOUS GARANTIE</b></p>	
<p>Au cas où un service sous garantie de votre produit Kenwood s'avère nécessaire, veuillez livrer le produit à n'importe quel centre de service KENWOOD et présenter la copie originale du contrat de vente et cette carte de garantie en tant que preuve de garantie ou veuillez faire parvenir votre produit assuré et port payé au centre de service KENWOOD autorisé le plus proche. Pour éviter toutes possibilités de dommages pendant le transport, veuillez bien emballer le produit. Veuillez inclure une copie du contrat de vente original et cette carte de garantie en tant que preuve de garantie aussi bien que votre nom, numéros de téléphone au poste de travail et/ou au domicile, votre adresse et une description détaillée des défauts. Les produits sous garantie réparés seront retournés port payé aux destinations à l'intérieur du Canada. Le consommateur sera responsable de tous frais de transport et d'autres frais qui s'y rapportent pour faire expédier les produits à destinations à l'extérieur du Canada.</p>	
<p><b>RENONCIATION</b></p>	
<p>KENWOOD renonce à toutes responsabilités de perte de temps, d'emploi du produit, de tous dommages indirects ou accessoires causés à d'autres produits ou biens, de tous inconvénients ou de toutes pertes commerciales.</p>	
<p><b>AVIS AUX CONSOMMATEURS</b></p>	
<p>Les stipulations contenues dans la présente garantie écrite n'ont pas pour but de limiter, de modifier, de diminuer, de rejeter ni d'exclure d'autres garanties ni droits énoncés dans n'importe quelles lois ou législations provinciales ou fédérales.</p>	
<p><b>IMPORTANT</b></p>	
<p>KENWOOD ne considère pas cette garantie toute seule comme étant une preuve d'achat valide. Lorsqu'on demande du service sous garantie, il faudra présenter la copie originale du contrat de vente aussi bien que cette carte de garantie en tant que preuve de garantie. On recommande de les conserver dans un lieu sûr au cas où elles s'avèreraient nécessaires à l'avenir.</p>	
<p><b>KENWOOD ELECTRONICS CANADA INC.</b> <b>6070 Kestrel Road, Mississauga, Ontario, Canada L5T 1S8</b> <b>Téléphone: (905) 670-7211</b> <b>Télocopieur: (905) 670-7248</b></p>	

## Free Manuals Download Website

<http://myh66.com>

<http://usermanuals.us>

<http://www.somanuals.com>

<http://www.4manuals.cc>

<http://www.manual-lib.com>

<http://www.404manual.com>

<http://www.luxmanual.com>

<http://aubethermostatmanual.com>

Golf course search by state

<http://golfingnear.com>

Email search by domain

<http://emailbydomain.com>

Auto manuals search

<http://auto.somanuals.com>

TV manuals search

<http://tv.somanuals.com>