

KENWOOD

CONNECTED NAVIGATION SYSTEM

DNN9150BT

DNN9150BTM

CONNECTED MONITOR WITH DVD RECEIVER

DNR8015BT

DNR8015BTM

Quick Start Guide

JVCKENWOOD Corporation

You can update the system by connecting a USB device containing an update file.

For updating the system, visit <<http://www.kenwood.com/cs/ce/>>.



Contents

About the Quick Start Guide	2
Precautions	3
Safety Precautions and Important Information	5
Features of Connected systems	6
First Step.....	7
Functions of the Buttons on the Front Panel.....	10
Common Operation.....	11
Login.....	12
Operation on the Home Screen	12
How to Use the Navigation System (DNN9150BT/ DNN9150BTM)	14
How to Play Music.....	16
How to Play Movie.....	17
How to Listen to the Radio.....	18
How to Make a Phone Call.....	18
Installation.....	20
iPod/ iPhone/ Android setup	29
About This Unit.....	32

About the Quick Start Guide

This Quick Start Guide describes basic functions of this unit.

For functions not described in this Guide, refer to the Instruction Manual on the following website:

<http://manual.kenwood.com/edition/im387/>



To refer to the Instruction Manual, a PC loaded with Microsoft® Windows XP/Vista/7/8 or Mac OS X® 10.4 or later is required in addition to Adobe® Reader™ 7.1 or Adobe® Acrobat® 7.1 or later.

The Instruction Manual is subject to change for modification of specifications and so forth. Be sure to download the latest edition of the Instruction Manual for reference.

NOTE

- The panels shown in this guide are examples used to provide clear explanations of the operations. For this reason, they may be different from the actual panels.
- In operation procedures, bracket shape indicates the key or button you should control.
 - < >: indicates the name of panel buttons.
 - []: indicates the name of touch keys

Precautions

▲WARNING

■ To prevent injury or fire, take the following precautions:

- To prevent a short circuit, never put or leave any metallic objects (such as coins or metal tools) inside the unit.
- Do not watch or fix your eyes on the unit's display when you are driving for any extended period.
- If you experience problems during installation, consult your Kenwood dealer.

■ Precautions on using this unit

- When you purchase optional accessories, check with your Kenwood dealer to make sure that they work with your model and in your area.
- You can select language to display menus, audio file tags, etc. See **Language setup (P.110)** in the Instruction Manual.
- The Radio Data System or Radio Broadcast Data System feature won't work where the service is not supported by any broadcasting station.

■ Protecting the monitor

To protect the monitor from damage, do not operate the monitor using a ballpoint pen or similar tool with the sharp tip.

■ Lens fogging

When you turn on the car heater in cold weather, dew or condensation may form on the lens in the disc player of the unit. Called lens fogging, this condensation on the lens may not allow discs to play. In such a situation, remove the disc and wait for the condensation to evaporate. If the unit still does not operate normally after a while, consult your Kenwood dealer.

■ Precautions on handling discs

- Do not touch the recording surface of the disc.
- Do not stick tape etc. on the disc, or use a disc with tape stuck on it.
- Do not use disc type accessories.
- Clean from the center of the disc and move outward.
- When removing discs from this unit, pull them out horizontally.
- If the disc center hole or outside rim has burrs, use the disc only after removing the burrs with a ballpoint pen etc.
- Discs that are not round cannot be used.

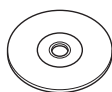

- 8-cm (3 inch) discs cannot be used.
- Discs with coloring on the recording surface or discs that are dirty cannot be used.
- This unit can only play the CDs with



This unit may not correctly play discs which do not have the mark.

- You cannot play a disc that has not been finalized. (For the finalization process see your writing software, and your recorder instruction manual.)

■ Erase the personal information

Before giving or selling this unit to others, be sure to delete the information (mail, search logs, etc.) stored in this unit by yourself and confirm that the data has been deleted.

We shall not be liable for any damage caused by leakage of undeleted data.

1. Press the <HOME> button.
2. Press the <MENU> button.
3. Touch [Setting].
4. Touch [Backup & Reset].
5. Touch [Factory data reset].
6. Enter owner password. Touch [Reset].
7. Touch [ERASE].

■ Acquiring GPS signal

(DNN9150BT/ DNN9150BTM)

The first time you turn on this unit, you must wait while the system acquires satellite signals for the first time. This process could take up to several minutes. Make sure your vehicle is outdoors in an open area away from tall buildings and trees for fastest acquisition.

After the system acquires satellites for the first time, it will acquire satellites quickly each time thereafter.

■ About the front panel

When removing the product from the box or installing it, the front panel may be positioned at the angle shown in (Fig. 1). This is due to the characteristics of mechanism the product is equipped with.

When the product is first powered on works properly, the front panel will automatically move into the position (initial setting angle) shown in (Fig. 2).

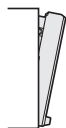

(Fig. 1)



(Fig. 2)

■ Cleaning the Unit

If the faceplate of this unit is stained, wipe it with a dry soft cloth such as a silicon cloth. If the faceplate is stained badly, wipe the stain off with a cloth moistened with neutral cleaner, then wipe it again with a clean soft dry cloth.

⚠ CAUTION

- Applying spray cleaner directly to the unit may affect its mechanical parts. Wiping the faceplate with a hard cloth or using a volatile liquid such as thinner or alcohol may scratch the surface or erase screened print.

■ How to reset your unit

If the unit or the connected unit fails to operate properly, reset the unit.

1 Press the <Reset> button.

The unit returns to factory settings.

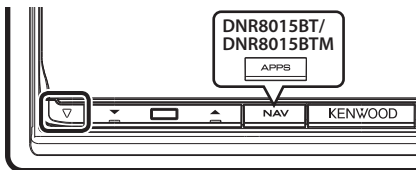

🔧 NOTE

- Disconnect the USB device before pressing the <Reset> button. Pressing the <Reset> button with the USB device connected can damage the data stored in the USB device. For how to disconnect the USB device, see **How to Play Music (P.16)**.
- When the unit is turned on after resetting, the Initial SETUP screen appears. See **First Step (P.7)**.

Safety Precautions and Important Information

Read this information carefully before starting to operate the Kenwood Car Navigation System and follow the instructions in this manual. Neither Kenwood nor Garmin shall be liable for problems or accidents resulting from failure to observe the instructions in this manual.

⚠️ WARNINGS

Failure to avoid the following potentially hazardous situations could result in an accident or collision resulting in death or serious injury.

When navigating, carefully compare information displayed on the navigation system to all available navigation sources, including information from street signs, visual sightings, and maps. For safety, always resolve any discrepancies or questions before continuing navigation.

Always operate the vehicle in a safe manner.

Do not become distracted by the navigation system while driving, and always be fully aware of all driving conditions. Minimize the amount of time spent viewing the screen of the navigation system while driving, and use voice prompts when possible.

Do not enter destinations, change settings, or access any functions requiring prolonged use of the navigation system controls while driving. Stop your vehicle in a safe and legal manner before attempting such operations.

Keep the system volume at a low enough level to be able to hear outside noises while driving. If you can no longer hear outside noises, you may be unable to react adequately to the traffic situation. This may cause accidents.

The navigation system will not display the correct current position of the vehicle the first time it is used after purchase, or if the vehicle battery is disconnected. GPS satellite signals will soon be received, however, and the correct position will be displayed.

Be careful of the ambient temperature. Using the navigation system at extreme temperatures can lead to malfunction or damage. Also note that the unit can be damaged by strong vibration, by metal objects, or by water getting inside the unit.

⚠️ CAUTIONS

Failure to avoid the following potentially hazardous situations may result in injury or property damage.

The navigation system is designed to provide you with route suggestions. It does not reflect road closures or road conditions, weather conditions, or other factors that may affect safety or timing while driving.

Use the navigation system only as a navigational aid. Do not attempt to use the navigation system for any purpose requiring precise measurement of direction, distance, location, or topography.

The Global Positioning System (GPS) is operated by the United States government, which is solely responsible for its accuracy and maintenance. The government system is subject to changes that could affect the accuracy and performance of all GPS equipment, including the navigation system. Although the navigation system is a precision navigation device, any navigation device can be misused or misinterpreted and, therefore, become unsafe.

IMPORTANT INFORMATION

🔋 Vehicle Battery Preservation

This navigation system can be used when the ignition key is turned to ON or ACC. To preserve the battery, however, it should be used with the engine running whenever possible. Using the navigation system for a long time with the engine switched off can cause the battery to run down.

🗺️ Map Data Information

One of the goals of Garmin is to provide customers with the most complete and accurate cartography that is available to us at a reasonable cost. We use a combination of governmental and private data sources, which we identify in product literature and copyright messages displayed to the consumer. Virtually all data sources contain some inaccurate or incomplete data. In some countries, complete and accurate map information is either not available or is prohibitively expensive.

Features of Connected systems

By connecting this unit to Internet, you can use various services.



■ Cooperation with Route Collector site

- Destinations and routes specified on the PC can be input to this navigation system. (DNN9150BT/ DNN9150BTM)
- The routes you have traveled and the songs you have listened to can be logged. (DNN9150BT/ DNN9150BTM)
- By uploading music files to Dropbox and creating a play list on Route Collector site, you can listen to music anywhere through streaming without music files on this unit.
- Speech to Text (STT) and Text to Speech (TTS).

■ Use of internet service

- Streaming service such as Aupeol.
- Internet service such as email, and social networking service such as Facebook and Twitter.
- Information (RSS, etc.) service.

■ 4G, 3G, LTE or EDGE

■ Wi-Fi access point

- Connect to Internet using the tethering function of your smartphone or an Internet device.

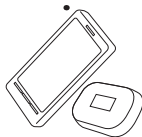

■ Wi-Fi (11n/g/b)



■ About the account

- To use internet services via this system, you need to create an account in the Route Collector site.
- In addition to the owner account, you can register up to four user accounts.
- You can use a guest account as well.
- By switching among accounts, you can secure the privacy when using the mail feature or social media.



■ Wi-Fi hotspot

- This unit becomes the Wi-Fi access point and you can enjoy music and video in a smartphone Wi-Fi connected by Kenwood Wireless Link.



Notes

- TTS (by Nuance)
- STT (by Nuance)

To use the following services, you need to register the corresponding free or paid accounts.

- Aupeol!
- Facebook
- Twitter
- Dropbox

First Step

Power on the unit and perform some setup steps before using.

1 Press the <HOME> button.

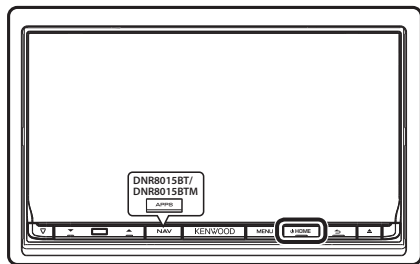

The unit is turned on.

• To turn off the unit:

Press the <HOME> button for 1 second.

NOTE

- "Initial setup" also appears when the unit is reset.

2 Touch the corresponding key and set the item.



Language Setup

Select the language used for the GUI and input methods. Default is "English (United States)".

- 1) Touch [Language Setup].
- 2) Select a language from the list.

WiFi Setup

Configure settings for connection to Wi-Fi.

- 1) Touch [Wifi Setup].
- 2) Slide Wi-Fi to ON.
- 3) Touch [Wi-Fi].
- 4) Select the Wi-Fi access point to register from the list.
- 5) Enter the Password.
- 6) Touch [Connect].

After setting, press the <↩> button.

Date Setup

Set the date and time.

- 1) Touch [Date Setup].
- 2) Touch [Select time zone]. (DNR8015BT/ DNR8015BTM only)
- 3) Select a time zone.

After setting, press the <↩> button.

Account Setup

Set the information about the user of this unit.

- 1) Touch [Account Setup].

See **Types of accounts**, **Create User Account** and **Set Owner Account**.

• Types of accounts

Administrator

As Administrator, you can create an owner account and perform initial setup.

You can log in to the system if you have not created an owner account.

Guest

An account for guests such as your friends.

The guest can operate this unit, but cannot use the functions related to mail, social media, and Route Collector site.

Owner

The account for the person who manages this unit.

The owner can use the functions related to mail, social media, and Route Collector site.

You can register users such as your family.

User

The account for the user of this unit.

The user can use the functions related to mail, social media, and Route Collector site.

You can register up to 4 user accounts.

• Create User Account

Preparation

- To register yourself in the Route Collector site as a user, you need a mail address.
- You can register yourself via the Web.
<http://www.route-collector.com/>
- This step may be skipped if you have already registered yourself in the Route Collector site.
 - 1) Touch [Create Account].
 - 2) Enter account information.
You cannot register an account which has already been used. Register another account name.
 - 3) Touch [OK].
The account is temporarily registered in the Route Collector site.
 - 4) Activate the account.
A confirmation mail is sent to the registered mail address. Open the indicated URL to complete account registration.
- **Set Owner Account**
 - 1) Touch [Set Owner Account].
 - 2) Enter account information.
Enter the information registered in the Route Collector site.
 - 3) Touch [OK].

3 Touch [Next].

4 Touch the corresponding key and set the item.



Locale (DNN9150BT/ DNN9150BTM)

Select the country for the navigation system.

The language, the distance unit, and the gasoline unit are set.

Language

Select the language used for the control screen and setting items. Default is "American English (en)".

After setting, touch [Enter].

Angle

Adjust the position of the monitor. Default is "0".

After setting, touch [].

Color

Set the screen and button illumination color. You can select whether to perform color scan and adjust scanning color.

After setting, touch [].

Camera

Set the parameters for the camera.

After setting, touch [].

DEMO

Set the demonstration mode. Default is "ON".

5 Touch [Finish].

NOTE

- For details on operations of each setting, refer to the Instruction Manual.

6 Touch [Administrator] or [Owner].

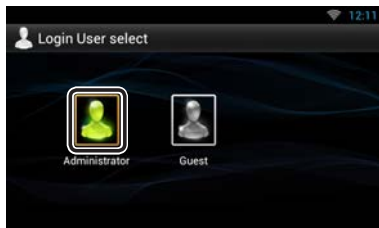

How to prepare the remote control

Insert two "AAA"/"R03"-size batteries with the ⊕ and ⊖ poles aligned properly, following the illustration inside the case.

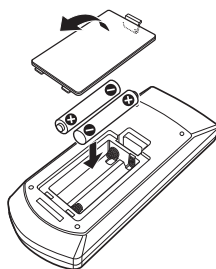

CAUTION

- Put the remote controller in a place where it will not move during braking or other operations. A dangerous situation could result, if the remote controller falls down and gets wedged under the pedals while driving.
- Do not leave the battery near fire or under direct sunlight. A fire, explosion or excessive heat generation may result.
- Do not recharge, short, break up or heat the battery or place it in an open fire. Such actions may cause the battery to leak fluid. If spilled fluid comes in contact with your eyes or on clothing, immediately rinse with water and consult a physician.
- Place the battery out of reach of children. In the unlikely event that a child swallows the battery, immediately consult a physician.

Functions of the Buttons on the Front Panel

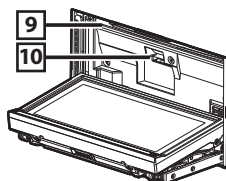
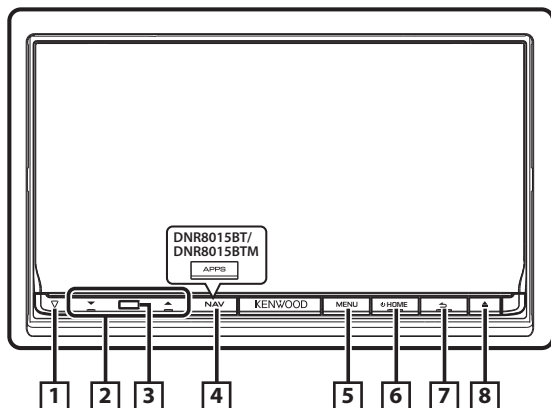

No.	Name/ Motion
1	<p>▽ (Reset)</p> <ul style="list-style-type: none"> If the unit or the connected unit fails to operate properly, the unit returns to initial settings when this button is pressed (Instruction Manual P.135). If the SI function is turned on, this indicator flashes when the vehicle ignition is off (Instruction Manual P.111).
2	<p>▲, ▼ (Vol)</p> <ul style="list-style-type: none"> Adjusts volume.
3	<p>Remote Sensor</p> <ul style="list-style-type: none"> Receives the remote control signal.
4	<p>NAV (DNN9150BT/ DNN9150BTM)</p> <ul style="list-style-type: none"> Displays the navigation screen. Pressing for 1 second turns the screen off.* <p>APPS (DNR8015BT/ DNR8015BTM)</p> <ul style="list-style-type: none"> Displays the APPS screen. Pressing for 1 second turns the screen off.*
5	<p>MENU</p> <ul style="list-style-type: none"> Displays the option menu screen. Pressing for 1 second switches AV out sources.

No.	Name/ Motion
6	<p>HOME</p> <ul style="list-style-type: none"> Displays the Home screen (P.12). Pressing for 1 second turns the power off. When the power off, turns the power on.
7	<p>↶ (Back)</p> <ul style="list-style-type: none"> Return to the previously viewed screen. Pressing for 1 second displays the Hands Free screen (Instruction Manual P.100).
8	<p>▲ (Eject)</p> <ul style="list-style-type: none"> Ejects the disc. When the panel is opened, pressing closes the panel and pressing for 1 second ejects the disc forcibly. When the panel is closed, pressing for 1 second fully opens the panel to the location of the SD card slot. (DNN9150BT/ DNN9150BTM)
9	<p>Disc insert slot</p> <ul style="list-style-type: none"> A slot to insert a disc media.
10	<p>SD card slot (DNN9150BT/ DNN9150BTM)</p> <ul style="list-style-type: none"> An SD card slot for upgrading the map. For how to upgrade the map, refer to the instruction manual of the navigation system.

* The function of the [NAV]/ [APPS] button can be changed to camera view function. (**Instruction Manual P.109**)

How to insert an SD card (DNN9150BT/ DNN9150BTM)

- 1) Press **[8]** <▲> button for 1 second.
The panel fully opens.
- 2) Hold the SD card as the illustration in the right and insert it into the slot until it clicks.

• To eject the card:

Push the card until it clicks and then remove your finger from the card.

The card pops up so that you can pull it out with your fingers.

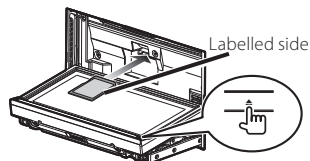

Common Operation

General

There are some functions which can be operated from most screens.

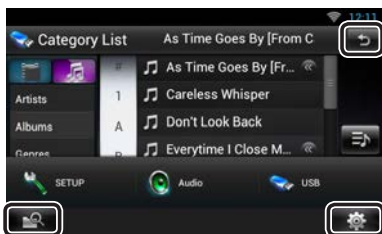



(Mixed Media Search)

Touch to display the Mixed Media Search screen.

(Quick menu)

Touch to display the quick menu. The content of the menu are as follows.

-  : Displays the SETUP Menu screen.
-  : Displays the Audio Control Menu screen.
-  : Displays the control screen of current source.
Icon feature differs depending on the source.

(RETURN)

Returns to previous screen.

List screen

There are some common function keys in the list screens of most sources.

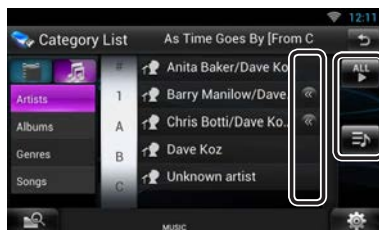

<< (Scroll)

Touch to scroll through texts on the display.

ALL etc.

Touch keys with various functions are displayed here.

Displayed keys differ depending on the current audio source, status, etc.

For examples, see **List screen (P.22)** in the Instruction Manual.

Flick scrolling

You can scroll the list screen by flicking the screen up/down or right/left.

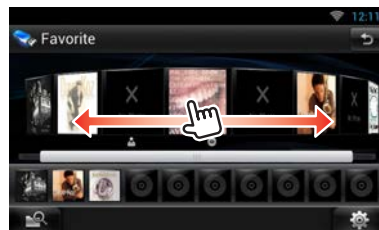
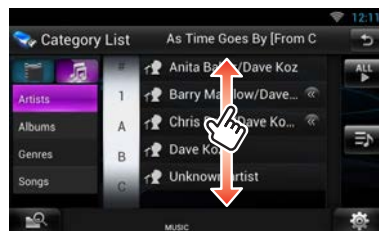

Login

- 1 Press the <HOME> button to turn the power on.
- 2 Select the login user.
- 3 Enter the password.



(Password)

Enter the registered password.

If you selected Administrator or Guest, this screen is not displayed.

[Auto Login?]

Checking this checkbox allows you to log in to the system automatically from the next time.

[Login]

Log in to the system.

NOTE

- If you forgot your password, create your new password on the Route Collector site.
<http://www.route-collector.com/>

Operation on the Home Screen

- 1 Press the <HOME> button to display the Home screen.
- 2 Flick the screen left or right to select the Service panel, Media panel, Source launcher panel, or Network contents panel.

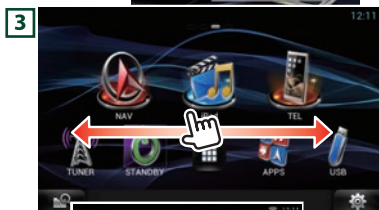

1 Service panel

Network widget: Displays the SNS, or RSS.

2 Media panel

Now playing: Displays the title of the song being played or the name of the station you are listening to, and allows you to perform simple operations.

Photo Frame Widget: Displays the Photo frame that shows photos.

3 Source launcher panel

Allows you select a source.

4 Network contents panel

Allows you to select a network-related application.

Source launcher panel



(Shortcut icon)

You can register sources you use frequently so that you can start them quickly.

(All source list)

Displays all sources.

• All source list



(All source list)

You can scroll the list screen by flicking the screen up/down.

(Home)

Returns to the Source launcher panel.

• Moving or deleting of an icon on the Source launcher panel

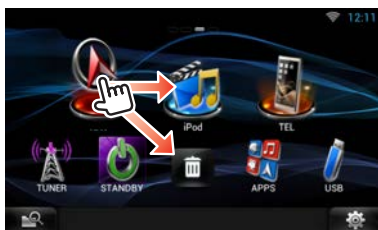

- 1) Touch and hold the icon.
- 2) Drag the icon to the desired position or Recycle Bin.

• Adding of a shortcut icon to Source launcher panel

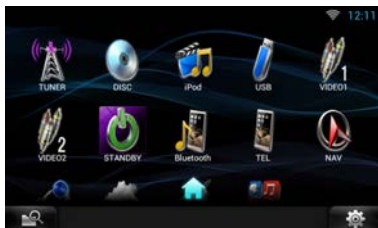

- 1) Touch [] in Source launcher panel.
- 2) Touching the icon continuously to display the Source launcher panel screen.
- 3) Drag the icon to an empty space.

How to Use the Navigation System (DNN9150BT/ DNN9150BTM)

1 Press the <NAV> button to display the navigation screen.

2 Operate the desired function from the Main Menu screen.



1	GPS satellite strength.
2	Finds a destination.
3	Views the map.
4	Uses the Apps such as ecoRoute and Help.
5	Adjusts the settings.

NOTE

- You can get additional information about using the navigation system from Help. To display Help, touch [Apps] and then touch [Help].



- For more information about your navigation system, download the latest version of the Owner's Manual from manual.kenwood.com/edition/im387

3 Enter your destination and start the guidance.

• Finding points of interest

- 1) Touch [Where To?].
- 2) Select a category and a subcategory.
- 3) Select a destination.
- 4) Touch [Go].

NOTE

- To enter letters contained in the name, touch the Search bar and enter the letters.

4 Follow your route to the destination.

NOTICE

- The speed limit icon feature is for information only and does not replace the driver's responsibility to abide by all posted speed limit signs and to use safe driving judgment at all times. Garmin and JVC KENWOOD will not be responsible for any traffic fines or citations that you may receive for failing to follow all applicable traffic laws and signs.

Your route is marked with a magenta line. As you travel, your navigation system guides you to your destination with voice prompts, arrows on the map, and directions at the top of the map. If you depart from the original route, your navigation system recalculates the route.



1	Views the Next Turn page or the junction view page, when available.
2	Views the Turn List page.
3	Views the Where Am I? page.
4	Stops the current route.
5	Displays traffic information on the route.
6	Returns to the Main Menu.

7	Displays a different data field.
8	Views the Trip Computer.
9	Displays more options.



NOTE

- Touch and drag the map to view a different area of the map.
- A speed limit icon could appear as you travel on major roadways.

• Adding a stop

- 1) While navigating a route, touch [] and then touch [Where To?].
- 2) Search for the extra stop.
- 3) Touch [Go!].
- 4) Touch [Add to Active Route] to add this stop before your final destination.

• Taking a detour

- 1) While navigating a route, touch [].
- 2) Touch [].

Other Features

• Manually avoiding traffic on your route (region code 3 area only)

- 1) From the map, touch the traffic icon.
- 2) Touch [Traffic On Route].
- 3) If necessary, touch the arrows to view other traffic delays on your route.
- 4) Touch [] > [Avoid].

• Viewing the traffic map (region code 3 area only)

- 1) The traffic map shows color-coded traffic flow and delays on nearby.

• About traffic (region code 3 area only)

NOTICE

- Traffic service is not available in some areas or countries.
- Garmin and JVC KENWOOD are not responsible for the accuracy or timeliness of the traffic information.
- Your navigation system can receive traffic information using the built-in traffic receiver. The traffic receiver must be in data range of a station transmitting traffic data to receive traffic information. The traffic subscription activates automatically after your navigation system acquires satellite signals while receiving traffic signals from the service provider.

• Updating the software

To update the navigation system software, you must have an SD card, a USB mass storage device and an internet connection.

- 1) Go to **www.garmin.com/kenwood**.
- 2) Find your model and select [Software Updates] > [Download].
- 3) Read and accept the terms of the Software License Agreement.
- 4) Follow the instructions on the Web site to complete the installation of the software update.

• Updating maps

You can purchase updated map data from Garmin or ask your Kenwood dealer or Kenwood service center for details.

- 1) Go to **www.garmin.com/kenwood**.
- 2) Select [Order Map Updates] for your Kenwood unit.
- 3) Follow the Web site instructions to update your map.

How to Play Music

You can play audio files from music CD, disc media, USB storage device and iPod.

NOTE

- For details on playable file format, media format, iPod model, etc., refer to the Instruction Manual. **(P.136)**
- To connect with iPod/iPhone/Android the setting is necessary. Refer to **iPod/iPhone/Android setup (P.29)**.

1 Connect the media you want to play as shown below.

Disc

- Press the <▲> button to open the front panel.
- Insert the disc into the slot.
The panel closes automatically and playback starts.

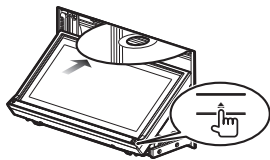

To eject the disc:

- Press the <▲> button.

iPod, USB device

- Connect the device with each cable.
Playback starts.

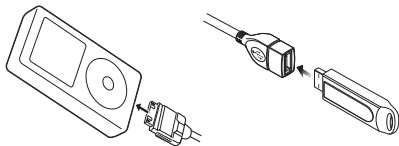

To disconnect the device:

- Touch [▲] on the screen and disconnect the device from the cable.

NOTE

- It applies when you set the iPod/iPhone connection with cable.

2 Control the music you are listening to on the source control screen.

The following symbols indicate the keys on the screen.

The functions of the keys are the same despite the difference of the source you are listening to.



Basic operations from this screen



Plays or pauses.



Stops playing.



Disconnects the device.



Searches the previous/next content.

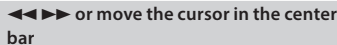

Fast forwards or Fast backwards (Disc media, CD, USB device only):



Repeats current content.



Plays all contents in random order.

NOTE

- For other operations, refer to the Instruction Manual.
- If desired key is not displayed in the multi-function bar, touch the [◀] to switch the menu.

3 Search the track/file you want to listen to.

List search

- Touch center of the screen.
The content list of the media being played is displayed.
If the information of the current track only is displayed, touch [▲] to switch the list display.



• Refined search

- 1) Touch [Q].
- 2) Touch the desired refinement method.
The list is refined by the item you selected.
- 3) Touch the desired item.

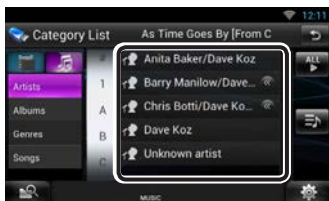

NOTE

- For details on searching operations, refer to **Search Operation (P.66)** in the Instruction Manual.

How to Play Movie

You can play DVD video, Video CD (VCD), movie files from disc media, iPod and USB storage device.

NOTE

- For details on playable file format, device format, etc., refer to the Instruction Manual.

1 Connect the media you want to play.

For the method of connecting, see **How to Play Music (P.16)**.

2 Control the movie by touching the screen.

Each area on the screen has a separate function.



No.	Name/Motion
1	Displays the movie control screen.
2	Displays the Source Control screen.
3	<ul style="list-style-type: none"> • Searches the next/previous content or file. • Scrolling from center of display to left or right performs fast backward or fast forward. To stop fast backward/forward, touch center of the display.*1

- *1 For iPod/USB, this function may be unavailable depending on the playing file format.



NOTE

- For operations on the source control screen, see **How to Play Music (P.16)**.
However, searching by category/link/album artwork is not available.

How to Listen to the Radio





- 1 Press the <HOME> button twice to the Source launcher panel.
- 2 Touch [] in the Source launcher panel.
- 3 Touch [TUNER].
The unit switches to the Radio tuner source.
- 4 Operate on the source control screen.

• Station search

- 1) Touch [].
Sub function menu appears.
- 2) Touch [AM] or [FM] to select the band.
- 3) Touch [] or [] to tune in the desired station.



• Auto memory

- 1) Touch [].
Sub function menu appears.
- 2) Touch [AM] or [FM] to select the band.
- 3) Touch [].
- 4) Touch [AME].
- 5) Touch [] or [] in the sub function menu.
Auto memory starts.

• Recalling the preset station

- 1) Touch [P#].
You can also display the preset list by touching the frequency display in the center.

NOTE



- For other operations, see **Radio Basic Operation (P.86)** in the Instruction Manual.

How to Make a Phone Call

You can use your Bluetooth cell-phone when paired to this unit.

1 Register your cell-phone to the unit.

Follow as the procedures shown below. For detailed operation, see **Registering the Bluetooth Unit (P.97)** in the Instruction Manual.

- 1) Press the <HOME> button twice to the Source launcher panel.
- 2) Touch [] in the Source launcher panel.
- 3) Touch [STANDBY].
- 4) Press and hold the <  > button.
- 5) Touch [].



- 6) Touch [Search].
Searched Device List screen appears.



- 7) Select your cell-phone from the displayed list in the Searched Device List screen.
- 8) Enter PIN code from the cell-phone.
Registering is completed.
The PIN code is set to "0000" as default.

2 Connect your cell-phone to the unit.

- 1) Touch the device name you want to connect in the Bluetooth SETUP screen.
- 2) Touch [ON] of [TEL(HFP)] in the BT Connection Settings screen.
The selected device is connected to the unit.



When registration of your cell-phone is completed, the phone book of the cell-phone is automatically downloaded to this unit.

NOTE

- Touch [Audio(A2DP)] if you want to connect the device as an audio player.

3 Make or receive a phone call.

See the table below for each operation method.



Call by entering a phone number

- 1) Touch [].
- 2) Enter a phone number with number keys.
- 3) Touch [].

Call using call records

- 1) Touch [] (Incoming Calls), [] (Outgoing Calls), or [] (Missed Calls).
- 2) Select the phone number from the list.
- 3) Touch [].

Call using the phonebook

- 1) Touch [].
- 2) Select the name from the list.
- 3) Select the number from the list.
- 4) Touch [].

Call using the preset number

- 1) Touch [Preset #] to start calling the corresponding phone number.

Call by voice

You can make a voice call using the voice recognition function of the cell-phone.

- 1) Touch [].
- 2) Pronounce the name registered in the cell-phone.

NOTE

- For detailed operation, see **Using Hands-Free Feature (P.100)** in the Instruction Manual.

Installation

■ Before Installation

Before installation of this unit, please note the following precautions.

⚠ WARNINGS

- If you connect the ignition wire (red) and the battery wire (yellow) to the car chassis (ground), you may cause a short circuit, that in turn may start a fire. Always connect those wires to the power source running through the fuse box.
- Do not cut out the fuse from the ignition wire (red) and the battery wire (yellow). The power supply must be connected to the wires via the fuse.

⚠ CAUTION

- Install this unit in the console of your vehicle. Do not touch the metal part of this unit during and shortly after the use of the unit. Metal part such as the heat sink and enclosure become hot.

🔪 NOTES

- Mounting and wiring this product requires skills and experience. For best safety, leave the mounting and wiring work to professionals.
- Make sure to ground the unit to a negative 12V DC power supply.
- Do not install the unit in a spot exposed to direct sunlight or excessive heat or humidity. Also avoid places with too much dust or the possibility of water splashing.
- Do not use your own screws. Use only the screws provided. If you use the wrong screws, you could damage the unit.
- If the power is not turned ON ("PROTECT" is displayed), the speaker wire may have a short-circuit or touched the chassis of the vehicle and the protection function may have been activated. Therefore, the speaker wire should be checked.
- If your car's ignition does not have an ACC position, connect the ignition wires to a power source that can be turned on and off with the ignition key. If you connect the ignition wire to a power source with a constant voltage supply, such as with battery wires, the battery may be drained.
- If the console has a lid, make sure to install the unit so that the faceplate will not hit the lid when closing and opening.
- If the fuse blows, first make sure the wires aren't

touching to cause a short circuit, then replace the old fuse with one with the same rating.



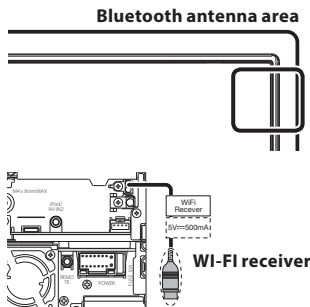



- Insulate unconnected wires with vinyl tape or other similar material. To prevent a short circuit, do not remove the caps on the ends of the unconnected wires or the terminals.
- Connect the speaker wires correctly to the terminals to which they correspond. The unit may be damaged or fail to work if you share the \ominus wires or ground them to any metal part in the car.
- When only two speakers are being connected to the system, connect the connectors either to both the front output terminals or to both the rear output terminals (do not mix front and rear). For example, if you connect the \oplus connector of the left speaker to a front output terminal, do not connect the \ominus connector to a rear output terminal.
- After the unit is installed, check whether the brake lamps, blinkers, wipers, etc. on the car are working properly.
- Mount the unit so that the mounting angle is 30° or less.
- This unit has the cooling fan (**P.24**) to decrease the internal temperature. Do not mount the unit in a place where the cooling fan of the unit is blocked. Blocking these openings will inhibit the cooling of the internal temperature and result in malfunction.
- Do not press hard on the panel surface when installing the unit to the vehicle. Otherwise scars, damage, or failure may result.
- Reception may drop if there are metal objects near the Bluetooth antenna and WI-FI receiver.

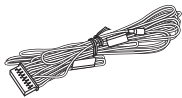
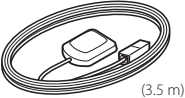
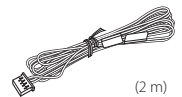

- Install the WI-FI receiver besides the place enclosed by the metal.

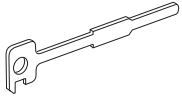
■ Supplied accessories

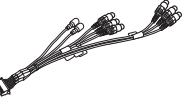
First of all, make sure that all accessories are supplied with the unit.

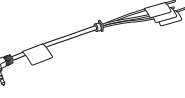
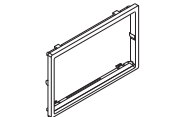
① ...1	⑦ *1 ...1
	 (3.5 m)
② ...1	⑧ *1 ...1
 (2 m)	
③ ...2	⑨ ...1
	 (3 m)
④ ...6	⑩ ...1
 (M5x6mm)	
⑤ ...6	⑪ ...1
 (M5x7mm)	
⑥ ...1	*1 DNN9150BT/ DNN9150BTM only
	

■ Unit

- 1) To prevent a short circuit, remove the key from the ignition and disconnect the ⊖ terminal of the battery.
- 2) Make the proper input and output wire connections for each unit.
- 3) Connect the speaker wires of the wiring harness.
- 4) Connect the wiring harness wires in the following order; ground, battery, ignition.
- 5) Connect the wiring harness connector to the unit.
- 6) Install the unit in your car.
- 7) Reconnect the ⊖ terminal of the battery.
- 8) Press the <Reset> button. **(P.4)**
- 9) Perform the Initial Setup.
See **First Step (P.7)**.

• Non-Japanese cars

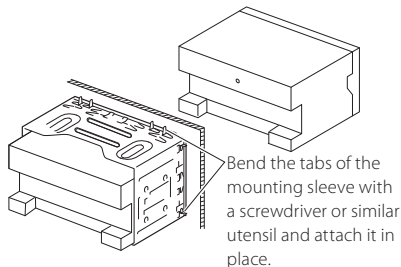

• Japanese cars

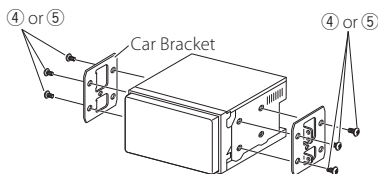

NOTE

- Make sure that the unit is installed securely in place. If the unit is unstable, it may malfunction (eg, the sound may skip).

■ Trim plate

- 1) Attach accessory ⑥ to the unit.

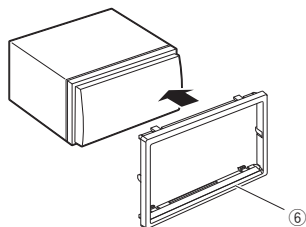

■ GPS antenna (DNN9150BT/ DNN9150BTM)

GPS antenna is installed inside of the car. It should be installed as horizontally as possible to allow easy reception of the GPS satellite signals.

To mount the GPS antenna inside your vehicle:

- 1) Clean your dashboard or other surface.
- 2) Remove the separator of the metal plate (accessory ⑧).
- 3) Press the metal plate (accessory ⑧) down firmly on your dashboard or other mounting surface. You can bend the metal plate (accessory ⑧) to conform to a curved surface, if necessary.
- 4) Remove the separator of the GPS antenna (accessory ⑦), and stick the antenna to the metal plate (accessory ⑧).

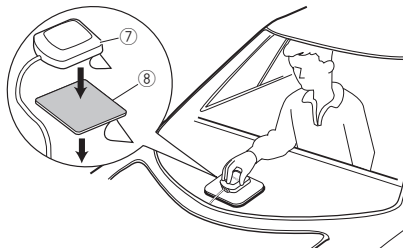

🔑 NOTE

- Depending on the type of car, reception of the GPS satellite signals might not be possible with an inside installation.
- Please install this GPS antenna in an area away from any antennas that are used with CB radios or satellite televisions.
- The GPS antenna should be installed at a position that is spaced at least 12 inch (30 cm) from cellular phone or other transmitting antennas. Signals from the GPS satellite may be interfered with by these types of communication.

- Painting the GPS antenna with (metallic) paint may cause a drop in performance.

■ Microphone unit

- 1) Check the installation position of the microphone (accessory ⑨).
- 2) Clean the installation surface.
- 3) Install the microphone.
- 4) Wire the microphone cable up to the unit with it secured at several positions using tape or other desired method.

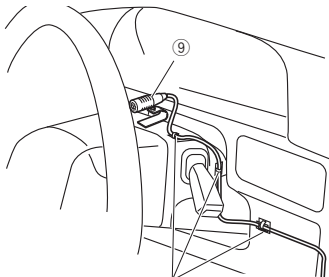

Fix a cable with a commercial item of tape.

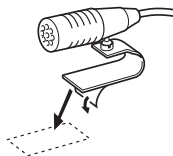

Remove the separator of the microphone, and stick the microphone to the place shown above.



Adjust the direction of the microphone to the driver.

🔑 NOTE

- Install the microphone as far as possible from the cell-phone.

■ Removing the trim plate

- 1) Engage the catch pins on the extraction key (accessory③) and remove the two locks on the lower level.

Lower the trim plate (accessory⑥) and pull it forward as shown in the figure.

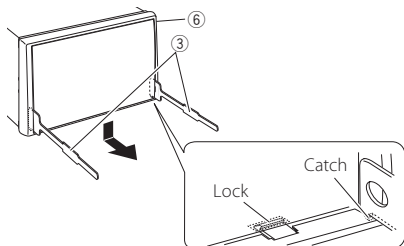

NOTE

- The trim plate can be removed from the top side in the same manner.
- 2) When the lower level is removed, remove the upper two locations.

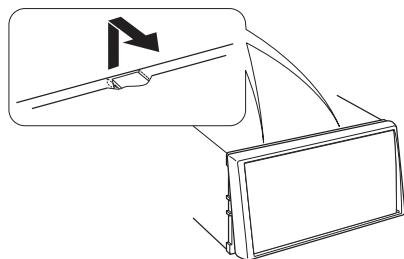

■ Removing the unit

- 1) Remove the trim plate by referring to **step 1 in "Removing the trim plate"**.
- 2) Insert the two extraction key (accessory③) deeply into the slots on each side, as shown.

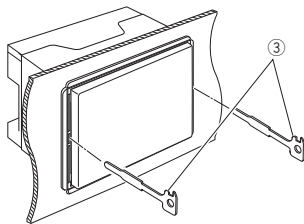

- 3) Lower the extraction key toward the bottom, and pull out the unit halfway while pressing towards the inside.

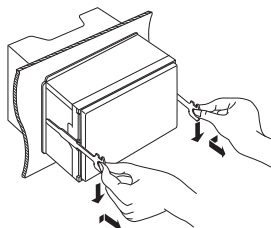

NOTE

- Be careful to avoid injury from the catch pins on the extraction key.
- 4) Pull the unit all the way out with your hands, being careful not to drop it.

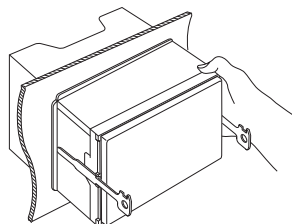

■ Connecting wires to terminals

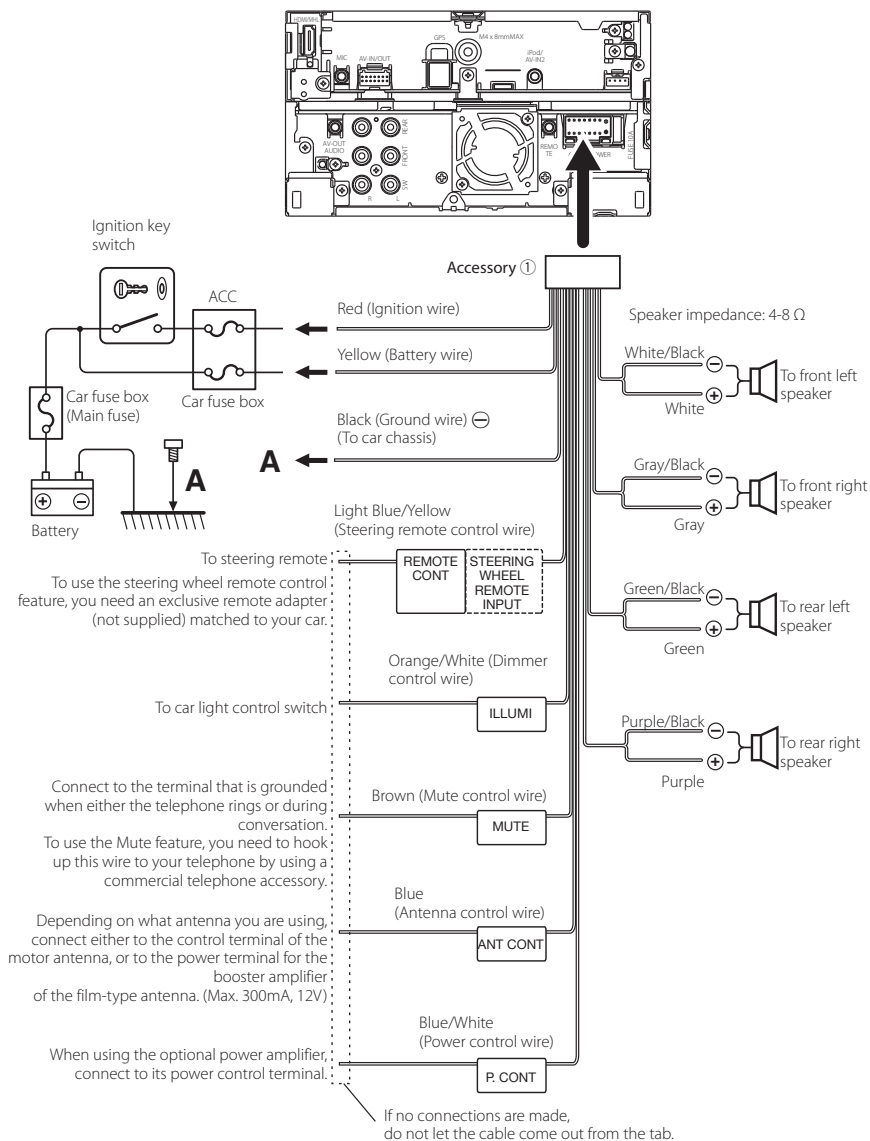

System connection

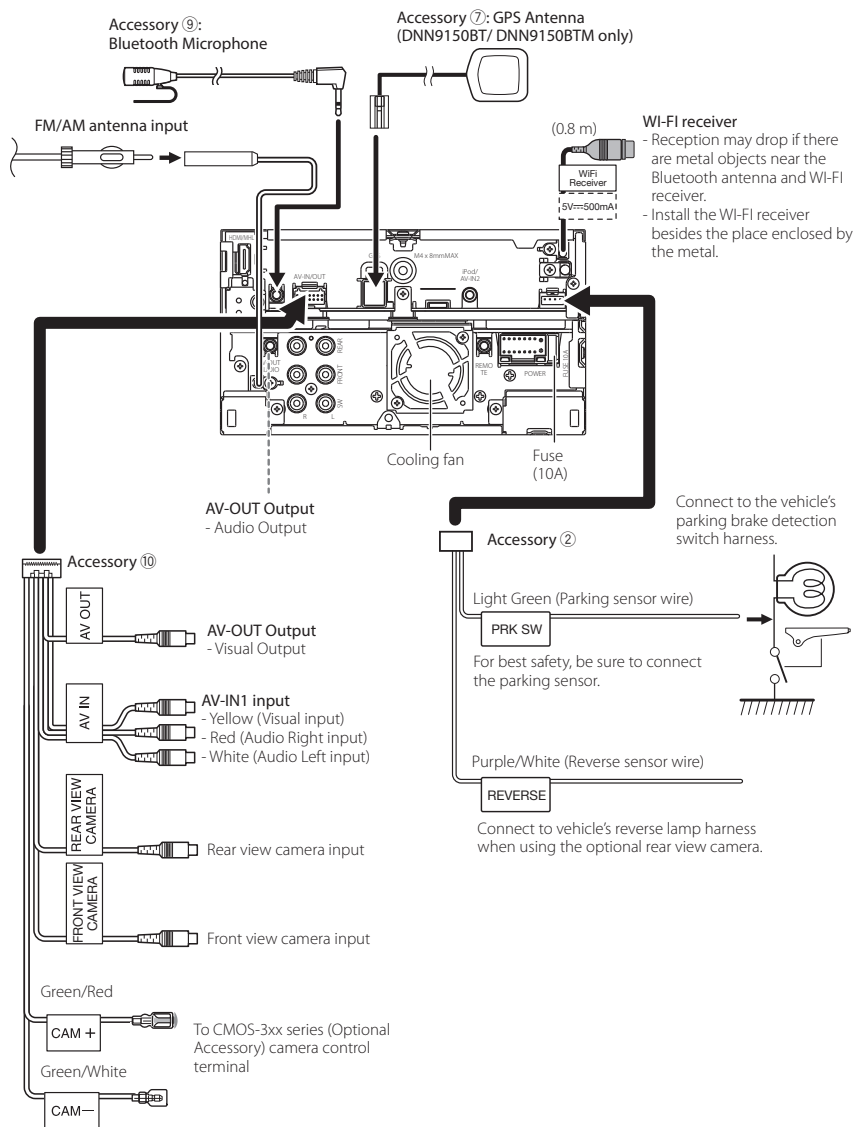

3 way speaker system setup

Region code 3 area

Connect the speaker wires

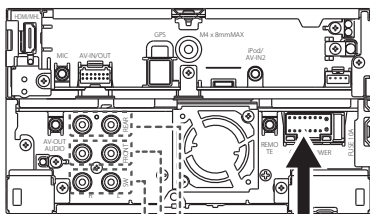

Subwoofer Preout

- Red (Audio Right Output)
- White (Audio Left Output)

Mid Range Preout

- Red (Audio Right Output)
- White (Audio Left Output)

Tweeter Preout

- Red (Audio Right Output)
- White (Audio Left Output)

Accessory ①

Speaker impedance: 4-8 Ω

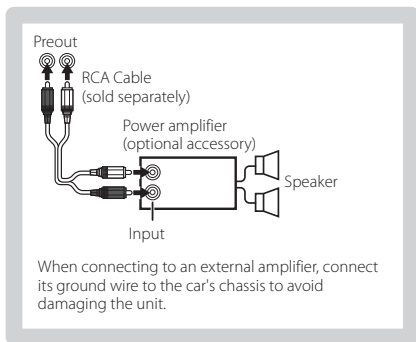
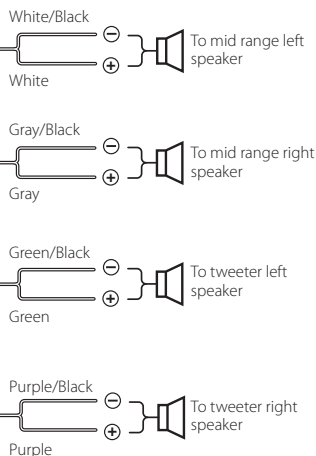

NOTE

- For how to connect speaker wires to terminals other than speaker terminals and Preout terminals, see **Connecting wires to terminals (P.24)** and **System connection (P.25)**.

Switching between speaker systems

Switch to the 3 way speaker system following the procedure below.



- Be sure to set the speaker network correctly. Connecting 3 way speakers with the 2 way mode selected can break the speakers.

1 Press the <HOME> button twice to the Source launcher panel.

2 Touch [] in the Source launcher panel.

3 Touch [STANDBY].

4 Press the <▼> button and <▲> button for 1 second at the same time.

Speaker system select screen appears.

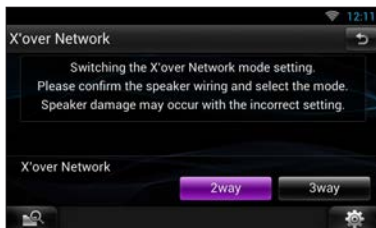
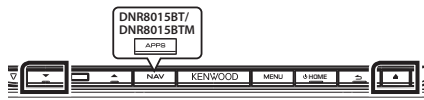

5 Touch [3way].

A confirmation screen appears.



6 Touch [Yes].

The 2 way speaker system is switched to the 3 way speaker system.

 **NOTE**

- When the 3-way speaker system is selected, the following functions are disabled. (See the Instruction Manual.)
 - **Zone Control (P.126)**
 - **DSP select (P.122)**
 - Fader of **Controlling General Audio (P.122)**
- For speaker setup and crossover setup, see **Setting Audio (P.118)** in the Instruction Manual.

Optional accessory connection

**DNN9150BT/
DNN9150BTM**

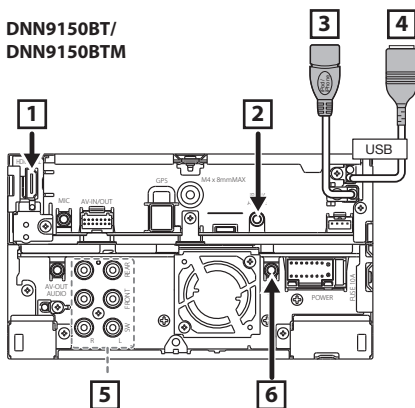

**DNR8015BT/
DNR8015BTM**

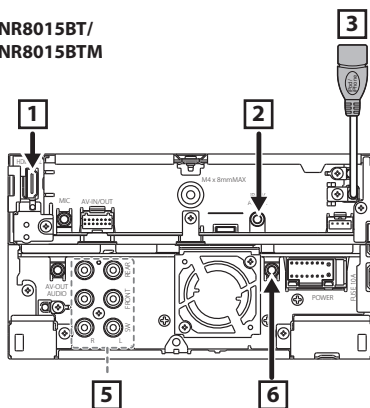

USB device
(sold separately)

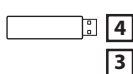

Android smartphone
(sold separately)



KCA-MH100 (1.8m)
(Optional Accessory)

- 1** HDMI/ MHL input
MHL maximum power supply current :
5 V \pm 900 mA

When you connect the cable to HDMI/MHL terminal, remove the fixture. After connecting the cable, put the fixture again.

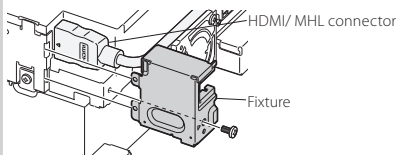

5 Rear Preout
- Red (Audio Right Output)
- White (Audio Left Output)

Front Preout
- Red (Audio Right Output)
- White (Audio Left Output)

Subwoofer Preout
- Red (Audio Right Output)
- White (Audio Left Output)

When connecting to an external amplifier, connect its ground wire to the car's chassis to avoid damaging the unit.

- 2** iPod input / AV-IN2 (CA-C3AV; Optional Accessory) input
(iPod/ AV-IN2 switchable)

- 3** iPod/ USB terminal (0.8m)
iPod/ USB maximum power supply current :
5 V \pm 1 A

- 4** USB terminal (0.8m)
(DNN9150BT/ DNN9150BTM only)
USB maximum power supply current :
5 V \pm 500 mA

- 6** Accessory **①** Steering remote harness
Connect to vehicle's steering remote harness.
Contact your Kenwood dealer for details.

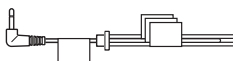

iPod/ iPhone/ Android setup

Android connection

To connect the Android device with this unit, the cable (sold separately) and the profile which your Android device supports are necessary as follows:

- **To listen to music and watch video of APPS source**

- MHL device
- KCA-MH100
- Bluetooth profile: SPP
- Application link setup: HDMI/MHL + BT (**P.31**)

- **To listen to music of APPS source**

- Bluetooth profile: A2DP
- Bluetooth profile: SPP
- Application link setup: Bluetooth (**P.31**)

- **To listen to music of Bluetooth Audio source**

- Bluetooth profile: A2DP
- Bluetooth profile: AVRCP

NOTE

- When you select Pandora source the setting of **Application link setup (P.31)** is also necessary.
- In the APPS source, some functions can be controlled from this unit and they depend on the applications. Refer to **Apps Operation (P.74)** in the Instruction Manual.
- Do not leave the cable or the adapter made by other makers inside the car. It might lead the malfunction caused by heat.

iPod/iPhone connection and setting

- **Connectable iPod/iPhone**

The following models can be connected to this unit.

Made for

- iPhone 5s
- iPhone 5c
- iPhone 5
- iPhone 4S
- iPhone 4
- iPhone 3GS
- iPhone 3G
- iPhone
- iPod touch (5th generation)
- iPod touch (4th generation)
- iPod touch (3rd generation)

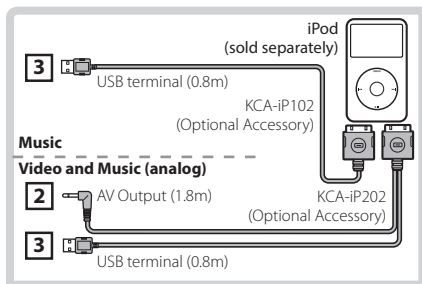
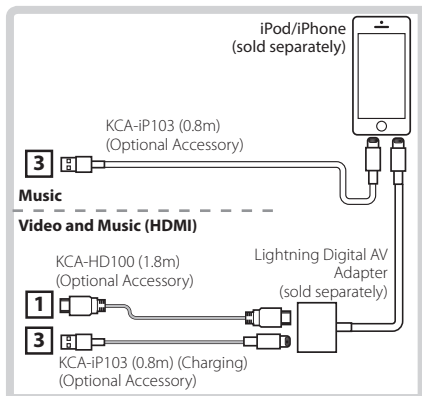

NOTE

- For the connection and the setting of iPod/iPhone refer to **iPod/iPhone connection and setting (P.29)**.
- For the connection and the setting of Android smartphone refer to **Android connection (P.29)**.

- iPod touch (2nd generation)
- iPod touch (1st generation)
- iPod classic
- iPod with video
- iPod nano (7th generation)
- iPod nano (6th generation)
- iPod nano (5th generation)
- iPod nano (4th generation)
- iPod nano (3rd generation)

• iPod/iPhone connection

To connect the iPod/iPhone with this unit, the cable, adapter (both sold separately), and the profile which your iPod/iPhone supports are necessary as follows:

- **To listen music and watch video with Lightning connector device**
 - Lightning Digital AV Adapter
 - KCA-HD100
 - KCA-iP103
 - Bluetooth profile: SPP
 - iPod connection setup: HDMI + BT **(P.30)**
- **To listen music with Lightning connector device**
 - KCA-iP103
 - iPod connection setup: USB 1Wire **(P.30)**
- **To listen music and watch video with 30-pin connector device (analog)**
 - KCA-iP202
 - iPod connection setup: USB+AV-IN **(P.30)**
- **To listen music with 30-pin connector device**
 - KCA-iP102
 - iPod connection setup: USB 1Wire **(P.30)**
- **To listen to music via Bluetooth**
 - Bluetooth profile: A2DP
 - Bluetooth profile: SPP
 - iPod connection setup: Bluetooth **(P.30)**
- **To listen to music of Bluetooth Audio source**
 - Bluetooth profile: A2DP
 - Bluetooth profile: AVRCP

NOTE

- When you select Pandora source the setting of **Application link setup (P.31)** is also necessary.
- In the APPS source, some functions can be controlled from this unit and they depend on the applications. Refer to **Apps Operation (P.74)** in the Instruction Manual.
For the setting refer to **Application link setup (P.31)**.
- Do not leave the cable or the adapter made by

other makers inside the car. It might lead the malfunction caused by heat.

• iPod/iPhone connection setup

When you first select iPod as a source, the setting screen of the iPod/iPhone connection will appear.

- 1 Press the <HOME> button twice to the Source launcher panel.
- 2 Touch [] in the Source launcher panel.
- 3 Touch [iPod].
iPod connection setup screen appears.
- 4 Touch [CHANGE].
- 5 Set each item as follows.



USB + AV-IN

Select when connecting with KCA-iP202.

USB 1Wire

Select when connecting with KCA-iP103 or KCA-iP102.

HDMI + BT

Select when connecting with KCA-HD100 and Lightning Digital AV Adapter.

Bluetooth

Select when connecting via Bluetooth only.

6 Touch [Next].

Confirmation screen appears.

7 Touch [Done].

NOTE

- When you select "HDMI + BT" or "Bluetooth" in step 5, Bluetooth device selection screen will appear. Select the iPod/iPhone to be connected.

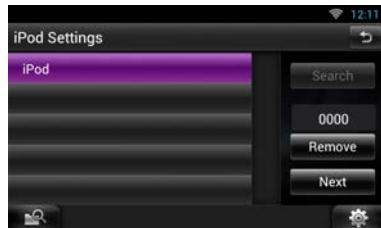

If a connectable Bluetooth device is not displayed, touch [Search] and do the pairing of the devices.

- "iPod connection setup" also appears when the unit is reset.
- The setting of "iPod connection setup" is just for the unit and regardless of the account.

Application link setup

When you first select Apps as a source, the setting screen for the connection with the device installed the apps will appear.

1 Press the <HOME> button twice to the Source launcher panel.

2 Touch [] in the Source launcher panel.

3 Touch [APPS].

Application link setup screen appears.

4 Touch [CHANGE].

5 Select the device installed the apps.

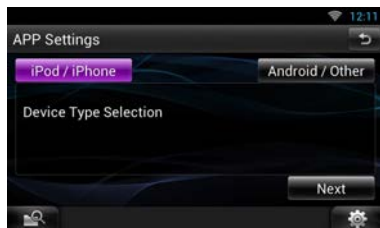

6 Select the way to connect the device with this unit.

- When selecting [iPod/iPhone]



For the setting items refer to *iPod/iPhone connection setup (P.30)*.

- When selecting [Android/Other]

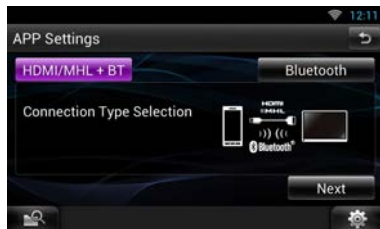

HDMI/MHL + BT

Select when connecting with KCA-MH100.

Bluetooth

Select when connecting via Bluetooth only.

7 Touch [Next].

Confirmation screen appears.

8 Touch [Done].

NOTE

- For the details of the necessary cable and adapter to connect with iPod/iPhone and Android, refer to **iPod/iPhone connection and setting (P.29)** and **Android connection (P.29)**.
- When you select "HDMI + BT", "HDMI/MHL + BT" or "Bluetooth" in step 6, Bluetooth device selection screen will appear. Select the device to be connected.

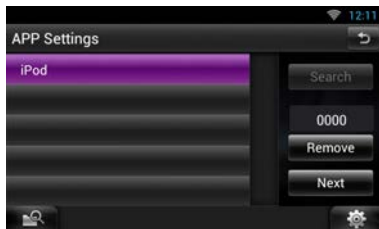

If a connectable Bluetooth device is not displayed, touch [Search] and do the pairing of the devices.

- "Application link setup" also appears when the unit is reset.
- The setting of "Application link setup" is just for the unit and regardless of the account.

About This Unit

Requirements Pandora®:

Requirements for listening to the Pandora® are as follows:

- A smartphone with the latest Pandora application installed.
- A Pandora account (if you do not have an account, create one for free using the mobile app or on www.pandora.com).
- An active internet connection.

iPhone or iPod touch

- Apple iPhone or iPod touch with iOS 3 or later installed.
- Latest version of the Pandora application (search App Store for Pandora and install).

Android™

- Latest version of the Pandora Android application (search Google Play for Pandora and install).

BlackBerry®

- Visit www.pandora.com from the built in browser to download the Pandora application.
- Bluetooth must be built in and the following profiles must be supported.
 - SPP (Serial Port Profile)
 - A2DP (Advanced Audio Distribution Profile)

NOTE

- The Pandora service is available only in the U.S., Australia and New Zealand.
- Because Pandora® internet radio is a third-party service, the specifications are subject to change without prior notice. Accordingly, compatibility may be impaired or some or all of the services may become unavailable.
- Some Pandora® functionality cannot be operated from this unit.
- For issues using the Pandora® application, please contact Pandora at pandora-support@pandora.com

Copyrights

- The Bluetooth word mark and logos are owned by the Bluetooth SIG, Inc. and any use of such marks by JVC KENWOOD Corporation is under license. Other trademarks and trade names are those of their respective owners.
- The "AAC" logo is a trademark of Dolby Laboratories.
- "Made for iPod" and "Made for iPhone" mean that an electronic accessory has been designed to connect specifically to iPod, or iPhone, respectively, and has been certified by the developer to meet Apple performance standards. Apple is not responsible for the operation of this device or its compliance with safety and regulatory standards. Please note that the use of this accessory with iPod, or iPhone may affect wireless performance.
- iPhone, iPod, iPod classic, iPod nano, and iPod touch are trademarks of Apple Inc., registered in the U.S. and other countries. Lightning is a trademark of Apple Inc.
-  is a trademark of DVD Format/Logo Licensing Corporation registered in the U.S., Japan and other countries.
- This item incorporates copy protection technology that is protected by U.S. patents and other intellectual property rights of Rovi Corporation. Reverse engineering and disassembly are prohibited.
- Manufactured under license from Dolby Laboratories. Dolby and the double-D symbol are trademarks of Dolby Laboratories.

- Adobe, Acrobat and Reader are either registered trademarks or trademarks of Adobe Systems Incorporated in the United States and/or other countries.
- Android is a trademark of Google Inc.
- Twitter is a registered trademark of Twitter, Inc.
- Facebook® is a registered trademark of Facebook Inc.
- Nuance is a registered trademark of Nuance Communications, Inc.
- “aupeo” is a trade mark of Aupeo Ltd.
- Dropbox is a trademark of Dropbox Inc.
- The terms HDMI and HDMI High-Definition Multimedia Interface, and the HDMI logo are trademarks or registered trademarks of HDMI Licensing LLC in the United States and other countries.
- MHL and the MHL logo are a trademark or registered trademark of MHL, LLC.
 - Incorporates MHL 2
- ABOUT DIVX VIDEO: DivX® is a digital video format created by DivX, LLC, a subsidiary of Rovi Corporation. This is an official DivX Certified® device that plays DivX video. Visit divx.com for more information and software tools to convert your files into DivX videos.
- ABOUT DIVX VIDEO-ON-DEMAND: This DivX Certified® device must be registered in order to play purchased DivX Video-on-Demand (VOD) movies. To obtain your registration code, locate the DivX VOD section in your device setup menu. Go to vod.divx.com for more information on how to complete your registration.
- DivX®, DivX Certified® and associated logos are trademarks of Rovi Corporation or its subsidiaries and are used under license.
- QR Code® is registered trademarks of DENSO WAVE INCORPORATED in JAPAN and other countries.
- The aptX® software is copyright CSR plc or its group companies. All rights reserved. The aptX® mark and the aptX logo are trade marks of CSR plc or one of its group companies and may be registered in one or more jurisdictions.
- AVC
THIS PRODUCT IS LICENSED UNDER THE AVC PATENT PORTFOLIO LICENSE FOR THE PERSONAL USE OF A CONSUMER OR OTHER USES IN WHICH IT DOES NOT RECEIVE REMUNERATION TO (i) ENCODE VIDEO IN COMPLIANCE WITH THE AVC STANDARD (“AVC VIDEO”) AND/OR (ii) DECODE AVC VIDEO THAT WAS ENCODED BY A CONSUMER ENGAGED IN A PERSONAL ACTIVITY AND/OR WAS OBTAINED

FROM A VIDEO PROVIDER LICENSED TO PROVIDE AVC VIDEO. NO LICENSE IS GRANTED OR SHALL BE IMPLIED FOR ANY OTHER USE. ADDITIONAL INFORMATION MAY BE OBTAINED FROM MPEG LA, L.L.C. SEE [HTTP://WWW.MPEGLA.COM](http://WWW.MPEGLA.COM)

- MPEG-4 Visual
THIS PRODUCT IS LICENSED UNDER THE MPEG-4 VISUAL PATENT PORTFOLIO LICENSE FOR THE PERSONAL AND NON-COMMERCIAL USE OF A CONSUMER FOR (i) ENCODING VIDEO IN COMPLIANCE WITH THE MPEG-4 VISUAL STANDARD (“MPEG-4 VIDEO”) AND/OR (ii) DECODING MPEG-4 VIDEO THAT WAS ENCODED BY A CONSUMER ENGAGED IN A PERSONAL AND NON-COMMERCIAL ACTIVITY AND/OR WAS OBTAINED FROM A VIDEO PROVIDER LICENSED BY MPEG LA TO PROVIDE MPEG-4 VIDEO. NO LICENSE IS GRANTED OR SHALL BE IMPLIED FOR ANY OTHER USE. ADDITIONAL INFORMATION INCLUDING THAT RELATING TO PROMOTIONAL, INTERNAL AND COMMERCIAL USES AND LICENSING MAY BE OBTAINED FROM MPEG LA, LLC. SEE [HTTP://WWW.MPEGLA.COM](http://WWW.MPEGLA.COM).
- libFLAC

Copyright (C) 2000,2001,2002,2003,2004,2005,2006,2007,2008,2009 Josh Coalson

Redistribution and use in source and binary forms, with or without modification, are permitted provided that the following conditions are met:

- Redistributions of source code must retain the above copyright notice, this list of conditions and the following disclaimer.
- Redistributions in binary form must reproduce the above copyright notice, this list of conditions and the following disclaimer in the documentation and/or other materials provided with the distribution.
- Neither the name of the Xiph.org Foundation nor the names of its contributors may be used to endorse or promote products derived from this software without specific prior written permission.

THIS SOFTWARE IS PROVIDED BY THE COPYRIGHT HOLDERS AND CONTRIBUTORS “AS IS” AND ANY EXPRESS OR IMPLIED WARRANTIES, INCLUDING, BUT NOT LIMITED TO, THE IMPLIED WARRANTIES OF MERCHANTABILITY AND FITNESS FOR A PARTICULAR PURPOSE ARE DISCLAIMED. IN NO EVENT SHALL THE FOUNDATION OR CONTRIBUTORS BE LIABLE FOR ANY DIRECT, INDIRECT, INCIDENTAL, SPECIAL, EXEMPLARY, OR CONSEQUENTIAL DAMAGES (INCLUDING, BUT NOT LIMITED TO, PROCUREMENT OF SUBSTITUTE GOODS OR SERVICES; LOSS OF USE, DATA, OR PROFITS; OR BUSINESS INTERRUPTION) HOWEVER CAUSED AND ON ANY THEORY OF

LIABILITY, WHETHER IN CONTRACT, STRICT LIABILITY, OR TORT (INCLUDING NEGLIGENCE OR OTHERWISE) ARISING IN ANY WAY OUT OF THE USE OF THIS SOFTWARE, EVEN IF ADVISED OF THE POSSIBILITY OF SUCH DAMAGE.

■ KENWOOD Route Network Service “Route Collector” User’s Agreement

This KENWOOD Route Network Service “Route Collector” User’s Agreement (“Agreement”) sets forth the terms and conditions for use of the KENWOOD Route Network Service “Route Collector” provided by JVC KENWOOD Corporation (“Service”) to the users who fulfill the requirements for “Conditions of Use” in the paragraph 1 (“User(s)”), and the rules for handling User’s information necessary for use this Service.

1. Conditions of Use

Users who desire to take advantage of this Service must however first register themselves upon agreeing to the terms of this Agreement. This Service may only be used by Users for personal use, not for commercial use.

The terms of this Agreement may be revised or modified as necessary at our option without prior notice. In such event, Users shall hereby agree to the application of any such revisions or modifications as a condition to continued use of the Service.

Also, Users shall be solely responsible for managing and using their registered user account names and passwords. In no event can we accept any responsibility for any problems or damages resulting from the User’s management and usage of its user account name and password management.

2. Period for the Service

Users may in principal continue to use the Service as long as it is being provided by us. However, the Service may be changed, suspended or cancelled at our option without prior notice.

3. Disclaimer

The User shall undertake use of the Service at its own individual responsibility, and accordingly we shall not assume any responsibility for usage of the Service by the User, including but not limited to the examples as follows.

- (1) We shall make no warranty as to completeness, legality, moral correctness, recentness, and appropriateness of the Service and the User shall assume full risk and individual responsibility for using the Service.

- (2) We shall assume no responsibility for any loss or damage that may be incurred by the User due to its use of or inability to use the Service, regardless of whether such loss or damage is direct or indirect, foreseeable or unforeseeable, including but not limited to special damages.
- (3) We shall not be involved in nor assume responsibility for any acts, problems, and other issues between Users.
- (4) Should any third parties suffer losses or damages as a result of the User’s use of the Service, we shall assume no responsibility therefor.
- (5) Should the User suffer losses or damages from misuse by any third parties of the User’s registered user account name or password for the Service, we shall assume no responsibility therefor.

4. Prohibited Matters

Concerning the use of the Service, the following or similar acts by the User are prohibited. Further, should we determine that the User has violated the terms of this Agreement, we reserve the right to suspend use of the Service by the User without prior notice, or take other necessary measures as we may deem necessary. In such case, we bear no obligation to disclose our reasons therefor.

- (1) Acts for commercial purposes or gain
- (2) Use of the account name or password of his own or any third parties for improper purposes
- (3) Infringement or acts that may likely infringe on the intellectual property rights of third parties (including but not limited to copyrights, design rights, patent, utility model rights, trademark, trade secrets, and know-how)
- (4) Infringement or acts that may likely infringe on the proprietary rights, honor, trustworthiness, portrait rights, privacy, publicity rights, and other rights or profits
- (5) Dissemination or distribution or acts that may likely constitute dissemination or distribution of contents that may be offensive to public morals and morals, or defamatory to third parties
- (6) Criminal acts, acts associated with criminal acts, or acts that may likely be criminal
- (7) Dissemination or distribution of junk mail, spam or malicious programs such as the computer viruses
- (8) Dissemination or distribution of false information
- (9) Obstruction or acts that may likely constitute obstruction of the operation of the Service

- (10) Acts that cause or that may likely cause trouble, disadvantages or damages to us or third parties
- (11) Use of the Service for illegal purposes
- (12) Other acts deemed inappropriate by us

5. Compensation Claim

Should any complaints, lawsuits or similar claims be asserted against us by other Users or third parties for any reasons attributable to the User in connection with the Service, we reserve the right to claim from the concerned User any damages, costs and expenses which we may incur (including compensation, attorney fees and legal costs).

6. Ownership of Intellectual Property Rights

All intellectual property rights (including but not limited to copyrights, design rights, patent, utility model rights, trademark, trade secrets, and know-how), the portrait rights, privacy, publicity rights and other personal rights, and proprietary rights or other property rights of the information, text, image, program, layout, design, architecture, and others related to the Service are owned by us, or provided to us under license from the rights holder except for the rights of the thing which are made by User. The unauthorized copying, alteration, or sublicensing of such intellectual property rights, in whole or in part, without our consent may be prohibited by applicable law.

Further, our trade names, trademarks, logo marks and product names, some of which are registered, are used as names and symbols for commercial purposes. Also, trademarks, service names, symbols and other marks belonging to other parties, such as companies and individuals, are also included in the Service.

7. Use of Public Information

We may save and store all information (including but not limited to text information, image information, and others) that were released, posted, uploaded, or saved by User via the Service. Furthermore, User shall agree that we may use such information as described previously in every possible condition toward smooth operation and improvement of the Service.

8. Usage Fee

The Service shall be offered without charge to the User. However, the environment that is necessary for use this Service shall be prepared by User on his own responsibility and liability including any miscellaneous expenses such as provider, electricity, packet communication, and others.

9. User Information

In order to take advantage of the Service, the User must first register user account name, password, the User's valid e-mail address and arbitrary User's information via the next page (collectively "Information"). We shall properly manage and keep Information as important data in conformity with our "Privacy Policy" and shall only use Information for issuing notices regarding completion of registration, maintenance of Service, suspension of Service, and procedures for reissuance of passwords. We shall not disclose Information for any purposes other than the foregoing without the prior consent of the User.

10. Governing Law

The Agreement shall be governed by and construed in accordance with the laws of Japan.

■ About QAU0569 (USB Wi-Fi® Adapter)

The Wi-Fi Adapter is attached to this unit when shipped from the factory. When the adapter is removed, store it in a safe place.

- The marking of products using lasers



The label is attached to the chassis/case and says that the component uses laser beams that have been classified as Class 1. It means that the unit is utilizing laser beams that are of a weaker class. There is no danger of hazardous radiation outside the unit.

- Eski Elektrik ve Elektronik Ekipmanların İmha Edilmesi Hakkında Bilgi (ayrı atık toplama sistemlerini kullanan ülkeleri için uygulanabilir)



Sembollü (üzerinde çarpı işareti olan çöp kutusu) ürünler ev atıkları olarak atılamaz.

Eski elektrik ve elektronik ekipmanlar, bu ürünleri ve ürün atıklarını geri dönüştürebilecek bir tesiste değerlendirilmelidir. Yaşadığınız bölgeye en yakın geri dönüşüm tesisinin yerini öğrenmek için yerel makamlara müracaat edin. Uygun geri dönüşüm ve atık imha yöntemi sağlığımız ve çevremiz üzerindeki zararlı etkileri önlerken kaynakların korunmasına da yardımcı olacaktır.

DNN9150BTM / DNR8015BTM:



Declaration of Conformity with regard to the EMC Directive 2004/108/EC

Declaration of Conformity with regard to the R&TTE Directive 1999/5/EC

Declaration of Conformity with regard to the RoHS Directive 2011/65/EU

Manufacturer:

JVC KENWOOD Corporation
3-12, Moriyacho, Kanagawa-ku, Yokohama-shi,
Kanagawa 221-0022, JAPAN

EU Representative:

JVCKENWOOD NEDERLAND B.V.
Amsterdamseweg 37, 1422 AC UITHOORN, The
Netherlands

English

Hereby, JVC KENWOOD declares that this unit DNN9150BTM/ DNR8015BTM is in compliance with the essential requirements and other relevant provisions of Directive 1999/5/EC.

Türkçe

Bu vesileyle JVC KENWOOD, DNN9150BTM/ DNR8015BTM ünitesinin, 1999/5/EC Direktifinin başlıca gereksinimleri ve diğer ilgili hükümleri ile uyumlu olduğunu beyan eder.

For Turkey

Bu ürün 28300 sayılı Resmi Gazete'de yayımlanan Atık Elektrikli ve Elektronik Eşyaların Kontrolü Yönetmeliğe uygun olarak üretilmiştir.

KENWOOD

Free Manuals Download Website

<http://myh66.com>

<http://usermanuals.us>

<http://www.somanuals.com>

<http://www.4manuals.cc>

<http://www.manual-lib.com>

<http://www.404manual.com>

<http://www.luxmanual.com>

<http://aubethermostatmanual.com>

Golf course search by state

<http://golfingnear.com>

Email search by domain

<http://emailbydomain.com>

Auto manuals search

<http://auto.somanuals.com>

TV manuals search

<http://tv.somanuals.com>