

DNX7380BT DNX7380BTM DNX5380BT DNX5380 DNX5380M

GPS NAVIGATION SYSTEM
INSTRUCTION MANUAL

Kenwood Corporation

Before reading this manual, click the button below to check the latest edition and the modified pages.





What Do You Want To Do?

Thank you for purchasing the KENWOOD GPS NAVIGATION SYSTEM.
In this manual, you will learn various convenient functions of the system.

Click the icon of the media you want to play.

With one-click, you can jump to the section of each media!



Contents

Before Use	4	Bluetooth Control	53
How To Read This Manual	5	Registering And Connecting Bluetooth Unit _____	53
Basic Operations	6	Playing Bluetooth Audio Device (models other than DNX5380BT)____	56
Functions Of The Buttons On The Front Panel _____	6	Using Hands-Free Unit _____	57
Turning On The Unit _____	10	Bluetooth Setup _____	60
How To Play Media _____	13	Hands-Free Control _____	61
Detaching The Front Panel _____	14	Setting Up	68
Operating With The Top Menu Screen ____	16	Monitor Screen Setup _____	68
Common Operations _____	18	System Setup _____	69
Navigation Operation _____	20	Display Setup _____	73
DVD/Video CD (VCD) Operation	22	Navigation Setup _____	76
DVD/VCD Basic Operation _____	22	Camera Setup _____	77
DVD Disc Menu Operation _____	25	Software Information _____	78
Zoom Control For DVD And VCD _____	26	AV Input Setup _____	78
DVD Setup _____	27	AV Output Interface Setup _____	79
CD/Audio And Visual Files /iPod Operation	30	External Device Control DNX7 _____	79
Music/Video/Picture Basic Operation ____	30	Controlling Audio	80
Search Operation _____	36	Setting Audio _____	80
Movie Control _____	41	Controlling General Audio _____	83
USB/iPod/DivX Setup _____	41	Equalizer Control _____	84
Radio And TV Operation	44	Zone Control _____	86
Radio Basic Operation _____	44	Space Enhancer DNX7 _____	86
TV Basic Operation _____	46	Listening Position DNX7 _____	87
Memory Operation _____	48	Remote Controller	88
Selecting Operation _____	49	Battery Installation _____	88
Traffic Information (FM tuner only) _____	50	Functions Of The Remote Controller Buttons _____	89
Frequency Step Setting _____	50		
Tuner Setup _____	50		
TV Setup _____	51		

Troubleshooting **92**

Problems And Solutions _____ 92

Error Messages _____ 93

Resetting The Unit _____ 94

Appendix **95**

Playable Media And Files _____ 95

Status Bar Indicator Items _____ 98

Region Codes In The World _____ 100

DVD Language Codes _____ 101

Specifications _____ 102

About This Unit _____ 104

Before Use

⚠ WARNING

To prevent injury or fire, take the following precautions:

- To prevent a short circuit, never put or leave any metallic objects (such as coins or metal tools) inside the unit.
- Do not watch or fix your eyes on the unit's display when you are driving for any extended period.
- If you experience problems during installation, consult your Kenwood dealer.

Precautions on using this unit

- When you purchase optional accessories, check with your Kenwood dealer to make sure that they work with your model and in your area.
- You can select language to display menus, audio file tags, etc. See [Language setup \(P.70\)](#).
- The Radio Data System or Radio Broadcast Data System feature won't work where the service is not supported by any broadcasting station.

Protecting the monitor

To protect the monitor from damage, do not operate the monitor using a ball point pen or similar tool with the sharp tip.

Cleaning the unit

If the faceplate of this unit is stained, wipe it with a dry soft cloth such as a silicon cloth. If the faceplate is stained badly, wipe the stain off with a cloth moistened with neutral cleaner, then wipe it again with a clean soft dry cloth.



- Applying spray cleaner directly to the unit may affect its mechanical parts. Wiping the faceplate with a hard cloth or using a volatile liquid such as thinner or alcohol may scratch the surface or erase screened print.

Lens fogging

When you turn on the car heater in cold weather, dew or condensation may form on the lens in the disc player of the unit. Called lens fogging, this condensation on the lens may not allow discs to play. In such a situation, remove the disc and wait for the condensation to evaporate. If the unit still does not operate normally after a while, consult your Kenwood dealer.

Precautions on handling discs

- Do not touch the recording surface of the disc.
- Do not stick tape etc. on the disc, or use a disc with tape stuck on it.
- Do not use disc type accessories.
- Clean from the center of the disc and move outward.
- When removing discs from this unit, pull them out horizontally.
- If the disc center hole or outside rim has burrs, use the disc only after removing the burrs with a ballpoint pen etc.
- Discs that are not round cannot be used.



- 8-cm (3 inch) discs cannot be used.
- Discs with coloring on the recording surface or discs that are dirty cannot be used.
- This unit can only play the CDs with



This unit may not correctly play discs which do not have the mark.

- You cannot play a disc that has not been finalized. (For the finalization process see your writing software, and your recorder instruction manual.)

How To Read This Manual

[Return to the Top page](#)
[CD, Disc, iPod, USB device](#)

Search Operation

You can search the music, video, or picture file by some operations.

NOTE

- If you use a remote controller, you can jump directly to the desired track/file with entering the track/folder/file number, play time, etc. For details, see "[Direct search mode](#)" (p.81).

List search

You can search tracks, folders, and files according to hierarchy.

For USB devices and iPods, you can list and search files in the device by using playlist.

1 | Press the <MENU> button during playback.
Simple Control screen appears.

2 | Touch [].
List Control screen appears.

3 | Touch desired track/file.

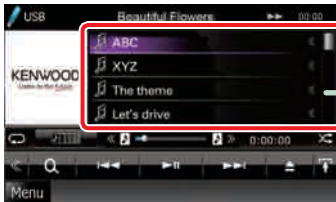

Playback starts.

Other search

When you want to narrow the list down, there are other search ways.

1 | Press the <MENU> button during playback.
Simple Control screen appears.

2 | Touch [].
The search type screen appears.

Link header

You can refer each section or top page with one-click.

Operation title

Introduces the function.

NOTE

Introduces some tips, notes, etc.

Reference mark

Displayed in blue notes.

With one-click, you can jump to the article related to the current section.

Operation procedure

Explains necessary procedures to achieve the operation.

< >: Indicates the name of panel buttons.

[]: Indicates the name of touch keys.

Screen shot

Shows some screen shots displayed during operation for reference.

The area or keys to touch are surrounded with a red frame.

NOTE

- The screens and panels shown in this manual are examples used to provide clear explanations of the operations. For this reason, they may be different from the actual screens or panels used, or some display patterns may be different.

Basic Operations

Functions Of The Buttons On The Front Panel

DNX7380BT/ DNX7380BTM

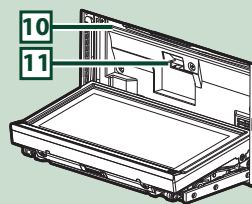
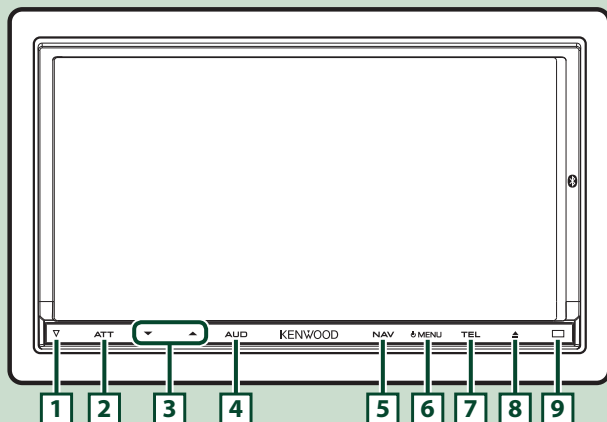

NOTE

- The panels shown in this guide are examples used to provide clear explanations of the operations. For this reason, they may be different from the actual panels.
- In this manual, each model name is abbreviated as follows.

DNX7380BT and DNX7380BTM: **DNX7**

If above icon is showed, read the article applicable to the unit you use.

How To Insert An SD Card

- 1) Press **8** <▲> button for 3 seconds.

The panel fully opens.

- 2) Hold the SD card as the diagram in the right and insert it into the slot until it clicks.

● To eject the card:

Push the card until it clicks and then remove your finger from the card.

The card pops up so that you can pull it out with your fingers.

Labelled side

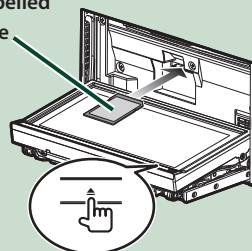

Number	Name	Motion
1	▽ (Reset)	• If the unit or the connected unit fails to operate properly, the unit returns to factory settings when this button is pressed (P.94) .
2	ATT	• Switches attenuation of the volume on/off. • Pressing for 1 second turns the screen off.
3	▼, ▲ (Vol)	Adjusts volume. Holding down a key turns up the volume in series up to 25. For more than 25, pressing the key turns up the volume one by one.
4	AUD	• Displays Graphic Equalizer screen (P.84) . • Pressing for 1 second switches camera view display on/off.
5	NAV	• Displays the navigation screen. • Pressing for 1 second switches AV out sources. • When the power off, turns the power on.
6	MENU	• Displays the Top Menu screen (P.16) . • Pressing for 1 second turns the power off. • When the power off, turns the power on.
7	TEL	• Displays the Hands Free screen (P.53) . • Pressing for 1 second displays the Screen Control screen. • When the power off, turns the power on.
8	▲ (Eject)	• Ejects the disc. • Pressing for 1 second opens the panel to the location of the disc slot. When the panel is opened, pressing for 1 second closes the panel and pressing for 3 seconds ejects the disc forcibly. • When the panel is closed, pressing for 3 seconds fully opens the panel to the location of the SD card slot.
9	Remote Sensor	• Receives the remote control signal. You can enable or disable this feature by Remote Sensor (P.69) . • If [Remote Sensor] is set to off, the remote control of TV reception is rejected.
10	Disc insert slot	A slot to insert a disc media.
11	SD card slot	An SD card slot for upgrading the map. For how to upgrade the map, refer to the instruction manual of the navigation system.

* The display may not switch to the Graphic Equalizer screen in some conditions.

DNX5380BT/DNX5380/DNX5380M

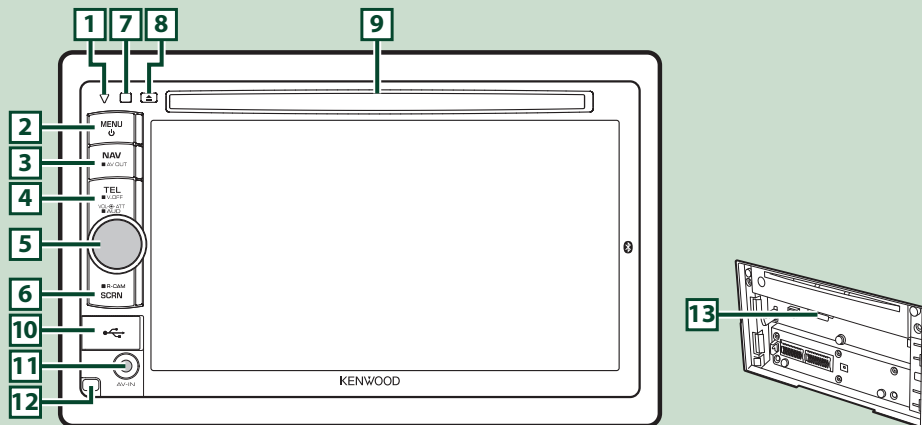

NOTE

- The panels shown in this guide are examples used to provide clear explanations of the operations. For this reason, they may be different from the actual panels.
- In this manual, each model name is abbreviated as follows.

DNX5380BT, DNX5380, and DNX5380M: **DNX5**

If above icons are showed, read the article applicable to the unit you use.

How To Insert An SD Card

- 1) Detach the front panel following the procedures in [Detaching The Front Panel \(P.14\)](#).
- 2) Hold the SD card as the diagram in the right and insert it into the slot until it clicks.

● To eject the card:

Push the card until it clicks and then remove your finger from the card.

The card pops up so that you can pull it out with your fingers.

Labelled side

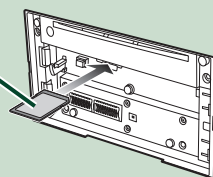

Number	Name	Motion
1	▽ (Reset)	<ul style="list-style-type: none"> If the unit or the connected unit fails to operate properly, the unit returns to factory settings when this button is pressed (P.94).
2	MENU	<ul style="list-style-type: none"> Displays the Top Menu screen (P.16). Pressing for 1 second turns the power off. When the power off, turns the power on.
3	NAV	<ul style="list-style-type: none"> Displays the navigation screen. Pressing for 1 second switches AV out sources.
4	TEL	<ul style="list-style-type: none"> Displays the Hands Free screen (P.53). Pressing for 1 second turns the screen off.
5	Volume Knob	<ul style="list-style-type: none"> Pressing switches attenuation of the volume on/off. Turning adjusts volume up or down. Pressing for 1 second displays Tone Control screen (P.85).*
6	SCRN	<ul style="list-style-type: none"> Displays the Screen Control screen. Pressing for 1 second displays rear view camera display.
7	Remote Sensor	<ul style="list-style-type: none"> Receives the remote control signal. You can enable or disable this feature by Remote Sensor (P.69). If [Remote Sensor] is set to off, the remote control of TV reception is rejected.
8	▲ (Eject)	<ul style="list-style-type: none"> Ejects the disc. Pressing for 1 second ejects the disc forcibly.
9	Disc insert slot	A slot to insert a disc media.
10	USB terminal	A USB terminal for USB storage device and iPod.
11	Input jack	An input jack for external device.
12	Release key	Detaches the front panel.
13	SD card slot	An SD card slot for upgrading the map. For how to upgrade the map, refer to the instruction manual of the navigation system.

* The display may not switch to the Tone Control screen in some conditions.

Turning On The Unit

The method of turning on is different depending on the model.

DNX7

- 1 Press the <NAV>, <MENU>, or <TEL> button.

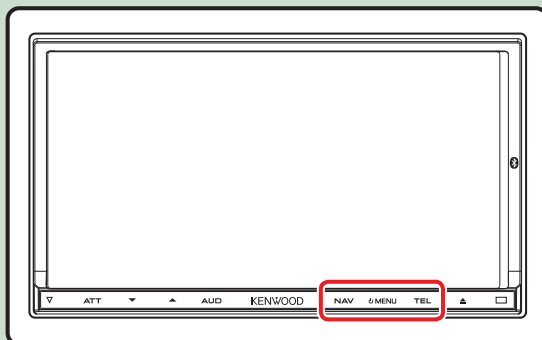

The unit is turned on.

- **To turn off the unit:**
Press the <MENU> button for 1 second.

DNX5

- 1 Press the <MENU> button.

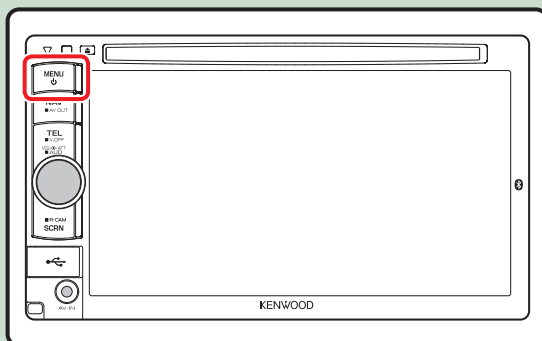

The unit is turned on.

- **To turn off the unit:**
Press the <MENU> button for 1 second.

If it is your first time turning the unit on after installation, it will be necessary to perform [initial setup \(P.11\)](#).

Initial setup

Perform this setup when you use this unit first time or when you reset the unit ([P.94](#)).

1 Set each item as follows.



Language

Select the language used for the control screen and setting items. Default is "British English (en)" for models with region code 2/3/4 and "Chinese" for model with region code 6.

- ① Touch [SET].
- ② Touch [◀] or [▶] to select the desired language.
- ③ Touch [Enter].

For detailed operation, see [Language setup \(P.70\)](#).

Angle **DNX7**

Adjust the position of the monitor. Default is "0".

- ① Touch [SET].
- ② Touch desired angle number and [↔].

For detailed operation, see [Monitor angle control \(P.74\)](#).

iPod AV Interface Use

Set the terminal which your iPod is connected to. Default is "iPod".

- ① Touch [iPod] or [AV-IN2].

Color

Set the screen and button illumination color. You can select whether to allow color scan operation or select a fixed color for operation.

- ① Touch [SET].
- ② Touch [ON] or [OFF] of [Panel Color Scan].
- ③ If you want to change color, touch [SET] of [Panel Color Coordinate].
- ④ Touch your desired color and [↔].

For detailed operation, see [Panel color coordinate \(P.74\)](#).

EXT SW **DNX7**

Control the external devices.

- ① Touch [SET].
- ② Set device name, output pattern, and pulse set for each device. Then, touch [↔].

For detailed operation, see [EXT SW setup \(P.72\)](#).

Camera

Set the parameters for the camera.

- ① Touch [SET].
- ② Set each item and touch [↔].

For detailed operation, see [Camera Setup \(P.77\)](#).

Continued

2 Touch [Finish].



NOTE

- These settings can be set from the SETUP menu. See [Setting Up \(P.68\)](#).

How To Play Media

Music CD and disc media

DNX7

- 1 Press the <▲> button for 1 second.



The panel opens.

- 2 Insert the disc into the slot.

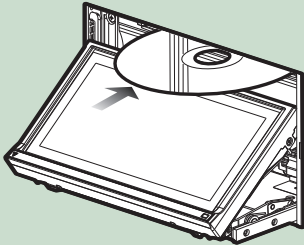

The panel closes automatically.
The unit loads the disc and playback starts.

- To eject the disc:
Press the <▲> button for 1 second.

DNX5

- 1 Insert the disc into the slot.

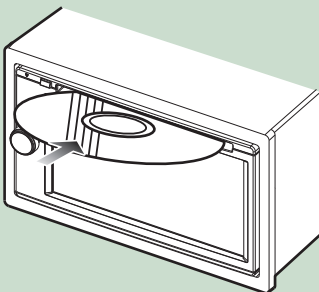

The unit loads the disc and playback starts.

- To eject the disc:
Press the <▲> button.

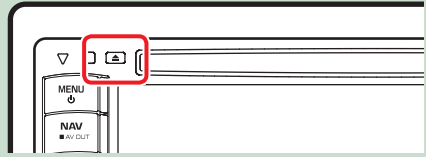

USB device

- 1 Connect the USB device with the USB cable.

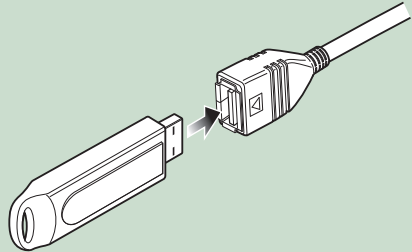

The unit reads the device and playback starts.

- To disconnect the device:
Touch [▲] for 1 second on the screen and disconnect the device from the cable.

iPod

- 1 Connect the iPod with the iPod cable.

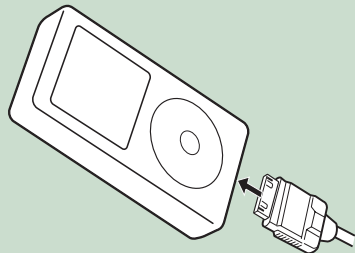

The unit reads the iPod and playback starts.

- To disconnect the device:
Touch [◀] on the screen and then touch [▲] for 1 second. Disconnect the iPod from the cable.

External device **DNX5**

1 Insert the plug into the AV-IN jack.

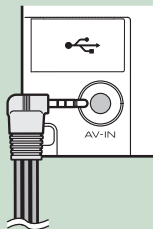

Detaching The Front Panel

You can detach the front panel to prevent theft.

DNX7

1 Press the **<▲>** button for 3 seconds to open the front panel.

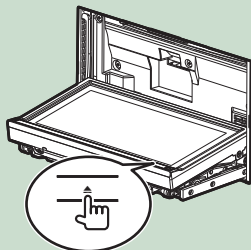

NOTE

- You can set the front panel to open automatically when the ignition is turned off. See [Monitor angle control \(P.74\)](#).

2 Detach the panel as the diagrams below.

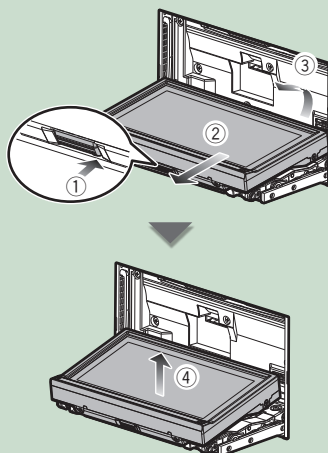

NOTE

- The attaching plate closes automatically in about 10 seconds after the front panel is released. Remove the panel before this happens.

DNX5

- 1 Detach the panel as the diagrams below.

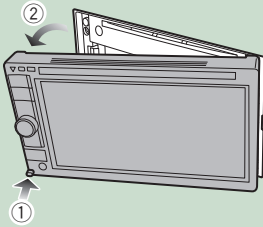

● After detaching:

Put the panel in the protective bag supplied with the unit.

DNX7

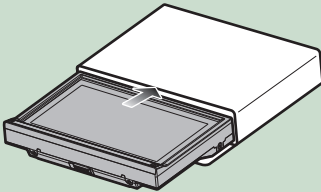

DNX5

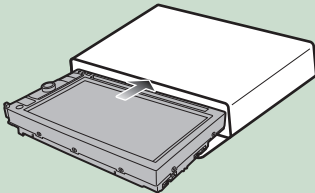

NOTE

- To prevent deterioration, do not touch the terminals of the unit and faceplate with your fingers.
- If the terminals on the unit or faceplate get dirty, wipe them with a clean soft dry cloth.

Attaching the front panel

- 1 Hold the panel securely so as not to drop it accidentally, and fit it onto the attaching plate until it is firmly locked.

DNX7

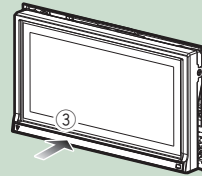
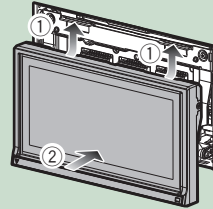

DNX5

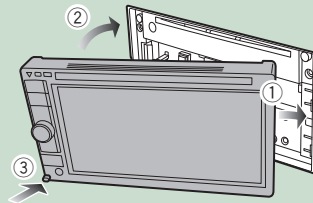

Operating With The Top Menu Screen

Most functions can be performed from the Top Menu screen.

1 Touch [Menu] on any screen.



NOTE

- If [Menu] is not displayed during video/picture playback, press the <MENU> button. [\(P.6, P.8\)](#)

Top Menu screen appears.

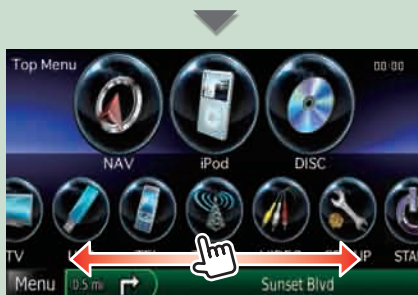

NOTE

- You can select the hiding icon by scrolling the screen left or right.

From this screen, you can perform the following functions.

Function	Icon	Operation
Switch the audio source	etc.	Touch the icon of the desired source.
Enter setup mode	etc.	Touch the icon of the desired setup function.
Display navigation screen	or	Touch [NAV] or navigation information.
Turn off all audio function		Touch [STANDBY].

● **Customizing Top Menu screen**

Drag the icon you want to register to the upper line.

You can move up to three icons.



Common Operations

Introduces the common operations.

General

There are some functions which can be operated from most screens.



[Menu]

Returns to the Top Menu screen.

← (RETURN)

Returns to previous screen.

← (common menu key)

Touch to display the common menu. The contents of the menu are as follows.

: **DNX7** Displays the EXT SW Control screen.

: Displays the SETUP Menu screen.

: Displays the Audio Control Menu screen.

: Displays the control screen of current source. Icon feature differs depending on the source.

: Closes the menu.

List screen

There are some common function keys in the list screens of most sources.



◀ (Scroll)

Scrolls the displayed text.

All > etc.

Touch keys with various functions are displayed here.

Displayed keys differ depending on the current audio source, status, etc.

For examples of functions of each key, refer to the table below.

Key	Function
	Lists all the music in the lower hierarchy.
	Moves to the upper hierarchy.
	Displays current category folder.
	Displays music/picture/movie file list.

Flick scrolling

You can scroll the list screen by flicking the screen up/down or right/left.

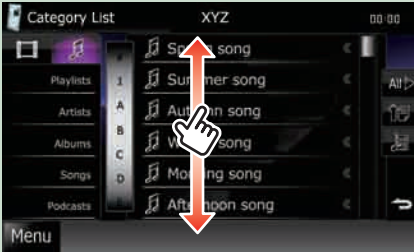

Navigation Operation

For details on the navigation function, please refer to the Navigation Instruction Manual.

Display the navigation screen

- 1 Press the <NAV> button.

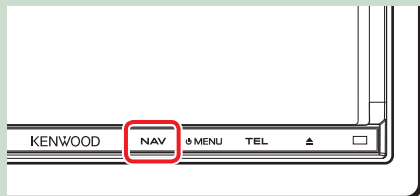

DNX7

The navigation screen appears.

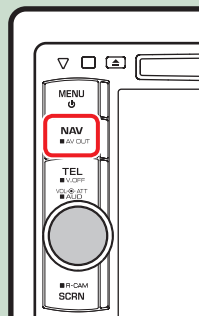

DNX5

Control audio from the navigation screen

You can control audio sources while the navigation screen is displayed.

Also, you can view the navigation information while the source control screen is displayed.

- 1 Touch the information bar.



The navigation screen with audio information appears.

2 Touch [] or [] in the navigation screen.



Touching this area displays the audio screen.

 : Displays the navigation and control keys of the current source.



 : Displays the navigation and current video/picture playback display.



NOTE

- The screen switches between playback screen and camera view each time the viewing area is touched.
- Touching the source icon in the bottom of the screen displays the full audio screen.

● **To return to the full navigation screen:**

Touch [].

NOTE

- For details on control keys, refer to the instructions in each section.

DVD/Video CD (VCD) Operation

DVD/VCD Basic Operation

Most functions can be controlled from the source control screen and playback screen.

NOTE

- Set the remote controller mode switch to DVD mode before starting operation, see [Switching the operation mode \(P.89\)](#).
- The screen shot below is for DVD. It may be different from the one for VCD.

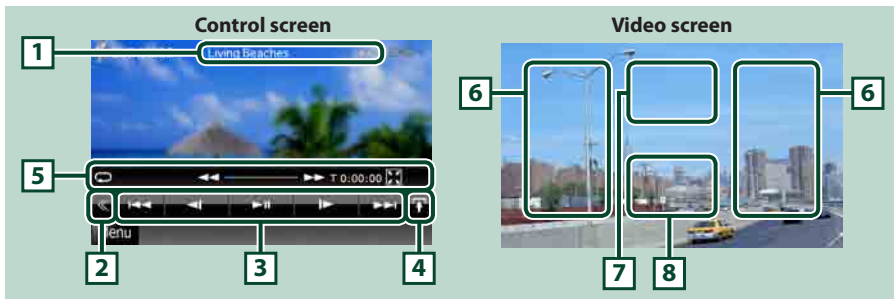

1 Information display

Displays the following information.

- **Title #, Chap #:** DVD title and chapter number display
- **Track #/Scene #:** VCD track or scene number display
*Scene # is displayed only when PBC is on.
- **▶, ▶▶, ▶▶▶, ■, etc.:** Current play mode display
The meanings of each icon are as follows; ▶ (play), ▶▶ (fast forward), ◀◀ (fast backward), ▶▶▶ (search up), ◀◀◀ (search down), ■ (stop), ■R (resume stop), || (pause), |▶ (slow playback), ◀| (slow reverse playback).

Touch this area to display the disc label name.

2 Multi function key

Touch to switch the multi function menu. For details on the menu, see [Multi function menu \(P.24\)](#).

3 Multi function menu







Various functions can be performed by using keys in this area. For details on the keys, see [Multi function menu \(P.24\)](#).

4 Control switching key

Unavailable in DVD/VCD source.

5 Sub function menu

The following functions can be performed by using keys in this area.

- **Repeats the current content:** Touch []. Each time you touch the key, repeat mode switches in the following sequence:
DVD: "title repeat"  "chapter repeat"  "function off"
VCD (PBC On): Does not repeat
VCD (PBC Off): "track repeat"  "function off"
- **Hides all keys:** Touch [].
- **Fast forward or fast backward:** Touch [] or []. Each time you touch the key, the speed changes; standard, 2 times, 3 times.
- **Confirms play time:** See ###:##.
DVD: You can switch the time display between title play time, chapter play time, and title remaining time. Each time you touch, the display switches between "T #:##:##" (title play time display), "C #:##:##" (chapter play time display), and "R #:##:##" (title remaining time display).
As well as the time display, the bar indicating current location appears.
VCD (PBC off): You can also confirm disc remaining time by touching time display. Each time you touch, the display switches between "P #:##:##" (play time display) and "R #:##:##" (disc remaining time).
- **Confirms the current location:** See the bar in center (DVD only). The bar does not appear when the time display is remaining time display.

6 Searching area

Touch to search the next/previous content.

Scrolling from center of display to left or right performs fast backward or fast forward. Each time you touch each area, the speed changes; standard, 2 times, 3 times. To stop fast backward/forward, touch center of the display.

7 Menu display area

This area functions differently depending on the current status.

- **During DVD playback:** Displays the DVD menu. During the menu display, displays the highlight control screen.
- **During VCD playback:** Displays the Zoom Control screen ([P.26](#))

8 Key display area

Touch to display the last control screen.

NOTE

- If you use a remote controller, you can jump directly to the desired image with entering the chapter number, scene number, play time, etc. ([P.89](#)).

Multi function menu

DVD



VCD



The functions of each key are as follows.

[<<<] [>>>]

Searches the previous/next content.

[▶ II]

Plays or pauses.

[◀ I] or [I ▶] (DVD only)

Plays in slow motion forward or backward.

[■]

Stops playback. When touched twice, the disc is played from the beginning when you play it the next time.

[PBC] (VCD only)

Turn PBC on or off.

[ SETUP]

Touch to display the SETUP Menu screen. See [Setting Up \(P.68\)](#).

[ AUDIO]

Touch to display the Audio Control screen. See [Controlling Audio \(P.80\)](#).

[ EXT SW] [DNX7▶]

Touch to control the external device power supply. For details, see [External Device Control \(P.79\)](#).

DVD Disc Menu Operation

You can set up some items in the DVD-VIDEO disc menu.

- 1 | Touch illustrated area during playback.



Menu Control screen appears.

- 2 | Perform desired operation as follows.



Displays the top menu

Touch [Top].*

Displays the menu

Touch [Menu].*

Displays the previous menu

Touch [Return].*

Enters selected item

Touch [Enter].

Enables direct operation

Touch [Highlight] to enter the highlight control mode ([P.25](#)).

Moves the cursor

Touch [▲], [▼], [◀], [▶].

* These keys may not function depending on the disc.

Highlight control

Highlight control lets you control the DVD menu by touching the menu key directly on the screen.

- 1 | Touch [Highlight] in the Menu Control screen.
- 2 | Touch desired item on the screen.



NOTE

- The highlight control is cleared automatically if you do not operate for a constant time.

DVD Play Mode Setting

You can select DVD play mode.

- 1 | Touch [Next] in the Menu Control screen.



Menu Control 2 screen appears.

Continued

2 | Touch the key which corresponds to desired setting item.



Switches the subtitle language

Touch [Subtitle]. Each time you touch this key, language is switched.

Switches the audio language

Touch [Audio]. Each time you touch this key, language is switched.

Controls zoom ratio

Touch [Zoom]. For details, see [step 2 in Zoom Control For DVD And VCD \(P.26\)](#).

Switches the picture angle

Touch [Angle]. Each time you touch this key, picture angle is switched.

Exits menu control

Touch [Exit].

Displays the Menu Control 1 screen

Touch [Previous].

Zoom Control For DVD And VCD

You can enlarge Playback screen for DVD and VCD.

1 | For VCD, touch illustrated area during playback.



Zoom Control screen appears.

NOTE

- For DVD, please refer to [DVD Play Mode Setting \(P.25\)](#) to display the Zoom Control screen.

2 | Perform desired operation as follows.



Switches zoom ratio

Touch [Zoom].

For DVD, changes the zoom ratio at 4 levels; Off, 2 times, 3 times, 4 times.

For VCD, changes the zoom ratio at 2 levels; Off, 2 times.

Scrolls the screen

Touch [▲], [▼], [◀], or [▶] to scroll the screen in the direction you touch.

Exits menu control

Touch [Exit].

Displays the previous menu*

Touch [Return].

* This function may not be performed depending on the disc.

NOTE

- You cannot touch the menu keys directly on the screen when zooming.

DVD Setup

You can set up the DVD playback functions.

NOTE

- Each operation in this section can be started from the Top Menu screen. For details, see [Operating With The Top Menu Screen \(P.16\)](#).

1 | Touch [◀◀] in the control screen.

Multi function menu appears.

2 | Touch [SETUP].

SETUP Menu screen appears.

3 | Touch [Source].



Source SETUP Menu screen appears.

4 | Touch [DVD SETUP] in the list.

DVD SETUP screen appears.

5 | Set each item as follows.



Menu/Subtitle/Audio Language*

See [Language setup \(P.28\)](#).

Dynamic Range Control*

Sets the dynamic range.

Wide: The dynamic range is wide.

Normal: The dynamic range is normal.

Dialog (Default): Makes the total sound volume larger than other modes. This is effective only when you are using Dolby Digital software.

Angle Mark

Sets an angle mark display.

ON (Default): An angle mark appears.

OFF: An angle mark does not appear.

Screen Ratio*

Sets the screen display mode.

16:9 (Default): Displays wide pictures.

4:3 LB: Displays wide pictures in the Letter Box format (having black stripes at the top and bottom of screen).

4:3 PS: Displays wide pictures in the Pan & Scan format (showing pictures cut at the right and left ends).

Parental Level*

See [Parental level \(P.28\)](#).

DISC SETUP

See [Disc setup \(P.29\)](#).

Stream Information

Displays the present source information.

The stream (Dolby Digital, dts, Linear PCM, MPEG, WMA or AAC) appears.

* These items are disabled when a DVD is being played.

Language setup

This setting is for the language used in the menu, subtitle, and voice. You cannot setup these items during DVD playback.

- 1 | **Touch [SET] of the desired item; [Menu Language], [Subtitle Language], [Audio Language].**

Language Set screen appears.

- 2 | **Enter the desired language code and touch [Enter].**



Sets the entered language and returns to the DVD SETUP screen.

NOTE

- To cancel the setup and return to the previous screen, touch [Cancel].
- To clear the entered code, touch [Clear].
- To set the DVD's original language for audio language, touch [Original].

Parental level

Sets a parental level. You cannot setup this item during DVD playback.

- 1 | **Touch [SET] of [Parental Level].**
Parental Pass screen appears.
- 2 | **Enter the parental code and touch [Enter].**
Parental Level screen appears.

NOTE

- To cancel the setup and return to the previous screen, touch [Cancel].
- To clear the entered code, touch [Clear].
- Current parental level appears as [Level#].

- 3 | **Touch [◀] or [▶] to select a parental level.**



NOTE

- If a disc has higher parental lock level, you need to enter the code number.
- The parental lock level varies depending on a loaded disc.
- If a disc has no parental lock, anybody can play it back even when you have set the parental lock.

Disc setup

Performs setup when using disc media.

1 | Touch [SET] of [DISC SETUP].

DISC SETUP screen appears.

2 | Select an option as follows.



CD Read

Sets the motion of this unit when a music CD is played.

1 (Default): Automatically recognizes and plays back an audio file disc, a DVD or a music CD.

2: Forcibly plays back a disc as a music CD. Select [2] if you wish to play a music CD having a special format or if you cannot play a disc in [1] position.

On Screen DVD

Sets an on-screen display.

Auto: When updated, information appears for 5 seconds.

OFF (Default): Information does not appear.

NOTE

- [CD Read] is not available when a disc is in the unit.
- You cannot play an audio file/VCD disc in the [2] position. Also, you may not play some music CDs in the [2] position.

CD/Audio And Visual Files/iPod Operation

Music/Video/Picture Basic Operation

Most functions can be controlled from the source control screen and playback screen.

NOTE

- Set the remote controller mode switch to AUD mode before starting operation, see [Switching the operation mode \(P.89\)](#).
- To connect iPod to this unit, optional accessory KCA-iP202/KCA-iP22F is necessary.

See the following sections for each source operation.

- Music CD ([P.30](#))
- Disc media ([P.30](#))
- USB device ([P.32](#))
- iPod ([P.32](#))

Music CD and disc media

NOTE

- In this manual, "Music CD" will be referred to as the general CDs which include music tracks in. "Disc media" will be referred to as CD/DVD disc which includes audio, picture or video files.
- The screen shot below is for CD. It may be different from the one for disc media.

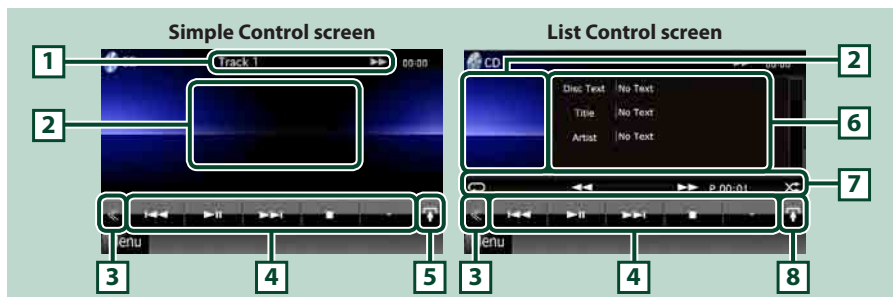

1 Information display

Displays the following information.

- Track #: Each time you touch this area, display switches between current track number, text, etc.
- ▶, ▶▶, ▶▶▶, ■, etc.: Current play mode display
The meanings of each icon are as follows; ▶ (play), ▶▶ (fast forward), ◀◀ (fast backward), ▶▶▶ (search up), ◀◀◀ (search down), ■ (stop), ■R (resume stop), || (pause).

2 Control switching key/Movie display area

Touch to switch between the Simple Control and List Control screen.

3 Multi function key

Touch to switch the multi function menu. For details on the menu, see [Multi function menu \(P.34\)](#).

4 Multi function menu

Various functions can be performed by using keys in this area. For details on the menu, see [Multi function menu \(P.34\)](#).

5 Sub function key

Touch to display "Sub function menu" (7 in this table).

6 Track information

Displays the information of the current track.

For music CD and disc media, you can switch the current track information and the current folder list by touching the list switching key (8 in this table).

However, only "No Information" is displayed for music CD.

7 Sub function menu

Various functions can be performed by using keys in this area. For details on the keys, see [Sub function menu \(P.35\)](#).

8 List switching key

Touch to switch between the track list and the CD-TEXT display (CD)/ID3 tag information (disc media only).

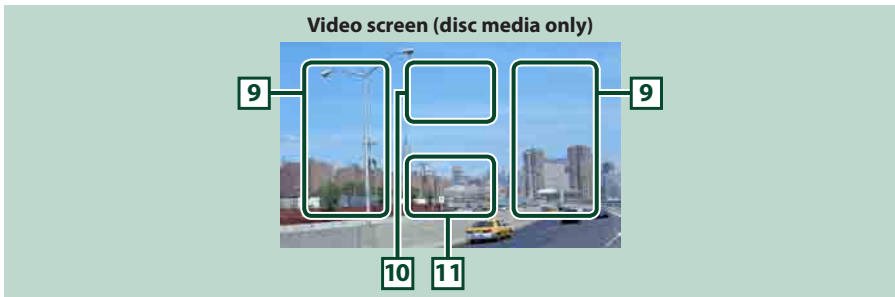

9 Searching file area (disc media only)

Touch to search the next/previous file.

Scrolling from center of display to left or right performs fast backward or fast forward. Each time you touch each area, the speed changes; standard, 2 times, 3 times. To stop fast backward/forward, touch center of the display.

10 Menu display area (disc media only)

Touch to display the disc menu. For details, see [Movie Control \(P.41\)](#).

11 Key display area (disc media only)

Touch to display the last control screen.

USB device and iPod

NOTE

- The screen shot below is for USB device. It may be different from the one for iPod.

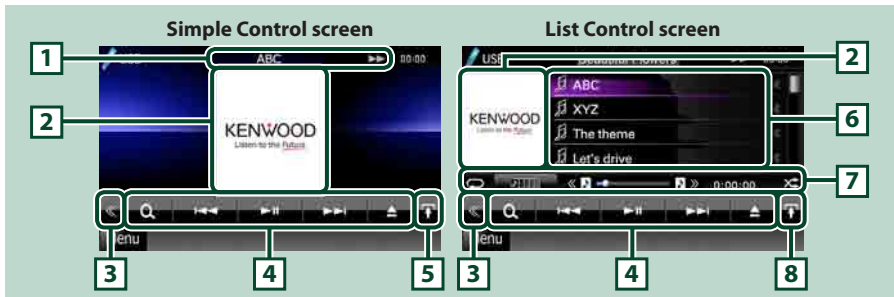

1 Information display

Displays the following information.

- **Current file name:** Each time you touch this area, display switches between file number/folder number and file name.
- **▶, ▶▶, etc.:** Current play mode display
The meanings of each icon are as follows: ▶ (play, searching), || (pause), ▶▶ (forward manual search), ◀◀ (reverse manual search).

2 Artwork/Control switching area

The picture data is displayed if available from the current file. When the picture is not available, "No Photo" is displayed.

Touch to switch between the Simple Control and List Control screen.

3 Multi function key

Touch to switch the multi function menu. For details on the menu, see [Multi function menu \(P.34\)](#).

4 Multi function menu

Various functions can be performed by using keys in this area. For details on the keys, see [Multi function menu \(P.34\)](#).

5 Sub function key

Touch to display "Sub function menu" (7 in this table).

6 Contents list

Displays the list and contents. The contents of the list differ depending on the playback status and source.

7 Sub function menu

Various functions can be performed by using keys in this area. For details on the keys, see [Sub function menu \(P.35\)](#).

8 List switching key

Touch to switch between the file list and the current file information.

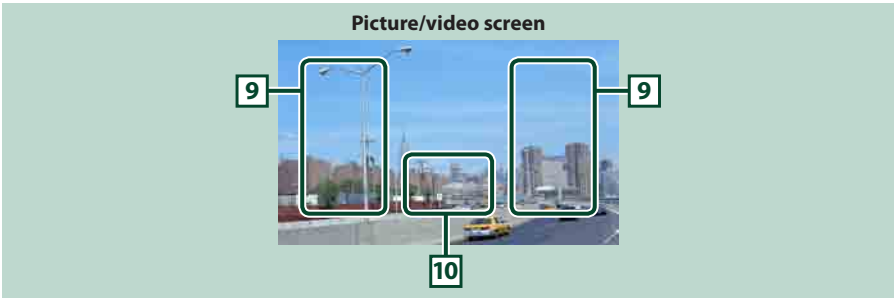

9 Searching file area (picture/video file only)

- Touch to search the next/previous file.
- During slide show in USB mode, touching each area searches the next/previous music file.
- Scrolling from center of display to left or right performs fast backward or fast forward. To stop fast backward/forward, touch center of the display. This function is not available when there is no music file in the current folder.

10 Key display area (picture/video file only)

Touch to display the last control screen.

Multi function menu

Music CD



iPod



Disc media



USB device



The following functions can be performed by using keys in this area.

[] (Disc media, iPod, USB device only)

Searches track/file. For details on search operation, see [Search Operation \(P.36\)](#).

[] []

Searches the previous/next track/file.

[]

Plays or pauses.

[] (music CD and disc media only)

Stops playback.

[] (iPod and USB device only)

Touch for 1 second to disconnect the device. For details, see [How To Play Media \(P.13\)](#).

[] (iPod only)

Enters the hand mode. Operation from this unit is disabled. To exit hand mode, touch this key again.

[] [] (disc media and USB device only)

Searches previous/next folder.

[] (picture files in USB device only)

During picture playback, switches to picture display.

[] SETUP

Touch to display the SETUP Menu screen. See [Setting Up \(P.68\)](#).

[] AUDIO

Touch to display the Audio Control screen. See [Controlling Audio \(P.80\)](#).

[] EXT SW []

Touch to control the external device power supply. For details, see [External Device Control \(P.79\)](#).

Sub function menu

Music CD



iPod



Disc media



USB device



The following functions can be performed by using keys in this area.



Repeats the current track/folder. Each time you touch the key, repeat mode switches in the following sequence;

CD, iPod: "track repeat" "repeat off"

Disc media, USB device: "file repeat" "folder repeat" "repeat off"



Searches track from the album artwork list. For details on search operation, see [Search from album artwork \(P.39\)](#).



Hides all keys.



Fast forward or fast backward.



Plays the previous or next album in [Favorite list \(P.40\)](#).

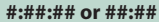

Confirms play time.

During music CD playback, you can also confirm disc remaining time by touching time display. Each time you touch, the display switches between "P ###:##" (track play time display) and "R ###:##" (disc remaining time).



Randomly plays all tracks in current folder/disc or in current playlist in the connected iPod.

Each time you touch the key, random mode switches in the following sequence;

CD: "track random" "random off"

Disc media, USB device: "file random" "random off"

iPod: "track random" "album random" "random off"



Confirms the current location.

During USB device and iPod playback, you can drag the circle left or right to change the playing position.

Search Operation

You can search music, video or picture files by the following operations.

NOTE

- If you use a remote controller, you can jump directly to the desired track/file with entering the track/folder/file number, play time, etc. For details, see [Direct search mode \(P.89\)](#).

List search

You can search tracks, folders, and files according to hierarchy.

1 | Touch illustrated area.



List Control screen appears.

2 | Touch desired track/file.



Playback starts.

NOTE

- For disc media, you can switch the file list and folder list by touching [Q].
- For disc media, you cannot display the list during random play and stop.

Other search

When you want to narrow the list down, there are other search ways.

This function is not available when music CD is the current source.

1 | Touch [Q] in the control screen.

The search type screen appears.

2 | Touch desired search way.

USB device

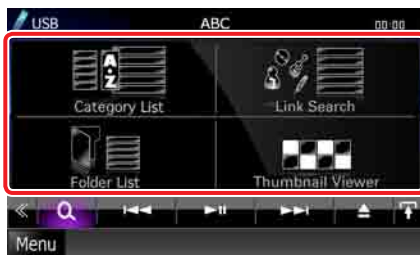

iPod

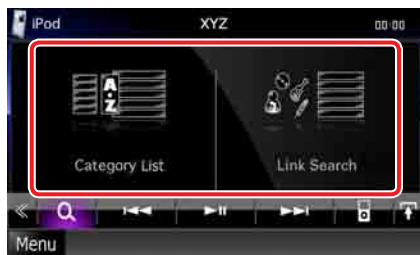

The list sorted in the way you selected appears.

See the following sections for each operation.

- [Category List]: You can search a file by selecting category [\(P.37\)](#).
- [Link Search]: You can search a file of same artist/album/genre/composer as the current track [\(P.37\)](#).
- [Folder List]: You can search a file according to hierarchy [\(P.38\)](#).
- [Thumbnail Viewer]: You can search a picture file [\(P.38\)](#).

NOTE

- For disc media, you can display the folder list directly by touching [Q].

Category search (USB device and iPod only)

- 1 | Touch the desired category from the left part of the screen.



- 2 | The list is sorted by selected category.

- 3 | Touch desired item.

Playback starts.

NOTE

- To narrow the search you can select a letter from the alphabet list in the center of the display.
- For operations in the list screen, see [Common Operations \(P.18\)](#).

Link search (USB device and iPod only)

- 1 | Touch the desired item from the left part of the screen. You can select from artist, album, genre and composer.



The list corresponding to your selection appears.

NOTE

- The list is sorted by the way you selected.
- **artist**: Displays the album list of the artist.
- **album**: Displays all tunes of the current album.
- **genre**: Displays the artists list in which artists belong to the same genre.
- **composer**: Displays the album list of the composer of the current file.

- 2 | Touch to select desired item in the list. Repeat this step until you find the desired file.

NOTE

- To narrow the search you can select a letter from the alphabet list in the center of the display.
- For operations in the list screen, see [Common Operations \(P.18\)](#).

Folder search (USB device and disc media only)

1 | Touch the desired folder.



Contents of the folder are displayed in the right area of the screen.

2 | Touch desired item from the content list.

Playback starts.

NOTE

- For operations in the list screen, see [Common Operations \(P.18\)](#).

Picture search (USB device only)

1 | Touch the desired picture.



The selected picture appears in full screen.

See number 9-10 in [USB device and iPod \(P.32\)](#) for operation of picture screen.

Search from album artwork (USB device and iPod only)

You can search music files by selecting the album artwork.

1 | Touch [].

Sub function menu appears.

2 | Touch [].



Favorite screen appears.

3 | Touch desired artwork in the lower line.

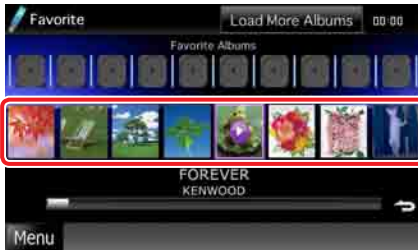

NOTE

- The key in the upper side of the screen functions differently depending on the status.

When [Load Albums] appears:

You have not yet loaded any artworks. Touch the key to start loading.

When [Load More Albums] appears:

Some artworks are not loaded. Touch the key to load all artworks. If you touch the key, the track being played may stop and another track may start playback.

When the key does not available:

All artworks are already loaded.

4 | Touch [] on the selected artwork.

The first song in the album is played.

In addition, you can create your original playlist from this screen. For details, see [Favorite list \(P.40\)](#).

NOTE

- After all tracks in the album are played, the same album is played again from the first track.
- The albums with no photo are not displayed.

Favorite list

You can create an original playlist of your favorite 10 albums by selecting album artworks.

- 1 | **Touch and drag the desired album artwork in the lower line to the upper line.**



Selected album is registered to the favorite list.

NOTE

- The added album is placed on the extreme right.
- You cannot register the same album already registered to the favorite list.
- Up to 10 albums can be registered to the list.

- 2 | **Touch the desired artwork in the favorite list.**

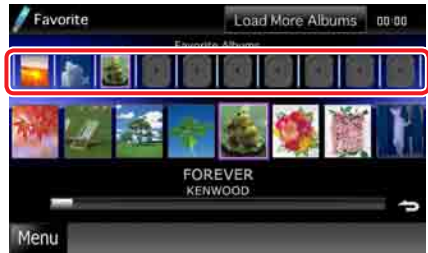

Selected album is played and the control screen appears.

NOTE

- The favorite list is played to the right starting with the selected album.
- To delete the album from the favorite list, touch and drag it to the lower line.
- You can change the playing order of the favorite list by dragging the artwork in the list.
- The favorite list mode is canceled in the following situations.
 - Playing another album from other list (folder list, category list, etc.)
 - Playing another album by touching the artwork in the lower line in the artwork list screen.
- The favorite list mode resumes after disconnecting/connecting the device or turning on/off. File being played, playing time code, favorite list contents, favorite list order, etc. resumes if file configuration of the device is not changed.

Movie Control

You can adjust the movie playback from a disc media.

- 1 | In the playback screen, touch illustrated area.



Movie Control screen appears.

- 2 | Perform desired operation as follows.



Changes subtitle language

Touch [Subtitle].

Changes audio language

Touch [Audio].

Exits the menu

Touch [Exit].

USB/iPod/DivX Setup

You can perform setup when using USB/iPod/DivX.

NOTE

- Each operation in this section can be started from the Top Menu screen. For details, see [Operating With The Top Menu Screen \(P.16\)](#).

- 1 | Touch [] in the control screen.

Multi function menu appears.

- 2 | Touch [SETUP].

SETUP Menu screen appears.

- 3 | Touch [Source].



Source SETUP Menu screen appears.

- 4 | Touch [USB], [iPod] or [DivX] in the list.

Each setup screen appears.

See the following section for each setting.

- [USB setup \(P.42\)](#)

- [iPod setup \(P.42\)](#)

- [DivX setup \(P.43\)](#)

USB setup

1 | Set each item as follows.



Picture Display Time

Selects length of time to display JPEG picture file in the screen. Select from [Short], [Middle], and [Long] (default).

On Screen USB

Sets how to display the information of the USB device.

Auto (Default): Information appears for 5 seconds when updated.

OFF: Does not display any information..

iPod setup

1 | Set each item as follows.



AudioBook Speed

Sets the audio book playback speed. Select from [Slow], [Normal] (default), and [Fast].

Wide Screen*

Sets Wide Screen. Set [ON] or [OFF] (default).

On Screen iPod

Sets how to display the information of the iPod.

Auto (Default): Information appears for 5 seconds when updated.

OFF: Does not display any information..

*** This setting is not available when an iPod is connected.**

DivX setup

1 | Set each item as follows.



DivX(R) Registration Code

Checks the registration code. This code is needed when making a disc which has DRM (Digital Rights Management).

DivX(R) Deactivation

Deregisters the unit which is already registered. After you touch the key, a confirmation message appears. Follow the message and complete the operation.

NOTE

- [DivX(R) Registration Code] is disabled when a DVD is being played.
- When downloading a DivX VOD file controlled by DRM, register the code appeared on the screen. Otherwise the file may not be able to play with this unit. Remaining number of viewing is displayed when playing a DivX VOD file with the viewing restriction. When the remaining number of viewing reached 0, a warning message appears and the file cannot be played.

Radio And TV Operation

Radio Basic Operation

Most functions can be controlled from the source control screen.

NOTE

- Set the remote controller mode switch to AUD mode before starting operation, see [Switching the operation mode \(P.89\)](#).

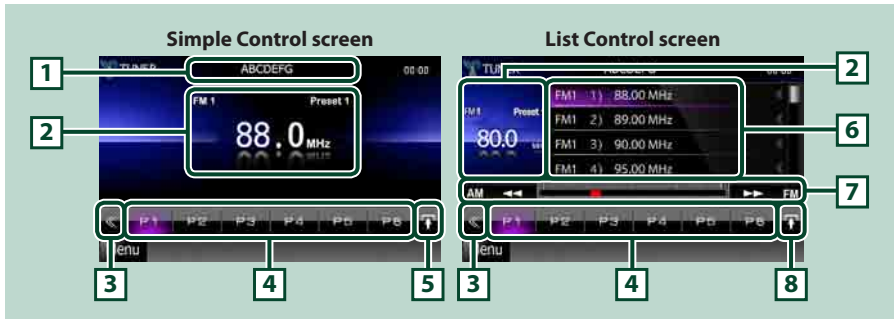

1 PS name display

Displays the PS name.

2 Information display/Control switching area

Displays the following information.

- [FM1], [AM], [MW], etc.: Band display
- Preset #: Preset number
- MHz/kHz: Frequency display

Touch to switch between the Simple Control and List Control screen.

3 Multi function key

Touch to switch the multi function menu. For details on the menu, see [Multi function menu \(P.45\)](#).

4 Preset key/Multi function menu

Recalls the memorized station or channel. When touched for 2 seconds, stores the current receiving station or channel in memory.

When switched, various functions can be performed by using keys in this area.

For details on the menu, see [Multi function menu \(P.45\)](#).

5 Sub function key

Touch to display "Sub function menu" (7 in this table).

6 Preset list

Displays the list of preset stations or channels and the information.

7 Sub function menu

The following functions can be performed by using keys in this area.

- **Switches the band:** Touch the desired band name.
- **Tunes in a station:** Touch [**◀◀**] [**▶▶**]. The method of frequency switching can be changed. See [Multi function menu \(P.45\)](#).

The bar in center (tuner only) shows the current frequency location.

8 List switching key

Touch to switch between the preset list and the information list.

In tuner mode, radio text plus will be displayed (for models with region code 2 or 3 only).

Multi function menu



The functions of each key are as follows.

[P1] - [P6]

Selects the preset station. Touch for 2 seconds to store the current station into the preset memory.



Displays the list of preset stations or channels.

[TI] (FM Tuner for models with region code 2 or 3 only)

Sets the traffic information mode on. For details, see [Traffic Information \(P.50\)](#).

[SEEK]

Switches the seek mode in the following sequence; [AUTO1], [AUTO2], [MANUAL].

- **AUTO1:** Tunes in a station with good reception automatically.
- **AUTO2:** Tunes in stations in memory one after another.
- **MANUAL:** Switches to the next frequency manually.

[AME]

Selects the auto memory mode. For details, see [Auto memory \(P.48\)](#).

[PTY] (FM Tuner for models with region code 2 or 3 only)

Searches a program by setting program type. For details, see [Search by program type \(P.49\)](#).

[CRSC] (FM Tuner for models with region code 4 or 6 only)

Switches to monaural to decrease noise when reception is poor.

[MONO] (FM Tuner for models with region code 2 or 3 only)

Select the Monaural reception.

[LO.S] (FM Tuner for models with region code 2 or 3 only)

Turns the Local Seek function on or off.



Touch to display the SETUP Menu screen. See [Setting Up \(P.68\)](#).



Touch to display the Audio Control screen. See [Controlling Audio \(P.80\)](#).



Touch to control the external device power supply. For details, see [External Device Control \(P.79\)](#).

TV Basic Operation

Most functions can be controlled from the source control screen and TV screen.

NOTE

- Set the remote controller mode switch to TV mode before starting operation, see [Switching the operation mode \(P.89\)](#).
- You can only operate TV with the optional accessory TV tuner KTC-V500N/PV300/N/P connected.
- During playback, press the <MENU> button to display the source control screen.

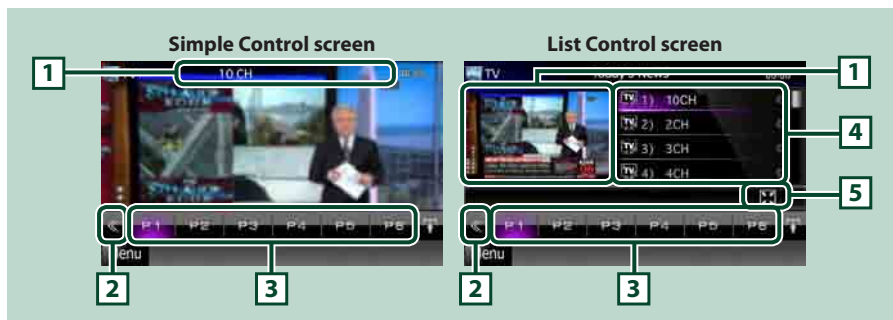

1 Information display/Control switching area

Displays the following information.

- [TV1], [TV2]: Band display
- Preset #: Preset number
- Group: TV area group
- #ch: Channel display

Touch to switch between the Simple Control and List Control screen.

2 Multi function key

Touch to switch the multi function menu. For details on the menu, see [Multi function menu \(P.47\)](#).

3 Preset key/Multi function menu

Recalls the memorized channel. When touched for 2 seconds, store the current receiving station or channel in memory.

When switched, various functions can be performed by using keys in this area.

For details on the menu, see [Multi function menu \(P.47\)](#).

4 Preset list

Displays the list of preset channels.

5 Sub function menu

The following function can be performed by using keys in this area.

- Hide all keys: Touch [].

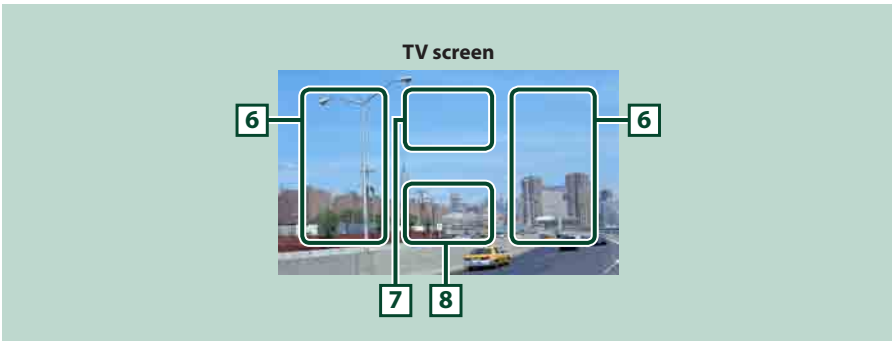

6 Switching channel area

Touch to switch the channel.

7 Switching band area

Touch to switch the band.

8 Key display area

Touch to display the last control screen.

Multi function menu



The functions of each key are as follows.

[P1] - [P6]

Selects the preset channel. Touch for 2 seconds to store the current channel into the preset memory.



Displays the list of preset channels.



Switches the channel.

[BAND]

Touch to switch the band.

[SEEK]

Switches the seek mode in the following sequence; [AUTO1], [AUTO2], [MANUAL].

- AUTO1: Tunes in channels with good reception automatically.
- AUTO2: Tunes in channels in memory one after another.
- MANUAL: Switches to the next channel manually.

[AME]

Selects the auto memory mode. For details, see [Auto memory \(P.48\)](#).

[SETUP]

Touch to display the SETUP Menu screen. See [Setting Up \(P.68\)](#).

[AUDIO]

Touch to display the Audio Control screen. See [Controlling Audio \(P.80\)](#).

[EXT SW]

Touch to control the external device power supply. For details, see [External Device Control \(P.79\)](#).

Memory Operation

Auto memory

You can store stations with good reception in memory automatically.

This function is for tuner and TV only.

NOTE

- Auto memory terminates when 6 stations are stored or when all stations are tuned in.
- The operation ends automatically if you do not operate within 10 seconds.

Tuner

1 | Touch [].

Sub function menu appears.

2 | Touch desired band key.



3 | Touch [] in the control screen.

The multi function menu appears.

4 | Touch [AME] in the multi function menu.

5 | Touch [] or [] in the sub function menu.

Auto memory starts.

TV (For models with region code 2 or 3)

1 | Touch illustrated area during playback to switch the band you want to store in memory.



2 | Touch illustrated area.



Simple Control screen appears.

3 | Touch [] in the control screen.

The multi function menu appears.

4 | Touch [AME] in the multi function menu.

5 | Touch [] or [] in the function menu.

Auto memory starts.

Manual memory

You can store the current receiving station or channel in memory.

- 1 | **Select a station or channel you wish to store in memory.**

NOTE

- For TV, touch center bottom area of the screen if source control screen is not displayed.

- 2 | **Touch [P#] (#:1-6) in which you want to store the station or channel for 2 seconds until a beep sounds.**

Selecting Operation

Preset select

You can list and select memorized station or channel.

Selecting from the multi function menu

- 1 | **Touch the desired number from P1 to P6.**
The unit will tune to the selected station or channel.

Selecting from the preset list

- 1 | **Touch illustrated area.**



List Control screen appears.

- 2 | **Select a station or channel from the list.**

Search by program type (FM tuner only)

You can tune to a station with a specific program type when listening to FM.

- 1 | **Touch [◀] in the control screen.**
The multi function menu appears.
- 2 | **Touch [PTY] in the multi function menu.**
TUNER PTY Mode screen appears.
- 3 | **Select a program type from the list.**
- 4 | **Touch [Search].**



You can search a station of the selected program type.

Traffic Information (FM tuner only)

You can listen and watch the traffic information automatically when a traffic bulletin starts.

However, this feature requires a Radio Data System that includes the TI information.

1 | Touch [] in the control screen.

The multi function menu appears.

2 | Touch [TI] in the multi function menu.

Traffic information mode is set.

When the traffic bulletin starts

The Traffic Information screen appears automatically.



NOTE

- It is necessary to have Traffic Information function set to on in order to have the Traffic Information screen appear automatically.
- The volume setting during reception of traffic information is automatically stored. The next time the traffic information is received, this unit recalls the volume setting automatically.

Frequency Step Setting

Change the tuning frequency step. The original setting is 50 kHz for FM band, and 9 kHz for AM band.

This function is available for models with region code 4 or 6.

1 |  While pressing <NAV> button and <▲> button, press <Reset> button.

 While pressing volume knob and <▲> button, press <Reset> button.

2 | Release your fingers from the buttons after the display appears.

The frequency step changes to 200 kHz for FM band, and 10 kHz for AM band.

Tuner Setup

You can set tuner related parameters.

This function is available for models with region code 2 or 3.

1 | Touch [] in the control screen.

Multi function menu appears.

2 | Touch [SETUP] in the multi function menu.

SETUP Menu screen appears.

3 | Touch [Source].



Source SETUP Menu screen appears.

4 | Touch [TUNER SETUP] in the list.

TUNER SETUP screen appears.

5 | Set each item as follows.



NEWS

Sets a news bulletin interrupt time. Default is "OFF."

AF

When station reception is poor, automatically switches to the station that is broadcasting the same program over the same Radio Data System network. Default is "ON."

Regional

Sets whether to switch to the station only in the specific region using the "AF" control. Default is "ON."

Auto TP Seek

When traffic information station reception is poor, automatically searches for a station that can be received better. Default is "ON."

Language Select

Selects a display language for the PTY function.

Antenna Control SETUP

Allows you to turn off the Radio Data System function to prevent the motor-driven antenna from extending. Default is "ON."

TV Setup

You can set the TV signal receiving areas.

NOTE

- Each operation in this section can be started from the Top Menu screen. For details, see [Operating With The Top Menu Screen \(P.16\)](#).

- 1 | Touch [] in the control screen.**
Multi function menu appears.
- 2 | Touch [SETUP] in the multi function menu.**
SETUP Menu screen appears.
- 3 | Touch [Source].**



Source SETUP Menu screen appears.

- 4 | Touch [TV SETUP] in the list.**
TV SETUP screen appears.

Continued

5 | Set each item as follows.



TV1 Area/TV2 Area

Sets the present TV1 or TV2 receiving area.
Touch [SET], and select the area and number.



This function is available only when KTC-V500N/
PV300/N/P optional accessory is connected.

On Screen TV

Sets how to display the information of the TV.

Auto (Default): Information appears for 5
seconds when updated.

OFF: Does not display any information.

Bluetooth Control

Using the Bluetooth function, various functions can be used: listening to the audio file, making/receiving a call.

NOTE

- To use Bluetooth function of DNX5380/ DNX5380M, the optional accessory (KCA-BT300) is necessary.

About the cell-phone and Bluetooth audio player

This unit conforms to the following Bluetooth specifications:

Version

Bluetooth Standard Ver. 2.1 + EDR

Profile

Cell-phone:

HFP (Hands Free Profile)

OPP (Object Push Profile)

PBAP (Phonebook Access Profile)

SYNC (Synchronization Profile)

Audio player **DNX7** :

A2DP (Advanced Audio Distribution Profile)

AVRCP (Audio/Video Remote Control Profile)

NOTE

- For the cell-phones verified for compatibility, access the following URL:
<http://www.kenwood.com/cs/ce/bt/>.
- The units supporting the Bluetooth function have been certified for conformity with the Bluetooth Standard following the procedure prescribed by Bluetooth SIG.
However, it may be impossible for such units to communicate with your cell-phone depending on its type.

Registering And Connecting Bluetooth Unit

It is necessary to register the Bluetooth audio player or cell-phone to this unit before using the Bluetooth function.

You can register up to 5 Bluetooth unit.

1 | Press the <TEL> button.

DNX7



DNX5

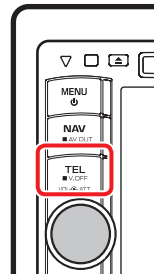

Hands Free screen appears.

2 | Touch [BT SETUP].



Bluetooth SETUP screen appears.

See the following section for each setting.

- **Registering the Bluetooth Unit** ([P.54](#))
- **Connecting the Bluetooth unit** ([P.54](#))

Registering the Bluetooth Unit

- 1 | **Touch [SET] of [Regist New Device].**
Searched Device List screen appears.

NOTE

- A new device cannot be registered if there are 5 registered Bluetooth units. Delete unnecessary registration. See [Connecting the Bluetooth unit \(P.54\)](#).
- If a Bluetooth unit cannot be registered by normal register (pairing) operation, touch [SP DEV]. For details, see [Registering special Bluetooth unit \(P.55\)](#).

- 2 | **Touch [PIN Code Set].**



PIN Code Set screen appears.

NOTE

- If the unit cannot be searched in step 1, you can search the unit again by touching [Search] in above screen.
- Touch [Cancel] to cancel searching for the Bluetooth unit.

- 3 | **Enter PIN code and touch [Enter].**

The entered code is recognized and Searched Device List screen appears again.

- 4 | **Select the Bluetooth unit to register from the list.**

The Connection Device List screen appears.

NOTE

- Registering operation can be performed from the Bluetooth unit. In this operation, entering the PIN code is necessary. See [Registering Bluetooth unit PIN code \(P.61\)](#).
- If registering cannot be completed even when the PIN code is correct, try [Registering special Bluetooth unit \(P.55\)](#).

Connecting the Bluetooth unit

- 1 | **Touch [SET] of [Paired Device List].**
Connection Device List screen appears.
- 2 | **Touch the device name you want to connect.**



Means that the device is a cell-phone.

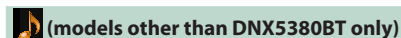

(models other than DNX5380BT only)

Means that the device is an audio player or cell-phone with audio player.

NOTE

- If the icon is lighted, it means that the unit will use that device.

- 3 | **Touch [TEL(HFP)] or [Audio(A2DP)].**
[TEL(HFP)] is for cell-phone.
[Audio(A2DP)] is for audio player.

NOTE

- [Audio(A2DP)] is available only for models other than DNX5380BT.
- Touching [Remove] removes registration information. After you touch the key, a confirmation message appears. Follow the message and complete the operation.
- To disconnect the device, perform above procedures again.

Registering special Bluetooth unit

If registering cannot be completed by normal operation, there is another method.

1 | Touch [SP DEV] in the Searched Device List screen.



Special Device List screen appears.

2 | Select the device name you want to register from the list.



Special Device Select Confirm screen appears.

3 | Confirm the device name and touch [Yes].

NOTE

- If you touch [No], operation is cancelled.
- The devices not listed cannot be registered.

Playing Bluetooth Audio Device (models other than DNX5380BT only)

Bluetooth basic operation

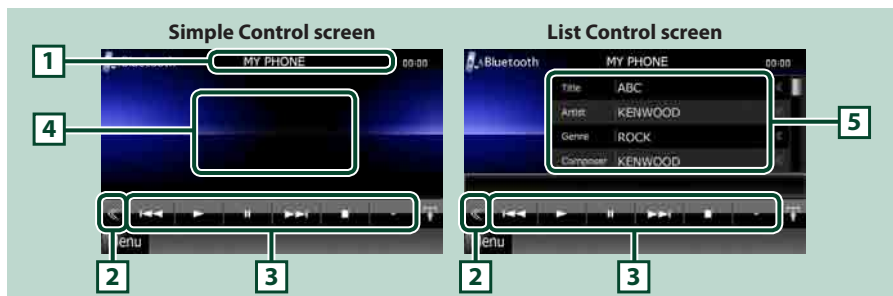

1 Information display

Displays the name of the track information. If the information is not available, device name is displayed.

2 Multi function key

Touch to switch the multi function menu.

3 Multi function menu

The functions of each key are as follows.

- [**◀◀**] [**▶▶**]: Searches the previous/next content.*
- [**▶**]: Plays.*
- [**⏸**]: Pauses.*
- [**🔊** AUDIO]: Touch to display the Audio Control screen. See [Controlling Audio \(P.80\)](#).
- [**⚙️** SETUP]: Touch to display the SETUP Menu screen. See [Setting Up \(P.68\)](#).
- [**🔌** EXT SW] **DNX7**: Control the external device power supply. For details, see [External Device Control \(P.79\)](#).

4 Control switching area **DNX7**

Touch to switch between the Simple Control and List Control screen.

5 File information **DNX7**

Displays the information of the current file.

* These items appear only when the audio player which supports AVRCP profile is connected.

NOTE

- If the operation keys do not appear, operate from the player.
- Depending on your cell-phone or audio player, audio may be heard and controlled but text information may not appear.

Using Hands-Free Unit

You can use telephone function by connecting the Bluetooth telephone to this unit.

Downloading the phonebook

If you want to use your phonebook data, it is necessary to download the data from the cell-phone to this unit in advance.

- 1 | Operate the cell-phone to send the phonebook data to this unit.
- 2 | Operate the cell-phone to start the hands-free connection.

NOTE

- If your cell-phone supports auto-download of phonebook but not downloaded automatically, follow the procedure above to download manually.
- See the instruction manual of your cell-phone for the operation.
- Up to 1000 phone numbers can be registered for each registered cell-phone.
- Up to 32 digits for **DNX7**, DNX5380, and DNX5380M or 25 digits for DNX5380BT can be registered for each phone number along with up to 50 characters representing a name. (50 is the number of alphabetical characters. Fewer characters can be input depending on the type of characters.)
- Depending on the type of your cell-phone, the following restrictions are placed;
 - The phonebook data cannot be downloaded normally.
 - Characters in the phonebook are garbled.
- To cancel downloading the phonebook data, operate the cell-phone.

Making a call

- 1 | Press the <TEL> button.
DNX7



DNX5

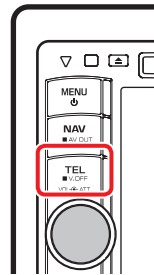

Hands Free screen appears.

Continued

2 | Select a dialing method.

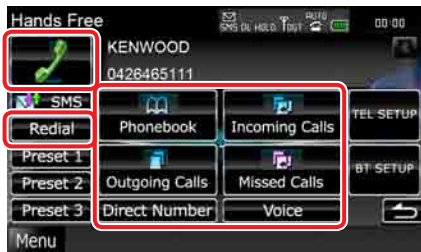

See the following table for each method.

Call by entering a phone number

- ① Touch [Direct Number].
- ② Enter a phone number with number keys.
- ③ Touch [].

Call using call records

- ① Touch [Incoming Calls], [Outgoing Calls], or [Missed Calls].
- ② Select the phone number from the list.
- ③ Touch [].

Redial

- ① Touch [Redial] to display the previously called number.
- ② Touch [].

Call using the phonebook

- ① Touch [Phonebook].
- ② Select the name from the list.*1*2
- ③ Select the number from the list.
- ④ Touch [].

Call using the preset number

- ① Touch [Preset #] to start calling the corresponding phone number.

Call using voice recognition

It is necessary to register your voice in the phonebook data. For details, see [Voice registration \(P.66\)](#) and [Key word voice registration \(P.67\)](#).

- ① Touch [Voice].
- ② Say the name registered in the phonebook within 2 seconds after a beep.*3
- ③ Touch [].

*1 You can sort the list to begin with touched character.



- Characters with no corresponding name will not appear.
- During search, a non-accent character such as "u" is searched for instead of an accent character such as "ü".

*2 You can set the list to arrange in the order of last name or first name. For details, see [Setting up the Hands-Free phone \(P.62\)](#).

*3 If more than one number are assigned to one name, say the key word for the category, and then touch [] to make a call.

If there are plural numbers under one key word or if you do not register the key word voice to the unit, touch [Phonebook] and select the desired number from the list.

NOTE

- While your car is moving, some functions are disabled for safety reasons. The keys associated with the disabled functions become ineffective if touched.
- The status icons such as battery and antenna displayed may differ from those displayed on the cell-phone.
- Setting the cell-phone in the private mode can disable the hands-free function.

Receiving a call

- 1 Touch [] to answer a phone call or [] to reject an incoming call.



NOTE

- While monitoring the camera view, this screen does not appear even if a call comes in. To display this screen, press the <TEL> button or return the shift knob of car to the driver position.

Operations during a call

Adjust the receiver volume

DNX7

Press the <▼> or <▲> button.

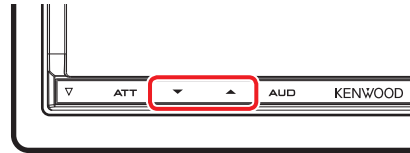

DNX5

Turn the volume knob.

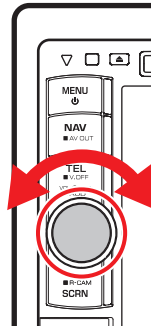

Switch the voice output

Touch [] to switch the voice output between phone and speaker.

Output the dial tone

Touch [DTMF] to display the tone input screen. You can send tones by touching desired keys on the screen.

Muting Audio Volume upon Reception of Phone Call

(DNX5380 and DNX5380M only)

When a call is received or you answer a call, the Call Interrupt screen appears and system is paused.



The system resumes playing automatically when the call ends and hang up the phone.

NOTE

- To use the Mute feature, you need to hook up the mute wire to your telephone using a commercial telephone accessory. See "Connection" (P.29) in Quick Start Guide.

Call waiting

If you receive a call during another call, you can answer it with the current call suspended or switch between the current call and waiting call.

Answer the new incoming call

Touch []. The current call is kept suspended.

Switch between the current and waiting call

Touch [] again.

Each time you touch [], the calling party is switched.

Terminate the current call

Touch [].

The call switches to the waiting one.

Bluetooth Setup

You can register PIN code, select the device to connect, and perform output setup.

1 | Press the <TEL> button.

DNX7



DNX5

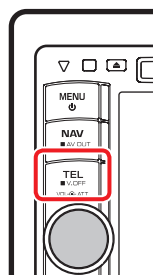

Hands Free screen appears.

2 | Touch [BT SETUP].



Bluetooth SETUP screen appears.

See the following section for each setting.

- Register the PIN code [\(P.61\)](#)
- Select the unit to connect [\(P.54\)](#)
- Set up output [\(P.61\)](#)

Registering Bluetooth unit PIN code

You can set the PIN code to the Bluetooth unit. The code is acquired when registering (pairing) from the cell-phone or audio player side.

1 | Touch [SET] of [Receiver PIN Code] in the Bluetooth SETUP screen.

Receiver PIN Code Set screen appears.

2 | Enter a code number and touch [Enter].

NOTE

- If you want to cancel the registration, touch [Cancel].
- If you want to clear the entered number, touch [Clear].

Bluetooth output setup

You can select speakers to output the sound from cell-phone (such as phone call voice and ringing tone) and Bluetooth audio player.

1 | Touch [Front Only] or [All] of [Bluetooth HF/Audio] in the Bluetooth SETUP screen.

Front Only

Outputs from the front speakers.

All

Outputs from all speakers.

Hands-Free Control

You can perform various setup about hands-free function.

1 | Press the <TEL> button.

Hands Free screen appears.

2 | Touch desired key in the Hands Free screen.



See the following section for each setting.

- Set up the Hands-Free system ([P.62](#))
- Set up SMS ([P.63](#))
- Preset the phone number ([P.65](#))
- Register your voice ([P.66](#))
- Register key word voice ([P.67](#))

Setting up the Hands-Free phone

1 | Touch [TEL SETUP] in the Hands Free screen.

Hands Free SETUP screen appears.

2 | Set each item as follows.

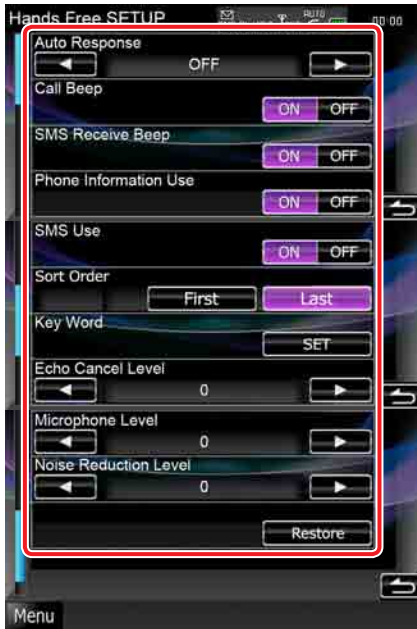

Auto Response*1

Sets an automatic response time to pick-up an incoming call.

OFF (Default)*2: Automatic response is not available.

0-99: Set calling ring time (second).

Call Beep

Select whether to beep at an incoming call.

ON (Default): Beeps.

OFF: Not beeps.

SMS Receive Beep

Select whether to beep at an incoming SMS.

ON (Default): Beeps.

OFF: Not beeps.

Phone Information Use

Sets whether to download phonebook for outgoing, incoming and missed calls list.

ON (Default): Yes.

OFF: No.

SMS Use

Select whether to use SMS.

ON (Default): Uses SMS.

OFF: Not uses SMS.

Sort Order

Sets how to arrange the cell-phone phonebook.

First: Arranges in the order of first name.

Last (Default): Arranges in the order of last name.

Key Word

Registers the voice to this unit and uses to recognize phone number category.

See [Key word voice registration \(P.67\)](#).

Echo Cancel Level DNX7/DNX5380BT

Adjusts the level of echo cancellation.

Default is "15".

Microphone Level DNX7/DNX5380BT

Adjusts the sensitivity of the telephone microphone. Default is "2" DNX7/ "8"(DNX5380BT).

Noise Reduction Level DNX7/DNX5380BT

Reduces the noises generated by surrounding environment without changing the microphone volume. Use this setting when the voice of caller is not clear. Default is "15" DNX7 / "4"(DNX5380BT).

[Restore]

Resets the settings to the default settings.

***1 Either the time interval for automatic answer set on this unit or the time interval set on the cell-phone, whichever is shorter takes effect.**

***2 As for DNX5380/DNX5380M, the default value is "8".**

SMS (Short Message Service)

You can use SMS function.

1 | Touch [SMS] in the Hands Free screen.

SMS Select screen appears.

2 | Select desired function from the list.

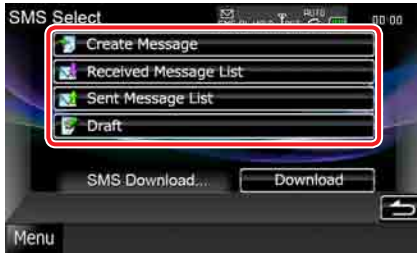

[Create Message]

Creates a message.

For details, see [Creating a new message \(P.64\)](#).

[Received Message List]

Displays the received message list.

[Sent Message List]

Displays the sent message list.

[Draft]

Displays the newest draft message. This key becomes active when any message has been created after turning power on.

[Download]

Retrieves message.

Operations in the message list screen

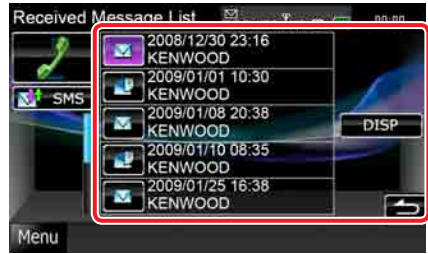

Calls the number in the message

Select desired message from the message list.

Displays message

Touch [DISP] to display the selected message.

Create a return message

Touch [SMS].

Creating a new message

1 | Touch [Create Message] in the SMS Select screen.

SMS Create Menu screen appears.

2 | Touch [📖] or [Direct Number].

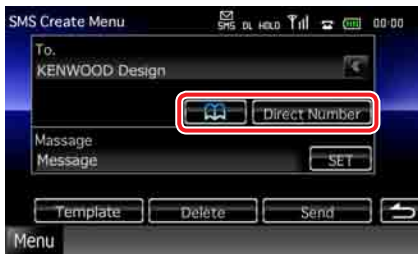

Select from the phonebook

Touch [📖].

Enter the phone number

Touch [Direct Number].

3 | Touch [SET] of [Message] in the SMS Create Menu screen.

Create SMS Message screen appears.

4 | Enter a message using keys and touch [SET].



Moves the cursor

Use [◀] [▶].

Switches the keyboard layout

Use [▲] [▼]. The layout changes in the following sequence; Alphabet, numbers, local language.

Toggles between uppercase and lowercase

Touch [Shift].

Changes the layout of the character keys

[abc]: Alphabetical layout

[qwe]: Qwerty layout

[ALT]: Alternate key

Erases the entered character

Touch [Clear]. To erase all the input characters, touch for 2 seconds.

Enters a space

Touch [Space] at desired position.

5 | Touch [Send].

The message is sent.

NOTE

- [Delete] appears only when a draft message is being edited. Touching [Delete] deletes the message. After you touch [Delete], a confirmation message appears. Follow the message and complete the operation.

Using templates

You can create a message easily by selecting the desired sentence from the template list.

1 | Touch [Create Message] in the SMS Select screen.

SMS Create Menu screen appears.

2 | Touch [Template].

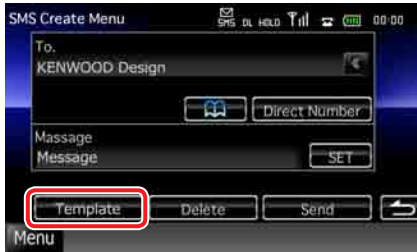

Template list screen appears.

3 | Touch the desired template.

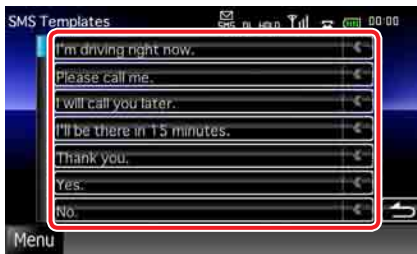

Selected template is entered.

Phone number preset

You can register frequently used phone numbers to this unit.

1 | Touch [Preset 1], [Preset 2], or [Preset 3] for 2 seconds in the Hands Free screen.

NOTE

- When there is no preset number, touching the key momentarily moves to the step 2.

2 | Touch desired key and enter the number you want to register.

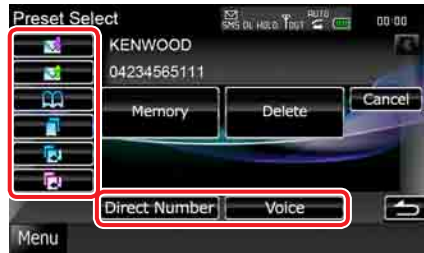

See the table below for explanations for each key.

Register from received SMS messages

Touch [].

Register from sent SMS messages

Touch [].

Register from phonebook

Touch [].

Register from outgoing calls list

Touch [].

Register from incoming call list

Touch [].

Register from missed calls list

Touch [].

Enter phone numbers

Touch [Direct Number].

Register voice

Touch [Voice].

3 | Touch [Memory].

Entered number is registered to the preset number you selected.

NOTE

- Touching [Delete] deletes the currently displayed number. After you touch [Delete], a confirmation message appears. Follow the message and complete the operation.

Voice registration

You can register your voice for the voice recognition feature which links to the phonebook information. Up to 35 voice memory positions can be registered for each paired cell phone.

1 | Touch [Phonebook] in the Hands Free screen.

Phonebook screen appears.

2 | Select desired name from the list.

3 | Touch [Record].

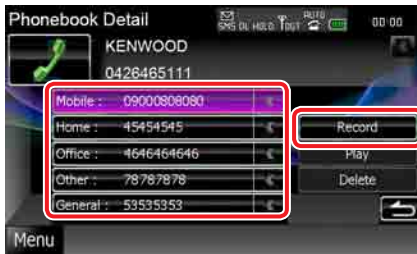

Address Recording screen appears.

NOTE

- A new voice tag cannot be registered if there are 35 registered voice tags. In that case, [Record] is deactivated.
- Touching [Play] plays the voice registered in the selected Phonebook file.
- Touching [Delete] deletes the voice tag registered in currently selected Phonebook file. After you touch [Delete], a confirmation message appears. Follow the message and complete the operation.

4 | Say the name within 2 seconds after a beep and touch [Record]. (1st try)



5 | Say the name again within 2 seconds after a beep. (2nd try)

If successful, the message appears and the voice registration ends.

NOTE

- A message appears if the voice is not recognized. Read the message for the further operation.
- Repeat from 1st try if the voice is different from the 1st try.

Key word voice registration

You can register your voice for the voice recognition feature which links to the phonebook category information.

1 Touch [SET] of [Key Word] in the Hands Free SETUP screen.

Key Word List screen appears.

2 Select desired phone number category from the list and touch [Record].

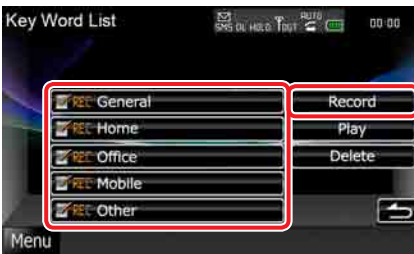

Key Word Recording screen appears.

NOTE

- The phone number with a voice already registered will show the "REC" icon as active.
- Touching [Play] plays the voice registered in the selected phone number category. This key does not appear for DNX5380BT.
- Touching [Delete] deletes the voice registered in currently selected category. After you touch [Delete], a confirmation message appears. Follow the message and complete the operation. This key does not appear for DNX5380BT.

3 Say the phone category within 2 seconds after a beep and touch [Record]. (1st try)



4 Say the phone category again within 2 seconds after a beep. (2nd try)

If successful, the message appears and the voice registration ends.

NOTE

- A message appears if the voice is not recognized. Read the message for the further operation.
- Repeat from 1st try if the voice is different from the 1st try.

Setting Up

Monitor Screen Setup

You can adjust image quality in iPod video, picture file, menu screen, etc.

- 1 Press the button instructed in each diagram when the desired screen is displayed.

DNX7



DNX5

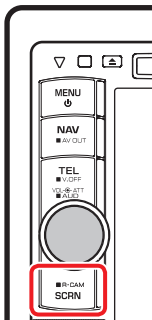

Screen Control screen appears.

- 2 Adjust each item as follows.



Bright/Tint/Color/Contrast/Black/Sharpness

Adjusts each item.

Dimmer

Select dimmer mode.

ON: The display and buttons dim.

OFF: The display and buttons do not dim.

SYNC (Default): Turns the dimmer function on or off when the vehicle light control switch is turned on or off.

NAV-SYNC: Turns the dimmer function on or off according to the Navigation Day/Night display setting.

Mode (Playback screen only)

Select screen mode.

Full: Full picture mode

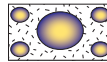

Just: Justify picture mode

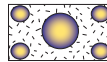

Zoom: Zoom picture mode

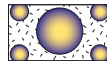

Normal: Normal picture mode

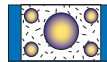

NOTE

- Adjusting items are different depending on the current source.
- You can perform this function only when you have applied the parking brake.
- The image quality can be set for each source.

System Setup

NOTE

- Each operation in this section can be started from the multi function menu.

1 | Touch [Menu] on any screen.

TOP Menu screen appears.

2 | Touch [SETUP].

3 | Touch [System].



System Menu screen appears.

See the following section for each setting.

- **Set up the user interface** [\(P.69\)](#)
- **Adjust touch panel** [\(P.71\)](#)
- **Set up security** [\(P.71\)](#)
- **Set up external switch** **DNX7** [\(P.72\)](#)
- **Set up memory** [\(P.73\)](#)

User interface

You can setup user interface parameters.

1 | Touch [User Interface] in the list.

User Interface screen appears.

2 | Set each item as follows.



Beep

Turns the key touch tone on or off.
Default is "ON".

Remote Sensor*

Selects a remote control signal. Default is "ON".

Language

Select the language used for the control screen and setting items. See [Language setup \(P.70\)](#).

Text Scroll

Allows scrolling of text display on the source control screen. Select from "Auto"/"Once"/"OFF".

Auto (Default): Scrolls the text automatically.

Once: Allows you to scroll the text only once automatically when updated.

OFF: Does not scroll the text automatically.

*** When turned off "Remote Sensor", the remote control of TV reception is rejected.**

Continued

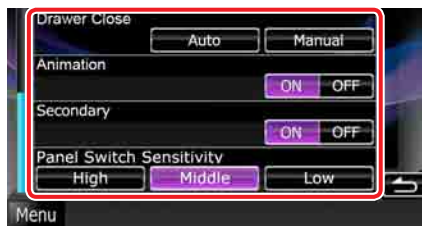

Drawer Close

Sets whether to close the common menu [\(P.18\)](#) automatically. Default is "Auto".

Animation

Sets whether to display animation. Default is "ON".

Secondary

Sets whether to display the navigation information in the audio screen or vice versa. Default is "ON".

Panel Switch Sensitivity **DNX7**

Adjusts the sensitivity of the front panel button (ATT button, etc.)

High: Sets sensitivity to high.

Middle (Default): Sets sensitivity to middle.

Low: Sets sensitivity to low.

Steering Remote Controller

Sets the desired function in the steering remote controller. See [Learning function of steering remote \(P.71\)](#).

Language setup

1 | Touch [SET] of [Language] in the User Interface screen.

Language Setting screen appears.

2 | Set each item as follows.



Select Mode

Selects the mode to select a language.

Easy (Default): Selects a language easily.

Advanced: Allows you to select languages for respective items.*

Language Select

Selects a language.

* If you select [Advanced] for Select Mode, the following screen appears.



GUI Language Select:

Selects the display language used for the control screen and so forth.

Navigation Language Select:

Selects the language used for navigation.

Text Language Select:

Selects the language used for tag text (song information).

3 | Touch [Enter].

NOTE

- To cancel the language setup, touch [Cancel].

Learning function of steering remote

This function is available only when your vehicle is equipped with the electrical steering remote controller.

If your steering remote controller is not compliant, learning may not be completed and error message may appear.

1 | Touch [SET] of [Steering Remote Controller].

Steering Remote Controller Setting screen appears.

2 | Press the steering remote controller button you want to set the function.

NOTE

- You can have the unit learned all buttons at a time. In that case, press the all buttons one at a time and after pressing all of them, touch [Done] in Steering Remote Controller Setting screen. However, new functions cannot be learned after this operation.

3 | Touch the function you want to set.



4 | Repeat steps 2 and 3 as necessary.

5 | Touch [Done].

NOTE

- When changing the function already learned, touch the button you want to change in step 2 and then touch to select the changed function from the function list.
- Confirm the contents of the settable function on the function list. You cannot edit the function list.
- To initialize the contents, touch [Initialize] of [Steering Remote Controller] in User Interface screen. After you touch [Initialize], a confirmation message appears. Follow the message and complete the operation.

Touch panel adjustment

1 | Touch [Touch] in the System Menu screen.

Touch Panel Adjustment screen appears.

2 | Follow the instruction on the screen and touch the center of each .

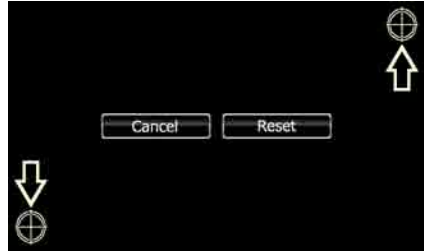

NOTE

- To cancel the touch panel adjustment, touch [Cancel].
- To reset to the initial status, touch [Reset].

Security setup

You can set up a security code to protect your receiver system against theft.

NOTE

- When the Security Code function is activated, the code cannot be changed and the function cannot be released. Note the Security Code can be set as the 4 digit number of your choice.

1 | Touch [Security] in the System Menu screen.

Security screen appears.

Continued

2 | Touch [ON] of [SI].



NOTE

- If "SI" is turned on, the SI indicator on the sub panel flashes when the vehicle ignition is off and the panel is detached. Default is "ON."

3 | Touch [SET] of [Security Code Set].

NOTE

- If you have already completed the code registration, [CLR] is displayed.

4 | Enter a security code with four-digit number and touch [Enter].

5 | Enter the same code again and touch [Enter].

Security code is registered.

NOTE

- If you enter a different security code, the screen returns to step 4 (for the first code entry).
- If you have pressed <Reset> button or if you have disconnected the Receiver from battery, enter the correct security code as that you have entered in step 4 and touch [Enter]. You can use your Receiver.

EXT SW setup **DNX7**

Set up the external switch power mode.

1 | Touch [EXT SW] in the System Menu screen.

EXT SW screen appears.

2 | Set each item as follows.

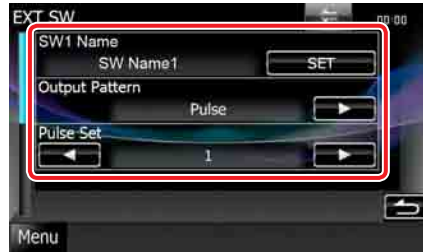

SW1 Name/SW2 Name

Sets the name of the external device.

Output Pattern

Sets the power signal output mode among "Pulse"/"Level". Default for EXT SW1 is "Pulse" and for EXT SW2 is "Level".

You can set to turn output on/off each time the button on the EXT SW screen is touched. See [External Device Control \(P.79\)](#)

Pulse Set

Sets the pulse signal output time.

Outputs 500ms when "1" is set.

Increases by 200ms with each step. Up to 100 steps can be set.

NOTE

- You can enter characters only after you have applied the parking brake.
- "Pulse": Generates a single power signal pulse.



- "Level": Continues output of high power signal.



Setup memory

Audio Control, AV-IN SETUP, Navigation, Camera, and Audio SETUP settings can be memorized. The memorized settings can be recalled at any time. For example, even when the settings are cleared due to replacement of the battery, the settings can be restored.

1 | Touch [SETUP Memory] in the System Menu screen.

SETUP Memory screen appears.

2 | Follow the instruction on the screen.

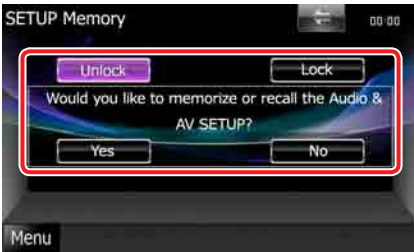

[Lock]/[Unlock]*

Locks or unlocks the AV-IN SETUP, Navigation, and Audio SETUP settings.

Yes

Memorizes or recalls the settings.

No

Cancels the function or memorization.
The SETUP Menu screen appears again.

* When [Lock] is selected, you cannot change the AV-IN SETUP, Navigation, and Audio SETUP settings.
Also, the locked key mark is displayed under each setting icon in the setup menu.

3 | Follow the instruction on the screen.

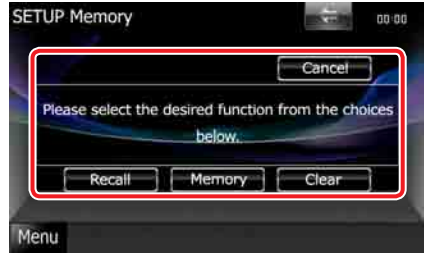

Recall

Recalls the memorized settings.

Memory

Memorizes the current settings.

Clear

Clears the currently memorized settings.

Cancel

Quits memorization/recalling of settings.

Display Setup

1 | Touch [Menu] on any screen.

2 | Touch [SETUP].

SETUP Menu screen appears.

3 | Touch [Display].



Display Menu screen appears.

See the following section for each setting.

- **Control monitor angle** **DNX7** [\(P.74\)](#)
- **Adjust panel color** [\(P.74\)](#)
- **Changing background image** [\(P.75\)](#)

Monitor angle control **DNX7**

You can adjust the position of the monitor.

- 1 | **Touch [Angle] in the Display Menu screen.**
Angle setup screen appears.
- 2 | **Select a below number that represents your desired angle setting.**



Default is "0".

NOTE

- You can store the current monitor angle as the angle during power off. Touch [Memory] when the desired angle is selected. However, the setting value returns to "0" if you detach the front panel.
- The front panel can be set to open automatically when the ignition is turned off, so that it can be detached for antitheft purpose. Touch [ON] of [Auto Open].

Panel color coordinate

You can set the screen and button illumination color.

The selectable items differ depending on the unit.

- 1 | **Touch [Color] in the Display Menu screen.**
Color screen appears.
- 2 | **Touch [SET] of [Panel Color Coordinate].**

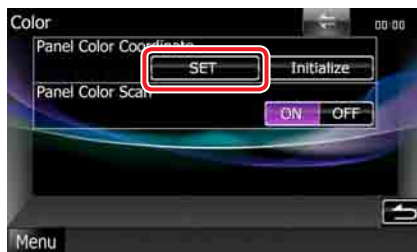

Panel Color Coordinate screen appears.

NOTE

- You can touch [SET] or [Initialize] when [Panel Color Scan] is set to off.
- Touch [Initialize] to reset the settings to the default settings.

- 3 | **Touch the desired color.**



Registering original color

You can register your original color.

1 | Touch [Adjust] in the Panel Color Coordinate screen.

Panel Color RGB Coordinate screen appears.

2 | Use [◀] and [▶] to adjust each color value.

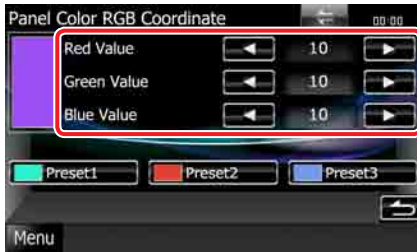

3 | Touch the desired preset key for 2 seconds.

Panel color scan

You can set the panel color to continuously scan through the color spectrum.

1 | Touch [ON] of [Panel Color Scan] in the Color screen.

Panel Color Scan is set to on.

Changing background image

You can load an image from the connected USB device and set it for the background image.

Before operating this procedure, it is necessary to connect the device which has the image to load.

1 | Touch [Background] in the Display Menu screen.

Background screen appears.

2 | Touch [STANDBY].



3 | Touch [Memory] of [User Background].

User Background File Select screen appears.

4 | Select the image to load.

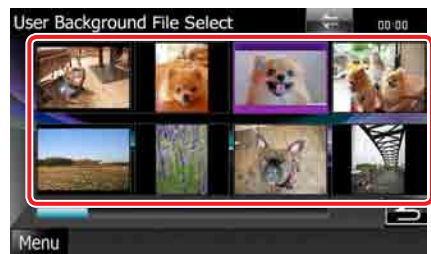

Continued

5 | Touch [Enter].



The selected image is loaded and the display returns to the Background screen.

NOTE

- Touching [↶] rotates counter clockwise.
- Touching [↷] rotates clockwise.

6 | Touch [Change] of [Background Change] in the Background screen.

7 | Select an image for background and touch [Enter].

NOTE

- See [Playable Media And Files \(P.95\)](#) for readable image specifications.
- Touching [Delete] in the Background screen deletes the background image. After you touch [Delete], a confirmation message appears. Follow the message and complete the operation.

Navigation Setup

You can set navigation parameters.

1 | Touch [Menu] on any screen.

2 | Touch [SETUP].

SETUP Menu screen appears.

3 | Touch [Navigation].



Navigation SETUP screen appears.

4 | Set each item as follows.



NAV Interrupt Speaker

Selects speakers used for voice guidance of the navigation system.

Front L: Uses the front left side speaker for voice guidance.

Front R: Uses the front right side speaker for voice guidance.

Front All (Default): Uses both front speakers for voice guidance.

NAV Voice Volume

Adjusts the volume for voice guidance of the navigation system. Default is "25".

NAV Mute

Mutes the volume of rear speakers during voice guidance of the navigation system. Default is "ON".

Camera Setup

You can set camera parameters.

1 | Touch [Menu] on any screen.

2 | Touch [SETUP].

SETUP Menu screen appears.

3 | Touch [Camera].



Camera SETUP screen appears.

4 | Set each item as follows.

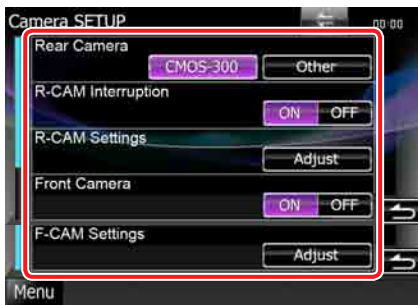

Rear Camera*¹ **DNX7**

Selects the type of rear camera to use.

CMOS-300: When the CMOS-300 with ID 1 set is connected.

Other (Default): When the other camera is connected.

R-CAM Interruption

Sets a method for switching the display. Setting values are ON and OFF.

ON: Switches to the rear view camera video display when shifting to reverse or pressing the <AUD> **DNX7** or <SCRN> **DNX5** button for 1 second.

OFF (Default): Switches to the rear view camera video display when pressing the <AUD> **DNX7** or <SCRN> **DNX5** button for 1 second.

R-CAM Settings*² **DNX7**

Adjusts the CMOS-300 with ID 1 set. For details, see the instruction manual of your camera.

Front Camera*¹ **DNX7**

Turn this setting on when the CMOS-300 with ID 2 set is connected. Setting values are ON and OFF. Default is "OFF".

F-CAM Settings*³ **DNX7**

Adjusts the CMOS-300 with ID 2 set. For details, see the instruction manual of your camera.

*¹ These settings become settable only when the parking brake is on.

*² This setting becomes settable only when the parking brake is on and the CMOS-300 is selected.

*³ This setting becomes settable only when the parking brake is on and "Front Camera" is set to [ON].

Software Information

Check the software version of this unit.

- 1 | Touch [Menu] on any screen.
- 2 | Touch [SETUP].
SETUP Menu screen appears.
- 3 | Touch [Software].



Software Information screen appears.

- 4 | Confirm the software version. Touch [Update] as necessary.

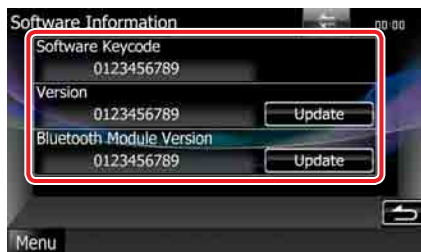

NOTE

- For how to update the software, see the relevant update procedure manual which comes with the software.

AV Input Setup

You can set AV input parameters.

- 1 | Touch [Menu] on any screen.
- 2 | Touch [SETUP].
SETUP Menu screen appears.
- 3 | Touch [Source].



- 4 | Touch [AV-IN SETUP] in the list.
AV-IN SETUP screen appears.

- 5 | Set each item as follows.

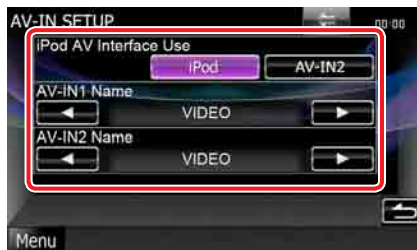

iPod AV Interface Use*1

Sets the terminal which iPod is connected.
Setting values are iPod and AV-IN2. Default is "iPod".

AV-IN1 Name/AV-IN2 Name*2

Sets a name to be displayed when you select a system that is connected via the AV INPUT port. Default is "VIDEO".

- *1 This item can be set when in STANDBY source and also the iPod is disconnected.
- *2 [AV-IN2 Name] becomes settable when "AV-IN2" is selected in [iPod AV Interface Use].

AV Output Interface Setup

You can select an AV source to be output at the AV OUTPUT port. Default is "OFF."

- 1 | Touch [Menu] on any screen.
- 2 | Touch [SETUP].
SETUP Menu screen appears.
- 3 | Touch [AV-OUT].



AV-OUT Interface screen appears.

- 4 | Touch [◀] or [▶] to set [AV-OUT] to VIDEO, DISC, TV, iPod or OFF.

External Device Control **DNX7**

Control the external device power supply.

- 1 | Touch [EXT SW] in the Source Control screen.



EXT SW Control screen appears.

NOTE

- If [EXT SW] is not displayed, touch [◀].

- 2 | Touch the desired switch key.

You can turn on or off the external device power supply.

NOTE

- You must connect a commercially available relay unit in order to use this function. Connect the external device to be controlled to that relay unit.
- See [EXT SW setup \(P.72\)](#) for information on setting the power on or off specification.

Controlling Audio

NOTE

- Each operation in this section can be started from the multi function menu.

You can adjust the various settings such as audio balance or subwoofer level.

1 | Touch [Menu] on any screen.

2 | Touch [Audio].

Audio screen appears.

See the following section for each setting.

- **Setting audio** ([P.80](#))
- **Controlling audio** ([P.83](#))
- **Controlling equalizer** ([P.84](#))
- **Performing zone control** ([P.86](#))
- **Set space enhancer** **DNX7** ([P.86](#))
- **Set listening position** **DNX7** ([P.87](#))

Setting Audio

1 | Touch [Audio SETUP].



DNX7

Audio SETUP screen appears.



See the following section for each setting.

- **Set up speakers** ([P.80](#))
- **Set up your car type (DTA)** ([P.82](#))
- **Select DSP** ([P.83](#))

DNX6 **DNX5**

Speaker Select screen appears.

- **Set up speakers** ([P.80](#))

Speaker setup

You can select a speaker type and its size to get the best sound effects.

When the speaker type and size are set, the speaker crossover network and equalizer curve are set automatically.

1 | Touch [Speaker Select] in the Audio SETUP screen. **DNX7**

Speaker Select screen appears.

2 | Touch the speaker you wish to adjust and set each item as follows.



Subwoofer **DNX5**

Select if you are using a subwoofer.

Tweeter **DNX7**

You can set the tweeter when you are selecting front speakers.

If you are using a tweeter together with the front speakers, set the tweeter to "ON".

In the "ON" position, the Equalizer is adjusted to its best position.

X'over

Displays the speaker crossover setup screen.

You can adjust the crossover setup that was set automatically when you selected the speaker type.

For details, see [Crossover network setup \(P.81\)](#).

- 3** Select a speaker size using [◀] and [▶]. The speaker size is different depending on the speaker type and the unit.

DNX7

Front

OEM, 10 cm, 13 cm, 16 cm, 17 cm, 18 cm, 4x6, 5x7, 6x8, 6x9, 7x10

Rear

None, OEM, 10 cm, 13 cm, 16 cm, 17 cm, 18 cm, 4x6, 5x7, 6x8, 6x9, 7x10

Subwoofer

None, 16 cm, 20 cm, 25 cm, 30 cm, 38 cm over

NOTE

- Select "None" if you have no speakers.

DNX5

Front

Standard, Wide, Middle, Narrow

Crossover network setup

You can set a crossover frequency of speakers.

- 1** Touch the speaker to set the crossover in the Speaker Select screen.
- 2** Touch [X'over].
X'over screen appears.
- 3** Set each item as follows.



Phase*

Sets the phase of subwoofer output.

The phase is reversed 180 degrees when set to "Reverse."

HPF FREQ

High Pass Filter adjustment. (When front or rear speaker is selected on Speaker Select screen)

LPF FREQ

Low Pass Filter adjustment. (When subwoofer is selected on Speaker Select screen)

Slope DNX7

Sets a crossover slope.

* This function is available in the specific situation.

DNX7 Only when "Subwoofer" is set to "ON" in "Speaker Setup".

DNX5 Only when "Subwoofer" is set to "ON" in "Speaker Setup" and "LPF FREQ" is set to other than "Through".

Car type (DTA) setup **DNX7**

You can setup the car type and speaker network, etc.

1 | Touch [Car Type] in the Audio SETUP screen.

Car Type screen appears.

2 | Select your car type from the list.



NOTE

- If your car type is selected, the Delay Time Alignment and Equalizer is set automatically (for timing adjustment of sound output for each channel) to have the highest surround effects.

Speaker location setup

1 | In the Car Type screen, touch [Location].

Speaker Location screen appears.

2 | Select the speaker locations using [▶].



Front Speaker

Select the location from "Door"/"On Dash"/"Under Dash."

Rear Speaker

Select the location from "Door"/"Rear Deck", "2nd Row"/"3rd Row" (Minivan, Minivan (Long)).

Car type adjust

You can manually set the sound output timing of each channel.

1 | In the Car Type screen, touch [Adjust].

Car Type Adjust screen appears.

2 | Touch the speaker you wish to adjust and set a delay time using [◀] and [▶] or slider bar.



NOTE

- Make fine adjustment of the delay time of the speaker output specified here to have a more suitable environment for your vehicle.
- The settings of the delay time are automatically identified and compensated by specifying the distances of each speaker from the center of the vehicle interior.

- ① Set the front and rear positions and the height of the reference point to the position of the ears of the person sitting in the front seat, and set the right and left positions to the center of the vehicle interior.
- ② Measure the distances from the reference point to the speakers.
- ③ Calculate the distance difference in accordance with the farthest speaker.

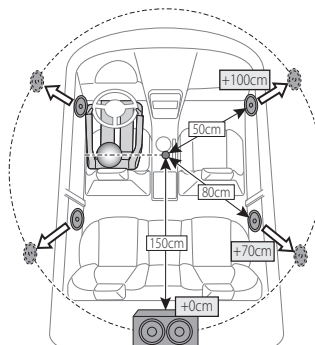

DSP select **DNX7**

You can select whether using DSP (Digital Signal Processor) System.

1 | Touch [Bypass] or [Through] of [DSP Select] in the Audio SETUP screen.

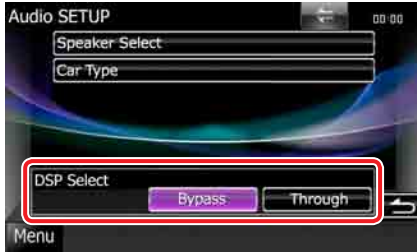

Bypass

There is no effect by DSP.

Through

There is an effect by DSP.

NOTE

- When the mode is set to [Bypass], DSP System cannot be adjusted.

Controlling General Audio

1 | Touch [Audio Control].



2 | Set each item as follows.



Fader #/Balance

Adjust the volume balance around the touched area.

[◀] and [▶] adjust the right and left volume balance.

[▲] and [▼] adjust the front and rear volume balance.

Volume Offset*

Finely adjust the volume of the current source to minimize the difference in volume between different sources.

Subwoofer Level

Adjusts the subwoofer volume. This setting is not available when subwoofer is set to "None". See [Speaker setup \(P.80\)](#).

Bass Boost **DNX7**

Sets the amount of bass boost among "OFF"/"Step1"/"Step2".

Loudness **DNX5**

Turns the loudness control function on or off. If turned on, high and low tones are automatically enhanced during low volume. Settable only when zone function [\(P.86\)](#) is set to off.

* If you have increased the volume first, then reduced the volume using the "Volume Offset", the sound generated if you suddenly switch to another source may be extremely loud.

Equalizer Control

You can adjust equalizer by selecting the optimized setting for each category.
If you use **DNX7**, you can also adjust equalizer manually.

1 | Touch [Equalizer].

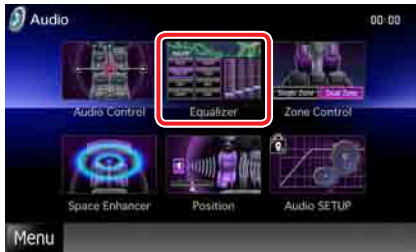

Equalizer screen appears.

DNX7 operation

Controlling EQ curves

- 1 | Select EQ curve from [Natural], [Rock], [Pops], [Easy], [Top40], [Jazz], [Game], [iPod], and [User].



NOTE

- [iPod] is available only during iPod source.

Controlling equalizer manually

This setting cannot be performed when you select [iPod] in the Equalizer screen.

- 1 | Touch [EQ] in the Equalizer screen.
- 2 | Touch the screen and set the Graphic Equalizer as desired.



Gain level (light green boxed area)

Adjust the gain level by touching the each frequency bar.

Touching [◀], [▶], [▲] and [▼] can also adjust the level. Use [◀] and [▶] to select a frequency, and [▲] and [▼] to set the level.

EQ INIT

Returns to the previous level which the gain level is adjusted.

Flat

Tone curve becomes flat.

Bass EXT (Bass Extend Settings)

When turned on, the frequency lower than 62.5 Hz is set to the same gain level as 62.5 Hz.

SW Level

Adjusts the subwoofer volume. This setting is not available when subwoofer is set to "None". See [Speaker setup \(P.80\)](#).

DNX5 operation

Controlling EQ curves

- 1 | Select EQ curve from [Natural], [Rock], [Pops], [Easy], [Top40], [Jazz], and [User] using [◀] and [▶].



Controlling SystemQ-Ex

Selects items to be adjusted for tone curve setup. If you turn off this setting, only Level can be set up for tone curves.

- 1 | Touch [ON] or [OFF] of [SystemQ-Ex].

Controlling equalizer manually

- 1 | Touch [Tone] in the Equalizer screen.
- 2 | Set each item as follows.

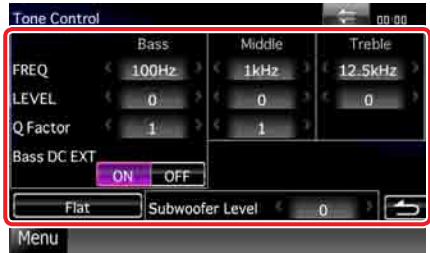

FREQ

Adjusts the center frequency for each range. Setting values are as follows.

Bass: 40Hz/50Hz/60Hz/70Hz/80Hz/100Hz/120 Hz/150Hz (Default is "100Hz")

Middle: 500Hz/1kHz/1.5kHz/2kHz (Default is "1kHz")

Treble: 10kHz/12.5kHz/15kHz/17.5kHz (Default is "12.5kHz")

LEVEL

Adjusts the level of each range.

Each setting value is within -8dB and 8dB and default is "0dB"

Q Factor

Adjust Q value for bass and middle.

Setting values are as follows.

Bass: 1/1.25/1.5/2 (Default is "1.")

Middle: 1/2 (Default is "1.")

Bass DC EXT

Turns Bass DC EXT on or off. Default is "OFF"

If you select "ON", the bass center frequency is extended to the low register by approximately 20%.

[Flat]

Tone level becomes 0 (flat).

Subwoofer Level

Adjusts the subwoofer volume. This setting is not available when subwoofer is set to "None".

See [Speaker setup \(P.80\)](#).

Zone Control

You can select different sources for both front and rear positions in the vehicle.

1 | Touch [Zone Control].



Zone Control screen appears.

2 | Touch [Dual Zone].



3 | Set each source as follows.



[▶] (Front Source, Rear Source)

Select the audio source for each.

[▼], [▲] (Rear VOL.)

Adjusts the rear channel volume.

[Single Zone]

Touch to turn off the dual zone function.

NOTE

- When the rear speaker sound is switched, the audio source that is output at the AV OUTPUT terminal is also switched to the same source.
- When the dual zone function is set to on, the following functions are not available.
 - Output from the subwoofer
 - Subwoofer Level/Bass Boost [DNX7](#) [\(P.83\)](#)
 - Equalizer Control/Space Enhancer [DNX7](#) / Listening Position [DNX7](#) [\(P.84, 86, 87\)](#)
 - DSP Bypass Control [DNX7](#) /Speaker Setup/Car Type (DTA) Setup [DNX7](#) [\(P.83, 80, 82\)](#)

Space Enhancer [DNX7](#)

1 | Touch [Space Enhancer].

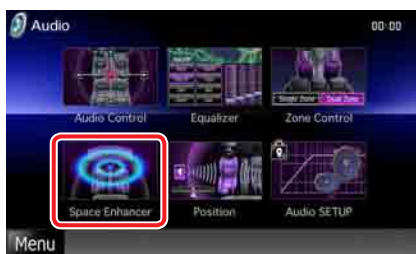

Space Enhancer screen appears.

2 | Touch [Small], [Large], or [OFF].

Each setting value indicates the soundscape level.

NOTE

- This setting is not available during tuner source.

Listening Position **DNX7**

You can adjust the sound effects according to your listening position.

1 | Touch [Position].



Position screen appears.

2 | Select listening position from [Front R] (Right front), [Front L] (Left front), [Front All] (All front), [All], and [User] using [◀] and [▶].



NOTE

- You can store present setting in memory by touching [P1], [P2], or [P3] for 2 seconds. You can also recall the setting by touching corresponding number.
- The final distance is adjusted to the total of car type set up value ([P.82](#)) and position setup (both position and position DTA) value.
- If you change the car type set up value ([P.82](#)), the position is set to [All].
- Only the adjusted distance of position setup (position and position DTA values) is stored in memory. Therefore, the final adjustment distance changes if you change the car type set up value ([P.82](#)).

Position DTA Control

You can fine-adjust your listening position.

1 | In Position screen, touch [DTA].

2 | Select the speaker you wish to adjust by touching speaker icon.



3 | Set DTA as follows.



[◀], [▶]

Adjust the settings of the DTA position.

Total DTA

The adjusted distance (position and position DTA values), and the total of the distance adjusted by [Car type \(DTA\) setup \(P.82\)](#) and the adjustment distance for position setup are indicated.

Remote Controller

This unit can be operated using the remote controller.
The remote controller is supplied with the unit.

⚠ CAUTION

- Put the remote controller in a place where it will not move during braking or other operations. A dangerous situation could result, if the remote controller falls down and gets wedged under the pedals while driving.
- Do not leave the battery near fire or under direct sunlight. A fire, explosion or excessive heat generation may result.
- Do not recharge, short, break up or heat the battery or place it in an open fire. Such actions may cause the battery to leak fluid. If spilled fluid comes in contact with your eyes or on clothing, immediately rinse with water and consult a physician.
- Place the battery out of reach of children. In the unlikely event that a child swallows the battery, immediately consult a physician.

Battery Installation

If the remote controller operates only over shorter distances or does not operate at all, it is possible that the batteries are depleted.

In such instances, replace the both batteries with new ones.

- 1 | Insert two "AAA"/"R03"-size batteries with the ⊕ and ⊖ poles aligned properly, following the illustration inside the case.

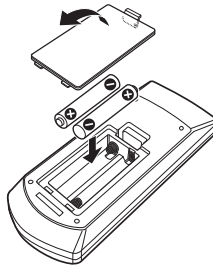

Functions Of The Remote Controller Buttons

Switching the operation mode

The functions operated from the remote controller differ depending on the position of the mode switch.

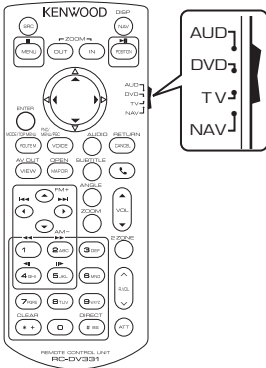

AUD mode

Switch to this mode when controlling a selected source or tuner source, etc.

DVD mode

Switch to this mode when playing a disc media including DVD, VCD, and CD.

TV mode

Switch to this mode when controlling TV.

NAV mode

Switch to this mode when controlling navigation function.

NOTE

- When controlling a player that is not integrated in the unit, select "AUD" mode.

Direct search mode

Using the remote controller, you can jump directly to the desired file, track chapter, etc. with entering the number corresponding to the content.

NOTE

- This operation cannot be performed for USB device and iPod.

1 | Press the <#BS> button several times until the desired content appears.

The available contents are different depending on the source.

DVD

Title number/Chapter number/Play time/Item number*

* You may not be able to use this function with some discs or scenes.

VCD 1.X and 2.X (PBC OFF)

Track number

VCD 2.X (PBC ON)

Scene number/number

Music CD

Track number/Play time

Audio files

Folder number/File number

Radio

Frequency value



2 | Enter the number of the content you want to play using the numeric keypad.

3 | For DVD or VCD, press the <Enter> button. For music CD or audio files, press the <POSITION> button. For radio, press the <◀> or <▶> button.

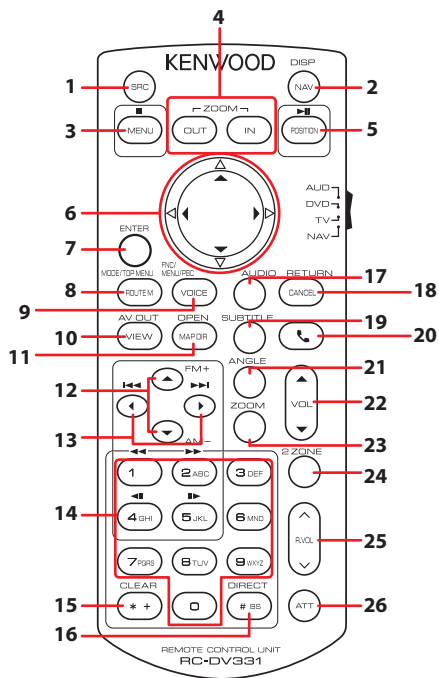
The content you entered is played.



	Key Name	Location of the mode switch	Function
1	SRC	—	Switches to the source to be played. In hands-free mode, hangs up the phone.
2	NAV	—	Switches between the navigation and the source screens.
3	MENU	DVD	Stops playing and memorizes the last point where the disc stopped. The last point is deleted by pressing twice.
		NAV	Displays Main menu.
4	OUT, IN	NAV	Zooms in or out the navigation map.
5	POSITION	AUD, DVD	Pauses the track or file, and resumes playing by pressing twice. During radio source in AUD mode, switches the seek mode (AUTO1, AUTO2, MANUAL).
		TV	Switches the seek mode (AUTO1, AUTO2, MANUAL).
		NAV	Displays the current position.
6	Cursor Key	DVD	Moves the cursor in the DVD menu.
		NAV	Moves the cursor or scrolls the map.
7	ENTER	AUD, DVD, TV	Performs the selected function.
		NAV	<ul style="list-style-type: none"> Registers the selected position. Performs the selected function.
8	ROUTE M	AUD, TV	Screen mode changes each time you press this key during video playback.
		DVD	Returns to the DVD top menu.
		NAV	Displays Route Option menu.

	Key Name	Location of the mode switch	Function
9	VOICE	AUD, TV	Switches navigation display on/off.
		DVD	Displays the DVD menu. Turns the playback control on or off while playing VCD.
		NAV	Speaks the voice guidance.
10	VIEW	AUD, DVD, TV	Switches the AV source to be output.
		NAV	Switches between 2D and 3D map displays.
11	MAP DIR	AUD, DVD, TV	DNX7 Switches the display angle each time it is pressed.
		NAV	Switches between the heading up navigation and north up navigation map displays.
12	▲/▼	AUD, DVD	Selects the folder to be played. During radio source in AUD mode, switches the bands to be received.
		TV	Switches between the station of the TV band to be received.
13	◀/▶	AUD, DVD	Selects the track or file to be played. During radio source in AUD mode, switches to broadcast stations received by the unit.
		TV	Selects the channel to be received.
14	Numeric Keypad	AUD	Specifies the number to search in direct search. For details on the direct search mode, see Direct search mode (P.89) . During radio source, this key functions same as in TV mode.
		DVD	<ul style="list-style-type: none"> • Press [1] [2] to fast forward/backward. Switches the fast forward/backward speed each time you press this key. • Press [4] [5] to slow forward/backward. Switches the slow playback speed each time you press this key.* *DVD only
		TV	Press the number of the memorized station to tune in ([1] - [6]).
15	* +	DVD	Clears the number.
16	# BS	AUD, DVD, TV	Switches to the direct search mode. For details on the direct search mode, see Direct search mode (P.89) .
17	AUDIO	DVD	Switches the voice language each time you press this key.
18	CANCEL	DVD	Displays previous screen.
		NAV	Cancels the operations.
19	SUBTITLE	DVD	Switches the subtitle language.
20		–	When a call comes in, answers the call.
21	ANGLE	DVD	Switches the picture angle each time you press this key.
22	Vol ▲▼	–	Adjusts the volume.
23	ZOOM	DVD	Switches the zoom ratio (1, 2, 3, Off) each time you press this key.
24	2 ZONE	AUD, DVD, TV	Switches the Dual Zone function on and off.
25	R.VOL 	–	Adjusts volume at rear when the Dual Zone function is on.
26	ATT	–	Lowers the volume by pressing the key once.
		–	Restores the previous volume by pressing the key twice.

Troubleshooting

Problems And Solutions

If any trouble occurs, first check the following table for possible problems.

- Some functions of this unit may be disabled by some settings made on this unit.
- What might seem to be a malfunction in your unit may just be the result of slight misoperation or miswiring.

About settings

Problem	Reason	Solution
<ul style="list-style-type: none"> • Cannot set up the subwoofer. • Cannot set up subwoofer phase. • No output from the subwoofer. • Cannot set up the low pass filter. • Cannot set up the high pass filter. 	Subwoofer is not set to on.	Set the subwoofer to on. See Speaker setup (P.80) .
	The dual zone function is enabled.	Set the dual zone function to off. See Zone Control (P.86) .
<ul style="list-style-type: none"> • Cannot select the output destination of the subsource in the dual zone. • Cannot adjust the volume of the rear speakers. 	The dual zone function is disabled.	Set the dual zone function to on. See Zone Control (P.86) .
	The dual zone function is enabled.	Set the dual zone function to off. See Zone Control (P.86) .
<ul style="list-style-type: none"> • Cannot set up the equalizer. • Cannot set up the crossover network. 	The dual zone function is enabled.	Set the dual zone function to off. See Zone Control (P.86) .
	"DSP Select" is set to "Bypass".	Set "DSP Select" to "Through". See DSP select (P.83) .

About audio operations

Problem	Reason	Solution
Radio reception is poor.	The car antenna is not extended.	Pull out the antenna all the way.
	The antenna control wire is not connected.	Connect the wire correctly. See "Connection" in the Quick Start Guide.
Cannot play audio files stored in a disc.	"CD Read" is set to "2".	Set "CD Read" to "1". See Disc setup (P.29) .
Cannot select a folder.	The random play function is enabled.	Turn off the random function.
Cannot perform repeat play during VCD playback.	The PBC function is enabled.	Turn off the PBC function.
The specified disc does not play, but another one plays instead.	The disc is quite dirty.	Clean the disc. See Precautions on handling discs (P.4) .
	The disc is severely scratched.	Try another disc instead.
The sound skips when an audio file is being played.	The disc is scratched or dirty.	Clean the disc. See Precautions on handling discs (P.4) .
	The recording condition is bad.	Record the file again or use another disc.

Other

Problem	Reason	Solution
The Touch Sensor Tone doesn't sound.	The preout jack is being used.	The Touch Sensor Tone cannot be output from the preout jack.

Error Messages

When you fail to operate the unit correctly, the cause of the failure appears as the message on the screen.

Error Message	Cause	Solution
Protect	Protective circuit has been activated because a speaker cord has shorted or it has come in contact with the car chassis.	Wire or insulate the speaker cord as appropriate and then push the <Reset> button (P.94).
Hot Error	When the internal temperature of this unit rises to 60°C or more, the protection circuit is activated and you may not be able to operate the unit.	Use the unit again after reducing the temperature of the unit.
Mecha Error	The disc player is malfunctioning.	Eject the disc and try inserting it again. Contact the Kenwood dealer if this indicator continues blinking or the disc cannot be ejected.
Disc Error	An unplayable disc is inserted.	Change the disc. See Playable Media And Files (P.95) .
Read Error	The disc is quite dirty.	Clean the disc. See Precautions on handling discs (P.4) .
	Disc is upside down.	Load the disc with the labeled side up.
Region Code Error	The disc you wanted to play has a region code that cannot be played with this unit.	See Region Codes In The World (P.100) or try another disc.
Parental Level Error	The disc you wanted to play has a higher level than the parental level you set.	Set the parental level. See Parental level (P.28) .
Error 07–67	The unit is not operating correctly due to some reason or other.	Push the unit's Reset button. If the "Error 07–67" message does not disappear, see your nearest Kenwood dealer.
No Device (USB device)	The USB device is selected as a source although no USB device is connected.	Change the source to any source other than USB/iPod. Connect a USB device, and change the source to USB again.
Disconnected (iPod, Bluetooth audio player)	The iPod/Bluetooth audio player is selected as a source although no iPod/Bluetooth audio player is connected.	Change the source to any source other than iPod/Bluetooth. Connect an iPod/Bluetooth audio player, and change the source to iPod/Bluetooth again.
No Media file	The connected USB device contains no playable audio file. Media was played that doesn't have data recorded that the unit can play.	See Playable Media And Files (P.95) and try another USB device.

Error Message	Cause	Solution
USB Device Error!!	The connected USB device is rated a current capacity higher than the allowable limit.	Check the USB device. Some trouble may have occurred to the connected USB device. Change the source to any source other than USB. Remove the USB device.
Authorization Error	Connection to the iPod has failed.	<ul style="list-style-type: none"> Remove the iPod and then reconnect it. The unit does not support the iPod. See Connectable iPod/iPhone (P.97).
Update your iPod	The iPod's software is an older version which the unit can not support.	The unit may not support the connected iPod model. Confirm that the software for the iPod is the latest version. See Connectable iPod/iPhone (P.97) .
Navigation Error. Please turn on power again later.	The communication error has occurred due to severely cold temperature.	Turn on power again after warming your car interior.

Resetting The Unit

If the unit or the connected unit fails to operate properly, reset the unit.

1 | Press the <Reset> button.

The unit returns to factory settings.

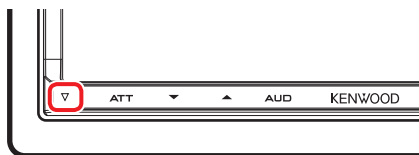

DNX7

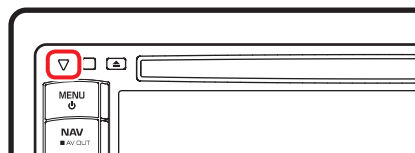

DNX5

NOTE

- Disconnect the USB device before pressing the <Reset> button. Pressing the <Reset> button with the USB device connected can damage the data stored in the USB device. For how to disconnect the USB device, see [How To Play Media \(P.13\)](#).
- When the unit is turned on after resetting, the Initial SETUP screen appears. See [Initial setup \(P.11\)](#).

Appendix

Playable Media And Files

You can play various kinds of media and files on this unit.

List of playable discs

Disc types	Standard	Support	Remark
DVD	DVD Video	○	
	DVD Audio	×	
	DVD-VR	×	
	DVD-R*	○	<ul style="list-style-type: none"> • MP3/WMA/AAC/MPEG1/MPEG2/DivX playback • Multi-border/Multisession playback (Playback depends on authoring conditions)
	DVD-RW	○	
	DVD+R	○	
	DVD+RW	○	
	DVD-R DL (Dual layer)	○	Only video format
	DVD+R DL (Double layer)	○	
DVD-RAM	×		
CD	Music CD*	○	CD-TEXT
	CD-ROM	○	<ul style="list-style-type: none"> • MP3/WMA/AAC/MPEG1/MPEG2/DivX playback • Multisession is supported. • Packet write is not supported.
	CD-R	○	
	CD-RW	○	
	DTS-CD	○	
	Video CD (VCD)	○	
	Super video CD	×	
	Photo CD	×	
	CD-EXTRA	△	Only music CD session can be played.
	HDCD	○	
CCCD	×		
Others	Dualdisc	×	
	Super audio CD	△	Only CD layer can be played.

* Incompatible with 8 cm (3 inch) discs.

○ : Playback is possible.

△ : Playback is partly possible.

×

 : Playback is impossible.

NOTE

- When buying DRM enabled contents, check the Registration Code in the [DivX setup \(P.43\)](#). Each time a file with the displayed code is played and protected against copying, the code changes.
- DivX can be played only from a DVD disc media.

■ Use of DualDisc

When playing a "DualDisc" on this unit, the surface of the disc that is not played may be scratched while the disc is inserted or ejected. Since the music CD surface does not conform to the CD standard, playback may be impossible.

(A "DualDisc" is a disc with one surface containing DVD standard signals and the other surface containing music CD signals.)

■ About disc format

The disc format should be the one of the following.

- ISO 9660 Level 1/2
- Joliet
- Romeo
- Long file name

About files

The following audio, video, and picture files are supported.

■ Audio files

- AAC-LC (.m4a)
- MP3 (.mp3)
- WMA (.wma)
- Linear PCM (WAVE) (.wav)
*Mass-storage-class USB device only

NOTE

- If music of normal CD and other playback systems are recorded in the same disc, only the playback system recorded at the first setout is played.
- WMA and AAC of which is covered with DRM cannot be played.
- Although the audio files are complied with the standards listed above, the play may be impossible depending on the types or conditions of media or device.
- An online manual about audio files is put on the site, www.kenwood.com/cs/ce/audiofile/. On this online manual, detailed information and notes which are not written in this manual are provided. Make sure to read through the online manual as well.

■ Video files

- MPEG1 (.mpg, .mpeg, .m1v)
- MPEG2 (.mpg, .mpeg, .m2v)
- DivX (.divx, .div, .avi)
- H.264/MPEG-4 AVC (.mp4, .m4v)
*Mass-storage-class USB device only
- WMV 9 (.wmv, .m2ts)
*Mass-storage-class USB device only

■ Picture files

Only picture files in USB device can be displayed. Files stored in disc media is not supported.

- JPEG (.jpg, .jpeg)
- PNG (.png)
- BMP (.bmp)

NOTE

- BMP and PNG can be set only as wallpaper.

■ Playing order of files

In the example of folder/file tree shown below, the files are played in the order from 1 to 10.

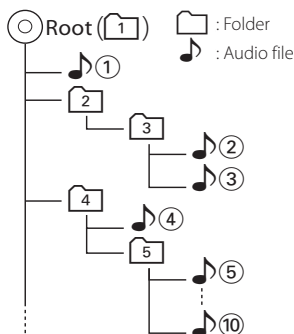

Connectable iPod/iPhone

The following models can be connected to this unit.

You can control an iPod/iPhone from this unit by connecting an iPod/iPhone (commercial product) with Dock connector using an optional accessory iPod connection cable (KCA-iP202/KCA-iP22F). The word “iPod” appearing in this manual indicates the iPod/iPhone connected with the KCA-iP202/KCA-iP22F (optional accessory).

Made for

- iPod nano (6th generation)
- iPod nano (5th generation)
- iPod nano (4th generation)
- iPod nano (3rd generation)
- iPod nano (2nd generation)
- iPod nano (1st generation)
- iPod with video
- iPod classic
- iPod touch (4th generation)
- iPod touch (3rd generation)
- iPod touch (2nd generation)
- iPod touch (1st generation)
- iPhone 4
- iPhone 3GS
- iPhone 3G
- iPhone

NOTE

- For the conformity information on iPod/iPhone software, access www.kenwood.com/cs/ce/ipod/.
- By connecting your iPod/iPhone to this unit with an optional accessory iPod connection cable (KCA-iP202/KCA-iP22F), you can supply power to your iPod/iPhone as well as charge it while playing music. However, the power of this unit must be on.
- If you start playback after connecting the iPod, the music that has been played by the iPod is played first.
In this case, “Reading” is displayed without displaying a folder name, etc. Changing the browse item will display a correct title, etc.
- When the iPod is connected to this unit, “KENWOOD” or “✓” is displayed on the iPod to indicate that you cannot operate the iPod.

Usable USB device

You can use a mass-storage-class USB device on this unit.

The word “USB device” appearing in this manual indicates a flash memory device and digital audio players can be recognized as mass-storage.

■ About file system

The file system should be the one of the following.

- FAT16
- FAT32

NOTE

- When the USB device is connected to this unit, it can be charged through the USB cable.
- Install the USB device in the place where it will not affect safe driving.
- You cannot connect a USB device via a USB hub and Multi Card Reader.
- Take backups of the audio files used with this unit. The files can be erased depending on the operating conditions of the USB device. We shall have no compensation for any damage arising from any erased data.
- No USB device comes with this unit. You need to purchase a commercially available USB device.
- When connecting the USB device, usage of the CA-U1EX (option) is recommended. (However, maximum supply current of CA-U1EX is 500mA.) Normal playback is not guaranteed when a cable other than the USB compatible cable is used.

Status Bar Indicator Items

Shown below is a list of indicators displayed on the status bar in the screen.
Current status of this unit is displayed on the bar.



Status bar

■ General

ATT

The attenuator is active.

DUAL

The dual zone function is on.

TEL

Indicates the connection state of the Bluetooth hands-free unit.

- White: Connected
- Orange: Not connected

LOUD DNX5

The loudness control function is on.

■ DVD/CD

FO-REP

Folder repeat function is on.

IN

A disc is inserted.

- White: A Disc is inside the unit.
- Orange: Error at the disc player

VIDEO

Identifies the video file.

MUSIC

Identifies the music file.

RDM

The random function is on.

REP

The repeat function is on.

C-REP

The chapter repeat function is on.

T-REP

The title repeat function is on.

■ VCD

1chLL/2chLL

Identifies the left audio output of channel 1 or 2.

1chLR/2chLR

Identifies the monaural audio output of channel 1 or 2.

1chRR/2chRR

Identifies the right audio output of channel 1 or 2.

1chST/2chST

Identifies the stereo audio output of channel 1 or 2.

LL

Identifies the left audio output.

LR

Identifies the monaural audio output.

RR

Identifies the right audio output.

STEREO

Identifies the stereo audio output.

PBC

The PBC function is on.

SVCD

Identifies the Super Video CD.

VER1

The VCD version is 1.

VER2

The VCD version is 2.

REP

The repeat function is on.

■ USB

FO-REP

The folder repeat function is on.

VIDEO

Identifies the video file.

MUSIC

Identifies the music file.

PICTURE

Identifies the picture file.

RDM

The random function is on.

REP

The repeat function is on.

PLST

The play list mode is selected now.

■ iPod

MUSIC

Identifies the music file.

VIDEO

Identifies the video file.

RDM

The random function is on.

A-RDM

The album random function is on.

REP

The repeat function is on.

■ Tuner

AUTO1

Seek mode is set to AUTO1.

AUTO2

Seek mode is set to AUTO2.

MONO

The forced monaural function is on.

EON*1

The Radio Data System station is sending EON.

AF*1

The AF search function is on.

LO.S*1

The Local Seek function is on.

NEWS*1

News bulletin interruption is in progress.

RDS*1

Indicates the state of the Radio Data System station when the AF function is on.

- White: Radio Data System is being received.
- Orange: Radio Data System is not being received.

MANUAL

Seek mode is set to MANUAL.

ST

A stereo broadcast is being received.

TI*1

Indicates the reception state of traffic information.

- White: TP is being received.
- Orange: TP is not being received.

CRSC*2

The CRSC ([P.45](#)) function is on.

***1 Models with region code 2 or 3 only**

***2 Models with region code 4 or 6 only**

■ TV

AUTO1

Seek mode is set to AUTO1.

AUTO2

Seek mode is set to AUTO2.

MANUAL

Seek mode is set to MANUAL.

Region Codes In The World

The DVD players are given a region code according to the country or area it is marketed, as shown in the following map.

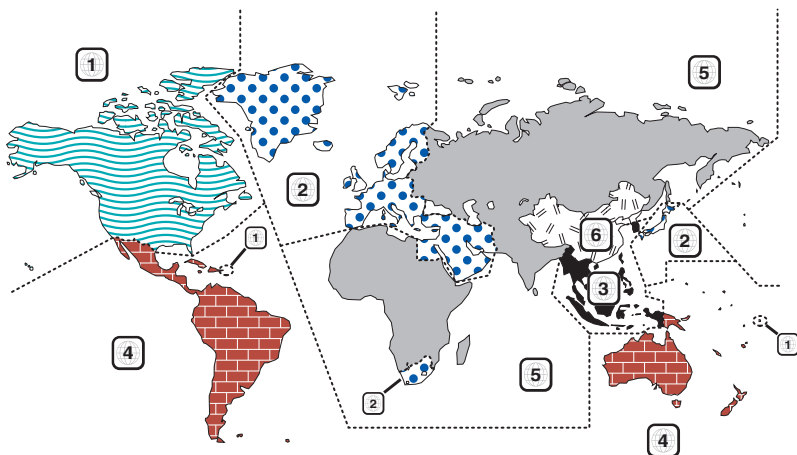

■ DVD disc marks



Indicates a region number. The discs with this mark can be played with any DVD player.



Indicates the number of audio languages recorded. Up to 8 languages can be recorded in a movie. You can select a favorite language.



Indicates the number of subtitled languages recorded. Up to 32 languages can be recorded.



If a DVD disc has scenes shot from multiple angles, you can select a favorite angle.

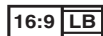

Indicates the type of screen for the image. The left mark indicates that a wide image picture (16:9) is displayed on a standard TV set screen (4:3) with a black band at both the top and bottom of the screen (letter box).

■ Operation regulatory marks

With this DVD, some functions of this unit such as the play function may be restricted depending on the location where the DVD is playing. In this case, the following marks will appear on the screen. For more information, refer to the disc manual.



■ Discs with limited period of use

Do not leave discs with a limited period of use in this unit. If you load an already expired disc, you may not be able to remove it from this unit.

DVD Language Codes

Code	Language
aa	Afar
ab	Abkhazian
af	Afrikaans
am	Amharic
ar	Arabic
as	Assamese
ay	Aymara
az	Azerbaijani
ba	Bashkir
be	Byelorussian
bg	Bulgarian
bh	Bihari
bi	Bislama
bn	Bengali, Bangla
bo	Tibetan
br	Breton
ca	Catalan
co	Corsican
cs	Czech
cy	Welsh
da	Danish
de	German
dz	Bhutani
el	Greek
en	English
eo	Esperanto
es	Spanish
et	Estonian
eu	Basque
fa	Persian
fi	Finnish
fj	Fiji
fo	Faroese
fr	French
fy	Frisian
ga	Irish
gd	Scots Gaelic
gl	Galician
gn	Guarani
gu	Gujarati
ha	Hausa
he	Hebrew
hi	Hindi
hr	Croatian
hu	Hungarian
hy	Armenian

Code	Language
ia	Interlingua
ie	Interlingue
ik	Inupiak
id	Indonesian
is	Icelandic
it	Italian
ja	Japanese
jav	Javanese
ka	Georgian
kk	Kazakh
kl	Greenlandic
km	Cambodian
kn	Kannada
ko	Korean
ks	Kashmiri
ku	Kurdish
ky	Kirghiz
la	Latin
lb	Luxembourgish
ln	Lingala
lo	Laotian
lt	Lithuanian
lv	Latvian, Lettish
mg	Malagasy
mi	Maori
mk	Macedonian
ml	Malayalam
mn	Mongolian
mo	Moldavian
mr	Marathi
ms	Malay
mt	Maltese
my	Burmese
na	Nauru
ne	Nepali
nl	Dutch
no	Norwegian
oc	Occitan
om	(Afan) Oromo
or	Oriya
pa	Punjabi
pl	Polish
ps	Pashto, Pushto
pt	Portuguese
qu	Quechua
rm	Rhaeto-Romance

Code	Language
rn	Kirundi
ro	Romanian
ru	Russian
rw	Kinyarwanda
sa	Sanskrit
sd	Sindhi
sg	Sangho
sh	Serbo-Croatian
si	Singhalese
sk	Slovak
sl	Slovenian
sm	Samoaan
sn	Shona
so	Somali
sq	Albanian
sr	Serbian
ss	Siswati
st	Sesotho
su	Sundanese
sv	Swedish
sw	Swahili
ta	Tamil
te	Telugu
tg	Tajik
th	Thai
ti	Tigrinya
tk	Turkmen
tl	Tagalog
tn	Setswana
to	Tongan
tr	Turkish
ts	Tsonga
tt	Tatar
tw	Twí
uk	Ukrainian
ur	Urdu
uz	Uzbek
vi	Vietnamese
vo	Volapuk
wo	Wolof
xh	Xhosa
yo	Yoruba
zh	Chinese
zu	Zulu

Specifications

■ Monitor section

Picture Size

DNX7380BT, DNX7380BTM
: 6.95 inches (diagonal) wide
: 156.6 mm (W) x 81.6 mm (H)
DNX5380BT, DNX5380, DNX5380M
: 6.1 inches (diagonal) wide
: 136.2 mm (W) x 72 mm (H)

Display System

: Transparent TN LCD panel

Drive System

: TFT active matrix system

Number of Pixels

: 1,152,000 (800H x 480V x RGB)

Effective Pixels

: 99.99 %

Pixel Arrangement

: RGB striped arrangement

Back Lighting

: LED

■ DVD player section

D/A Converter

: 24 bit

Audio Decoder

: Linear PCM/Dolby Digital/dts/MP3/WMA/AAC

Video Decoder

: MPEG1/ MPEG2/DivX

Wow & Flutter

: Below Measurable Limit

Frequency Response

DNX7380BT, DNX7380BTM

Sampling frequency;

- 96 kHz : 20 – 20,000 Hz
- 48 kHz : 20 – 20,000 Hz
- 44.1 kHz : 20 – 20,000 Hz

DNX5380BT, DNX5380, DNX5380M

Sampling frequency;

- 96 kHz : 20 – 22,000 Hz
- 48 kHz : 20 – 22,000 Hz
- 44.1 kHz : 20 – 20,000 Hz

Total Harmonic Distortion

DNX7380BT, DNX7380BTM

: 0.008 % (1 kHz)

DNX5380BT, DNX5380, DNX5380M

: 0.010 % (1 kHz)

S/N Ratio (dB)

: 98 dB (DVD-Video 96 kHz)

Dynamic Range

: 98 dB (DVD-Video 96 kHz)

Disc Format

: DVD-Video/ VIDEO-CD/ CD-DA

Sampling Frequency

: 44.1/48/96 kHz

Quantifying Bit Number

: 16/20/24 bit

■ USB interface section

USB Standard

DNX7380BT, DNX7380BTM

: USB 2.0 High speed

DNX5380BT/ DNX5380/ DNX5380M

: USB 2.0 Full speed

File System

: FAT 16/ 32

Maximum Power Supply Current

: 1A (5V)

D/A Converter

: 24 Bit

Video Decoder

: MPEG1/MPEG2/MPEG4/WMV/H.264

Audio Decoder

: MP3/WMA/ AAC/WAV (Linear PCM)

■ Bluetooth section

Technology

DNX7380BT, DNX7380BTM

: Bluetooth Ver.2.1 + EDR Certified

DNX5380BT

: Bluetooth 2.1 Certified

Frequency

: 2.402 – 2.480 GHz

Output Power

: +4dBm (MAX), 0dBm (AVE), Power Class2

Maximum Communication Range

: Line of sight approx. 10m (32.8 ft)

Profile

- HFP (Hands Free Profile)
 - SPP (Serial Port Profile)
 - HSP (Headset Profile)
 - OPP (Object Push Profile)
 - PBAP (Phonebook Access Profile)
 - SYNC (Synchronization Profile)
 - A2DP* (Advanced Audio Distribution Profile)
 - AVRCP* (Audio/Video Remote Control Profile)
 - Multi Profile support
- *DNX7380BT, DNX7380BTM only

■ FM tuner section

Frequency Range

DNX7380BT, DNX7380BTM, DNX5380, DNX5380M
: 87.5 MHz – 108.0 MHz (50 kHz)
DNX7380BT, DNX5380BT, DNX5380 (Region code 6)
: 87.5 MHz - 108.0 MHz (50 kHz)
: 87.9 MHz - 107.9 MHz (200 kHz)

Usable Sensitivity (S/N : 26 dB)

DNX7380BT, DNX7380BTM
: 9.3 dBf (0.7 μ V/75 Ω)
DNX5380 (Region code 6)
: 9.3 dBf (0.7 μ V/75 Ω)
DNX5380BT, DNX5380 (Region code 3), DNX5380M
: 9.3 dBf (0.8 μ V/75 Ω)

Quieting Sensitivity (S/N : 46 dB)

: 15.2 dBf (1.6 μ V/75 Ω)

Frequency Response (\pm 3.0 dB)

: 30 Hz – 15 kHz

S/N Ratio (dB)

DNX5380 (Region code 6)
: 65 dB (MONO)
DNX7380BT, DNX7380BTM, DNX5380BT, DNX5380
(Region code 3), DNX5380M
: 70 dB (MONO)

Selectivity (\pm 400 kHz)

: \geq 80 dB

Stereo Separation

DNX7380BT, DNX7380BTM, DNX5380 (Region code 6)
: 35 dB (1 kHz)
DNX5380BT, DNX5380 (Region code 3), DNX5380M
: 40 dB (1 kHz)

■ AM tuner section

Frequency Range

DNX7380BT, DNX7380BTM, DNX5380 (Region code 3),
DNX5380M
LW : 153 – 279 kHz (9 kHz)
MW : 531 – 1611 kHz (9 kHz)
DNX5380BT, DNX5380 (Region code 6)
: 531 kHz - 1611 kHz (9 kHz)
: 530 kHz - 1700 kHz (10 kHz)

Usable Sensitivity

DNX7380BT, DNX7380BTM, DNX5380 (Region code 3),
DNX5380M
LW : 45 μ
MW : 25 μ
DNX5380BT, DNX5380 (Region code 6)
: 28dB μ

■ Video section

Color System of External Video Input

: NTSC/PAL

External Video Input Level (RCA/mini jack)

: 1 Vp-p/ 75 Ω

External Audio Max Input Level (RCA/mini jack)

: 2 V/ 25 k Ω

Video Output Level (RCA jacks)

: 1 Vp-p/ 75 Ω

Audio Output Level (RCA jacks)

: 1.2 V/ 10 k Ω

■ Audio section

Maximum Power (Front & Rear)

: 50 W x 4

Full Bandwidth Power (Front & Rear) (at less than 1% THD)

: 22 W x 4

Preout Level (V)

DNX7380BT, DNX7380BTM
: 4 V/ 10 k Ω
DNX5380BT, DNX5380, DNX5380M
: 2 V/ 10 k Ω

Preout Impedance

: \leq 600 Ω

Speaker Impedance

: 4 – 8 Ω

Tone (DNX5380BT, DNX5380, DNX5380M)

Bass: 100Hz \pm 10dB
Middle: 1kHz \pm 10dB
Treble: 10kHz \pm 10dB

■ DSP section (DNX7380BT, DNX7380BTM)

Graphics equalizer

Band: 5 Band
Frequency (BAND1 – 5)
: 62.5/250/1k/4k/16kHz

Gain

: -9/-8/-7/-6/-5/-4/-3/-2/-1/0/1/2/3/4/5/6/7/8/9 dB

X'over

High pass filter

Frequency: Through, 30/40/50/60/70/80/90/100/120
/150/180/ 220/ 250 Hz
Slope: -6/-12/-18/-24 dB/Oct.

Low pass filter

Frequency: 30/40/50/60/70/80/90/100/120/150/180
/220/250 Hz, Through
Slope: -6/-12/-18/-24 dB/Oct.

Time alignment

Front/ Rear/ Subwoofer
: 0 – 4.4 m (0.02 m Step)

Position

: 0 – 1.7 m (0.02 m Step)

Subwoofer level

: -50 – +10 dB

■ **Navigation section**

Receiver

: High-sensitivity GPS receiver

Reception Frequency

: 1575.42 MHz (C/A code)

Acquisition Times

Cold : 38 seconds (typ)

(On average for a stationary receiver with a clear view of the sky)

Accuracy

Position : < 10 meters, typical

Velocity : 0.05 m/sec. RMS

Position Method

: GPS

Antenna

: External GPS antenna

■ **External SW (DNX7380BT, DNX7380BTM)**

Maximum Power Supply Current

: 500 mA

■ **General**

Operating Voltage

: 14.4 V (10.5 – 16 V allowable)

Maximum Current Consumption

: 15 A

Installation Dimensions (W x H x D)

DNX7380BT, DNX7380BTM

: 182.0 x 112.0 x 163.0 mm

DNX5380BT, DNX5380, DNX5380M

: 178.0 x 100.0 x 156.3 mm

Operational Temperature Range

: -10 °C – +60 °C

Storage Temperature Range

: -20 °C – +85 °C

Weight

DNX7380BT, DNX7380BTM: 2.7 kg

DNX5380BT, DNX5380, DNX5380M: 2.2 kg

NOTE

- Although the effective pixels for the liquid crystal panel is given as 99.99% or more, 0.01% of pixels may not light or may light incorrectly.

Specifications subject to change without notice.

About This Unit

■ **Copyrights**

- The Bluetooth word mark and logos are owned by the Bluetooth SIG, Inc. and any use of such marks by Kenwood Corporation is under license. Other trademarks and trade names are those of their respective owners.
- The "AAC" logo is a trademark of Dolby Laboratories.
- "Made for iPod" and "Made for iPhone" mean that an electronic accessory has been designed to connect specifically to iPod or iPhone, respectively, and has been certified by the developer to meet Apple performance standards. Apple is not responsible for the operation of this device or its compliance with safety and regulatory standards. Please note that the use of this accessory with iPod, iPhone, or iPad may affect wireless performance.
- iPhone, iPod, iPod classic, iPod nano, and iPod touch are trademarks of Apple Inc., registered in the U.S. and other countries.



-  is a trademark of DVD Format/Logo Licensing Corporation registered in the U.S., Japan and other countries.

- This item incorporates copy protection technology that is protected by U.S. patents and other intellectual property rights of Rovi Corporation. Reverse engineering and disassembly are prohibited.
- Manufactured under license from Dolby Laboratories. Dolby and the double-D symbol are trademarks of Dolby Laboratories.
- Manufactured under license under U.S. Patent #'s: 5,451,942; 5,956,674; 5,974,380; 5,978,762; 6,487,535 & other U.S. and worldwide patents issued & pending. DTS and the Symbol are registered trademarks & DTS 2.0 Channel and the DTS logos are trademarks of DTS, Inc. Product includes software. © DTS, Inc. All Rights Reserved.
- Font for this product is designed by Ricoh.
- **ABOUT DIVX VIDEO:**
DivX® is a digital video format created by DivX, Inc. This is an official DivX Certified® device that plays DivX video. Visit divx.com for more information and software tools to convert your files into DivX video.

- **ABOUT DIVX VIDEO-ON-DEMAND:**
This DivX Certified® device must be registered in order to play purchased DivX Video-on-Demand (VOD) movies. To obtain your registration code, locate the DivX VOD section in your device setup menu. Go to vod.divx.com for more information on how to complete your registration.
- DivX®, DivX Certified® and associated logos are registered trademarks of DivX, Inc. and are used under license.

■ The marking of products using lasers



The label is attached to the chassis/case and says that the component uses laser beams that have been classified as Class 1. It means that the unit is utilizing laser beams that are of a weaker class. There is no danger of hazardous radiation outside the unit.

For Turkey

Bu ürün 26891 sayılı Resmi Gazete’de yayımlanan Elektrikli ve Elektronik Eşyalarda Bazı Zararlı Maddelerin Kullanımının Sınırlandırılmasına Dair Yönetmeliğe uygun olarak üretilmiştir.

This product complies with Directive, Number 26891 regarding “REGULATION ON THE RESTRICTION OF THE USE OF CERTAIN HAZARDOUS SUBSTANCES IN ELECTRICAL AND ELECTRONIC EQUIPMENT”.

DNX7380BTM, DNX5380M:



Declaration of Conformity with regard to the EMC Directive 2004/108/EC

Declaration of Conformity with regard to the R&TTE Directive 1999/5/EC

Manufacturer:

Kenwood Corporation
2967-3 Ishikawa-machi, Hachioji-shi, Tokyo, 192-8525
Japan

EU Representative’s:

Kenwood Electronics Europe BV
Amsterdamsesweg 37, 1422 AC UITHOORN, The
Netherlands

English

Hereby, Kenwood declares that this unit DNX7380BTM, DNX5380M is in compliance with the essential requirements and other relevant provisions of Directive 1999/5/EC.

Türk

Kenwood, işbu belge ile DNX7380BTM, DNX5380M numaralı bu ünitenin 1999/5/EC Direktifi’nin özel gereksinimlerine ve ilgili diğer hükümlerine uygun olduğunu beyan eder.

KENWOOD

Free Manuals Download Website

<http://myh66.com>

<http://usermanuals.us>

<http://www.somanuals.com>

<http://www.4manuals.cc>

<http://www.manual-lib.com>

<http://www.404manual.com>

<http://www.luxmanual.com>

<http://aubethermostatmanual.com>

Golf course search by state

<http://golfingnear.com>

Email search by domain

<http://emailbydomain.com>

Auto manuals search

<http://auto.somanuals.com>

TV manuals search

<http://tv.somanuals.com>