

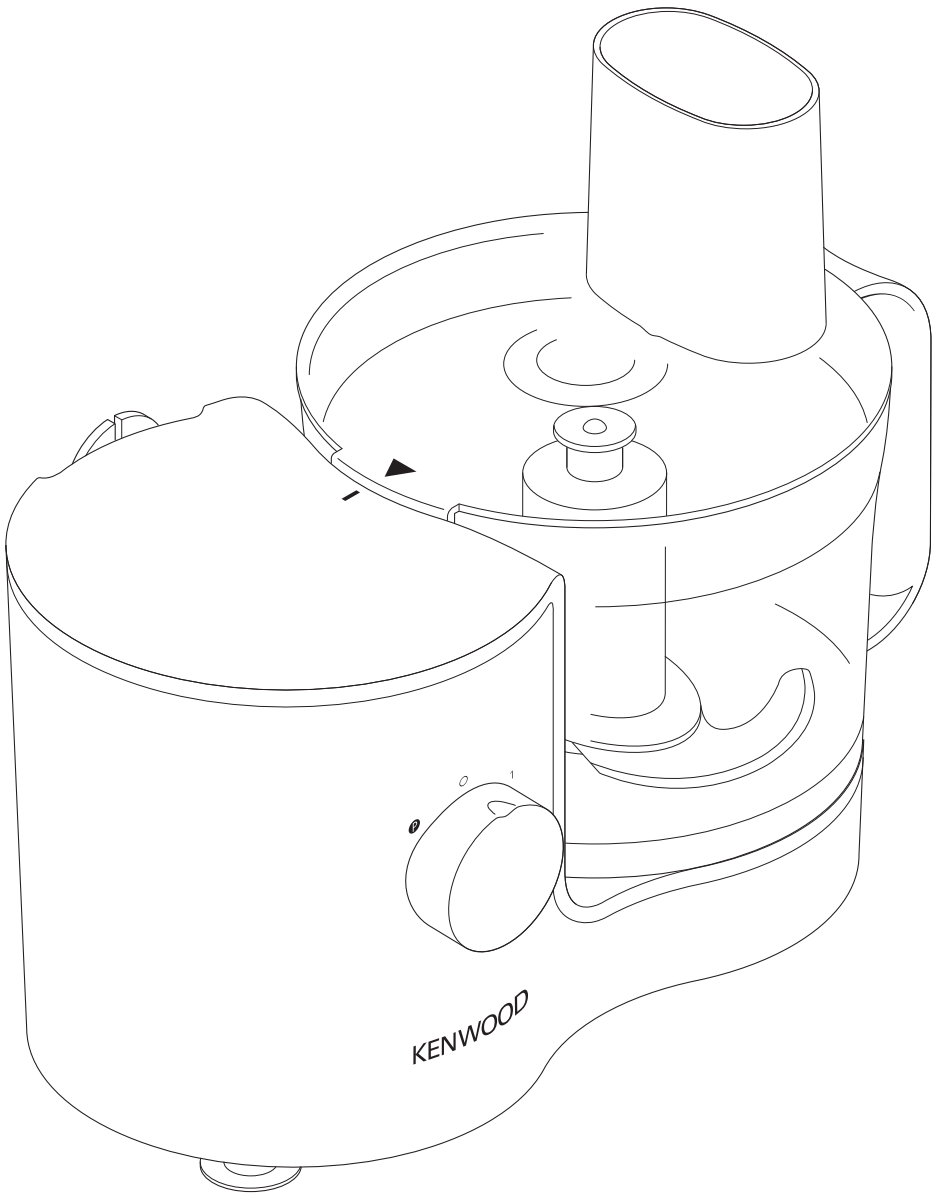

Head Office Address:
Kenwood Limited, New Lane, Havant, Hampshire PO9 2NH, UK
www.kenwoodworld.com
Designed and engineered by Kenwood in the UK
Made in China

KENWOOD



FP120 series

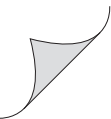

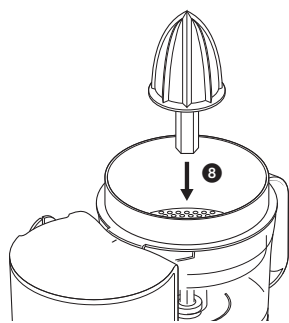
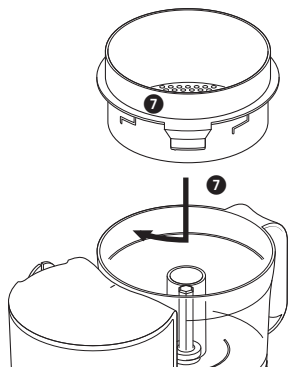
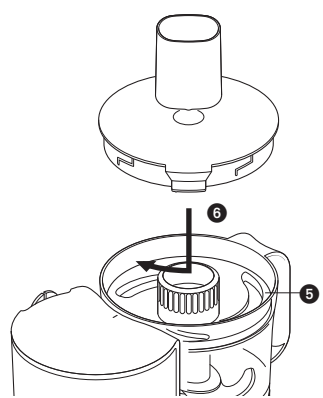
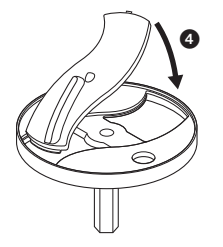
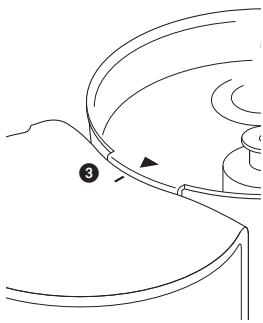
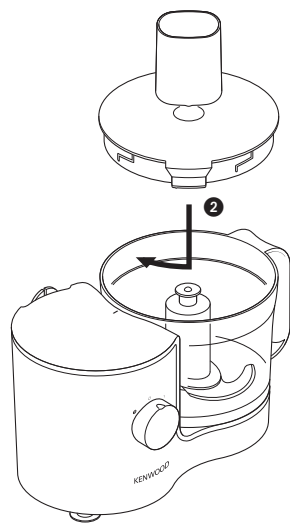
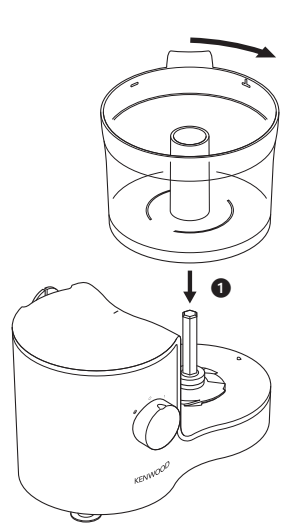
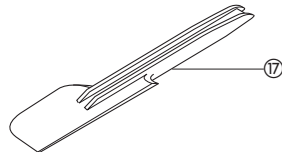
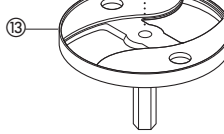
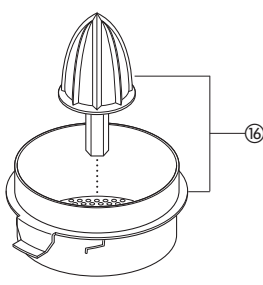
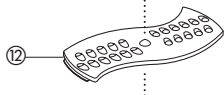
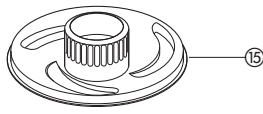
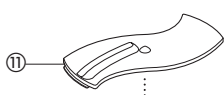
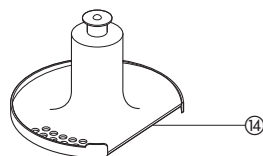
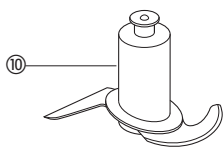
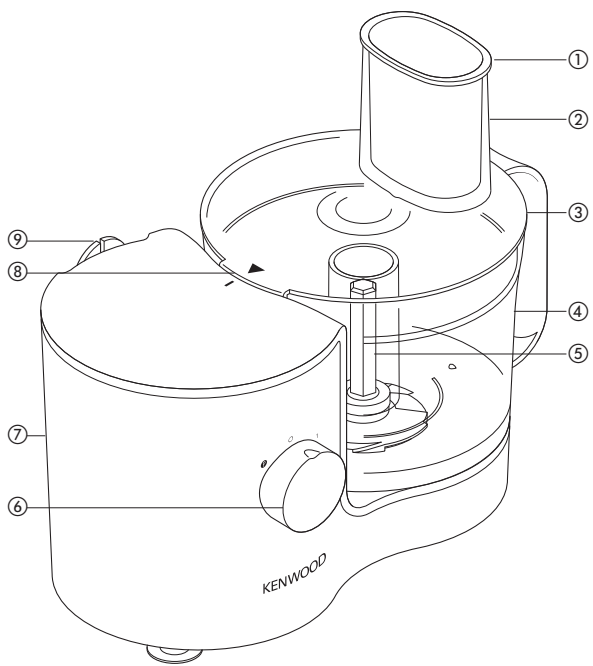

before using your Kenwood appliance

- Read these instructions carefully and retain for future reference.
- Remove all packaging and any labels.

safety

- The blades and plates are very sharp, handle with care. **Always hold by the finger grip at the top, away from the cutting edge, both when handling and cleaning.**
- Do not lift or carry the processor by the handle - or the handle may break resulting in injury.
- Always remove the knife blade before pouring contents from the bowl.
- Keep hands and utensils out of the processor bowl whilst connected to the power supply.
- Switch off and unplug:
 - before fitting or removing parts;
 - when not in use;
 - before cleaning.
- Never use your fingers to push food down the feed tube. Always use the pusher/s supplied.
- Before removing the lid from the bowl or bowl from the power unit:-
 - switch off;
 - wait until the attachment/blades have completely stopped.
- Liquids should be allowed to cool to room temperature before blending.
- Do not use the lid to operate the processor, always use the on/off speed control.
- **This appliance will be damaged and may cause injury if the interlock mechanism is subjected to excessive force.**
- Never use an unauthorised attachment.
- Never leave the appliance unattended when it is operating.
- Never use a damaged appliance. Get it checked or repaired: see 'service & customer care'.
- Never let the power unit, cord or plug get wet.
- Don't let excess cord hang over the edge of a table or worktop or touch hot surfaces.
- Do not exceed the maximum capacities stated.
- This appliance is not intended for use by persons (including children) with reduced physical, sensory or mental capabilities, or lack of experience and knowledge, unless they have been given supervision or instruction concerning use of the appliance by a person responsible for their safety.
- Children should be supervised to ensure that they do not play with the appliance.
- Only use the appliance for its intended domestic use. Kenwood will not accept any liability if the appliance is subject to improper use, or failure to comply with these instructions.
- Misuse of your processor can result in injury.

before plugging in

- Make sure your electricity supply is the same as the one shown on the underside of your appliance.

^a Important – UK only

- The wires in the cord are coloured as follows:
Blue = Neutral, Brown = Live.
- The appliance must be protected by a 3A approved (BS1362) fuse.

Note:

- For non-rewireable plugs the fuse cover **MUST** be refitted when replacing the fuse. If the fuse cover is lost then the plug must not be used until a replacement can be obtained. The correct fuse cover is identified by colour and a replacement may be obtained from your Kenwood Authorised Repairer (see Service).
- If a non-rewireable plug is cut off it must be **DESTROYED IMMEDIATELY**. An electric shock hazard may arise if an unwanted non-rewireable plug is inadvertently inserted into a 13A socket outlet.
- This appliance conforms to EC directive 2004/108/EC on Electromagnetic Compatibility and EC regulation no. 1935/2004 of 27/10/2004 on materials intended for contact with food.

before using for the first time

- 1 Remove the plastic blade covers from the knife blade. **Take care the blades are very sharp.** These covers should be discarded as they are to protect the blade during manufacture and transit only.
- 2 Wash the parts see 'care & cleaning'

key

processor

- ① pusher
- ② feed tube
- ③ lid
- ④ bowl
- ⑤ food processor drive
- ⑥ speed/pulse control
- ⑦ power unit
- ⑧ safety interlock
- ⑨ cord storage (at back)

attachments

- ⑩ knife blade
- ⑪ slicing plate
- ⑫ shredding plate
- ⑬ plate carrier
- ⑭ whisk
- ⑮ maxi-blend canopy
- ⑯ citrus juicer
- ⑰ spatula

to use your food processor

- 1 Fit the bowl onto the processor base - handle towards the back - lower and turn clockwise until it locks firmly into place ❶.
- 2 Add an attachment over the food processor drive.
 - Always fit the bowl and attachment onto the processor before adding ingredients.
- 3 Fit the lid onto the bowl - feed tube towards the back of the appliance ❷. Turn clockwise until the arrow on the lid aligns with the line on the power unit ❸.
- 4 Plug in and switch on.
 - **The processor won't work if the bowl and lid are fitted incorrectly.**
 - Use the pulse (P) for short bursts. The pulse will operate for as long as the control is held in position.
- 5 Reverse the above procedure to remove the lid, attachments and bowl.
 - **Always switch off and unplug before removing the lid. important**
 - Your processor is not suitable for crushing or grinding coffee beans, or converting granulated sugar to caster sugar.
 - When adding almond essence or flavouring to mixtures avoid contact with the plastic as this may result in permanent marking.

maximum capacities	
egg whites	6
chopping meat	300g/10oz
shortcrust pastry flour weight	250g/9oz
yeast dough flour weight	340g/12oz
one stage sponge cake total weight	800g/1lb 12oz
soup with canopy	800ml/1.3pt

using the attachments

knife blade

This blade is the most versatile of all the attachments. The texture you get is determined by the length of processing time. For coarser textures use the 'pulse' feature checking the consistency regularly.

what the knife blade can do.

Raw meat

Make 'mince' by trimming raw meat of any excess fat and cutting into 2cm $\frac{3}{4}$ in cubes, place into the bowl and operate for approximately 10 seconds or until the desired texture is achieved. The longer you run the machine the smoother the texture will be.

Cooked meat

Follow the method for raw meat but process for a shorter time.

Vegetables

Cut the vegetables into pieces approximately 2.5cm/1in in size. Process foods having a similar texture together eg harder vegetables like carrots and potatoes or softer ones like mushrooms, tomatoes or cooked vegetables.

Biscuit and breadcrumbs

Drop pieces down the feed tube whilst the machine is operating.

Shortcrust pastry and scones

Put the flour into the bowl. Use fat straight from the refrigerator and cut into 2cm $\frac{3}{4}$ in cubes. Process until the mixture resembles fine breadcrumbs but take care not to overprocess. Leave the machine running and add the liquid down the feed tube. Process until one or two balls of pastry are formed. Chill before use.

Soups

Purée soups either before or after cooking. Drain the ingredients and place into the bowl with a small quantity of liquid from the recipe. Process until the desired consistency has been reached, then add to the remainder of the liquid.

Nuts

Chop nuts for cakes and biscuits by placing into the bowl and processing until the desired consistency is obtained.

Cake making

Sponge type cakes are best made by the 'all in one method'. All the ingredients are placed into the bowl and processed until smooth - approximately 10 seconds. A 'soft tub' margarine used straight from the refrigerator and cut into 2cm $\frac{3}{4}$ in cubes should always be used.

Savoury dips/spreads

Place the solid ingredients into the bowl in 2.5cm/1in cubes. Process until finely chopped. Add the cream etc., and continue to process until the ingredients are well blended.

Batters

With the knife blade in position place the dry ingredients, egg and a little liquid in the bowl, process until smooth. Add the remaining liquid down the feed tube whilst the machine is operating.

Mayonnaise

Place the egg and seasonings into the bowl and mix for a few seconds. With the machine running gradually add the oil down the feed tube in a slow steady stream.

Yeast dough

Place the flour, fat and other dry ingredients into the bowl and process for a few seconds to mix. With the machine running add the liquid mixture down the feed tube and continue processing until the mixture forms a dough and becomes smooth in appearance and elastic to touch - this will take 45-60 seconds. Allow the dough to rise then re-knead for 10 seconds.

whisk

Use for egg whites and cream only. The whisk is unsuitable for other recipes. Make sure the bowl and whisk are free from any traces of grease or egg yolk when whisking egg whites.

slicing and shredding plates

what the cutting plates can do.

slicing plate - slices carrots, potato, cabbage, cucumber, courgette, beetroot, onion.

shredding plate - grates cheese, carrot, potato and foods of a similar texture.

to assemble the plate carrier

- 1 Select the desired plate and fit into the carrier with the cutting side uppermost.
 - Locate one end of the plate under the rim and press the other end into position. It will only fit one way round ❹.

using the cutting plates

shredding plate

Cut pieces of food to fit the feed tube. Fill the tube almost to the top and push down using the pusher with an even pressure whilst the machine is running.

Longer shreds can be obtained by stacking pieces horizontally in the feed tube eg carrot.

slicing plate

If necessary cut food to fit the feed tube. Core foods such as apples and peppers. Pack the food in an upright position in the feed tube. The height should be slightly shorter than the feed tube. Using the pusher, push down with an even pressure whilst the machine is running.

hints

- Use fresh ingredients.
- Don't cut food up too small. Fill the feed tube fairly full, this prevents food from slipping sideways during processing.
- When slicing or shredding: food placed upright comes out shorter than food placed horizontally.
- After using a cutting plate there will always be a small amount of waste on the plate or in the food.
- Do not allow food to build up to the underside of the plate - empty regularly.
- Push food down the feed tube using an even pressure.

maxi blend canopy

When blending, use the maxi blend canopy in conjunction with the knife blade. It allows you to increase the liquid processing capacity of the bowl and improve the chopping performance of the blade.

- 1 Place the canopy into the bowl over the knife blade - **do not push down** ⑤.
- 2 Fit the lid ⑥

citrus press

The citrus press is used to juice citrus fruit ie oranges, lemons, limes and grapefruits.

- 1 Fit the bowl onto the processor. Add the strainer and turn clockwise until the fin on the strainer aligns with the mark on the processor body ⑦.
- 2 Attach the cone onto the drive shaft turning until it drops all the way down ⑧.
- 3 Cut the fruit in half. Switch on and press the fruit onto the cone.

care & cleaning

- Always switch off and unplug before cleaning.
- Handle blades and cutting plates with care - they are extremely sharp.
- Some foods may discolour the plastic. This is perfectly normal and won't harm the plastic or affect the flavour of your food. Rub with a cloth dipped in vegetable oil to remove the discolouration.

power unit

- Wipe with a damp cloth, then dry. Ensure that the interlock area is clear of food debris.
- Don't immerse the power unit in water.
- Wrap excess cord around the bracket at the back of the appliance.

all other parts

- Wash by hand, then dry.
- Alternatively they can be washed on the top rack of your dishwasher. A short low temperature programme is recommended.

service & customer care

- If the cord is damaged it must, for safety reasons, be replaced by KENWOOD or an authorised KENWOOD repairer.

UK

If you need help with:

- using your appliance or
 - servicing, spare parts or repairs (in or out of guarantee)
- ☎ call Kenwood customer care on 023 9239 2333. **Have your model number (ie FP120) and date code (4 digit code ie 6T41) ready.** They are on the underside of the power unit.
- **spares and attachments**
- ☎ call 0870 2413653.
- **other countries**
- Contact the shop where you purchased your appliance.

- Designed and engineered by Kenwood in the UK.
- Made in China.



IMPORTANT INFORMATION FOR CORRECT DISPOSAL OF THE PRODUCT IN ACCORDANCE WITH EC DIRECTIVE 2002/96/EC.

At the end of its working life, the product must not be disposed of as urban waste.

It must be taken to a special local authority differentiated waste collection centre or to a dealer providing this service.

Disposing of a household appliance separately avoids possible negative consequences for the environment and health deriving from inappropriate disposal and enables the constituent materials to be recovered to obtain significant savings in energy and resources. As a reminder of the need to dispose of household appliances separately, the product is marked with a crossed-out wheeled dustbin.

guarantee UK only

If your food processor goes wrong within one year from the date you bought it, we will repair it (or replace it if necessary) free of charge provided:

- it has been used in accordance with these instructions.
 - you have not misused, neglected, or damaged it;
 - it has not been modified (unless by KENWOOD);
 - it is not second hand;
 - it has not been used commercially;
 - you have not fitted a plug incorrectly; and
 - **you supply your receipt to show when you bought it.**
- This guarantee does not affect your statutory rights.

recipes

mackerel pâté

200g/8oz smoked mackerel cut into 2cm³/₄in cubes
100g/4oz cream cheese cut into 2cm³/₄in cubes
few drops of lemon juice
salt and pepper

} optional

Fit the knife blade in the bowl, add all the ingredients and blend until smooth.

shortcrust pastry

250g/9oz plain flour
125g/4½oz mixture of lard and margarine, cut into 2cm³/₄in cubes, taken straight from the refrigerator
pinch salt
45ml/9tsp water

Fit the knife blade to the bowl, add the flour, fat and salt.

Process until the mixture resembles fine breadcrumbs (approximately 6 seconds - don't overprocess as it will continue mixing when the water is added.)

With the machine running add the water down the feed tube and process until one or two balls of pastry are formed. Remove the pastry from the bowl and gather together by hand to prevent overprocessing. Wrap in cling film and chill for 30 minutes before using.

beef cobbler

450g/1lb lean braising steak, cut into 2.5cm/1in cubes
1 onion, peeled
25g/1oz butter
400g tin chopped tomatoes
125g/4½oz mushrooms, wiped
2.5ml/½tsp mixed herbs
salt and pepper

topping

200g/8oz self raising flour
75g/3oz suet
50g/2oz cheddar cheese
90ml/6tbsp water approximate

With the knife blade in position separately chop the onion, mushrooms and meat (chop the meat in two batches). Melt the butter add the onion and meat and fry for approximately 10 minutes. Add the tomatoes, mushrooms and seasoning and simmer gently for approximately 20 minutes. Transfer the mixture to an ovenproof dish.

Grate the cheese. Place the knife blade in position, add the cheese, flour and suet. Mix together then with the motor running add sufficient water down the feed tube to make a firm dough. Roll out on a lightly floured surface to approximately 1cm¹/₂in thick and cut out circles using a 6cm/2½in cutter. Arrange the scones on top of the meat overlapping slightly. Brush with milk then bake at 200°C, 400°F or gas mark 6 for 30 minutes.

layered salad

1/4 small white cabbage, stalk removed
1/2 small red cabbage, stalk removed
1/2 cucumber
2 eating apples, cored
2 carrots, peeled
100g/4oz cheddar cheese
50g/2oz walnuts

Separately slice the cabbage, cucumber and apples then place in layers in a salad bowl. Separately grate the carrot and cheese and add in layers to the bowl. Using the knife blade chop the walnuts and sprinkle on top of the salad. Serve with your favourite salad dressing.

victoria sandwich

150g/6oz 'soft tub' margarine, cut into 2cm³/₄in cubes, taken straight from the refrigerator
150g/6oz caster sugar
3 eggs
150g/6oz self raising flour
jam
icing sugar

Using the knife blade, place the margarine, sugar, eggs and flour into the bowl. Process for a few seconds (approximately 5-8 seconds) until smooth.

Place the mixture into two greased 18cm/7in sandwich tins and bake in a pre-heated oven at 190°C/375°F/gas mark 5 for approximately 25 minutes until golden and springs back when lightly touched. Turn onto a wire rack and allow to cool, then sandwich together with jam and dredge with icing sugar.

mushroom soup

200g/8oz white button mushrooms
1 small onion
50g/2oz butter
250ml/½pt white stock
25g/1oz plain flour
250ml/½pt milk
40ml/2tbsp single cream
salt and pepper

Peel or wipe the mushrooms, slice mushrooms and onions using the slicing plate. Melt the butter and fry the vegetables for about 5 minutes. Add the stock, bring to the boil, cover pan and allow to simmer for 15 minutes, cool slightly. With the knife blade in position pour the soup into the processor bowl, add the flour and process until smooth. Return to the pan add the milk, bring to the boil stirring all the time, finally add the cream and seasonings.

white bread

300g/10oz strong white plain flour
5ml/1tsp salt
6g/½oz lard
15g/½oz fresh yeast or 10ml/2tsp dried active yeast plus
5ml/1tsp sugar
175ml/6fl.oz warm water

dried active yeast

Sprinkle the dried yeast into the warm water, add the sugar and allow to stand for approximately 10 minutes or until the mixture is frothy.

fresh yeast

Crumble into the bowl with the flour.

other types of yeast

Follow the manufacturers instructions.

With the knife blade in the bowl, add the flour, salt, lard (fresh yeast if used) and process for a few seconds to evenly distribute the ingredients throughout the flour. With the machine operating, quickly pour the water or yeast liquid in a steady stream through the feed tube (this should take about 10 seconds). Continue processing until the mixture forms a dough and becomes smooth in appearance and elastic to the touch, this will take about 45 seconds. Remove the dough into either a greased polythene bag or a lightly floured bowl and cover. Leave this dough in a warm place until doubled in size. Return the risen dough to the processor bowl fitted with the knife blade and re-knead for about 10 seconds. Shape the dough into a loaf or about 15 rolls and place on greased baking trays and leave until double in size. Bake at 230°C/450°F/gas mark 8 for 20-25 minutes for a loaf or 10-15 minutes for bread rolls. When the loaf or rolls are cooked they should sound hollow when tapped on the base.

Free Manuals Download Website

<http://myh66.com>

<http://usermanuals.us>

<http://www.somanuals.com>

<http://www.4manuals.cc>

<http://www.manual-lib.com>

<http://www.404manual.com>

<http://www.luxmanual.com>

<http://aubethermostatmanual.com>

Golf course search by state

<http://golfingnear.com>

Email search by domain

<http://emailbydomain.com>

Auto manuals search

<http://auto.somanuals.com>

TV manuals search

<http://tv.somanuals.com>