

KENWOOD

Microwave Oven



K17SJA09



DSG Retail Limited is responsible for after sales services.
If you have a query about the product please contact our product support line
0844 561 6263 (Currys) and 08700 118 117 (Pixmania).

table of contents

table of contents	2 - 3
know your Kenwood microwave	4
safety information	4 - 8
using aluminium foil in your microwave	9
unpacking and getting ready	10
introducing microwave cooking	11 - 16
cooking with a microwave	11 - 12
microwave heating categories	13
<hr/>	
microwave cooking	19
two-stage cooking	20
delay start cooking (program set in advance)	21
auto cooking	22 - 23
auto menu	22 - 23
quick start cooking	24
potatoes cooking	25
auto reheat	26
defrosting	27 - 28
defrost by weight	27
defrost by time	38
querying the cooking function	29
to find out the cooking power	29
to find out the time	29
to find out the pre-set time	29
<hr/>	
cleaning your microwave	30 - 31
troubleshooting	32 - 33
questions and answers	32 - 33
specification	34

steam	14
condensation	14
product overview	14 - 15
control panel overview	15
checking your microwave	16
clock setting	17
setting the child lock	18

before use

operating instructions

care, maintenance and troubleshooting

know your Kenwood microwave

before using your Kenwood microwave

- Read these instructions carefully and retain for future reference.
- Remove all packaging labels. Please dispose of them properly.

before calling for service

- Review the section on Troubleshooting. This will help you to solve some general problems by yourself and reduce the need to ask for the help of professional technicians.

safety information

general safety

- Switch off and unplug before fitting or removing tools/ attachments, after use and before cleaning.
- Keep your fingers away from moving parts and fitted attachments.
- Never use a damaged machine.
- Never operate the machine when it is empty.
- Keep cord out of the reach of children.
- Keep power unit, cord or plug away from water.
- Never exceed the maximum capacities.
- When using an attachment, read the accompanying safety instructions.
- Take care when lifting this appliance as it is heavy.
- This appliance is not intended for use by persons (including children) with reduced physical, sensory or mental capabilities, or lack of experience and knowledge, unless they have been given supervision or instruction concerning use of the appliance by a person responsible for their safety.
- Children should be supervised to ensure that they do not play with the appliance.
- Only use the appliance for its intended domestic use.
The company responsible for this product, DSG Retail Limited, will not accept any liability if the appliance is subjected to improper use, or failure to comply with these instructions.

safety information

please read carefully and keep for future reference

maintenance of your microwave

WARNING  : *It is hazardous for anyone other than a qualified technician to carry out any service or repair operation which involves the removal of a cover that gives protection against exposure to microwave energy.*

WARNING  : If the door or door seals are damaged, the oven must not be operated until it has been repaired by a qualified technician.

- If smoke is observed, switch off, unplug the appliance and keep the door closed in order to contain any flames.
- If the supply cord is damaged, it must be replaced by a service agent or a qualified technician.
- If you have a pacemaker, please contact your doctor before using a microwave oven.

microwave use

- This microwave is not intended for commercial use.
- It should never be used for drying clothes or other non-food purposes.
- The microwave should not be left unattended when in use.
- The temperature of accessible surfaces may be high when the appliance is operating.
- To prevent high moisture content gathering inside the oven cavity, open the door immediately after the cooking function has stopped to allow steam to escape.
- Only use utensils that are suitable for microwave use.
- Care should be taken so metal objects are not used in the microwave.
 - These include :
 - ” Metal cooking utensils
 - ” Metal plates or trays
 - ” Wire twist ties
 - ” Crockery with metal trims
 - ” Meat thermometers
- Care should be taken when using paper, plastic, wooden or other combustible materials in the oven as they can catch fire.
- Oil & fat for deep frying should not be heated in the microwave.
- Only use cling film designed for microwave use & take extra care when removing the film to avoid steam burns.

before use

GB-5

safety information

cooking use

As the power of different microwave ovens can vary considerably, care must be taken when first using this appliance as it may cook faster than expected.

- Do not leave the appliance unattended during use.

WARNING  : Only allow children to use the oven without supervision when adequate instructions have been given so that the child is able to use the oven in a safe way and understands the hazards of improper use; DO NOT assume that because a child has mastered one cooking skill he/she can cook everything without close supervision. The microwave MUST NOT be treated nor used like a toy.

- Take care when cooking food with a high sugar or fat content, such as Christmas pudding or fruitcake. The sugar or fat can overheat and in some cases catch fire.

fire!

In the event of fire:

- Keep the oven door closed.
- Turn off the power.
- Unplug the appliance from the mains power.

first aid

Treat scalding by:

- Quickly placing the scald under cold running water for at least 10 minutes.
- Cover with a clean dry dressing. Do not use creams, oils or lotions.

cleaning your microwave

The oven should be cleaned regularly and food deposits removed. Failure to maintain the oven in a clean condition can affect the life of the appliance and possibly result in a hazardous situation. (See cleaning your microwave)

safety information

do not use these in your microwave

- Never use equipment made of metal, except foil in your microwave oven. The microwave energy cannot pass through the metal so it bounces off and sparks against the inside of the oven.
- Stop the microwave straight away if any equipment does cause sparks.
- Remember that some crockery has a metal trim around the edge. Even this trim can cause sparks.

Containers / Certain foods

WARNING  : Pressure will build up in sealed containers and cause them to explode. Therefore, do not use the following in your microwave:

- Sealed containers
 - Capped bottles
 - Vacuum containers
 - Sealed jars
 - Hard-boiled eggs
 - Eggs in their shells
 - Nuts
- Always pierce the skin of fruit and vegetables, such as potatoes.
 - Never use scratched, cracked or damaged glass in a microwave. Damaged glass can explode.

delayed boiling

Liquids heated in a microwave can boil up when removing them from the microwave.

Take the following precautions :

- Always stir liquids, before and after cooking.
- Allow them to stand.
- Use containers that are wider at the top than the bottom.

preparing food for babies

Extra care must be taken when preparing food or drink for babies and small children.

- Always test the food or liquid temperature before giving it to a baby.
- When using a baby bottle, ensure the teat is removed before heating.
- When warming milk, ensure the bottle is shaken.

caution!

During cooking, the outer surface will become hot, do not touch outer casing of appliance. Care should be taken not to store any items on top of your microwave oven.

before use

GB-7

safety information



earthing instructions

- **WARNING: THIS APPLIANCE MUST BE EARTHED.**
- **This appliance is equipped with a cord having an equipment-earthing conductor and an earthing plug.**
- The plug must be plugged into an appropriate outlet that is installed and earthed in accordance with all local standard and requirements.

warning!

- Improper connection of the equipment-earthing conductor can result in a risk of electric shock.
- The wires in the cord are coloured as follows:
 - Green and Yellow = Earth,
 - Blue = Neutral,
 - Brown = Live.
- Check with a qualified electrician or service representative if you are in doubt whether the appliance is properly earthed.
- Never modify the plug provided with the appliance.
- If the plug does not fit properly to the outlet, have a qualified electrician to install a proper outlet.

using aluminium foil in your microwave

It is safe to use aluminium foil in your microwave oven as long as you follow these safety guidelines.

As with all metal, microwave energy cannot pass through foil, but provided that you keep the foil away from the side of the oven it will not cause sparks and there will not be any damage to your oven.

Using foil is a good way of shielding parts of food that you do not want to cook as quickly as others – perhaps where the food is narrower and would otherwise overcook.

Place the foil over the area you want to shield, taking care that the foil will not touch the sides of the oven when the turntable rotates. Only use one piece of foil at a time so that you do not get sparks between the separate pieces.

Follow these guidelines when using foil in your microwave:

- Remove foil lids from containers before using in the microwave. Some lids are made of card with a foil covering – these should be removed too. Use a microwave-safe transparent lid if possible.
- Stir food during cooking if the container has a lid or film cover.
- Always use the glass turntable.
- Use shallow containers with a large surface area. Do not use containers that are more than 1.25in (3.5cm) deep.
- Use oven gloves when handling hot foil containers.
- Do not completely cover food with foil. The microwave energy cannot pass through the foil so the food will not cook.
- Do not let aluminium foil touch the inside of the oven.
- Do not use more than one piece of foil in the oven at the same time.

before use

unpacking and getting ready

This microwave oven is designed for home use. It should not be used for commercial catering.

1. After unpacking your oven, check that it has not been damaged whilst in the box. Make sure there are no dents on the oven, and the door closes properly. A dented or damaged oven could allow microwave energy to escape. Make sure that you have taken all the packaging out from the inside of the oven. Please dispose of the plastic wrappings or bags safely and keep them out of the reach of babies and young children.

2. Choose a flat work surface for your microwave away from heat sources such as radiators or fires and away from cold areas. You should allow a 10cm space all around the oven and 30cm above it so that warm air can escape from the vents during cooking – This microwave is not designed to be built in. ①

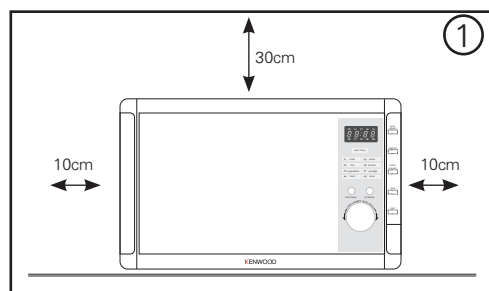

3. Plug your oven into a standard household electrical socket (230-240 volt, 13 amp rated). Avoid using a socket that also has an adaptor and other equipment plugged in. Do not use a multi-adaptor.

4. Put the turntable ring inside the oven and place the glass turntable on top of the ring. ② The turntable is shaped to sit securely on the spindle. You must always use the turntable and ring whenever you use the microwave.

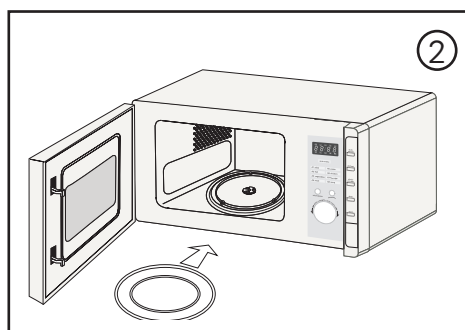

introducing microwave cooking

Always remember the basic safeguards you would follow when using any cooking equipment or handling hot food.

See below for basic guidelines on microwave cooking.

If you are unfamiliar with using a microwave, refer to the back of this instruction booklet for more information.

before use

cooking with a microwave

- Cooking with a microwave is much faster than conventional cooking and, whilst you should make sure that the food is fully cooked, you should also be careful not to overcook it.
- Microwave energy can heat unevenly so stirring to distribute heat is very important. Always stir from the outside, inwards.
- If you are cooking a number of individual foods at the same time, such as baked potatoes or small cakes, arrange them evenly on the turntable so that they cook evenly. Never stack food in your microwave.
- Turn larger foods such as meat roasts and poultry during cooking so that the top and bottom cook evenly. It is also recommended to turn pieces of meat or poultry, especially if they contain the bone.
- Meat and poultry which is cooked for 15 minutes or more will brown lightly in its own fat. Anything cooked for a shorter time can be brushed with a browning sauce to give an appetising colour.
- Strips of aluminium foil can be used to cover the thinner pieces of food to stop them overcooking before the thicker parts of the food have had a chance to cook. Use the foil sparingly and wrap around the food or container carefully to stop it touching the inside of the oven which could cause sparks.

NOTE: You should always have your microwave checked by a qualified technician if it has been dropped or damaged to ensure it is safe to use.

- Microwave ovens cook food using microwave energy that is similar to naturally occurring radio waves. Normally, these “waves” would fade as they dispersed into the atmosphere but in a microwave oven they are concentrated onto the food causing it to heat up.
- Microwave energy cannot pass through metal – so it cannot escape from the inside of your microwave oven – but it can pass through materials like glass, porcelain, plastic and paper. These materials are used in the manufacture of microwave safe cooking equipment.
- Microwave safe cooking equipment will still get hot as the food it contains heats up.

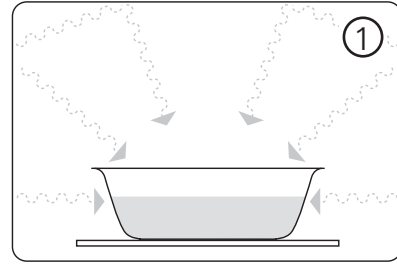

The microwave energy focuses on the moisture in the food causing lots of tiny vibrations. The vibrations get so great that the moisture, and the food heats up. (Fig 1)

checking your cooking utensils

Most heat-resistant, non-metallic cooking utensils are safe to use in your microwave. If you are not sure if you can use a utensil in your microwave, follow this simple test:

1. Put the utensil into the oven next to a cup of water – use a cup that you know is microwave-safe. Close the door.
2. Turn the microwave oven on for 30 seconds only.
3. At the end of the time, carefully check to see if the water has warmed up.
If the water has not warmed up but the utensil has, the utensil is not microwave-safe and should not be used in the oven.

microwave heating categories

Your oven has been tested and labelled to meet the government's voluntary agreement on the reheating of pre-cooked food.

The heating characteristics and output power levels of microwave ovens are usually calculated using a relatively large portion of food (a 1000 gram load, IEC 705) but many packs of pre-cooked food are sold in smaller packs, often about 350 grams. The government, in partnership with food companies and microwave manufacturers, have set up a system of heating categories to help you choose the reheating time for pre-cooked food.





800W is the output power of the oven.

E is the heating category for your oven. Check the cooking times for category E on the food's packaging to see how long it should be cooked for. Please see below example for reference.

To Microwave:
 Remove outer packaging.
 Pierce film lid SEVERAL TIMES.
 Place on a microwaveable plate.
 Turn the heat on to full power.
 Stir or Turn halfway through heating.

To Microwave from frozen:
 Remove outer packaging.
 Pierce film lid SEVERAL TIMES.
 Place on a microwaveable plate.
 Turn the heat on to full power.
 Stir or Turn halfway through heating.

	Heating Category		Wattage (IEC 705)	
	B	D	650W	750W
	B	D	650W	750W
Full power (in minutes)	2	2	2	2
Stir / Turn	Stir / Turn		Stir / Turn	
Full power (in minutes)	2	1.5	2	1.5
Standing time (in minutes)	1	1	1	1

	Heating Category		Wattage (IEC 705)	
	B	D	650W	750W
	B	D	650W	750W
Full power (in minutes)	3	2.5	3	2.5
Stir / Turn	Stir / Turn		Stir / Turn	
Full power (in minutes)	4	3.5	4	3.5
Standing time (in minute)	1	1	1	1

steam

When you microwave food, steam is created as water in the food heats up and evaporates.

The steam formed during microwave cooking is entirely safe. It has to escape from the microwave to prevent pressure from building up inside the oven. It does this through the vents on the back of the oven and from around the door.

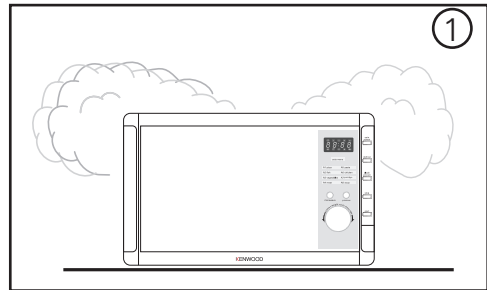

condensation

As the steam cools, you may find the condensation gathers in small pools inside your microwave and on the work surface beneath the door and vents.

Always dry the oven after cooking foods with a high moisture content.

Your microwave is designed to let steam escape from the vents and around the door without microwave energy escaping. (Fig 1)

There is no danger of microwave energy escaping with the steam.

product overview

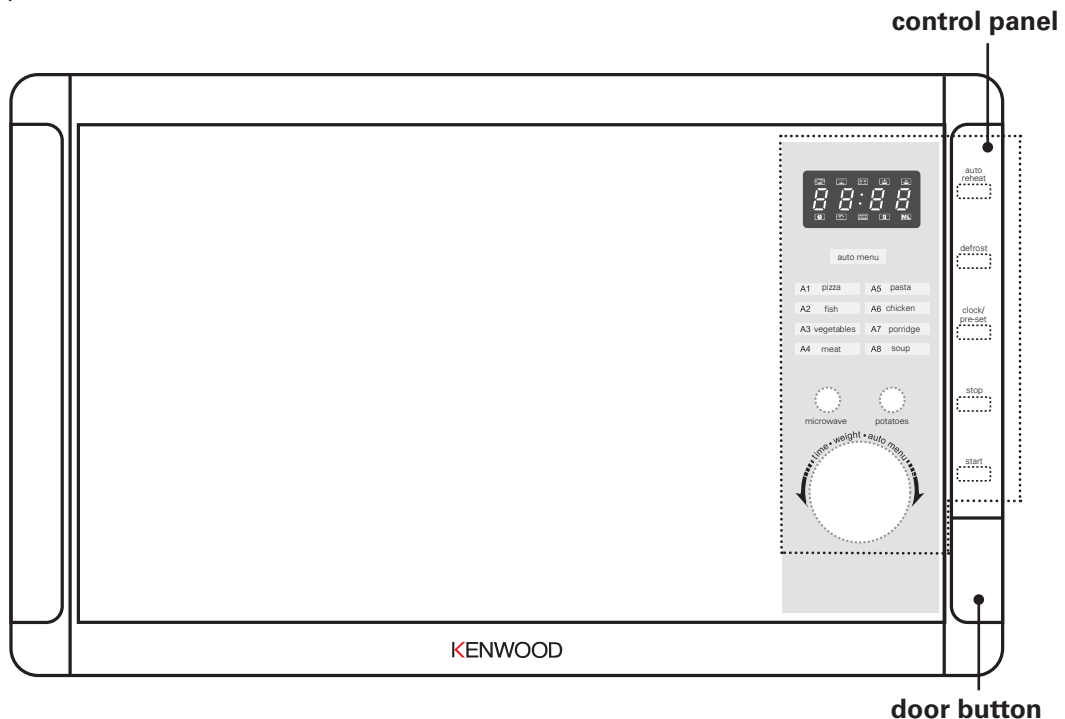



GB-14

control panel overview

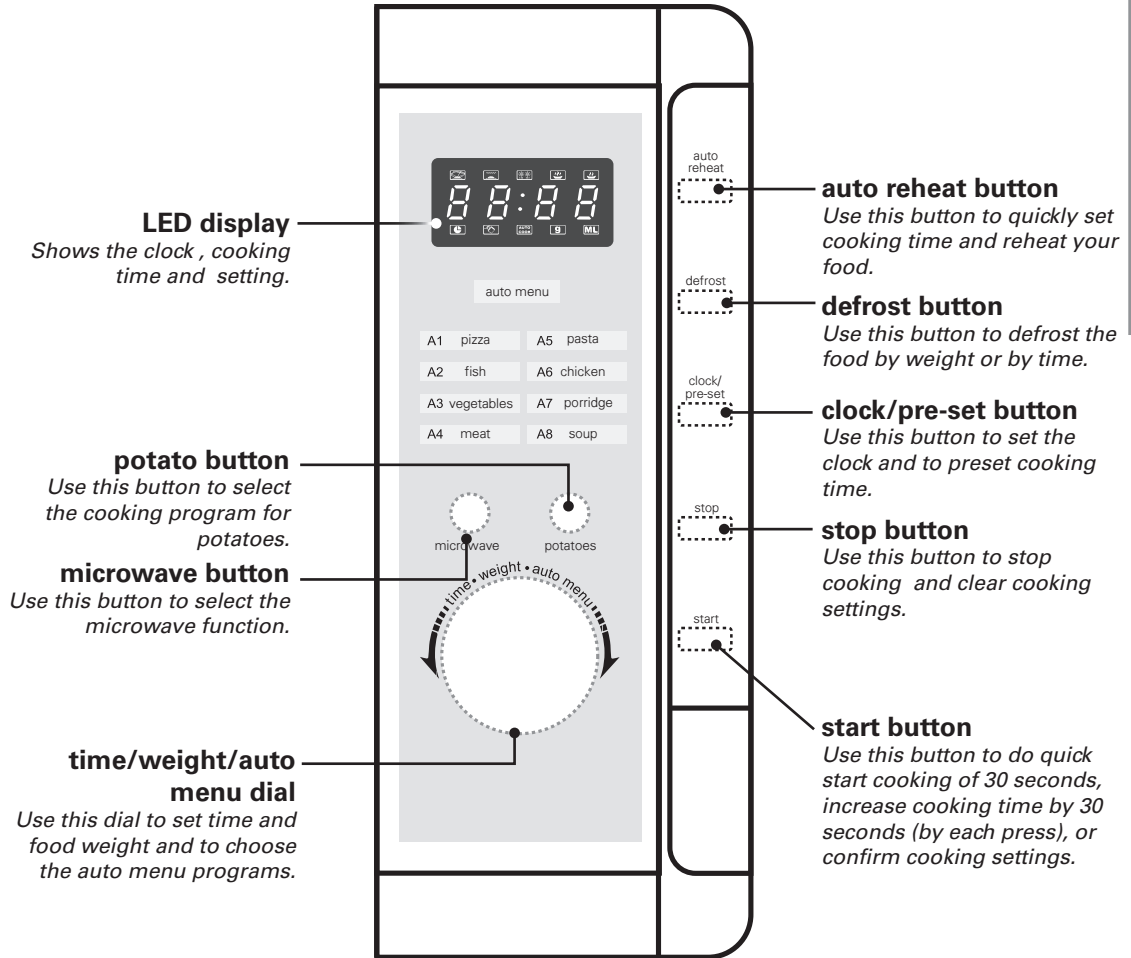
before use

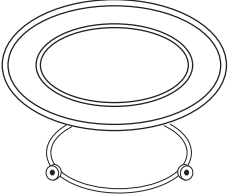

Accessories	
<p>part numbers 252100500496 and 252200200011</p>  <p>Glass Turnable x 1 Turnable Ring x 1</p>	<p>part number 261800303068</p>  <p>Instruction Manual x 1</p>

checking your microwave

Check your microwave after unpacking.

NOTE: For your safety, the microwave stops if the oven door is opened during cooking.

1. Pull the handle to open the door.
Put the turntable ring inside the oven and place the glass turntable on top of the ring. The turntable is shaped to sit securely on the spindle. (Fig 1)
You must always use the glass turntable and turntable ring whenever you use the microwave.
Place a cup of water on the glass turntable. Make sure the cup is microwave-safe and it should not have any decorative metal trim.
2. Close the oven door.
3. Press the **stop** button to clear any settings that have already been made. (Fig 2)
4. Press the **microwave** button once and then press **start** button. Turn the **time/weight/ auto menu** dial to adjust the time of the microwave cooking cycle, which allows you to check the operation of the microwave oven.
5. Press the **stop** button to clear any settings once the checking is complete.

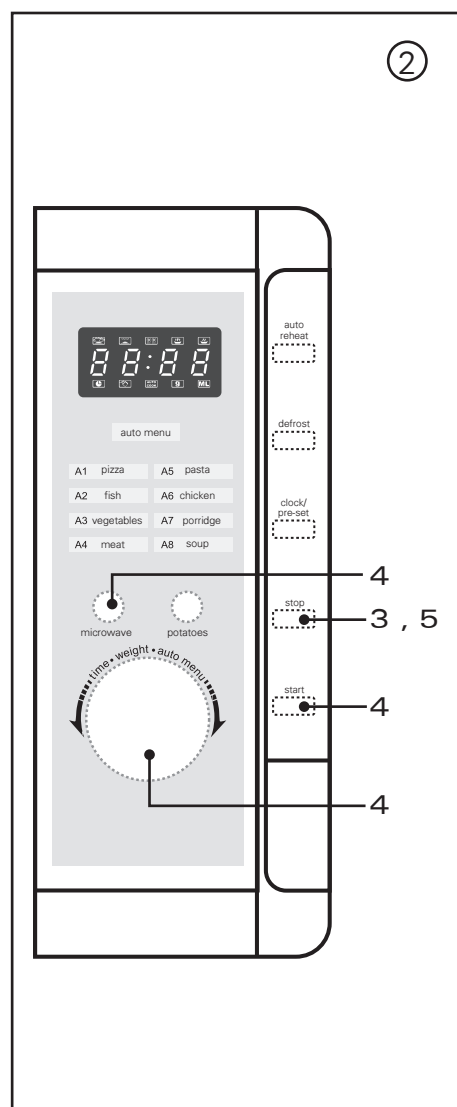
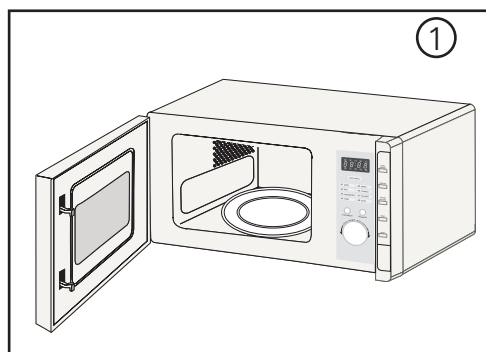

clock setting

When the microwave oven is connected to the mains power, the oven will display **0:00**, and the microwave will sound once. Please ensure that you have set the clock prior to use.

Please follow the steps below to set the clock.

1. Press the **clock/pre-set** and the hour figures will flash.
2. Turn the **time/weight/auto menu** dial to adjust the hour figures. The input time has to be within 0-23.
3. Press the **clock/pre-set** and the minute figures will flash.
4. Turn the **time/weight/auto menu** dial to adjust the minute figures, the input time has to be within 0-59.
5. Press the **clock/pre-set** again to complete the clock setting.
: will start flashing and the time will illuminate.

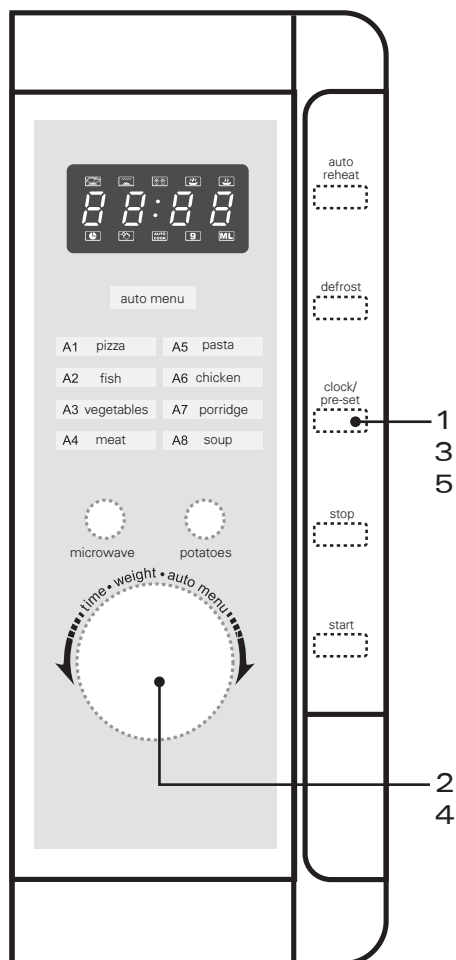

before use

setting the child lock

This feature prevents the electronic operation of the oven by locking the operation of the control panel until you have cancelled it.

Please follow the steps below to set the child lock.

1. Press the **stop** button for 3 seconds.
A long tone will sound and the LED display will show **[- - -]** to indicate the microwave has set the child lock.
2. To release the child lock, press the **stop** button again for 3 seconds and a long tone will sound to indicate the microwave has released the child lock.

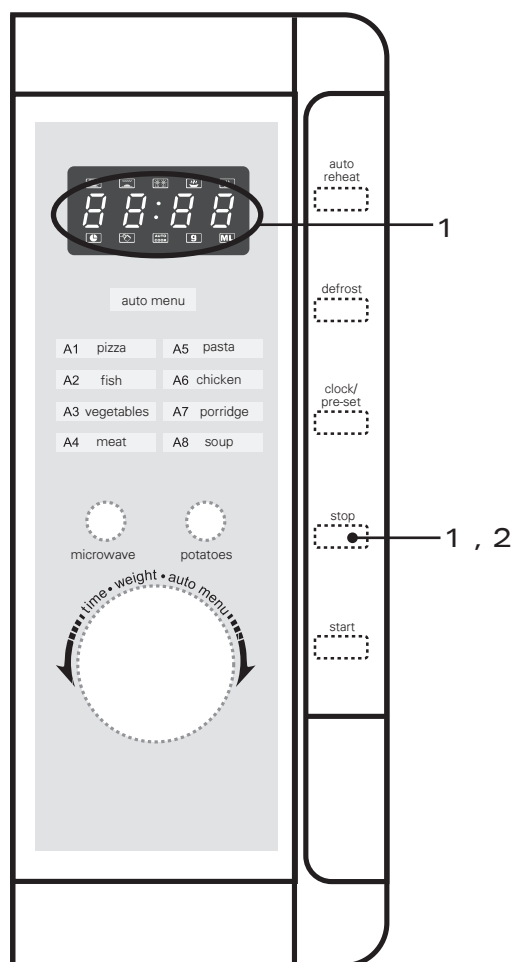

microwave cooking

For simple **Microwave Cooking**, follow the steps below.

For instance: If you want to use 80% microwave power to cook for 20 minutes.

1. Press the **microwave** button once and the LED display will show **P100**. Press the button again to change the microwave power level to **P80**.

NOTE: Alternatively, after you press the **microwave** button once, you can turn the **time/weight/auto menu** dial to change the power level to **P80** as well.

2. Press the **start** button to confirm the microwave power level.
3. Turn the **time/weight/auto menu** dial to adjust the cooking time until the LED display shows **20:00**.
4. Press the **start** button to confirm and start cooking.
5. Press the **stop** button to stop cooking and cancel the setting.

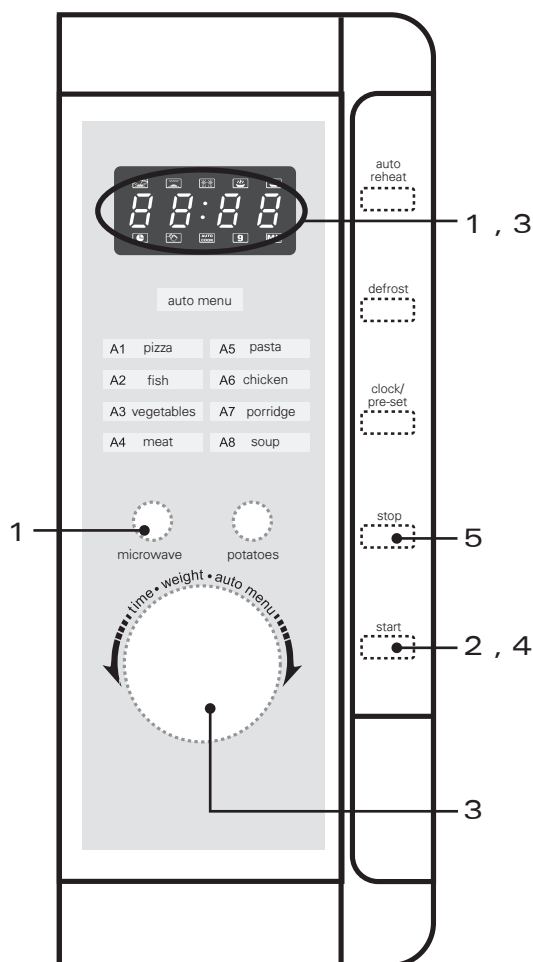

operating instructions

Microwave Button Control		
Order	LED Display	Microwave Power
1	P100	100%
2	P80	80%
3	P50	50%
4	P30	30%
5	P10	10%

two-stage cooking

For **Two-Stage Cooking**, please follow the steps below.

For instance: If you want to defrost your food for 5 minutes and then to cook it with 80% microwave power for 7 minutes.

NOTE: You can set 2 stages for Two-Stage Cooking at maximum. If defrosting is among one of the stages, then it needs to be set as the first stage.

1. Press the **defrost** button twice to initiate the multi-stage cooking with defrost as the first stage. The LED display will show **dEF2**.
2. Turn the **time/weight/auto menu** dial to adjust the defrosting time until the LED display shows **5:00**.
3. Press the **microwave** button once and the LED display will show **P100**. Press the button again to change the microwave power level to **P80**.

NOTE: Alternatively, after you press the **microwave** button once, you can turn the **time/weight/auto menu** dial to change the power level to **P80** as well.

4. Press the **start** button to confirm the microwave power level.
5. Turn the **time/weight/auto menu** dial to adjust the cooking time until the LED display shows **7:00**.
6. Press the **start** button to confirm and start cooking. The microwave oven will sound once to indicate it has started the defrosting count down. The microwave oven will sound again as it starts the microwave cooking (the second stage). Once completed, the microwave oven will sound five times.

7. Press the **stop** button to stop the cooking and cancel the setting.

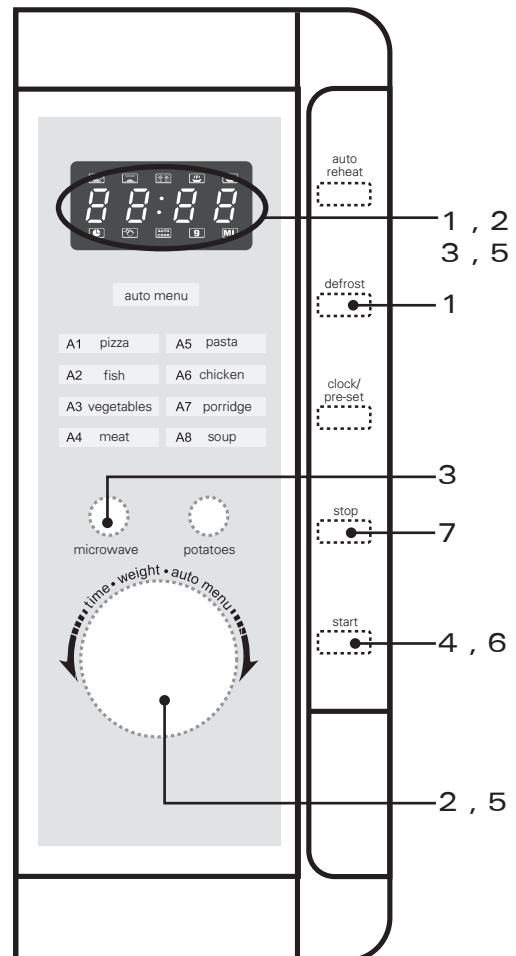

delay start cooking (program set in advance)

For **Delay Start Cooking**, set the clock first and follow the steps below.

For instance: The current time is 12 o'clock (noon) and you want to cook with 80% microwave power for 5 minutes in an hour and a half time.

NOTE: You can only set 2 stages for Delay Start Cooking at maximum. Defrost cannot be set as one of those stages. Auto Menu Cooking can only be set as single stage. Ensure the oven door is closed prior to setting the program.

1. Press the **microwave** button once and the LED display will show **P100**. Press the button again to change the microwave power level to **P80**.

NOTE: Alternatively, after you press the **microwave** button once, you can turn the **time/weight/auto menu** dial to change the power level to **P80** as well.

2. a Press the **start** button to confirm the microwave power level.
b Turn the **time/weight/auto menu** dial to adjust the cooking time until the LED display shows **5:00**.

ATTENTION: Do not press the **start** button to confirm and start cooking at this point.

3. a Press the **clock/pre-set** button to preset the starting time for the cooking. The hour figures will flash first.
b Turn the **time/weight/auto menu** dial to adjust the starting time until the LED display shows **13:00**.

4. a Press the **clock/pre-set** button to preset the starting time for the cooking. The minute figures will flash first.

- b Turn the **time/weight/auto menu** dial to adjust the starting time until the LED display shows **13:30**.

5. Press the **start** button to complete the setting. The microwave oven will sound when the count down reaches the starting time and cooking will start automatically.

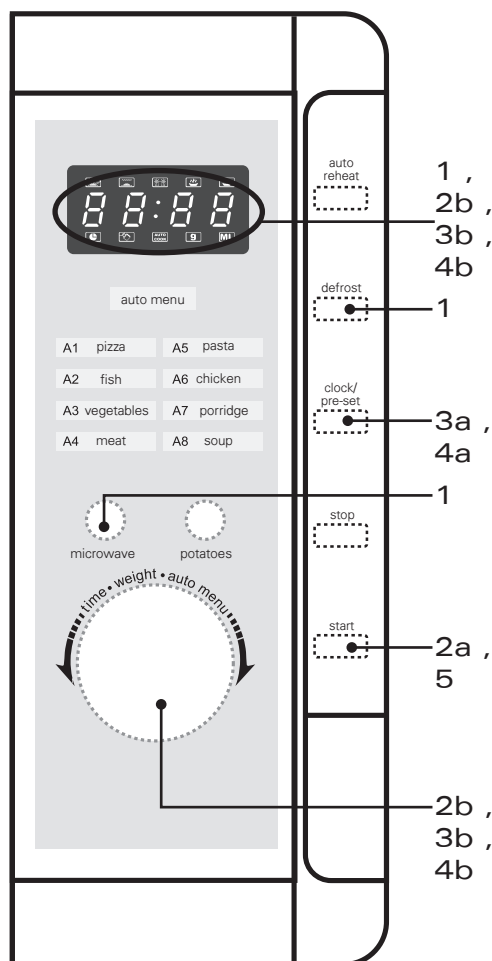

operating instructions

auto cooking

This feature allows you to cook most of your food based on the food category and the weight. Select the category and choose the default weight of the food. For quick reference of the cooking time and the default weight, please refer to the **Auto Menu** table.

auto menu

1. Turn the **time/weight/auto menu** dial to select the Auto Menu program required. The LED display will show **A-1**, **A-2**, **A-3** and so forth.
2. Press the **start** button to select the program.
3. Turn the **time/weight/auto menu** dial again to choose the default weight for your chosen program. Please refer to the Auto Menu table for more information.
4. Press the **start** button to confirm and start cooking.
5. Press the **stop** button to stop the cooking and cancel the setting.

For instance: If you want to cook 300g of fish using Auto Menu program. Please follow the steps below.

- a. Turn the **time/weight/auto menu** dial to select the Auto Menu program for fish. The LED display will show **A-2**.
- b. Press the **start** button to confirm the program selection.
- c. Turn the **time/weight/auto menu** dial again to select the default weight for **A-2** program until the LED display shows 300.
- d. Press the **start** button to confirm and start cooking.

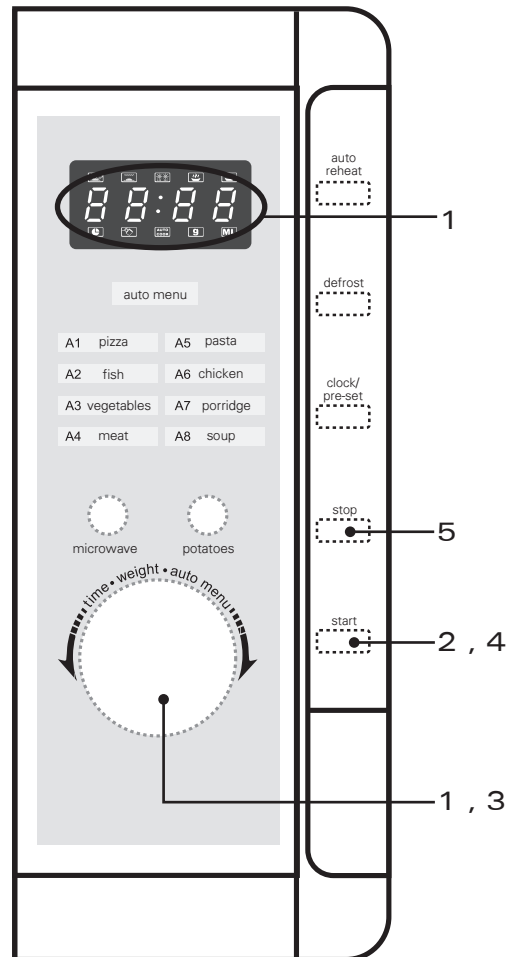

NOTE: The density and thickness of food can affect its cooking time. Ensure all food is piping hot and cooked thoroughly before serving. It is essential that food is checked during and after the recommended cooking time, even if Auto Menu was used.

Auto Menu table

Menu	Weight	Display	Cooking Time	Comments
A-1 pizza	200g	200	2'50"	This setting is designed for re-heating cooked pizza slices (not frozen pizza).
	400g	400	4'25"	
A-2 fish	200g	200	3'50"	Make sure food is cooked thoroughly before consuming. Additional cooking time may be required for thicker pieces of fish.
	300g	300	4'20"	
	400g	400	5'30"	
A-3 vegetables	250g	250	4'10"	<ul style="list-style-type: none"> Only use suitable microwavable containers and cling film in the microwave oven. Check regularly to ensure the water does not boil over.
	350g	350	5'00"	
	450g	450	6'40"	
A-4 meat	250g	250	4'40"	Make sure food is cooked thoroughly before consuming. Additional cooking time may be required for thicker pieces of meat.
	350g	350	5'40"	
	450g	450	7'00"	
A-5 pasta	50g	50	18'00"	50g of Pasta + 450ml of Cold Water <ul style="list-style-type: none"> Only use suitable microwavable containers and cling film in the microwave oven.
	100g	100	22'00"	100g of Pasta + 800ml of Cold Water <ul style="list-style-type: none"> Ensure to check the cooking regularly to make sure the water does not boil over.
A-6 chicken	200g	200	5'00"	Make sure food is cooked thoroughly before consuming. Additional cooking time may be required for thicker pieces of chicken.
	400g	400	8'40"	
	600g	600	10'10"	
A-7 porridge	550g	550	8'50"	50g of Oat + 500ml of Water <ul style="list-style-type: none"> Only use suitable microwavable containers and cling film in the microwave oven.
	1100g	1100	13'00"	100g of Oat + 1000ml of Water <ul style="list-style-type: none"> Ensure to check the cooking regularly to make sure the water does not boil over.
A-8 soup	200ml	200	2'00"	Only use suitable microwavable containers and cling film in the microwave oven. Pierce the film with a fork before cooking.
	400ml	400	3'10"	

operating instructions

quick start cooking

This feature allows you to quickly cook your food for 30 seconds with 100% microwave power. Please follow the steps below.

1. Press the **start** button to start the quick start cooking. Press the button again to increase by another 30 seconds, you may increase the cooking time up to 95 minutes.

NOTE: This feature is ONLY applicable to Microwave and Defrost programs. This feature is NOT applicable to Auto Menu and Defrost by Weight programs.

2. Alternatively, you can turn the **time/weight/auto menu** dial in anti-clockwise direction to set the cooking time with 100% microwave power first. Then, press the **start** button to start cooking.

3. Press the **stop** button to stop cooking or cancel the setting.

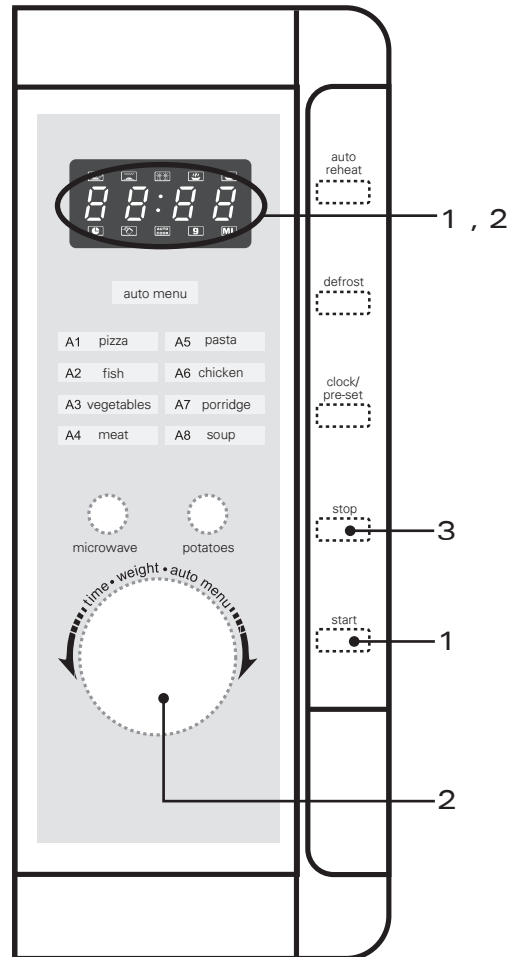

potatoes cooking

This feature is specially designed for you to quickly cook potatoes by weight. Please follow the steps below.

1. Press the **potatoes** button once and the LED display will show **200**. This number is equivalent to 200g of potatoes. Press the **potatoes** button again and the LED display will show **400** and so forth.

NOTE: Alternatively, after you press the **potatoes** button once, you can turn the **time/weight/auto menu** dial to change the weight to **400** as well.

2. After you have selected the weight, press the **start** button to start cooking.
3. Press the **stop** button to stop cooking or cancel the setting.

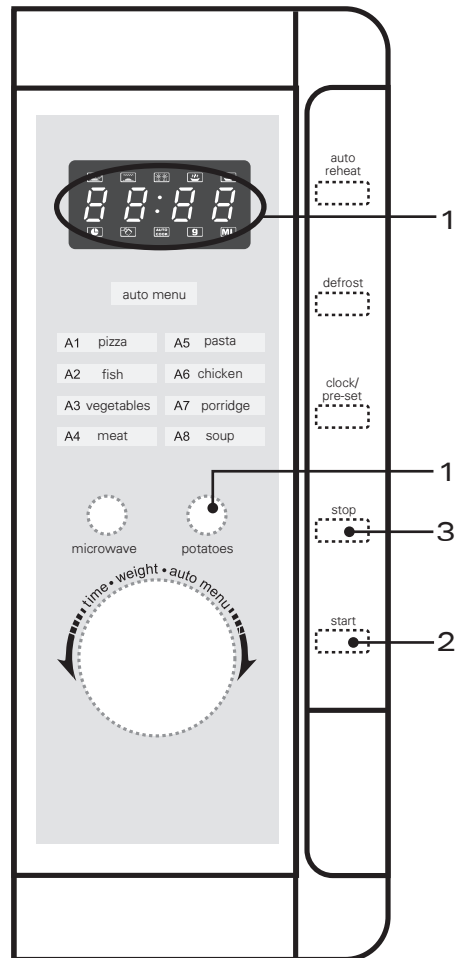

operating instructions

auto reheat

This feature allows you to quickly reheat your food by weight.
Please follow the steps below.

1. Press the **auto reheat** button once and the LED display will show **200**. This number is equivalent to 200g of food. Press the **auto reheat** button again and the LED display will show **400** and so forth.

NOTE: Alternatively, after you press the **auto reheat** button once, you can turn the **time/weight/auto menu** dial to change the weight to **400** as well.

2. After you have selected the weight, press the **start** button to start cooking.
3. Press the **stop** button to stop cooking or cancel the setting.

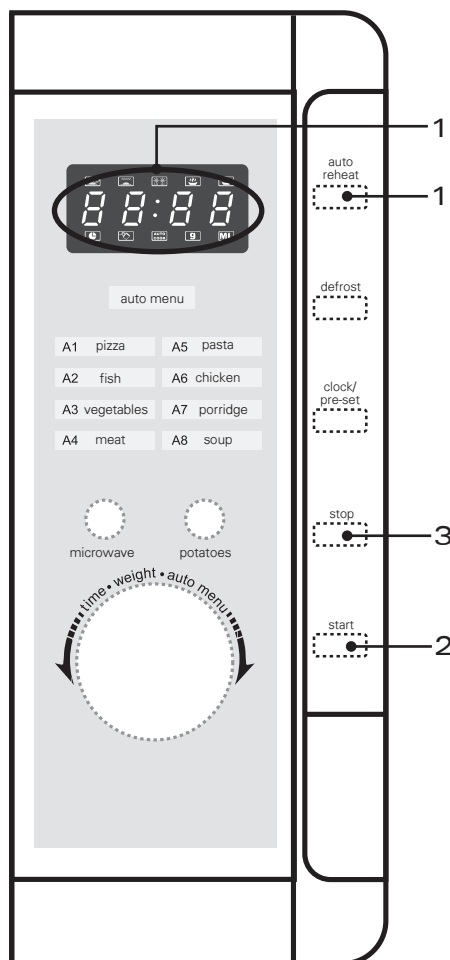

defrosting

This feature allows you to defrost your frozen foods simply by entering the weight or time. You may wish to place the frozen food on a microwave safe plate or dish before placing it on the defrost rack. This is to ensure that any liquids released during defrosting will not spill and dirty the interior of the oven.

defrost by weight

1. Press **stop** button once to clear any previous program setting.
2. Press the **defrost** button once and the LED display will show **DEF1**.
3. Turn the **time/weight/auto menu** dial to adjust the weight of your food. The default range is 100g to 2000g.
4. Press the **start** button to start defrosting.

TIPS: Large items may be frozen in the centre. Therefore, to ensure even thawing, turn them over from time to time and break them into smaller pieces during defrosting. You will need to press the **stop** button once to hold the defrosting program and open the oven door. After you rotate the food, you need to press the **start** button to re-start defrosting.

Place roasts fat-side down or whole poultry breast-side down.

Drain liquids during defrosting as the juices from food can get hot and cook the food.

5. Press the **stop** button to stop defrosting or cancel the setting.

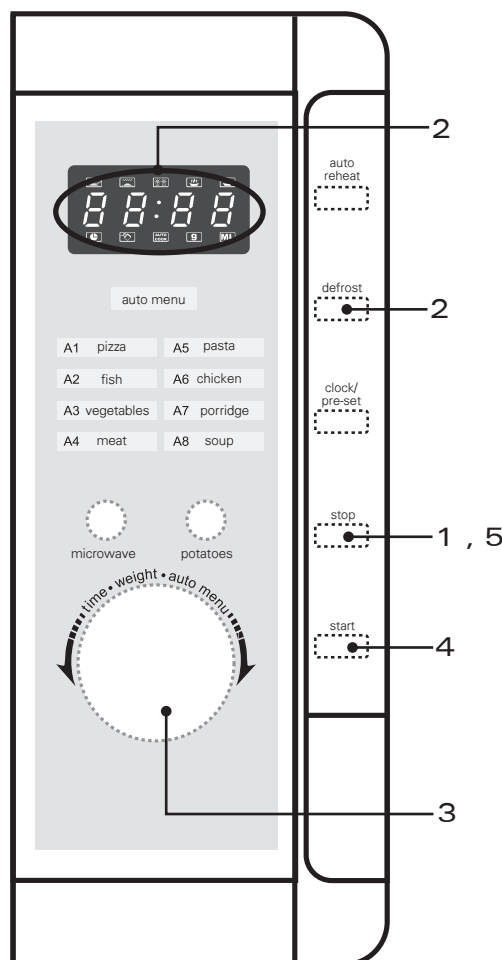

operating instructions

defrost by time

1. Press the **defrost** button twice and the LED display will show **DEF2**.
2. Turn the **time/weight/auto menu** dial to set the defrosting leadtime.

NOTE: The maximum setting time is 95 minutes.

3. Press the **start** button to start defrosting.
4. Press the **stop** button to stop defrosting or cancel the setting.

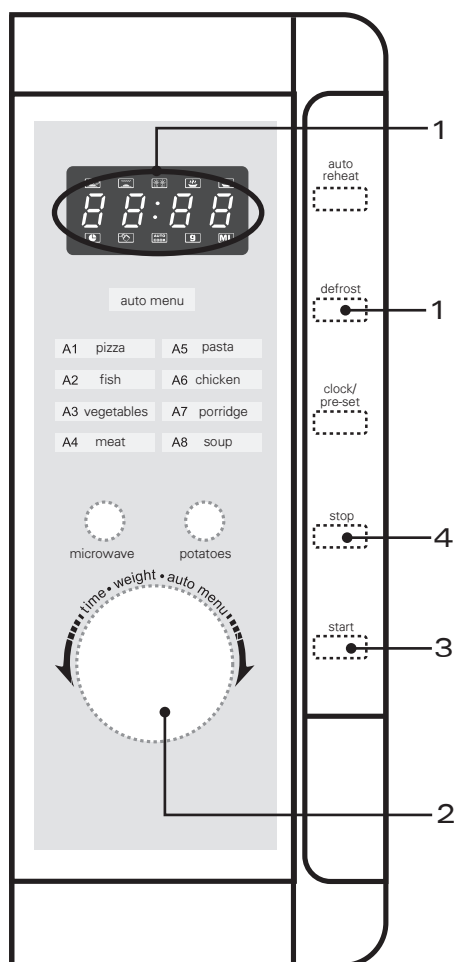

querying the cooking function

This feature allows you to check and view the current power, time, and pre-set time of your selected cooking program.

to find out the current cooking power

1. Press the **microwave** button once and the LED display will show the current cooking power. It will last for 2 - 3 seconds and the oven will then return to its original display.

to find out the time

2. Press the **clock/pre-set** button once and the LED display will show the time while the oven is in the cooking state. It will last for 2 - 3 seconds and the oven will then return to its original display.

to find out the pre-set time

3. While the oven is still at the pre-set state, press the **clock/pre-set** button once and the LED display will show the pre-set time. It will last for 2 - 3 seconds and the oven will then return its original display.

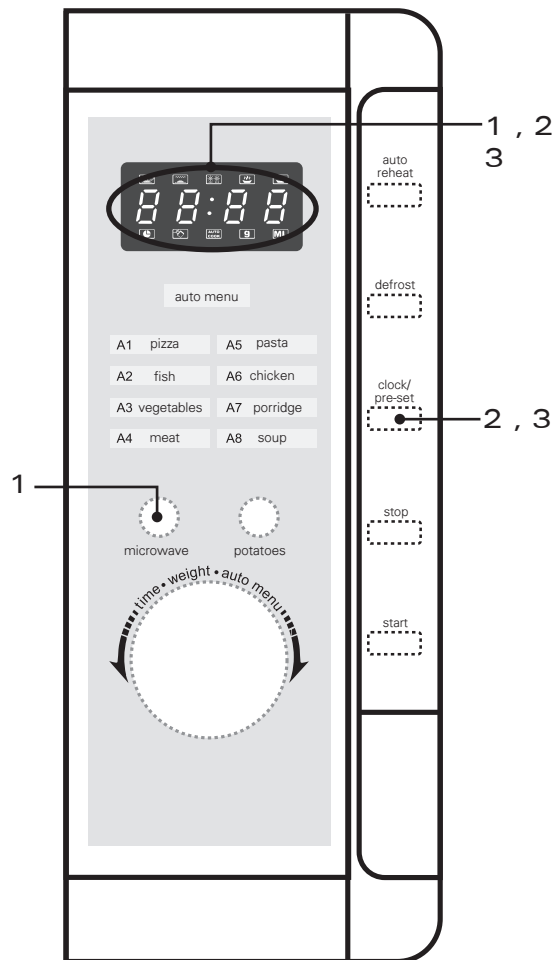

operating instructions

Cleaning your

*Cleaning your oven each time you use it will help to prevent
Unplug your microwave from the mains and wait for the
On the right hand side wall of the cavity is the wave guide cover,
It is important that this wave guide cover is kept clean at all times.*

The oven walls have a special enamel coating which makes cleaning very easy. Use a soft damp cloth to wipe off any splashes or a paper towel to mop up any spills. Wipe off grease with a damp cloth and a little detergent. Dry thoroughly. As with any oven, if grease is left to accumulate, it can smoke and even catch fire.

Make sure you keep the outlet grids clean.

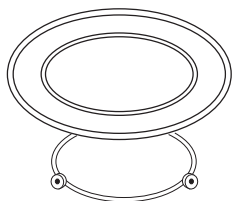

Treat the glass turntable as you would any glass plate. After you have used it for more than 15 minutes, allow it to cool down before you use it again. Do not wash the turntable in very hot water, this could crack it.

Make sure the turntable is dry before you put it back in the oven.

Wash the turntable ring in warm water. Do not use very hot water which could make it warp.

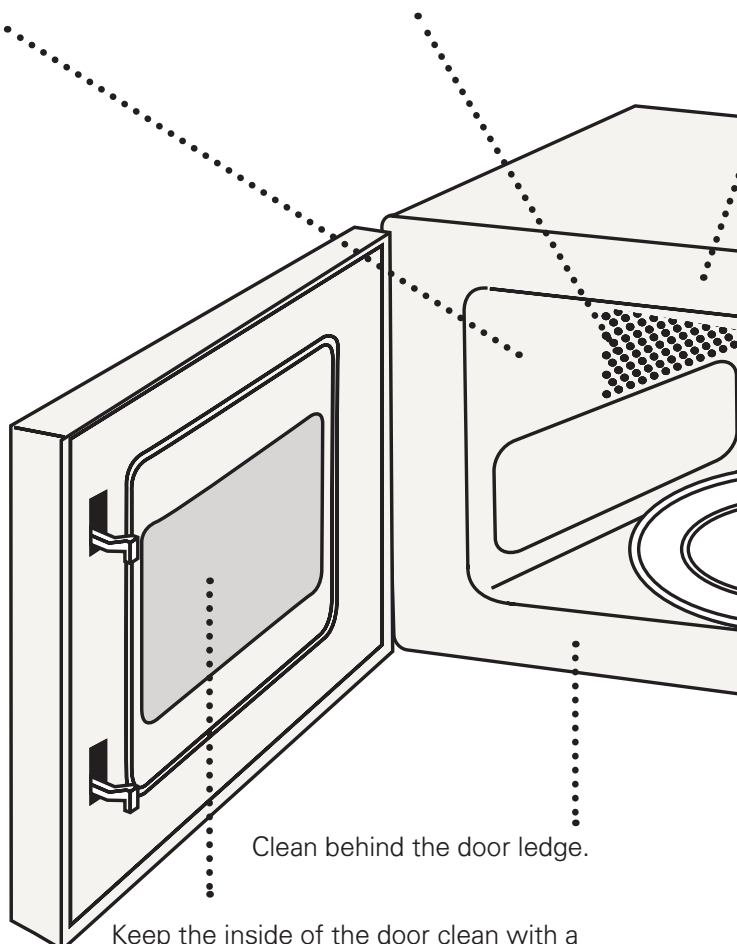

Clean behind the door ledge.

Keep the inside of the door clean with a damp cloth. Use warm soapy water for stubborn marks and dry thoroughly. The inside of the door has a special coating and must not be cleaned with abrasive pads or cleaning powders.

microwave

*a build up of stubborn marks that can be difficult to clean.
oven to cool down completely before cleaning.
microwaves are passed through this to enable your food to cook.
Wipe it with mild detergent and water and leave to dry.*

Be careful not to spill water into the vents.

Keep the front of the oven clean so that the door can close properly.



Do not remove wave guide cover: It is important to keep the cover clean in the same manner as the inside of the oven. If grease is left to accumulate, it can smoke and even catch fire.

Unplug the oven before cleaning the power lead and the oven. Wipe with a damp cloth and leave to dry before plugging it back in.

Use warm soapy water to clean the outside of the oven. Do not use abrasive pads or powders that could scratch the surface.

NOTE: Do not remove any fixed parts from the inside of your microwave oven during cleaning or at any other time.

care, maintenance and troubleshooting

GB-31

troubleshooting

If you have a problem that cannot be answered by these points, please contact your nearest store. Please note: If you call our service agency out to your home and the product is found not to be faulty, or the instruction book has not been followed, our product guarantee is not applicable and a call-out fee will be charged.

questions and answers

Q. *Why doesn't the food seem to cook?*

A. Check that:

- the cooking time has been set
- the door is closed
- the power socket is not overloaded causing the fuse to blow.

Q. *Why does the food seem undercooked or overcooked?*

A. Check that:

- the correct cooking time has been set
- the correct power setting has been used.

Q. *How can I stop eggs from popping?*

A. When you cook or poach eggs in the microwave, the yolk can sometimes pop as steam builds up inside it. You can stop the egg from popping by piercing the yolk with a toothpick before cooking.

Never cook eggs that are still in their shells.

Q. *Why is it so important that I allow standing time after cooking?*

A. With microwave cooking, many foods build up enough heat inside them to continue cooking even after they've been taken out of the oven. Because microwave cooking works from the outside of food inwards, standing time lets you cook the centre of the food just right without the outside being overcooked.

Q. *Why does my oven sometimes take longer to cook than it says in the recipe?*

A. First check that the oven was set as per the recipe. Cooking times and heat settings are suggestions to help prevent overcooking but differences in the weight, size, shape and starting temperature of food will all affect how long it takes to cook – just as it does with a conventional oven. Use your judgement along with the recipe to check whether food has been cooked properly.

Q. *Why do I get condensation on the inside of the oven door?*

A. Condensation is perfectly normal, especially when you are cooking food with a high moisture content such as potatoes.

Q. *Does the microwave energy get through the window on the door?*

A. No. The door has a special metal screen with holes in that lets you see inside but stops microwave energy from getting out.

Q. *Steam comes out of the side of the door and vents. Can microwave energy get out too?*

A. No. The door and vents are carefully designed to let steam out during cooking but keep microwave energy in. The gaps are not big enough for microwave energy to escape.

questions and answers

Q. What happens if the microwave is switched on while the oven is empty?

A. The microwave will be damaged. Do not switch the microwave on when there is nothing inside the oven. It is a good idea to keep a cup of water in the oven just in case someone accidentally starts the microwave.

Q. Why doesn't the oven light illuminate?

A. Open the door. If the light does not illuminate, the bulb has probably blown. Call a qualified technician – do not try to change the bulb yourself.

Q. There are sparks inside the oven when I use the microwave. Will this cause any damage?

A. Yes. Make sure that you are not using any metal utensils and that your containers don't have a metal trim. You must not use metal in your microwave, except foil, when you cook.

Q. Light is showing through the vents and door. Does this mean the microwave energy can escape?

A. No. It is normal for the light to be visible and is nothing to be concerned about.

Q. Why do I get interference on my TV and radio when I use the microwave?

A. Microwave ovens use radio waves similar to those received by TVs and radios. You can lessen the interference by moving your microwave further away from the TV or radio.

specification

Input	230 - 240V ~50Hz
Output	750 - 800 Watts
Microwave Frequency	2450MHz
Outside Dimensions	461mm x 359mm x 280mm (width x deep x height)
Power consumption	
Microwave	1300 - 1400 Watts

Complies with EEC directives 89/336/EEC and 92/31/EEC.
Because we continually strive to improve our products, we may change specifications without prior notice. The highest quality requirements are placed on our appliances. However, should a malfunction occur for which you cannot find any information in the operating instructions, please contact the store where you purchased your appliance.



IMPORTANT INFORMATION FOR CORRECT DISPOSAL OF THE PRODUCT IN ACCORDANCE WITH EC DIRECTIVE 2002/96/EC.

At the end of its working life, the product must not be disposed of as urban waste.

It must be taken to a special local authority differentiated waste collection centre or to a dealer providing this service.

Disposing of a household appliance separately avoids possible negative consequences for the environment and health deriving from an inappropriate disposal and enables the constituent materials to be recovered to obtain significant savings in energy and resources. As a reminder of the need to dispose of household appliances separately, the product is marked with a crossed-out wheeled dustbin.



Visit Partmaster.co.uk today for the easiest way to buy electrical spares and accessories. With over 1 million spares and accessories available we can deliver direct to your door the very next day.

Visit www.partmaster.co.uk

or call

0870 6001 338

(UK customers only)

Calls charged at National Rate.

NOTE: If you require a replacement for any of the items listed below, please quote their corresponding part numbers:

Replacement Part	Part Number
glass turntable	252100500496
turntable ring	252200200011
instruction manual	261800303068



**DSG Retail Limited is responsible for after sales services.
If you have a query about the product please contact our product support line
0844 561 6263 (Currys) and 08700 118 117 (Pixmania).**

DSG Retail · 200 The Campus · Marylands Avenue ·
Hemel Hempstead · Herts · HP2 7TG

GB-34





Free Manuals Download Website

<http://myh66.com>

<http://usermanuals.us>

<http://www.somanuals.com>

<http://www.4manuals.cc>

<http://www.manual-lib.com>

<http://www.404manual.com>

<http://www.luxmanual.com>

<http://aubethermostatmanual.com>

Golf course search by state

<http://golfingnear.com>

Email search by domain

<http://emailbydomain.com>

Auto manuals search

<http://auto.somanuals.com>

TV manuals search

<http://tv.somanuals.com>