

KENWOOD

KDC-V7521
KDC-B7021
KDC-7021

CD-RECEIVER
INSTRUCTION MANUAL

KENWOOD CORPORATION



© B64-2145-00 (E2W)



Contents

Safety precautions	3	CD/External disc control features	17	Tuning Mode	
About RDS	5	Playing CD		Auto Memory Entry	
About CDs	6	Playing External Disc		AF (Alternative Frequency)	
General features	7	Fast Forwarding and Reversing		Restricting RDS Region (Region Restrict Function)	
Power		Track Search		Auto TP Seek	
Volume		Album Search		Monaural Reception	
Attenuator		Direct Track Search		Text Scroll	
Selecting the Source		Direct Album Search		Power OFF Timer	
Loudness		Track/Album Repeat		Basic Operations of remote	28
System Q		Track Scan		Loading and Replacing the battery	
Audio Control		Random Play		Basic operations	
Speaker Setting		Magazine Random Play		In Tuner source	
Switching Display		Disc Naming (DNPS)		In Disc source	
Switching Clock Display		Text/Title Scroll		Accessories	30
Auxiliary Input Display Setting		DNPP (Disc Name Preset Play)		Installation Procedure	30
Faceplate Angle Adjustment		Menu system	21	Connecting Cables to Terminals	31
Theft Deterrent Faceplate		Menu System		Installtion	32
Hiding the Control Panel		Mask Key		Removing the Unit	33
TEL Mute		Touch Sensor Tone		Locking the faceplate to the unit	33
Tuner features	12	Manual Clock Adjustment		Troubleshooting Guide	34
Tuning		Synchronize Clock		Specifications	38
Direct Access Tuning		Selectable Illumination			
Station Preset Memory		Switching Graphic Display			
Auto Memory Entry		Illumination Color Setting			
Preset Tuning		Contrast Adjustment			
RDS features	14	Dimmer			
Traffic Information		OFF Wait Time Setting			
Presetting Volume for Traffic Information		System Q			
PTY (Program Type)		B.M.S. (Bass Management System)			
Program Type preset		News Bulletin with Timeout Setting			
Changing Language for PTY Function		Local Seek			

Safety precautions

▲WARNING

To prevent injury and/or fire, take the following precautions:

- Insert the unit all the way until it is fully locked in place. Otherwise it may fly out of place during collisions and other jolts.
- When extending the ignition, battery or ground wires, make sure to use automotive-grade wires or other wires with an area of 0.75mm² (AWG18) or more to prevent wire deterioration and damage to the wire coating.
- To prevent short circuits, never put or leave any metallic objects (e.g., coins or metal tools) inside the unit.
- If the unit starts to emit smoke or strange smells, turn off the power immediately and consult your Kenwood dealer.
- Make sure not to get your fingers caught between the faceplate and the unit.
- Be careful not to drop the unit or subject it to strong shock.
The unit may break or crack because it contains glass parts.
- Do not touch the liquid crystal fluid if the LCD is damaged or broken due to shock. The liquid crystal fluid may be dangerous to your health or even fatal.
If the liquid crystal fluid from the LCD contacts your body or clothing, wash it off with soap immediately.

▲CAUTION

To prevent damage to the machine, take the following precautions:

- Make sure to ground the unit to a negative 12V DC power supply.
- Do not open the top or bottom covers of the unit.
- Do not install the unit in a spot exposed to direct sunlight or excessive heat or humidity. Also avoid places with too much dust or the possibility of water splashing.
- Do not subject the faceplate to excessive shock, as it is a piece of precision equipment.
- When replacing a fuse, only use a new one with the prescribed rating. Using a fuse with the wrong rating may cause your unit to malfunction.
- To prevent short circuits when replacing a fuse, first disconnect the wiring harness.
- Do not place any object between the faceplate and the unit.
- During installation, do not use any screws except for the ones provided. The use of improper screws might result in damage to the main unit.
- Do not apply excessive force to the moving faceplate. Doing so will cause damage or malfunction.
- Do not apply excessive force to the open faceplate or place objects on it. Doing so will cause damage or breakdown.

IMPORTANT INFORMATION

About the disc changer to be connected:

To connect a disc changer having the "O-N" switch to this unit, set the "O-N" switch to "N". When you connect a model with no "O-N" switch, the converter cord CA-DS100 available as an option may be required. For details, consult your Kenwood dealer.

A disc changer doesn't work when it is connected without using these options. If a model with no "O-N" switch is connected, some unavailable functions and information that cannot be displayed are generated. Note that none of the KDC-C100, KDC-C302, C205, C705, and non-Kenwood CD changers can be connected.



You can damage both your unit and the CD changer if you connect them incorrectly.

Do Not Load 8-cm (3-in.) CDs in the CD slot

If you try to load an 8-cm CD with its adapter into the unit, the adapter might separate from the CD and damage the unit.

Safety precautions

NOTE

- If you experience problems during installation, consult your Kenwood dealer.
- If the unit fails to operate properly, press the Reset button. The unit returns to factory settings when the Reset button is pressed. After you press the reset button, the Mask Key will be needed to restart the unit. If the unit still fails to operate properly after the Reset button has been pressed, contact your local KENWOOD dealer for assistance.
- Press the reset button if the Disc auto changer fails to operate correctly. Normal operation should be restored.

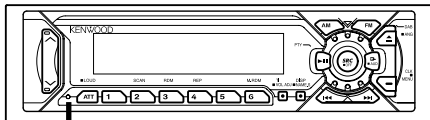

Reset button

- Characters in the LCD may become difficult to read in temperatures below 41 °F (5 °C).
- If you send products in for repair that include a mask key, make sure to present the unit together with the mask key.

- The illustrations of the display and the panel appearing in this manual are examples used to explain more clearly how the controls are used. Therefore, what appears on the display in the illustrations may differ from what appears on the display on the actual equipment, and some of the illustrations on the display may represent something impossible in actual operation.

When using the unit for the first time

In order to deactivate the demonstration mode. Transmit the Mask Key's signal. (page 22)

Lens Fogging

Right after you turn on the car heater in cold weather, dew or condensation may form on the lens in the CD player of the unit. Called lens fogging, CDs may be impossible to play. In such a situation, remove the disc and wait for the condensation to evaporate. If the unit still does not operate normally after a while, consult your Kenwood dealer.

Cleaning the Faceplate Terminals

If the terminals on the unit or faceplate get dirty, wipe them with a dry, soft cloth.

Cleaning the Unit

If the faceplate of this unit is stained, wipe it with a dry soft cloth such as a silicon cloth. If the faceplate is stained badly, wipe the stain off with a cloth moistened with neutral cleaner, then wipe neutral detergent off.



Applying spray cleaner directly to the unit may affect its mechanical parts. Wiping the faceplate with a hard cloth or using a volatile liquid such as thinner or alcohol may scratch the surface or erase characters.

Cleaning the CD Slot

As dust can accumulate in the CD slot, clean it occasionally. Your CDs can get scratched if you put them in a dusty CD slot.

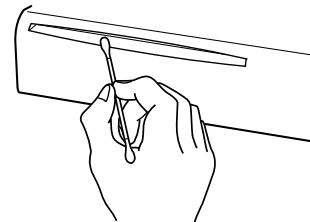

***The marking of products using lasers
(Except for some areas)***

**CLASS 1
LASER PRODUCT**

The label is attached to the chassis/case and says that the component uses laser beams that have been classified as Class 1. It means that the unit is utilizing laser beams that are of a weaker class. There is no danger of hazardous radiation outside the unit.

About RDS

RDS (Radio Data System)

When listening to an RDS station, the program service name of the station is displayed, advising you quickly which station is being received.

RDS (Radio Data System) stations also transmit alternative frequency data for the same station. When you are making long trips, this function automatically switches to the particular frequency with the best reception for the particular network of stations that you want to listen to. The data is automatically stored, allowing you to switch quickly to another RDS stations, broadcasting the same program, that has better reception. These include stations stored in the station preset memory that you often listen to.

Enhanced Other Network

Stations that offer <Enhanced Other Network> also transmit information about other RDS stations that have traffic information. When you are tuned to a station that is not transmitting traffic information, but another RDS station starts transmitting a traffic bulletin, the tuner automatically switches to the other station for the duration of the bulletin.

Alarm

When an emergency transmission (announcing disasters, etc.) is sent, all current functions are interrupted to allow the warning to be received.

About CDs

Handling CDs

- Don't touch the recording surface of the CD.

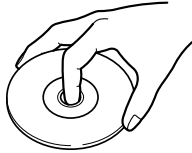

- CD-R and CD-RW are easier to damage than a normal music CD. Use a CD-R or a CD-RW after reading the caution items on the package etc.
- Don't stick tape etc. on the CD. Also, don't use a CD with tape stuck on it.

When using a new CD

If the CD center hole or outside rim has burrs, use it after removing them with a ball pen etc.

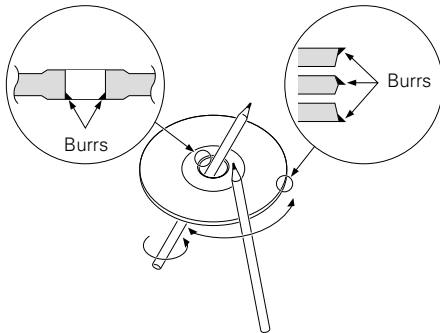

CD accessories

Don't use disc type accessories.

CD cleaning

Clean from the center of the disc and move outward.

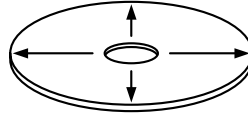



Removing CDs

When removing CDs from this unit pull them out horizontally.

CDs that can't be used

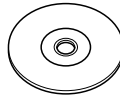
- CDs that aren't round can't be used.



- CDs with coloring on the recording surface or that are dirty can't be used.
 - Don't use CDs without disc mark
- 
- A CD-R or CD-RW that hasn't been finalized can't be played. (For the finalization process refer to your CD-R/CD-RW writing software, and your CD-R/CD-RW recorder instruction manual.)

CD storage

- Don't place them in direct sunlight (On the seat or dashboard etc.) and where the temperature is high.
- Store CDs in their cases.

General features

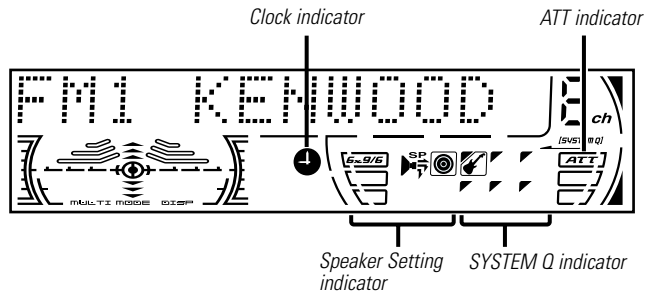
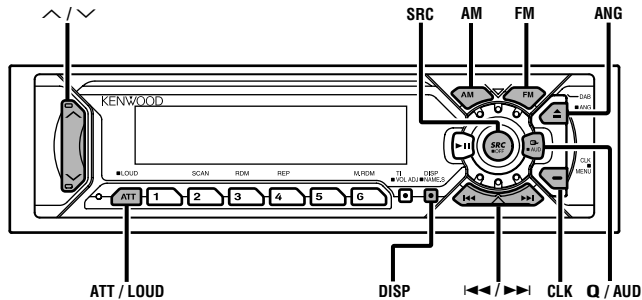

Power

Turning ON the Power

Turn the vehicle ignition ON.
The faceplate reverses and control panel is displayed.

Turning OFF the Power

Turn the vehicle ignition OFF.
When the set time for removing the faceplate (page 24) lapses, the faceplate reverses and the control panel is hidden.

⚠ Do not apply force to the faceplate during operation. It can cause damage.

💬 The first time the unit is used it is necessary to cancel the Demonstration mode with the Mask key (page 22). If the Demonstration mode isn't canceled, the unit can't be used normally.

Volume

Increasing Volume

Press the [^] button.

Decreasing Volume

Press the [v] button.

Attenuator

Turning the volume down quickly.

Press the [ATT] button.

Each time the button is pressed the Attenuator turns ON or OFF. When it's ON, the "ATT" indicator blinks.

General features

Selecting the Source

Press the [SRC] button.

Source required	Display
Tuner	"TUNER"
CD	"CD"
External disc	"DISC"/"CD2"
Auxiliary input	"AUX"
Standby (Illumination only mode)	"ALL OFF"



- For Auxiliary input one of the below optional accessories is necessary.
 - KCA-S210A
 - CA-C1AX
 - CD changer with an Auxiliary input function installed.
- This unit automatically turns full power OFF after 20 minutes lapses in Standby mode in order to save the vehicles battery. The time until full power OFF can be set in <Power OFF Timer> (page 27).

Loudness

Compensating for low and high tones during low volume.

Press the [LOUD] button for at least 1 second.

Each time the button is pressed for at least 1 second the Loudness turns ON or OFF.

When it's ON, "LOUD ON" is displayed.

System Q

You can recall the best sound setting preset for different types of the music.

1 Select the source to set

Press the [SRC] button.

2 Select the Sound type

Press the [Q] button.

Each time the button is pressed the sound setting switches.

Sound setting	Display
Flat	"Flat"
Rock	"Rock"
Top 40	"Top 40"
Pops	"Pops"
Jazz	"Jazz"
Easy	"Easy"
Scan of Flat — Easy	"Scan"
User memory	"User"



- User memory: The values set on the <Audio control> (page 9).
- Each setting value is changed with the <Speaker setting> (page 9).
First, select the speaker type with the Speaker setting.

Audio Control

1 Select the source for adjustment

Press the [SRC] button.

2 Enter Audio Control mode

Press the [AUD] button for at least 1 second.

3 Select the Audio item for adjustment

Press the [FM] or [AM] button.

Each time the button is pressed the items that can be adjusted switch as shown below.

4 Adjust the Audio item

Press the [◀◀] or [▶▶] button.

Adjustment Item	Display	Range
Bass Center Frequency	"Bass F"	60/70/80/100 or 150 Hz
Bass level	"Bass"	-8 — +8
Bass Q Factor	"Bass Q"	1.00/1.25/1.50/2.00
Bass Extend	"Bass EXT"	ON/OFF
Middle Center Frequency	"MID F"	0.5/1.0/1.5/2.0 kHz
Middle level	"Middle"	-8 — +8
Middle Q Factor	"Middle Q"	1.0/2.0
Treble Center Frequency	"TRE F"	10.0/12.5/15.0/17.5 kHz
Treble level	"Treble"	-8 — +8
Balance	"Balance"	Left 15 — Right 15
Fader	"Fader"	Rear 15 — Front 15
Volume offset	"V Offset"	-8 — ±0



- According to the Bass Q Factor setting value, the frequencies that can be set in Bass Center Frequency change as shown below.

Bass Q Factor	Bass Center Frequency
1.00/1.25/1.50	60/70/80/100
2.00	60/70/80/150

- When the Bass Extend is set to ON, low frequency response is extended by 20%.
- Volume offset: Each source's volume can be set as a difference from the basic volume.

5 Exit Audio Control mode

Press the [AUD] button.

Speaker Setting

Fine-tuning so that the System Q value is optimal when setting the speaker type.

1 Enter Standby

Press the [SRC] button.

Select the "ALL OFF" display.

2 Enter Speaker Setting mode

Press the [Q] button.

3 Select the Speaker type

Press the [◀◀] or [▶▶] button.

Each time the button is pressed the setting switches as shown below.

Speaker type	Display
OFF	"SP OFF"
For 6 & 6x9 in. speaker	"SP 6*9/6inch"
For 5 & 4 in. speaker	"SP 5/4inch"
For the OEM speaker	"SP O.E.M."

4 Exit Speaker Setting mode

Press the [Q] button.

General features

Switching Display

Switching the information displayed.

Press the [DISP] button.

Each time the button is pressed the display switches as shown below.

In Tuner source

Information	Display
Program Service name or Frequency	
Radio text	"R-TEXT"

Displaying the frequency during Program Service name reception

Press the [DISP] button for at least 1 second.

The frequency for the RDS station will be displayed for 5 seconds instead of the station name.

In CD & External disc source

Information	Display
Track Time	
Disc name	"DNPS"
Disc title (In External disc source)	"D-TITLE"
Track title (In External disc source)	"T-TITLE"

Switching Clock Display

Switching the displayed information.

Press the [CLK] button.

Each time the button is pressed it switches between clock display and current source.

During clock display the clock indicator is ON.

Auxiliary Input Display Setting

Selecting the display when this device is switched to Auxiliary input source.

1 Select Auxiliary input source

Press the [SRC] button.

Select the "AUX" display.

2 Enter Auxiliary input display setting mode

Press the [DISP] button for at least 2 seconds.

The presently selected AUX Name is displayed.

3 Select the Auxiliary input display

Press the [◀◀] or [▶▶] button.

Each time the button is pressed it switches through the below displays.

- "AUX"
- "TV"
- "VCP"
- "GAME"
- "PORTABLE"

4 Exit Auxiliary input display setting mode

Press the [DISP] button.



When operation stops for 10 seconds, the name at that time is selected, and Auxiliary input display setting mode closes.

Faceplate Angle Adjustment

Press the [ANG] button for at least 1 second.



Do not apply excessive force to the faceplate. It can cause damage.

Theft Deterrent Faceplate

The faceplate of the unit can be detached and taken with you, helping to deter theft.

Removing the Faceplate

- 1 Turn the ignition OFF or press the [SRC] button for at least 1 second.
The power turns OFF and the faceplate slides open.
- 2 Holding the center part of the faceplate pull it out.

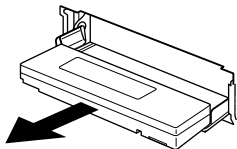

-  When the faceplate is kept remove open, according to the <OFF Wait Time Setting> (page 24) setting, the faceplate is hidden and the power turns OFF.
- The faceplate is a precision piece of equipment and can be damaged by shocks or jolts. For that reason, keep the faceplate in its special storage case while detached.
- Do not expose the faceplate or its storage case to direct sunlight or excessive heat or humidity. Also avoid places with too much dust or the possibility of water splashing.

Reattaching the Faceplate

- 1 Set the left side of the faceplate in the faceplate bracket.

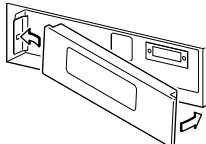

- 2 Press the right side of the faceplate until it locks.

Hiding the Control Panel

Prevents tampering with the unit while your car is being serviced etc.

Hiding the control panel

Press the [SRC] button for at least 1 second.

The faceplate slides open.

When the time set in <OFF Wait Time Setting> (page 24) lapses, the faceplate is hidden and the power turns OFF.

Showing the control panel

Press the left part at the upper side of the faceplate.

The faceplate will open and show the control panel.

TEL Mute

The audio system automatically mutes when a call comes in.

When a call comes in

"CALL" is displayed.

The audio system pauses.

Listening to the audio during a call

Press the [SRC] button.

The "CALL" display disappears and the audio system comes back ON.

When the call ends

Hang up the phone.

The "CALL" display disappears and the audio system comes back ON.

Tuner features

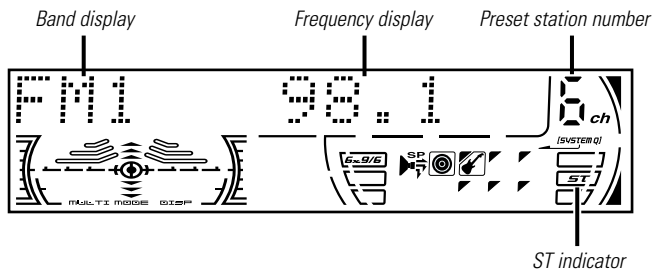
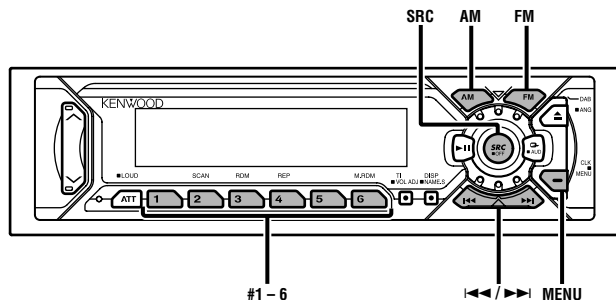

Tuning

Selecting the station.

1 Select tuner source

Press the [SRC] button.
Select the "TUNER" display.

2 Select the band

Press the [FM] or [AM] button.
Each time the [FM] button is pressed it switches between the FM1, FM2, and FM3 bands.

3 Tune up or down band

Press the [◀◀] or [▶▶] button.



During reception of stereo stations the "ST" indicator is ON.

Direct Access Tuning (Function of remote)

Entering the frequency and tuning.

1 Select the band

Press the [FM] or [AM] button.

2 Enter Direct Access Tuning mode

Press the [DIRECT] button on the remote.
The "----" display.

3 Enter the frequency

Press the number buttons on the remote.
Example:

Desired frequency	Press button
92.1 MHz (FM)	[#0], [#9], [#2], [#1]
810 kHz (AM)	[#0], [#8], [#1], [#0]

Canceling Direct Access Tuning

Press the [DIRECT] button on the remote.

Station Preset Memory

Putting the station in the memory.

1 Select the band

Press the [FM] or [AM] button.

2 Select the frequency to put in the memory

Press the [◀◀] or [▶▶] button.

3 Put the frequency in the memory

Press the [#1] — [#6] button for at least 2 seconds.

The preset number display blinks 1 time.

On each band, 1 station can be put in the memory on each [#1]

— [#6] button.

- When Auto Memory Entry is done in the FM2 band, the RDS stations preset in the FM1 band aren't put in the memory. Likewise, when it is done in the FM3 band, RDS stations preset in FM1 or FM2 aren't put in the memory.

Auto Memory Entry

Putting a station with good reception in the memory automatically.

1 Select the band for Auto Memory Entry

Press the [FM] or [AM] button.

2 Enter Menu mode

Press the [MENU] button for at least 1 second.

"MENU" is displayed.

3 Select the Auto Memory Entry mode

Press the [FM] or [AM] button.

Select the "Auto-Memory" display.

4 Open Auto Memory Entry

Press the [◀◀] or [▶▶] button for at least 2 seconds.

When 6 stations that can be received are put in the memory

Auto Memory Entry closes.



- When the <AF Function> (page 26) is ON, only RDS stations are put in the memory.

Preset Tuning

Calling up the stations in the memory.

1 Select the band

Press the [FM] or [AM] button.

2 Call up the station

Press the [#1] — [#6] button.

RDS features

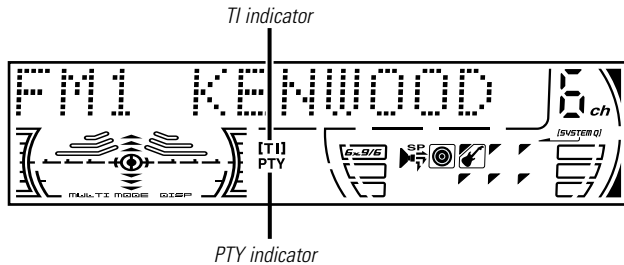
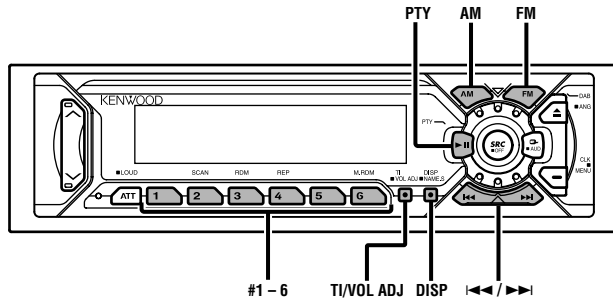

Traffic Information

Switching to traffic information automatically when a traffic bulletin starts even when you aren't listening to the radio.

Press the [TI] button.

Each time the button is pressed the Traffic Information function turns ON or OFF.

When it's ON, "TI" indicator is ON.

When a traffic information station isn't being received the "TI" indicator blinks.

When a traffic bulletin starts, "Traffic Info" is displayed it and it switches to traffic information.

 During reception of a AM station when the Traffic Information function is turned ON, it switches to a FM station.

Receiving other traffic information stations

Press the [◀◀] or [▶▶] button.

 Traffic information station switching can be done when listening to the radio.

Presetting Volume for Traffic Information

Setting the volume during Traffic Information.

1 Receive the station.

2 Set the volume you want.

3 Preset the volume

Press the [VOL ADJ] button for at least 2 seconds.

The volume level display blinks 1 time.

PTY (Program Type)

Selecting the Program Type and searching for a station.

1 Enter PTY mode

Press the [PTY] button.

During PTY mode the "PTY" indicator is ON.

 This function can't be used during a traffic bulletin or AM reception.

2 Select the Program Type

Press the [FM] or [AM] button.

Each time the button is pressed the Program Type switches as shown below.

No.	Program Type	Display
1.	Speech	"Speech"
2.	Music	"Music"
3.	News	"News"
4.	Current Affairs	"Affairs"
5.	Information	"Info"
6.	Sport	"Sport"
7.	Education	"Educate"
8.	Drama	"Drama"
9.	Culture	"Culture"
10.	Science	"Science"
11.	Varied	"Varied"
12.	Pop Music	"Pop M"
13.	Rock Music	"Rock M"
14.	Easy Listening Music	"Easy M"
15.	Light Classical	"Light M"
16.	Serious Classical	"Classics"
17.	Other Music	"Other M"
18.	Weather	"Weather"
19.	Finance	"Finance"
20.	Children's programs	"Children"

21.	Social Affairs	"Social"
22.	Religion	"Religion"
23.	Phone In	"Phone In"
24.	Travel	"Travel"
25.	Leisure	"Leisure"
26.	Jazz Music	"Jazz"
27.	Country Music	"Country"
28.	National Music	"Nation M"
29.	Oldies Music	"Oldies"
30.	Folk Music	"Folk M"
31.	Documentary	"Document"

-  • Speech and Music include the Program type shown below.
Music: No.12 — 17, 26 — 30
Speech: No.3 — 11, 18 — 25, 31
- The Program Type can be put in the [#1] — [#6] button memory and called up quickly. Refer to the <Program Type preset> (page 16).
 - The display language can be changed. Refer to <Changing Language for PTY Function> (page 16).

3 Search for the selected Program Type station

Press the [◀◀] or [▶▶] button.

When you want to search for other stations press the [◀◀] or [▶▶] button again.

-  When the selected Program Type isn't found, "NO PTY" is displayed. Select another Program Type.

4 Exit PTY mode

Press the [PTY] button.

RDS features

Program Type preset

Putting the Program Type in the Preset button memory and calling it up quickly.

Presetting the Program Type

1 Select the Program Type to preset

Refer to <PTY(Program Type)> (page 15).

2 Preset the Program Type

Press the [#1] — [#6] button for at least 2 seconds.

Calling up the preset Program Type

1 Enter PTY mode

Refer to <PTY(Program Type)> (page 15).

2 Call up the Program Type

Press the [#1] — [#6] button.

Changing Language for PTY Function

Selecting the Program Type display language.

1 Enter PTY mode

Refer to <PTY (Program Type)> (page 15).

2 Enter Changing Language mode

Press the [DISP] button.

3 Select the language

Press the [FM] or [AM] button.

Each time the button is pressed the language switches as shown below.

Language	Display
English	"English"
Spanish	"Spanish"
French	"French"
Dutch	"Dutch"
Norwegian	"Norwegian"
Portuguese	"Portuguese"
Swedish	"Swedish"
German	"German"

4 Exit Changing Language mode

Press the [DISP] button.

CD/External disc control features

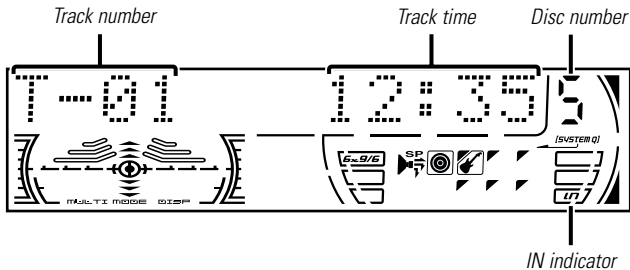
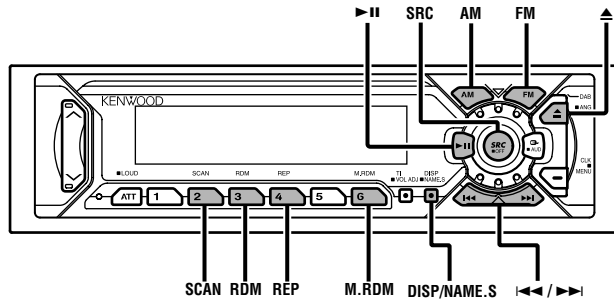

Playing CD

When a CD isn't inserted

1 Slide open the faceplate

Press the [▲] button.

2 Insert a CD.

⚠ When the faceplate has been slid open, it might interfere with the shift lever or something else. If this happens, pay attention to safety and move the shift lever or take an appropriate action, then operate the unit.

- The sound will be temporarily muted while the faceplate is moving.
- When a CD is inserted, the "IN" indicator is ON.

When a CD is inserted

Press the [SRC] button.

Select the "CD" display.

Pause and play

Press the [▶||] button.

Each time the button is pressed the CD pauses and plays.

Eject the CD

1 Eject the CD

Press the [▲] button.

2 Close the faceplate

Press the [▲] button.

⚠ 3 in. (8cm) CD cannot be played. Using an adapter and inserting them into this unit can cause damage.

CD/External disc control features

Playing External Disc

Playing discs set in the optional accessory disc player connected to this unit.

Press the [SRC] button.

Select the display for the disc player you want.

Display examples:

Display	Disc player
"CD2"	CD player
"DISC"	CD changer/MD changer

Pause and play

Press the [▶||] button.

Each time the button is pressed it pauses and plays.



- Disc #10 is displayed as "0".
- The functions that can be used and the information that can be displayed will differ depending on the external disc players being connected.

Fast Forwarding and Reversing

Fast Forwarding

Hold down on the [▶▶] button.

Release your finger to play the disc at that point.

Reversing

Hold down on the [◀◀] button.

Release your finger to play the disc at that point.

Track Search

Selecting the song you want to hear.

Press the [◀◀] or [▶▶] button.

Album Search (Function of disc changer)

Selecting the disc you want to hear.

Press the [AM] or [FM] button.

Direct Track Search (Function of remote)

Doing Track Search by entering the track number.

1 Enter the track number

Press the number buttons on the remote.

2 Do Track Search

Press the [◀◀] or [▶▶] button.

Canceling Direct Track Search

Press the [▶||] button.

Direct Album Search (Function of disc changers with remote)

Doing Disc Search by entering the disc number.

1 Enter the disc number

Press the number buttons on the remote.

2 Do Album Search

Press the [DISC+] or [DISC-] button.

Canceling Direct Album Search

Press the [▶||] button.

 Input "0" to select disc 10.

Track/Album Repeat

Replaying the track/disc you're listening to.

Press the [REP] button.

Each time the button is pressed the Repeat Play switches as shown below.

Repeat play	Display
Track Repeat	"Repeat ON"/"T-Repeat ON"
Album Repeat (Function of disc changer)	"D-Repeat ON"
OFF	"Repeat OFF"

Track Scan

Playing the first part of each song on the disc you are listening to and searching for the song you want to listen to.

1 Start Track Scan

Press the [SCAN] button.

"Scan ON" is displayed.

2 Release it when the song you want to listen to is played

Press the [SCAN] button.

Random Play

Playing all the songs on the disc in random order.

Press the [RDM] button.

Each time the button is pressed Random Play turns ON or OFF.

When it's ON, "Random ON" is displayed.

 When the [▶▶||] button is pressed, the next song select starts.

Magazine Random Play (Function of disc changer)

Play the songs on all the discs in the disc changer in random order.

Press the [M.RDM] button.

Each time the button is pressed the Magazine Random Play turns ON or OFF.

When it's ON, "M.Random ON" is displayed.

 When the [▶▶||] button is pressed, the next song select starts.

CD/External disc control features

Disc Naming (DNPS)

Attaching a title to a CD.

1 Play the disc you want to attach a name to

- A title can't be attached to a MD.
- Disc Naming can't be done during CD text display.

2 Enter name set mode

Press the [NAME.S] button for at least 2 seconds.
"NAME SET" is displayed.

3 Move the cursor to the enter character position

Press the [◀◀] or [▶▶] button.

4 Select the character type

Press the [▶II] button.

Each time the button is pressed the character typed switches as shown below.

Character type

Alphabet upper case

Alphabet lower case

Numbers and symbols

Special characters (Accent characters)

5 Select the characters

Press the [FM] or [AM] button.

- Characters can be entered by using a remote with a number button.
Example: If "DANCE" is entered.

Character	Button	#Times pressed
"D"	[#3]	1
"A"	[#2]	1
"N"	[#6]	2
"C"	[#2]	3
"E"	[#3]	2

6 Repeat steps 3 through 5 and enter the name.

7 Exit name set mode

Press the [NAME.S] button.



- When operation stops for 10 seconds the name at that time is registered, and Name Set mode closes.
- Media that you can attach names to
 - Internal CD player: 30 discs.
 - External CD changer/ player: Varies according to the CD changer/ player. Refer to the CD changer/ player manual.
- The name of a CD can be changed by the same operation you used to name it.

Text/Title Scroll

Scrolling the displayed CD text or MD title.

Press the [DISP] button for at least 1 second.

Menu system

DNPP (Disc Name Preset Play) (Function of Remote)

Selecting the CD displayed in the DNPS of the CDs set in the Disc changer.

1 Enter DNPP mode

Press the [DNPP] button on the remote.

When "DNPP" is displayed the DNPS display in order.

Forward / Reverse display

Press the [DISC-] or [DISC+] button.

2 When the disc you want is displayed

Press the [OK] button on the remote.

The disc being displayed is played.

Canceling the DNPP mode

Press the [DNPP] button on the remote.

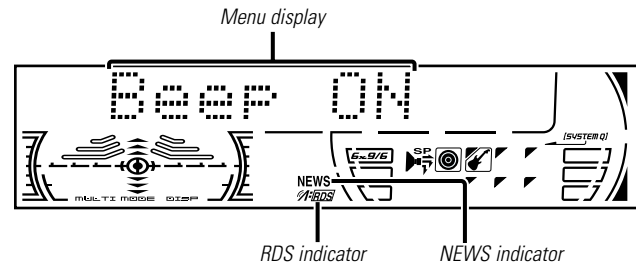
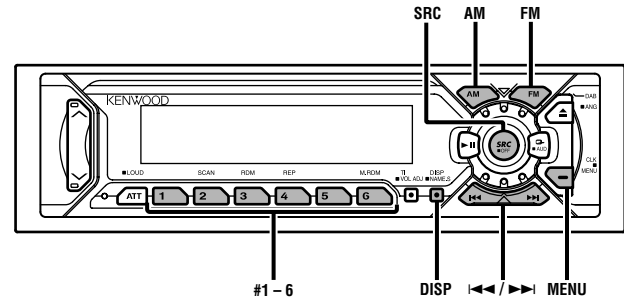

Menu system

Menu System

Setting during operation beep sound etc. functions. The Menu system basic operation method is explained here. The reference for the Menu items and their setting content is after this operation explanation.

1 Enter Menu mode

Press the [MENU] button for at least 1 second.
"MENU" is displayed.

2 Select the menu item

Press the [FM] or [AM] button.
Example: When you want to set the beep sound select the "Beep" display.

3 Set the menu item

Press the [◀◀] or [▶▶] button.
Example: When "Beep" is selected, each time the button is pressed it switches "Beep ON" or "Beep OFF". Select 1 of them as the setting.

You can continue by returning to step 2 and setting other items.

4 Exit Menu mode

Press the [MENU] button.



When other items that are applicable to the basic operation method above are displayed afterwards their setting content chart is entered. (Normally the uppermost setting in the chart is the original setting.)

Also, the explanation for items that aren't applicable (<Manual Clock Adjustment>etc.) are entered step by step.

Mask Key

Because authorization by the Mask Key is required when it's removed from the vehicle, personalizing this unit by using the

Mask Key is a help in preventing theft.

1 Enter Standby

Press the [SRC] button.
Select the "ALL OFF" display.

2 Enter Menu mode

Press the [MENU] button for at least 1 second.
When "MENU" is displayed, "Mask key" is displayed.

3 Enter Mask key mode

Press the [◀◀] or [▶▶] button for at least 1 second.
"TRANSMIT 1" is displayed.

4 Enter the Mask Key's signal

Hold down the transmit button on the Mask Key until the full transmit level indicator lights up in the display.
"TRANSMIT 2" is displayed.

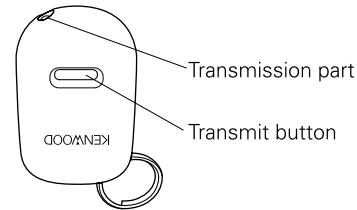

- Keep the Mask Key close to the signal sensor when you transmit the Mask Key's signal.
- If the Mask Key's signal does not be received correctly, the display will return to "TRANSMIT 1". In this case, repeat the procedure in step 4.

5 Reenter the Mask Key's signal

Hold down the transmit button on the Mask Key until the full transmit level indicator lights up in the display.
"APPROVED" is displayed, and the Mask Key function activates.

Press the Reset button and when it's removed from the battery power source

1 Turn the power ON

The vehicle engine turns ON.
"TRANSMIT 1" is displayed.

2 Enter the Mask Key's signal

Repeat steps 4 and 5 above, and enter the Mask Key's signal.
"APPROVED" is displayed.
The unit can be used.

Touch Sensor Tone

Setting the operation check sound (beep sound) ON/OFF.

Display	Setting
"Beep ON"	Beep is heard.
"Beep OFF"	Beep canceled.

Manual Clock Adjustment

 This adjustment can be done when the <Synchronize Clock> (page 23) is set as OFF.

1 Select Clock Adjustment mode

Press the [FM] or [AM] button.
Select the "Clock Adjust" display.

2 Enter Clock Adjust mode

Press the [◀◀] or [▶▶] button for at least 1 second.
The clock display blinks.

3 Adjust the hours

Press the [FM] or [AM] button.

Adjust the minutes

Press the [◀◀] or [▶▶] button.

4 Exit Clock adjustment mode

Press the [MENU] button.

Synchronize Clock

Synchronizing the RDS station time data and this unit's clock.

Display	Setting
"SYNC ON"	Synchronizes the time.
"SYNC OFF"	Adjust the time manually.



It takes 3 to 4 minutes to synchronize the clock.

Selectable Illumination

Selecting the button illumination color as green or red.

Display	Setting
"Button Green"	The illumination color is green.
"Button Red"	The illumination color is red.

Switching Graphic Display

Setting the graphic part display ON/OFF.

Display	Setting
"Graphic ON"	The graphic part is displayed.
"Graphic OFF"	The graphic part isn't displayed.

Menu system

Function of the KDC-V7521

Illumination Color Setting

You can set the display to a desired color.

1 Select Illumination Color Setting Mode

Press the [FM] or [AM] button.

Select the "COL" display.

2 The color continues to change gradually

Continue pressing the [◀◀] or [▶▶] button.

Release your finger at the color you want.

Quick call up the preset color

Press the [#1] — [#4] button.

Button	Color
[#1]	Silky White
[#2]	Red
[#3]	Blue
[#4]	Blue Green

Selecting the Color mode

Press the [#6] button.

Each time the button is pressed the Color mode switches as shown below.

Display	Color mode
"Scan"	The color changes in sequence.
"SRC"	The color changes according to the selected source.
"Time"	The color changes every six hours.
	Keeps the presently set color.

Blue fine adjustment

1 Press the [#3] button for at least 2 seconds.

2 Press the [◀◀] or [▶▶] button.

When the blue fine adjustment is completed, press the [#3] button.

The set color memory

Press the [#5] button for at least 2 seconds.

When the setting in the memory is called up press the [#5] button.

 The blue fine adjustment setting cannot be stored in memory.

Contrast Adjustment

Adjusting the display contrast.

Display and Setting

"Contrast 0"	
:	
"Contrast 5" (Original setting)	
:	
"Contrast 10"	

Dimmer

Dimming this unit's display automatically when the vehicle light switch is turned ON.

Display	Setting
"Dimmer ON"	The display dims.
"Dimmer OFF"	The display doesn't dim.

OFF Wait Time Setting

Setting the time until the faceplate hide operation starts after the

power is turned OFF.

The faceplate can be removed only during the set time period.

Display and Setting

"Off Wait 0s"

⋮

"Off Wait 3s" (Original setting)

⋮

"Off Wait 25s"

System Q

Setting display/don't display for the System Q factors (Bass center frequency, Bass Q factor, Bass extend, Middle center frequency, Middle Q factor, and Treble center frequency) in Audio control.

Display Setting

"System Q ON" The System Q factors are displayed.

"System Q OFF" The System Q factors aren't displayed.

B.M.S. (Bass Management System)

Adjust the bass boost level of the external amplifier using the main unit.

Display Setting

"AMP Bass FLT" Bass boost level is flat.

"AMP Bass +6" Bass boost level is low (+6dB).

"AMP Bass +12" Bass boost level is high (+12dB).



Refer to the catalog or instruction manual for power amplifiers that can be controlled from this unit.

News Bulletin with Timeout Setting

It switches automatically when a news bulletin starts even if the radio isn't being listened to. Also, the time interval when interrupt is prohibited can be set.

Display and Setting

"News OFF"

"News 00min"

⋮

"News 90min"

When "News 00min" — "News 90min" is set, the News Bulletin Interrupt function is ON.

When it's ON, the "NEWS" indicator is ON.

When the news bulletin starts, "News" is displayed, and it switches to the news bulletin.



- If you choose the "20min" setting, further news bulletins will not be received for 20 minutes once the first news bulletin is received.
- The news bulletin volume is the same level that was set for traffic information (page 14).
- This function is only available if the desired station sends PTY-code for news bulletin or belongs to <Enhanced Other Network>-Network sending PTY-code for news bulletin.
- When the News Bulletin Interrupt function is ON, it switches to an FM station.

Menu system

Local Seek <In Tuner mode>

Only stations whose reception is good are searched for in auto seek tuning.

Display	Setting
"Local.S OFF"	The local seek function is OFF.
"Local.S ON"	The local seek function is ON.

Tuning Mode <In Tuner mode>

Sets the tuning mode.

Tuning mode	Display	Operation
Auto seek	"Auto1"	Automatic search for a station.
Preset station seek	"Auto2"	Search in order of the stations in the Preset memory.
Manual	"Manual"	Normal manual tuning control.

Auto Memory Entry <In Tuner mode>

For the operation method refer to <Auto Memory Entry> (13page).

AF (Alternative Frequency)

When poor reception is experienced, automatically switch to another frequency broadcasting the same program in the same RDS network with better reception.

Display	Setting
"AF ON"	The AF function is ON.
"AF OFF"	The AF function is OFF.

When the AF function is ON, the "RDS" indicator is ON.



When no other stations with stronger reception are available for the same program in the RDS network, you may hear the incoming broadcast in bits and snatches. Turn OFF the AF function in such a case.

Restricting RDS Region (Region Restrict Function)

You can choose whether or not to restrict the RDS channels, received with the AF function for a particular network, to a specific region.

Display	Setting
"Regional ON"	The Region Restrict Function is ON.
"Regional OFF"	The Region Restrict Function is OFF.



Sometimes stations in the same network broadcast different programs or use different program service names.

Auto TP Seek

When the TI function is ON and poor reception conditions are experienced when listening to a traffic information station, another traffic information station with better reception will be searched for automatically.

Display	Setting
"ATPS ON"	The Auto TP Seek Function is ON.
"ATPS OFF"	The Auto TP Seek Function is OFF.

Monaural Reception <In FM reception>

Noise can be reduced when stereo broadcasts are received as monaural.

Display	Setting
"MONO OFF"	The monaural reception is OFF.
"MONO ON"	The monaural reception is ON.

Text Scroll <In Tuner/External disc control mode>

Setting the displayed text scroll.

Display	Setting
"Scroll MANU"	Doesn't scroll.
"Scroll Auto"	Scrolls when the display changes.



The text scrolled is shown below.

- CD text
- MD title
- Radio text

Power OFF Timer

Setting the timer to turn this unit's power OFF automatically when Standby mode continues.

Using this setting can save the vehicle's battery power.

Display	Setting
"OFF ----"	Power OFF Timer function is OFF.
"OFF 20min" (Original setting)	Turns the power OFF after 20 minutes.
"OFF 40min"	Turns the power OFF after 40 minutes.
"OFF 60min"	Turns the power OFF after 60 minutes.

Basic Operations of remote

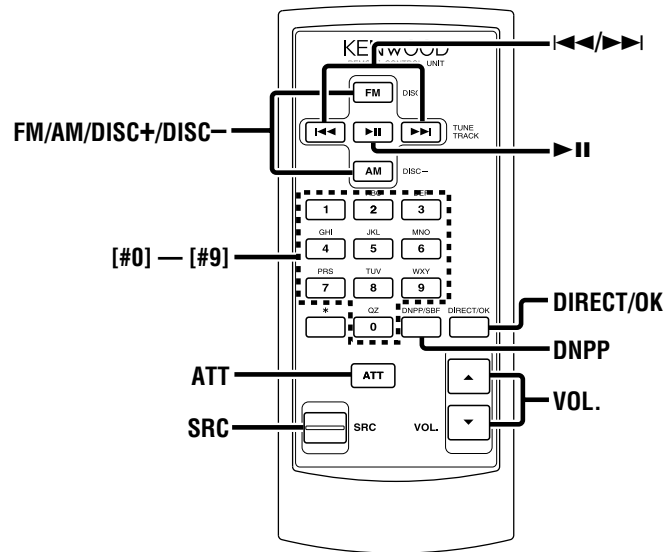

Loading and Replacing the battery

Use one lithium battery (CR2025). Insert the batteries with the + and - poles aligned properly, following the illustration inside the case.

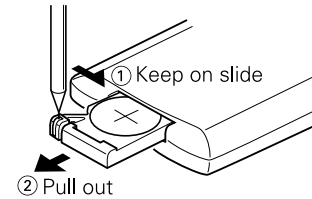

⚠ WARNING

Store unused batteries out of the reach of children. Contact a doctor immediately if the battery is accidentally swallowed.

⚠ Do not set the remote on hot places such as above the dashboard.

Basic operations

[VOL.] buttons

Adjusting the volume.

[SRC] button

Each time the button is pressed the source switches. For the source switching order refer to <Selecting the Source> (page 8).

[ATT] button

Turning the volume down quickly. When it is pressed again it returns to the previous level.

In Tuner source

[FM]/ [AM] buttons

Select the band.

Each time the [FM] button is pressed it switches between the FM1, FM2, and FM3 bands.

[◀◀]/ [▶▶] buttons

Tune up or down band.

[#0] — [#9] buttons

Press buttons [#1] — [#6] to recall preset stations.

[DIRECT] button

Enters and cancels the <Direct Access Tuning> (page 12) mode.

[▶ II] button

Enters and cancels the <PTY (Program Type)> (page 15) mode.

In Disc source

[◀◀]/ [▶▶] buttons

Doing track forward and backward.

[DISC+]/ [DISC-] buttons

Doing album forward and backward.

[▶ II] button

Each time the button is pressed the song pauses and plays.

[DNPP]/ [OK] button



Enters and cancels the <DNPP (Disc Name Preset Play)> (page 21) mode.

[#0] — [#9] buttons

When in <Direct Track Search> (page 18) and <Direct Album Search> (page 18), enter the track/disc number.

Accessories

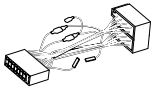
External view

- Number of items
- ① 1
- ② 2
- ③ 1

External view

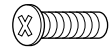
- Number of items
- ④ 1
- ⑤ 1



The use of any accessories except for those provided might result in damage to the unit. Make sure only to use the accessories shipped with the unit, as shown above.

Installation Procedure

- To prevent short circuits, remove the key from the ignition and disconnect the \ominus terminal of the battery.
- Make the proper input and output wire connections for each unit.
- Connect the wire on the wiring harness.
- Take Connector B on the wiring harness and connect it to the speaker connector in your vehicle.
- Take Connector A on the wiring harness and connect it to the external power connector on your vehicle.
- Connect the wiring harness connector to the unit.
- Install the unit in your car.
- Reconnect the \ominus terminal of the battery.
- Press the left part at the upper side of the faceplate once to make the faceplate control panel appear.

▲CAUTION

- If your car is not prepared for this special connection-system, consult your KENWOOD dealer.
- Only use antenna conversion adapters (ISO-JASO) when the antenna cord has an ISO plug.
- Make sure that all wire connections are securely made by inserting jacks until they lock completely.
- If your vehicle's ignition does not have an ACC position, or if the ignition wire is connected to a power source with constant voltage such as a battery wire, the power will not be linked with the ignition (i.e., it will not turn on and off along with the ignition). If you want to link the unit's power with the ignition, connect the ignition wire to a power source that can be turned on and off with the ignition key.
- If the fuse blows, first make sure that the wires have not caused a short circuit, then replace the old fuse with one with the same rating.
- Insulate unconnected wires with vinyl tape or other similar material. To prevent short circuits, also do not remove the caps on the ends of the unconnected wires or the terminals.
- Connect the speaker wires correctly to the terminals to which they correspond. The unit may receive damage or fail to work if you share the \ominus wires and/or ground them to any metal part in the car.
- After the unit is installed, check whether the brake lamps, indicators, wipers, etc. on the car are working properly.
- If the console has a lid, make sure to install the unit so that the faceplate does not hit the lid when closing and opening.
- Mount the unit so that the mounting angle is 30° or less.

Connecting Cables to Terminals

Connector Function Guide		
Pin Numbers for ISO Connectors	Cable Colour	Functions
External Power Connector		
A-4	Yellow	Battery
A-5	Blue/White	Power Control
A-6	Orange/White	Dimmer
A-7	Red	Ignition (ACC)
A-8	Black	Earth (Ground) Connection
Speaker Connector		
B-1	Purple	Rear Right (+)
B-2	Purple/Black	Rear Right (-)
B-3	Gray	Front Right (+)
B-4	Gray/Black	Front Right (-)
B-5	White	Front Left (+)
B-6	White/Black	Front Left (-)
B-7	Green	Rear Left (+)
B-8	Green/Black	Rear Left (-)

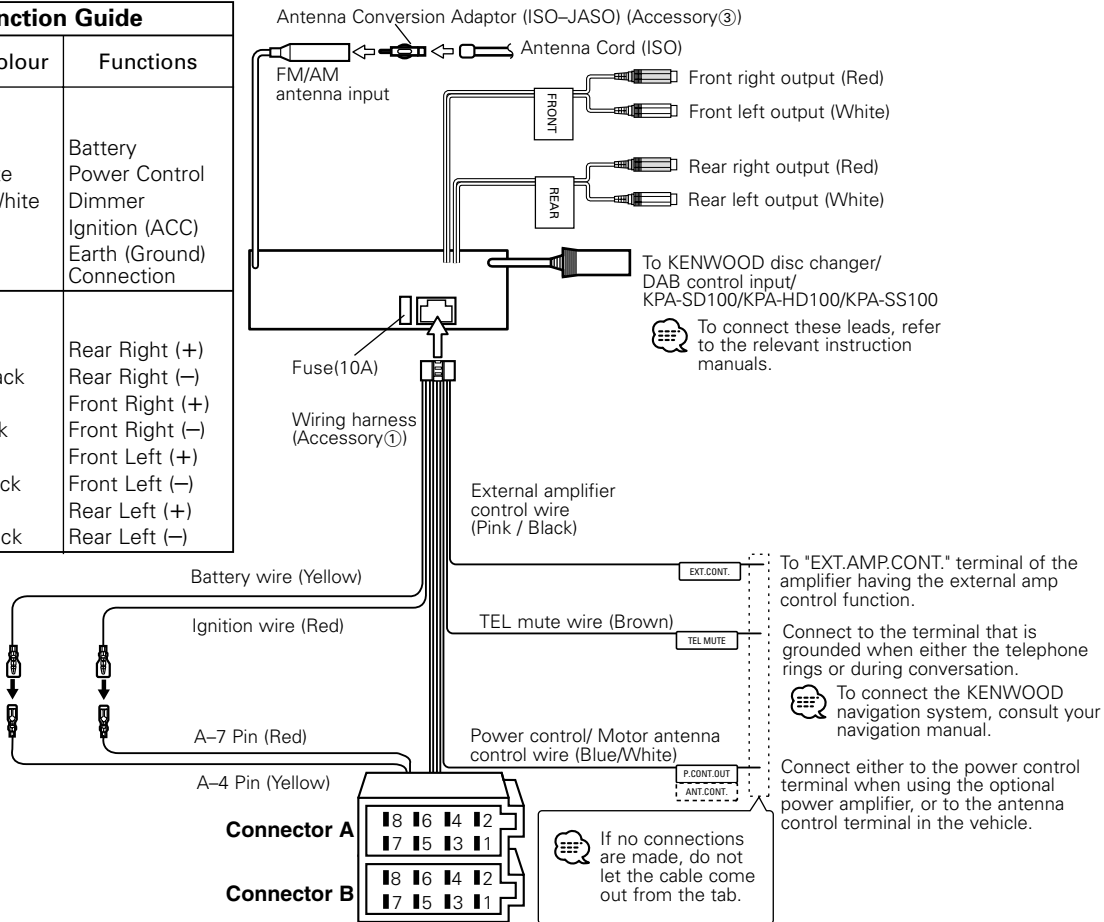

Connecting Cables to Terminals

⚠ WARNING Connecting the ISO Connector (see p.31)

The pin arrangement for the ISO connectors depends on the type of vehicle you drive. Make sure to make the proper connections to prevent damage to the unit.

The default connection for the wiring harness is described in **1** below. If the ISO connector pins are set as described in **2** or **3**, make the connection as illustrated.

- 1** (Default setting) The A-7 pin (red) of the vehicle's ISO connector is linked with the ignition, and the A-4 pin (yellow) is connected to the constant power supply.

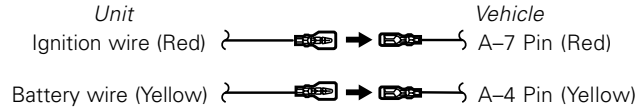

- 2** The A-7 pin (red) of the vehicle's ISO connector is connected to the constant power supply, and the A-4 pin (yellow) is linked to the ignition.

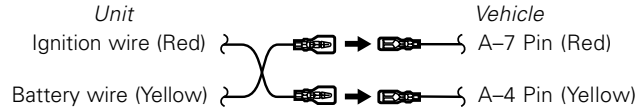

- 3** The A-4 pin (yellow) of the vehicle's ISO connector is not connected to anything, whilst the A-7 pin (red) is connected to the constant power supply (or both the A-7 (red) and A-4 (yellow) pins are connected to the constant power supply).

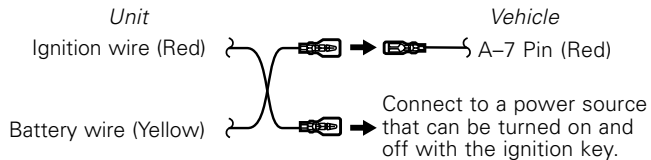

Installation

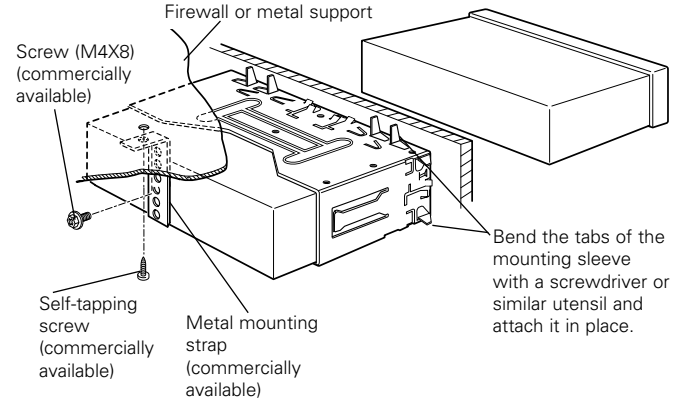

- ⓘ** Make sure that the unit is installed securely in place. If the unit is unstable, it may malfunction (eg, the sound may skip).

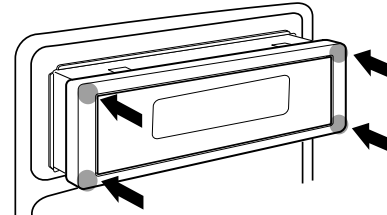

- ⚠** To attach this unit, make sure the front of the control panel faces you and fit it into the mounting sleeve by pressing the four corners of the hard rubber frame at the same time. Do not apply strong pressure to other sections than the corners; otherwise troubles such as the impossibility of opening or closing the panel may result.

Removing the Unit

- 1 Insert the removal tool into the indentations in the hard rubber frame, and pull it gently until the lock is released.

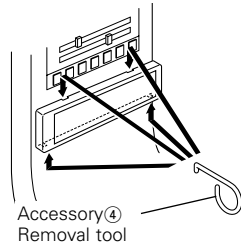

- 2 Remove the screw (M4x8) on the back panel.
- 3 Insert the two removal tools deeply into the slots on each side, as shown.

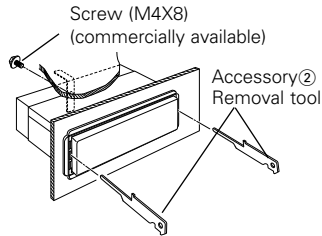

- 4 Push upward the removal tool toward the top, and pull out the unit halfway while pressing towards the inside.

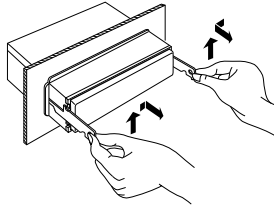

 Be careful to avoid injury from the catch pins on the removal tool.

- 5 Pull the unit all the way out with your hands, being careful not to drop it.

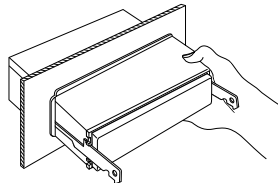

Locking the faceplate to the unit

If you want to lock the faceplate to the unit so that it does not fall off, follow the directions below.

- 1 Refer to the function "Removing the faceplate" (page 11) and remove the faceplate.
- 2 Insert the provided screw into the hole at the center of the bottom side of the faceplate which you have removed from the unit.

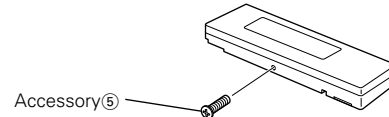

- 3 Refer to the section "Removing the faceplate" (page 11) and then reattaching the faceplate.

 Never insert the tapite screws (ø2 X 4 mm) in any other screw holes than the one specified. If you insert it in another hole, it will contract and may cause damage to the mechanical parts inside the unit.

Troubleshooting Guide

What might seem to be a malfunction in your unit may just be the result of slight misoperation or miswiring. Before calling service, first check the following table for possible problems.

General

? The power does not turn ON.

- ✓ The fuse has blown.
 - ☞ After checking for short circuits in the wires, replace the fuse with one with the same rating.
- ✓ No ACC position on vehicle ignition.
 - ☞ Connect the same wire to the ignition as the battery wire.

? If you have selected Standby mode, the power will go OFF automatically.

- ✓ The Power OFF Timer function has been activated.
 - ☞ If you do not want the power to go OFF automatically, cancel the Power OFF Timer function.

? Nothing happens when the buttons are pressed.

- ✓ The computer chip in the unit is not functioning normally.
 - ☞ Press the reset button on the unit (page 4).

? There's a source you can't switch.

- ✓ There's no CD inserted.
 - ☞ Set the media you want to listen to. If there's no media in this unit, you can't switch to each source.
- ✓ The Disc changer isn't connected.
 - ☞ Connect the Disc changer. If the Disc changer isn't connected to it's input terminal, You can't switch to an external disc source.

? The faceplate does not open or close.

- ✓ The faceplate is incorrectly attached.
 - ☞ Reattach the faceplate correctly, See the section on <Removing the Faceplate>(page 11).

? The memory is erased when the ignition is turned OFF.

- ✓ The battery wire has not been connected to the proper terminal.
 - ☞ Connect the wire correctly, referring to the section on <Connecting Wires to Terminals>.
- ✓ The ignition and battery wire are incorrectly connected.
 - ☞ Connect the wire correctly, referring to the section on <Connecting Wires to Terminals>.

? The TEL mute function does not work.

- ✓ The TEL mute wire is not connected properly.
 - ☞ Connect the wire correctly, referring to the section on <Connecting Wires to Terminals>.

? The TEL mute function turns ON even though the TEL mute wire is not connected.

- ✓ The TEL mute wire is touching a metal part of the car.
 - ☞ Pull the TEL mute wire away from the metal part of the car.

? Even if Loudness is turned ON, high-pitched tone isn't compensated for.

- ✓ Tuner source is selected.
 - ☞ High-pitched tone isn't compensated for when in Tuner source.

? The Bass center frequency, Bass quality factor, Bass extend, Middle center frequency, Middle quality factor, and Treble center frequency can't be adjusted.

- ✓ The <System Q> (page 25) is set OFF.
 - ☞ Set it ON.

? No sound can be heard, or the volume is low.

- ✓ The fader or balance settings are set all the way to one side.
 - ☞ Center the fader and balance settings.
- ✓ The input/output wires or wiring harness are connected incorrectly.
 - ☞ Reconnect the input/output wires or the wiring harness correctly. See the section on <Connecting Wires to Terminals>.
- ✓ The values of Volume offset are low.
 - ☞ Increase the values of Volume offset. (page 9)

? **The sound quality is poor or distorted.**

- ✓ One of the speaker wires is being pinched by a screw in the car.
 - ☞ Check the speaker wiring.
 - ✓ The speakers are not wired correctly.
 - ☞ Reconnect the speaker wires so that each output terminal is connected to a different speaker.
-

? **The Mask Key item isn't displayed in the Menu System.**

- ✓ The Mask Key function is already activated.
 - ☞ When the Mask Key function is activated it isn't displayed in the menu items.
-

? **The Touch Sensor Tone doesn't sound.**

- ✓ The preout jack is being used.
 - ☞ The Touch Sensor Tone can't be output from the preout jack.
-

? **Even though Synchronize Clock is ON, the clock can't be adjusted.**

- ✓ The received RDS station isn't sending time data.
 - ☞ Receive another RDS station.
-

? **Even though the vehicle light switch is turned ON, the unit's display won't dim.**

- ✓ The dimmer wire isn't connected.
 - ☞ Connect the dimmer wire correctly.
-

? **The display color changes subtly.**

- ✓ This is because the temperature is different than the temperature when the setting was done.
 - ☞ The display color condition changes subtly according to the ambient temperature.
-

Tuner source

? **Radio reception is poor.**

- ✓ The car antenna is not extended.
 - ☞ Pull the antenna out all the way.
 - ✓ The antenna control wire is not connected.
 - ☞ Connect the wire correctly, referring to the section on <Connecting Wires to Terminals>.
-

? **The desired frequency can't be entered with the Direct Access Tuning.**

- ✓ A station that can't be received is being entered.
 - ☞ Enter a station that can be received.
 - ✓ You're trying to enter a frequency with a 0.01 MHz unit.
 - ☞ What can be designated in the FM band is to 0.1 MHz.
-

? **It isn't the set Traffic information sound volume.**

- ✓ The set sound volume is less than the tuner sound volume.
 - ☞ If the tuner sound volume is louder than the set sound volume, the tuner sound volume is used.
-

Troubleshooting Guide

Disc source

? "AUX" is displayed without achieving External disc control mode.

- ✓ O-N switch is set to "O" side.
 - ☞ Set the switch to "N" side.
- ✓ Unsupported disc changer is connected.
 - ☞ Connect the supported disc changer. (page 3)

? The specified disc does not play, but another one plays instead.

- ✓ The specified CD is quite dirty.
 - ☞ Clean the CD.
- ✓ The CD is upside-down.
 - ☞ Load the CD with the labeled side up.
- ✓ The disc is loaded in a different slot from that specified.
 - ☞ Eject the disc magazine and check the number for the specified disc.
- ✓ The disc is severely scratched.
 - ☞ Try another disc instead.

? The specified track will not play.

- ✓ Random play or magazine random play has been selected.
 - ☞ Turn off random play or magazine random play.

? Track repeat, disc repeat, track scan, random play, and magazine random play start by themselves.

- ✓ The setting is not canceled.
 - ☞ The settings for these functions remain on until the setting is off or the disc is ejected, even if the power is turned off or the source is changed.

? Cannot play CD-R or CD-RW.

- ✓ Finalization processing is not being conducted for CD-R/CD-RW.
 - ☞ Conduct finalization processing with CD recorder.
- ✓ A non-compatible CD changer is being used to play the CD-R/CD-RW.
 - ☞ Use a CD changer compatible with CD-R/CD-RW to play.

? A CD ejects as soon as it is loaded.

- ✓ The CD is upside-down.
 - ☞ Load the CD with the labeled side up.

- ✓ The CD is quite dirty.
 - ☞ Clean the CD, referring to the section on <CD cleaning> (page 6).

? Can't remove disc.

- ✓ The cause is that more than 10 minutes has elapsed since the vehicle ACC switch was turned OFF.
 - ☞ The disc can only be removed within 10 minutes of the ACC switch being turned OFF. If more than 10 minutes has elapsed, turn the ACC switch ON again and press the Eject button.

? The disc won't insert.

- ✓ There's already another disc inserted.
 - ☞ Press the [▲] button and remove the disc.

? Direct Track Search and Direct Album Search can't be done.

- ✓ Another function is ON.
 - ☞ Turn Random Play or other functions OFF.

? Track Search can't be done.

- ✓ For the albums first or last song.
 - ☞ For each album, Track Search can't be done in the backward direction for the first song or in the forward direction for the last song.

If the following situations, consult your nearest service center:

- Even though the disc changer is connected, the Disc Changer source is not ON, with "AUX" showing in the display during the Changer Mode.
- Even though no device (KCA-S210A, CA-C1AX, KDC-CPS87, KDC-CX87, KDC-CPS85, KDC-CX85, KDC-CPS82 or KDC-CX82) is connected, the Auxiliary input is entered when switching modes.

The messages shown below display your systems condition.

Eject: No disc magazine has been loaded in the changer.
The disc magazine is not completely loaded.
⇨ Load the disc magazine properly.
No CD in the unit.
⇨ Insert the CD.

No Disc: No disc has been loaded in the disc magazine.
⇨ Load a disc into the disc magazine.

TOC Error: No disc has been loaded in the disc magazine.
⇨ Load a disc into the disc magazine.
The CD is quite dirty. The CD is upside-down. The CD is scratched a lot.
⇨ Clean the CD and load it correctly.

Blank DISC: Nothing has been recorded on the MD.

No Tr DISC: No tracks are recorded on the MD, although it has a title.

NO PANEL: The faceplate of the slave unit being connected to this unit has been removed.
⇨ Replace it.

E-77: The unit is malfunctioning for some reason.
⇨ Press the reset button on the unit. If the "E-77" code does not disappear, consult your nearest service center.

Mecha Error: Something is wrong with the disc magazine. Or the unit is malfunctioning for some reason.
⇨ Check the disc magazine. And then press the reset button on the unit. If the "Mecha Error" code does not disappear, consult your nearest service center.

Hold Error: The protective circuit in the unit activates when the temperature inside the automatic disc changer exceeds 60°C (140°F), stopping all operation.
⇨ Cool down the unit by opening the windows or turning on the air conditioner. As the temperature falls below 60°C (140°F), the disc will start playing again.

NO NAME: Attempted to display DNPS during the CD play having no disc names preset.

NO TITLE: Attempted to display the disc title or track title while the MD having no MD title is being played.

NO TEXT:

- Attempted to display the disc text or track text while the CD having no CD text is being played.
- Attempted to display text during reception of the station that isn't sending text data.

Waiting: Radio text data is being received.

Load: Discs are being exchanged in the Disc changer.

NO ACCESS: After setting it in the Disc Changer, DNPP was done without having it been played at least 1 time.

IN (Blink): The CD player section is not operating properly.
⇨ Reinsert the CD. If the CD cannot be ejected or the display continues to flash even when the CD has been properly reinserted, please switch off the power and consult your nearest service center.

Specifications

Specifications subject to change without notice.

FM tuner section

Frequency range (50 kHz space)	87.5 MHz – 108.0 MHz
Usable sensitivity (S/N = 26dB)	0.7 μ V/75 Ω
Quieting Sensitivity (S/N = 46dB)	1.6 μ V/75 Ω
Frequency response (\pm 3 dB)	30 Hz – 15 kHz
Signal to Noise ratio (MONO)65 dB
Selectivity (DIN) (\pm 400 kHz)	\geq 80 dB
Stereo separation (1 kHz)35 dB

MW tuner section

Frequency range (9 kHz space)	531 kHz – 1611 kHz
Usable sensitivity (S/N = 20dB)25 μ V

LW tuner section

Frequency range	153 kHz – 281 kHz
Usable sensitivity (S/N = 20dB)45 μ V

CD player section

Laser diode	GaAlAs (λ =780 nm)
Digital filter (D/A)	8 Times Over Sampling
D/A Converter	1 Bit
Spindle speed	500 – 200 rpm (CLV)
Wow & Flutter	Below Measurable Limit
Frequency response (\pm 1 dB)	10 Hz – 20 kHz
Total harmonic distortion (1 kHz)	0.01 %
Signal to Noise ratio (1 kHz)	105 dB
Dynamic range	93 dB
Channel separation85 dB

Audio section

Maximum output power	50 W x 4
Output power (DIN 45324, +B=14.4V)	30 W x 4
Tone action	
Bass :	100 Hz \pm 10 dB
Middle :	1 kHz \pm 10 dB
Treble :	10 kHz \pm 10 dB
Preout level / Load (during disc play)	1800 mV/10 k Ω
Preout impedance (during disc play)	\leq 600 Ω

General

Operating voltage (11 – 16V allowable)	14.4 V
Current consumption	10 A
Installation Size (W x H x D)	182 x 53 x 161 mm
Weight	1.4 kg

Free Manuals Download Website

<http://myh66.com>

<http://usermanuals.us>

<http://www.somanuals.com>

<http://www.4manuals.cc>

<http://www.manual-lib.com>

<http://www.404manual.com>

<http://www.luxmanual.com>

<http://aubethermostatmanual.com>

Golf course search by state

<http://golfingnear.com>

Email search by domain

<http://emailbydomain.com>

Auto manuals search

<http://auto.somanuals.com>

TV manuals search

<http://tv.somanuals.com>