

KENWOOD

KDC-X598 KDC-BT558U KMR-D558BT

CD-RECEIVER INSTRUCTION MANUAL

AMPLI-TUNER LECTEUR DE CD

MODE D'EMPLOI

REPRODUCTOR DE DISCOS COMPACTOS RECEPTOR DE FM/AM

MANUAL DE INSTRUCCIONES

JVCKENWOOD Corporation

Take the time to read through this instruction manual. Familiarity with installation and operation procedures will help you obtain the best performance from your new CD-receiver.

For your records

Record the serial number, found on the back of the unit, in the spaces designated on the warranty card, and in the space provided below. Refer to the model and serial numbers whenever you call upon your Kenwood dealer for information or service on the product.

Model KDC-X598/ KDC-BT558U/ KMR-D558BT

Serial number _____

US Residents Only



Register Online

Register your Kenwood product at www.Kenwoodusa.com

CONTENTS

BEFORE USE	2
BASICS	3
GETTING STARTED	4
RADIO	5
CD / USB / iPod	6
AUX	8
Pandora®	8
iHeartRadio®	9
SiriusXM® Radio	10
BLUETOOTH®	12
AUDIO SETTINGS	17
DISPLAY SETTINGS	18
MORE INFORMATION	18
TROUBLESHOOTING	19
INSTALLATION / CONNECTION	22
SPECIFICATIONS	24

How to read this manual

- Operations are explained mainly using buttons on the faceplate.
- [XX] indicates the selected items.
- (➔ XX) indicates references are available on the stated page.

BEFORE USE

⚠ Warning

Do not operate any function that takes your attention away from safe driving.

⚠ Caution

Volume setting:

- Adjust the volume so that you can hear sounds outside the car to prevent accidents.
- Lower the volume before playing digital sources to avoid damaging the speakers by the sudden increase of the output level.

General:

- Avoid using the USB device or iPod/iPhone if it might hinder safe driving.
- Make sure all important data has been backed up. We shall bear no responsibility for any loss of recorded data.
- Never put or leave any metallic objects (such as coins or metal tools) inside the unit, to prevent a short circuit.
- If a disc error occurs due to condensation on the laser lens, eject the disc and wait for the moisture to evaporate.

Remote control (RC-406):

- Do not leave the remote control in hot places such as on the dashboard.
- The Lithium battery is in danger of explosion if replaced incorrectly. Replace it only with the same or equivalent type.
- The battery pack or batteries shall not be exposed to excessive heat such as sunshine, fire or the like.
- Keep the battery out of reach of children and in its original packaging when not in used. Dispose of used batteries promptly. If swallowed, contact a physician immediately.

Maintenance

Cleaning the unit: Wipe off dirt on the faceplate with a dry silicone or soft cloth.

Cleaning the connector: Detach the faceplate and clean the connector gently with a cotton swab, being careful not to damage the connector.

Handling discs:

- Do not touch the recording surface of the disc.
- Do not stick tape etc. on the disc, or use a disc with tape stuck on it.
- Do not use any accessories for the disc.
- Clean from the center of the disc and move outward.
- Clean the disc with a dry silicone or soft cloth. Do not use any solvents.
- When removing discs from this unit, pull them out horizontally.
- Remove burrs from the center hole and disc edge before inserting a disc.

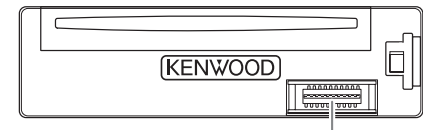

Connector (on the reverse side of the faceplate)

BASICS

Faceplate

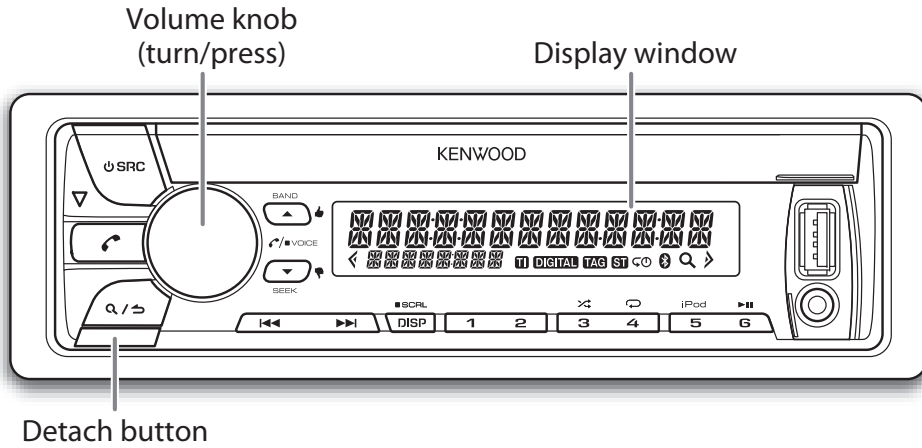

<p>Attach</p>	<p>Detach</p>	<p>How to reset</p> <p>Your preset adjustments will also be erased.</p>
----------------------	----------------------	--

Remote control (RC-406)

(except for **KMR-D558BT**)

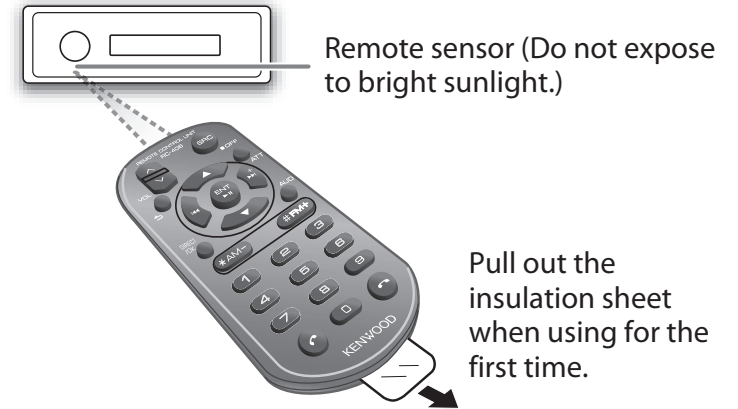

How to replace the battery

The diagram shows a hand opening the battery cover on the back of the remote control. A CR2025 battery is shown being inserted into the compartment. The steps are numbered 1 through 4.

To	Do this (on the faceplate)	Do this (on the remote control)
Turn on the power	Press SRC . • Press and hold to turn off the power.*	Press and hold SRC to turn off the power. (Pressing SRC does not turn on the power.)
Adjust the volume	Turn the volume knob.	Press VOL \wedge or VOL \vee . Press ATT during playback to attenuate the sound. • Press again to cancel.
Select a source	Press SRC repeatedly.	Press SRC repeatedly.
Change the display information	Press DISP SCRL repeatedly. • Press and hold to scroll the current display information.	(not available)

* For **KMR-D558BT**: The power will automatically turn off after 20 minutes when in standby mode (Auto Power Off).

GETTING STARTED



1 Cancel the demonstration

When you turn on the power (or after you reset the unit), the display shows: "CANCEL DEMO" → "PRESS" → "VOLUME KNOB"

- 1 Press the volume knob.
[YES] is selected for the initial setup.
- 2 Press the volume knob again.
"DEMO OFF" appears.

For **KMR-D558BT**, [DEMO OFF] is selected initially.

2 Set the clock

- 1 Press the volume knob to enter [FUNCTION].
- 2 Turn the volume knob to select [CLOCK], then press the knob.
- 3 Turn the volume knob to select [CLOCK ADJUST], then press the knob.
- 4 Turn the volume knob to make the settings, then press the knob.
Day → Hour → Minute
- 5 Turn the volume knob to select [CLOCK FORMAT], then press the knob.
- 6 Turn the volume knob to select [12H] or [24H], then press the knob.
- 7 Press and hold **Q/↵** to exit.

To return to the previous setting item or hierarchy, press **Q/↵**.

3 Set the initial settings

- 1 Press **⏻ SRC** to enter STANDBY.
- 2 Press the volume knob to enter [FUNCTION].
- 3 Turn the volume knob to make a selection (see the following table), then press the knob.
- 4 Press and hold **Q/↵** to exit.

To return to the previous setting item or hierarchy, press **Q/↵**.

Default: **XX**

AUDIO CONTROL

SP SELECT **OFF/ 5/4/ 6 × 9/6/ OEM**: Selects according to the speaker size (5 inches or 4 inches, 6×9 inches or 6 inches) or OEM speakers for optimum performance.

DISPLAY

EASY MENU **ON**: Both display and button illumination change to white color when entering [FUNCTION]. ; **OFF**: Both display and button illumination remain as [COLOR SELECT] color. (→ 18)

TUNER SETTING

PRESET TYPE **NORMAL**: Memorizes one station for each preset button in each band (FM1/ FM2/ FM3/ AM). ; **MIX**: Memorizes one station or SiriusXM channel for each preset button, regardless of the selected band or SiriusXM channel.

SYSTEM

KEY BEEP **ON**: Activates the keypress tone. ; **OFF**: Deactivates.

SOURCE SELECT

PANDORA SRC **ON**: Enables PANDORA in source selection. ; **OFF**: Disables. (→ 8)

IHEART SRC **ON**: Enables IHEARTRADIO in source selection. ; **OFF**: Disables. (→ 9)

BUILT-IN AUX **ON**: Enables AUX in source selection. ; **OFF**: Disables. (→ 8)

CD READ **1**: Automatically distinguishes between audio file disc and music CD. ; **2**: Forces to play as an music CD. No sound can be heard if an audio file disc is played.

F/W UPDATE

UPDATE SYSTEM / UPDATE BT

F/W UP **YES**: Starts upgrading the firmware. ; **NO**: Cancels (upgrading is not activated).
xx.xx For details on how to update the firmware, see: www.kenwood.com/cs/ce/

RADIO



Search for a station

- 1 Press **SRC** to select TUNER.
 - 2 Press **▲ BAND** repeatedly (or press ***AM-** / **#FM+** on RC-406) to select FM1/ FM2/ FM3/ AM.
 - 3 Press **◀◀ / ▶▶** (or press **◀◀ / ▶▶ (+)** on RC-406) to search for a station.
- To change the searching method for **◀◀ / ▶▶**: Press **▼ SEEK** repeatedly.
AUTO1: Automatically search for a station.
AUTO2: Search for a preset station.
MANUAL: Manually search for a station.
 - To store a station: Press and hold one of the number buttons (**1** to **6**).
 - To select a stored station: Press one of the number buttons (**1** to **6**) (or press one of the number buttons (**1** to **6**) on RC-406).

Direct Access Tuning (using RC-406)

(except for **KMR-D558BT**)

- 1 Press **DIRECT** to enter Direct Access Tuning.
 - 2 Press the number buttons to enter a frequency.
 - 3 Press **ENT ▶▶** to search for a station.
- To cancel, press **↶** or **DIRECT**.
 - If no operation is done for 10 seconds after step **2**, Direct Access Tuning is automatically canceled.

Other settings

- 1 Press the volume knob to enter [FUNCTION].
- 2 Turn the volume knob to make a selection (see the following table), then press the knob.
- 3 Press and hold **Q / ↶** to exit.

To return to the previous setting item or hierarchy, press **Q / ↶**.

Default: **XX**

TUNER SETTING

AUTO MEMORY	YES : Automatically starts memorizing 6 stations with good reception. ; NO : Cancels. (Selectable only if [NORMAL] is selected for [PRESET TYPE].) (→ 4)
MONO SET	ON : Improves the FM reception, but the stereo effect may be lost. ; OFF : Cancels.
TI	ON : Allows the unit to temporarily switch to Traffic Information. ; OFF : Cancels.
PTY SEARCH	Selects the available Program Type (see below), then, press ◀◀ / ▶▶ to start.

CLOCK

TIME SYNC	ON : Synchronizes the unit's time to the Radio Broadcast Data System station time. ; OFF : Cancels.
------------------	---

- [**MONO SET**]/ [**TI**]/ [**PTY SEARCH**] is selectable only when the band is FM1/ FM2/ FM3.
 - Available Program Type:
SPEECH: **NEWS**, **INFORM** (information), **SPORTS**, **TALK**, **LANGUAGE**, **REL TALK** (religious talk), **PERSNLTY** (personality), **PUBLIC**, **COLLEGE**, **HABL ESP** (spanish talk), **WEATHER**
MUSIC: **ROCK**, **CLS ROCK** (classic rock), **ADLT HIT** (adult hits), **SOFT RCK** (softrock), **TOP 40**, **COUNTRY**, **OLDIES**, **SOFT**, **NOSTALGA** (nostalgia), **JAZZ**, **CLASSICL** (classical), **R & B** (rhythm and blues), **SOFT R&B** (soft rhythm and blues), **REL MUSC** (religious music), **MUSC ESP** (spanish music), **HIP HOP**
- The unit will search for the Program Type categorized under [**SPEECH**] or [**MUSIC**] if selected.
- If the volume is adjusted during reception of traffic information or alarm, the adjusted volume is memorized automatically. It will be applied the next time traffic information or alarm function is turned on.

CD / USB / iPod

Start playback

The source changes automatically and playback starts.

CD

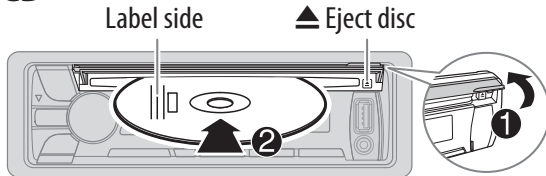

USB

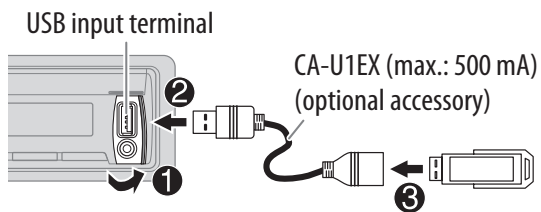

iPod/iPhone

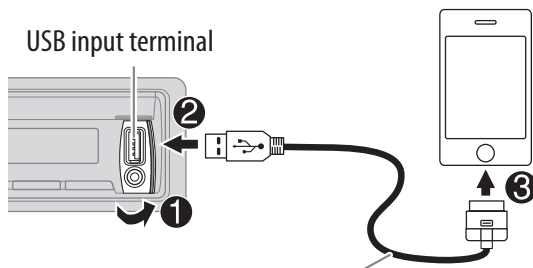

KCA-iP102 (optional accessory) or accessory cable of the iPod/iPhone*1

Press 5 iPod to select the control mode while in iPod source.

MODE ON: From the iPod*2.

MODE OFF: From the unit.

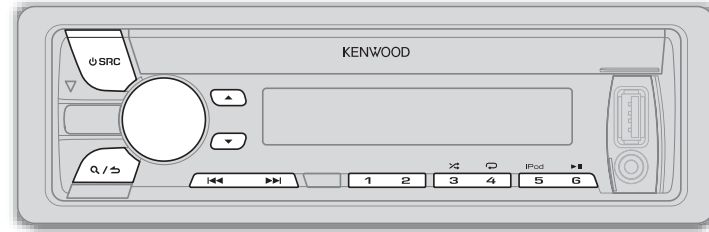

To	Do this
Pause or resume playback	Press 6 ► (or press ENT ► on RC-406).
Select a track/file	Press ◀◀ / ▶▶ (or press ◀◀ / ▶▶ (+) on RC-406).
Select a folder *3	Press ▲ / ▼ (or press *AM- / #FM+ on RC-406).
Reverse/ Fast-forward	Press and hold ◀◀ / ▶▶ (or press and hold ◀◀ / ▶▶ (+) on RC-406).
Repeat play *4	Press 4 ◀ repeatedly. <ul style="list-style-type: none"> • Audio CD: TRACK REPEAT, REPEAT OFF • MP3/WMA/WAV file or iPod: FILE REPEAT, FOLDER REPEAT, REPEAT OFF • KENWOOD Music Editor Light (KME Light)/ KENWOOD Music Control (KMC) file (→ 18): FILE REPEAT, REPEAT OFF
Random play *4	Press 3 ✂ repeatedly. <ul style="list-style-type: none"> • Audio CD: DISC RANDOM, RANDOM OFF • MP3/WMA/WAV file or iPod or KME Light/ KMC file: FOLDER RANDOM, RANDOM OFF <p>Press and hold 3 ✂ to select "ALL RANDOM". *5</p>

*1 Do not leave the cable inside the car when not using.

*2 You can still play/pause, file skip, fast-forward or reverse files from the unit.

*3 Only for MP3/WMA/WAV files. This does not work for iPod.

*4 **For iPod:** Applicable only when [MODE OFF] is selected.

*5 **For CD:** Only for MP3/WMA files.

If you connect the iPod/iPhone to the USB input terminal of the unit (while listening to TuneIn Radio, TuneIn Radio Pro or Aupeo), the unit will output the sound from these apps.

Select a track/file from a list

For iPod: Applicable only when [MODE OFF] is selected. (→ 6)

- 1 Press **Q / ↵**.
 - 2 Turn the volume knob to make a selection, then press the knob.
 - MP3/WMA/WAV file: Select the desired folder, then a file.
 - iPod or KME Light/ KMC file: Select the desired file from the list (PLAYLISTS, ARTISTS, ALBUMS, SONGS, PODCASTS*, GENRES, COMPOSERS*).
- * Only for iPod.
- To return to the root folder (or first file), press number button **5 iPod**.
 - To return to the previous setting item or hierarchy, press **Q / ↵**.
 - To cancel, press and hold **Q / ↵**.

If you have many files....

You can search through them quickly (on step 2 above) at a preset skip search ratio by pressing **◀◀ / ▶▶**.

- See also "Set the skip search ratio."
- Pressing and holding **◀◀ / ▶▶** skip songs at the maximum ratio (10%) regardless of the setting made.
- For USB: Only for files registered in the database created with KME Light/ KMC.
- Not applicable for audio CD.

Direct Music Search (using RC-406)

(except for **KMR-D558BT**)

- 1 Press **DIRECT**.
- 2 Press the number buttons to enter a track/file number.
- 3 Press **ENT ▶||** to search for music.
 - To cancel, press **↵**.
 - Not available if Random Play is selected.
 - Not applicable for iPod, KME Light/ KMC file.

Select a song by name

While listening to iPod...

- 1 Press **Q / ↵**.
- 2 Turn the volume knob to select a category, then press the knob.
- 3 Turn the volume knob quickly to enter character search.
- 4 Turn the volume knob to select the character to be searched for.
- 5 Press **◀◀ / ▶▶** to move to the entry position.

You can enter up to 3 characters.
- 6 Press the volume knob to start searching.
- 7 Turn the volume knob to make a selection, then press the knob.

Repeat step 7 until the desired item is selected.

 - To search for a character other than A to Z and 0 to 9, enter only **"*"**.
 - To return to the previous hierarchy, press **Q / ↵**.
 - To return to the top menu, press number button **5 iPod**.
 - To cancel, press and hold **Q / ↵**.

Set the skip search ratio

While listening to iPod or KME Light/ KMC file...

- 1 Press the volume knob to enter [FUNCTION].
- 2 Turn the volume knob to select [USB], then press the knob.
- 3 Turn the volume knob to select [SKIP SEARCH], then press the knob.
- 4 Turn the volume knob to make a selection, then press the knob.

0.5% (default)/ 1%/ 5%/ 10%: Skip search ratio over the total files.
- 5 Press and hold **Q / ↵** to exit.

Change the USB drive

When a smartphone (Mass Storage Class) is connected to the USB input terminal, you can select its internal memory or external memory (such as an SD card) to playback the stored songs. You can also select the desired drive to playback when a multiple drives device is connected.

Press **5 iPod** repeatedly to select the desired drive.

(or)

- 1 Press the volume knob to enter [FUNCTION].
- 2 Turn the volume knob to select [USB], then press the knob.
- 3 Turn the volume knob to select [MUSIC DRIVE], then press the knob.
- 4 Press the volume knob to select [DRIVE CHANGE].

The next drive is selected automatically. Repeat steps 1 to 4 to select the following drives.

Selectable items: [DRIVE 1] to [DRIVE 5]

AUX

Preparation:

Select [ON] for [BUILT-IN AUX]. (→ 4)

Start listening

- 1 Connect a portable audio player (commercially available).

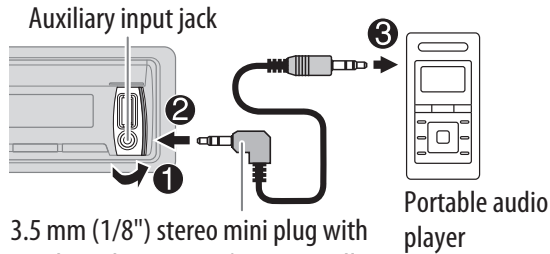

3.5 mm (1/8") stereo mini plug with "L" shaped connector (commercially available)

- 2 Press **SRC** to select AUX.
- 3 Turn on the portable audio player and start playback.

Set the AUX name

While listening to a portable audio player connected to the unit...

- 1 Press the volume knob to enter [FUNCTION].
- 2 Turn the volume knob to select [SYSTEM], then press the knob.
- 3 Turn the volume knob to select [AUX NAME SET], then press the knob.
- 4 Turn the volume knob to make a selection, then press the knob.
AUX (default)/ DVD/ PORTABLE/ GAME/ VIDEO/ TV
- 5 Press and hold **Q/↵** to exit.

Pandora®

Preparation:

Install the latest version of the Pandora application onto your device (iPhone/iPod touch), then create an account and log in to Pandora.

- Select [ON] for [PANDORA SRC]. (→ 4)

Start listening

- 1 Open the Pandora application on your device.
- 2 Connect your device to the USB input terminal.

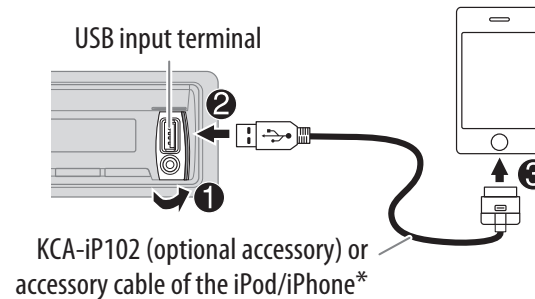

KCA-iP102 (optional accessory) or accessory cable of the iPod/iPhone*

The source changes to PANDORA and broadcast starts.

- * Do not leave the cable inside the car when not using.

To	Do this
Pause or resume playback	Press 6 ▶ (or press ENT ▶ on RC-406).
Thumbs up or thumbs down	Press ▲/▼ . • If thumbs down is selected, the current track is skipped.
Skip a track	Press ▶▶ (or press ▶▶ (+) on RC-406).
Create a new station	<ol style="list-style-type: none"> 1 Press and hold the volume knob. 2 Turn the volume knob to select [FROM TRACK] or [FROM ARTIST], then press the knob. A new station is created based on the current song or artist.
Save a station	<p>Press and hold one of the number buttons (1 to 5) to store.</p> <ul style="list-style-type: none"> • To select a stored station, press one of the number buttons (1 to 5).
Search for a registered station	<ol style="list-style-type: none"> 1 Press Q/↵. 2 Turn the volume knob to make a selection, then press the knob (or press ▲/▼ on RC-406). [BY DATE]: According to the registered date. [A-Z]: Alphabetical order. 3 Turn the volume knob to the desired station, then press the knob.

iHeartRadio®

Preparation:

Install the latest version of iHeart Link for KENWOOD application onto your device (iPhone/ iPod touch), then create an account and log in to iHeartRadio

- Select [ON] for [IHEART SRC]. (→ 4)

Start listening

- 1 Open the iHeart Link application on your device.
- 2 Connect your device to the USB input terminal.

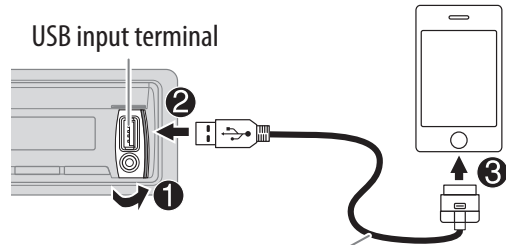

KCA-iP102 (optional accessory) or accessory cable of the iPod/iPhone*

- 3 Press **⏻ SRC** to select IHEARTRADIO. Broadcast starts automatically.

* Do not leave the cable inside the car when not using.

To	Do this
Pause or resume playback	Press 6 ▶ (or press ENT ▶ on RC-406).
Thumbs up or thumbs down for custom station	Press ▲ / ▼ . • If thumbs down is selected, the current track is skipped.
Skip a track for custom station	Press ▶▶ (or press ▶▶ (+) on RC-406).
Create a new/ custom station	Press 1 .
Add to favorite stations for live station	Press 2 .
Scan for live station	Press 5 .

Search for a station

- 1 Press **Q / ↵**.
- 2 Turn the volume knob to select a category, then press the knob.
- 3 Turn the volume knob to the desired station, then press the knob.
When a city list appears, you can skip cities in alphabetical order.

(or using RC-406)

Press **▲ / ▼** to search for a station.

To cancel, press and hold **Q / ↵**.

Skip cities by alphabetical order

While a city list appears during search...

- 1 Turn the volume knob quickly to enter character search.
- 2 Turn the volume knob or press **◀◀ / ▶▶** to select the character to be searched for.
- 3 Press **▲ / ▼** to move to the previous/next page.
- 4 Press the volume knob to start searching.

To cancel, press and hold **Q / ↵**.

Delete a station

While listening to IHEARTRADIO...

- 1 Press the volume knob to enter [FUNCTION].
- 2 Turn the volume knob to select [SYSTEM], then press the knob.
- 3 Turn the volume knob to select [STATION DEL], then press the knob.
- 4 Turn the volume knob to select [LIVE] or [CUSTOM], then press the knob.
- 5 Turn the volume knob to select the desired station to delete, then press the knob.
- 6 Turn the volume knob to select [YES], then press the knob.
- 7 Press and hold **Q / ↵** to exit.

To return to the previous setting item or hierarchy, press **Q / ↵**.

SiriusXM® Radio

Preparation:

- 1 Connect the optional SiriusXM Vehicle Tuner (commercially available).

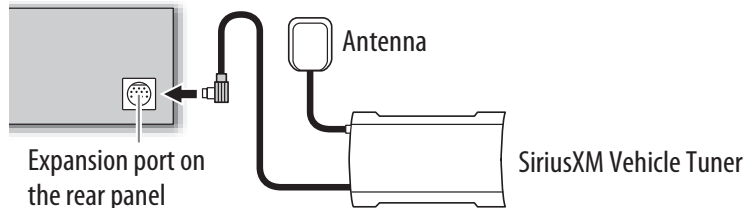

- 2 Activate the subscription through www.siriusxm.com/activatenow or call 1-866-635-2349.

The Radio ID is required to activate the SiriusXM Vehicle Tuner. The Radio ID is located on the label of the SiriusXM Vehicle Tuner and can also be shown on the unit's display window when you select "Channel 0" after SiriusXM Vehicle Tuner is connected. For users in Canada: To activate SiriusXM Canada service go to www.xmradio.ca and click on "ACTIVATE RADIO" in the top right corner, or call 1-877-438-9677.

- 3 Press **SRC** to select SIRIUS XM to start updating.

Start listening

- 1 Press **SRC** to select SIRIUS XM.
- 2 Press **BAND** repeatedly to select a band.
- 3 Press **Q** / **↵**.
"Q" lights up.
- 4 Turn the volume knob to select a category, then press the knob. If "ALL CHANNELS" is selected, all the available channels will be shown.
- 5 Turn the volume knob to select a channel, then press the knob. (or)
Press **◀◀ / ▶▶** to search for a channel manually.
 - Pressing and holding **◀◀ / ▶▶** changes the channel rapidly.

If a locked channel or a mature channel ([**MATURE CH**] is set to [**ON**]) is selected, a pass code input screen appears. Enter the pass code to receive the channel.

- To change the tuning method for **◀◀ / ▶▶**: Press **▼ SEEK**. Each time you press **▼ SEEK**, the tuning method switches between "CHANNEL" (manually search for a channel) and "PRESET" (searches for a preset channel of the selected band).
- To store a channel of the current band: Press and hold one of the number buttons (**1** to **6**).
- To select a stored channel of the current band: Press one of the number buttons (**1** to **6**).

Direct Access Tuning (using RC-406)

(except for **KMR-D558BT**)

- 1 Press **DIRECT** to enter Direct Access Tuning.
 - 2 Press the number buttons to enter a channel number.
 - 3 Press **◀◀ / ▶▶ (+)** to start searching.
- To cancel, press **↵** or **DIRECT**.
 - If no operation is done for 10 seconds after step 2, Direct Access Tuning is automatically canceled.

SiriusXM Replay™

Press and hold **▼ SEEK** (or **▼** on RC-406).

Replay starts from the live position and "Ⓞ" lights up.

During Replay...

- To pause or resume playback, press **6 ▶▶ ||** (or press **ENT ▶▶ ||** on RC-406).
- To skip the current song backward/forward, press **◀◀ / ▶▶** (or press **◀◀ / ▶▶ (+)** on RC-406).
- To rewind/fast-forward, press and hold **◀◀ / ▶▶** (or press and hold **◀◀ / ▶▶ (+)** on RC-406).
- To exit from Replay and go to live, press and hold **▼ SEEK** (or press and hold **▼** on RC-406).

Smart Favorites

User stored channels (**1 to 6**) of the current band are recognized as Smart Favorite channels. SiriusXM Vehicle Tuner automatically buffered their broadcasting content in the background.

- Smart Favorite channel is available with SXV200 or later SiriusXM tuner models.

When you select a Smart Favorite channel, you can rewind and replay up to 30 minutes of any of the missed news, talk, sports or music content.

- 1 Press one of the number buttons (1 to 6) to select a channel.**
- 2 For operation (→ 10, SiriusXM Replay™)**

SiriusXM settings

- 1 Press the volume knob to enter [FUNCTION].**
- 2 Turn the volume knob to select [SIRIUS XM], then press the knob.**
- 3 Turn the volume knob to make a selection (see the following table), then press the knob.**
- 4 Press and hold Q/↵ to exit.**

To return to the previous setting item or hierarchy, press Q/↵.

There are two types of lock functions available:

- SiriusXM-defined: When [MATURE CH] is set to [ON]
- User-defined: Using [CHANNEL EDIT] when [MATURE CH] is set to [OFF]

CHANNEL LOCK	To unlock settings: <ol style="list-style-type: none"> 1 Turn the volume knob to select a number. 2 Press ◀◀ / ▶▶ to move to the entry position. 3 Repeat steps 1 and 2 to enter the current pass code. (Initial pass code is 0000.) 4 Press the volume knob to confirm.
CODE SET	<ol style="list-style-type: none"> 1 Turn the volume knob to select a number. 2 Press ◀◀ / ▶▶ to move to the entry position. 3 Repeat steps 1 and 2 to enter a new 4-digit pass code. 4 Press the volume knob to confirm. 5 Repeat steps 1 to 4 to reconfirm the pass code. <ul style="list-style-type: none"> • Make a note of the new pass code to enter channel lock settings from next time.
CHANNEL EDIT*	<ol style="list-style-type: none"> 1 Turn the volume knob to select a category, then press the knob. 2 Turn the volume knob to select a channel you want to lock, then press the knob. "L" appears in front of the channel number. 3 Press and hold Q/↵ to exit.
CHANNEL CLEAR*	YES: Clears all the locked channels. ; NO: Cancels.
MATURE CH	ON: Turns on the SiriusXM-defined lock setting (mature channel). ; OFF: Turns off. <ul style="list-style-type: none"> • If [ON] is selected, your setting [CHANNEL EDIT] is temporary ignored.
SIGNAL LEVEL	WEAK/ GOOD/ STRONG: Shows the strength of the current received signal.
BUFFER USAGE	0% — 100% (0): Shows the memory usage for Replay buffer.
SXM RESET	YES: Resets stored channel, locked channel setting and Mature CH setting to default. ; NO: Cancels.

* Displayed only when [MATURE CH] is set to [OFF].

BLUETOOTH®

You can operate Bluetooth devices using this unit.

Connect the microphone

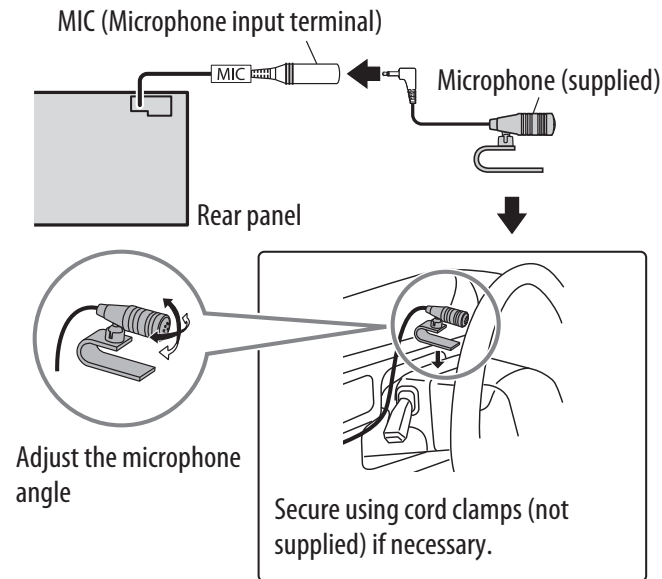

If you turn off the unit or detach the control panel during a phone call conversation, the Bluetooth connection is disconnected. Continue the conversation using your mobile phone.

Supported Bluetooth profiles

- Hands-Free Profile (HFP)
- Serial Port Profile (SPP)
- Phonebook Access Profile (PBAP)
- Object Push Profile (OPP)
- Advanced Audio Distribution Profile (A2DP)
- Audio/Video Remote Control Profile (AVRCP)

Pair a Bluetooth device

When connecting a Bluetooth device to the unit for the first time, perform pairing between the unit and the device. Once the pairing is completed, the Bluetooth device will remain registered in the unit even if you reset the unit.

- Up to five devices can be registered (paired) in total.
 - A maximum of two Bluetooth phones and one Bluetooth audio device can be connected at any time.
 - This unit supports Secure Simple Pairing (SSP).
 - Some Bluetooth devices may not automatically connect to the unit after pairing. Connect the device to the unit manually. Refer to the instruction manual of the Bluetooth device for more information.
- 1 Press **⏻ SRC** to turn on the unit.
 - 2 Search and select this unit model name (KDC-X5**/ KDC-BT5**U/ KMR-D5**BT) on the Bluetooth device.
"PAIRING" → "PASS XXXXXX" → Device name → "PRESS" → "VOLUME KNOB" scrolls on the display.
 - 3 Press the volume knob to start pairing.
"PAIRING OK" appears when pairing is completed and "📶" will light up when the Bluetooth connection is established.
- For some Bluetooth devices, you may need to enter the Personal Identification Number (PIN) code immediately after searching.

- Pairing request (via Bluetooth) is automatically activated if an iPhone/iPod touch is connected through the USB input terminal. (Applicable only if [AUTO PAIRING] is set to [ON].) (→ 16)
Press the volume knob to pair once you have confirm the device name.

Bluetooth test mode

You can check the connectivity of the supported profile between the Bluetooth device and the unit.









- Make sure there is no Bluetooth device connected.
- 1 Press and hold **📶**.
"PLEASE PAIR YOUR PHONE" appears.
 - 2 Search and select this unit model name (KDC-X5**/ KDC-BT5**U/ KMR-D5**BT) on the Bluetooth device.
 - 3 Operate the Bluetooth device to confirm pairing.
"TESTING" flashes on the display.

The connectivity result (OK or NG) appears after the test.

- PAIRING: Pairing status
HF CNT: Hands-Free Profile (HFP) compatibility
AUD CNT: Advanced Audio Distribution Profile (A2DP) compatibility
PB DL: Phonebook Access profile (PBAP) compatibility

- To cancel check mode, press and hold **⏻ SRC** to turn off the unit.

Bluetooth mobile phone

To	Do this
Receive a call	<p>Press  or the volume knob or one of the number buttons (1 to 6) (or press  on RC-406).</p> <ul style="list-style-type: none"> All the buttons and display flash when there is an incoming call. During a call, the buttons and display illuminate according to the settings made for [DISPLAY]. (→ 18) When [AUTO ANSWER] is set to the selected time, the unit answers incoming call automatically. (→ 14)
Reject an incoming call	Press  SRC (or press  on RC-406).
End a call	Press  or  SRC (or press  on RC-406).
Switch between hands-free and private talk modes	<p>Press 6  during a call.</p> <ul style="list-style-type: none"> Operations may vary according to the connected Bluetooth device.
Adjust the phone volume	<p>Turn the volume knob during a call.</p> <p>Phone volume: [00] to [35] (Default: [15])</p> <ul style="list-style-type: none"> This adjustment will not affect the volume of the other sources.
Switch between two connected phones	<p>Press  repeatedly.</p> <ul style="list-style-type: none"> Not applicable during a call.

Improve the sound quality during a call

While talking on the phone...

- Press the volume knob to enter [FUNCTION].
- Turn the volume knob to make a selection (see the following table), then press the knob.
- Press and hold  to exit.

To return to the previous setting item or hierarchy, press .

Default: XX



MIC GAIN	-20 — +8 (0): The sensitivity of the microphone increases as the number increased.
NR LEVEL	-5 — -20 (-10): Adjust the noise reduction level until the least noise is being heard during a phone conversation.
ECHO CANCEL	1 — 10 (4): Adjust the echo cancellation delay time until the least echo is being heard during a phone conversation.

Text message notification

When the phone receives a text message, the unit rings and “SMS RECEIVED” appears.



- You cannot read, edit, or send a message through the unit.
- To clear the message, press any button.

Use Voice Recognition

- Press and hold  to activate Voice Recognition. The connected phone (which has been paired the earliest) is activated. However, if priority device is connected, pressing and holding  activate the priority device. (→ 15, DVC PRIORITY)
- Speak the name of the contact you want to call or the voice command to control the phone functions.
 - Supported Voice Recognition features vary for each phone. Refer to the instruction manual of the connected phone for details.
 - This unit also supports the intelligent personal assistant function of iPhone.

BLUETOOTH®



Bluetooth mode operations

- 1 Press  to enter Bluetooth mode.
- 2 Turn the volume knob to make a selection (see the following table), then press the knob.
- 3 Press and hold  to exit.

To return to the previous setting item or hierarchy, press .

- | | |
|---------------------|--|
| CALL HISTORY | <ol style="list-style-type: none"> 1 Press the volume knob to select a name or a phone number. <ul style="list-style-type: none"> • “INCOMING”, “OUTGOING”, or “MISSED” is shown on the lower part of the display to indicate the previous call status. • Press DISP SCRL to change the display category (NUMBER or NAME). • “NO DATA” appears if there is no recorded call history. 2 Press the volume knob to call. |
|---------------------|--|

- | | |
|-------------------|--|
| PHONE BOOK | <ol style="list-style-type: none"> 1 Turn the volume knob to select a name, then press the knob. 2 Turn the volume knob to select a phone number, then press the knob to call. <ul style="list-style-type: none"> • If the phone supports PBAP, the phonebook of the connected phone is automatically transferred to the unit when pairing. If the phone does not support PBAP, “TRANSFER PB” appears. Transfer the phonebook manually. (➔ 16, TRANSFER PB) • Contacts are categorized as: HOME, OFFICE, MOBILE, OTHER, GENERAL • This unit can display only non-accent letters. (Accent letters such as “Ú” is shown as “U”.) • If the phonebook contains many contacts, (➔ Select a contact by name). |
|-------------------|--|

- | | |
|--------------------|---|
| NUMBER DIAL | <ol style="list-style-type: none"> 1 Turn the volume knob to select a number (0 to 9) or character (*, #, +). 2 Press  /  to move the entry position. Repeat steps 1 and 2 until you finish entering the phone number. 3 Press the volume knob to call. <p>(or using RC-406)</p> <ol style="list-style-type: none"> 1 Press the number buttons (0 to 9) to enter the phone number. 2 Press  to call. |
|--------------------|---|

VOICE	Speak the name of the contact you want to call or the voice command to control the phone functions. (➔ 13)
BATT*	LOW/ MID/ FULL: Shows the strength of the battery.
SIGNAL*	NO SIGNAL/ LOW/ MID/ MAX: Shows the strength of the current received signal.
SETTINGS Default: <u>XX</u>	
AUTO ANSWER	1 — 30: The unit answer incoming call automatically in the selected time. ; OFF: Cancels.
RING MODE	<p>SYSTEM: The unit rings to notify you when a call/text message comes in. (Default ring tone is different according to the paired device.)</p> <ul style="list-style-type: none"> • CALL: Selects your preferred ring tone (TONE 1 — 5) for incoming calls. • MESSAGE: Selects your preferred ring tone (TONE 1 — 5) for incoming text messages. <p>PHONE: The unit uses the connected phones’ ring tone to notify you when a call/text message comes in. (The connected phone will ring if it does not support this feature.)</p>
SMS NOTIFY*	ON: The unit rings and “SMS RECEIVED” appears to notify you of an incoming text message. ; OFF: Cancels.

* Functionality depends on the type of the phone used.

Select a contact by name

- You can search through the contacts quickly according to the first letter (A to Z), number (0 to 9), or symbol.
- The second alphabet of the contact will be searched if the first alphabet does not exist.

- 1 Press  to enter Bluetooth mode.
- 2 Turn the volume knob to select [PHONE BOOK], then press the knob.

- 3 Turn the volume knob quickly to enter alphabet search mode.**
The first menu (ABCDEFGHIJK) appears. To go to the other menu (LMNOPQRSTUV or WXYZ1*), press ▲/▼.
- 4 Turn the volume knob or press |◀◀/▶▶| to select the desired first letter, then press the knob.**
 - To search with numbers, select "1".
 - To search with symbols, select "*".
- 5 Turn the volume knob to select a name, then press the knob.**
- 6 Turn the volume knob to select a phone number, then press the knob to call.**

To return to the previous hierarchy, press Q/↵.

Store a contact in memory

You can store up to 6 contacts.

- 1 Press**  **to enter Bluetooth mode.**
- 2 Turn the volume knob to select [CALL HISTORY], [PHONE BOOK], or [NUMBER DIAL], then press the knob.**
- 3 Turn the volume knob to select a contact or enter a phone number.**
If a contact is selected, press the volume knob to show the phone number.
- 4 Press and hold one of the number buttons (1 to 6).**
"STORED" appears when the contact is stored.

To erase a contact from the preset memory, select [NUMBER DIAL] in step 2 and store a blank number.

Make a call from memory

- 1 Press**  **to enter Bluetooth mode.**
- 2 Press one of the number buttons (1 to 6).**
- 3 Press the volume knob to call.**
"NO MEMORY" appears if there is no contacts stored.

Delete a contact

Not applicable for mobile phone that supports PBAP.

- 1 Press**  **to enter Bluetooth mode.**
- 2 Turn the volume knob to select [CALL HISTORY] or [PHONE BOOK], then press the knob.**
- 3 Turn the volume knob to select a contact.**
If a contact is selected, press the volume knob to show the phone number.
- 4 Press and hold the volume knob to enter delete mode.**
- 5 Turn the volume knob to select [DELETE ONE] or [DELETE ALL], then press the knob.**
DELETE ONE: Selected name or phone number in step 3 is deleted.
DELETE ALL: All names or phone numbers from the selected menu in step 2 is deleted.
- 6 Turn the volume knob to select [YES] or [NO], then press the knob.**

Bluetooth mode settings

- 1 Press the volume knob to enter [FUNCTION].**
- 2 Turn the volume knob to select [BT MODE], then press the knob.**
- 3 Turn the volume knob to make a selection (see the following table), then press the knob.**
- 4 Press and hold Q/↵ to exit.**

To return to the previous setting item or hierarchy, press Q/↵.

Default: XX

PHONE SELECT	Selects the phone or audio device to connect or disconnect.
AUDIO SELECT	"*" appears in front of the device name.
DEVICE DELETE	<ol style="list-style-type: none"> 1 Turn the volume knob to select a device to delete, then press the knob. 2 Turn the volume knob to select [YES] or [NO], then press the knob.
DVC PRIORITY	Selects a device to be connected as priority device. "*" appears in front of the device name set as priority.

BLUETOOTH®

TRANSFER PB*	<p>“DL PB ※※※” appear and transfer the phonebook of the connected phone to this unit manually.</p> <p>* Selectable only when the connected phone supports OPP.</p>
PIN CODE EDIT (0000)	<p>Changes the PIN code (up to 6 digits).</p> <ol style="list-style-type: none"> 1 Turn the volume knob to select a number. 2 Press ◀◀ / ▶▶ to move the entry position. Repeat steps 1 and 2 until you finish entering the PIN code. 3 Press the volume knob to confirm.
RECONNECT	<p>ON: The unit automatically reconnect when the Bluetooth device is within range. ; OFF: Cancels.</p>
AUTO PAIRING	<p>ON: The unit automatically pair supported Bluetooth device (iPhone/iPod touch) when it is connected through USB input terminal. Depending on the iOS version of the connected iPhone/iPod touch, this function may not work. ; OFF: Cancels.</p>
BT HF/AUDIO	<p>FRONT: Outputs audio from the front left and right speakers. ; ALL: Outputs audio from all the speakers.</p>
INITIALIZE	<p>YES: Initializes all the Bluetooth settings (including stored pairing, phonebook, and etc.). ; NO: Cancels.</p>

Internet radio via Bluetooth

Listen to Pandora

Preparation:

Select **[ON]** for **[PANDORA SRC]**. (→ 4)

You can listen to Pandora on your smart phone (Android OS) through Bluetooth on this unit.

- 1 **Open the Pandora application on your device.**
- 2 **Connect to Bluetooth audio player. (→ 12)**
- 3 **Press **⏻ SRC** to select PANDORA.**
The source switches and broadcast starts automatically.

- You can operate Pandora in the same way as Pandora for iPod/iPhone. (→ 8)

Listen to iHeartRadio

Preparation:

Select **[ON]** for **[IHEART SRC]**. (→ 4)

You can listen to iHeartRadio on your smart phone (Android OS) through Bluetooth on this unit.

- 1 **Open the iHeart Link application on your smart phone.**
- 2 **Connect your smart phone via Bluetooth connection. (→ 12)**
- 3 **Press **⏻ SRC** to select IHEARTRADIO.**
The source switches and broadcast starts automatically.

- You can operate iHeartRadio in the same way as iHeartRadio for iPod/iPhone. (→ 9)

Bluetooth audio player

Operations and display indications may differ according to their availability on the connected device.

To	Do this
Playback	<ol style="list-style-type: none"> 1 Press ⏻ SRC (or press SRC on RC-406) to select BT AUDIO. 2 Operate the Bluetooth audio player to start playback.
Pause or resume playback	Press 6 ▶ (or press ENT ▶ on RC-406).
Select group or folder	Press ▲ / ▼ (or press *AM- / #FM+ on RC-406).
Reverse/forward skip	Press ◀◀ / ▶▶ (or press ◀◀ / ▶▶ (+) on RC-406).
Reverse/fast-forward	Press and hold ◀◀ / ▶▶ (or press and hold ◀◀ / ▶▶ (+) on RC-406).
Repeat play	<p>Press 4 ↻ repeatedly to make a selection.</p> <p>ALL REPEAT, FILE REPEAT, REPEAT OFF</p>
Random play	<p>Press 3 ↻ repeatedly to make a selection.</p> <p>FOLDER RANDOM, RANDOM OFF</p> <p>Press and hold 3 ↻ to select “ALL RANDOM.”</p>

AUDIO SETTINGS

While listening to any source...

- 1 Press the volume knob to enter [FUNCTION].
- 2 Turn the volume knob to select [AUDIO CONTROL], then press the knob.
- 3 Turn the volume knob to make a selection (see the following table), then press the knob.
Repeat step 3 until the desired item is selected or activated.
- 4 Press and hold **Q** / **↶** to exit.

(or using RC-406)

- 1 Press **AUD** to enter [AUDIO CONTROL].
- 2 Press **▲** / **▼** to make a selection, then press **ENT ▶** **||**.

To return to the previous setting item or hierarchy, press **Q** / **↶**.

Default: **XX**

SUB-W LEVEL	-15 to +15 (0)	Adjusts the subwoofer output level.
BASS LEVEL	-8 to +8 (+6)	Adjusts the level to memorize for each source. (Before making an adjustment, select the source you want to adjust.)
MID LEVEL	-8 to +8 (+5)	
TRE LEVEL	-8 to +8 (0)	
EQ PRO (for KDC-X598)		
BASS ADJUST	BASS CTR FRQ	60/ 80/ 100/ 200HZ : Selects the center frequency.
	BASS LEVEL	-8 to +8 (+6) : Adjusts the level.
	BASS Q FACTOR	1.00/ 1.25/ 1.50/ 2.00 : Adjusts the quality factor.
	BASS EXTEND	ON : Turns on the extended bass. ; OFF : Cancels.
MID ADJUST	MID CTR FRQ	0.5/ 1.0/ 1.5/ 2.5KHZ : Selects the center frequency.
	MID LEVEL	-8 to +8 (+5) : Adjusts the level.
	MID Q FACTOR	0.75/ 1.00/ 1.25 : Adjusts the quality factor.
TRE ADJUST	TRE CTR FRQ	10.0/ 12.5/ 15.0/ 17.5KHZ : Selects the center frequency.
	TRE LEVEL	-8 to +8 (0) : Adjusts the level.

PRESET EQ	DRIVE EQ/ TOP40/ POWERFUL/ ROCK/ POPS/ EASY/ JAZZ/ NATURAL/ USER : Selects a preset equalizer suitable to the music genre. (Select [USER] to use the customized bass, middle, and treble settings.) [DRIVE EQ] is a preset equalizer that reduces noise from the road.
BASS BOOST	LEVEL1/ LEVEL2/ LEVEL3 : Selects your preferred bass boost level. ; OFF : Cancels.
LOUDNESS	LEVEL1/ LEVEL2 : Selects your preferred low and high frequencies boost to produce a well-balanced sound at a low volume level. ; OFF : Cancels.
SUBWOOFER SET	ON : Turns on the subwoofer output. ; OFF : Cancels.
LPF SUBWOOFER	THROUGH : All signals are sent to the subwoofer. ; 85HZ/ 120HZ/ 160HZ : Audio signals with frequencies lower than 85 Hz/ 120 Hz/ 160 Hz are sent to the subwoofer.
SUB-W PHASE	REVERSE (180°)/ NORMAL (0°) : Selects the phase of the subwoofer output to be in line with the speaker output for optimum performance. (Selectable only if a setting other than [THROUGH] is selected for [LPF SUBWOOFER].)
HPF	THROUGH : All signals are sent to the speakers. ; 100HZ/ 120HZ/ 150HZ : Audio signals with frequencies higher than 100 Hz/ 120 Hz/ 150 Hz are sent to the speakers.
FADER	R15 to F15 (0) : Adjusts the rear and front speaker output balance.
BALANCE	L15 to R15 (0) : Adjusts the left and right speaker output balance.
VOLUME OFFSET (Default: 0)	-8 to +8 (for AUX) ; -8 to 0 (for other sources) : Presets the volume adjustment level of each source. (Before adjustment, select the source you want to adjust.)
SOUND RECNSTR (Sound reconstruction)	ON : Creates realistic sound by compensating the high-frequency components and restoring the rise-time of the waveform that are lost in audio data compression. ; OFF : Cancels.

[SUB-W LEVEL]/ [LPF SUBWOOFER]/ [SUB-W PHASE] is selectable only if [SUBWOOFER SET] is set to [ON].

DISPLAY SETTINGS

- 1 Press the volume knob to enter [FUNCTION].
- 2 Turn the volume knob to select [DISPLAY], then press the knob.
- 3 Turn the volume knob to make a selection (see the following table), then press the knob. Repeat step 3 until the desired item is selected or activated.
- 4 Press and hold **Q** / **↵** to exit.

To return to the previous setting item or hierarchy, press **Q** / **↵**.

Default: **XX**

COLOR SELECT	<p>VARIABLE SCAN/ COLOR 01 — COLOR 24/ USER: Selects your preferred key and display illumination color.</p> <hr/> <p>You can create your own color (when [COLOR 01] — [COLOR 24] or [USER] is selected). The color you have created can be selected when you select [USER].</p> <ol style="list-style-type: none"> 1 Press and hold the volume knob to enter the detailed color adjustment. 2 Press ◀◀ / ▶▶ to select the color (R/ G/ B) to adjust. 3 Turn the volume knob to adjust the level (0 — 9), then press the knob.
DIMMER	<p>ON: Dims the display and button illumination. ; OFF: Illuminates according to the [BRIGHTNESS] settings.</p>
BRIGHTNESS	<p>0 — 31: Selects your preferred brightness level for display and button illumination.</p>
TEXT SCROLL	<p>AUTO/ ONCE: Selects whether to scroll the display information automatically, or scroll only once. ; OFF: Cancels.</p>

MORE INFORMATION

General

- This unit can only play the following CDs:



- Detailed information and notes about the playable audio files are stated in an online manual on the following web site: www.kenwood.com/cs/ce/audiofile/

Playable files

- Playable audio file: MP3 (.mp3), WMA (.wma)
 - Playable disc media: CD-R/CD-RW/CD-ROM
 - Playable disc file format: ISO 9660 Level 1/2, Joliet, Long file name.
 - Playable USB device file system: FAT12, FAT16, FAT32
- Even when audio files comply with the standards listed above, playback may be impossible depending on the types or conditions of media or device.

Unplayable discs

- Discs that are not round.
- Discs with coloring on the recording surface or discs that are dirty.
- Recordable/ReWritable discs that have not been finalized.
- 8 cm CD. Attempting to insert using an adapter may cause malfunction.

About USB devices

- This unit can play MP3/WMA/WAV files stored on a USB mass storage class device.
- You cannot connect a USB device via a USB hub.
- Connecting a cable whose total length is longer than 5 m may result in abnormal playback.
- This unit cannot recognize a USB device whose rating is other than 5 V and exceeds 1 A.

About KENWOOD Music Editor Light and KENWOOD Music Control

- This unit supports the PC application KENWOOD Music Editor Light and Android™ application KENWOOD Music Control.
- When you play audio files with song data added using the KENWOOD Music Editor Light or KENWOOD Music Control, you can search for audio files by Genres, Artists, Albums, Playlists, and Songs.
- KENWOOD Music Editor Light and KENWOOD Music Control are available on the following web site: www.kenwood.com/cs/ce/

About iPod/iPhone

Made for

- iPod touch (1st, 2nd, 3rd, 4th, and 5th generation)
- iPod classic
- iPod nano (3rd, 4th, 5th, 6th, and 7th generation)
- iPhone, iPhone 3G, 3GS, 4, 4S, 5
- For the latest compatible list and software versions of iPhone/iPod, see: www.kenwood.com/cs/ce/ipod
- You cannot operate iPod if "KENWOOD" or "✓" is displayed on iPod.

About Pandora

- Pandora is available only in the U.S., Australia and New Zealand.
- Because Pandora is a third-party service, the specifications are subject to change without prior notice. Accordingly, compatibility may be impaired, or some or all of the services may become unavailable.
- Some functions of Pandora cannot be operated from this unit.
- For issues using the application, please contact Pandora at pandora-support@pandora.com.

MORE INFORMATION

About iHeartRadio

- iHeartRadio® is a third-party service, therefore the specifications are subject to change without prior notice. Accordingly, compatibility may be impaired or some or all of the services may become unavailable.
- Some iHeartRadio® functionality cannot be operated from this unit.

About Bluetooth

- Depending on the Bluetooth version of the device, some Bluetooth devices may not be able to connect to this unit.
- This unit may not work with some Bluetooth devices.
- Signal conditions vary, depending on the surroundings.
- For more information about Bluetooth, visit the following website:
www.kenwood.com/cs/ce/

TROUBLESHOOTING

Symptom	Remedy
Sound cannot be heard.	<ul style="list-style-type: none"> • Adjust the volume to the optimum level. • Check the cords and connections.
"PROTECT" appears and no operations can be done.	Check to be sure the terminals of the speaker wires are insulated properly, then reset the unit. If this does not solve the problem, consult your nearest service center.
<ul style="list-style-type: none"> • Sound cannot be heard. • The unit does not turn on. • Information shown on the display is incorrect. 	Clean the connectors. (➔ 2)
The unit does not work at all.	Reset the unit. (➔ 3)
For KMR-D558BT : The Auto Power Off function (that turns the power off after 20 minutes when in standby mode) does not work.	Make sure [OFF] is selected for [DEMO MODE]. (➔ 4)
<ul style="list-style-type: none"> • Radio reception is poor. • Static noise while listening to the radio. 	<ul style="list-style-type: none"> • Connect the antenna firmly. • Pull the antenna out all the way.
"NA FILE" appears.	Make sure the disc contains supported audio files. (➔ 18)
"NO DISC" appears.	Insert a playable disc into the loading slot.
"TOC ERROR" appears.	Make sure the disc is clean and inserted properly.
"PLEASE EJECT" appears.	Reset the unit. If this does not solve the problem, consult your nearest service center.
Disc cannot be ejected.	Press and hold ▲ to forcibly eject the disc. Be careful not to drop the disc when it is ejected. If this does not solve the problem, reset the unit. (➔ 3)

TROUBLESHOOTING

Symptom	Remedy	
"READ ERROR" appears.	Copy the files and folders onto the USB device again. If this does not solve the problem, reset the USB device or use another USB device.	
"NO DEVICE" appears.	Connect a USB device, and change the source to USB again.	
"COPY PRO" appears.	A copy-protected file is played.	
"NA DEVICE" appears.	Connect a supported USB device, and check the connections.	
"NO MUSIC" appears.	Connect a USB device that contains playable audio files.	
"iPod ERROR" appears.	<ul style="list-style-type: none"> • Reconnect the iPod. • Reset the iPod. 	
Noise is generated.	Skip to another track or change the disc.	
Tracks do not play back as you intended them to play.	Playback order is determined when files are recorded.	
"READING" keeps flashing.	Do not use too many hierarchical levels or folders.	
Elapsed playing time is not correct.	This is caused by how the tracks are recorded.	
Correct characters are not displayed (e.g. album name).	This unit can only display uppercase letters, numbers, and a limited number of symbols.	
Pandora	"ADD ERROR" "SEARCH ERROR"	New station creation is unsuccessful.
	"CHECK DEVICE"	Check the Pandora application on your device.
	"NO SKIPS"	The skip limit has been reached.
	"NO STATIONS"	No stations are found.
	"STATION LIMIT"	The number of registered stations has reached its limit. Retry after deleting unnecessary stations from your device.
	"UPGRADE APP"	Make sure you have installed the latest version of the Pandora application on your device.

Symptom	Remedy	
Pandora	"CONNECT ERROR"	Communication is unstable.
	"RATING ERROR"	Registration of thumbs up/thumbs down has failed.
	"LICENSE ERROR"	You try to access from a country which Pandora is not deliverable.
iHeartRadio	Station cannot be selected.	If "Explicit Content" in [Account Settings] is checked in the web version of iHeartRADIO, custom stations become unavailable.
	"CANNOT CREATE"	Custom station name creation is unsuccessful.
	"CANNOT SAVE"	Addition to the favorite category failed.
	"DISCONNECTED"	Check the connection to the device.
	"NO SKIPS"	The skip limit has been reached. Retry later.
	"NO STATIONS"	No stations are found.
	"NOT CONNECTED"	Link to the application is impossible.
	"IHEARTLINK UP"	Make sure you have installed the latest version of the iHeart Link for KENWOOD application on your device.
	"PLEASE LOGIN"	You haven't log in. Log in again.
	"STATION NOT AVAILABLE"	Broadcast from the station is over.
	"STATION NOT SELECTED"	No station is selected.
	"STREAM ERROR"	Broadcast data is interrupted.
	"THUMB FAILED"	Registration of Thumbs Up/Down has failed.
"TIMED OUT"	The request has resulted in time-out.	

	Symptom	Remedy
SiriusXM® Radio	“CH LOCKED”	The selected channel is locked. Enter the correct pass code to unlock. (➔ 11)
	“CHAN UNSUB”	The selected channel is unsubscribed. Call 1-866-635-2349 or 1-877-438-9677 to subscribe.
	“CH UNAVAIL”	The selected channel is unavailable.
	“CHECK ANTENNA”	Check the antenna and its connection are in good condition.
	“CHECK TUNER”	Make sure the SiriusXM Vehicle Tuner is connected to the unit.
	“NO SIGNAL”	Make sure the antenna is mounted outside the vehicle.
	“SUBSCRIPTION UPDATED – PRESS ENTER TO CONTINUE.”	Your subscription is updated. Press the volume knob to continue.
	“WRONG CODE”	Make sure you have entered the correct pass code. (➔ 11)
Bluetooth®	No Bluetooth device is detected.	<ul style="list-style-type: none"> • Search from the Bluetooth device again. • Reset the unit. (➔ 3)
	Pairing cannot be made.	<ul style="list-style-type: none"> • Make sure you have entered the same PIN code to both the unit and Bluetooth device. • Delete pairing information from both the unit and the Bluetooth device, then perform pairing again. (➔ 12)
	“DEVICE FULL” appears.	The number of registered devices has reached its limit. Retry after deleting an unnecessary device. (➔ 15, DEVICE DELETE)
	Echo or noise occurs.	<ul style="list-style-type: none"> • Adjust the microphone unit’s position. (➔ 12) • Check the [ECHO CANCEL] setting. (➔ 13)
	Phone sound quality is poor.	<ul style="list-style-type: none"> • Reduce the distance between the unit and the Bluetooth device. • Move the car to a place where you can get a better signal reception.

	Symptom	Remedy
Bluetooth®	<ul style="list-style-type: none"> • Voice calling method is not successful. • “N/A VOICE TAG” appears. 	<ul style="list-style-type: none"> • Use voice calling method in a more quiet environment. • Reduce the distance from the microphone when you speak the name. • Make sure the same voice as the registered voice tag is used.
	“NOT SUPPORT” appears.	The connected phone does not support Voice Recognition feature.
	<ul style="list-style-type: none"> • “NO ENTRY” appears. • “NO PAIR” appears. 	There is no registered device connected/found via Bluetooth.
	“ERROR” appears.	Try the operation again. If “ERROR” appears again, check if the device supports the function you have tried.
	“NO INFO” appears.	Bluetooth device cannot get the contact information.
	Sound is being interrupted or skipped during playback of a Bluetooth audio player.	<ul style="list-style-type: none"> • Reduce the distance between the unit and the Bluetooth audio player. • Turn off, then turn on the unit and try to connect again. • Other Bluetooth devices might be trying to connect to the unit.
	The connected Bluetooth audio player cannot be controlled.	<ul style="list-style-type: none"> • Check whether the connected Bluetooth audio player supports Audio/Video Remote Control Profile (AVRCP). (Refer to the instructions of your audio player.) • Disconnect and connect the Bluetooth player again.
	<ul style="list-style-type: none"> • “HF ERROR XX” appears. • “BT ERROR” appears. 	Reset the unit and try the operation again. If this does not solve the problem, consult your nearest service center.

⚠ Warning

- The unit can only be used with a 12 V DC power supply, negative ground.
- Disconnect the battery's negative terminal before wiring and mounting.
- Do not connect Battery wire (yellow) and Ignition wire (red) to the car chassis or Ground wire (black) to prevent a short circuit.
- Insulate unconnected wires with vinyl tape to prevent a short circuit.
- Be sure to ground this unit to the car's chassis again after installation.

⚠ Caution

- For safety's sake, leave wiring and mounting to professionals. Consult the car audio dealer.
- Install this unit in the console of your vehicle. Do not touch the metal parts of this unit during and shortly after use of the unit. Metal parts such as the heat sink and enclosure become hot.
- Do not connect the \ominus wires of speakers to the car chassis or Ground wire (black), or connect them in parallel.
- Mount the unit at an angle of less than 30°.
- If your vehicle wiring harness does not have the ignition terminal, connect Ignition wire (red) to the terminal on the vehicle's fuse box which provides 12 V DC power supply and is turned on and off by the ignition key.
- After the unit is installed, check whether the brake lamps, blinkers, wipers, etc. on the car are working properly.
- If the fuse blows, first make sure the wires are not touching car's chassis, then replace the old fuse with one that has the same rating.

Basic procedure

- 1 Remove the key from the ignition switch, then disconnect the \ominus terminal of the car battery.
- 2 Connect the wires properly.
See Wiring connection. (→ 23)
- 3 Install the unit to your car.
See Installing the unit (in-dash mounting).
- 4 Connect the \ominus terminal of the car battery.
- 5 Reset the unit. (→ 3)

Installing the unit (in-dash mounting)

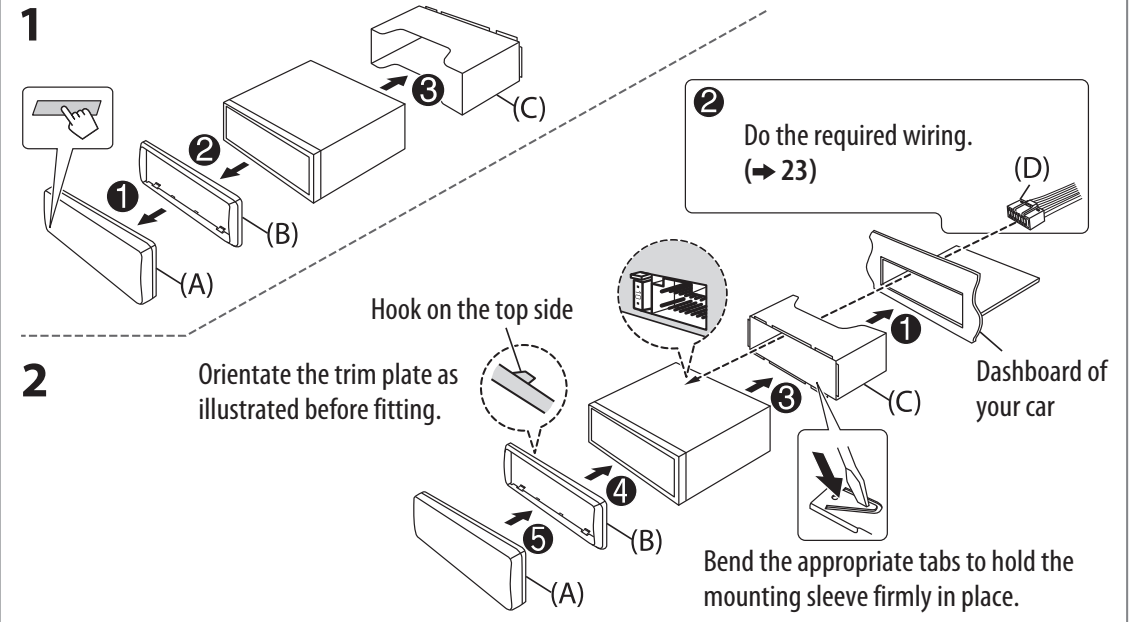

When installing without the mounting sleeve

- 1 Remove the mounting sleeve and trim plate from the unit.
- 2 Align the holes in the unit (on both sides) with the vehicle mounting bracket and secure the unit with screws (commercially available).

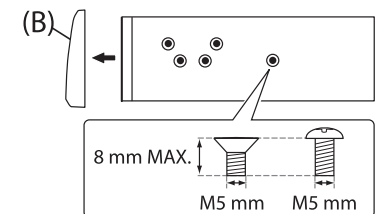

⚠ Use only the specified screws. Using wrong screws might damage the unit.

How to remove the unit

- 1 Detach the faceplate.
- 2 Fit the catch pin on the extraction keys into the holes on both sides of the trim plate, then pull it out.
- 3 Insert the extraction keys deeply into the slots on each side, then follow the arrows as shown on the right.

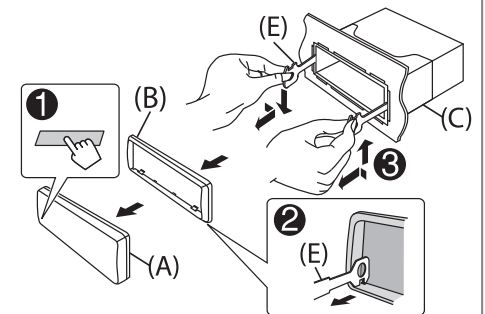

Wiring connection

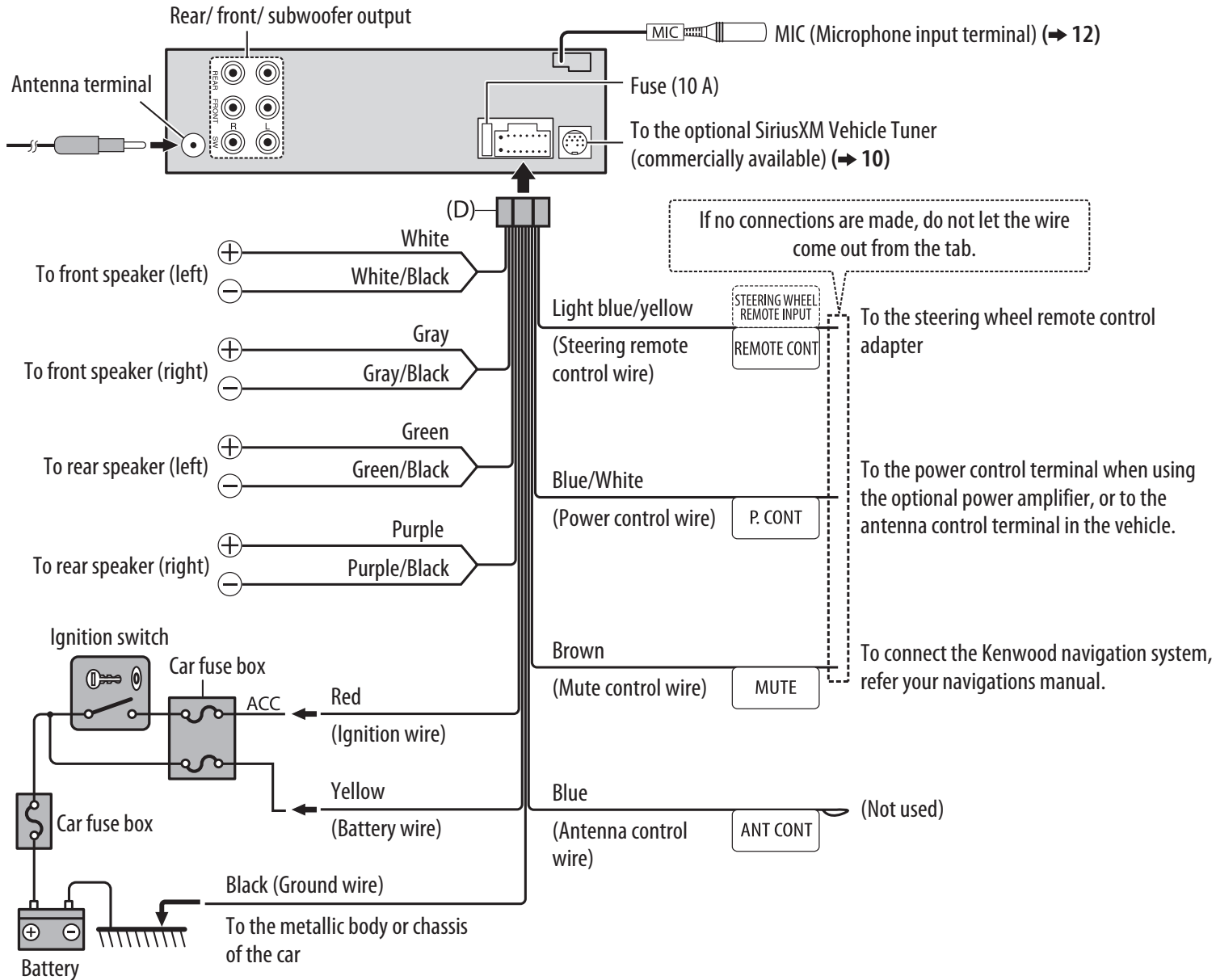

Part list for installation

(A) Faceplate

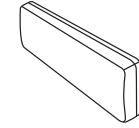

(×1)

(B) Trim plate

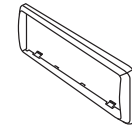

(×1)

(C) Mounting sleeve

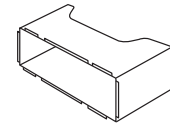

(×1)

(D) Wiring harness

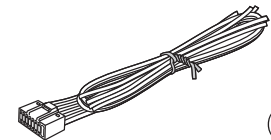

(×1)

(E) Extraction key

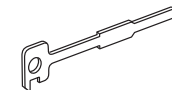

(×2)

SPECIFICATIONS

TUNER	FM	Frequency Range	87.9 MHz — 107.9 MHz (200 kHz space)
		Usable Sensitivity (S/N = 26 dB)	8.2 dBf (0.71 μ V/75 Ω)
		Quieting Sensitivity (DIN S/N = 46 dB)	17.2 dBf (2.0 μ V/75 Ω)
		Frequency Response (± 3 dB)	30 Hz — 15 kHz
		Signal-to-Noise Ratio (MONO)	64 dB
		Stereo Separation (1 kHz)	40 dB
	AM	Frequency Range	530 kHz — 1 700 kHz (10 kHz space)
	Usable Sensitivity (S/N = 20 dB)	29 dB μ (28.2 μ V)	

CD player	Laser Diode	GaAlAs
	Digital Filter (D/A)	8 times over sampling
	Spindle Speed	500 rpm — 200 rpm (CLV)
	Wow & Flutter	Below measurable limit
	Frequency Response (± 1 dB)	20 Hz — 20 kHz
	Total Harmonic Distortion (1 kHz)	0.01 %
	Signal-to-Noise Ratio (1 kHz)	KDC-X598 : 110 dB Other models: 105 dB
	Dynamic Range	90 dB
	Channel Separation	85 dB
	MP3 Decode	Compliant with MPEG-1/2 Audio Layer-3
WMA Decode	Compliant with Windows Media Audio	

USB	USB Standard	USB 1.1, USB 2.0 (Full speed)
	File System	FAT12/ 16/ 32
	Maximum Supply Current	DC 5 V \equiv 1 A
	MP3 Decode	Compliant with MPEG-1/2 Audio Layer-3
	WMA Decode	Compliant with Windows Media Audio
	WAV Decode	Linear-PCM

Bluetooth	Version	Bluetooth Ver.2.1+EDR Certified
	Frequency Range	2.402 GHz — 2.480 GHz
	Output Power	+4 dBm (MAX), 0 dBm (AVE) Power Class 2
	Maximum Communication Range	Line of sight approx. 10 m (32.8 ft)
	Profile	HFP (Hands-Free Profile) SPP (Serial Port Profile) PBAP (Phonebook Access Profile) OPP (Object Push Profile) A2DP (Advanced Audio Distribution Profile) AVRCP (Audio/Video Remote Control Profile)

Audio	Maximum Output Power	50 W \times 4	
	Full Bandwidth Power	22 W \times 4 (at less than 1 % THD)	
	Speaker Impedance	4 Ω — 8 Ω	
	Tone Action	Bass	200 Hz ± 8 dB
		Middle	2.5 kHz ± 8 dB
		Treble	12.5 kHz ± 8 dB
	Preout Level/Load (CD)	KDC-X598 : 4 000 mV/10 k Ω Other models: 2 500 mV/10 k Ω	
	Preout Impedance	\leq 600 Ω	

Auxiliary	Frequency Response (± 3 dB)	20 Hz — 20 kHz
	Input Maximum Voltage	1 200 mV
	Input Impedance	30 k Ω
General	Operating Voltage	14.4 V (10.5 V — 16 V allowable)
	Maximum Current Consumption	10 A
	Operational Temperature Range	0°C — +40°C
	Installation Size (W \times H \times D)	182 mm \times 53 mm \times 159 mm (7-3/16" \times 2-1/8" \times 6-1/4")
	Weight	1.2 kg (2.65 lbs)

Subject to change without notice.

IC (Industry Canada) Notice

This device complies with Industry Canada licence-exempt RSS standard(s).

Operation is subject to the following two conditions:

- (1) This device may not cause interference, and
- (2) this device must accept any interference, including interference that may cause undesired operation of the device.

The term "IC:" before the certification/ registration number only signifies that the Industry Canada technical specification were met.

Note de IC (Industrie Canada)

Le présent appareil est conforme aux CNR d'Industrie Canada applicables aux appareils radio exempts de licence.

L'exploitation est autorisée aux deux conditions suivantes:

- (1) l'appareil ne doit pas produire de brouillage, et
- (2) l'utilisateur de l'appareil doit accepter tout brouillage radioélectrique subi, même si le brouillage est susceptible d'en compromettre le fonctionnement.

L'expression "IC:" avant le numéro d'homologation/ enregistrement signifie seulement que les spécifications techniques d'Industrie Canada ont été respectées.

CAUTION

This equipment complies with FCC/IC radiation exposure limits set forth for an uncontrolled environment and meets the FCC radio frequency (RF) Exposure Guidelines in Supplement C to OET65 and RSS-102 of the IC radio frequency (RF) Exposure rules. This equipment has very low levels of RF energy that it deemed to comply without maximum permissive exposure evaluation (MPE). But it is desirable that it should be installed and operated keeping the radiator at least 20cm or more away from person's body (excluding extremities: hands, wrists, feet and ankles). Under Industry Canada regulations, this radio transmitter may only operate using an antenna of a type and maximum (or lesser) gain approved for the transmitter by Industry Canada. To reduce potential radio interference to other users, the antenna type and its gain should be so chosen that the equivalent isotropically radiated power (e.i.r.p.) is not more than that necessary for successful communication.

ATTENTION

Cet équipement est conforme aux limites d'exposition aux rayonnements énoncées pour un environnement non contrôlé et respecte les règles d'exposition aux fréquences radioélectriques (RF) CNR-102 de l'IC. Cet équipement émet une énergie RF très faible qui est considérée conforme sans évaluation de l'exposition maximale autorisée. Cependant, cet équipement doit être installé et utilisé en gardant une distance de 20 cm ou plus entre le dispositif rayonnant et le corps (à l'exception des extrémités : mains, poignets, pieds et chevilles). Conformément à la réglementation d'Industrie Canada, le présent émetteur radio peut fonctionner avec une antenne d'un type et d'un gain maximal (ou inférieur) approuvé pour l'émetteur par Industrie Canada. Dans le but de réduire les risques de brouillage radioélectrique à l'intention des autres utilisateurs, il faut choisir le type d'antenne et son gain de sorte que la puissance isotrope rayonnée équivalente (p.i.r.e.) ne dépasse pas l'intensité nécessaire à l'établissement d'une communication satisfaisante.

- Contains Bluetooth Module FCC ID: XQN-BTR60X
- Contains Bluetooth Module IC: 9688A-BTR601

Para cumplimiento de la COFETEL:

"La operación de este equipo está sujeta a las siguientes dos condiciones:

- (1) es posible que este equipo o dispositivo no cause interferencia perjudicial y
- (2) este equipo o dispositivo debe aceptar cualquier interferencia, incluyendo la que pueda causar su operación no deseada"

CAUTION

Use of controls or adjustments or performance of procedures other than those specified herein may result in hazardous radiation exposure. In compliance with Federal Regulations, following are reproductions of labels on, or inside the product relating to laser product safety.

JVC KENWOOD Corporation
2967-3, ISHIKAWA-MACHI,
HACHIOJI-SHI, TOKYO, JAPAN

THIS PRODUCT COMPLIES WITH DHHS RULES 21CFR
SUBCHAPTER J IN EFFECT AT DATE OF MANUFACTURE.

Location : Top Plate

FCC WARNING

This equipment may generate or use radio frequency energy. Changes or modifications to this equipment may cause harmful interference unless the modifications are expressly approved in the instruction manual. The user could lose the authority to operate this equipment if an unauthorized change or modification is made.

FCC NOTE

This equipment has been tested and found to comply with the limits for a Class B digital device, pursuant to Part 15 of the FCC Rules. These limits are designed to provide reasonable protection against harmful interference in a residential installation. This equipment may cause harmful interference to radio communications, if it is not installed and used in accordance with the instructions. However, there is no guarantee that interference will not occur in a particular installation. If this equipment does cause harmful interference to radio or television reception, which can be determined by turning the equipment off and on, the user is encouraged to try to correct the interference by one or more of the following measures:

- Reorient or relocate the receiving antenna.
- Increase the separation between the equipment and receiver.
- Connect the equipment into an outlet on a circuit different from that to which the receiver is connected.
- Consult the dealer or an experienced radio/TV technician for help.

- “Made for iPod,” and “Made for iPhone” mean that an electronic accessory has been designed to connect specifically to iPod, or iPhone, respectively, and has been certified by the developer to meet Apple performance standards. Apple is not responsible for the operation of this device or its compliance with safety and regulatory standards. Please note that the use of this accessory with iPod or iPhone may affect wireless performance.
- iPhone, iPod, iPod classic, iPod nano, and iPod touch are trademarks of Apple Inc., registered in the U.S. and other countries.
- Lightning is a trademark of Apple Inc.
- Pandora, the Pandora logo, and the Pandora trade dress are trademarks or registered trademarks of Pandora Media, Inc., used with permission.
- iHeartRadio® is a registered mark of Clear Channel Broadcasting, Inc. in the United States and other countries. Such marks are used under license.
- Sirius, XM and all related marks and logos are trademarks of Sirius XM Radio Inc. All rights reserved.
- Android is trademark of Google Inc.
- The Bluetooth® word mark and logos are registered trademarks owned by Bluetooth SIG, Inc. and any use of such marks by JVC KENWOOD Corporation is under license. Other trademarks and trade names are those of their respective owners.

Información acerca de la eliminación de equipos eléctricos y electrónicos al final de la vida útil (aplicable a los países que hayan adoptado sistemas independientes de recogida de residuos)



Los productos con el símbolo de un contenedor con ruedas tachado no podrán ser desechados como residuos domésticos. Los equipos eléctricos y electrónicos al final de la vida útil, deberán ser reciclados en instalaciones que puedan dar el tratamiento adecuado a estos productos y a sus subproductos residuales correspondientes. Póngase en contacto con su administración local para obtener información sobre el punto de recogida más cercano. Un tratamiento correcto del reciclaje y la eliminación de residuos ayuda a conservar los recursos y evita al mismo tiempo efectos perjudiciales en la salud y el medio ambiente.

CALIFORNIA, USA ONLY

This product contains a CR Coin Cell Lithium Battery which contains Perchlorate Material—special handling may apply. See www.dtsc.ca.gov/hazardouswaste/perchlorate

Informação sobre a eliminação de pilhas

Este produto não deve ser eliminado como lixo doméstico geral. Devolva a pilha usada ao revendedor ou entidade autorizada para que a mesma seja devolvida ao fabricante ou importador. A reciclagem e a eliminação de lixo de maneira apropriada ajudarão a conservar os recursos naturais ao mesmo tempo que prevenirão os efeitos prejudiciais à nossa saúde e ao meio ambiente.

MILITARY

Units purchased through the U.S.A. military exchange service overseas may be serviced under warranty in the continental U.S.A. subject to the following conditions.

- 1) The original warranty is in effect.
- 2) Proof of purchase is provided to the servicer.

WARRANTY FOR MILITARY MARKET

Kenwood corporation is proud of the quality and workmanship of its audio equipment. This unit has been properly designed, tested and inspected before it was shipped to you. If properly installed and operated in accordance with instructions furnished, it should give you an optimum reliable performance.

WARRANTY PERIOD

This product is warranted for a period of (1) year from the date of the original purchase.

SCOPE OF WARRANTY

Except as specified below, this warranty covers all defects in materials and workmanship of the Kenwood brand products.

During the warranty period, any authorized Kenwood Service Center in the military market listed in the back of this warranty card will provide you free-of-charge both parts and labor required to correct any defect in materials or workmanship.

The following are not covered by this warranty.

1. Voltage conversions.
2. Periodic check-ups which do not disclose any defect covered by the warranty.
3. Cabinets, grilles, other exterior finishes, belts, tape heads, and other non-durable parts and accessories.
4. Units on which the serial number has been effaced, modified or removed.
5. Installation and/or removal charges.
6. Damaged magnetic tapes.
7. House call charges for any repairs.
8. Shipping or delivery charges to or from an authorized Kenwood Service Center.
9. This warranty will not cover any failure that is due to any of the following conditions in accordance with the visual inspection of the authorized Kenwood Service Center:
 - * Improper maintenance or repair, including the installation of parts or accessories that do not conform to the quality and specifications of the original parts.
 - * Misuse, abuse, neglect, unauthorized product modification or failure to follow instructions contained in the Owner's Manual.
 - * Accidental or intentional damages.
 - * Repairs or attempted repairs by an unauthorized agency. (All repairs must be performed at an authorized Kenwood Service Center.)
 - * Damages or deteriorations caused during shipment. (Claims must be presented to the carrier).
 - * Damages or deteriorations resulting from removal and/or replacement.

PURCHASER'S RESPONSIBILITIES

As the purchaser of a new Kenwood brand product, you are requested to do the following in order to obtain Kenwood warranty service.

1. Retain your sales slip or other evidence of purchase for proving your eligibility for requesting Kenwood warranty service.
2. Make your unit available to an authorized Kenwood Service Center in the military market for inspection and approved warranty service, or ship your unit in its original carton box or equivalent, fully insured and shipping charges prepaid, to the authorized Kenwood Service Center.

LIMITATION OF IMPLIED WARRANTIES

Any and all implied warranties, including warranties of merchantability and fitness for a particular purpose, shall be limited in duration to the length of this warranty.

EXCLUSION OF CERTAIN DAMAGES

KENWOOD's liability for any defective product is limited to the repair or replacement of said product, at our option, and shall not include damages of any kind, whether incidental, consequential or otherwise, except to the extent prohibited by applicable law.

KENWOOD AUTHORIZED SERVICE CENTERS IN MILITARY MARKET

JAPAN:

Yokota

Kenwood Rep.; c/o
Yokota BX, JAAX AAFES-PAC,
APO San Francisco 96328

Zama

Kenwood Rep.; c/o
Zama PX, JAAX AAFES-PAC,
APO San Francisco 96343

Misawa

Kenwood Rep.; c/o
Misawa BX, JAAX AAFES-PAC,
APO San Francisco 96519

Yokosuka

Kenwood Rep.; c/o
A-33, Yokosuka NEX No. 260-010
FPO Seattle 98760

Atsugi

Kenwood Rep.; c/o
Atsugi NEX No. 260-020 FPO Seattle
98767

Iwakuni

Kenwood Rep.; c/o
Marine Corps Exchange, Marine Corps
Air Station,
FPO Seattle 98764

Sasebo

Sasebo NEX;
Navy Exchange 260-040
F.A. Box 115 FPO Seattle 98766

Okinawa

Kenwood Rep.; c/o
OWAX, AAFES-PAC, APO San Francisco
96230

KOREA:

Kenwood Rep.; c/o
KOAX Repair Shop, AAFES-PAC
DD-Camp Market, APO San Francisco
96488

GUAM:

Kenwood Rep.; c/o
Guam NEX No. 230-010,
FPO San Francisco 96630
Kenwood Rep.; c/o
GUAX, AAFES-PAC, APO San Francisco
96334

U.S.A.:

Hawaii

Kenwood Factory Service
99-994 Iwaena St., Aiea, Hawaii 96701

Alaska

Vista Radio TV;
861 East Loop Road, Anchorage, Alaska
99501
Anchorage Commercial Electronics, Inc.;
1450 East 9th Ave., Anchorage, Alaska
99501

In The Continental U.S.A.

For Nearest Authorized Service Center;
Tel: 1-800-536-9663

Kenwood Service U.S.A.

Kenwood Factory Service;
P.O. Box 22745, 2201 East Dominguez
Street,
Long Beach, California 90801-5745
Tel: (310) 639-5300

EUROPE:

Please inquire at the military resale outlets where you bought your Kenwood products, or
KENWOOD ELECTRONICS
DEUTSCHLAND GMBH:
Rembrücker-Str. 15, 63150 Heusenstamm,
Germany
Tel.: 49-06104-69010

KENWOOD

Warranty Card

Identification du produit
Modelo do aparelho e numero de série
Model number & serial number

Revendeur & cachet
Nome da loja e carimbo
Dealer & stamp

Date d'achat
Data da compra
Purchase date

Nom & adresse du client
Nome e endereço do cliente
Name & address of customer

Attention:

This card and receipt (or invoice) are necessary to purchase a new panel in case of theft or damage.

Attention:

Vous aurez besoin de cette carte et du reçu (ou de la facture) pour acheter un nouveau panneau en cas de vol ou d'endommagement.

Atenção:

Em caso de dano ou perda do painel frontal, este Certificado de Garantia e a Nota Fiscal de compra serão requisitados para a aquisição de um novo painel.

© B46-0824-00/01 (K) (12/07)

Dear Customer,

Thank you for purchasing this Kenwood product. As mentioned in the pages of this booklet, our warranty is only valid in the countries listed. If your country is not listed please contact your retailer for information on warranty procedure, or write to:

JVC KENWOOD Customer Information Center

3-12, Moriyacho, Kanagawa-ku, Yokohama-shi, Kanagawa 221-0022, Japan

U.S.A. KENWOOD USA CORPORATION

This warranty will be honored only in the U.S.A.

KENWOOD LIMITED WARRANTY FOR CAR STEREO COMPONENTS

HOW LONG IS THE WARRANTY

Kenwood U.S.A. Corporation ("Kenwood") warrants this product for a period of one (1) year from the date of original purchase.

WHAT IS COVERED AND WHAT IS NOT COVERED

Except as specified below, this warranty covers all defects in material and workmanship in Kenwood car stereo components. The following are not covered by the warranty:

- 1. Any product which is not distributed in the U.S.A. by Kenwood or which is not purchased in the U.S.A. from an authorized Kenwood car stereo dealer or an automobile dealer, unless the product is purchased through the U.S.A. Military Exchange Service.
2. Any product on which the serial number has been defaced, modified or removed.
3. Damage, deterioration or malfunction resulting from:
a. Any shipment of the product (claims must be presented to the carrier).
b. Installation or removal of the product.
c. Accident, acts of nature, misuse, abuse, neglect, unauthorized product modification or failure to follow instructions supplied with the product.
d. Repair or attempted repair by anyone not authorized by Kenwood.
e. Any other cause which does not relate to a product defect.

WHO IS PROTECTED

This warranty is enforceable only by the original purchaser.

WHAT WE WILL PAY FOR

We will pay for all labor and material expenses for covered items. Payment of shipping charges is discussed in the next section of this warranty.

HOW TO OBTAIN WARRANTY SERVICE

If your KENWOOD product ever needs service:
1. Take or ship it to any KENWOOD Authorized Service Center in the U.S.A. along with a complete description of the problem. (If you are uncertain as to whether a Service Center is authorized, please call 1-800-KENWOOD for the nearest Service Center. 1-800-536-9663).
2. Although you must pay any shipping charges if it is necessary to ship the product for warranty service, we will pay the return shipping charges if the repairs are covered by the warranty within the United States.
3. Whenever your units are taken or sent for warranty service, you must include a copy of the original dated sales receipt as proof of warranty coverage.

LIMITATION OF IMPLIED WARRANTIES

ALL IMPLIED WARRANTIES, INCLUDING WARRANTIES OF MERCHANTABILITY AND FITNESS FOR A PARTICULAR PURPOSE, ARE LIMITED IN DURATION TO THE LENGTH OF THIS WARRANTY.

EXCLUSION OF DAMAGES

KENWOOD'S LIABILITY FOR ANY DEFECTIVE PRODUCT IS LIMITED TO THE REPAIR OR REPLACEMENT OF THE PRODUCT AT OUR OPTION. KENWOOD SHALL NOT BE LIABLE FOR:
1. INSTALLATION OR REMOVAL CHARGES, DAMAGE TO OTHER PROPERTY CAUSED BY ANY DEFECTS IN KENWOOD CAR STEREO COMPONENTS, DAMAGES BASED UPON INCONVENIENCE, LOSS OF USE OF THE PRODUCT; OR
2. ANY OTHER DAMAGES, WHETHER INCIDENTAL, CONSEQUENTIAL OR OTHERWISE.
SOME STATES DO NOT ALLOW LIMITATIONS ON HOW LONG AN IMPLIED WARRANTY LASTS AND/OR DO NOT ALLOW THE EXCLUSION OR LIMITATION OF INCIDENTAL OR CONSEQUENTIAL DAMAGES, SO THE ABOVE LIMITATIONS AND EXCLUSIONS MAY NOT APPLY TO YOU.

This warranty gives you specific legal rights, and you may also have other rights which vary from state to state.

If a problem develops during or after the Limited Warranty Period, or if you have any questions regarding the operation of the product, you should contact your KENWOOD Authorized Dealer or Authorized Service Center. If the problem or your question is not handled to your satisfaction, please contact our Customer Relations Department at the address listed below:

KENWOOD USA CORPORATION
P.O. Box 22745, 2201 East Dominguez
Street, Long Beach, CA 90801-5745
Tel: (310) 639-5300

BRASIL JVC KENWOOD DO BRASIL COMÉRCIO DE ELETRÔNICOS LTDA

O fabricante garante o produto identificado na Nota Fiscal de venda ao consumidor contra qualquer defeito de fabricação ou de matéria-prima durante o período de garantia. Esta garantia é válida no território brasileiro desde que o produto tenha sido adquirido no Brasil e distribuído pela JVC KENWOOD do Brasil Comércio de Eletrônicos Ltda.

PERÍODO DA GARANTIA

Este produto é garantido pelo prazo de 01 (um) ano, incluindo o período estabelecido por lei, a partir da data de aquisição, comprovada mediante a apresentação da respectiva Nota Fiscal de venda ao consumidor final. Eventuais reparos realizados no produto durante o período de garantia não implicam na dilatação do seu prazo.

EXCLUSÃO DA GARANTIA

- (a) Produtos com o número de série ou certificado de garantia rasurados, adulterados ou ilegíveis;
(b) Defeitos resultantes de acidentes (quedas, batidas e etc), uso em desacordo com o manual de instruções, má utilização, ligação à fonte de tensão diferente da especificada no Manual de Instruções, modificações não autorizadas;
(c) Danos causados por agentes da natureza (Ex: chuvas, raios, maresia, enchentes e etc);
(d) Defeitos ou danos em decorrência de consertos realizados por pessoas não autorizadas;
(e) Defeitos ou danos resultantes do uso de peças ou dispositivos não conformes às especificações da JVC KENWOOD;
(f) Danos ou deteriorações aos acabamentos externos, partes cosméticas, cabos, chicotes, parafusos de fixação, luvas, alças, bolsas, estojos, adaptadores, antenas, fitas, cabecas gravadoras, CDs ou danos causados por pilhas defeituosas ou com vazamento;
(g) Defeitos ou danos devido ao transporte (reclamações devem ser feitas junto à empresa transportadora);
(h) Qualquer outra causa que não esteja relacionada a defeitos de matéria-prima e de fabricação;
(i) Danos causados por tentativa de roubo ou furto;
(j) Danos causados por uso de CDs de má qualidade;
(k) Danos decorrentes do desgaste natural do produto;
(l) Danos causados por mau uso. (derramamento de líquidos e/ou alimentos, corrosão, oxidação, exposição à umidade ou situações climáticas extremas, riscos ou quedas).

CONCERTO EM GARANTIA

É indispensável a apresentação deste Certificado de Garantia devidamente preenchido, acompanhado da respectiva Nota Fiscal de compra do produto, desde que não apresente rasuras ou modificações. O consumidor somente terá direito a estes benefícios, quando o produto for entregue diretamente no balcão de um Serviço Autorizado da JVC KENWOOD.

O QUE NÃO É COBERTO PELA GARANTIA

Instalação e remoção do produto, despesas de frete, seguro e embalagem são de responsabilidade do proprietário.

Este produto é destinado exclusivamente ao uso doméstico.

IMPORTANTE:

Para qualquer informação sobre seu equipamento JVC KENWOOD, ou para obter o endereço do Serviço Autorizado mais próximo, acesse o site www.kenwood.com.br, ou ligue para a Central de Atendimento JVC KENWOOD – Tel.: +55 (11) 3777-6771 com os dados abaixo preenchidos.

JVC KENWOOD DO BRASIL COMÉRCIO DE ELETRÔNICOS LTDA
Tel: (11) 3777-6771
www.kenwood.com.br

Nome do consumidor: _____
Endereço: _____ CEP: _____
Cidade: _____ Estado: _____
Telefone: _____
Data da compra: ____ / ____ / ____ Nota Fiscal: _____

CANADA KENWOOD ELECTRONICS CANADA INC.

KENWOOD WARRANTY

KENWOOD ELECTRONICS CANADA INC. (hereinafter called "KENWOOD"), gives the following written warranty to the original customer of each new Kenwood product distributed in Canada by KENWOOD and purchased from a dealer authorized by KENWOOD.

KENWOOD warrants that each new Kenwood product, under normal use, is free from any defects, subject to the terms and conditions set forth below. If a defect should occur within the warranty period, repairs will be made free of charge for parts and labour when such defects are determined by KENWOOD or its' authorized service centres to be attributable to faulty materials or workmanship at time of manufacture. Please contact KENWOOD to confirm if a dealer or service centre is authorized by KENWOOD.

WARRANTY PERIOD

This Kenwood product is warranted for parts and labour for a period of one (1) year from the date of original purchase, lease or rental, except for products which are used in a professional or commercial application, which are warranted for a period of ninety (90) days for parts and labour and are subject to the terms and conditions of the warranty.

WARRANTY EXCLUSIONS

- This warranty excludes:
(a) Products purchased in a foreign country or purchased in Canada and taken to a foreign country.
(b) Products purchased from a dealer not authorized by KENWOOD.
(c) Products with the serial number defaced, altered or missing.
(d) Periodic check-ups which do not disclose any defects covered by this warranty.

GARANTIE KENWOOD

KENWOOD ELECTRONICS CANADA INC. (ci-après appelée "KENWOOD"), donne par écrit la garantie suivante à l'acheteur original de chaque nouveau produit Kenwood distribué au Canada par KENWOOD et acheté à un concessionnaire autorisé par KENWOOD.

KENWOOD garantit, sous réserve des termes et des conditions énoncés ci-dessous, que chaque nouveau produit Kenwood, dans des conditions d'emploi normales, est exempt de tous défauts. Si l'un défaut se produit pendant la période de garantie, KENWOOD s'engage à assumer le coût des pièces défectueuses et de la main-d'oeuvre nécessaires pour effectuer les réparations pourvu que de tels défauts sont attribuables à des pièces défectueuses employées lors de la fabrication du produit Kenwood ou à la main-d'oeuvre tel qu'établi par KENWOOD ou par l'un de ses centres de service autorisés. Appelez KENWOOD pour vérifier si un concessionnaire ou un centre de service est autorisé par KENWOOD.

PÉRIODE DE GARANTIE

Les pièces et la main-d'oeuvre nécessaires pour la réparation des produits Kenwood sont garanties pendant la période d'un (1) an à compter de la date d'achat, de bail ou de location originale, sauf dans les cas où les produits Kenwood sont employés dans un but professionnel ou commercial, où la garantie des pièces et de la main-d'oeuvre demeure en vigueur pendant une période de quatre-vingt-dix (90) jours sous réserve des termes et des conditions de la garantie.

EXCLUSIONS DE GARANTIE

- Cette garantie ne couvre pas:
(a) les produits achetés à l'étranger ou achetés au Canada et transportés à l'étranger;
(b) les produits achetés à un concessionnaire non autorisé par KENWOOD;
(c) les produits dont le numéro de série manque, a été effacé ou modifié;
(d) les services d'entretien périodiques qui n'indiquent aucun défaut couvert par cette garantie;

- (e) Defects resulting from disaster, accident, abuse, misuse, lightning, power surges, neglect or lack of periodic maintenance, unauthorized modification or failure to follow instructions in the owner's manual.
(f) Defects or damage as a result of repairs performed by a person or party not authorized by KENWOOD.
(g) Defects resulting from the use of parts or devices that do not conform to KENWOOD specifications.
(h) Damage or deterioration occurring to any exterior finishes, cosmetic parts, tape heads, adaptors, antennas, cables, tapes, discs or faults or damage caused by defective or leaking batteries.
(i) Defects or damage occurring during shipping (claims should be presented to the shipping company).
(j) Product voltage and /or line frequency conversions.
(k) Product installation or removal charges.

TO OBTAIN WARRANTY SERVICE

Should your Kenwood product require warranty service, deliver it to any authorized KENWOOD service centre and present the original copy of your bill of sale and this warranty card as proof of warranty, or send your product fully insured and freight prepaid to the nearest authorized KENWOOD service centre. To avoid possible shipping damage, make sure the product is properly packed. Include a copy of your original bill of sale and this warranty card as proof of warranty along with your name, home and /or work telephone number(s), a complete return address and a detailed description of the fault(s). Products repaired within warranty will be returned freight prepaid to destinations within Canada. The customer is responsible for all freight and related costs for the return of product(s) to destinations outside Canada.

L'ENTIÈRE GARANTIE

- (e) les défauts causés par les désastres, les accidents, les abus, les emplois incorrects, les éclairs, les surtensions de courant, les manques de soins ou d'entretiens périodiques, les modifications non autorisées ou les manques de respect du mode d'emploi;
(f) les défauts ou les dommages causés lors de réparations effectuées par une personne ou par une partie non autorisée par KENWOOD;
(g) les défauts causés par l'emploi de pièces ou de dispositifs qui ne se conforment pas aux exigences de KENWOOD;
(h) les finitions extérieures, les pièces cosmétiques, les têtes de bandes, les adaptateurs, les antennes, les câbles, les bandes, les disques endommagés ou déformés, ni les défauts ou dommages causés par des piles défectueuses ou qui fuient;
(i) les défauts ou dommages qui se produisent pendant l'expédition des produits Kenwood (On devrait déposer de telles réclamations auprès des compagnies de transport);
(j) les conversions de tension et/ou de fréquence du produit;
(k) les frais d'installation ou d'enlèvement du produit.

COMMENT OBTENIR DU SERVICE SOUS GARANTIE

Au cas où un service sous garantie de votre produit Kenwood s'avère nécessaire, veuillez livrer le produit à n'importe quel centre de service KENWOOD et présenter la copie originale du contrat de vente et cette carte de garantie en tant que preuve de garantie ou veuillez faire parvenir votre produit assuré et port payé au centre de service KENWOOD autorisé le plus proche. Pour éviter toutes possibilités de dommages pendant le transport, veuillez bien emballer le produit. Veuillez inclure une copie du contrat de vente original et cette carte de garantie en tant que preuve de garantie aussi bien que votre nom, numéros de téléphone au poste de travail et/ou au domicile, votre adresse et une description détaillée des défauts. Les produits sous garantie réparés seront retournés port payé aux destinations à l'intérieur du Canada. Le consommateur sera responsable de tous frais de transport et d'autres frais qui s'y rapportent pour faire expédier les produits à destinations à l'extérieur du Canada.

ENTIRE WARRANTY

This warranty constitutes the entire written warranty given by KENWOOD. No person, party, dealer or service centre or their agents or employees are authorized to extend or enlarge this warranty on behalf of KENWOOD by any written or verbal statement or advertisement or promotion, including any extended warranty program or plan that may be offered by the dealer or service centre, unless approved in writing by KENWOOD.

DISCLAIMER

KENWOOD disclaims any responsibility for loss of time or use of the product or any other indirect, incidental or consequential damage to other products or goods, inconvenience or commercial loss.

NOTICE TO CONSUMER

The provisions contained in this written warranty are not intended to limit, modify, take away, disclaim or exclude any warranties or rights you may have which are set forth in any applicable provincial or federal laws or legislation.

IMPORTANT

This warranty card by itself is not considered by KENWOOD as a valid proof of purchase. When applying for warranty repairs, you must present the original copy of your bill of sale and this warranty card as proof of warranty, so we recommend that they be kept in a safe place, should they be required in the future.

KENWOOD ELECTRONICS CANADA INC.
6070 Kestrel Road, Mississauga,
Ontario, Canada L5T 1S8
Tel.: (905) 670-7211
Fax: (905) 670-7248

RENONCIATION

KENWOOD renonce à toutes responsabilités de perte de temps, d'emploi du produit, de tous dommages indirects ou accessoires causés à d'autres produits ou biens, de tous inconvénients ou de toutes pertes commerciales.

AVIS AUX CONSOMMATEURS

Les stipulations contenues dans la présente garantie écrite n'ont pas pour but de limiter, de modifier, de diminuer, de rejeter ni d'exclure d'autres garanties ni droits énoncés dans n'importe quelles lois ou législations provinciales ou fédérales.

IMPORTANT

KENWOOD ne considère pas cette garantie toute seule comme étant une preuve d'achat valide. Lorsqu'on demande du service sous garantie, il faudra présenter la copie originale du contrat de vente aussi bien que cette carte de garantie en tant que preuve de garantie. On recommande de les conserver dans un lieu sûr au cas où elles s'avèreraient nécessaires à l'avenir.

KENWOOD ELECTRONICS CANADA INC.
6070 Kestrel Road, Mississauga,
Ontario, Canada L5T 1S8
Téléphone: (905) 670-7211
Télécopieur: (905) 670-7248

Free Manuals Download Website

<http://myh66.com>

<http://usermanuals.us>

<http://www.somanuals.com>

<http://www.4manuals.cc>

<http://www.manual-lib.com>

<http://www.404manual.com>

<http://www.luxmanual.com>

<http://aubethermostatmanual.com>

Golf course search by state

<http://golfingnear.com>

Email search by domain

<http://emailbydomain.com>

Auto manuals search

<http://auto.somanuals.com>

TV manuals search

<http://tv.somanuals.com>