

KENWOOD

Microwave / Combination Oven

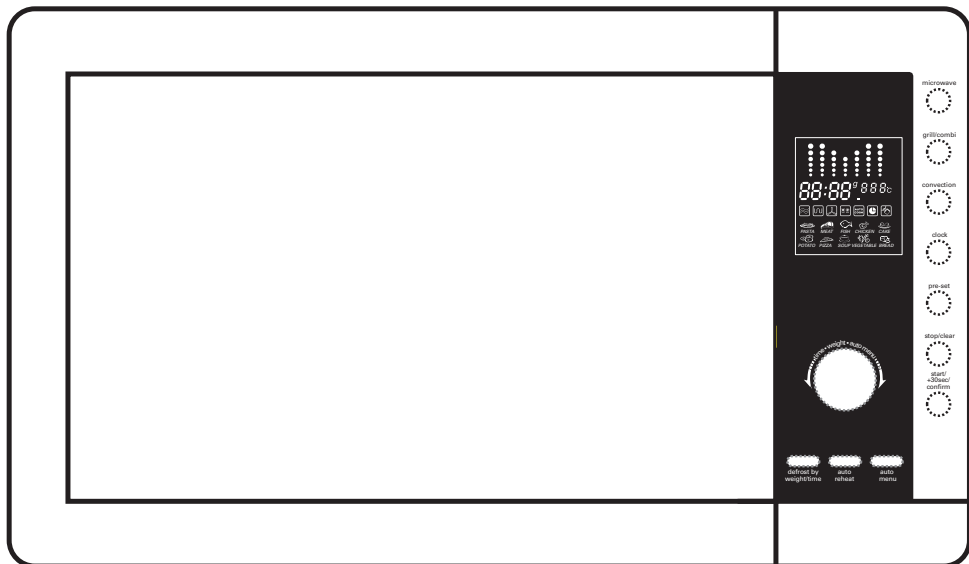

KEN CJ99SSA



**DSG Retail Limited is responsible for after sales service.
If you have a query about the product please contact our product support line
0844 561 6263 (Currys) and 08700 118 117 (Pixmania).**

table of contents

table of contents	2 - 3
know your Kenwood microwave	4
safety information	4 - 8
using aluminium foil in your microwave	9
unpacking and getting ready	10
introducing microwave cooking	11 - 16
cooking with a microwave	11 - 12
microwave heating categories	13
<hr/>	
microwave cooking	19
grill or combination cooking	20 - 21
convection cooking (with preheating)	22
convection cooking (without preheating)	23
multi-stage cooking	24
delay start cooking (program set in advance)	25
auto cooking	26 - 27
auto menu	26 - 27
quick start cooking	28
auto reheat cooking	29
defrosting	30 - 31
defrost by weight	30
defrost by time	31
querying the cooking function	32
to find out the cooking power	32
to find out the time	32
<hr/>	
cleaning your microwave	34 - 35
troubleshooting	36 - 37
questions and answers	36 - 37
specification	38

steam	14
condensation	14
product overview	14 - 15
control panel overview	15
checking your microwave	16
clock setting	17
setting the child lock	18

to find out the pre-set time	32
------------------------------	----

before use

operating instructions

**care, maintenance and
troubleshooting**

know your Kenwood microwave

before using your Kenwood microwave

- Read these instructions carefully and retain for future reference.
- Remove all packaging labels. Please dispose of them properly.

before calling for service

- Review the section on Troubleshooting. This will help you to solve some general problems by yourself and reduce the need to ask for the help of professional technicians.

safety information

general safety

- Switch off and unplug before fitting or removing tools/ attachments, after use and before cleaning.
- Keep your fingers away from moving parts and fitted attachments.
- Never use a damaged machine.
- Never operate the machine when it is empty.
- Keep cord out of reach from children.
- Keep power unit, cord or plug away from water.
- Never exceed the maximum capacities.
- When using an attachment, read the accompanying safety instructions.
- Take care when lifting this appliance as it is heavy.
- This appliance is not intended for use by persons (including children) with reduced physical, sensory or mental capabilities, or lack of experience and knowledge, unless they have been given supervision or instruction concerning use of the appliance by a person responsible for their safety.
- Children should be supervised to ensure that they do not play with the appliance.
- Only use the appliance for its intended domestic use.
The company responsible for this product, DSG Retail Limited, will not accept any liability if the appliance is subject to improper use, or failure to comply with these instructions.

safety information

please read carefully and keep for future reference

maintenance of your microwave

WARNING  : *It is hazardous for anyone other than a qualified technician to carry out any service or repair operation which involves the removal of a cover that gives protection against exposure to microwave energy.*

WARNING  : If the door or door seals are damaged, the oven must not be operated until it has been repaired by a qualified technician.

- If smoke is observed, switch off or unplug the appliance and keep the door closed in order to contain any flames.
- If the supply cord is damaged, it must be replaced by a service agent or similar qualified technician.
- If you have a pacemaker, please contact your doctor before using a microwave oven.

microwave use

- This microwave is not intended for commercial use.
- It should never be used for drying clothes or other non-food purposes.
- The microwave should not be left unattended when in use.
- The temperature of accessible surfaces may be high when the appliance is operating.
- To prevent high moisture content gathering inside the oven cavity, open the door immediately after the cooking function has stopped to allow steam to escape.
- Only use utensils that are suitable for microwave use.
- Care should be taken so metal objects are not used in the microwave.
 - These include :
 - “ Metal cooking utensils
 - “ Metal plates or trays
 - “ Wire twist ties
 - “ Crockery with metal trims
 - “ Meat thermometer
- Care should be taken when using paper, plastic, wooden or other combustible materials in the oven as they can catch fire.
- Oil & fat for deep frying should not be heated in the microwave.
- Only use cling film designed for microwave use & take extra care when removing the film to avoid steam burns.
- Only heat popcorn that has been designed for microwave use.

safety information

cooking use

As the power of different microwave ovens can vary considerably, care must be taken when first using this appliance as it may cook faster than expected.

- Do not leave the appliance unattended during use.

WARNING  : Only allow children to use the oven without supervision when adequate instructions have been given so that the child is able to use the oven in a safe way and understands the hazards of improper use; DO NOT assume that because a child has mastered one cooking skill he/she can cook everything without close supervision. The microwave MUST NOT be treated nor used like a toy.

- Take care when cooking food with a high sugar or fat content, such as Christmas pudding or fruitcake. The sugar or fat can overheat and in some cases catch fire.

fire!

In the event of fire:

- Keep the oven door closed.
- Turn off the power.
- Unplug the appliance from the mains power.

first aid

Treat scalding by:

- Quickly placing the scald under cold running water for at least 10 minutes.
- Cover with a clean dry dressing. Do not use creams, oils or lotions.

cleaning your microwave

The oven should be cleaned regularly and food deposits removed. Failure to maintain the oven in a clean condition can affect the life of the appliance and possibly result in a hazardous situation. (See cleaning your microwave)

safety information

before use

do not use these in your microwave

- Never use equipment made of metal, except foil in your microwave oven. The microwave energy cannot pass through the metal so it bounces off and sparks against the inside of the oven.
- Stop the microwave straight away if any equipment does cause sparks.
- Remember that some crockery has a metal trim around the edge. Even this trim can cause sparks.

Containers / Certain foods

WARNING  : Pressure will build up in sealed containers and cause them to explode. Therefore, do not use the following in your microwave:

- Sealed containers
 - Capped bottles
 - Vacuum containers
 - Sealed jars
 - Hard-boiled egg
 - Eggs in their shells
 - Nuts
- Always pierce the skin of fruit and vegetables, such as potatoes.
 - Never use scratched, cracked or damaged glass in a microwave. Damaged glass can explode.

delayed boiling

Liquids heated in a microwave can boil up when removing them from the microwave.

Take the following precautions :

- Always stir liquids, before and after cooking.
- Allow them to stand.
- Use containers that are wider at the top than the bottom.

preparing food for babies

Extra care must be taken when preparing food or drink for babies and small children.

- Always test the food or liquid temperature before giving it to a baby.
- When using a baby bottle, ensure the teat is removed before heating.
- When warming milk, ensure the bottle is shaken.

caution!

During cooking, the outer surface will become hot, do not touch outer casing of appliance. Care should be taken not to store any items on top of your microwave oven.

safety information



earthing instructions

- **WARNING: THIS APPLIANCE MUST BE EARTHED.**
- **This appliance is equipped with a cord having an equipment-earthing conductor and an earthing plug.**
- The plug must be plugged into an appropriate outlet that is installed and earthed in accordance with all local standards and requirements.

warning!

- Improper connection of the equipment-earthing conductor can result in a risk of electric shock.
- The wires in the cord are coloured as follows:
 - Green and Yellow = Earth,
 - Blue = Neutral,
 - Brown = Live.
- Check with a qualified electrician or service representative if you are in doubt whether the appliance is properly earthed.
- Never modify the plug provided with the appliance.
- If the plug does not fit properly to the outlet, have a qualified electrician to install a proper outlet.

using aluminium foil in your microwave

It is safe to use aluminium foil in your microwave oven as long as you follow these safety guidelines.

As with all metal, microwave energy cannot pass through foil, but provided that you keep the foil away from the side of the oven it will not cause sparks and there will not be any damage to your oven.

Using foil is a good way of shielding parts of food that you do not want to cook as quickly as others – perhaps where the food is narrower and would otherwise overcook.

Place the foil over the area you want to shield, taking care that the foil will not touch the sides of the oven when the turntable rotates. Only use one piece of foil at a time so that you do not get sparks between the separate pieces.

Follow these guidelines when using foil in your microwave:

- Remove foil lids from containers before using in the microwave. Some lids are made of card with a foil covering – these should be removed too. Use a microwave-safe transparent lid if possible.
- Stir food during cooking if the container has a lid or film cover.
- Always use the glass turntable.
- Use shallow containers with a large surface area. Do not use containers that are more than 1.25in (3.5cm) deep.
- Use oven gloves when handling hot foil containers.
- Do not completely cover food with foil. The microwave energy cannot pass through the foil so the food will not cook.
- Do not let aluminium foil touch the inside of the oven.
- Do not use more than one piece of foil in the oven at the same time.

unpacking and getting ready

This microwave oven is designed for home use. It should not be used for commercial catering.

1. After unpacking your oven, check that it has not been damaged whilst in the box. Make sure there are no dents on the oven, and the door closes properly. A dented or damaged oven could allow microwave energy to escape. Make sure that you have taken all the packaging from inside the oven. Please dispose of the plastic wrappings or bags safely and keep out of the reach of babies and young children.
2. Choose a flat work surface for your microwave away from heat sources such as radiators or fires and away from cold areas. You should allow a 10cm space all around the oven and 30cm above so that warm air can escape from the vents during cooking – This microwave is not designed to be built in. ①
3. Plug your oven into a standard household electrical socket (230-240 volt, 13 amp rated). Avoid using a socket that also has an adaptor and other equipment plugged in. Do not use a multi adaptor.
4. Put the turntable ring inside the oven and place the glass turntable on top of the ring. ②
The turntable is shaped to sit securely on the spindle. You must always use the turntable and ring whenever you use the microwave.

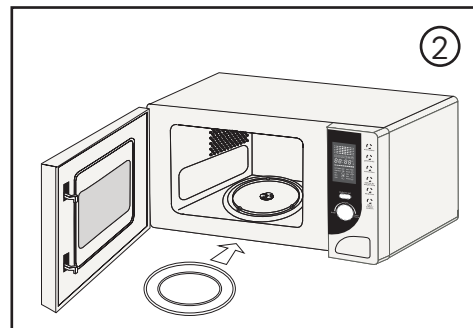
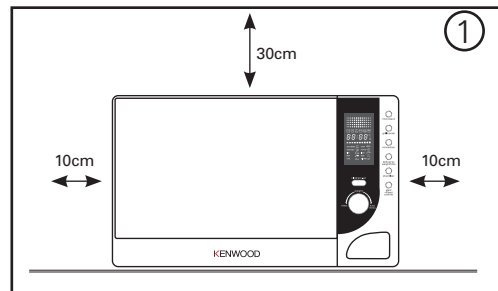

introducing microwave cooking

Always remember the basic safeguards you would follow when using any cooking equipment or handling hot food.

See below for basic guidelines in microwave cooking.

If you are unfamiliar with using a microwave, refer to the back of this instruction booklet for more information.

before use

cooking with a microwave

- Cooking with a microwave is much faster than conventional cooking and, whilst you should make sure that food is fully cooked, you should be careful not to overcook it.
- Microwave energy can heat unevenly so stirring to distribute heat is very important. Always stir from the outside, inwards.
- If you are cooking a number of individual foods at the same time, such as baked potatoes or small cakes, arrange them evenly on the turntable so that they cook evenly. Never stack food in your microwave.
- Turn larger foods such as meat roasts and poultry during cooking so that the top and bottom cook evenly. It is also recommended to turn pieces of meat or poultry, especially if they contain the bone.
- Meat and poultry which is cooked for 15 minutes or more will brown lightly in its own fat. Anything cooked for a shorter time can be brushed with a browning sauce to give an appetising colour.
- Strips of aluminium foil can be used to cover the thinner pieces of food to stop them overcooking before the thicker parts of the food have had a chance to cook. Use the foil sparingly and wrap around the food or container carefully to stop it touching the inside of the oven which could cause sparks.

NOTE: You should always have your microwave checked by a qualified technician if it has been dropped or damaged to ensure it is safe to use.

- Microwave ovens cook food using microwave energy that is similar to naturally occurring radio waves. Normally, these “waves” would fade as they dispersed into the atmosphere but in a microwave oven they are concentrated onto food causing it to heat up.
- Microwave energy cannot pass through metal – so it cannot escape from inside your microwave oven – but it can pass through materials like glass, porcelain, plastic and paper. These materials are used in the manufacture of microwave safe cooking equipment.
- Microwave safe cooking equipment will still get hot as the food it contains heats up.

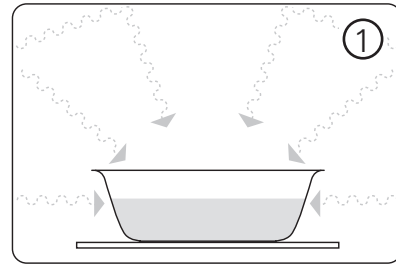

The microwave energy focuses on the moisture in the food causing lots of tiny vibrations. The vibrations get so great that the moisture, and the food heats up. (Fig 1)

checking your cooking utensils

Most heat-resistant, non-metallic cooking utensils are safe to use in your microwave. If you are not sure if you can use a utensil in your microwave, follow this simple test:

1. Put the utensil into the oven next to a cup of water – use a cup that you know is microwave-safe. Close the door.
2. Make sure that the grill is positioned in the upwards position to the top of the microwave (Do not use your hands to touch the grill as it may already be hot). Turn the microwave oven on for 30 seconds only.
3. At the end of the time, carefully check to see if the water has warmed up. If the water has not warmed up but the utensil has, the utensil is not microwave-safe and should not be used in the oven.

microwave heating categories

Your oven has been tested and labelled to meet the government's voluntary agreement on the reheating of pre-cooked food.

The heating characteristics and output power levels of microwave ovens are usually calculated using a relatively large portion of food (a 1000 gram load, IEC 705) but many packs of pre-cooked food are sold in smaller packs, often about 350 grams.

The government, in partnership with food companies and microwave manufacturers, have set up a system of heating categories to help you choose the reheating time for pre-cooked food.





1000W is the output power of the oven.

E is the heating category for your oven. Check the cooking times for category E on the food's packaging to see how long it should be cooked for. Please see below example for reference.

To Microwave:
 Remove outer packaging.
 Pierce film lid SEVERAL TIMES.
 Place on a microwaveable plate.
 Heat on full power.
 Stir or Turn halfway through heating.

To Microwave from frozen:
 Remove outer packaging.
 Pierce film lid SEVERAL TIMES.
 Place on a microwaveable plate.
 Heat on full power.
 Stir or Turn halfway through heating.

	Heating Category		Wattage (IEC 705)	
	B	D	650W	750W
	B	D	650W	750W
Full power (in minutes)	2	2	2	2
Stir / Turn	Stir / Turn		Stir / Turn	
Full power (in minutes)	2	1.5	2	1.5
Standing time (in minutes)	1	1	1	1

	Heating Category		Wattage (IEC 705)	
	B	D	650W	750W
	B	D	650W	750W
Full power (in minutes)	3	2.5	3	2.5
Stir / Turn	Stir / Turn		Stir / Turn	
Full power (in minutes)	4	3.5	4	3.5
Standing time (in minutes)	1	1	1	1

steam

When you microwave food, steam is created as water in the food heats up and evaporates.

The steam formed during microwave cooking is entirely safe. It has to escape from the microwave to prevent pressure from building up inside the oven. It does this through the vents on the back of the oven and from around the door.

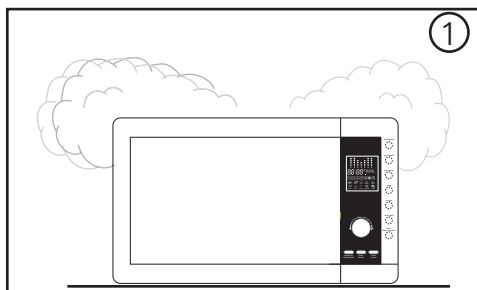

condensation

As the steam cools, you may find the condensation gathers in small pools inside your microwave and on the work surface beneath the door and vents.

Always dry the oven after cooking foods with a high moisture content.

Your microwave is designed to let steam escape from the vents and around the door without microwave energy escaping. (Fig 1)

There is no danger of microwave energy escaping with the steam.

product overview

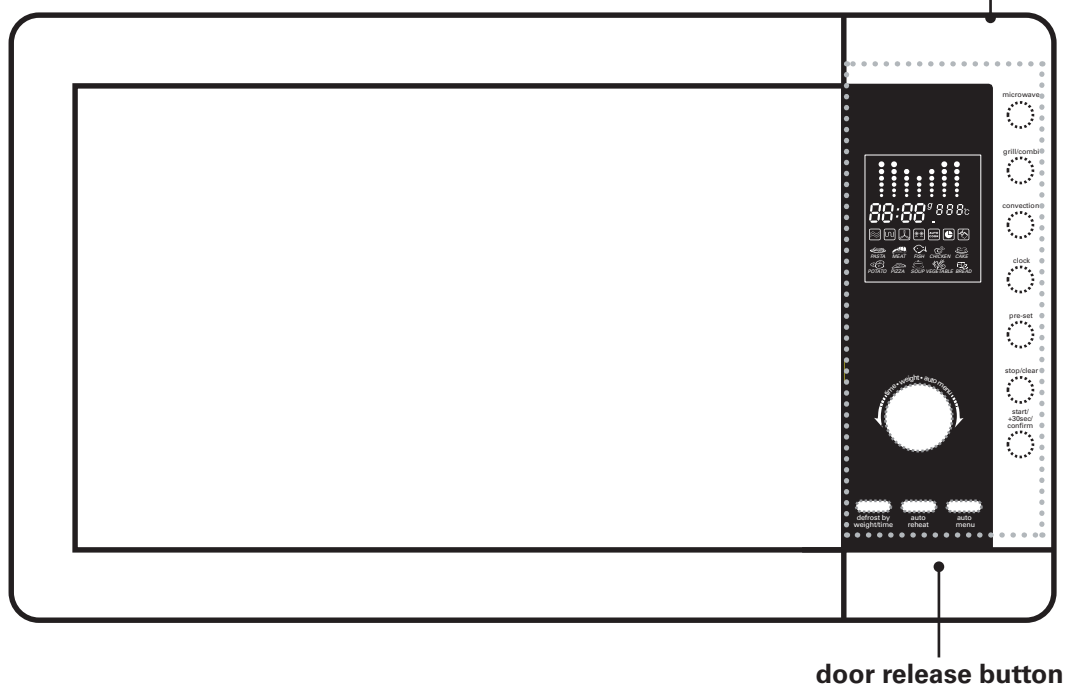

control panel overview

LED display
Shows the clock, cooking time and setting.

time/weight/auto menu dial
Use this dial to set time and food weight and to choose the auto menu programs.

defrost by weight/time button
Use this button to defrost the food by weight or by time.

auto reheat button
Use this button to quickly reheat your food.

microwave button
Use this button to select the microwave function.

grill/combi button
Use this button to select the function of grill, microwave and grill combination.

convection button
Use this button to select the function of convection.

clock button
Use this button to set the clock.

pre-set button
Use this button to preset cooking time.

stop/clear button
Use this button to stop cooking and clear cooking settings.

start/+30 sec./confirm button
Use this button for quick start cooking of 30 seconds, increase cooking time by 30 seconds (by each press), or confirm cooking settings.

auto menu button
Use this button to select the auto menu cooking.

microwave

grill/combi

convection

clock

pre-set

stop/clear

start/+30sec/confirm

defrost by weight/time

auto reheat

auto menu

LED display
88:00 g 888c
PASTA MEAT FISH CHICKEN CAKE
POTATO PIZZA SOUP VEGETABLE BREAD

before use

Accessories

part numbers 252100500504 and 252200200010

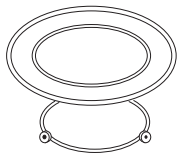

Glass Turnable x 1
Turnable Ring x 1

part number 256511700007



Grill Rack x 1

part number 250900200006

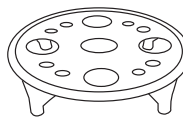

Defrost Rack x 1

part number 261800303126



KENWOOD
Microwave / Combination
Oven

KEN C./9985A

Instruction Manual x 1

checking your microwave

Check your microwave after unpacking.

NOTE: For your safety, the microwave stops if the oven door is opened during cooking. Close the door and press the **start/+30sec./confirm** to continue the cooking cycle.

1. Pull handle to open the door.
Put the turntable ring inside the oven and place the glass turntable on top of the ring. The turntable is shaped to sit securely on the spindle. (Fig 1)
You must always use the glass turntable and turntable ring whenever you use the microwave.
Place a cup of water on the glass turntable. Make sure the cup is microwave-safe - it should not have any decorative metal trim.
2. Close the oven door.
3. Press the **stop/clear** button to clear any settings that have already been made. (Fig 2)
4. Press the **start/+30sec./confirm** once to start a simple 30-second microwave cooking cycle and that allows you to check the operation of the microwave oven.
5. Press the **stop/clear** button to clear any settings once the checking is completed.

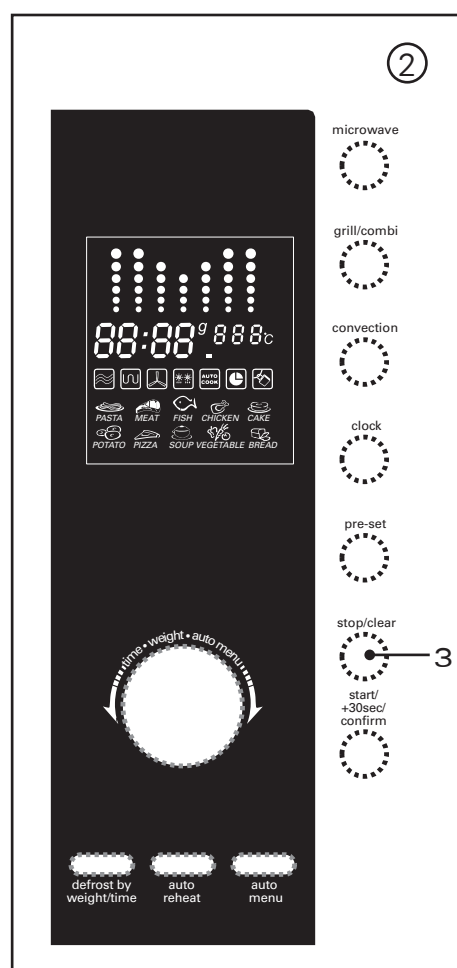
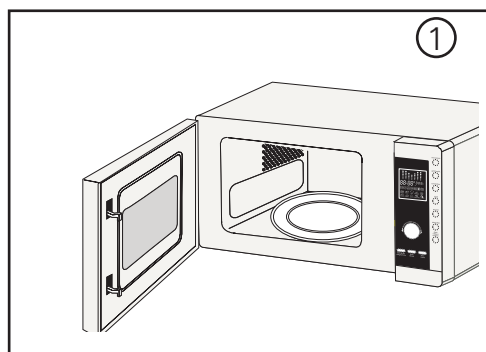

clock setting

When the microwave oven is connected to the mains power, the oven will display **0:00**, and the microwave will sound once. Please ensure you have set the clock prior to use.

Please follow the steps below to set the clock.

1. Press the **clock** to choose 12-hour system or 24-hour system.
2. Turn the **time/weight/auto menu** dial to adjust the hour figures. The input time has to be within 1-12 or 0-23.
3. Press the **clock** again and the minute figures will flash.
4. Turn the **time/weight/auto menu** dial to adjust the minute figures, the input time has to be within 0-59.
5. Press the **clock** again to complete the clock setting.
: will start flashing and the time will illuminate.

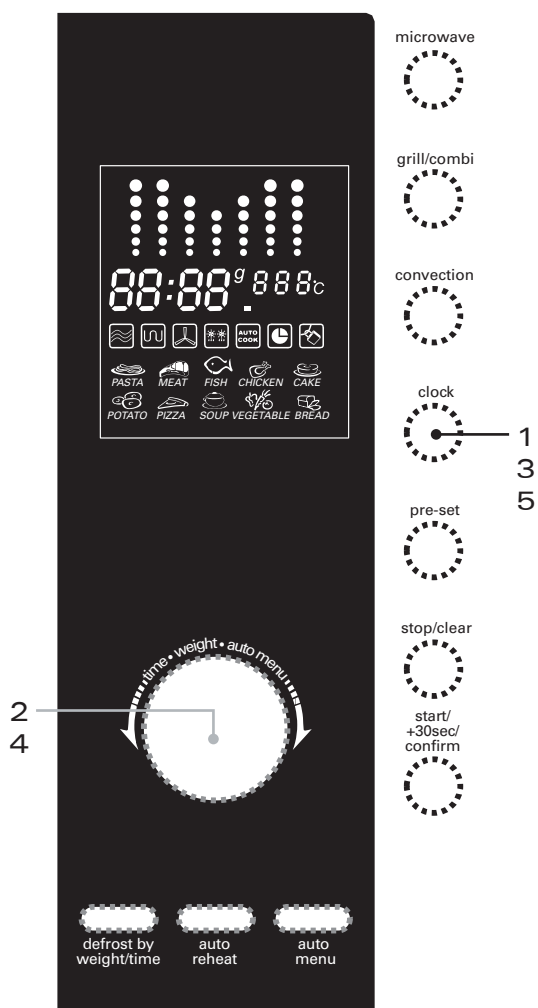

before use

setting the child lock

This feature prevents the electronic operation of the oven by locking the operation of the control panel until you have cancelled it.

Please follow the steps below to set the child lock.

1. Press the **stop/clear** button for 3 seconds and a long tone will sound and the child lock indicator will illuminate to indicate the microwave has set the child lock.
2. To release the child lock, press the **stop/clear** button again for 3 seconds and a long tone will sound and the child lock indicator will disappear to indicate the microwave has released the child lock.

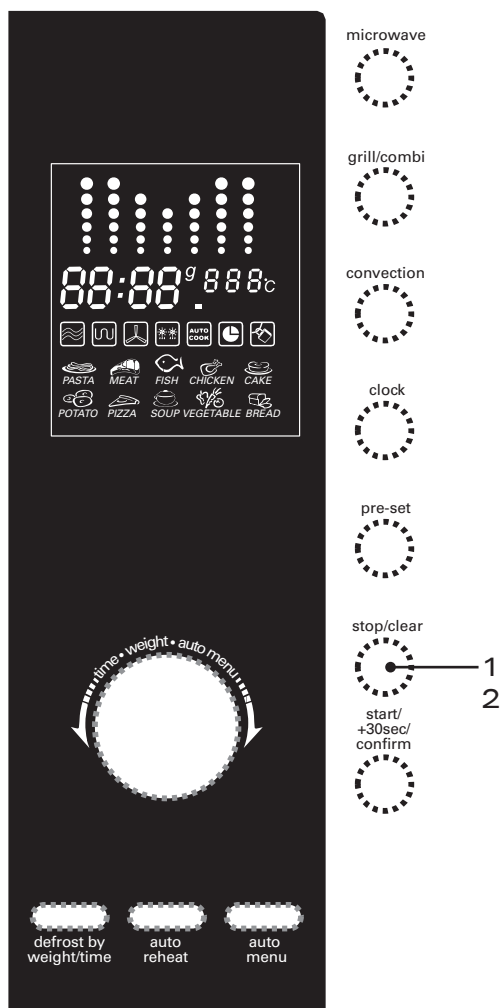

microwave cooking

For simple **Microwave Cooking**, follow the steps below.

For instance: If you want to use 80% microwave power to cook for 20 minutes.

1. Press the **microwave** button once and the LED display will show **P100**. Press the button again to change the microwave power level to **P80**.

NOTE: Alternatively, after you press the **microwave** button once, you can turn the **time/weight/auto menu** dial to change the power level to **P80** as well.

2. Press the **start/+30sec./confirm** button to confirm the microwave power level.
3. Turn the **time/weight/auto menu** dial to adjust the cooking time until the LED display shows **20:00**.
4. Press the **start/+30sec./confirm** button to confirm and start cooking.
5. Press the **stop/clear** button to stop cooking and cancel the setting.

Microwave Button Control		
Order	LED Display	Microwave Power
1	P100	100%
2	P80	80%
3	P50	50%
4	P30	30%
5	P10	10%

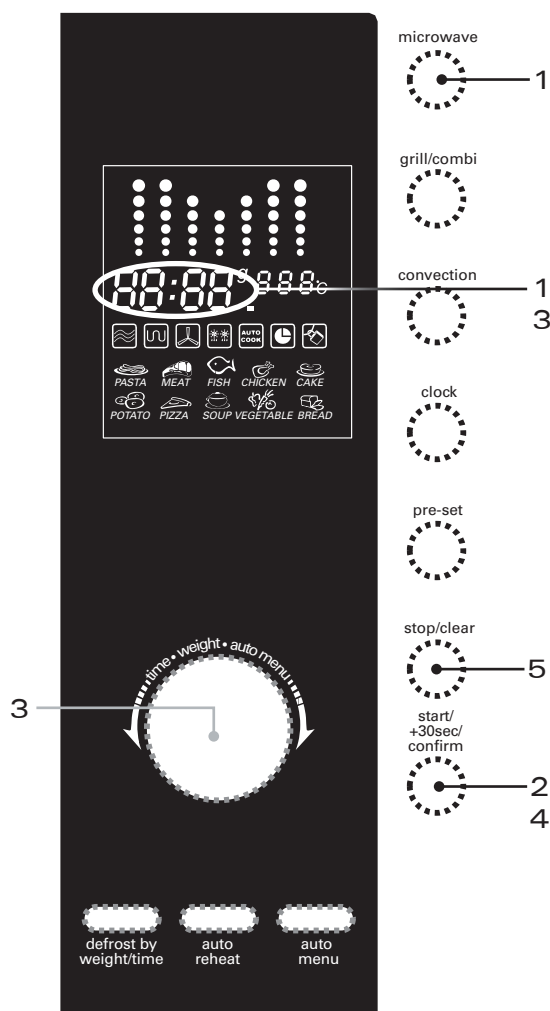

grill or combination cooking

For **Grilling**, follow the steps below.

1. Press the **grill/combi.** button once and the LED display will show **G-1**.
2. Press the **start/+30sec./confirm** button to confirm the grill cooking setting.
3. Turn the **time/weight/auto menu** dial to adjust the cooking time.
4. Press the **start/+30sec./confirm** button to confirm and start cooking.
5. Press the **stop/clear** button to stop the cooking and cancel the setting.

For **Combination Cooking**, follow the steps below.

1. Press the **grill/combi.** button twice and the LED display will show **C-1**. Press the **grill/combi.** button three times and the LED display will show **C-2** and so forth.

NOTE: Alternatively, after you press the **grill/combi.** button once, you can turn the **time/weight/auto menu** dial to change the cooking setting to **C-1**, **C-2**, **C-3**, or **C-4**.

2. Press the **start/+30sec./confirm** button to confirm the cooking setting.
3. Turn the **time/weight/auto menu** dial to adjust the cooking time. The time setting is between 0:05 - 95:00.
4. Press the **start/+30sec./confirm** button to confirm and start cooking.
5. Press the **stop/clear** button to stop cooking and cancel the setting.

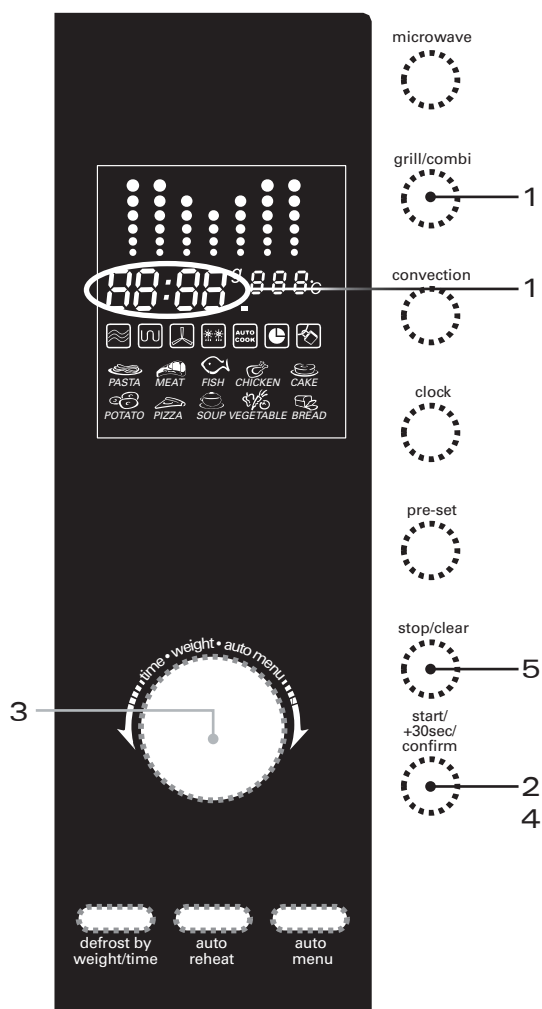

NOTE: The microwave will sound twice to for the cooking session, this is normal. In order to obtain better grilling your food over periodically. Press the and open the door. Then, turn your Press the **start/+30sec./confirm**

Grill/Combi. Button Control					
Order	LED Display	Microwave Power	Grill Power	Convection	Cavity Temperature
1	G-1	X	100%	X	
2	C-1	50%	X	50%	Approximately keeping at 160 °C
3	C-2	50%	100%	X	
4	C-3	X	100%	100%	Approximately keeping at 195 °C
5	C-4	30%	70%	70%	

Please note that there are only 4 modes of Combination Cooking and their Microwave, Grill and Convection Powers are indicated as per above table.

For instance: If you want to do 50% microwave power and 100% grill power cooking (**C-2**) for 10 minutes, please follow the steps below.

1. Press the **grill/combi.** button three times and the LED display will show **C-2**.

NOTE: Alternatively, after you press the **grill/combi.** button once, you can turn the **time/weight/auto menu** dial to change the cooking setting to **C-2**.

2. Press the **start/+30sec./confirm** button to confirm the cooking setting.
3. Turn the **time/weight/auto menu** dial to adjust the cooking time until the LED display shows **10:00**.
4. Press the **start/+30sec./confirm** button to confirm and start cooking.
5. Press the **stop/clear** button to stop the cooking and cancel the setting.

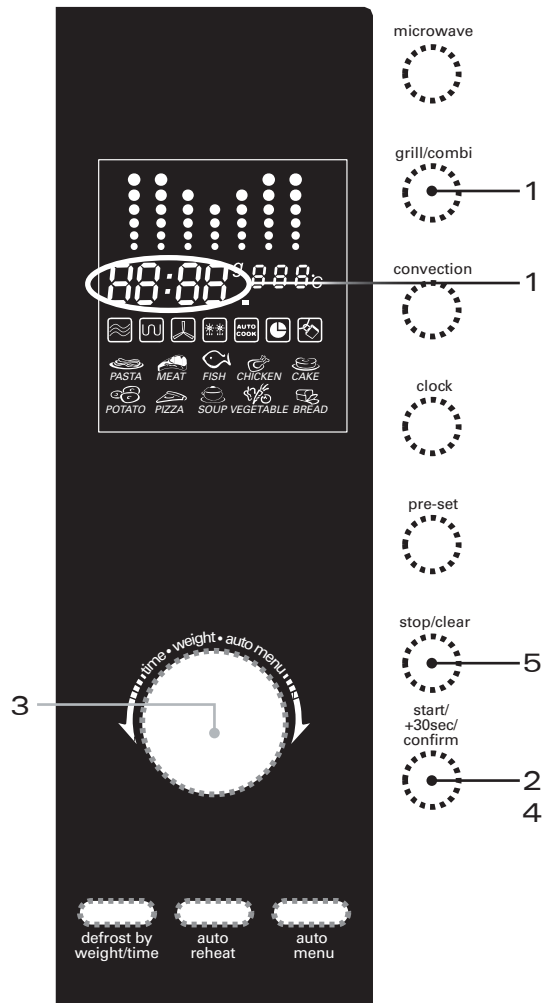

operating instructions

indicate it has reached the half time

performance for your food, please turn **stop/clear** button once to stop cooking food over and close the door. button to continue cooking.

convection cooking (with preheating)

Convection Cooking allows you to cook the food like a traditional oven.

It is recommended to pre-heat the oven to the appropriate temperature before placing the food in the oven. Microwave power will not be used.

1. Press the **convection** button once and the LED display will flash **150**.
2. Keep pressing the **convection** button until the LED display shows your preferred temperature setting. Press the button each time and the temperature will increase 10°C. The temperature ranges from 150°C to 240°C.

NOTE: Alternatively, after you press the **convection** button once, you can turn the **time/weight/auto menu** dial to change to the temperature setting.

3. Press the **start/+30sec./confirm** button to confirm the temperature setting.
4. Press the **start/+30sec./confirm** button again to start preheating. Once the preheating temperature is reached, the oven will sound twice and the LED display will flash the preheating temperature to remind you.
5. Place your food in the oven and close the door. Turn the **time/weight/auto menu** dial to adjust the cooking time. The maximum time setting is 95 minutes.
6. Press the **start/+30sec./confirm** button to confirm and start cooking.

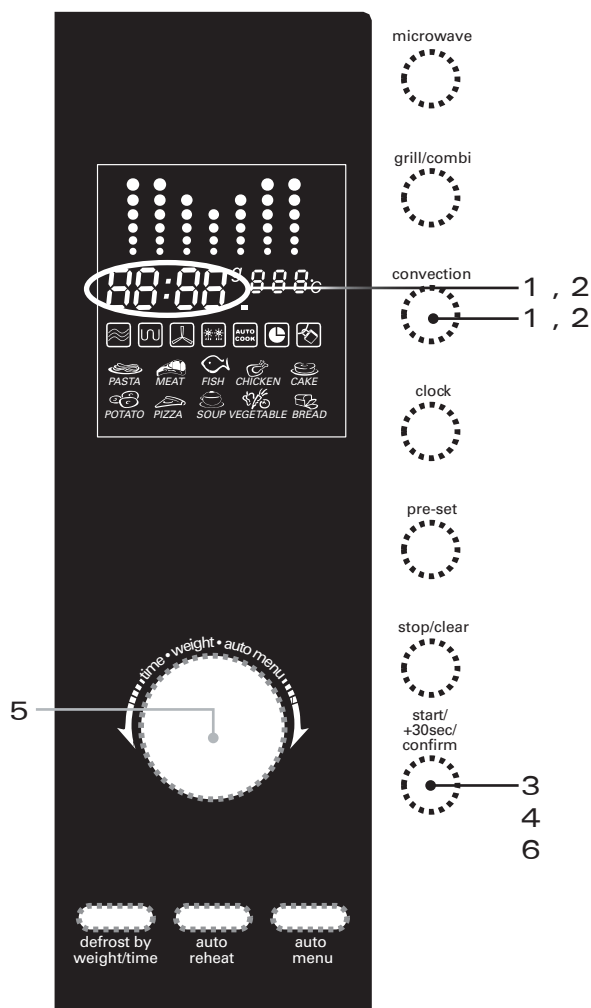

NOTE: Cooking time cannot be input until the preheating temperature is reached and the oven door is opened.

If the preheating temperature is still below your preferred temperature setting after 30 minutes, the oven will sound twice to remind you to input the cooking time.

The cooking time must be input within 5 minutes; otherwise, the oven will stop the preheating, sound 5 times and return to its original display.

convection cooking (without preheating)

For **Convection Cooking** without preheating, please follow the steps below.
For instance: If you want to cook your food for 15 minutes at 180°C.

1. Press the **convection** button once and the LED display will flash **150**.
2. Keep pressing the **convection** button until the LED display shows **180**. The temperature ranges from 150°C to 240°C.

NOTE: Alternatively, after you press the **convection** button once, you can turn the **time/weight/auto menu** dial to change to the temperature setting.

3. Press the **start/+30sec./confirm** button to confirm the temperature setting.
4. Place your food in the oven and close the door. Turn the **time/weight/auto menu** dial to adjust the cooking time to **15:00**. The maximum time setting is 95 minutes.
5. Press the **start/+30sec./confirm** button to confirm and start cooking.
6. Press the **stop/clear** button to stop cooking and cancel the setting.

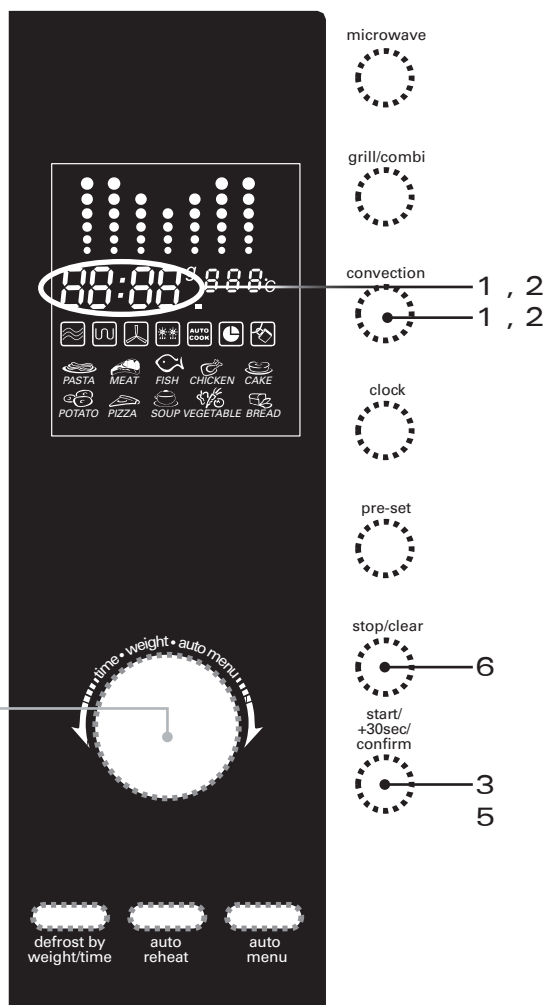

multi-stage cooking

For **Multi-Stage Cooking**, please follow the steps below.

For instance: If you want to defrost your food for 5 minutes and then to cook it with 80% microwave power for 7 minutes.

NOTE: You can set a maximum of 3 stages for Multi-Stage Cooking. If defrosting is among one of the stages, then it will set as the first stage.

1. Press the **defrost by weight/time** button twice to initiate the multi-stage cooking with defrost as the first stage. The LED display will show **DEF2**.

2. Turn the **time/weight/auto menu** dial to adjust the defrosting time until the LED display shows **5:00**.

3. Press the **microwave** button once and the LED display will show **P100**. Press the button again to change the microwave power level to **P80**.

NOTE: Alternatively, after you press the **microwave** button once, you can turn the **time/weight/auto menu** dial to change the power level to **P80** as well.

4. Press the **start/+30sec./confirm** button to confirm the microwave power level.

5. Turn the **time/weight/auto menu** dial to adjust the cooking time until the LED display shows **7:00**.

6. Press the **start/+30sec./confirm** button to confirm and start cooking. The microwave oven will sound once to indicate it has started the defrosting count down. The microwave oven will sound again as it starts the microwave cooking (the second stage). Once completed, the microwave oven will sound five times to indicate the completion.

7. Press the **stop/clear** button to stop the cooking and cancel the setting.

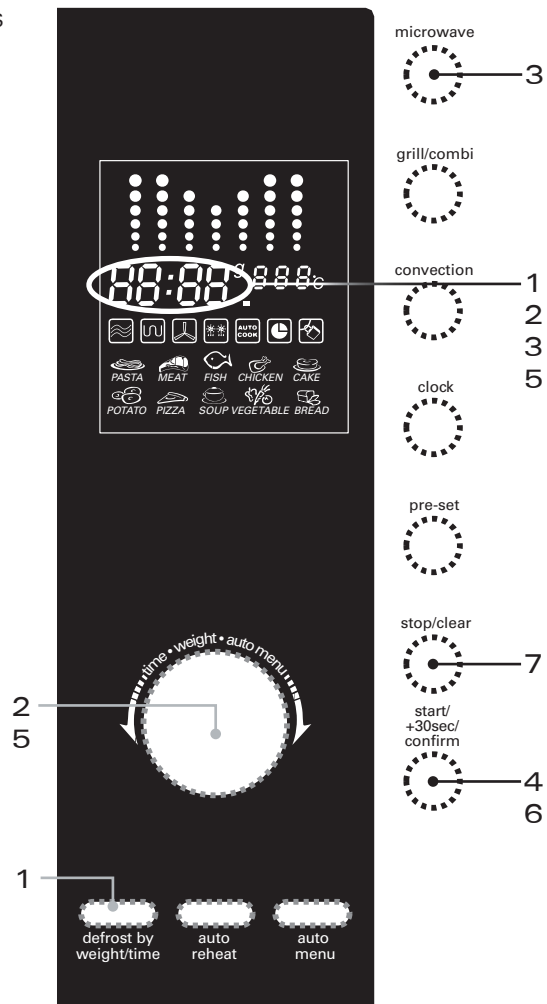

delay start cooking (program set in advance)

For **Delay Start Cooking**, set the clock first and follow the steps below.

For instance: The current time is 12 o'clock (noon) and you want to cook with 80% microwave power for 5 minutes after 1 hour 30 minutes.

NOTE: You can only set a maximum of 3 stages for Delay Start Cooking.
Defrosting cannot be set as one of those stages.

1. Press the **microwave** button once and the LED display will show **P100**. Press the button again to change the microwave power level to **P80**.

NOTE: Alternatively, after you press the **microwave** button once, you can turn the **time/weight/auto menu** dial to change the power level to **P80** as well.

2. a Press the **start/+30sec./confirm** button to confirm the microwave power level.
b Turn the **time/weight/auto menu** dial to adjust the cooking time until the LED display shows **5:00**.

ATTENTION: Do not press the **start/+30sec./confirm** button to confirm and start cooking at this point.

3. a Press the **pre-set** button to preset the starting time for the cooking. The hour figure will flash first.
b Turn the **time/weight/auto menu** dial to adjust the starting time until the LED display shows **13:00**.

4. a Press the **pre-set** button to preset the starting time for the cooking. The minute figure will flash first.
b Turn the **time/weight/auto menu** dial to adjust the starting time until the LED display shows **13:30**.

5. Press the **start/+30sec./confirm** button to complete the setting. The microwave oven will sound when the count down reaches the starting time and cooking will start automatically.

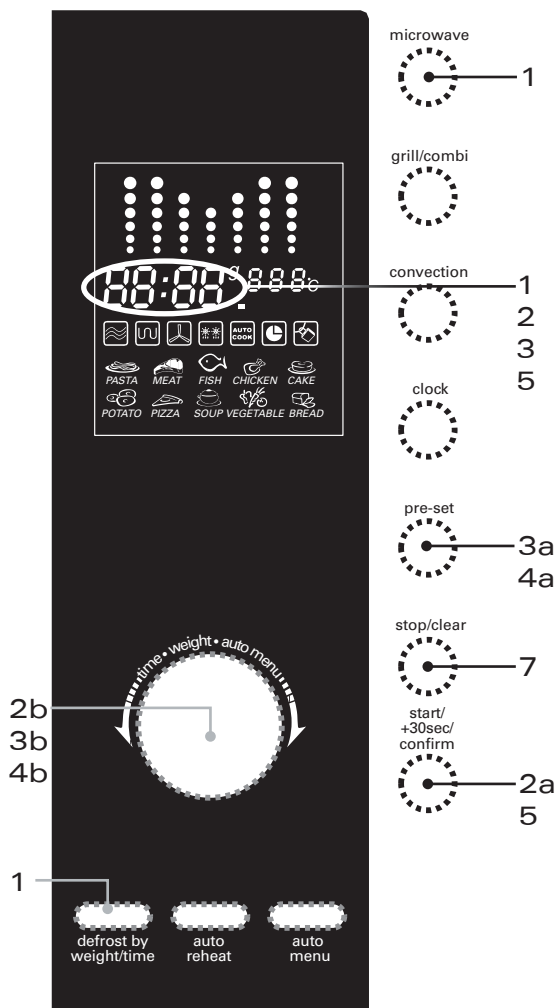

auto cooking

This feature allows you to cook most of your food based on the food category and the weight. Select the category and choose the default weight of the food. For quick reference of the cooking time and the default weight, please refer to the **Auto Menu** table.

auto menu

1. Turn the **time/weight/auto menu** dial to select the Auto Menu program required. The LED display will show **A-1**, **A-2**, **A-3** etc.
2. Press the **start/+30sec./confirm** button to select the program.
3. Turn the **time/weight/auto menu** dial again to choose the default weight for your chosen program. Please refer to the Auto Menu table for information.
4. Press the **start/+30sec./confirm** button to confirm and start cooking.
5. Press the **stop/clear** button to stop the cooking and cancel the setting.

For instance: If you want to cook 350g of fish using Auto Menu program. Please follow the steps below.





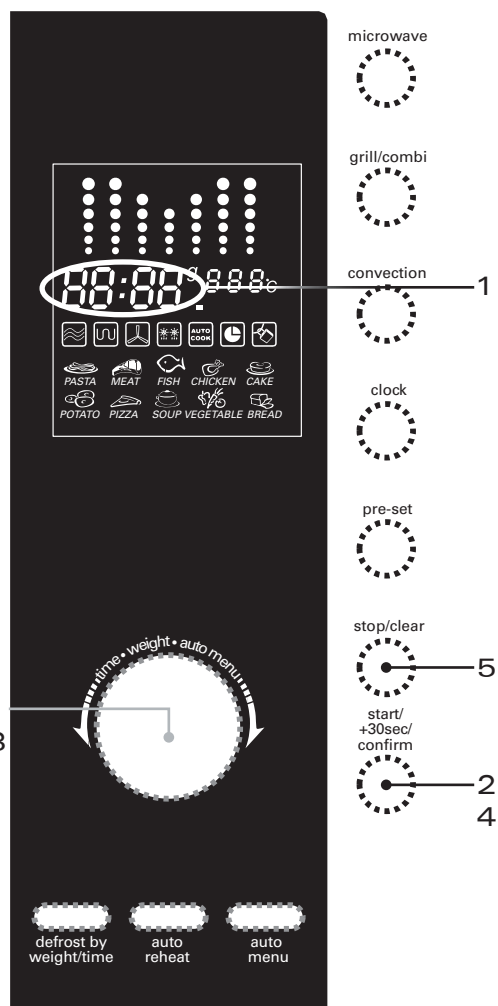





- a. Turn the **time/weight/auto menu** dial to select the Auto Menu program for fish. The LED display will show **A-3**.
- b. Press the **start/+30sec./confirm** button to confirm the program selection.
- c. Turn the **time/weight/auto menu** dial again to select the default weight for **A-3** program until the LED display shows 350.
- d. Press the **start/+30sec./confirm** button to confirm and start cooking.

NOTE: The cake menu is under convection cooking. Once you have confirmed the cooking program, the 180°C pre-heating function will automatically integrate in the process. When the preheating temperature is reached, the oven will sound once. Place the cake in the oven and press the **start/+30sec./confirm** button to confirm and start baking the cake for 50 minutes.



NOTE: The density and thickness of food can affect its cooking time. Ensure all food is piping hot and cooked thoroughly before serving. It is essential that food is checked during and after the recommended cooking time, even if Auto Menu was used.

Auto Menu table

Menu	Weight	Display	Cooking Time	Comments
A-1 Pasta  PASTA	50g	50	17'00"	50g of Pasta + 450ml of Cold Water · Only use suitable microwavable containers and cling film in the microwave oven. · Check the cooking regularly to make sure the water does not boil over.
	100g	100	19'00"	
	150g	150	21'00"	
A-2 Meat  MEAT	150g	150	2'40"	Make sure food is cooked thoroughly before consuming. Additional cooking time may be required for thicker pieces of meat.
	300g	300	4'20"	
	450g	450	6'00"	
	600g	600	7'40"	
A-3 Fish  FISH	150g	150	2'40"	Make sure food is cooked thoroughly before consuming. Additional cooking time may be required for thicker pieces of fish.
	250g	250	3'50"	
	350g	350	5'00"	
	450g	450	6'10"	
	650g	650	8'30"	
A-4 Chicken  CHICKEN	500g	500	29'00"	Make sure food is cooked thoroughly before consuming. Additional cooking time may be required for thicker pieces of chicken.
	750g	750	34'00"	
	1000g	1000	39'00"	
	1200g	1200	44'00"	
A-5 Cake  CAKE	475g	475	50'00"	For best results, we recommend using a cake mix. Use a tin no larger than 8 inches and remember to preheat the oven to 180°C first. Check the cake at regular intervals.
A-6 Potatoes  POTATO	1 (~230g)	1	4'50"	For best results, once the potatoes are cooked, wrap them in aluminium foil for at least 5 minutes to ensure they are cooked thoroughly.
	2 (~460g)	2	7'30"	
	3 (~690g)	3	9'30"	
A-7 Pizza  PIZZA	200g	200	10'30"	This setting is designed for re-heating cooked pizza slices (not frozen pizza).
	300g	300	13'00"	
	400g	400	14'00"	
A-8 Soup  SOUP	200ml	200	2'00"	Only use suitable microwavable containers and cling film in the microwave oven. Pierce the film with a fork before cooking.
	400ml	400	4'00"	
	600ml	600	6'00"	
A-9 Vegetables  VEGETABLE	150g	150	2'30"	· Only use suitable microwavable containers and cling film in the microwave oven. · Check regularly to ensure the water does not boil over.
	350g	350	4'30"	
	500g	500	6'10"	
A-10 Bread  BREAD	50g	50	7'30"	This setting is designed for re-heating bread and crisping up croissants.
	100g	100	9'30"	
	150g	150	11'30"	

quick start cooking

This feature allows you to quickly cook your food for 30 seconds with 100% microwave power. Please follow the steps below.

1. Press the **start/+30sec./confirm** button to start the quick start cooking. Press the button again to increase by another 30 seconds, you may increase the cooking time up to 95 minutes.

NOTE: This feature is ONLY applicable to Microwave, Grill/Combination and Convection programs. This feature is NOT applicable to Defrost, Auto Menu and Multi-stage programs.

NOTE: Alternatively, you can turn the **time/weight/auto menu** dial to set the cooking time with 100% microwave power first. Then, press the **start/+30sec./confirm** button to start cooking.

2. Press the **stop/clear** button to stop cooking or cancel the setting.

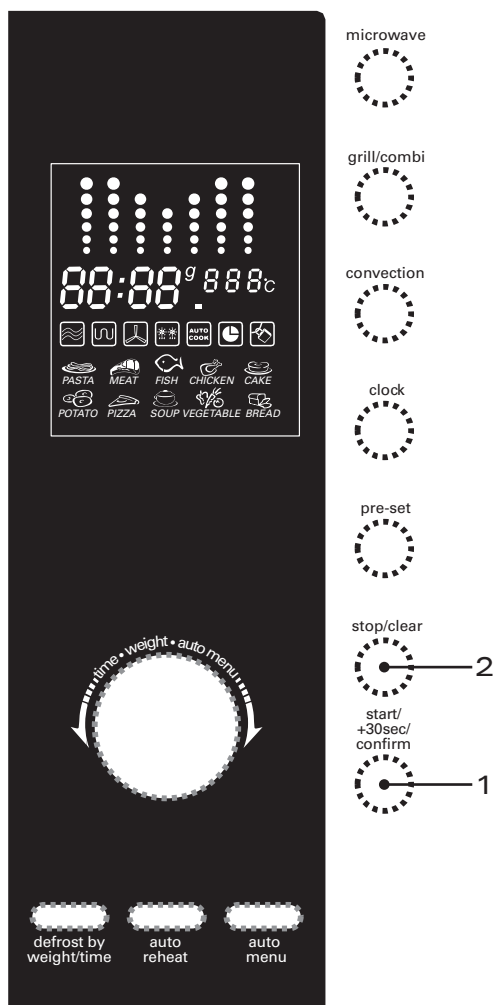

auto reheat cooking

This feature allows you to quickly reheat your food.
Please follow the steps below.

1. Press the **auto reheat** button to reheat food by weight. The LED display will show **150**, which equates to 150g.
2. To increase the weight, you can turn the **time/weight/auto menu** dial to set the weight. Alternatively, you can keep pressing the **auto reheat** button to increase the weight.
3. Press the **start/+30sec./confirm** button to start reheating.
4. Press the **stop/clear** button to stop cooking or cancel the setting.

Auto Reheat table

Menu	Weight	Display
auto reheat	150g	150
	250g	250
	350g	350
	450g	450
	600g	600

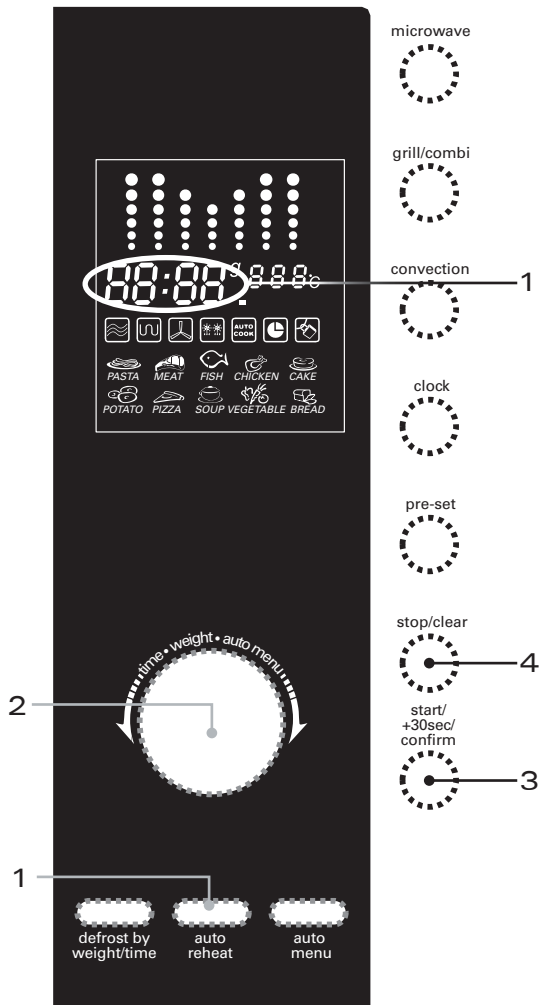

operating instructions

defrosting

This feature allows you to defrost your frozen foods simply by entering the weight or time. You may wish to place the frozen food on a microwave safe plate or dish before placing it on the defrost rack. This is to ensure that any liquids released during defrosting will not spill and dirty the interior of the oven.

defrost by weight

1. Press **stop/clear** button once to clear any previous program setting.
2. Press the **defrost by weight/time** button once and the LED display will show **DEF1**.
3. Turn the **time/weight/auto menu** dial to adjust the weight of your food. The default range is 100g to 2000g.
4. Press the **start/+30sec./confirm** button to start defrosting.

TIPS: Large items may be frozen in the centre. Therefore, to ensure even thawing, turn them over from time to time and break them into smaller pieces during defrosting. You will need to press the **stop/clear** button once to hold the defrosting program and open the oven door. After you rotate the food, you need to press the **start/+30sec./confirm** button to re-start defrosting.

Place roasts fat-side down or whole poultry breast-side down.

Drain liquids during defrosting as the juices from food can get hot and cook the food.

5. Press the **stop/clear** button to stop defrosting or cancel the setting.

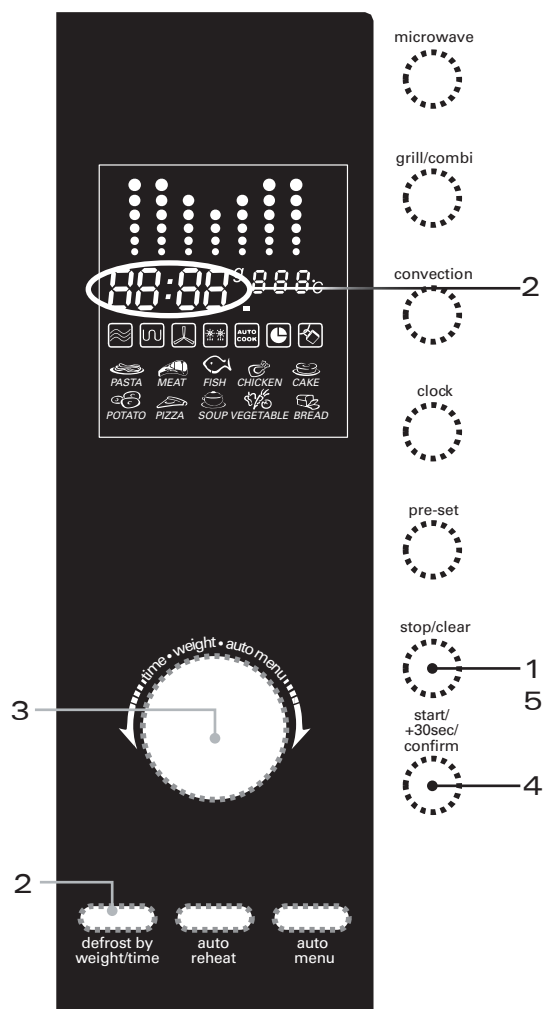

defrost by time

1. Press the **defrost by weight/time** button twice and the LED display will show **DEF2**.
2. Turn the **time/weight/auto menu** dial to set the defrosting time.

NOTE: The maximum setting time is 95 minutes.

3. Press the **start/+30sec./confirm** button to start defrosting.
4. Press the **stop/clear** button to stop defrosting or cancel the setting.

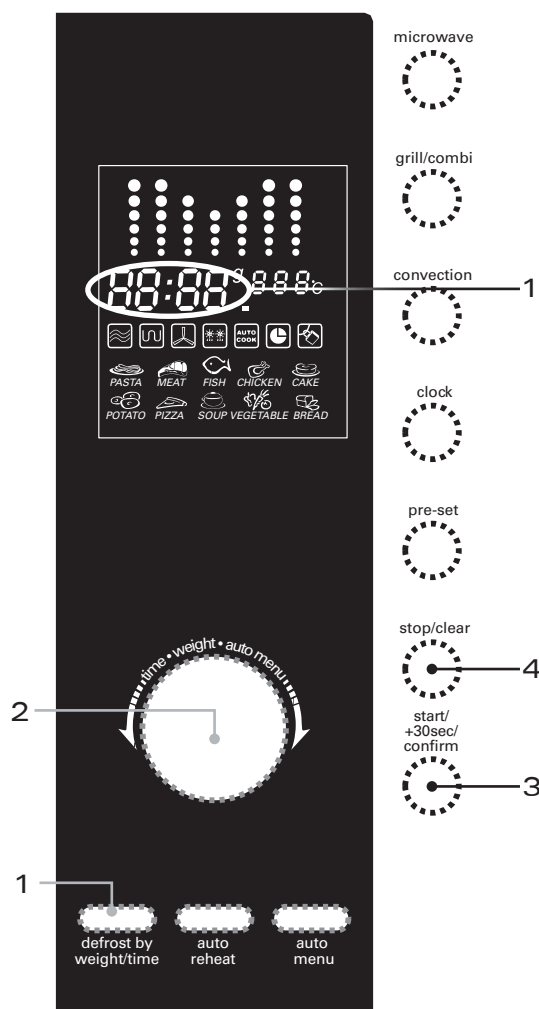

querying the cooking function

This feature allows you to check and view the current power, time, and pre-set time of your selected cooking program.

to find out the current cooking power

1. Press the **microwave**, **grill/combi.**, or **convection** button once and the LED display will show the current cooking power while the oven is either microwave, grill, combination, or convection cooking. It will last for 2 - 3 seconds and the oven will then return to its original display.

to find out the time

2. Press the **clock** button once and the LED display will show the time while the oven is in cooking state. It will last for 2 - 3 seconds and the oven will then return to its original display.

to find out the pre-set time

3. While the oven is still at the pre-set state, press the **pre-set** button once and the LED display will show the pre-set time. It will last for 2 - 3 seconds and the oven will then return its original display.

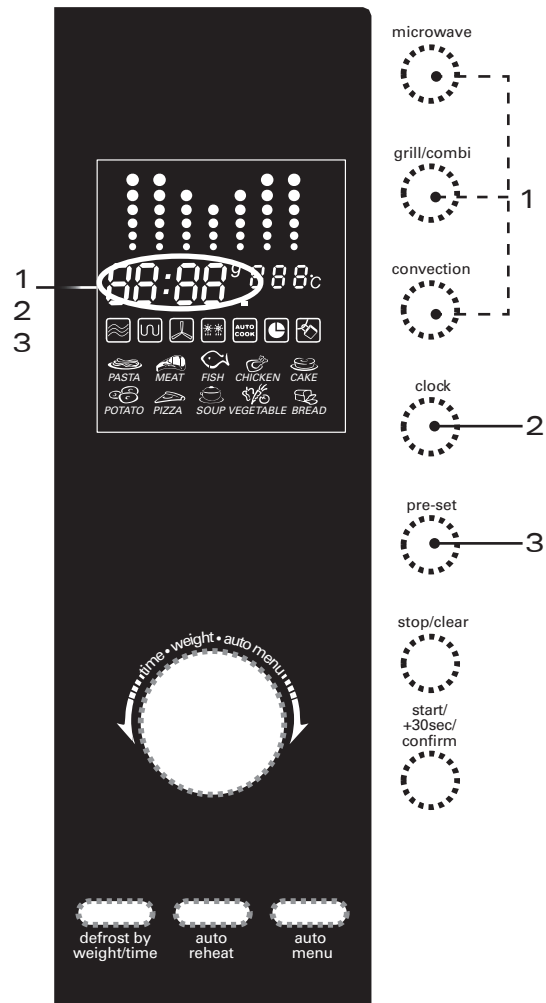

operating instructions

Cleaning your

*Cleaning your oven each time you use it will help to prevent
Unplug your microwave from the mains and wait for the
On the right hand side wall of the cavity is the wave guide cover,
It is important that this wave guide cover is kept clean at all times.*

The oven walls have a special enamel coating which makes cleaning very easy. Use a soft damp cloth to wipe off any splashes or a paper towel to mop up any spills. Wipe off grease with a damp cloth and a little detergent. Dry thoroughly. As with any oven, if grease is left to accumulate, it can smoke and even catch fire.

Make sure you keep the outlet grids clean.

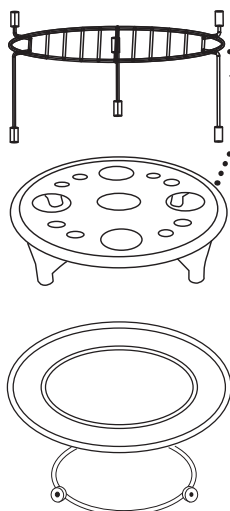

Wash racks in warm water. Do not use very hot water on the racks which could make them warp.

Treat the glass turntable as you would any glass plate. After you have used it for more than 15 minutes, allow it to cool down before you use it again. Do not wash the turntable in very hot water, this could crack it. Make sure the turntable is dry before you put it back in the oven.

Wash the turntable ring in warm water. Do not use very hot water which could make it warp.

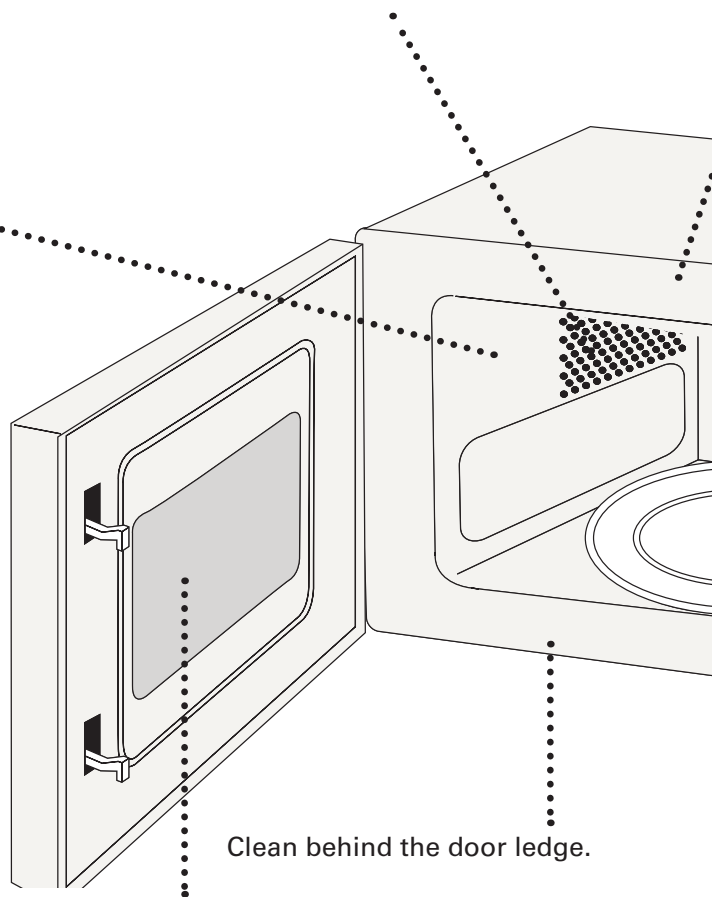

Clean behind the door ledge.

Keep the inside of the door clean with a damp cloth. Use warm soapy water for stubborn marks and dry thoroughly. The inside of the door has a special coating and must not be cleaned with abrasive pads or cleaning powders.

microwave

*a build up of stubborn marks that can be difficult to clean.
oven to cool down completely before cleaning.
microwaves are passed through this to enable your food to cook.
Wipe it with mild detergent and water and leave to dry.*

Be careful not to spill water into the vents.

Keep the front of the oven clean so that the door can close properly.

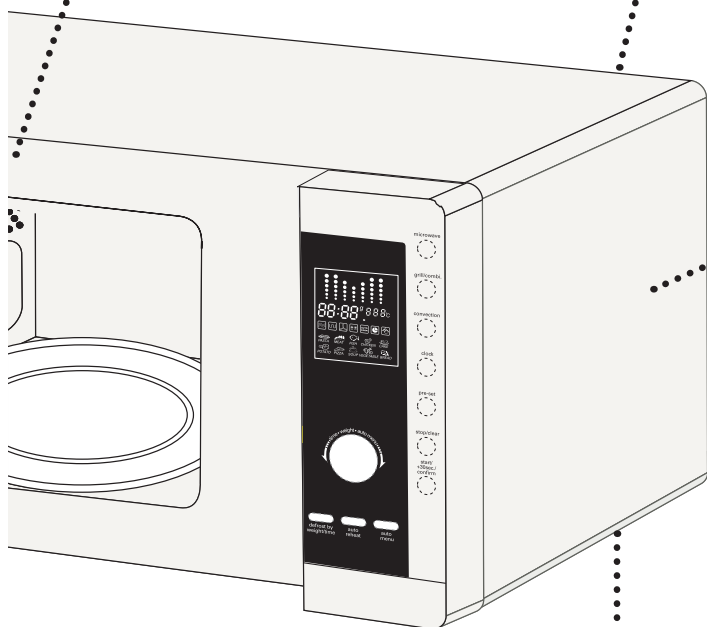

Do not remove wave guide cover: It is important to keep the cover clean in the same manner as the inside of the oven. If grease is left to accumulate, it can smoke and even catch fire.

Unplug the oven before cleaning the power lead and the oven. Wipe with a damp cloth and leave to dry before plugging it back in.

Use warm soapy water to clean the outside of the oven. Do not use abrasive pads or powders that could scratch the surface.

NOTE: Do not remove any fixed parts from the inside of your microwave oven during cleaning or at any other time.

care, maintenance and troubleshooting

troubleshooting

If you have a problem that cannot be answered by these points, please contact your nearest store. Please note: If you call a Mastercare engineer out to your home and the product is found not to be faulty, or the instruction book has not been followed, our product guarantee is not applicable and a call-out fee will be charged.

questions and answers

Q. *Why doesn't the food seem to cook?*

A. Check that:

- the cooking time has been set
- the door is closed
- the power socket is not overloaded causing the fuse to blow.

Q. *Why does the food seem undercooked or overcooked?*

A. Check that:

- the correct cooking time has been set
- the correct power setting has been used.

Q. *How can I stop eggs from popping?*

A. When you cook or poach eggs in the microwave, the yolk can sometimes pop as steam builds up inside it. You can stop the egg from popping by piercing the yolk with a toothpick before cooking.

Never cook eggs that are still in their shells.

Q. *Why is it so important that I allow standing time after cooking?*

A. With microwave cooking, many foods build up enough heat inside them to continue cooking even after they've been taken out of the oven. Because microwave cooking works from the outside of food inwards, standing time lets you cook the centre of the food just right without the outside being overcooked.

Q. *Why does my oven sometimes take longer to cook than it says in the recipe?*

A. First check that the oven was set just as the recipe said. Cooking times and heat settings are suggestions to help prevent overcooking but differences in the weight, size, shape and starting temperature of food will all affect how long it takes to cook – just as it does with a conventional oven. Use your judgement along with the recipe to check whether food has been cooked properly.

Q. *Why do I get condensation on the inside of the oven door?*

A. Condensation is perfectly normal, especially when you are cooking food with a high moisture content such as potatoes.

Q. *Does the microwave energy get through the window on the door?*

A. No. The door has a special metal screen with holes in that lets you see inside but stops microwave energy from getting out.

Q. *Steam comes out of the side of the door and vents. Can microwave energy get out too?*

A. No. The door and vents are carefully designed to let steam out during cooking but keep microwave energy in. The gaps are not big enough for microwave energy to escape.

questions and answers

Q. What happens if the microwave is switched on while the oven is empty?

A. The microwave will be damaged. Do not switch the microwave on when there is nothing inside the oven. It is a good idea to keep a cup of water in the oven just in case someone accidentally starts the microwave.

Q. Why doesn't the oven light illuminate?

A. Open the door. If the light does not illuminate, the bulb has probably blown. Call a qualified repairer – do not try to change the bulb yourself.

Q. There are sparks inside the oven when I use the microwave. Will this cause any damage?

A. Yes. Make sure that you are not using any metal utensils and that your containers don't have a metal trim. You must not use metal in your microwave, except foil, when you cook.

Q. Light is showing through the vents and door. Does this mean the microwave energy can escape?

A. No. It is normal for the light to be visible and is nothing to be concerned about.

Q. Why do I get interference on my TV and radio when I use the microwave?

A. Microwave ovens use radio waves similar to those received by TVs and radios. You can lessen the interference by moving your microwave further away from the TV or radio.

specification

Input	230 - 240V ~50Hz
Output	950 - 1000 Watts
Microwave Frequency	2450MHz
Outside Dimensions	510mm x 485mm x 310mm (width x deep x height)
Power consumption	
Microwave	1650 - 1750 Watts
Grill	1100 - 1200 Watts
Convection	2400 - 2600 Watts

Complies with EEC directives 89/336/EEC and 92/31/EEC.

Because we continually strive to improve our products, we may change specifications without prior notice. The highest quality requirements are placed on our appliances. However, should a malfunction occur for which you cannot find any information in the operating instructions, please contact the store where you purchased your appliance.



IMPORTANT INFORMATION FOR CORRECT DISPOSAL OF THE PRODUCT IN ACCORDANCE WITH EC DIRECTIVE 2002/96/EC.

At the end of its working life, the product must not be disposed of as urban waste.

It must be taken to a special local authority differentiated waste collection centre or to a dealer providing this service.

Disposing of a household appliance separately avoids possible negative consequences for the environment and health deriving from an inappropriate disposal and enables the constituent materials to be recovered to obtain significant savings in energy and resources. As a reminder of the need to dispose of household appliances separately, the product is marked with a crossed-out wheeled dustbin.



Visit Partmaster.co.uk today for the easiest way to buy electrical spares and accessories.

With over 1 million spares and accessories available we can deliver direct to your door the very next day.

Visit www.partmaster.co.uk

or call

0870 6001 338

(UK customers only)

Calls charged at National Rate.

NOTE: If you require a replacement for any of the items listed below, please quote their corresponding part numbers:	
Replacement Part	Part Number
glass turntable	252100500504
turntable ring	252200200010
grill rack	256511700007
defrost rack	250900200006
instruction manual	261800303126



DSG Retail Limited is responsible for after sales service.

If you have a query about the product please contact our product support line

0844 561 6263 (Currys) and 08700 118 117 (Pixmania).

DSG Retail · 200 The Campus · Marylands Avenue ·
Hemel Hempstead · Herts · HP2 7TG





Free Manuals Download Website

<http://myh66.com>

<http://usermanuals.us>

<http://www.somanuals.com>

<http://www.4manuals.cc>

<http://www.manual-lib.com>

<http://www.404manual.com>

<http://www.luxmanual.com>

<http://aubethermostatmanual.com>

Golf course search by state

<http://golfingnear.com>

Email search by domain

<http://emailbydomain.com>

Auto manuals search

<http://auto.somanuals.com>

TV manuals search

<http://tv.somanuals.com>