

KENWOOD

DVD NAVIGATION SYSTEM

KNA-DV2200

INSTRUCTION MANUAL

KENWOOD CORPORATION

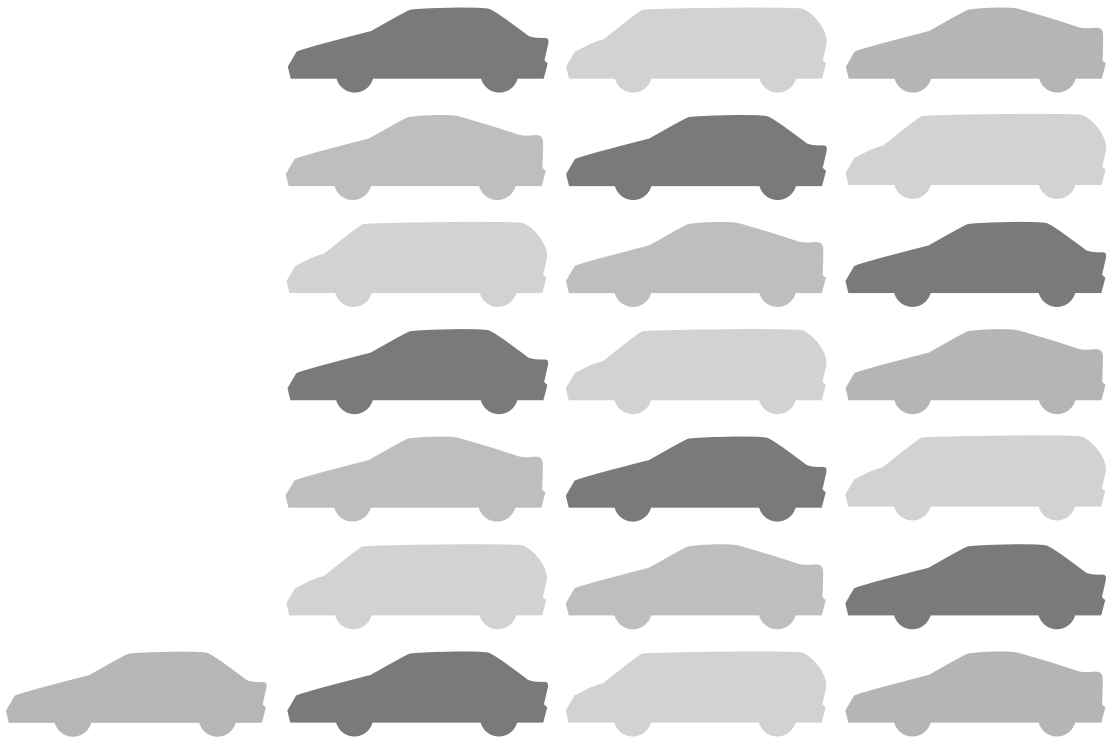

© PRINTED IN JAPAN B64-2503-00/00 (E) (+)
03/12 11 10 9 8 7 6 5 4 3 2 1 02/12 11 10 9 8 7 6

Warning Messages

For safe usage please observe the following !!!

■ **READ THIS MANUAL FIRST.**

Read this manual carefully before starting to operate the Kenwood Car Navigation System and follow the manual's instructions. Kenwood are not liable for problems or accidents resulting from failure to observe the instructions in this manual.

■ **OBSERVE LOCAL TRAFFIC SIGNS AND REGULATIONS.**

Always observe the local traffic signs and regulations whilst driving and check them against the system's instructions. Due to frequent changes in local signs and regulations, the traffic sign and regulation data on the Map DVD-ROM may be outdated. Furthermore the Map DVD-ROM cannot reckon with certain conditions such as traffic density at certain times of the day, (temporary) road closures due to construction work, weather conditions or special events taking place.

Therefore always obey the local traffic signs and regulations rather than the system's instructions. Failure to do so may place you in illegal, unsafe or dangerous situations.

■ **DRIVE SAFELY.**

Before following the system's guidance instructions, such as changes in direction, always check first whether it is safe to do so given the current traffic conditions. Then follow the given instructions, but make sure you do so in a safe manner.

■ **VOLUME LEVEL.**

Keep the system's volume at a low enough level to be able to hear outside noises whilst driving. If you can no longer hear outside noises, you may be unable to react adequately to the traffic situation. This may cause accidents.

■ **FOREIGN OBJECTS.**

Keep fingers and foreign objects out of the disc-loading slot, so as not to cause accidents. In the event of there being foreign objects inside the unit, or smoke or noxious odours coming out, stop operation immediately and contact the closest Kenwood dealer.

■ **STOP OPERATION IN THE EVENT OF PROBLEMS.**

In event of problems such as a lack of sound or video occurring, stop operation and push the reset button. Should the problems persist, stop operation of the system and contact the closest Kenwood dealer.

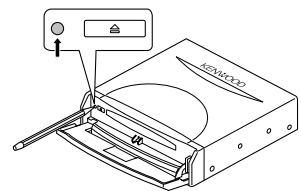

■ **NEVER DISASSEMBLE OR ALTER.**

Never try to disassemble or alter the navigation equipment. Any attempt to do so may cause accidents, fire or electric shock.

■ **REPLACING FUSES.**

When replacing fuses always use the same rated ampere. Failure to do so may cause fire.

■ **SMALL ARTICLES.**

Keep small articles (like screws or batteries) out of the reach of children. If any such object is accidentally swallowed, consult a doctor immediately.

Information in this document is subject to change without notice.

Contents

Before Use	2
Precautions when Handling Map Discs	3
Replacing Map Discs	4
Inserting a Map Disc	4
Removing the Map Disc	4
Touch Screen Operation	5
Starting Up Navigation	6
Language Selection	7
Markers (and Switches) Displayed on Maps	8
Screens Before Setting Route	8
Screens During Route Guidance	9
Menu Screen Change Chart	10
Map Operations	11
Changing the Orientation of the Map	11
Changing the Scale of the Map	12
Map Display	13
Showing Current Position	13
Scrolling the Map	13
Set Route	14
Route Searching	14
Setting Destination	15
Route Guidance	23
Route Options	25
Navigation Set Up	28
Guidance Options	33
Stored Locations	35
Editing Stored Locations	37
Deleting Stored Locations	40
User Settings	41
Other Functions	42
Displaying POI's on a Map	42
Local Search	42
Deleting POI Markers	43
Showing POI Data	43
Checking the Route by a Simulation Run	44
General Information	45
Mechanism of Detecting the Vehicle's Position	45
Accuracy of the Vehicle's Position	45
Accuracy of the Route Guidance	47
Troubleshooting	48
Terminology	49

Before Use

■ Start the car engine before use

This mobile navigation system can be used when the ignition key is turned to ON or ACC. However, to preserve the battery, it should be used with the engine running whenever possible. Using the navigation system for a long time with the engine switched off can cause the battery to run down.

■ Time before current position is displayed

The mobile navigation system will not display the correct current position of the vehicle the first time it is used after purchase, or if the battery has been removed for a long time. GPS positioning signals will soon be received, however, and the correct position will be displayed.

■ Reading programmes after the battery has been turned off

The navigation programmes will be deleted if the battery is removed for repairs, etc. If this happens, set the map disc provided into the mobile navigation system and switch on the engine. The mobile navigation system will automatically load the programmes and start operating normally again.

■ When driving on rough roads

The mobile navigation system might not operate properly or be able to read map data from the disc if there is severe vibration caused by driving on rough roads.

■ Handling the GPS antenna

- Do not paint the antenna. This will impair or disable signal reception.
- Remove any object or accumulated snow, etc., from the top of the antenna. It will reduce reception strength.
- Do not pull the cord when removing the antenna or adjusting its position. This can cause a short or snap the wires.

■ Operating whilst driving

The GPS voice navigation system displays the switches disabled during driving in fainter colours. These switches stop functioning and no message is displayed.

■ Precautions for handling precision machines

Be careful of the surrounding temperature. Using the mobile navigation system at extremely high or low temperatures can lead to malfunction or damage. Also note that the unit can be damaged by strong vibration or by metal objects or water getting inside.

■ Condensation

Condensation can form on the lens inside the main unit just after the car heater is switched on in cold weather, for example, leading to malfunction. The main unit will start working normally again if it is just left alone for about one hour for this condensation to go away. If normal operation is not restored after several hours, return the main unit to the store where you purchased the mobile navigation system.

■ Map disc

Always replace the map disc with another compatible map disc. Never insert an incompatible disc. It can damage the main unit.

Precautions when Handling Map Discs

- Data recorded on a disc is read by laser beam, so there is no wearing of the disc due to friction from a needle. You should handle discs carefully, however, as excessive warping or scratches on the disc surface or label can lead to reading errors.

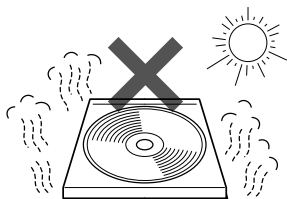

- Store discs away from direct sunlight. The disc might warp and become unusable.

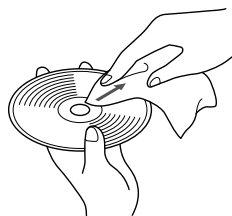

- Lightly wipe the disc with a soft cloth in a straight line from the centre of the disc towards the outer edge.

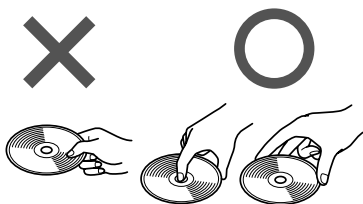

- If you touch the data surface of a disc (the surface without a label printed on it) it might get dirty and lead to a malfunction. Always hold a disc either by its centre hole and an edge or by two edges.

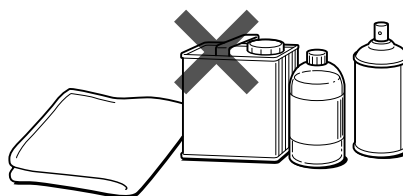

- Never clean discs with benzene, thinners, record spray, anti-static spray or chemical swabs.

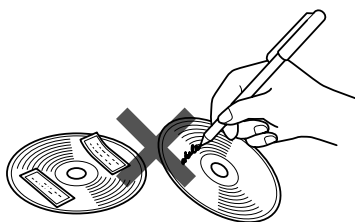

- Do not write on, or stick paper or seals onto, the surface of a disc.

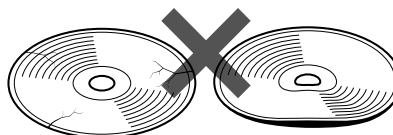

- Map discs rotate at high speed inside the main unit. Do not use a cracked or badly warped disc, therefore, because it might damage the main unit.

Replacing Map Discs

Inserting a Map Disc

- 1 Press the right side of the button marked DVD and open the lid.



- 2 Insert the map disc and close the lid.

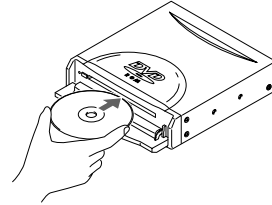

NOTE :
Insert the map disc with the label facing upwards.

Removing the Map Disc

- 1 Press the right side of the button marked DVD and open the lid.



- 2 Press the eject button.

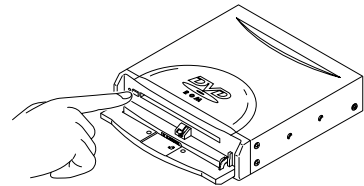

- 3 Remove the map disc and close the lid.

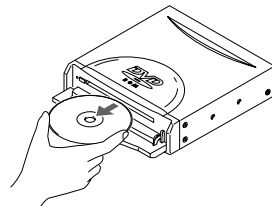

Touch Screen Operation

The switches displayed on the screen can be selected by actually touching the screen.

[Example]

Here are the steps to display the screen by touching **Menu** .

1 Touch **Menu** .



2 **Menu** is selected and the Menu screen appears.



Starting Up Navigation

Start up navigation and display the map of the area around your vehicle.

- 1** Turn on the car engine.



- 2** The opening screen appears on the display.

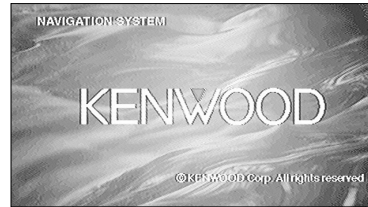

- 3** The CAUTION screen appears.

Most functions are inhibited whilst the vehicle is in motion.
Please read the handbook for operating instructions.
Always obey traffic regulations.

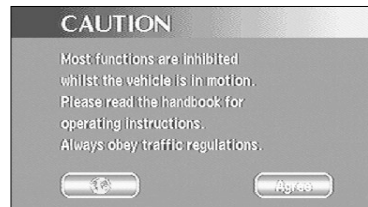

Once you have consented to the message on the screen, press **Agree** .

You can select the language by pressing  . You can also alter the language by Language Selection. (See page 7)

If 3 minutes elapse without any operation, the display changes automatically to Language Selection. (See page 7)

NOTE :

The CAUTION screen remains on the display unless you select **Agree** .

- 4** The Current Position screen appears.

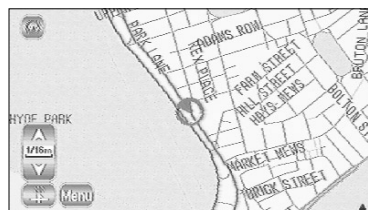

Language Selection

You can change the language of the menu and the voice guidance.

1 Select **Menu** .

Select  (Language Selection).



2 Select the language you prefer by touching the appropriate switch.



Markers (and Switches) Displayed on Maps

Here we introduce the markers that are displayed on the map.

Screens Before Setting Route

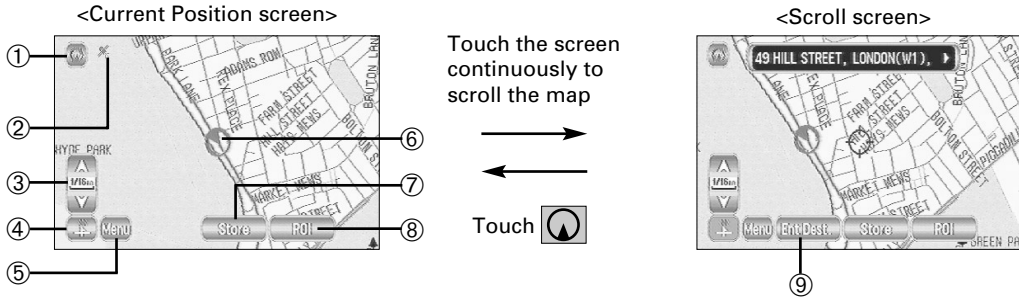



① Current Position switch

Selecting this switch shows the current position of your vehicle.

② GPS (Global Positioning System) marker

This shows the status of the signal from the GPS satellite. When this marker appears, the GPS satellite signal is being received and used to calculate the position of your vehicle.

③ Zoom Out/Zoom In switch, scale display

Press  to display a wide area map and  to display a detailed map. The numbers on the display indicate the scale of the map currently shown.

④ Direction switch

Selecting this switch changes the orientation of the map shown.

⑤ Menu switch

Selecting this switch shows the menu. (See page 10)

⑥ Vehicle marker

This shows the position and direction of your vehicle.

⑦ Store (Store Memory Point) switch

This stores markers on the map. This switch only appears if you touch the screen once.

⑧ POI (Point of Interest) Display switch

Selecting this switch moves to the POI Selection screen. (See page 42) This switch only appears if you touch the screen once.

⑨ Enter Destination switch

After scrolling the map, selecting this switch sets the centre of the  as the destination.

Screens During Route Guidance

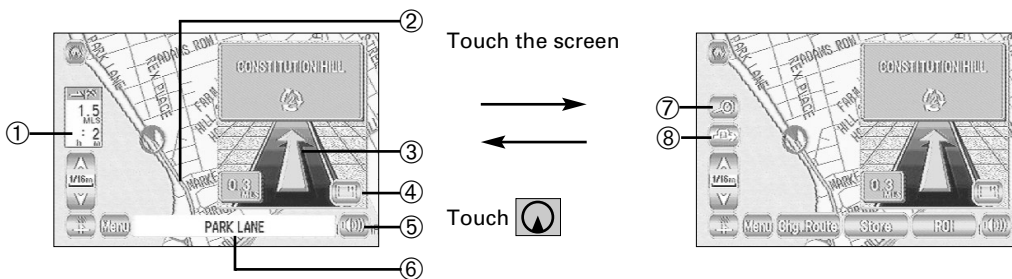

① **Distance and Time to Destination display**

This shows the driving distance and the estimated time required to the destination. It also shows the direct distance from the current position to the destination if the vehicle has left the route.

② **Route display**

This shows the provided route as a thick green line.

③ **Turn Arrow display**

This shows the direction to turn at the next junction and the distance to the junction.

④ **Split Screen to Full Screen switch**

Selecting this switch brings up a full screen map of the vicinity in which you are currently driving.

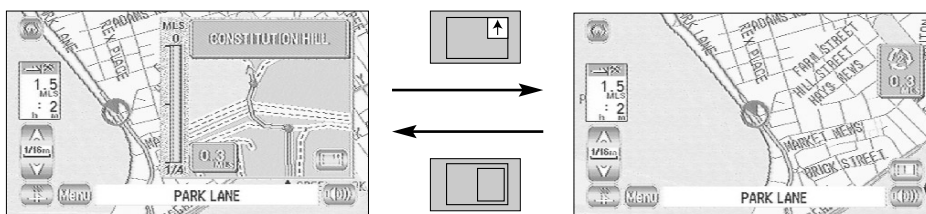

<Enlarged diagram of junction>
(Split Map)

<Mini-arrow display>
(Full Map)

⑤ **Repeat Voice switch**

This repeats the last voice guidance message.

⑥ **Current Road Name**

This shows the name of the road you are currently driving along.

⑦ **Display Whole Route switch**

This shows the entire route. (See page 27)

⑧ **Detour button**

This shows the detour setting screen. (See page 26)

Menu Screen Change Chart

<Current Position screen>

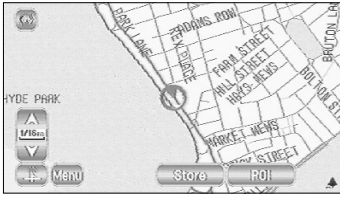

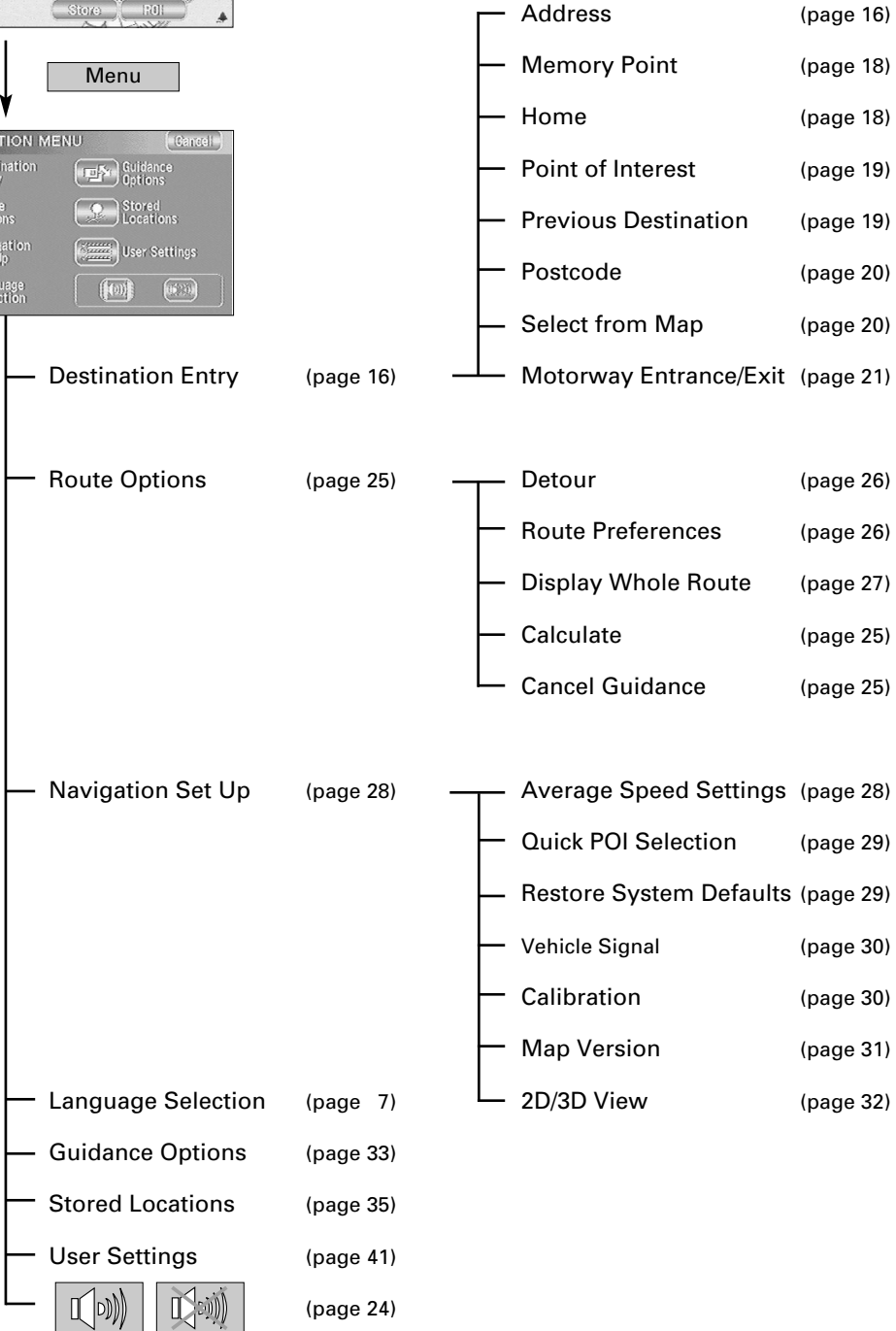

Menu



Map Operations

Changing the Orientation of the Map

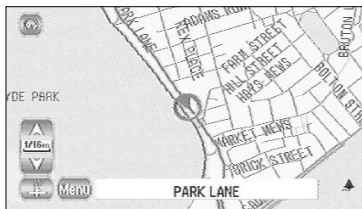

Either the direction in which you are headed or north can be shown as upwards on the map.

1 Select  (North Up) or  (Heading Up).

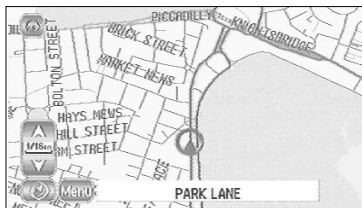

2 The orientation of the map will change.



- Selecting  or  changes the orientation of the map as shown below.

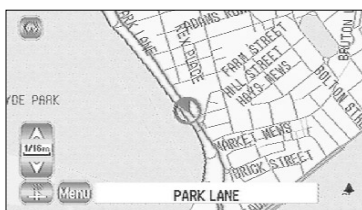
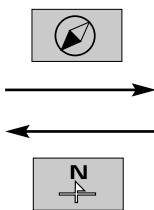
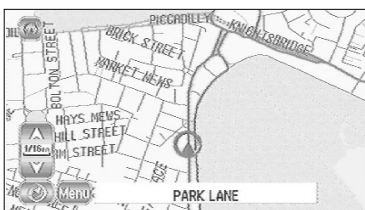

Heading up

The direction in which your vehicle is heading is always shown as upwards on the screen.

This orientation marker is



(north: red)

North up



North is always shown as upwards on the screen.

This orientation marker is





Changing the Scale of the Map

You can increase or decrease the scale of the map.

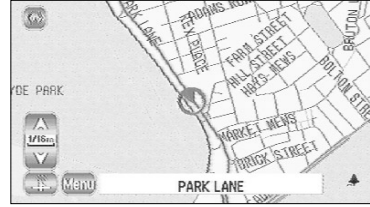
- 1** Touch  or  to change the map scale.







- Selecting  or  changes the scale of the map as shown below.

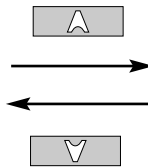

Detailed



Wide area

- You can keep touching  or  to continually change the scale.
- By touching the right of the scale bar after  or  is selected, you can directly change between 5 scale levels. (See below)



Imperial display	Metric display
128m (mile)	256Km
16m (mile)	32Km
2m (mile)	4Km
1/4m (mile)	500m
1/32m (mile)	50m

<Scale bar>

NOTE :

- The scale can be displayed in imperial or metric units.
- See page 41 for the method of changing the units displayed.

Map Display

Showing Current Position

This shows the current position of your vehicle.

- 1 Touch the  switch.

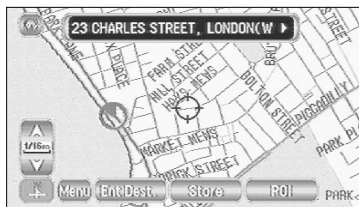

- 2 The current position of your vehicle will be shown.

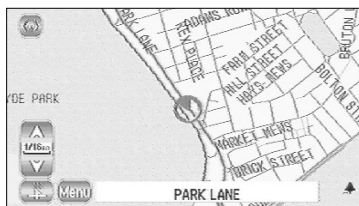

Scrolling the Map

Touching the screen scrolls the map.

- 1 Touch the screen.

- 2 Touch the map.

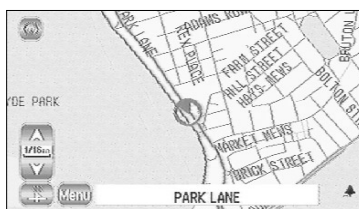

NOTE :

The screen can scroll up, down, left, right and diagonally in a total of eight directions.

- 3 Scroll the screen so that the point you touch with your finger becomes the centre of the map.

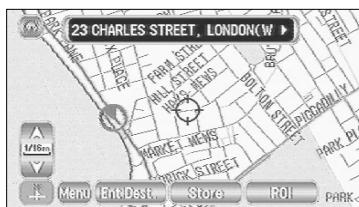

- The screen that displays the present location of your vehicle is called the Current Position screen. The screen that scrolls the maps with a cursor key is called the Map screen. Current Position screen (auto-mode).... Scrolls automatically according to the movement of your vehicle. (The map automatically follows your current position.) Map screen (manual mode).... Shows the map of the location you want to see. It does not scroll automatically.
- If you move the map, it stops automatically scrolling. If you then select the  switch, the Current Position screen reappears and the map returns to auto scroll.
- To quickly search for a location, first move the map on the wide area map scale screen to the general area of the destination and then change to the detailed map to find the destination.
- When you touch the screen, it scrolls towards the place touched. If you keep touching the screen, scrolling continues in the direction of the place touched (one of eight directions). If you keep touching the screen longer, scrolling speeds up.

Set Route

Route Searching

Here we explain how to set the route. Follow the example below.

CAUTION!

The mobile navigation system provides maps and voice guidance for your reference when driving. In unusual situations, however, this guidance might be inappropriate. When driving along the route provided, always comply with local traffic regulations (one-way streets, etc.).

NOTE :

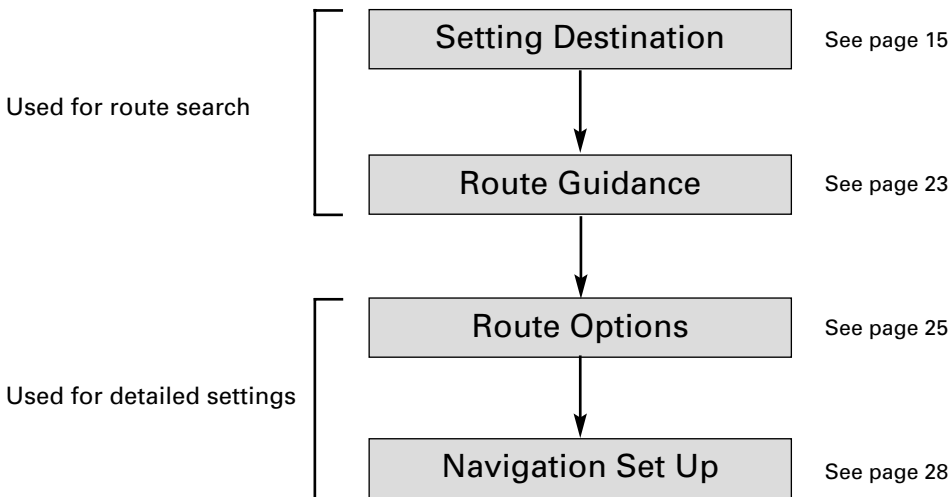

- The route shown is a reference route as far as the destination area. It might not be the shortest route.
- If the street on the map disc does not agree with the actual street, the voice guidance might be wrong.
- At a complicated junction, it might be difficult to understand where to turn from only the voice guidance. Stop the vehicle and check the Map screen.
- If a destination or way points are not on a road that the mobile navigation system can direct to, the route provided might not pass that destination or way points.
- The mobile navigation system might not be able to provide directions due to the distance from the destination area or a lack of road data.
- If the current position cannot be determined properly, voice guidance and enlarged junction diagrams will be disabled or might be incorrect.



Setting Destination

Setting Destination by Scrolling the Map

[Example]
Full address not known.

1 Touch the screen to scroll the map until the  is at the destination point and select  (Enter Destination).



2 Select  (Destination).

 (Way Point)Sets the way point.

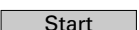

3 A map of the whole route appears.
Select , if happy with the route shown.



or select

 (Next Route).....This brings up the next proposed route.

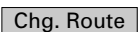
 (Change Route).....During route guidance you can change the route options, stop or check the route. (See page 25)

When happy with the route shown, press

.

4 Route guidance begins.

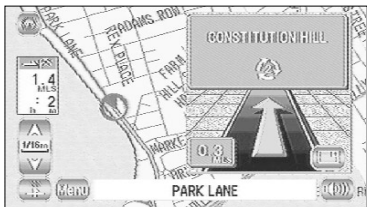

Setting Destination from the Navigation Menu

[Example]
Here are the steps to set the destination using the Address function from the Navigation menu.

1 Select **Menu** .





2 Select  (Destination Entry).

3 Select  (Address).



If you cannot select wanted address check search area is correctly selected.

-  (Memory Point) See page 18
-  (Home) See page 18
-  (Point of Interest) See page 19
-  (Previous Dest.) See page 19
-  (Postcode) See page 20
-  (Select from Map) See page 20
-  (Motorway Ent/Exit) See page 21
- Change** This allows you to designate the area to be searched. (See page 22)

- You can switch between screens by selecting  (Next Page) or  (Prev. Page).

NOTE :

- Depending on the selected area, you may not be able to search from the post code.
- If the destination setting is different to the Search Area shown in the right of the screen, you must select **Change** and designate the search area again.

4 Enter the street name and select **List** .



Selecting this deletes the character that was last entered. Selecting it continuously deletes all the characters that have been entered.

- You can switch between the input screens showing different input characters by selecting **Others** , **Sym.** (Symbols) or **A-Z** (A to Z).
- You can search for the street you want quickly by selecting **Town** and entering the name.

- 5** If the same street name exists in more than one town, a list of those towns is shown.
Select the right town from the list.

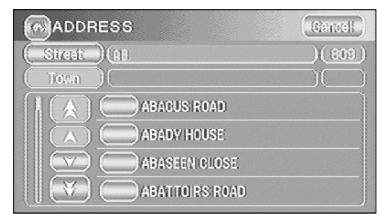

NOTE :
If the house number data is not stored on the map disc, the system may display the wrong location.

- 6** Select **Dest.** (Destination).

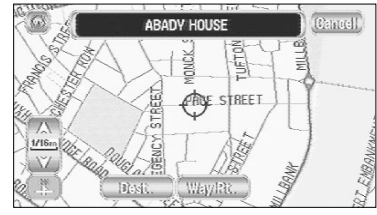

Way Pt. (Way Point).....Sets the way point.

NOTE :
If your destination is not on a road,set destination point on nearest main road.

- 7** The Entire Route Map appears.

Select **Start** .

or

- Next** (Next Route)This brings up the next proposed route.
- Chg. Route** (Change Route)You can alter the route calculation conditions, etc.
(See page 25)

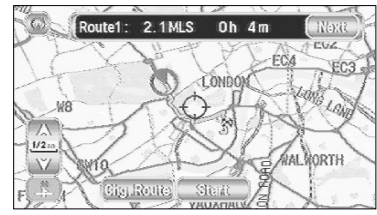

- 8** The route is found and route guidance begins.

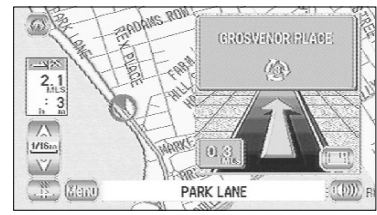

Memory Point

If a marked point is stored, you can make it the destination.



1 Select  (Memory Point).

2 Select the required Memory Point.

See page 17, part 6 to 8 for the route search method.



NOTE :

You cannot use this function if no Memory Point is stored. (See page 35 for the Memory Point storing method.)

Home

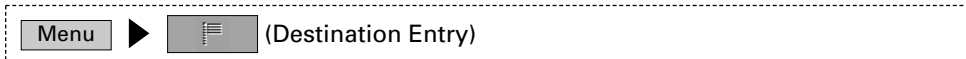

1 Select  (Home).

2 The map of the area around Home appears.

See page 17, part 6 to 8 for the route search method.

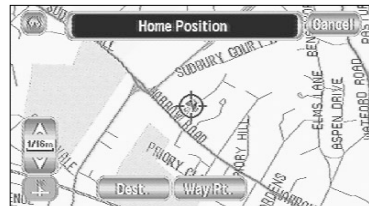

NOTE :

You cannot use this function if Home is not stored. (See page 35 for the Home storing method.)

Point of Interest

This finds a name from the list of points of interest and makes it the destination.

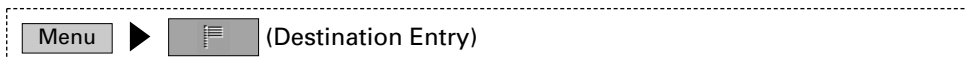

1 Select  (Point of Interest).

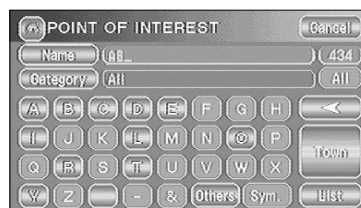

2 Enter the name of the point and select  .

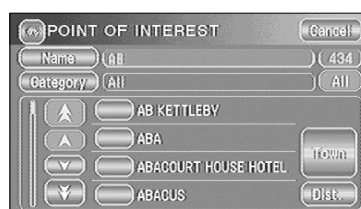

3 Select the required point of interest from the list.

See page 17, part 6 to 8 for the route search method.



If there is more than one item with the same name, select  or  to shorten the list.

Previous Destination

This lets you choose one of the most recent 20 destinations or way points and set it as your new destination.

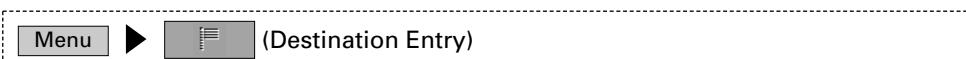

1 Select  (Previous Dest.).

2 Select the Previous Destination you want.

See page 17, part 6 to 8 for the route search method.



NOTE :

You cannot use this function if there are no Previous Destinations.

Postcode

This finds a location by its postcode and makes it the destination.



1 Select  (Postcode).

2 Enter the postcode and select  .

See page 17, part 6 to 8 for the route search method.

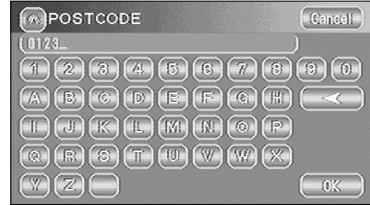

This deletes the last character entered. Selecting it continuously deletes all of the characters entered.



NOTE :

Postcodes cover a designated area so destination may be some distance from wanted address.

Select from Map

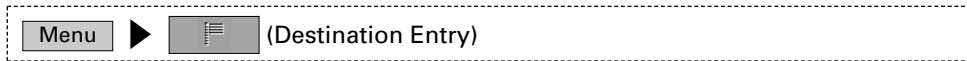
This finds a location from the map that was last displayed and makes it the destination.



1 Select  (Next Page) and then  (Select from Map).

2 The map that was last displayed appears again.

See page 17, part 6 to 8 for the route search method.

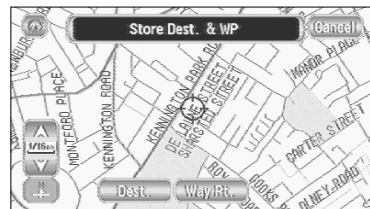

Motorway Entrance/Exit

This finds the name of a motorway entrance or exit and makes it the destination.

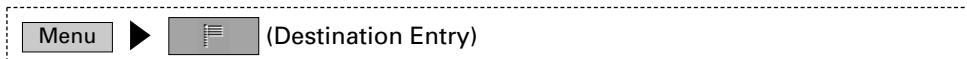

1 Select (Next Page) and then (Motorway Ent/Exit).

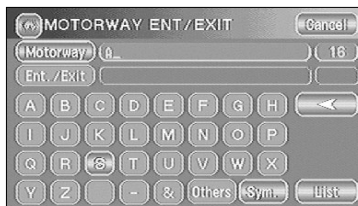

2 Enter the name of the motorway and select .

3 Select the name of the motorway you want.

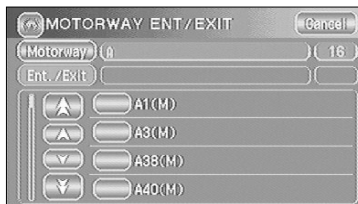

4 Select or .



5 Select the name of the entrance or exit you want from the list.

See page 17, part 6 to 8 for the route search method.

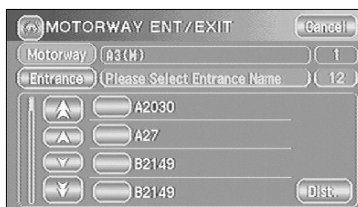

Change (Change Search Area)

This designates the area in which the destination can be set.





1 Select **Change** .

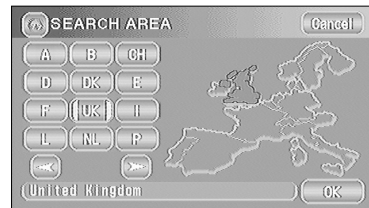

2 Select the Search Area and then **OK** .

See page 16 for the destination setting method.



- You can switch between screens by selecting  or  .

NOTE :

The SEARCH AREA screen above is the imaged screen. It may be slightly different than the screen of the unit.

Route Guidance

Guidance Screen

Whilst driving along during route guidance, the directions for the next junction where you have to turn are shown as a Turn Arrow or Turn List. To change the display, see page 33.

<Turn Arrow>

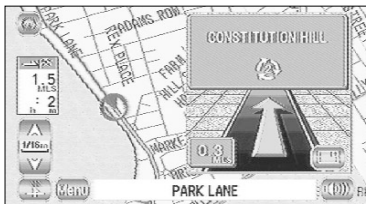

Directions are indicated by an arrow.

<Turn List>

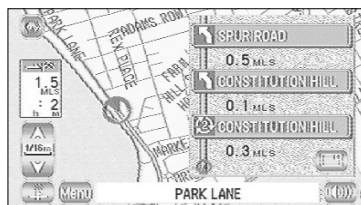



Directions are indicated as a list.

Enlarged Junction Diagram

Before a fork in the road, an enlarged diagram of the junction automatically appears in a second screen. This is to make route guidance even clearer.

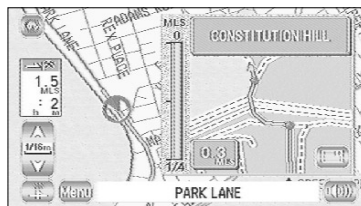
During route guidance, an enlarged diagram of an approaching fork or junction appears. When you drive past the junction, the enlarged diagram disappears.



- To stop the enlarged junction diagram being displayed, you can select  to switch to the following input screen.

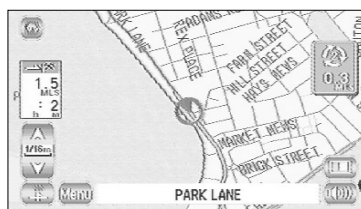
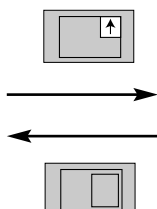
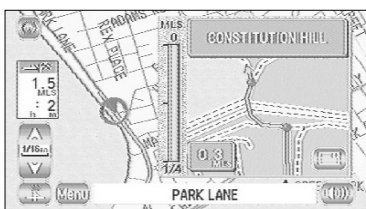

The enlarged junction diagram can be displayed.

- Even if you select , an enlarged junction diagram will appear again as you approach the next junction.

NOTE :

The name of the junction sometimes does not appear on the enlarged junction diagram.

Fork Junction Diagram

During route guidance, an enlarged diagram of the motorway automatically appears in a second screen as you approach a fork on the motorway. This is to make route guidance even clearer.

During route guidance along a motorway, a diagram of an approaching fork or exit appears. When you drive past that junction, the diagram disappears.

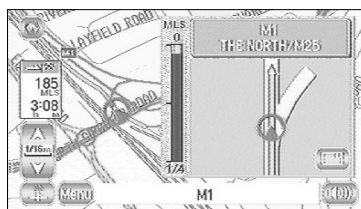

Replaying Voice Guidance

This function allows you to listen to the last voice guidance message again during route guidance.

Select  .

You can hear the voice guidance again.

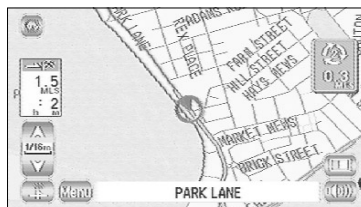

Voice Guidance

During route guidance, voice guidance will inform you of distances and turning directions as you approach turning points, way points or the destination. If you want voice guidance, switch on as follows.

1 Select  .

2 Select  .

You can hear the voice guidance.



...Voice guidance is not given.

Route Options

During route guidance you can change the route options, stop or check the route.

1 Select **Menu** and then  (Route Options).



2 The Route Options screen appears.

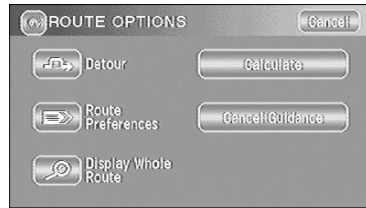

DetourThis calculates an alternative route from your current position within a specified distance. (See page 26)

Route PreferencesAllows you to alter the route search conditions and recalculate. (See page 26)

Display Whole RouteAllows you to confirm the route information during guidance. (See page 27)

CalculateRecalculates the route.

Cancel GuidanceStops route guidance. Note that this deletes the destination and way points. To start guidance again, select **Calculate** .

NOTE :
 Recalculating the route sometimes provides the same route as before.

Detour

You can specify the distance from your current position and the mobile navigation system calculates an alternative route.



- 1** Select  (Detour).
- 2** Select the distances for both Residential and Motorway.
- 3** Select or .

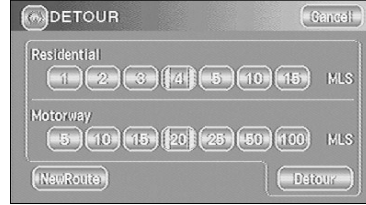

-Recalculates a route to detour the guidance route.
-Calculates another detour.

Route Preferences

You can set the conditions and the mobile navigation system calculates a route.



- 1** Select  (Route Preferences).
- 2** Set the conditions and select .
Select to recalculate a route.



- Minimize Time/Dist.Searches for a route giving priority to time or distance.
- Use Toll RoadsWhen the button No is selected, the mobile navigation system searches for a route avoiding toll roads where possible.
- Use FerriesWhen the button No is selected, the mobile navigation system searches for a route avoiding ferries where possible.

NOTE :

The route will not necessarily follow the specified conditions.

Display Whole Route

This function allows you to display the entire route when the destination is set and the guidance route shown. You can also display the map around the destination and other route information (street names).



Select  (Display Whole Route).

The Entire Route screen appears.

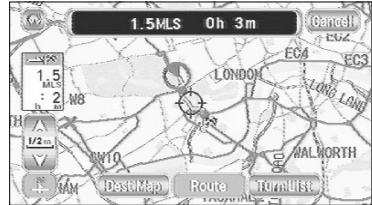

Dest Map (Destination Map)..... Displays the map of the area around the destination.



Route Displays the entire route.

Turn List Displays the data for the entire route. (See below)



Avoid You can set any areas you want to avoid from the list of street names.

Reroute Recalculates the route.

- If the data for the route cannot be shown on one screen, you can scroll using  and .
- You can switch to the screen shown below by selecting **Dest Map** (Destination Map) or **Route**.

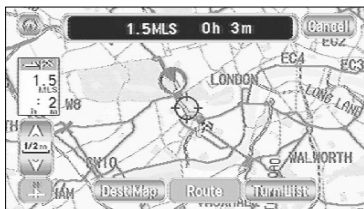
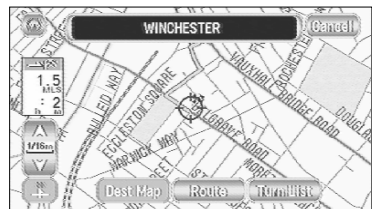
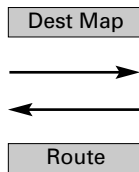



Diagram of entire route



Destination area

Navigation Set Up

This function is for altering the map display conditions and the route guidance conditions and showing the system information.

- 1 Select **Menu** and then  (Navigation Set Up).



- 2 The Navigation Set Up screen appears.

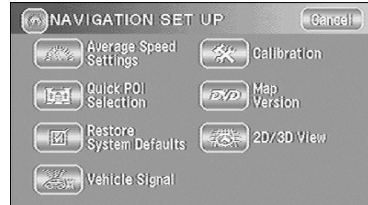



- Average Speed SettingsAllows you to set the predicted average speed for each category of road. (See below)
- Quick POI SelectionAllows you to select the categories on the menu displayed when **POI** has been selected on the Current Position screen.
- Restore System DefaultsAllows you to return all the settings in the navigation system to the initial default settings. (See page 29)
- Vehicle Signal.....Allows you to check the condition of signals that are connected to the navigation system. (See page 30)
- CalibrationAllows you to correct any error in the vehicle display position or direction. (See page 30)
- Map VersionAllows you to check the version of the map disc you are currently using. (See page 31)
- 2D/3D View Allows you to switch between a 2D and 3D display screen. (See page 32)

Average Speed Settings

You can display a more accurate estimation of the time required (see page 34) by setting the predicted average driving speed on each category of road.



- 1 Select  (Average Speed Settings).
- 2 Select   to set the average speed.
- 3 Select **OK** .

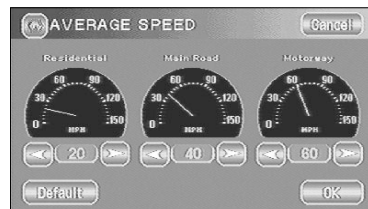

NOTE :
DefaultReturns the average speed setting to the initial default setting.

Quick POI Selection

This function allows you to set the categories on the menu displayed when **POI** (Point of Interest) is selected on the map. (See page 42 for how to display markers on the map and search for nearby points of interest)

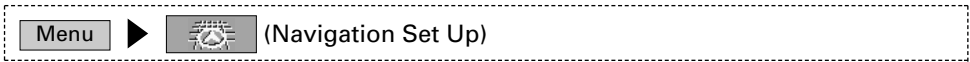

- 1** Select (Quick POI Selection).
- 2** Select a switch to change the POI category.
- 3** Select the POI you want to display on the menu.

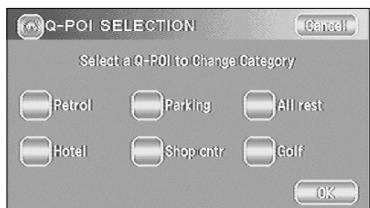

- 4** Select .

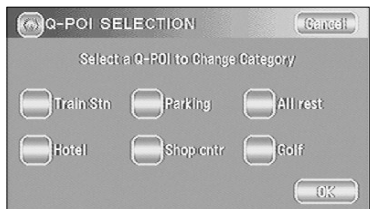
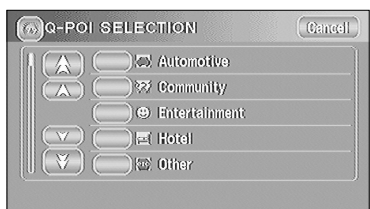

• Repeat the above steps 1 to 4 to add further POI markers displayed on the menu.

Restore System Defaults

This function replaces all the settings in the mobile navigation system with the initial default settings.



- 1** Select (Restore System Defaults).
- 2** Select .

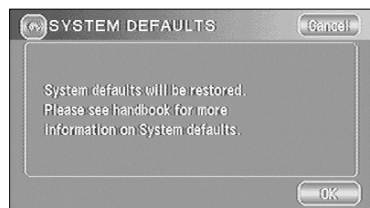

IMPORTANT :
If you execute Restore System Defaults, all of your Stored Locations data will be deleted.

Vehicle Signal

In this screen you can check the navigation connections. The Reverse (REV) and Speed-pulse (SPD) connections are necessary for accurate calibration and functionality.

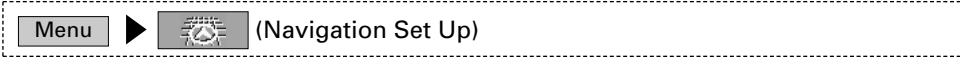

1 Select (Vehicle Signal).

REV. : With the reverse signal wire connected and with reverse gear selected, the REV indicator will change to 'ON'. The current position cursor will move backwards on the map screen (whilst the vehicle is reversing).

PKB. : When the handbrake is applied, the destination input is activated.

ILL. : The illumination connection enables automatic switching of the map screen between day and night mode.

SPD. : The speed-pulse is received from the vehicle's electronics and is necessary to tell the navigation system how fast the car is moving. This speed is an approximation and may differ from that shown on the vehicle's speedometer.

GPS : The number of received GPS satellites is shown and the current position, expressed in Latitude and Longitude.

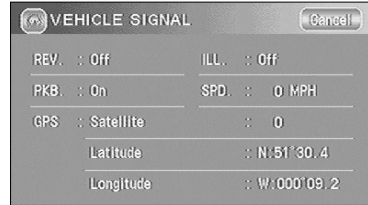

Calibration

This function allows you to correct any error in the position or direction of your vehicle display.

Position

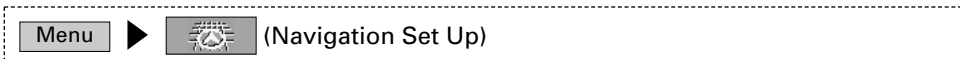

1 Select (Calibration).

2 Select .

3 Move the to the correct position and select .

4 Use or to make point in the direction in which you are driving, and select .

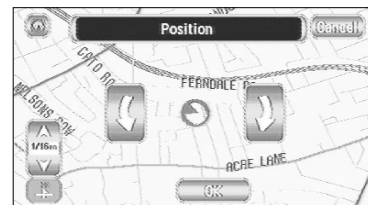
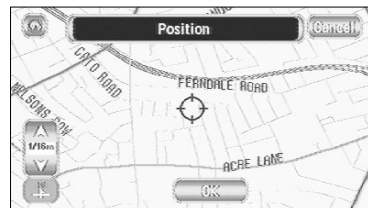

Distance

This function automatically corrects any error in the display of the current position that might occur after tyre replacement.

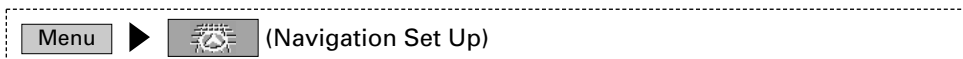

1 Select  (Calibration).

2 Select  .

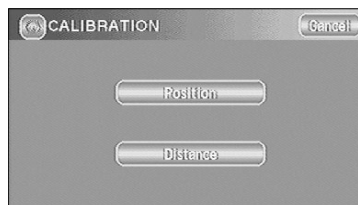

NOTE :

You will have to drive about 10km (6 miles) before distance correction is complete.

Map Version

This function enables you to check the version of the map disc and the software you are currently using.

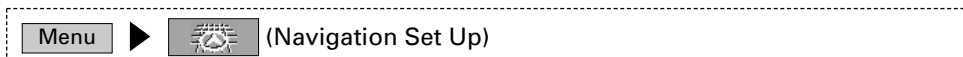

Select  (Map Version).

The version of the map disc and the software you are now using is shown.

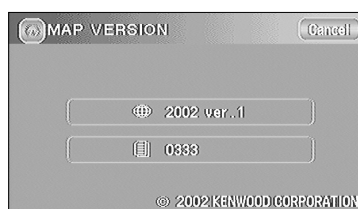

2D/3D View

You can switch between a 2D and 3D display screen. You can also change the viewing angle of the 3D display.

Map Dimension

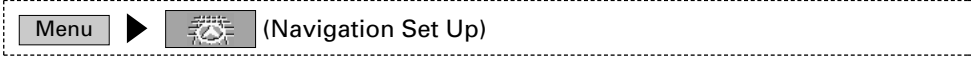

1 Select (2D/3D View).

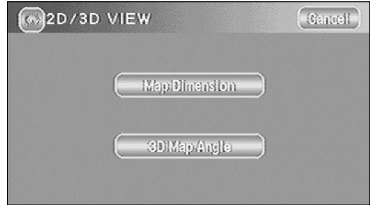

2 Select .

3 Select a 2D or 3D display for the Map Screen and the Guidance Screen.

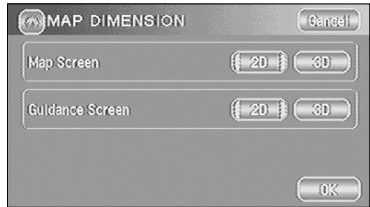

4 Select .

Map Screen Changes the map screen display.
 Guidance Screen Changes the route guidance screen, such as the enlarged junction diagrams.

3D Map Angle

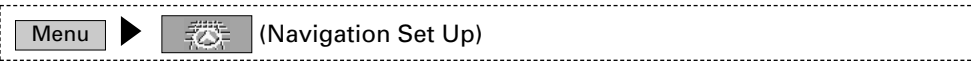

1 Select (2D/3D View).

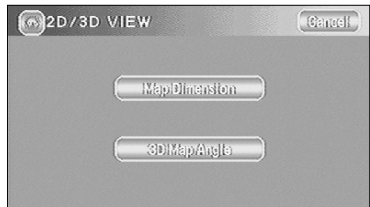

2 Select .

3 Adjust the angle using and on the right of the screen.

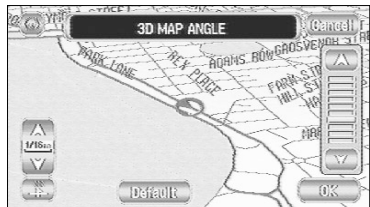

4 Select .

.... Restores the initial default angle setting.

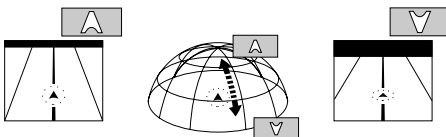

Guidance Options

This allows you to set the route guidance display and method.

1 Select **Menu** .

2 Select  (Guidance Options).

3 Select the item you require and then **OK** .



Time to Destination.....This sets whether the estimated required time to the destination is displayed or not during route guidance. You can also display a more accurate estimation of the time required by carrying out Average Speed setting. (See page 28)
(The time shown here may differ from the actual travel time.)

ShowThe estimated required time is shown.

HideThe estimated required time is not shown.

Audio MuteThis turns off the sound of the car audio system, if it is being played, to allow you to hear the voice guidance during the route guidance.

SplitThe Current Position screen always includes the Guidance screen.

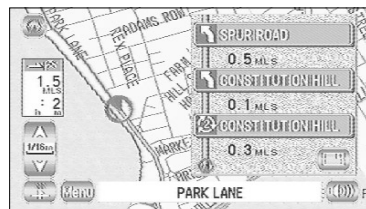
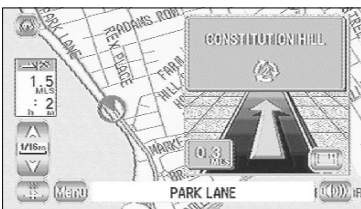

FullThe Current Position screen always shows the mini-arrow.



Arrow.....The Guidance screen that appears whilst driving along the road during guidance gives directions with an arrow. When  is selected, however, the mobile navigation system switches to a mini-arrow display.

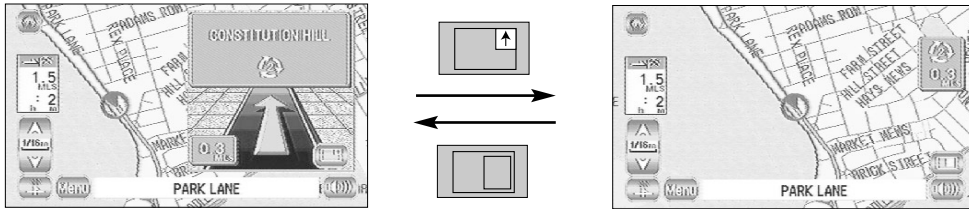

Turn ListThe Guidance screen that appears whilst driving along the road during guidance gives directions as a list. When  is selected, however, the mobile navigation system switches to mini-arrow display.

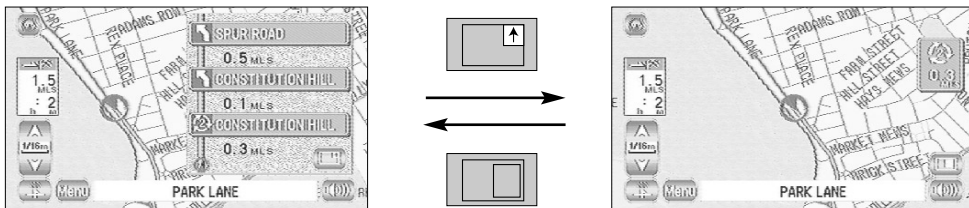

Stored Locations

You can store, edit or delete any destinations, way points or marked point.

[Example]
Here are the steps to add a location to Memory Point.

1 Select **Menu** .

2 Select  (Stored Locations).



3 Select the item you require.

Select  (Memory Points).

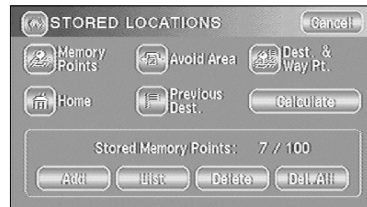

Memory PointsThis places a marker on the map.

HomeThis stores the location of your home.

Avoid AreaThis stores any areas to be avoided.

Previous Dest. (Destinations)This deletes previously stored destinations (and way points).

Dest. & Way Pt. (Destination and Way Point)

.....This sets the destination (and way points).

4 Select **Add** .

You can display the map of the area you require by selecting one of the methods on the screen.

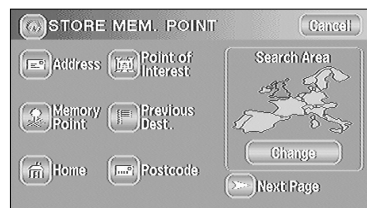

- See page 16 for how to access maps.

- Select the editing method you require from **Add** , **List** , **Delete** and **Del. All** (Delete All).

- Add**This is for storing a new location.
- List**This is for displaying the list of stored locations.
- Delete**This is for deleting stored locations.
- Del. All**This is for deleting all stored locations.

The switches displayed vary according to the item. (See below)

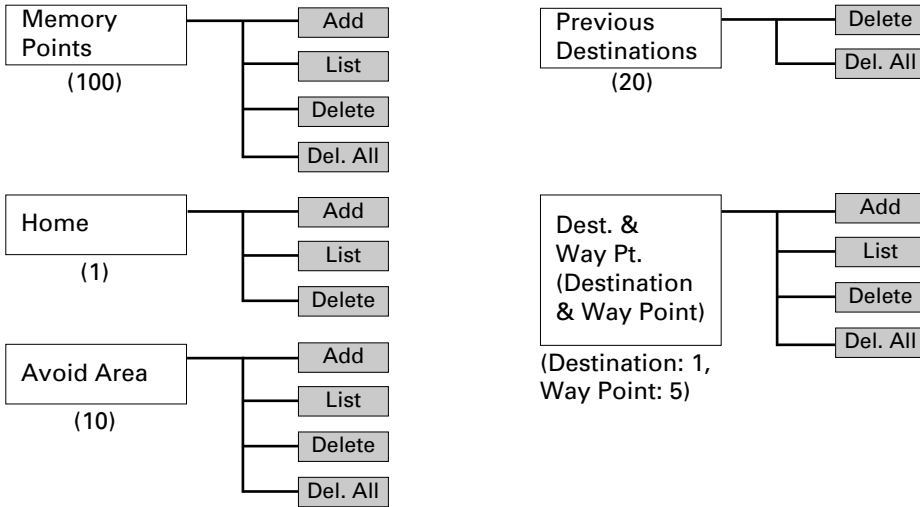

The numbers in the parentheses indicate the maximum items you can store in the memory.

NOTE :

- Up to 100 memory points can be stored. You will not be able to store more than 100. Delete a memory point that you no longer require (see page 40) before storing a new memory point. The remaining number of spaces in the memory is indicated at the bottom of the screen.

5 Select **OK** .



Editing Stored Locations

Edit Memory Points

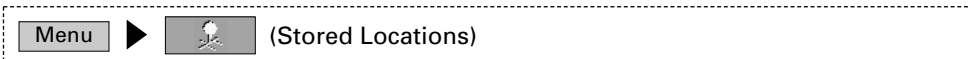

1 Select (Memory Points) and then **List**.

2 Select the location you want to edit.

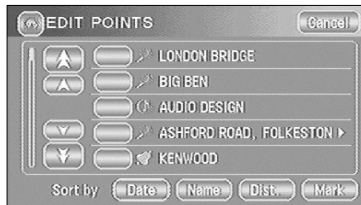

- You can display the Memory Points in the desired order by selecting **Date**, **Name**, **Dist.** (Distance) or **Mark**.

The Edit Point screen appears.



- Icon**This is the icon of the memory point that appears on the map. You can select from 15 kinds of normal icons and 3 kinds of audible icons. (See below)
- Name**This is the name of the memory point. You can change the name as required. (See page 38)
- Position**This is the position of the memory point. You can display and edit this position. (See page 38)
- Tel.** (Telephone)This is the telephone number of the memory point.(See page 38)

Edit Icon



1 Select the location you want to edit and then **Icon**.

2 Select the required icon.



- Audible Icons**As you approach a location marked with such an icon, the mobile navigation system informs you with a sound.

Edit Name

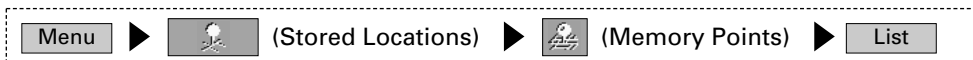

- 1 Select the location you want to edit and then

Name .



.....Selecting this deletes the character that was last entered. Selecting it continuously deletes all the characters that have been entered.

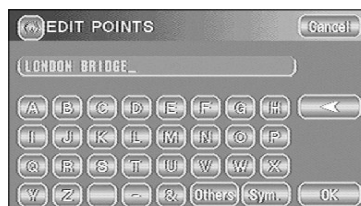

- 2 Enter the name and select .

NOTE :

It may be necessary to delete information before entering new details. Use the

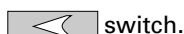

switch.

Edit Position



- 1 Select the location you want to edit and then

Position .

- 2 Move the  to the required position and select

.



Edit Telephone Number

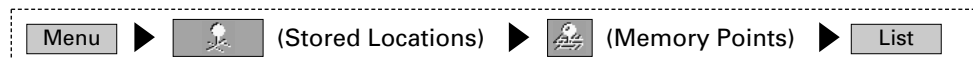

- 1 Select the location you want to edit and then

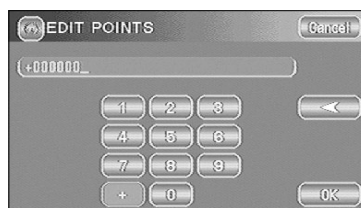

Tel. (Telephone).

- 2 Enter the telephone number and select .



Edit Home

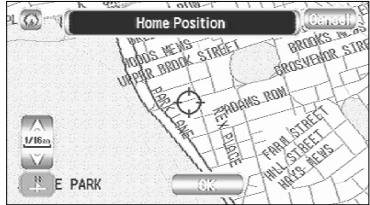

Menu ► (Stored Locations)

- 1 Select  (Home) and then .
- 2 Move the  to the Home position and select .



Edit Avoid Area

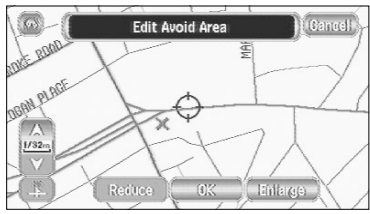
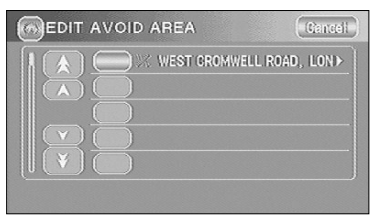

Menu ► (Stored Locations)

- 1 Select  (Avoid Area) and then .
- 2 Select the Avoid Area item to be edited.
- 3 A map including the Avoid Area appears. Move the  to the desired point and specify the area to be avoided using or .
- 4 Select .



Edit Destination & Way Point

Menu ► (Stored Locations)

- 1 Select  (Dest. & Way Pt.) and then .
- 2 Select on the right of the location to be edited.
- 3 Move the  to the required position and select .

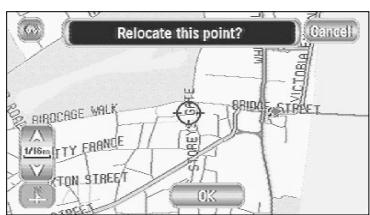

Chg. Order (Change Order)You can change the order of the destination (or way points) shown on the screen below.



By selecting on the right of each point in the order your vehicle will travel, numbers appear to indicate this order.

Select **OK** .

UndoThis restores the previous order before it was switched.

Chg. Loc. (Change Location)This lets you edit the location of the destination or way points.

■ Deleting Stored Locations

[Example]

Here are the steps to delete a location from Memory Point.



1 Select  (Memory Points) and then **Delete** .

Del. All (Delete All).....This deletes all the stored memory points.

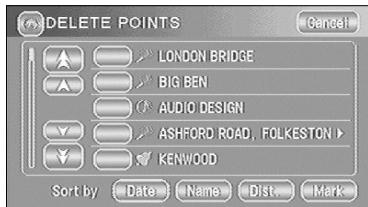

2 Select the marked point you want to delete.

3 Select **Yes** .



User Settings

These are the settings for the screen display and sound.

1 Select **Menu** .

2 Select  (User Settings).

3 Select the required item.

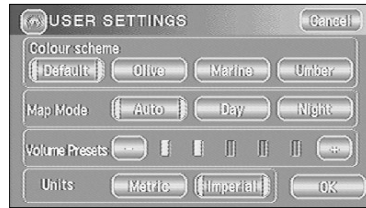

4 Select **OK** .



Colour schemeYou can set one of the four screen colours, Default, Olive, Marine or Umber.

Map ModeYou can set the display to the Day screen or Night screen.

- Auto.....The display will automatically switch between the Day and Night screens when you operate the car lights switch.
- Day.....The Day screen will be displayed regardless of whether the car lights are on or off.
- NightThe Night screen will be displayed regardless of whether the car lights are on or off.

Volume PresetsYou can select  or  to adjust the volume of the voice guidance.

Units..... This sets the map to display metric or imperial units.

Other Functions

Displaying POI's on a Map

You can select one of the six categories on the menu or List Categories and then select the POI(s) to be displayed on the map.

- 1** Touch the screen.
- 2** Select (Points of Interest) from the map.
- 3** Select one of the six categories on the menu or and then select the POI(s) to be displayed on the map.
Allows you to search for a POI. (See below)
 The POI markers will appear.

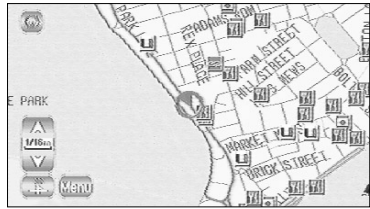
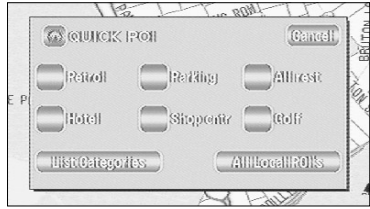

See page 43 for the method of deleting POI's.

Local Search

- 1** Touch the screen.
- 2** Select (Points of Interest) from the map.
- 3** Select (All Local Points of Interest).
- 4** Select the POI you want to find from the list.

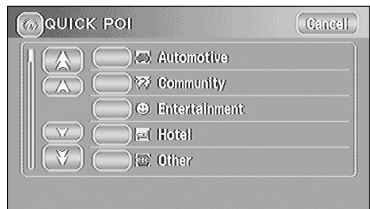
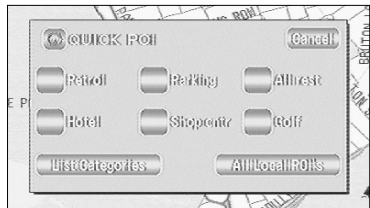

- Displays up to five previous suggestions.
- Displays the previous suggestion.
- Displays the next suggestion.
- Displays up to five of the next suggestions.

The point of interest you selected appears.

Deleting POI Markers

This function deletes any POI markers shown.

- 1 Touch the screen.
- 2 Select **POI Off** (Points of Interest Off).

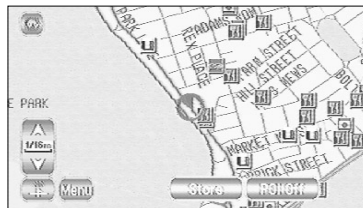

- 3 The POI markers disappear.

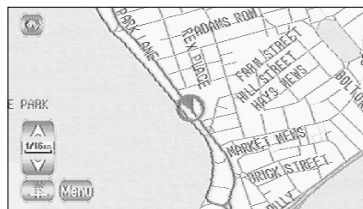

Showing POI Data

You can display POI (Point of Interest) data, such as name, address and telephone number.

- 1 Display the POI's. (See pages 29 and 42)
- 2 Select the POI required by moving the  on the POI icon.



- 3 The name of the selected POI appears. If no data is stored for the selected POI, the POI name is not displayed.

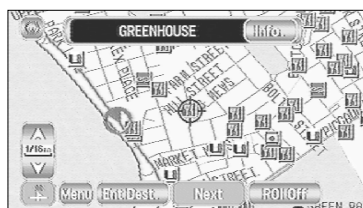

- 4 Select **Info.** (Information).

- 5 The data of that POI is displayed.



NOTE :

POI search and POI display can't be done at a map scale above 1 mile (2 km).

■ Checking the Route by a Simulation Run

The mobile navigation system can show you a simulation of the calculated course automatically.

- 1 After the route has been calculated, touch **Start** for at least 5 seconds.

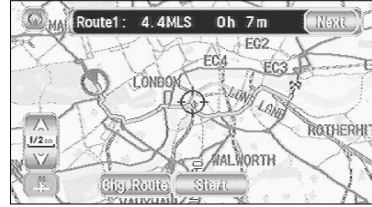

- 2 A simulation run of the set route begins.

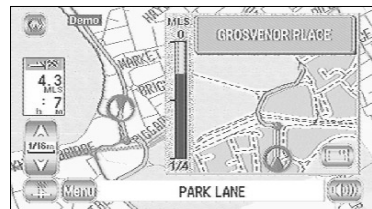
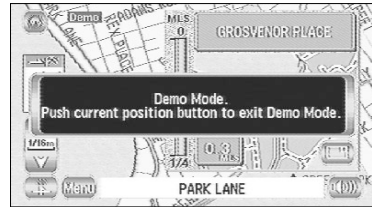

This finishes the simulation run.

- The speed of the simulation run can be altered by changing the scale of the map. The simulation run is faster with a wider area map and slower with a closer up map.

IMPORTANT :

- Finish the simulation run before actually starting to drive. The simulation run will automatically finish when you actually start to drive, but this can lead to an error in the display of the current position of your vehicle.

General Information

Mechanism of Detecting the Vehicle's Position

Detecting the vehicle's position through the GPS

- * GPS stands for the "Global Positioning System"; it is a system for detecting the position through the use of the satellites of the Defence Department of the United States. Radiowave signals from three or more satellites are received by the system, which utilizes the principle of triangulation, in order to detect the position in which the radiowave signals are received.
When this navigation unit is receiving the GPS radiowave signals, a "GPS" mark will appear on the map screen.

Detecting the vehicle's position through self-contained navigation

- * Self-contained navigation is a system that detects the vehicle's position by calculating the vehicle's driven distance and turning angle through the use of various types of sensors that are mounted on the vehicle.
Through the use of self-contained navigation, the vehicle's position can be detected even in an area in which the GPS radiowaves signals cannot be received.

Marking corrections to the detection of the vehicle's position through map matching

- * In map matching, the position information resulting from the detection of the vehicle's position and the locus of the travel of the vehicle up to the present are constantly compared to the shapes of the roads on the map in order to correct the vehicle's position mark to the most appropriate road.
- * If the vehicle is driven on a road whose actual shape differs from the map data, the vehicle's position mark on the map could deviate from the actual position. Occasionally, the correction of the vehicle's position mark to the actual road on the map can be observed particularly after the vehicle has turned at an intersection or has come out of a parking area.

Accuracy of the Vehicle's Position

Area in which GPS signals cannot be received

- * Because the radiowave signals from the GPS satellites travel primarily by line of sight, a navigation system might not be able to receive the signals in the areas described below. (If the GPS mark does not appear on the map screen, it means that the GPS radiowave signals are not being properly received.)
 - (1) Inside a tunnel
 - (2) Inside a building
 - (3) Under a three-dimensional road such as a high-speed road
 - (4) On tree-lined boulevards or in the mountain groves
 - (5) Between buildings
 - (6) Under a cliff or in a cave
- If the GPS antenna or its surroundings are blocked by an obstacle (including cargo), it might not be possible for the system to receive the GPS radiowave signals.
- If multiple paths are created due to the reflection from the buildings, a large measurement error could occur, causing the vehicle's mark to deviate from the actual position.

Deviation of the vehicle's position mark

* The vehicle's mark could deviate from the actual position when the vehicle is being driven under the conditions listed below or due to the conditions of the GPS satellites. If the vehicle travels on a road whose actual shape differs from that in the map data, the vehicle's mark could deviate from the actual position. The correct position will eventually appear on the screen through the correction function. If the screen does not show the correct position for a long time, correct the current position or make an automatic correction.

- (1) The vehicle's mark could appear on a parallel road.
- (2) When the road splits into a narrow Y, the vehicle's mark could appear on the other fork of the Y.
- (3) When the vehicle makes a right or left turn, the vehicle's mark could appear on one street ahead or behind.
- (4) If the vehicle is transported by a means other than the vehicle's own power, such as on a ferry boat, the vehicle's mark will remain in the position before the transport until the system can calculate the position through the GPS.
- (5) When the vehicle is driven on a steep incline, the vehicle's mark could deviate from the actual position.
- (6) If there are continuous curves in the same direction, the vehicle's mark could deviate from the actual position.
- (7) If the vehicle is driven in a zigzag pattern, such as through frequent lane changes, the vehicle's mark could deviate from the actual position.
- (8) If the vehicle is placed on a turntable, such as in a parking area, and turned with the ACC OFF, the orientation of the vehicle's mark could deviate from the actual orientation. The vehicle's mark could also deviate even after the vehicle has exited the parking area.
- (9) The vehicle's mark could deviate from the actual position if the vehicle is driven on a snow-covered road or on a mountainous road with tyre chains or spare tyres.
 - * After driving the vehicle under those conditions, perform the same operation given in the section on "After changing tyres".
- (10) The vehicle's mark could deviate from the actual position after the tyres have been replaced.
 - * After replacing the tyres, refer to the section on "After changing tyres".

■ Accuracy of the Route Guidance

The conditions listed below do not indicate a malfunction.

- (1) If the vehicle proceeds to the destination without passing through the transit point, a route to return to the transit point could appear on the screen if a search is repeated.
- (2) The guidance might prompt the driver to drive straight even though the vehicle is being driven on a straight road.
- (3) The directional guidance could display multiple place names.
- (4) If the vehicle makes a turn at an intersection before the guided route, the wrong type of voice guidance could be output.
- (5) The guidance might not be output whilst the vehicle is making a turn at an intersection.
- (6) The system might not be able to search for the proper route.
- (7) If there is no road to the destination or if there is only a narrow road, the route might only indicate up to an area that is away from the destination.
- (8) The repeat search time could be long whilst the vehicle is being driven at high speeds.
- (9) Whilst the system is searching again for the route, the route indication might not appear in time for the next right or left turn.
- (10) Whilst searching again for the route, the route could make a larger turn.
- (11) The route might not change even if a search is made again.
- (12) The system might guide the driver to make a U-turn.
- (13) The system might guide the driver on a road that cannot actually be travelled (such as on a road in which entry is prohibited).
- (14) The system might not output a guidance even if the vehicle is driven in reverse on the guided route.
- (15) The system might not use a ferry boat even if it is located nearby.
- (16) If the guided intersection is near the end of the route search, the system might not be able to provide guidance.
- (17) The route might not go on a toll road even the toll-road priority is selected. Similarly, a route that uses a toll road could appear on the screen even if the toll-road priority is not selected. (The driver may or may not select the "toll-road priority" if both toll and free roads are available.)

Troubleshooting

See the table below to confirm whether any problem is due to a minor operational error or a malfunction.

A problem might be due to a minor operational error rather than a malfunction. Check the table below before contacting your local dealer for any repair service.

General problems on the navigation system

Problem	Possible cause	Probable solution
The power does not come on.	The fuse might be blown.	Check the fuse. Replace it if it is blown.
The map does not scroll even when the vehicle is moving.	The screen shown might not be the Current Position screen.	See page 13 of this manual to display the Current Position screen.
The vehicle marker does not appear.	The screen shown might not be the Current Position screen.	See page 13 of this manual to display the Current Position screen.
The GPS marker is not displayed.	The GPS antenna or your vehicle might be in a position where GPS signals cannot be received.	Try moving the GPS antenna or your vehicle to a position where there are no obstacles around.
There is no voice guidance.	Route guidance might be suspended.	The route guidance is off, see Route Options (page 25).
	The guidance volume might be turned down low.	See User Settings (page 41).
Small spots or bright flashes appear in the screen displayed.	This is probably due to the nature of the LCD display.	There is nothing wrong with the display and no need for concern.
The map disc cannot be ejected.	The disc might be incompatible or might have been inserted incorrectly.	Restart the engine and see page 4 of this manual.

Terminology

Here is an explanation of the terms displayed on the screens.

All Local POI'sAll Local Points of Interest
A-ZA to Z
Chg. Loc.Change Location
Chg. OrderChange Order
Chg.RouteChange Route/Alter Priorities
Del. AllDelete All
Dest.Destination
DistDistance
Dest MapDestination Map
Ent Dest.Enter Destination
Info.Information
POIPoint of Interest
POI OffPoint of Interest Off
Sym.Symbol
Tel.Telephone
Way Pt.Way Point

KENWOOD

Free Manuals Download Website

<http://myh66.com>

<http://usermanuals.us>

<http://www.somanuals.com>

<http://www.4manuals.cc>

<http://www.manual-lib.com>

<http://www.404manual.com>

<http://www.luxmanual.com>

<http://aubethermostatmanual.com>

Golf course search by state

<http://golfingnear.com>

Email search by domain

<http://emailbydomain.com>

Auto manuals search

<http://auto.somanuals.com>

TV manuals search

<http://tv.somanuals.com>