

KENWOOD

AUDIO / VIDEO STEREO RECEIVER

KR-V5550

INSTRUCTION MANUAL

KENWOOD CORPORATION

Introduction

Your choice of this product indicates that you are a devotee to excellence in sound reproduction.

We appreciate your patronage and take pride in the long tradition of quality components that our company represents.

So that you can get the most out of your unit, we suggest that you take the time to read through this manual before you hook up and operate your system. This will acquaint you with operating features and system-connection considerations so that your listening pleasure will be enhanced right from the start. You will notice that in all aspects of planning, engineering, styling, operating convenience and adaptability we have sought to anticipate your needs and desires.

Keep this manual handy for future reference.

For your records

Record the serial number, found on the back of the unit, in the spaces designated on the warranty card, and in the space provided below. Refer to the model and serial numbers whenever you call upon your dealer for information or service on this product.

Model KR-V5550 Serial Number _____

Unpacking

Unpack the unit carefully and make sure that all accessories are put aside so they will not be lost.

Examine the unit for any possibility of shipping damage. If your unit is damaged or fails to operate, notify your dealer immediately. If your unit was shipped to you directly, notify the shipping company without delay. Only the consignee (the person or company receiving the unit) can file a claim against the carrier for shipping damage.

We recommend that you retain the original carton and packing materials for use should you transport or ship the unit in the future.

For the U.S.A.

Note to CATV system installer:

This reminder is provided to call the CATV system installer's attention to Article 820-40 of the NEC that provides guidelines for proper grounding and, in particular, specifies that the cable ground shall be connected to the grounding system of the building, as close to the point of cable entry as practical.

Accessories

- AM loop antenna 1
- FM indoor antenna 1

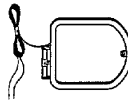

- Loop antenna stand 1
- Remote control unit 1

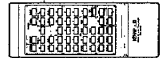



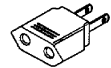

- Batteries(R6 / AA) 2
- AC plug adaptor 1
(Except for some areas)



Contents

Caution: Read the pages marked  carefully to ensure safe operation.

Introduction	2
 Before applying power	3
 Safety precautions	3
 IMPORTANT SAFEGUARDS	4
System connections	6
Controls and indicators	10
Remote control unit operation	11

Operating instructions	13
Reception of radio broadcast	17
Operation with video components	19
DOLBY SURROUND	20
In case of difficulty	21
 Specifications	23

Before applying power

 **Caution: Read this page carefully to ensure safe operation.**

For the U.S.A. and Canada

Important!

Units shipped to the U.S.A. and Canada are designed for operation on 120 volts AC only.

CAUTION: TO PREVENT ELECTRIC SHOCK DO NOT USE THE AC PLUG WITH AN EXTENSION CORD, RECEPTACLE OR OTHER OUTLET UNLESS THE BLADES CAN BE FULLY INSERTED TO PREVENT BLADE EXPOSURE.

For Australia and Europe

Important!

Units shipped to Australia are designed for operation on 240 V AC only.

Units shipped to Europe are designed for operation on 230 V AC only.

For the United Kingdom

Important!

Units shipped to the U.K. are designed for operation on 240 volts AC only.

The mains plug must be removed from the wall socket prior to any internal examination.

The wires in this mains lead are coloured in accordance with the following code:

Blue Neutral
Brown Live

The wires in this mains lead must be connected to the terminals in the plug as follows:

Wire colour	Plug terminal marking
Blue	N or Black
Brown	L or Red

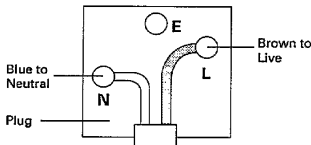

Notes:

1. If a 13-amp plug is used, this must be fitted with a 13-amp fuse.
2. If a 3-pin plug with earthing contact is used, no wire must be connected to the E terminal.

For other countries

Important!

Units shipped to countries other than the above countries are equipped with an AC voltage selector switch on the rear panel. Refer to the following paragraph for the proper setting of this switch.

AC voltage selection

This unit operates on 110 - 120 or 220 - 240 volts AC. The AC voltage selector switch Type A or Type B on the rear panel is set to the voltage that prevails in the area to which the unit is shipped. Before connecting the power cord to your AC outlet, make sure that the setting position of this switch matches your line voltage. If not, it must be set to your voltage in accordance with the following direction.

AC voltage selector switch

Type A

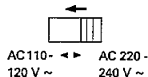

Type B

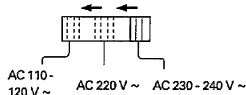

Move switch lever to match your line voltage with a small screwdriver or other pointed tool.

Notes:

Our warranty does not cover damage caused by excessive line voltage due to improper setting of the AC voltage selector switch.

Safety precautions

WARNING: TO PREVENT FIRE OR ELECTRIC SHOCK, DO NOT EXPOSE THIS APPLIANCE TO RAIN OR MOISTURE.



CAUTION
RISK OF ELECTRIC SHOCK
DO NOT OPEN



CAUTION: TO REDUCE THE RISK OF ELECTRIC SHOCK, DO NOT REMOVE COVER (OR BACK). NO USER-SERVICEABLE PARTS INSIDE, REFER SERVICING TO QUALIFIED SERVICE PERSONNEL.



THE LIGHTNING FLASH WITH ARROWHEAD SYMBOL, WITHIN AN EQUILATERAL TRIANGLE, IS INTENDED TO ALERT THE USER TO THE PRESENCE OF UNINSULATED "DANGEROUS VOLTAGE" WITHIN THE PRODUCT'S ENCLOSURE THAT MAY BE OF SUFFICIENT MAGNITUDE TO CONSTITUTE A RISK OF ELECTRIC SHOCK TO PERSONS.



THE EXCLAMATION POINT WITHIN AN EQUILATERAL TRIANGLE IS INTENDED TO ALERT THE USER TO THE PRESENCE OF IMPORTANT OPERATING AND MAINTENANCE (SERVICING) INSTRUCTIONS IN THE LITERATURE ACCOMPANYING THE APPLIANCE.

IMPORTANT SAFEGUARDS

 **Caution: Read this page carefully to ensure safe operation.**

Please read all of the safety and operating instructions before operating this unit. For best results, follow all warnings placed on the unit and adhere to the operating and use instructions. These safety and operating instructions should be retained for future reference.

1. Power sources – The unit should be connected to a power supply only of the type described in the operating instructions or as marked on the appliance.

2. Power-cord protection – Power-supply cords should be routed so that they are not likely to be walked on or pinched by items placed upon or against them, pay particular attention to cords at plugs, convenience receptacles, and the point where they exit from the unit.

Never pull or stretch the cord.

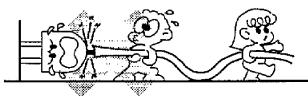

3. Grounding or polarization – The precautions should be taken so that the grounding or polarization means of this unit is not defeated.

4. Ventilation – The unit should be situated so that its location or position does not interfere with its proper ventilation.

To maintain good ventilation, do not put records or a table-cloth on the unit. Place the unit at least 10 cm away from the walls.

Do not use the unit on a bed, sofa, rug or similar surface that may block the ventilation openings.

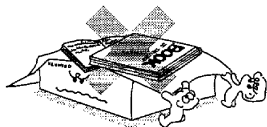

5. Water and moisture – The unit should not be used near water - for example, near a bathtub, washbowl, kitchen sink, laundry tub, in a wet basement, or near a swimming pool, etc.

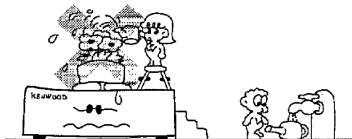

6. Temperature – The unit may not function properly if used at extremely low, or freezing temperatures. The ideal ambient temperature is above +5°C (41°F).

7. Heat – The unit should be situated away from heat sources such as radiators, heat registers, stoves, or other units (including amplifiers) that produce heat.

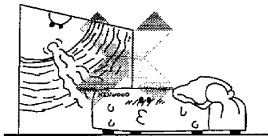

8. Electric shock – Care should be taken so that objects do not fall and liquid is not spilled into the enclosure through openings. If a metal object, such as a hair pin or a needle, comes into contact with the inside of this unit, a dangerous electric shock may result. For families with children, never permit children to put anything, especially metal, inside this unit.

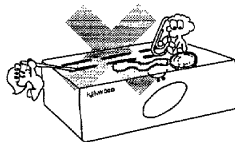

9. Enclosure removal – Never remove the enclosure. If the internal parts are touched accidentally, a serious electric shock might occur.

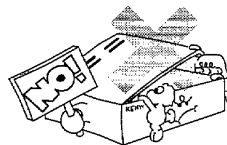

10. Magnetic fields – Keep the unit away from sources of magnetic fields such as TV sets, speaker systems, radios, motorized toys or magnetized objects.

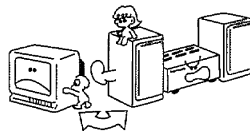

11. Cleaning – Do not use volatile solvents such as alcohol, paint thinner, gasoline, or benzine, etc. to clean the cabinet. Use a clean dry cloth.



12. Carts and stands – An appliance and cart combination should be moved with care. Quick stops, excessive force, and uneven surfaces may cause the appliance and cart combination to overturn.



13. Nonuse periods – The power cord of the unit should be unplugged from the outlet when left unused for a long period of time.

14. Abnormal smell – If an abnormal smell or smoke is detected, immediately turn the power OFF and pull out the power cord. Contact your dealer or nearest service center.

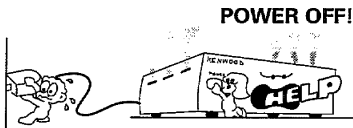

15. Damage requiring service – The unit should be serviced by qualified service personnel when:

- A. The power-supply cord or the plug has been damaged; or
- B. Objects have fallen, or liquid has been spilled into the unit; or
- C. The unit has been exposed to rain; or
- D. The unit does not appear to operate normally or exhibits a marked change in performance; or
- E. The unit has been dropped, or the enclosure damaged.

16. Servicing – The user should not attempt to service the unit beyond that described in the operating instructions. All other servicing should be referred to qualified service personnel.

17. Outdoor antenna grounding – If an outside antenna system is connected to the receiver, be sure the antenna system is grounded so as to provide some protection against voltage surges and built up static charges. Section 810 of the National Electrical Code, ANSI/NFPA 70, provides information with respect to proper grounding of the mast and supporting structure, grounding of the lead-in wire to an antenna discharge unit, size of grounding conductors, location of antenna-discharge unit, connection to grounding electrodes, and requirements for the grounding electrode. See Figure.

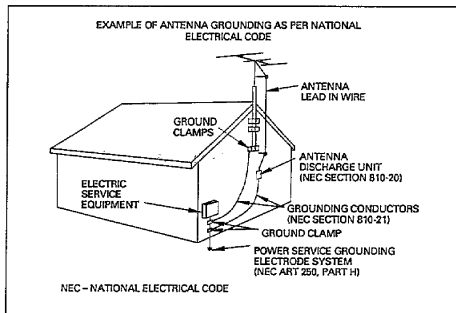

18. Power lines – An outdoor antenna should be located away from power lines.

19. AC outlets – Do not connect other audio equipment with a power consumption larger than that specified to the AC outlet on the rear panel. Never connect other electrical units, such as an iron or toaster, to it to prevent fire or electric shock.

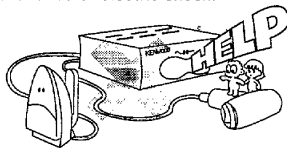

Notes:

- 1. Item 3 is not required except for grounded or polarized equipment.
- 2. Items 17 and 18 are not required except for units provided with antenna terminals.
- 3. Item 17 complies with UL in the U.S.A.

System connections

Make connections as shown below. When connecting the related system components, refer also to the instruction manuals of the related components.

Do not plug in the power cord until all connections are completed.

■ Connection of audio components

For the connection of video components, please refer to page 19.

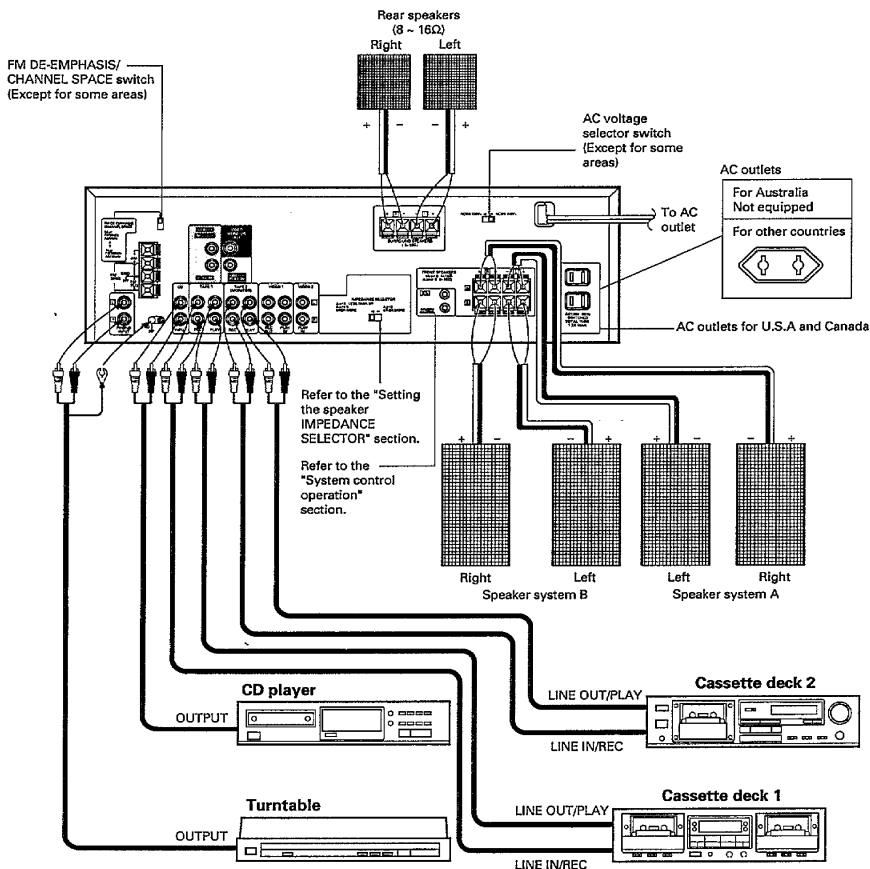

Notes on connection

- Connect all cords firmly. If connections are loose, there could be loss of sound or noise produced.
- When plugging or unplugging connection cords, be sure to first unplug the power cord from the AC outlet. Plugging / unplugging connection cords without disconnecting of the power cord can cause malfunctions or damage to the unit.
- Do not connect a component with a power rating larger than that indicated at the rear of the unit.

■ Connection of speakers

- ① While pressing lever. ② Insert cord. ③ Release lever.

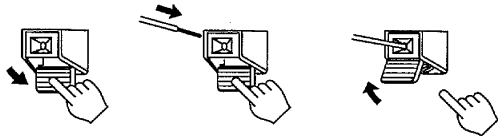

- Never short-circuit the + and - speaker cords.
- If the left and right speakers are connected inversely or if the speaker cords are connected with reversed polarity, the sound becomes unnatural with ambiguous acoustic image positioning. Be sure to connect the speakers and speaker cords correctly.

Setting the speaker IMPEDANCE SELECTOR

A or B:
LESS THAN 8Ω
A and B:
8Ω OR MORE A or B:
8Ω OR MORE



IMPEDANCE SELECTOR

According to the impedance of the speakers used, set the speaker IMPEDANCE SELECTOR on the rear panel as shown in the table.

When using speakers A or B separately

Speaker impedance	Selector position
4 Ω, 6 Ω	A or B : LESS THAN Ω
8 Ω, 16 Ω	A or B : 8 Ω OR MORE

When using speakers A and B simultaneously

Speaker impedance	Selector position
8 Ω, 16 Ω	A and B : 8 Ω OR MORE

- When the IMPEDANCE SELECTOR switch is set to "A or B : 8 Ω OR MORE", it is impossible to use A and B speakers at the same time. Therefore, when using the speakers A and B simultaneously, be sure to set the IMPEDANCE SELECTOR switch to the "A and B : 8 Ω OR MORE" position.
- When connecting speakers and operating the speaker IMPEDANCE SELECTOR, make sure the POWER switch is OFF.

FM DE-EMPHASIS / CHANNEL SPACE switch (Except for some areas)

The FM DE-EMPHASIS / CHANNEL SPACE switch on the rear panel is already set to the correct setting that prevails in the area to which the unit is shipped. However, the FM DE-EMPHASIS / CHANNEL SPACE setting may be different in some areas. In this case, change the FM DE-EMPHASIS / CHANNEL SPACE setting as shown in the table.

- When changing the setting of the FM DE-EMPHASIS / CHANNEL SPACE switch, first disconnect the power cord, then change the switch setting, connect the power cord again, and turn the power on.

	Area	CHANNEL SPACE freq.	FM DE-EMPHASIS
1	U.S.A., Canada, and South American countries	FM: 100kHz AM: 10kHz	75μs
2	Other countries	FM: 50kHz AM: 9kHz	50μs

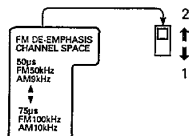

System connections

Connection method to each antenna terminal

- ① While pressing lever.
- ② Insert cord.
- ③ Release lever.

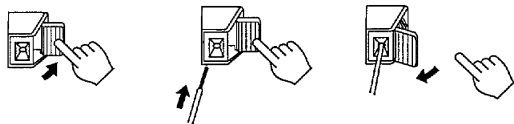

AM loop antenna connection

The supplied antenna is for indoor use. Place it as far as possible from the main system, TV set, speaker cords and power cord, and set it to the direction which provides the best reception.

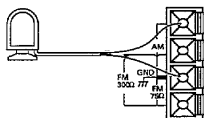

AM outdoor antenna connection

If reception is poor when using the AM loop antenna, connect the ANTENNA terminals to a vinyl-coated wire of more than 6 meters outdoors, without disconnecting the loop antenna.

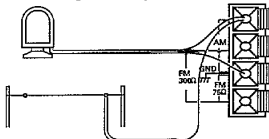

FM indoor antenna connection

The supplied antenna is for indoor use. For stable reception, it is recommended to install an outdoor antenna as soon as possible.

- ① Find the position that provides best reception.
- ② Fix the two ends.

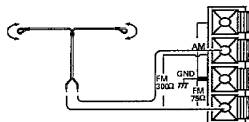

FM outdoor antenna connection

It is recommended to install an exclusive FM outdoor antenna to receive FM broadcast with high sound quality. Use a coaxial cable for the connection between the outdoor antenna and FM ANTENNA terminal on the rear panel. For the connection between the coaxial cable and FM ANTENNA terminal, please refer to the illustration.

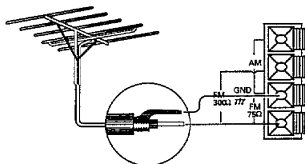

■ Connection for system control operation

Using the system control cords provided with KENWOOD system components, make connections as shown below.

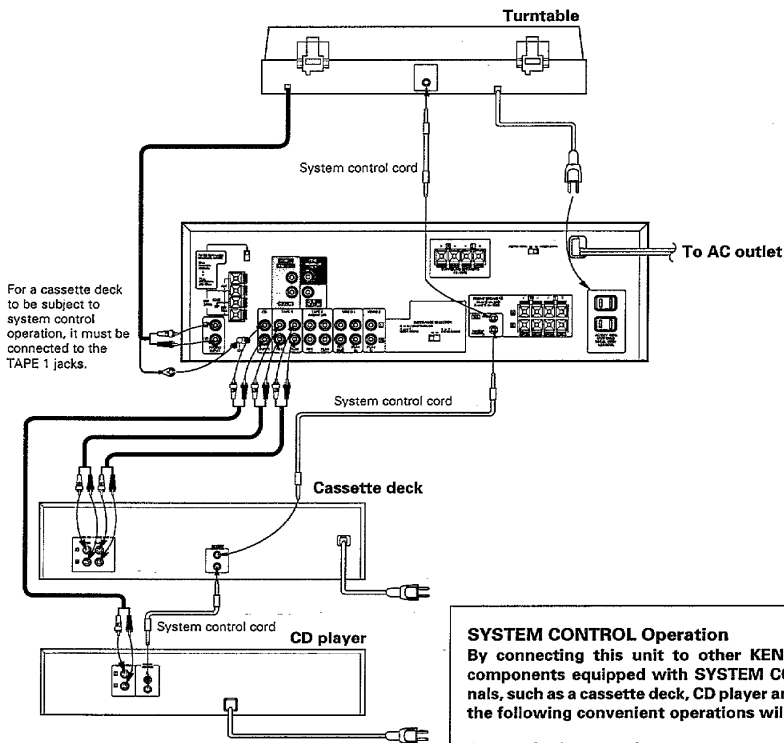

System control connection

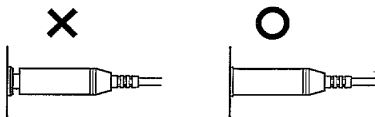

- Be sure to insert the system control cord plugs fully into the SYSTEM CONTROL terminals.
- If the system control cord and audio cords are not connected properly, the automatic system governing remote control and system functions will not operate.

SYSTEM CONTROL Operation

By connecting this unit to other KENWOOD system components equipped with SYSTEM CONTROL terminals, such as a cassette deck, CD player and/or turntable, the following convenient operations will be available.

Automatic play operation

To play the turntable, cassette deck, or CD player connected to this unit, press the desired input selector keys on this unit. The turntable, cassette deck, or CD player will automatically enter play mode.

In the same way, pressing the Play key of the turntable, cassette deck, or CD player will automatically switch the input selector on this unit to the corresponding component.

Synchro recording

To record sound from the CD player or turntable onto a tape with the cassette deck, press the CD or PHONO input selector key and load a CD or record. Set the cassette deck to rec pause mode, then press the Play (start) key of the CD player or turntable. The cassette deck will start recording automatically, synchronized with the CD player or turntable.

For more details, refer to the instruction manual of the cassette deck.

Remote control

When the cassette deck, and CD player are connected via the system control cords, these components can be controlled from the remote control unit supplied with this unit.

Controls and indicators

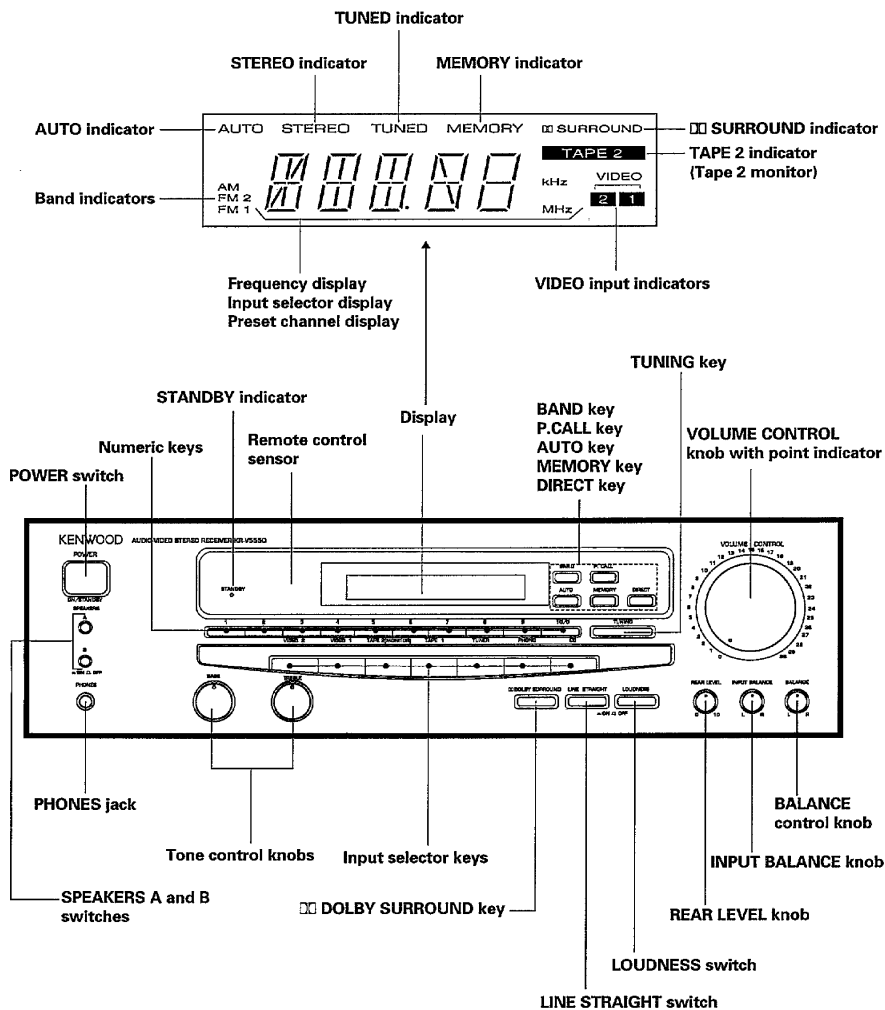

POWER switch STANDBY mode

When the power cord of this system is plugged into an AC outlet, the STANDBY indicator lights up regardless of the ON / OFF setting of the POWER switch. This indicates that a small amount of current is being supplied to the unit to back up the memory contents. This mode is referred to as the standby mode. When the STANDBY indicator is lit, the power of the system can be switched ON / OFF from the remote control unit.

Remote control unit operation

■ Loading batteries

1 Remove the cover.

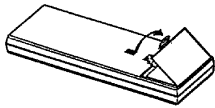

2 Insert batteries.

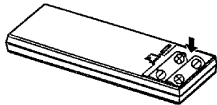

- Insert two AA-size (R6/SUM-3) batteries as indicated by the polarity marking.

3 Close the cover.

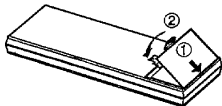

■ Operation procedure

Plug the power cord of the system into an AC wall outlet, and press the **POWER** key on the remote control unit to turn the power on. When the power is turned on, press the key of the source component to be operated.

- When two operation keys on the remote control unit are pressed successively, wait for one second or more between presses.
- Components connected via the system control cords, such as a CD player, can also be remote-controlled. In this case, please read the instruction manual supplied with your CD player.

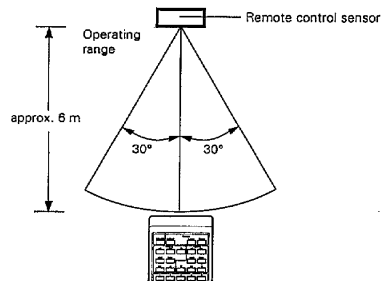

Notes on operation

- The supplied batteries are intended only for use in checking operation. Therefore, battery life may be shorter than ordinary batteries.
- When the remote-controllable distance gets shorter than before, replace both batteries with new ones.
- Malfunction may occur if direct sunlight or the light of a high-frequency fluorescent lamp shines on the remote control sensor. In such a case, change the system installation position to prevent malfunction.

Remote control unit operation

POWER key

Press to turn the power of the unit ON / OFF.

Tape deck operation keys

The TAPE A and TAPE B keys allow control of tape decks A and B respectively.

CD player operation keys

Operate the CD player.
 DISC – When a CD player with a multi-disc magazine is used, the DISC key functions as the disc selector. Every press changes the disc number.

Input selector keys

Press one of these keys to select an input source.

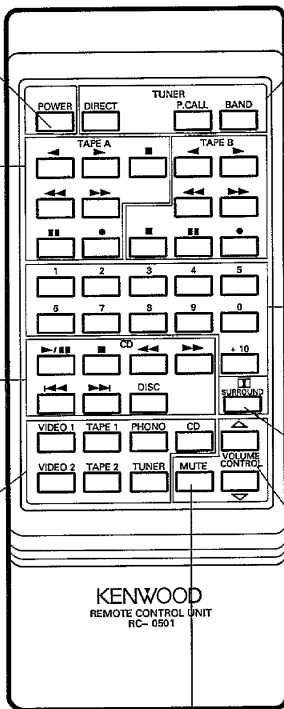

Tuner operation keys

BAND – Press to select the broadcast band (AM or FM).
P.CALL – Press to recall the preset stations in sequence.
DIRECT – Use together with the numeric keys to recall a station directly.

Numeric keys

When the CD input is selected, these keys function as the numeric keys of the CD player. When the TUNER input is selected, these keys function as the numeric keys of the tuner.
 How to enter numbers:

To enter 23 – Press **[2]** twice then **[3]** once.
 To enter 40 – Press **[4]** four times then **[0]** once.

SURROUND key

Press when playing a source bearing the **[DOLBY SURROUND]** mark.

VOLUME CONTROL keys

Press to control the volume. During control operation, the VOLUME CONTROL knob on the main unit rotates and the indicator on it blinks rapidly.

MUTE key

Press to drop the volume temporarily.
 The volume indicator on the VOLUME CONTROL on the main unit flashes during muting.

Note on remote control unit

- In case any of the following models is used, the CD manual search cannot be operated from this remote control unit:
 DP-M97, DP-57, DP-47
- If the CD player is not equipped with the System control jack, it cannot be operated properly from this remote control unit. In such a case, please use the remote control unit provided with the CD player.

Operating instructions

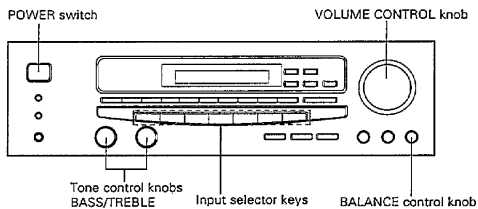

■ Playing a source

1 Turn the POWER ON.

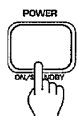

Main unit



Remote control unit

2 Select the input source.

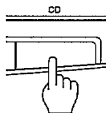

Main unit



Remote control unit

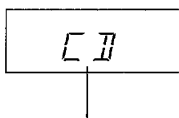

The selected source name appears on the display.

4 Adjust the volume.

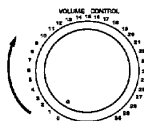

Main unit



Remote control unit

- When the volume is adjusted from the remote control unit, the VOLUME CONTROL knob on the main unit rotates while the point indicator blinks.

5 Adjust the left and right volume balance.

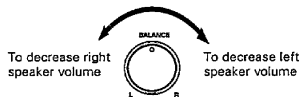

3 Play the TAPE source component.

- The selected source component starts playing automatically if it is connected by a system control cord.

6 Adjust the tone controls.

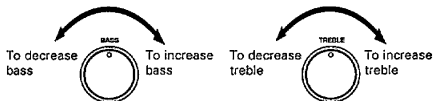

Notes on input selector keys

- When the TAPE 2 key is set to ON, the source selected with the input selector cannot be heard from the speakers. To listen to a source other than cassette deck 2, be sure to set the TAPE 2 key to OFF.
- The source last selected with the input selector is backed up for a few days even when the power cord is unplugged. After this period, the tuner is automatically selected when the power is turned on.

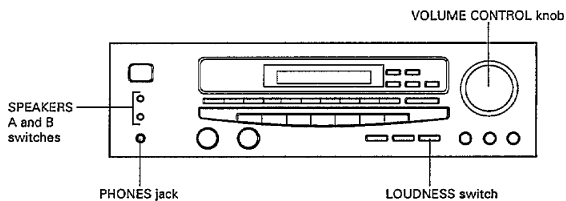

■ To mute the sound temporarily

Press the MUTE key.

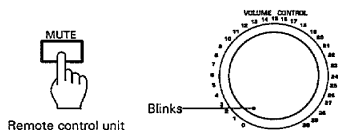

- Pressing the key again resumes the previous volume.

■ Listening through headphones

1 Insert the headphones plug into the PHONES jack.



- Set the SPEAKERS switch so that both speaker systems A and B are OFF.

2 Adjust the volume.

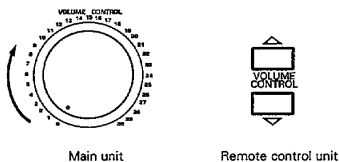

Main unit

Remote control unit

LOUDNESS switch

Human ears are less sensitive to low frequencies when listening at low volume levels. When the VOLUME CONTROL is set to a low position, press the LOUDNESS switch to boost the low frequencies.

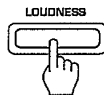

Enhances low frequencies.

- The LOUDNESS switch is less effective when the VOLUME CONTROL is set to the center position or above.

SPEAKERS A and B switches

- A, B OFF:** This position silences all speakers to permit private use of headphones.
- A ON:** Activates the speakers connected to the SPEAKERS A terminals on the rear panel.
- B ON:** Activates the speakers connected to the SPEAKERS B terminals on the rear panel.
- A, B ON:** Activates the speakers connected to the SPEAKERS A and B terminals simultaneously.

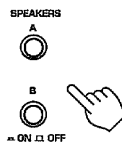

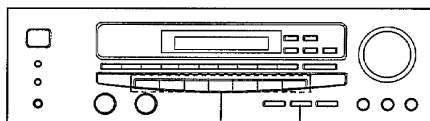

Input selector keys

LINE STRAIGHT switch

■ LINE STRAIGHT mode

This function lets you enjoy high-quality sound without passing through the tone control circuitry.

1 Select the input source.

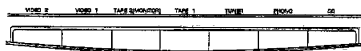

2 Press the LINE STRAIGHT switch.

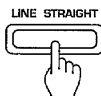

3 Play the input source.

To cancel LINE STRAIGHT mode

Press the key again.

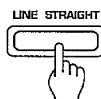

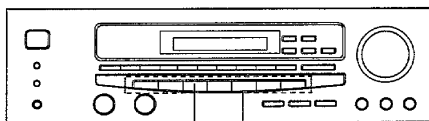

TAPE 2 (MONITOR) key Input selector keys

■ Recording

1 Select the source to be recorded.

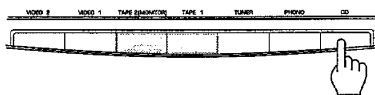

- Select a source other than TAPE 1 or TAPE 2.

2 Set cassette deck 1 or 2 to the record-pause mode.

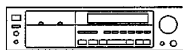

Record-pause mode

- A source can be recorded on cassette decks 1 and 2 simultaneously.

3 Play the source component to be recorded, and start recording it on the cassette deck.

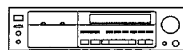

Recording starts.

■ Tape dubbing

Dubbing from TAPE 2 to TAPE 1

1 Press the TAPE 2 key.

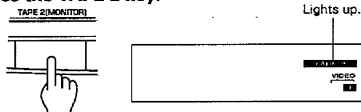

2 Select a source other than TAPE 1.

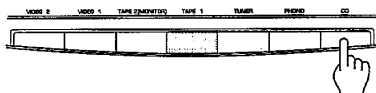

- Select a source other than TAPE 1.

3 Set the cassette deck connected to TAPE 2 to playback mode and start recording on the cassette deck connected to TAPE 1.

- The sound of TAPE 2 can be heard from the speakers.
- Do not select TAPE 1 while dubbing.

Dubbing from TAPE 1 to TAPE 2

1 Press the TAPE 1 key.

2 Set the cassette deck connected to TAPE 1 to playback mode and start recording on the cassette deck connected to TAPE 2.

Note on recording

The input source cannot be changed while a cassette deck connected to this unit via the system control cord is in the record mode. When it is required to change the input source, first stop the cassette deck.

Note on dubbing using double cassette deck

For the tape-to-tape dubbing procedure using a double-cassette deck, please read the instruction manual provided with the cassette deck.

Reception of radio broadcasts

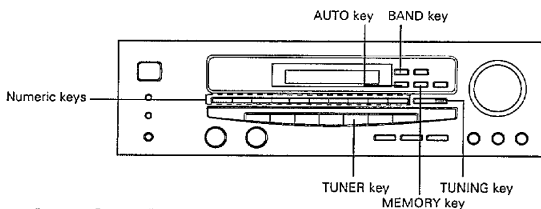

■ Tuning in radio stations and storing them in memory (preset operation)

1 Set the input source to tuner mode.

- Previous reception mode is resumed.
- Pressing the **BAND** key also set the unit to tuner mode.

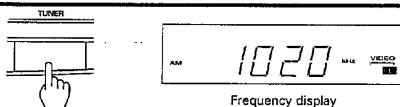

2 Select the broadcast band.



The band is switched as follows every time the **BAND** key is pressed.

FM 1 → FM 2 → AM

3 Select the tuning mode.

- Normally, select the auto mode (with AUTO lit).



AUTO indicator

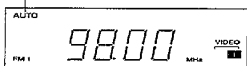

Press the key to select the auto mode (AUTO lit) or manual mode (not lit).

4 Tune to the desired station.

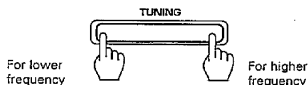

- The TUNED indicator lights up when a station is received.
- Use manual tuning mode when the radio signal is weak and noisy. At this time, stereo FM broadcasts are received in monaural mode.

Auto tuning mode	Manual tuning mode
Press once. (Tuning stops automatically when a station is received.)	Press repeatedly, or press and hold, until the desired station is received.

5 Store the station in preset memory.

① Press the MEMORY key.

- Proceed to step ② before **MEMORY** goes off.

② Press the desired numeric key.



MEMORY lights up for approx. 5 sec.

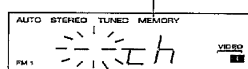

MEMORY goes off.



- If a station has previously been preset under the selected numeric key, the newly preset station replaces the previous station.
- To continue presetting, repeat steps 2 to 5.
- Up to 10 broadcast stations can be preset in each broadcasting band.

Reception of radio broadcasts

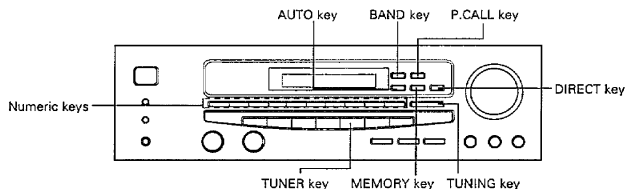

Receiving a preset station

- 1 Set the input source to tuner mode.

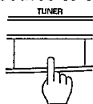

- 2 Select the broadcast band.



- 3 Select the desired station.

Press the numeric key under which the station is preset.

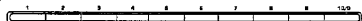

- The frequency of the selected station will be displayed.

Direct tuning of radio stations

If you know the frequency of the desired station, it can be tuned in directly by inputting the frequency using the numeric keys.

- 1 Select the broadcast band.

- One of FM 1, FM 2 or AM.



- 2 Press the DIRECT key.



- 3 Input the frequency of the desired station by pressing the numeric keys.

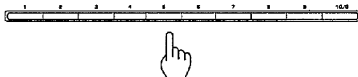

Example of input

Desired station	Order of pressing numeric keys
FM 90 MHz	9, 0, 0 (100 kHz space) 9, 0, 0, 0 (50 kHz space)
FM 102.5 MHz	1, 0, 2, 5 (100 kHz space) 1, 0, 2, 5, 0 (50 kHz space)
AM 810 kHz	8, 1 (10 kHz space) 8, 1, 0 (9 kHz space)
AM 1260 kHz	1, 2, 6 (10 kHz space) 1, 2, 6, 0 (9 kHz space)

- If you make a mistake when pressing the numeric keys, start over from step 2.

Listening to all preset stations in sequence (PRESET CALL)

- 1 Select the broadcast band.

- One of FM 1, FM 2 or AM.



- 2 Press P.CALL key.



FM : Preset stations are received in the following order
(FM1)1→2...9→10→(FM2)1→2...9→10→(FM1)1...

AM : Preset stations are received in the following order
1→2...9→10→1→2...

To stop Preset Scan, press the P.CALL key again.

- The preset station being received when the key is pressed is received continuously.

Last channel memory

When the band is switched or when the input selector is switched from another source to TUNER, the last received station is recalled.

Operation with video components

For connections and operations, also carefully read the instruction manuals supplied with the video components.

When connecting to a KENWOOD LD player having a system control terminal, do not connect anything to the system control terminal.

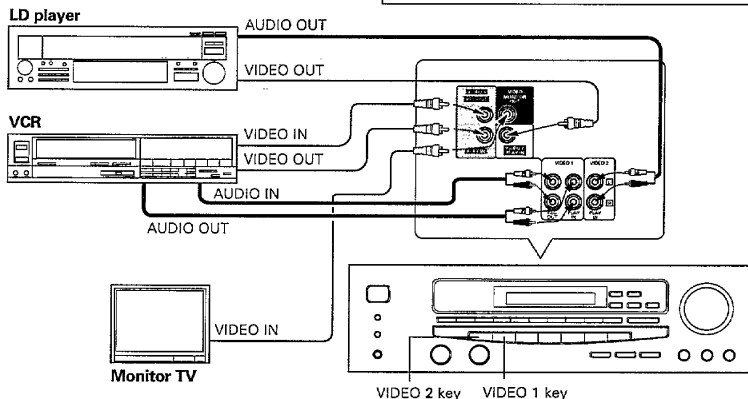

■ Playing a video tape

1 Switch the power of the monitor TV ON.

2 Press the VIDEO 1 key.

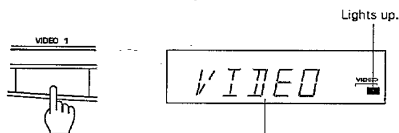

- When an input selector key other than VIDEO 1 is pressed, the audio input of the selected source will be played instead of the audio input from VIDEO 1.

3 Play the VCR.

4 Adjust the volume.

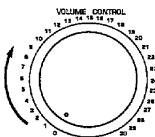

■ Recording a video source

Recording is possible on a VCR connected to VIDEO 1.

1 Connect the video source component to be recorded to the VIDEO 2 jacks.

- A video player deck, video camera, LD player, DBS tuner, etc., can be connected.

2 Press the VIDEO 2 key.

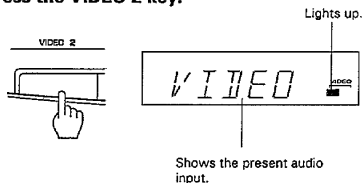

- When an input selector key other than VIDEO 2 is pressed, the audio input of the selected source will be played instead of the audio input from VIDEO 2.

3 Play the video source component.

4 Put the VCR in the record mode.

DOLBY SURROUND

When video software bearing the  mark is played, this mode provides a Dolby Surround effect similar to movie theaters. When using the Dolby Surround mode, be sure to connect rear speakers to this unit, and arrange them as shown below.

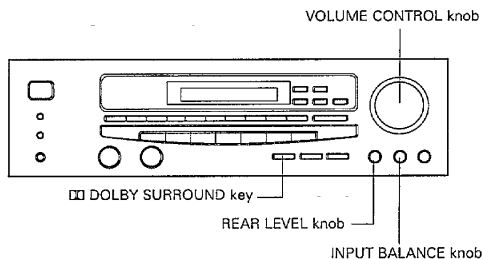
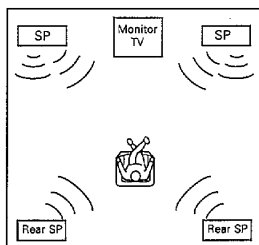

■ Operation of Dolby Surround playback

1 Set the DOLBY SURROUND key to ON.

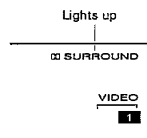

- Press the DOLBY SURROUND key once.

2 Start playback of a Dolby Surround software program.

① Play a Dolby Surround software program.

② Adjust the volume.

③ Adjust the volume of the rear speakers.

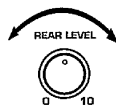
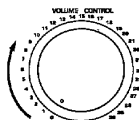

3 Adjust the input balance of Dolby Surround.

① Play a Dolby Surround software program.

② Adjust the left and right input balance.

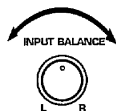

- Select a desired software program and play a place containing much dialogue.

- Adjust the INPUT BALANCE to minimize the dialogue heard from the rear speakers.

To cancel the Dolby surround mode

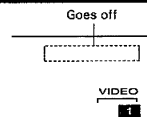

- Press the DOLBY SURROUND key again.

In case of difficulty

What appears to be a malfunction may not always be serious. If your unit should not perform as expected, consult the table below to see if the problem can be corrected before seeking help from your dealer or service representative.

Remote control unit

Symptom	Cause	Remedy
Remote control operation is not possible.	<ul style="list-style-type: none"> ● Batteries are exhausted. ● The audio cords and system control cords are not connected properly. ● The remote control unit is too far away from the main system, controlling angle is too large, or there is an obstacle in between. ● The source component to be operated does not contain a record, tape(s) or CD. ● An attempt is made to play a tape which is being recorded in the cassette deck. 	<ul style="list-style-type: none"> ● Replace with new batteries. ● Connect properly referring to "System connections". ● Operate the remote control unit within the controllable range. ● Place a record, tape(s) or CD in the source component to be played. ● Wait until the recording is completed.

Amplifier section, speakers

Symptom	Cause	Remedy
Sound is not output.	<ul style="list-style-type: none"> ● The speaker cords are disconnected. ● The VOLUME CONTROL is set to minimum position. ● The MUTE key is set to ON and the point indicator is blinking. 	<ul style="list-style-type: none"> ● Connect properly referring to "System connections". ● Adjust the volume to a proper level. ● Press the MUTE key to OFF.
Sound is not output from one of the speakers.	<ul style="list-style-type: none"> ● The speaker cord is disconnected. ● The BALANCE control is set to an extreme position. 	<ul style="list-style-type: none"> ● Connect properly referring to "System connections". ● Adjust the Left / Right balance.
Sound is not output from the Surround rear speaker, or the sound is very small.	<ul style="list-style-type: none"> ● The rear speaker cords are disconnected. ● The Surround play mode has not been engaged. ● The REAR LEVEL is set to the minimum level. 	<ul style="list-style-type: none"> ● Connect properly referring to "System connections". ● Set the Dolby Surround. ● Adjust the REAR LEVEL control.
A hum noise is generated when the PHONO input selector key is pressed.	<ul style="list-style-type: none"> ● The audio cord from the turntable is not inserted securely into the PHONO jacks. ● The turntable is not grounded. 	<ul style="list-style-type: none"> ● Insert the audio cord plugs securely into the PHONO jacks. ● Connect the grounding wire to the GND terminal on the rear panel.

In case of difficulty

Tuner section

Symptom	Cause	Remedy
Radio stations cannot be received.	<ul style="list-style-type: none">● No antenna is connected.● The broadcast band is not set properly.● The frequency of the desired station is not set.	<ul style="list-style-type: none">● Connect an antenna.● Set the broadcast band properly.● Tune to the frequency of the desired station.
A station which was preset cannot be received by pressing the corresponding numeric key.	<ul style="list-style-type: none">● The preset station belongs to a frequency that cannot be received.● The preset memory was cleared because the power cord was unplugged for a long period of time.	<ul style="list-style-type: none">● Preset a station with a receivable frequency.● Preset the station again.
Interference.	<ul style="list-style-type: none">● Noise due to ignition noise of automobiles.● Noise due to an influence from an electric appliance.● Noise due to a nearby TV set.	<ul style="list-style-type: none">● Install the outdoor antenna away from the road.● Turn off the power of the appliance.● Install the system further away from the TV set.

Speaker protection circuitry

If the speaker cords are short-circuited, the speaker protection circuitry is activated and the sound is muted. If this occurs, switch the POWER key to OFF, remove the short-circuit from the speaker cords, and switch the POWER key to ON again. Normal operation will resume.

Manufactured under license from Dolby Laboratories Licensing Corporation. Additionally licensed under one or more of the following patents: U.S. numbers 3,632,888, 3,746,792 and 3,959,590; Canadian numbers 1,004,603 and 1,037,877. "Dolby" and the double-D symbol  are trademarks of Dolby Laboratories Licensing Corporation.

For the U.S.A.

FCC WARNING:

This equipment may generate or use radio frequency energy. Changes or modifications to this equipment may cause harmful interference unless the modifications are expressly approved in the instruction manual. The user could lose the authority to operate this equipment if an unauthorized change or modification is made.

NOTE:

This equipment has been tested and found to comply with the limits for a Class B digital device, pursuant to Part 15 of the FCC Rules. These limits are designed to provide reasonable protection against harmful interference in a residential installation. This equipment may cause harmful interference to radio communications, if it is not installed and used in accordance with the instructions. However, there is no guarantee that interference will not occur in a particular installation. If this equipment does cause harmful interference to radio or television reception, which can be determined by turning the equipment off and on, the user is encouraged to try to correct the interference by one or more of the following measures:

- Reorient or relocate the receiving antenna.
- Increase the separation between the equipment and receiver.
- Connect the equipment into an outlet on a circuit different from that to which the receiver is connected.
- Consult the dealer or an experienced radio/TV technician for help.

Notes:

1. This system is microprocessor-controlled, so malfunction may occur due to external noise or interference noise. In such a case, unplug the power cord, plug it in and turn the power on again.
2. Do not use contact cleaner because it could cause a malfunction. Be specially wary of contact cleaners containing oil, for they may deform the plastic components.

Specifications (For the U.S.A. and Canada)

 **Caution:** Read this page carefully to ensure safe operation.

[AUDIO section]

Rated power output (FTC)
STEREO MODE

100 watts per channel minimum RMS, both channels driven, at 8 Ω from 20 Hz to 20,000 Hz with no more than 0.06 % total harmonic distortion.

SURROUND MODE

Front

100 watts per channel minimum RMS, both channels driven, at 8 Ω 1 kHz with no more than 0.9 % total harmonic distortion

Rear

15 watts per channel minimum RMS, both channels driven, at 8 Ω 1 kHz with no more than 0.9 % total harmonic distortion

Total harmonic distortion

.....0.03 % (1 kHz, 50 W, 8 Ω)

Signal to noise ratio

(IHF'66)

PHONO (MM) 73 dB

LINE (CD, TAPE, VIDEO) 100 dB

Input sensitivity / impedance

PHONO (MM) 2.5 mV / 47 k Ω

LINE (CD, TAPE, VIDEO) 200 mV / 47 k Ω

Tone control

BASS ± 10 dB (at 100 Hz)

TREBLE ± 10 dB (at 10 kHz)

Loudness control (volume at -30 dB level)

..... + 9 dB (100 Hz)

[VIDEO section]

Television format

Input level / impedance

VIDEO (Composite) 1Vp-p / 75 Ω

Input (UNBALANCE)

Output level / impedance

VIDEO (Composite) 1Vp-p / 75 Ω

Output (UNBALANCE)

[FM tuner section]

Tuning frequency range 87.5 MHz ~ 108 MHz

Usable sensitivity (MONO at 75 Ω) .. 0.95 μ V / 10.8 dBf

50 dB quieting sensitivity (at 75 Ω)

MONO 2.0 μ V / 17.2 dBf

STEREO 39.2 μ V / 25.0 dBf

Total harmonic distortion (at 1 kHz)

MONO 0.4 % (65 dBf input)

STEREO 0.5 % (65 dBf input)

Signal to noise ratio (at 1 kHz)

MONO 78 dB (65 dBf input)

STEREO 73 dB (65 dBf input)

Stereo separation

1 kHz 45 dB

Selectivity (± 400 kHz) 50 dB

Frequency response (30 Hz ~ 15 kHz)

..... + 0.5 dB, -2.0 dB

[AM tuner section]

Tuning frequency range 530 kHz ~ 1,700 kHz

Usable sensitivity 16 μ V / (400 μ V/m)

Signal to noise ratio (at 30% mod. 1mV input) 50 dB

Total harmonic distortion 0.5 %

Selectivity 23 dB

[General]

Power consumption 3 A

AC outlet

SWITCHED 2: (Total 150 W max.)

Dimensions W : 440 mm (17-5/16")

H : 129 mm (5-1/16")

D : 379 mm (14-15/16")

Weight (Net) 10.8 kg (23.8 lb)

Note:

KENWOOD follows a policy of continuous advancements in development. For this reason specifications may be changed without notice.

Specifications (For other countries)

 **Caution:** Read this page carefully to ensure safe operation.

[AUDIO section]

Rated power output

STEREO MODE

(IHF'66) From 20 Hz to 20,000 Hz, 0.06 % T.H.D.

at 8 Ω 105 W+105 W

SURROUND MODE

(IHF'66) 1 kHz, 0.9 % T.H.D. at 8 Ω

FRONT 105 W+105 W

REAR 15 W+15 W

Total harmonic distortion

..... 0.03 % (1 kHz, 50 W, 8 Ω)

Signal to noise ratio

(IHF'66)

PHONO (MM) 73 dB

LINE (CD, TAPE, VIDEO) 100 dB

Input sensitivity / impedance

PHONO (MM) 2.5 mV / 47 k Ω

LINE (CD, TAPE, VIDEO) 200 mV / 47 k Ω

Tone control

BASS \pm 10 dB (at 100 Hz)

TREBLE \pm 10 dB (at 10 kHz)

Loudness control (volume at -30 dB level)

..... + 9 dB (100 Hz)

[VIDEO section]

Television format

Input level / impedance

VIDEO (Composite) 1Vp-p / 75 Ω

Input (UNBALANCE)

Output level / impedance

VIDEO (Composite) 1Vp-p / 75 Ω

Output (UNBALANCE)

[FM tuner section]

Tuning frequency range 87.5 MHz ~ 108 MHz

Usable sensitivity (MONO at 75 Ω) .. 0.95 μ V / 10.8 dB

50 dB quieting sensitivity (at 75 Ω)

MONO 2.0 μ V / 17.2 dB

STEREO 25.0 μ V / 39.2 dB

Total harmonic distortion (at 1 kHz)

MONO 0.4 % (65 dBf input)

STEREO 0.5 % (65 dBf input)

Signal to noise ratio (at 1 kHz)

MONO 78 dB (65 dBf input)

STEREO 73 dB (65 dBf input)

Stereo separation

1 kHz 45 dB

Selectivity (\pm 400 kHz) 50 dB

Frequency response (30 Hz ~ 15 kHz)

..... + 0.5 dB, - 2.0 dB

[AM tuner section]

Tuning frequency range

9 kHz step 531 kHz ~ 1,602 kHz

10 kHz step 530 kHz ~ 1,610 kHz

Usable sensitivity 16 μ V / (400 μ V/m)

Signal to noise ratio (at 30% mod. 1mV input) 50 dB

Total harmonic distortion 0.5 %

Selectivity 23 dB

[General]

Power consumption 230 W

AC outlet

SWITCHED 2: (Total 150W max.)

Dimensions W: 440 mm

H: 129 mm

D: 379 mm

Weight (Net) 10.8 kg

Note:

KENWOOD follows a policy of continuous advancements in development. For this reason specifications may be changed without notice.

Free Manuals Download Website

<http://myh66.com>

<http://usermanuals.us>

<http://www.somanuals.com>

<http://www.4manuals.cc>

<http://www.manual-lib.com>

<http://www.404manual.com>

<http://www.luxmanual.com>

<http://aubethermostatmanual.com>

Golf course search by state

<http://golfingnear.com>

Email search by domain

<http://emailbydomain.com>

Auto manuals search

<http://auto.somanuals.com>

TV manuals search

<http://tv.somanuals.com>