

# KENWOOD

## AUDIO VIDEO STEREO RECEIVER KR-V7060 KR-V6060

### INSTRUCTION MANUAL

KENWOOD CORPORATION

**This manual contains instructions for two models.**

#### *For your records*

Record the serial number, found on the back of the unit, in the spaces designated on the warranty card, and in the space provided below. Refer to the model and serial numbers whenever you call upon your dealer for information or service on this product.

Model \_\_\_\_\_ Serial Number \_\_\_\_\_

#### *Unpacking*

Unpack the unit carefully and make sure that all accessories are put aside so they will not be lost. Examine the unit for any possibility of shipping damage. If your unit is damaged or fails to operate, notify your dealer immediately. If your unit was shipped to you directly, notify the shipping company without delay. Only the consignee (the person or company receiving the unit) can file a claim against the carrier for shipping damage.

We recommend that you retain the original carton and packing materials for use should you transport or ship the unit in the future.

#### *Accessories*

FM indoor antenna .....(1)



AM loop antenna .....(1)

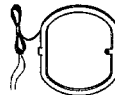

Loop antenna stand .....(1)

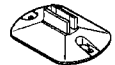

Remote control unit .....(1)

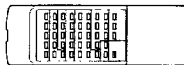

Batteries (R6/AA) .....(2)



AC plug adaptor .....(1)



Except for U.S.A., Mexico,  
Canada, and Australia

# Before applying power

⚠ Caution: Read this page carefully to ensure safe operation.

## 2 Before applying power

Units are designed for operation as follows.

U.S.A., Mexico and Canada ..... 120 V only  
Australia ..... 240 V only

Other countries ..... 110-120 / 220-240 V switch

### AC voltage selection

This unit operates on 110 - 120 volts or 220 - 240 volts AC. The AC voltage selector switch on the rear panel is set to the voltage that prevails in the area to which the unit is shipped. Before connecting the power cord to your AC outlet, make sure that the setting position of this switch matches your line voltage. If not, it must be set to your voltage in accordance with the following direction.

### AC voltage Selector switch

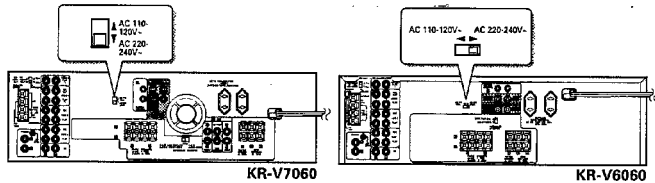





### Note:

Our warranty does not cover damage caused by excessive line voltage due to improper setting of the AC voltage selector switch.

Move switch lever to match your line voltage with a small screwdriver or other pointed tool.

## Safety precautions

**WARNING :** TO PREVENT FIRE OR ELECTRIC SHOCK, DO NOT EXPOSE THIS APPLIANCE TO RAIN OR MOISTURE.

 	<b>CAUTION</b> RISK OF ELECTRIC SHOCK DO NOT OPEN	<b>CAUTION:</b> TO REDUCE THE RISK OF ELECTRIC SHOCK, DO NOT REMOVE COVER (OR BACK). NO USER-SERVICEABLE PARTS INSIDE, REFER SERVICING TO QUALIFIED SERVICE PERSONNEL.
		THE LIGHTNING FLASH WITH ARROWHEAD SYMBOL, WITHIN AN EQUILATERAL TRIANGLE, IS INTENDED TO ALERT THE USER TO THE PRESENCE OF UNINSULATED "DANGEROUS VOLTAGE" WITHIN THE PRODUCT'S ENCLOSURE THAT MAY BE OF SUFFICIENT MAGNITUDE TO CONSTITUTE A RISK OF ELECTRIC SHOCK TO PERSONS.
		THE EXCLAMATION POINT WITHIN AN EQUILATERAL TRIANGLE IS INTENDED TO ALERT THE USER TO THE PRESENCE OF IMPORTANT OPERATING AND MAINTENANCE (SERVICING) INSTRUCTIONS IN THE LITERATURE ACCOMPANYING THE APPLIANCE.

**For the U.S.A.**

### FCC WARNING

This equipment may generate or use radio frequency energy. Changes or modifications to this equipment may cause harmful interference unless the modifications are expressly approved in the instruction manual. The user could lose the authority to operate this equipment if an unauthorized change or modification is made.

### NOTE:

This equipment has been tested and found to comply with the limits for a Class B digital device, pursuant to Part 15 of the FCC Rules. These limits are designed to provide reasonable protection against harmful interference in a residential installation. This equipment may cause harmful interference to radio communications, if it is not installed and used in accordance with the instructions. However, there is no guarantee that interference will not occur in a particular installation. If this equipment does cause harmful interference to radio or television reception, which can be determined by turning the equipment off and on, the user is encouraged to try to correct the interference by one or more of the following measures:

- Reorient or relocate the receiving antenna.
- Increase the separation between the equipment and receiver.
- Connect the equipment into an outlet on a circuit different from that to which the receiver is connected.
- Consult the dealer or an experienced radio / TV technician for help.

**For the U.S.A.**

### Note to CATV system installer:

This reminder is provided to call the CATV system installer's attention to Article 820-40 of the NEC that provides guidelines for proper grounding and, in particular, specifies that the cable ground shall be connected to the grounding system of the building, as close to the point of cable entry as practical.

# Special features

## **DOLBY PRO LOGIC & DOLBY 3 STEREO**

The surround system reproduces video software programmes carrying the **DOLBY SURROUND** mark with similar acoustic effects to movie theaters.

The **DOLBY PRO LOGIC** mode controls the audio signals of the Front Left/Right, Center and Rear surround channels using the built-in directivity enhancer circuit to reproduce the feeling of sound motions realistically.

The **DOLBY 3 STEREO** mode can reproduce the motions of sound even when only the front and center speakers are used, by providing proper acoustic position using the directivity enhancer circuit.

## **THEATER LOGIC**

This mode adds presence sound components to the signals output from the **DOLBY PRO LOGIC** (Left, Center, Right and Surround channels), allowing movie software programmes to be played with a similar feeling of presence to movie theater in a listening room at home.

# Contents

**Caution : Read the pages marked  $\Delta$  carefully to ensure safe operation.**

<b>Before applying power</b>	
$\Delta$ Before applying power .....	2
$\Delta$ Safety precautions .....	2
	3
<b>Special features</b>	
<b>System connection</b>	4
<b>Controls and indicators</b>	10
<b>Operation of remote control unit</b>	12
<b>Playing music</b>	13
<b>Sound adjustment functions</b>	14
<b>Recording</b>	16
Recording .....	16
Copying tape (Tape dubbing) .....	16
	17
<b>Broadcast reception</b>	17
Receiving broadcast station .....	17
Receiving radio station by specifying its frequency .....	18
Storing radio stations in memory (Station preset) .....	19
	20
<b>Operation of video components</b>	20
Playback of videotape .....	20
Recording of video source .....	20
	21
<b>Presence play</b>	21
DOLBY PRO LOGIC surround arrangement .....	22
DOLBY PRO LOGIC surround playback .....	23
DOLBY 3 STEREO adjustment and playback .....	24
Enjoying music with feeling of presence (THEATER LOGIC mode) .....	25
	26
	28
<b>In case of difficulty</b>	
<b>Specifications</b>	

# System connection (KR-V7060)

Make connection as shown below.

When connecting the related system components, refer also to the instruction manuals of the related components. Do not plug in the power lead until all connections are completed.

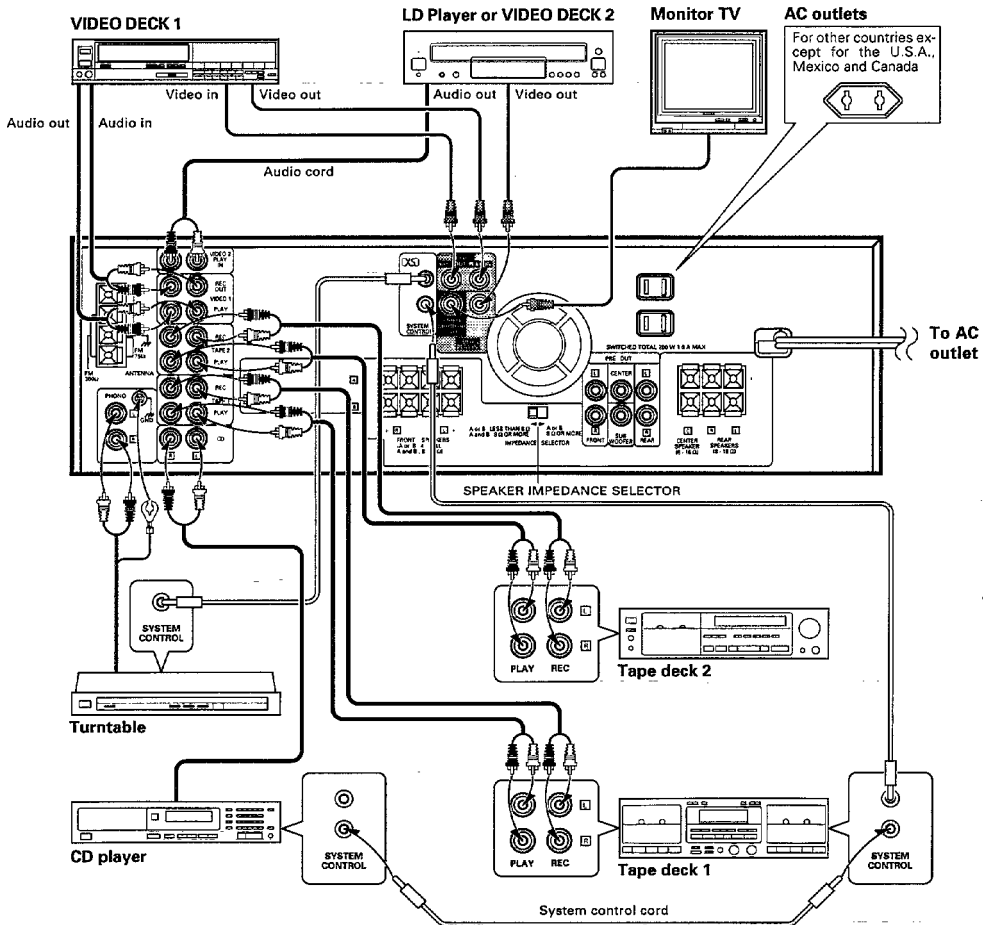

- This unit has a cooling fan on the rear panel. Do not place anything near the cooling fan.

## Automatic operation

When this unit is connected to KENWOOD system components such as a cassette deck and CD player through system control cords and the input source is selected with the INPUT SELECTOR, the selected component starts to play automatically. Inversely, playing a component automatically selects that source as the input to this unit. The automatic operation also occurs when the provided remote control is used.

### Notes



1. Connect all cords firmly. If connections are loose, there could be loss of sound or noise produced.
2. When plugging and unplugging connection cords, be sure to first remove the power cord from the AC outlet. Plugging / unplugging connection cords without removal of the power cord can cause malfunctions or damage to the unit.
3. Do not connect up a power source which is larger than that indicated on the socket at the rear of the unit.
4. Insert the system control plugs completely into the jacks.
5. If the system control cords or audio cords are not connected properly, the remote control or automatic operation between system components will not work properly.

# Connection of speakers

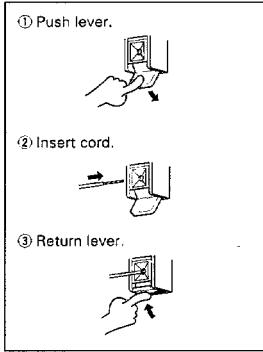

- Never short-circuit the + and - speaker cords.
- If the left and right speakers are connected inversely or if the speaker cords are connected with reversed polarity, the sound becomes unnatural with ambiguous acoustic image positioning. Be sure to connect the speakers and speaker cords correctly.
- Proper sound will not be produced unless two rear speakers are connected.

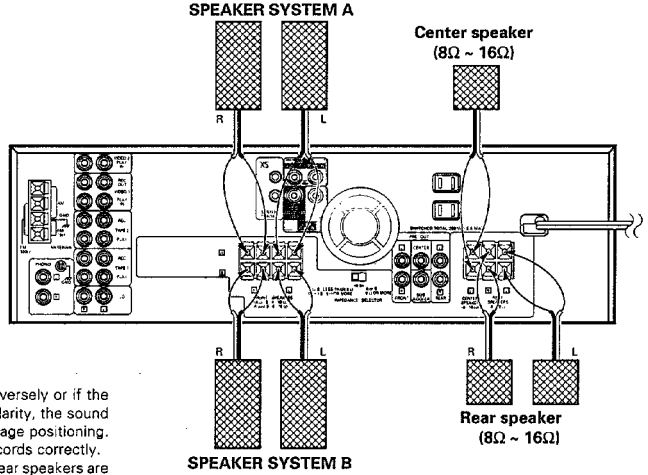

## Speaker IMPEDANCE SELECTOR

**CAUTION :** During operation of the speaker IMPEDANCE SELECTOR, set the POWER switch to OFF.

Set the IMPEDANCE SELECTOR switch on the rear panel according to the impedance of the front speakers used. The center and rear speakers should have impedances from 8 to 16 ohms regardless of the position of this switch.

Front speaker impedance	Selector position
A or B speakers 4Ω ~ 6Ω A and B speakers 8Ω ~ 16Ω	<p>A or B : LESS THAN 8 Ω A and B : 8 Ω OR MORE</p> <p>IMPEDANCE SELECTOR</p>
A or B speakers 8Ω ~ 16Ω	<p>A or B : LESS THAN 8 Ω A and B : 8 Ω OR MORE</p> <p>IMPEDANCE SELECTOR</p>

- It is not possible to use both A and B speaker systems for surround play.
- It is not possible to use both A and B speaker systems if speakers have impedances from 4 ohms to 6 ohms.

## PRE OUT jacks

Use these jacks when you want to play music with larger volume level than the level obtained with normal connection, or when you want to enjoy music with different tones.

Speakers cannot output sufficient sound level even when they are connected directly to the PRE OUT jacks. These jacks should be connected to speakers containing an amplifier or to amplifiers to which speakers are connected.

Be sure to press the SPEAKERS switch (A and/or B) to ON.

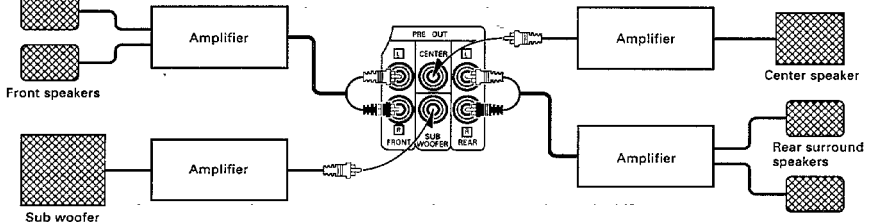

- Connect a sub woofer if you want to enhance the bass sound.

# System connection (KR-V6060)

6

Make connection as shown below.

When connecting the related system components, refer also to the instruction manuals of the related components.  
Do not plug in the power lead until all connections are completed.

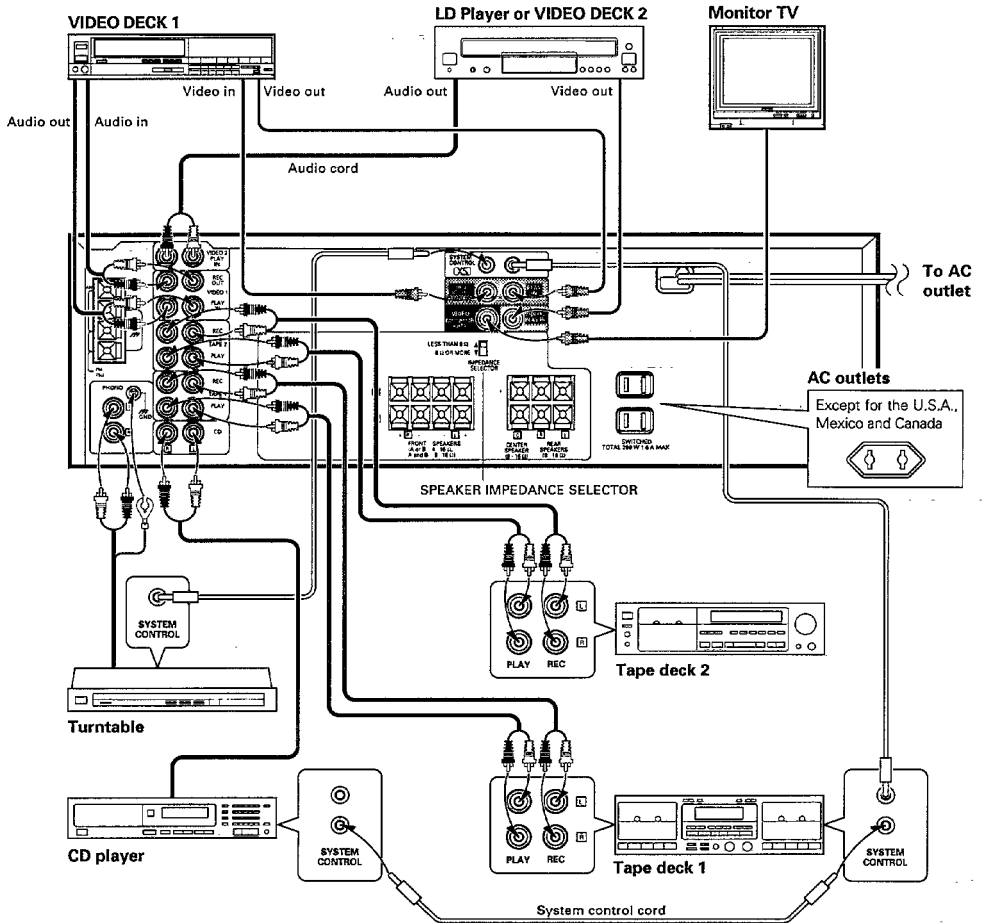

## Automatic operation

When this unit is connected to KENWOOD system components such as a cassette deck and CD player through system control cords and the input source is selected with the INPUT SELECTOR, the selected component starts to play automatically. Inversely, playing a component automatically selects that source as the input to this unit. The automatic operation also occurs when the provided remote control is used.

### Notes



1. Connect all cords firmly. If connections are loose, there could be loss of sound or noise produced.
2. When plugging and unplugging connection cords, be sure to first remove the power cord from the AC outlet. Plugging / unplugging connection cords without removal of the power cord can cause malfunctions or damage to the unit.
3. Do not connect up a power source which is larger than that indicated on the socket at the rear of the unit.
4. Insert the system control plugs completely into the jacks.
5. If the system control cords or audio cords are not connected properly, the remote control or automatic operation between system components will not work properly.

# Connection of speakers

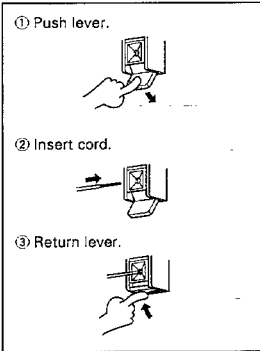

- Never short-circuit the + and - speaker cords.
- If the left and right speakers are connected inversely or if the speaker cords are connected with reversed polarity, the sound becomes unnatural with ambiguous acoustic image positioning. Be sure to connect the speakers and speaker cords correctly.
- Proper sound will not be produced unless two rear speakers are connected.

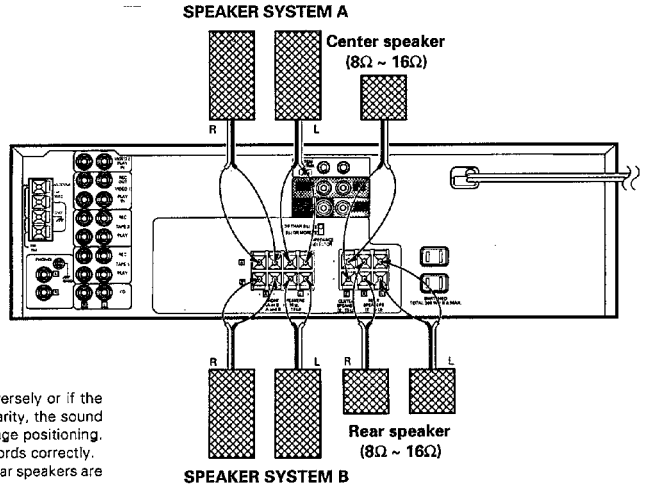

## Speaker IMPEDANCE SELECTOR

Set the IMPEDANCE SELECTOR switch on the rear panel according to the impedance of the front speakers used. The center and rear speakers should have impedances from 8 to 16 ohms regardless of the position of this switch.

For surround play		For non-surround play	
Front speaker impedance	Selector position	Front speaker impedance	Selector position
A or B speakers 4Ω ~ 6Ω	LESS THAN 8Ω 8Ω OR MORE IMPEDANCE SELECTOR	A or B speakers 4Ω ~ 6Ω	LESS THAN 8Ω 8Ω OR MORE IMPEDANCE SELECTOR
A or B speakers 8Ω ~ 16Ω	LESS THAN 8Ω 8Ω OR MORE IMPEDANCE SELECTOR	A or B speakers 8Ω ~ 16Ω A and B speakers 8Ω ~ 16Ω	LESS THAN 8Ω 8Ω OR MORE IMPEDANCE SELECTOR

- It is not possible to use both A and B speaker systems for surround play.
- It is not possible to use both A and B speaker systems if speakers have impedances from 4 ohms to 6 ohms.

**Connection method to each antenna terminal**

① Push lever.



② Insert cord.



③ Return lever.



## Connection of AM antenna

**AM loop antenna connection**

The supplied antenna is for indoor use. Place it as far as possible from the main system, TV set, speaker cords and power cord, and set it in a direction which provides the best reception.

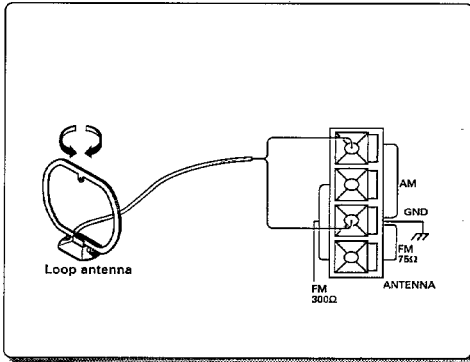
**AM outdoor antenna connection**

If the reception is poor when the AM loop antenna is used, distribute a vinyl-coated wire of more than 6 meters outdoors, without disconnecting the loop antenna.

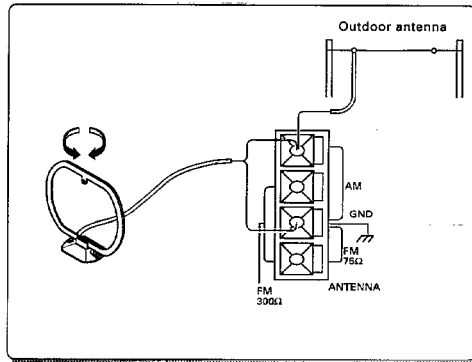

## Connection of FM antenna

**FM indoor antenna connection**

The supplied antenna is for indoor use. For stable reception, remove the indoor antenna after installing an outdoor antenna as soon as possible.

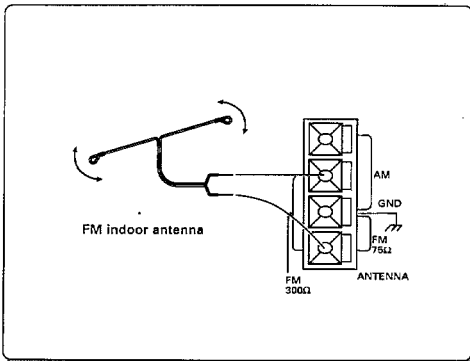
**FM outdoor antenna connection**

Lead the 75Ω coaxial cable connected to the FM outdoor antenna into the room and connect it to the FM 75Ω terminal.

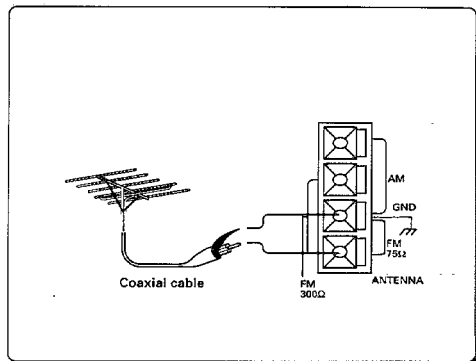



**FM DE-EMPHASIS / CHANNEL SPACE switch  
(Except for U.S.A., Mexico and Canada)**

The FM DE-EMPHASIS / CHANNEL SPACE switch on the rear panel is set to the correct setting that prevails in the area to which the unit is shipped. However, if the FM DE-EMPHASIS / CHANNEL SPACE setting is not matched to the area where the unit is to be used, for instance, when you moved from area 1 to area 2 or vice versa, desired reception of AM / FM broadcasts is not expected. In this case, change the FM DE-EMPHASIS / CHANNEL SPACE setting in accordance with the area corresponding to the table. The FM DE-EMPHASIS is switched over at the same time.

**KR-V7060**

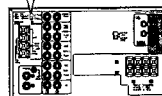
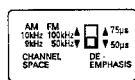

**KR-V6060**

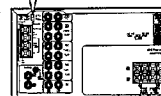
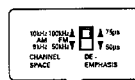

Area	CHANNEL SPACE freq.	FM DE-EMPHASIS
1. U.S.A., Canada, Hawaii, South American countries	FM: 100kHz AM: 10kHz	75 $\mu$ s
2. Other countries	FM: 50kHz AM: 9kHz	50 $\mu$ s

- When changing the setting of the FM DE-EMPHASIS / CHANNEL SPACE switch, first disconnect the power cord of the amplifier, then reset the channel space switch, connect the power cord again, and turn the power on.

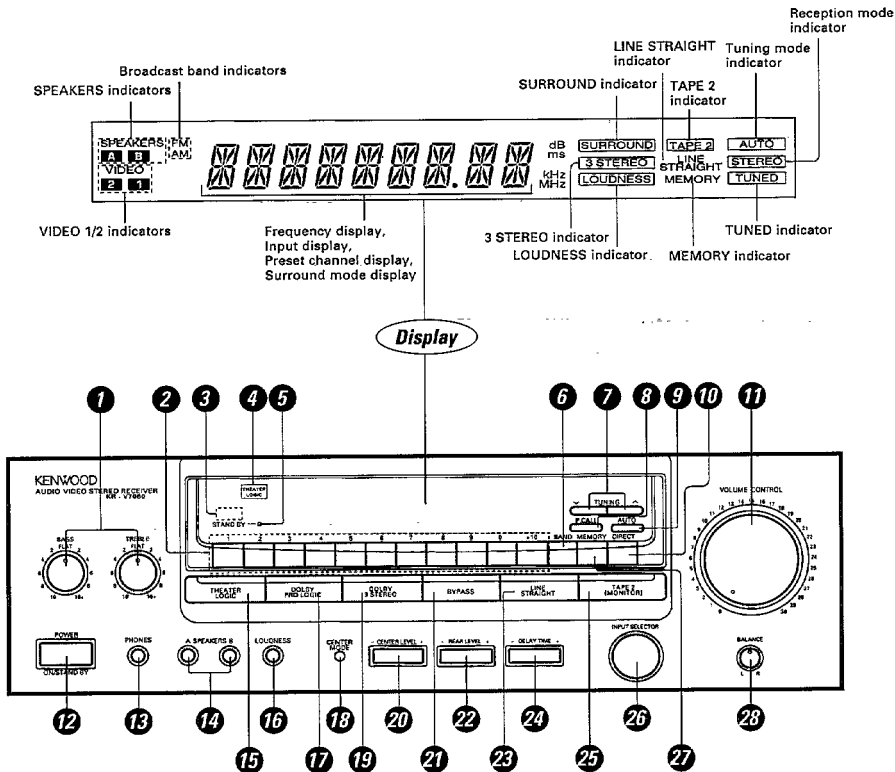

- ① **TONE control knobs**
- ② **Numeric keys**
- ③ **Remote control sensor**
- ④ **THEATER LOGIC indicator**
- ⑤ **STAND BY indicator**
- ⑥ **BAND key**  
Press to switch the broadcast band.
- ⑦ **TUNING keys**
- ⑧ **P.CALL key**
- ⑨ **AUTO key**
- ⑩ **DIRECT key**  
Press for direct station tuning based on numerical input.
- ⑪ **VOLUME CONTROL knob**
- ⑫ **POWER key**

- ⑬ **PHONES jack**  
Used for headphone listening.
- ⑭ **SPEAKERS A/B keys**  
Press to select the A and/or B speaker systems.
- ⑮ **THEATER LOGIC key**
- ⑯ **LOUDNESS key**  
Press to enhance low frequencies.
- ⑰ **DOLBY PRO LOGIC key**
- ⑱ **DOLBY 3 STEREO key**
- ⑲ **CENTER LEVEL key**
- ⑳ **REAR LEVEL key**
- ㉑ **DELAY TIME key**
- ㉒ **BYPASS key**  
Press to cancel the surround modes.

- ㉓ **LINE STRAIGHT key**  
Press to reproduce the source with higher sound quality.
- ㉔ **DELAY TIME key**  
Press to adjust delay time.
- ㉕ **TAPE 2 (MONITOR) key**
- ㉖ **INPUT SELECTOR knob**  
Turn to select the input sources.
- ㉗ **MEMORY key**  
Press to preset a station in the memo
- ㉘ **BALANCE control knob**  
Turn to adjust the volume balance between left and right.

### STAND BY mode of POWER switch

When the power cord of this system is plugged into an AC outlet, the STAND BY indicator lights up regardless of the ON/OFF setting of the POWER switch. This indicates that a small amount of current is being supplied to the unit to back up the memory contents. This mode is referred to as Stand By mode. While the STAND BY indicator is lit, the power of the system can be switched ON/OFF from the remote control unit.

# Remote control unit

The remote control unit provided with the receiver can also control KENWOOD cassette decks and CD player connected to the receiver through system control cords. For details of the controllable functions, refer to the instruction manuals of these components.

## Cassette deck operation keys

These keys are used to operate TAPE A and TAPE B decks.

### REC/ARM:

When recording on TAPE B, puts the deck in record-pause mode after leaving a non-recorded blank of 4 seconds.

## CD player operation keys

**DISC:** This key is used as the disc selector of a multi-CD player. Each press selects a different disc.

## INPUT key

Selects the input sources.

### TAPE 2 (MONITOR) key

Press to monitor the source being recorded.

## MUTE key

Mutes the sound temporarily.

### VOLUME CONTROL keys

Adjust the listening volume. The VOLUME CONTROL knob of the main unit turns when these keys are operated. In this case, the indicator on the knob blinks at high speed.

## TUNER operation keys

### BAND:

Selects the broadcast band.

### P.CALL:

Recalls preset stations.

### DIRECT:

Used in combination with the numeric keys for direct tuning of stations.

## Numeric keys

When the CD input is selected, function as the numeric keys of the CD player. When the TUNER input is selected, function as the numeric keys of the tuner.

## SURROUND keys

### SURROUND MODE:

Switches the surround modes.

### TEST TONE:

Switches the test tone ON and OFF.

**CENTER + MULTI LEVEL CONTROL:** This combination adjusts the center level.

**REAR + MULTI LEVEL CONTROL:** Adjusts the rear level.

**DELAY + MULTI LEVEL CONTROL:** Adjusts the delay time.

## POWER key

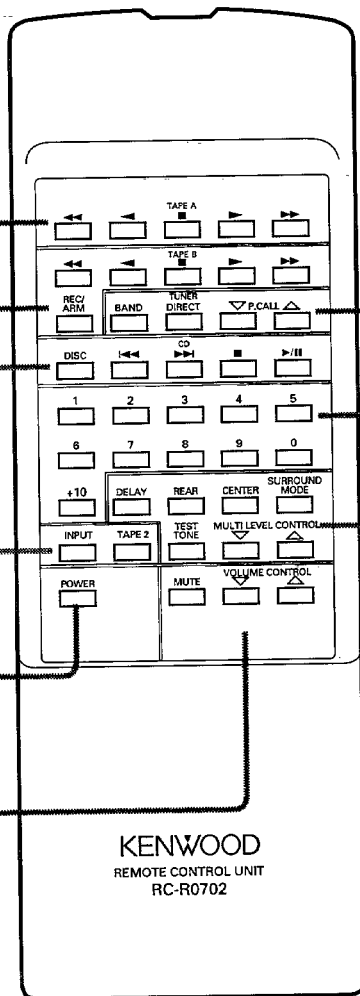

Model: RC-R0702  
Infrared ray system

# Operation of remote control unit

12

## Loading batteries

**1** Remove the cover.

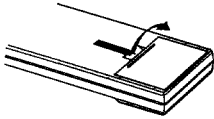

**2** Insert batteries.

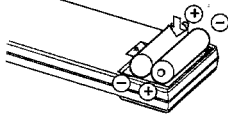

**3** Close the cover.

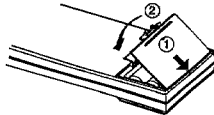

- Insert two AA-size (R6 / SUM-3) batteries as indicated by the polarity marking.

## Operation procedure

Plug the power cord of the system into an AC wall outlet, and press the **POWER** key on the remote control unit to turn the power on. When the power is turned on, press the key of the source component to be operated.

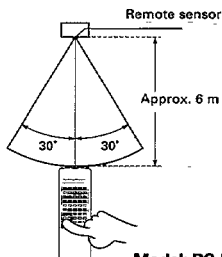

**Model: RC-R0702**  
**Infrared ray system**

- When two operation keys on the remote control unit are pressed successively, press each key securely reserving an interval of more than 1 second for each press.
- Components connected via the system control cords, such as the CD player, can also be remote-controlled. In this case, please read the instruction manual supplied with your component.

### Notes



1. The supplied batteries are intended for use in operation checks. Therefore, their lives may be shorter than ordinary batteries.
2. When the remote-controllable distance gets shorter than before, replace both batteries with new ones.
3. Malfunction may occur if direct sunlight or the light of a high-frequency lighting fluorescent lamp enters the remote control light sensor. In such a case, change the system installation position to prevent the malfunction.

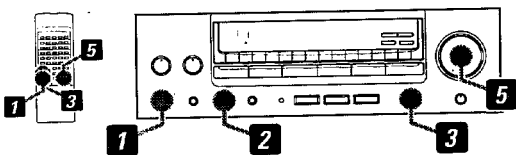

## 1 Turn the power ON.



## 2 Select the SPEAKERS switch setting.



The indicators of the speaker systems to be used should light up.



## 3 Select the input source.



## 4 Play the selected source.

## 5 Adjust the volume.



To increase volume

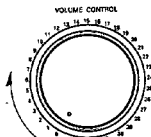

### A, B OFF

Sound is not output from the speakers. Use this setting for listening through headphones, etc.

### A ON

Sound is output from the speakers connected to the SPEAKERS A terminals on the rear panel.

### B ON

Sound is output from the speakers connected to the SPEAKERS B terminals on the rear panel.

### A, B ON

Sound is output from the speakers connected to the SPEAKERS A and B terminals on the rear panel.

- When a surround mode is activated while both SPEAKERS A and B are ON, the SPEAKERS B system is automatically switched off. If the SPEAKERS B key is pressed at this time, the SPEAKERS B system is switched ON and the SPEAKERS A system is switched OFF automatically.

- If the cassette deck(s), CD player and/or turntable is connected through system control cords, the component of the selected input source starts to play automatically.

The input sources are switched in the following order:

- ① TUNER (frequency display)
- ② TAPE 1
- ③ VIDEO 1
- ④ VIDEO 2
- ⑤ CD
- ⑥ PHONO

The selected source is displayed.

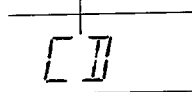

- The selected input source is held in memory for about 3 days even after the power cord is unplugged from the mains outlet.

- The sound of input source cannot be listened to while TAPE 2 is ON.
- When the volume is adjusted from the remote control unit, the indicator on the VOLUME CONTROL knob blinks.

## Adjusting the tone

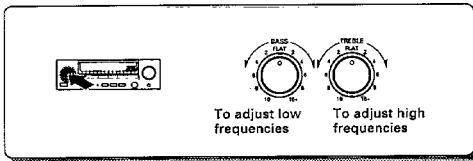

## Adjusting the left/right sound balance

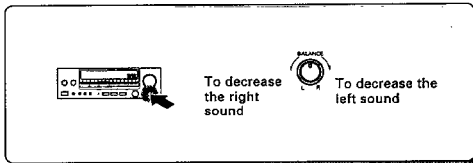

## Using the LOUDNESS key

When listening at a low volume, the loudness function allows to compensate the low frequencies which human ears have difficulty in hearing at a low volume.

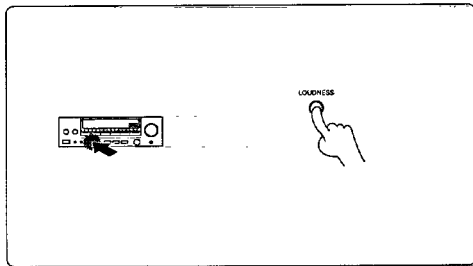

## To mute sound temporarily

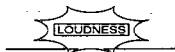
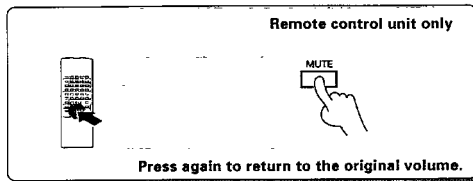

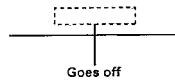

**To cancel the loudness function**  
Press the key again.





● The indicator on the VOLUME CONTROL of the main unit blinks.

### To listen through headphones

① Set both of the **SPEAKERS** switches to **OFF**.

② Plug headphones.

③ Adjust the volume.

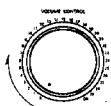

To increase volume

Main unit

### Line-straight playback

This feature allows to enjoy music sources such as CD with an even higher sound quality.

① Select the source to be played.

② Press the **LINE STRAIGHT** key.

③ Play the source.

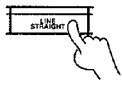

- The tone control functions are defeated during line-straight play.
- The line-straight play is cancelled when a key associated with surround play is pressed.

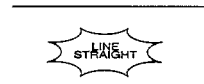
### To cancel

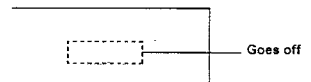

Press the key again.



## Recording

### To record a music source

① Select the source to be recorded.



Select an input source other than TAPE 1.

② Put the cassette deck in record-pause mode.



③ Play the source and start recording.

### Copying tape (Tape dubbing TAPE 2 → TAPE 1)

① Press the TAPE 2 key.

② Select a source other than TAPE 1.

③ Play cassette deck 2 and start recording on cassette deck 1.



- For copying a tape using a double cassette deck, read the instruction manual of the double cassette deck.

### Copying tape (Tape dubbing TAPE 1 → TAPE 2)

Play the cassette deck connected to the TAPE 1 jacks and start recording of the cassette deck connected to the TAPE 2 jacks.

### Synchro recording

By connecting this unit to a CD player or turntable manufactured by KENWOOD through a system control cord, the CD or analog disc sound can be recorded with a simple operation on the cassette deck(s).

Select the music source to be recorded with the INPUT SELECTOR and put the cassette deck in record-pause mode. With this condition, press the play key of the CD player or turntable to start recording at the same time as the source component starts to play.



# Broadcast reception

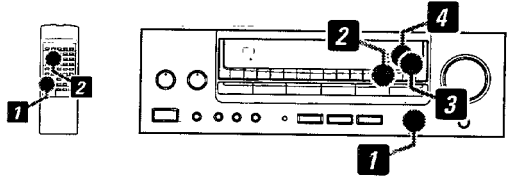

## Receiving broadcast station

### 1 Select the TUNER input.



The input sources are switched in the following order:

- ① TUNER (frequency display)
- ② TAPE 1
- ③ VIDEO 1
- ④ VIDEO 2
- ⑤ CD
- ⑥ PHONO

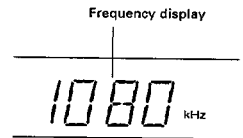

- The last frequency tuned before is displayed.

### 2 Select the broadcast band.



Each press switches the band as follows:

- ① FM
- ② AM

AM or FM indicator



### 3 Select the tuning method.



Each press switches the tuning method as follows:

- ① AUTO lit (auto tuning)
- ② AUTO not lit (manual tuning)

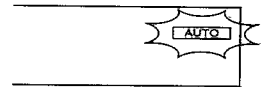

- Usually, set the switch to AUTO (auto tuning).

Select manual tuning when noise interferes due to weak radio wave.  
(The stereo broadcasting is received in monaural during manual tuning.)

### 4 Select a station.

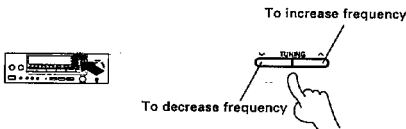

Frequency display

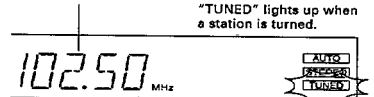

Auto tuning: The next station found is tuned automatically.  
Manual tuning: Press repeatedly or hold until a station is tuned.

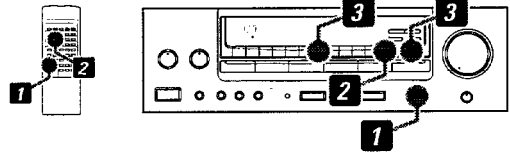

## Receiving radio station by specifying its frequency

### 1 Select the TUNER input.



The input sources are switched in the following order:

- ① TUNER (frequency display)
- ② TAPE 1
- ③ VIDEO 1
- ④ VIDEO 2
- ⑤ CD
- ⑥ PHONO

Frequency display

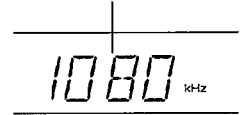

### 2 Select the broadcast band.



Each press switches the band as follows:

- ① FM
- ② AM

AM or FM indicator

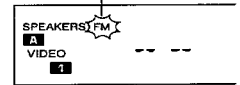

### 3 Specify the frequency.

① Press the DIRECT key.



② Enter the frequency of the desired station.

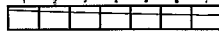

Press the numeric keys according to the frequency to be tuned as shown below.

AM 810 kHz	.....	8, 1, 0	(9 kHz space)
		8, 1	(10 kHz space)
AM 1260 kHz	.....	1, 2, 6, 0	(9 kHz space)
		1, 2, 6	(10 kHz space)
FM 90 MHz	.....	9, 0, 0, 0	(50 kHz space)
		9, 0, 0	(100 kHz space)
FM 102.5 MHz	....	1, 0, 2, 5, 0	(50 kHz space)
		1, 0, 2, 5	(100 kHz space)

Frequency display

TUNED lights up when a station is tuned.

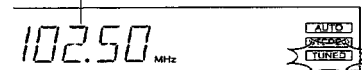

• If you make a mistake, repeat step 3 again

### Preparation



- Tune the station to be stored in memory.

## Storing radio stations in memory (Station preset)

### 1 Press the MEMORY key during receiving a station.

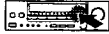

Lights up (for 5 sec.)

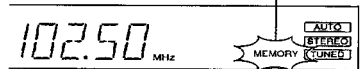

Proceed to step 2 within 5 sec.

(If more than 5 sec. have elapsed, press the MEMORY key again.)

### 2 Select one of the preset numbers from 1 to 20.

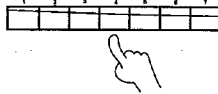

Press the numeric keys in the following order.

To store in "15" .....+10, 5  
To store in "20" .....+10, +10, 0

- Repeat steps 1 and 2 for each of the stations to be stored in memory.
- If a station is stored in a preset number which already stores a station memory under it, the previous memory is replaced by the new memory content.
- Once the memory content has been preset, it is held for about 3 days even after the power cord is unplugged from the mains outlet.

## Receiving a preset station

Press the preset number of the desired station.

- ① Select the TUNER input with the INPUT SELECTOR.



②

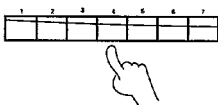

Press the numeric keys in the following order.

To recall "15" .....+10, 5  
To recall "20" .....+10, +10, 0

## Receiving all preset stations in order

Press the P.CALL key.



- Every time the key is pressed, the next station in the order of the preset number is received.

If the key is held pressed .....Preset stations will be received successively for about half a second each.

# Operation of video components

20

For the connections and operations, also read carefully the instruction manuals of the video components. → P.4 → P.6

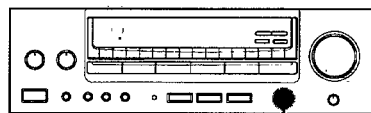

## Playback of videotape

**1** Turn the power of the monitor TV ON.

**2** Select the VIDEO 1 input.



**3** Play the video deck.

The input sources are switched in the following order:

- ① TUNER (frequency display)
- ② TAPE 1
- ③ VIDEO 1
- ④ VIDEO 2
- ⑤ CD
- ⑥ PHONO

"VIDEO 1" should be displayed.

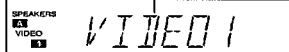

- Select the input to which a video deck is connected.

## Recording of video source

**1** Connect the video source component to be played.

**2** Select the VIDEO 2 input.



**3** Play the source component.

**4** Start recording on the recording video deck.

- Connect the component to be played to the VIDEO 2 jacks.
- The connectable components include a video deck (playback only), video camera (playback only), LD player or DBS tuner.

The input sources are switched in the following order:

- ① TUNER (frequency display)
- ② TAPE 1
- ③ VIDEO 1
- ④ VIDEO 2
- ⑤ CD
- ⑥ PHONO

"VIDEO 2" should be displayed.

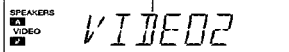

- Start recording with the video deck which is connected to the VIDEO 1 jacks.

# Presence play

The surround modes allow to enjoy the feeling of presence in music. Select the mode according to the source or components played. For the connections of the rear and/or center speakers, refer to "Connection of speakers". → P.6 → P.7

## DOLBY PRO LOGIC surround mode

Video and LD software programs carrying the  mark contain recording of the same Dolby Surround data as those used in movie theaters.

The DOLBY PRO LOGIC surround mode uses the Dolby Surround data and brings into home a similar sound field with full of presence to movie theater.

To use this mode, connect the rear (and center) speakers.

→ P.6 → P.7

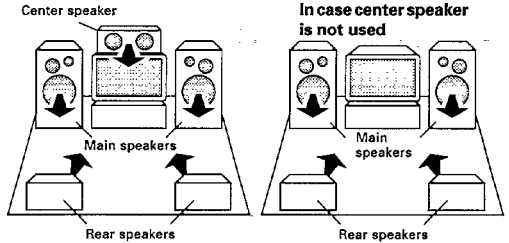

## DOLBY 3 STEREO mode

If the left and right speakers are installed apart from each other, the center acoustic image (words, etc.) may vary depending on the listener's position. The DOLBY 3 STEREO mode provides an improved positioning of the center acoustic image regardless of the listening position.

To use this mode, connect the center speaker.

→ P.6 → P.7

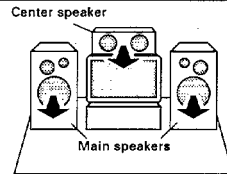

## THEATER LOGIC

This mode provides the atmosphere of a movie theater by adding the reverberation component of movie theater to the sound of the original music source. To use this mode, connect both the rear and center speakers.

→ P.6 → P.7

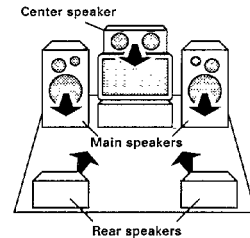

This mode provides a similar Dolby Surround effect used in movie theaters when a video (or LD) software program carrying the **DOLBY SURROUND** mark is played.

# DOLBY PRO LOGIC surround arrangement

**1 Activate the DOLBY PRO LOGIC mode.**

- 
- 

**2 Adjust the volume balance.**

- 
- 
- 

**3 Adjust the delay time.**

### How to calculate the proper delay time

Assuming that the distance from the front speaker is A meters and the distance from the rear speakers is B meters

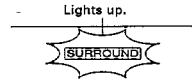

Each press of the **CENTER MODE** key switches the center modes as follows:

- ① **NORMAL** :When the center speaker is a compact-sized speaker.
- ② **WIDE BAND** :When the center speaker is a medium- or large-sized speaker.
- ③ **PHANTOM** :When the center speaker is not used.

- If you cannot tell whether your center speaker is compact or medium-sized, try two modes and select according to your liking.
- The selected center mode is automatically stored in memory and held unless it is changed later.

- The test tone which is heard like noise moves between speakers at an interval of 1.5 sec.

<p><b>In NORMAL and WIDE BAND modes:</b></p> <ul style="list-style-type: none"> <li>Left (L)</li> <li>Center (C)</li> <li>Right (R)</li> <li>Surround (Rear) (S)</li> </ul>	<p><b>In PHANTOM mode:</b></p> <ul style="list-style-type: none"> <li>Left (L)</li> <li>Right (R)</li> <li>Surround (Rear) (S)</li> </ul>
---	---

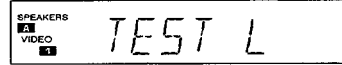

- Be sure to adjust from your listening position.
- When a key is pressed, the corresponding volume level to the key is displayed on the display. While the level is displayed, it can be adjusted by 1 dB per press of the key.
- The volume levels can be adjusted in the range from -10 dB to +10 dB.
- The center and rear levels are stored in memory as the common settings with the THEATER LOGIC mode.

- When the **DELAY TIME** key is pressed, the delay time is displayed on the display.
- The delay time can be adjusted in the range from 15 to 30 ms, in 5 ms steps.
- Set the closest value to the value obtained with method ① or ② below.
- Once the delay time has been preset, it is held until it is re-set later.

- ① Use the delay time calculation chart on the below.  
Example: When A = 3 m, B = 3 m, the delay time is 20 ms.

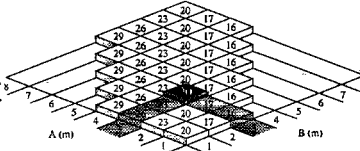

- ② Use the following formula for calculation.  
Delay time =  $20 + 3 \times (A - B)$  (Unit: ms)

Before playing a video (or LD) software program carrying the **DOLBY SURROUND** mark, be sure to complete the "DOLBY PRO LOGIC surround arrangement".

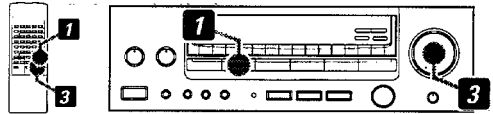

## DOLBY PRO LOGIC surround playback

**1** Activate the DOLBY PRO LOGIC mode.

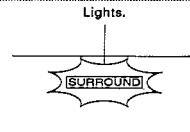

Each press of the key switches the modes as follows:

- ① PRO LOGIC
- ② 3 STEREO
- ③ THEATER LOGIC
- ④ OFF (BYPASS)

**2** Play a video software program.

**3** Adjust the volume.

VOLUME CONTROL

### To cancel DOLBY PRO LOGIC SURROUND play

BYPASS

SURROUND MODE

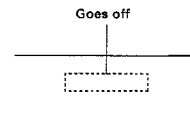

This mode improves the positioning of the acoustic image of words, etc., by applying directivity enhancer processing and using an additional center speaker when a video software program recorded with ordinary 2-channel stereo is played.

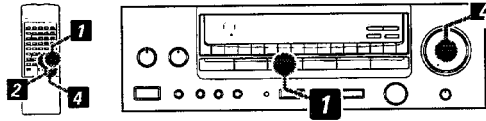

## DOLBY 3 STEREO adjustment and playback

### 1 Activate the DOLBY 3 STEREO mode.

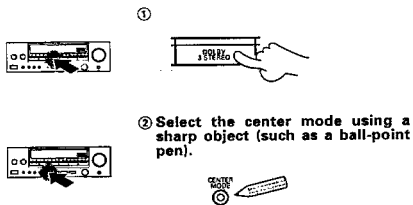

### 2 Adjust the volume balance.

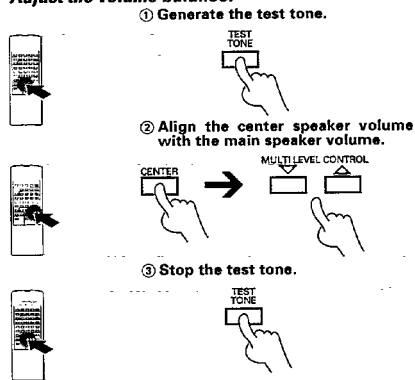

### 3 Play a video software program.

### 4 Adjust the volume.

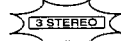
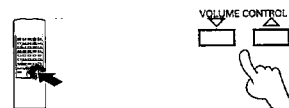

Each press of the **CENTER MODE** key switches the center modes as follows:

- ① **NORMAL** :When the center speaker is a compact-size speaker.
  - ② **WIDE BAND** :When the center speaker is a medium- or large-sized speaker.
- If you cannot tell whether your center speaker is compact or medium-sized, try two modes and select according to your liking.
  - The selected center mode is automatically stored in memory and held unless it is changed later.
- 
- The test tone which is heard like noise moves between speakers in an interval of 1.5 sec.

- Left (L)
- Center (C)
- Right (R)

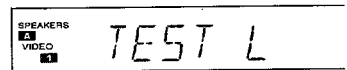

- Be sure to adjust from your listening position.
- When a key is pressed, the volume level is displayed on the display. While the level is displayed, it can be adjusted by 1 dB per press of the key.
- The center level can be adjusted in the range from -10 dB to +1 dB.
- The center level is stored in memory as the common settings when the DOLBY PRO LOGIC surround mode.

### To cancel DOLBY 3 STEREO play

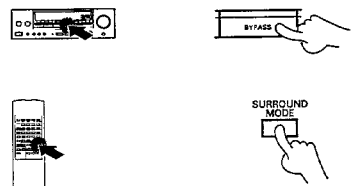



This mode allows to enjoy the sound field of a movie theater. By varying the settings, it is also possible to create the desired sound field. The settings should be adjusted from your listening position.

### Preparation

- Play a video source.

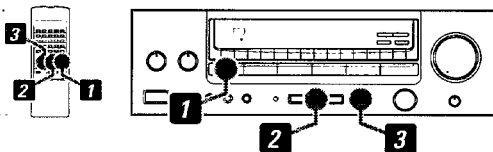

## Enjoying music with a feeling of presence (THEATER LOGIC mode)

### 1 Activate the THEATER LOGIC mode.



SURROUND  
MODE



Step 1 is enough for obtaining sufficient sound field effect. Proceed to steps 2 and 3 below if you like.

### 2 Adjust the volume balance.

- ① Adjust the centre speaker volume.



MULTI LEVEL CONTROL



- ② Adjust the rear speaker volume.



MULTI LEVEL CONTROL



### 3 Adjust the delay time.



MULTI LEVEL CONTROL



### To cancel the presence play



SURROUND  
MODE



Each press of the key switches the modes as follows:

- ① PRO LOGIC
- ② 3 STEREO
- ③ THEATER LOGIC
- ④ OFF (BYPASS)

Lights up.

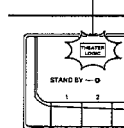

- The values set in the following steps are reset to the initial values when another surround mode is selected.

CENTER +5<sup>dB</sup>

- When the **CENTER** key is pressed, the center volume level is displayed on the display. The level can be adjusted by 1 dB per press of the **MULTI LEVEL CONTROL** key.

- The center volume level can be adjusted in the range from -10 dB to +10 dB.

REAR +3<sup>dB</sup>

- When the **REAR** key is pressed, the rear volume level is displayed on the display. The level can be adjusted by 1 dB per press of the **MULTI LEVEL CONTROL** key.

- The rear volume level can be adjusted in the range from -10 dB to +10 dB.

- The center level is stored in memory as the common setting with the DOLBY PRO LOGIC and DOLBY 3 STEREO mode, and the rear level is stored as the common settings with the DOLBY PRO LOGIC modes.

DELAY 30<sup>ms</sup>

- When the **DELAY TIME** key is pressed, the delay time is displayed on the display, which can be adjusted by 10 ms per press of the **MULTI LEVEL CONTROL** key.

- The initial setting is 20 ms.

- The delay time can be adjusted in the range from 10 ms to 60 ms.

Goes off

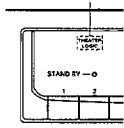

- Be sure to set the SURROUND MODE to OFF when the presence play is not required.

# ***n case of difficulty***

26

## **Remote control unit**

<b>Symptom</b>	<b>Cause</b>	<b>Remedy</b>
Remote control operation is not possible.	<ul style="list-style-type: none"> <li>● Batteries are exhausted.</li> <li>● The remote control unit is too far away from the main system, controlling angle is too large, or there is an obstacle in between.</li> <li>● The audio cords and system control cords are not connected properly.</li> <li>● The source component to be operated does not contain the tape(s) or CD.</li> <li>● An attempt is made to play a tape which is being recorded in the cassette deck.</li> </ul>	<ul style="list-style-type: none"> <li>● Replace with new batteries. → P.12</li> <li>● Operate the remote control unit within the controllable range.</li> <li>● Connect properly referring to "System connection". → P.4 → P.8</li> <li>● Place the tape(s) or CD in the source component to be played.</li> <li>● Wait until the recording is completed.</li> </ul>

## **Amplifier**

<b>Symptom</b>	<b>Cause</b>	<b>Remedy</b>
Sound is not output.	<ul style="list-style-type: none"> <li>● The speaker cords are disconnected.</li> <li>● The VOLUME is set to the minimum position.</li> <li>● The MUTE key is set to ON and the point indicator is blinking.</li> <li>● The SPEAKERS switches are set to OFF.</li> <li>● The TAPE 2 key is set to ON.</li> </ul>	<ul style="list-style-type: none"> <li>● Connect them properly referring to "System connection".</li> <li>● Adjust the volume to a proper level. → P.13</li> <li>● Press the MUTE key to OFF.</li> <li>● Set the SPEAKERS switch(es) to ON.</li> <li>● Set the TAPE 2 key to OFF.</li> </ul>
The STAND BY indicator blinks and sound is not output.	<ul style="list-style-type: none"> <li>● Speaker cords are short-circuited.</li> </ul>	<ul style="list-style-type: none"> <li>● Turn the power off, eliminate the short-circuiting, then turn on the power again.</li> </ul>
Sound is not output from one of the speakers.	<ul style="list-style-type: none"> <li>● The speaker cord is disconnected.</li> <li>● The BALANCE control is set to an extreme position.</li> </ul>	<ul style="list-style-type: none"> <li>● Connect it properly referring to "System connection".</li> <li>● Adjust the Left/Right balance.</li> </ul>
Sound is not output from the Surround rear speaker and/or center speaker, or their sound is very small.	<ul style="list-style-type: none"> <li>● The rear-speaker cords and/or center speaker cord are disconnected.</li> <li>● The Surround play mode has not been engaged.</li> <li>● The REAR VOL. and/or CENTER VOL. controls are set to the minimum level.</li> </ul>	<ul style="list-style-type: none"> <li>● Connect them properly referring to "System connection".</li> <li>● Set the presence mode.</li> <li>● Adjust the REAR VOL. and CENTER VOL. controls.</li> </ul>
A hum noise is generated when the PHONO input selector key is pressed.	<ul style="list-style-type: none"> <li>● The audio cord from the turntable is not inserted securely into the PHONO jacks.</li> <li>● The turntable is not grounded.</li> </ul>	<ul style="list-style-type: none"> <li>● Insert the audio cord plugs securely into the PHONO jacks.</li> <li>● Connect the grounding wire to the GND terminal on the rear panel.</li> </ul>

## **Tuner**

<b>Symptom</b>	<b>Cause</b>	<b>Remedy</b>
Radio stations cannot be received.	<ul style="list-style-type: none"> <li>● No antenna is connected.</li> <li>● The broadcast band is not set properly.</li> <li>● The frequency of the desired station is not tuned.</li> </ul>	<ul style="list-style-type: none"> <li>● Connect an antenna.</li> <li>● Set the broadcast band properly.</li> <li>● Tune the frequency of the desired station. → P.1</li> </ul>
Interference.	<ul style="list-style-type: none"> <li>● Noise due to ignition noise of an automobile.</li> <li>● Noise due to an influence from an electric appliance.</li> <li>● Noise due to a nearby TV set.</li> </ul>	<ul style="list-style-type: none"> <li>● Install the outdoor antenna apart from the road.</li> <li>● Turn off the power of the appliance.</li> <li>● Install the system more apart from the TV set.</li> </ul>
A station which was preset cannot be received by pressing the corresponding numeric key.	<ul style="list-style-type: none"> <li>● The preset station belongs to a frequency that cannot be received.</li> <li>● The preset memory was cleared because the power cord had been unplugged for a long period of time.</li> </ul>	<ul style="list-style-type: none"> <li>● Preset a station with a receivable frequency.</li> <li>● Preset the station again.</li> </ul>

### **Notes**



1. This system is microprocessor-controlled, so malfunction may occur due to external noise or interference noise. In such a case, unplug the power cord, plug it and turn power on again. Therefore, their lives may be shorter than ordinary batteries.
2. Do not use contact cleaners because it could cause a malfunction. Be specially careful against contact cleaners containing oil, for they may deform the plastic components.

## KR-V7060

U.S.A., Mexico and Canada

### Audio section

Rated power output at the STEREO operation

100 watts per channel minimum RMS, both channels driven at 8 Ω, from 20 Hz to 20,000 Hz with no more than 0.06% total harmonic distortions. (FTC)

Power output at the Surround operation

Front (1 kHz, 0.9% T.H.D. at 8 Ω) ..... 100 W + 100 W  
Center (1 kHz, 0.9% T.H.D. at 8 Ω) ..... 100 W  
Rear (1 kHz, 0.9% T.H.D. at 8 Ω) ..... 25 W + 25 W

Total harmonic distortion (1 kHz, 8 Ω) ..... 0.03% at 50 W

Signal to noise ratio (IHF A)

PHONO (MM) ..... 76 dB  
CD, TAPE, VIDEO ..... 100 dB

Input sensitivity / impedance

PHONO (MM) ..... 2.5 mV / 47 kΩ  
CD, TAPE, VIDEO ..... 200 mV / 47 kΩ

Tone controls

BASS ..... ±10 dB (at 100 Hz)

TREBLE ..... ±10 dB (at 10 kHz)

Loudness control at -30 dB VOLUME level  
..... + 8 dB (100 Hz)

### Video section

VIDEO inputs / outputs(Composite) ..... 1 Vp-p / 75 Ω

### FM Tuner section

Tuning frequency range ..... 87.5 MHz-108 MHz

Usable sensitivity (IHF) ..... 13.2 dBf (1.2 μV at 75 Ω)

50 dB quieting sensitivity  
STEREO ..... 41.2 dBf (32 μV at 75 Ω)

Total harmonic distortion at 1 kHz

MONO ..... 0.6%

STEREO ..... 0.7%

Signal to noise ratio at 65 dBf (IHF)

MONO ..... 75 dB

STEREO ..... 68 dB

Selectivity (IHF ±400 kHz) ..... 50 dB

Stereo separation (IHF at 1 kHz) ..... 40 dB

Frequency response ..... 30 Hz-15 kHz, +0.5 dB, -3.0 dB

### AM Tuner section

Tuning frequency range ..... 530 kHz-1,700 kHz

Usable sensitivity ..... 12 μV / (500 μV / m)

Total harmonic distortion ..... 0.7 %

Signal to noise ratio ..... 48 dB

Selectivity ..... 30 dB

### General

Power consumption ..... 3.5 A

AC outlet

SWITCHED ..... 2: (total 200 W, 1.6 A max.)

Dimensions ..... W: 440 mm (17-5/16")

H: 143 mm (5-5/8")

D: 401 mm (15-13/16")

Weight (net) ..... 12 kg (26.5 lb)

## KR-V7060

Other countries

### Audio section

Rated power output at the STEREO operation

(EIAJ) 1 kHz, 10 % THD at 8 Ω ..... 135 W + 135 W

(IHF '66) from 20 Hz to 20 kHz,

0.06% T.H.D., at 8 Ω ..... 100 W + 100 W

Power output at the Surround operation

Front (1 kHz, 0.9% T.H.D. at 8 Ω) ..... 100 W + 100 W

Center (1 kHz, 0.9% T.H.D. at 8 Ω) ..... 100 W

Rear (1 kHz, 0.9% T.H.D. at 8 Ω) ..... 25 W + 25 W

Total harmonic distortion (1 kHz, 8 Ω) 0.03% at 50 W

Signal to noise ratio (IHF'66)

PHONO (MM) ..... 76 dB

CD, TAPE, VIDEO ..... 100 dB

Input sensitivity / impedance

PHONO (MM) ..... 2.5 mV / 47 kΩ

CD, TAPE, VIDEO ..... 200 mV / 47kΩ

Tone controls

BASS ..... ±10 dB (at 100 Hz)

TREBLE ..... ±10 dB (at 10 kHz)

Loudness control at -30 dB VOLUME level

..... + 8 dB (100 Hz)

### Video section

VIDEO inputs / outputs(Composite) ..... 1 Vp-p / 75 Ω

### FM Tuner section

Tuning frequency range ..... 87.5 MHz~108 MHz

Usable sensitivity (IHF) ..... 13.2 dBf (1.2 μV at 75 Ω)

50 dB quieting sensitivity

STEREO ..... 41.2 dBf (32 μV at 75 Ω)

Total harmonic distortion at 1 kHz

MONO ..... 0.6 %

STEREO ..... 0.7 %

Signal to noise ratio at 65 dBf (IHF)

MONO ..... 75 dB

STEREO ..... 68 dB

Selectivity (IHF ± 400 kHz) ..... 50 dB

Stereo separation (IHF at 1 kHz) ..... 40 dB

Frequency response ..... 30 Hz ~ 15 kHz, + 0.5 dB, - 3.0 dB

### AM Tuner section

Tuning frequency range

9 kHz ..... 531 kHz ~ 1,602 kHz

10 kHz ..... 530 kHz ~ 1,610 kHz

Usable sensitivity ..... 12 μV / (500 μV / m)

Total harmonic distortion ..... 0.7 %

Signal to noise ratio ..... 48 dB

Selectivity ..... 30 dB

### General

Power consumption ..... 330 W

AC outlet

SWITCHED ..... 2: (total 200 W max.)

(Except for Australia)

Dimensions ..... W: 440 mm

H: 143 mm

D: 401 mm

Weight (net) ..... 12 kg

#### Note



KENWOOD follows a policy of continuous advancements in development. For this reason specifications may be changed without notice.



## KR-V6060

U.S.A., Mexico and Canada

### Audio section

#### Rated power output at the STEREO operation

100 watts per channel minimum RMS, both channels driven at 8 Ω, from 20 Hz to 20,000 Hz with no more than 0.06% total harmonic distortions. (IHF)

#### Power output at the Surround operation

Front (1 kHz, 0.9% T.H.D. at 8 Ω) ..... 70 W + 70 W  
 Center (1 kHz, 0.9% T.H.D. at 8 Ω) ..... 70 W  
 Rear (1 kHz, 0.9% T.H.D. at 8 Ω) ..... 20 W + 20 W

#### Total harmonic distortion (1 kHz, 8 Ω) ..... 0.03% at 50 W

#### Signal to noise ratio (IHF A)

PHONO (MM) ..... 75 dB  
 CD, TAPE, VIDEO ..... 100 dB

#### Input sensitivity / impedance

PHONO (MM) ..... 2.5 mV / 47 kΩ  
 CD, TAPE, VIDEO ..... 200 mV / 47 kΩ

#### Tone controls

BASS ..... ±10 dB (at 100 Hz)  
 TREBLE ..... ±10 dB (at 10 kHz)  
 Loudness control at -30 dB level ..... + 8 dB (100 Hz)

### Video section

VIDEO inputs / outputs(Composite) ..... 1 Vp-p / 75 Ω

### FM Tuner section

Tuning frequency range ..... 87.5 MHz~108 MHz

Usable sensitivity (IHF) ..... 13.2 dBf (1.2 μV at 75 Ω)

50 dB quieting sensitivity

STEREO ..... 41.2 dBf (32 μV at 75 Ω)

Total harmonic distortion at 1 kHz

MONO ..... 0.6%

STEREO ..... 0.7%

Signal to noise ratio at 65 dBf (IHF)

MONO ..... 75 dB

STEREO ..... 68 dB

Selectivity (IHF ±400 kHz) ..... 50 dB

Stereo separation (IHF at 1 kHz) ..... 40 dB

Frequency response ..... 30 Hz~15 kHz, +0.5 dB, -3.0 dB

### AM Tuner section

Tuning frequency range ..... 530 kHz~1,700 kHz

Usable sensitivity ..... 12 μV / (500 μV / m)

Total harmonic distortion ..... 0.7%

Signal to noise ratio ..... 48 dB

Selectivity ..... 30 dB

### General

Power consumption ..... 3 A

AC outlet

SWITCHED ..... 2: (total 200 W, 1.6 A max.)

For Canada ..... 2: (total 140 W, 1.2 A max.)

Dimensions ..... W: 440 mm (17-5/16")

H: 143 mm (5-5/8")

D: 334 mm (13-1/8")

Weight (net) ..... 9.5 kg (20.9 lb)

## KR-V6060

Other countries

### Audio section

#### Rated power output at the STEREO operation

(EIAJ) 1 kHz, 10 % THD at 8 Ω ..... 135 W + 135 W

(IHF '66) from 20 Hz to 20 kHz,

0.06% T.H.D., at 8 Ω ..... 100 W + 100 W

#### Power output at the Surround operation

Front (1 kHz, 0.9% T.H.D. at 8 Ω) ..... 70 W + 70 W

Center (1 kHz, 0.9% T.H.D. at 8 Ω) ..... 70 W

Rear (1 kHz, 0.9% T.H.D. at 8 Ω) ..... 20 W + 20 W

Total harmonic distortion (1 kHz, 8 Ω) 0.03% at 50 W

#### Signal to noise ratio (IHF'66)

PHONO (MM) ..... 75 dB

CD, TAPE, VIDEO ..... 100 dB

#### Input sensitivity / impedance

PHONO (MM) ..... 2.5 mV / 47 kΩ

CD, TAPE, VIDEO ..... 200 mV / 47kΩ

#### Tone controls

BASS ..... ±10 dB (at 100 Hz)

TREBLE ..... ±10 dB (at 10 kHz)

Loudness control at -30 dB level ..... + 8 dB (100 Hz)

### Video section

VIDEO inputs / outputs(Composite) ..... 1 Vp-p / 75 Ω

### FM Tuner section

Tuning frequency range ..... 87.5 MHz~108 MHz

Usable sensitivity (IHF) ..... 13.2 dBf (1.2 μV at 75 Ω)

50 dB quieting sensitivity

STEREO ..... 41.2 dBf (32 μV at 75 Ω)

Total harmonic distortion at 1 kHz

MONO ..... 0.6%

STEREO ..... 0.7%

Signal to noise ratio at 65 dBf (IHF)

MONO ..... 75 dB

STEREO ..... 68 dB

Selectivity (IHF ± 400 kHz) ..... 50 dB

Stereo separation (IHF at 1 kHz) ..... 40 dB

Frequency response ..... 30 Hz ~ 15 kHz, + 0.5 dB, -3.0 dB

### AM Tuner section

Tuning frequency range

9 kHz ..... 531 kHz ~ 1,602 kHz

10 kHz ..... 530 kHz ~ 1,610 kHz

Usable sensitivity ..... 12 μV / (500 μV / m)

Total harmonic distortion ..... 0.7%

Signal to noise ratio ..... 48 dB

Selectivity ..... 30 dB

### General

Power consumption ..... 260 W

AC outlet

SWITCHED ..... 2: ( total 200 W max.

[Except for Australia

Dimensions ..... W: 440 mm

H: 143 mm

D: 334 mm

Weight (net) ..... 9.5 kg

#### Note



KENWOOD follows a policy of continuous advancements in development. For this reason specifications may be changed without notice.

## Free Manuals Download Website

<http://myh66.com>

<http://usermanuals.us>

<http://www.somanuals.com>

<http://www.4manuals.cc>

<http://www.manual-lib.com>

<http://www.404manual.com>

<http://www.luxmanual.com>

<http://aubethermostatmanual.com>

Golf course search by state

<http://golfingnear.com>

Email search by domain

<http://emailbydomain.com>

Auto manuals search

<http://auto.somanuals.com>

TV manuals search

<http://tv.somanuals.com>