

KENWOOD

KRC-V679R

KRC-679R

KRC-579R

KRC-579B

CASSETTE RECEIVER

INSTRUCTION MANUAL

KENWOOD CORPORATION



© B64-1926-20 (EW)

Contents

Safety precautions.....3

General features

Power.....	5
Volume.....	5
Switching Modes.....	6
Attenuator.....	6
Loudness.....	6
System Q.....	7
Speaker Setting.....	7
Audio Control Setting.....	8
Clock display.....	8
TEL Mute.....	9
Theft Deterrent Faceplate.....	10

Tuner features

Tuning.....	12
Station Preset Memory.....	12
Switching Display for Tuner.....	12

RDS features

RDS (Radio Data System).....	14
Enhanced Other Network.....	14
Alarm.....	14
Traffic Information Function.....	14
Presetting Volume for Traffic Information/News.....	15
Radio Text Scroll.....	15
Programme Type (PTY) Function.....	16
Changing Language for Programme Type(PTY) Function.....	17

Cassette player features

Playing Cassette Tapes.....	18
Fast Forwarding and Rewinding Cassette Tapes.....	18
Using Dolby B Noise Reduction.....	18
Switching Tape Types.....	18
Using DPSS (Direct Programme Search System).....	19
Blank Skip.....	19
Music Repeat.....	20
Switching Display for Cassette Tapes.....	20

External disc control features

Playing Disc mode.....	21
Switching Display for Discs.....	21
Fast Forwarding and Reversing Disc Play.....	22
Track Search.....	22
Disc Search.....	22
Track / Disc Repeat.....	22
Track Scan.....	23
Random Play.....	23
Magazine Random Play.....	24
Text / Title Scroll.....	24
Presetting Disc Names (DNPS).....	24

Menu settings

Menu System.....	26
Code Security Function.....	26
Touch Sensor Tone.....	27
Manual Time Adjustment.....	27
Automatic Time Adjustment.....	28
Selectable Illumination.....	28
Switching Graphic Display.....	28
Variable Illumination Colour Setting.....	28
Contrast Adjustment.....	29
Dimmer.....	29
External Amp Control.....	29
News Bulletin Function with PTY News Timeout Setting.....	30
Local Seek Function.....	30
Selecting Tuning Mode.....	30
Auto Memory Entry.....	30
AF (Alternative Frequency) Function.....	31
Restricting RDS Region (Region Restrict Function).....	31
Auto TP Seek Function.....	31
Monaural Reception.....	32
Text Scroll.....	32
Power OFF Timer.....	32

Installation

Accessories).....	33
Installation Procedure.....	33
Connecting Wires to Terminals.....	34
Installation.....	35

Troubleshooting guide38

Specifications42

Safety precautions

▲WARNING

To prevent injury and/or fire, take the following precautions:

- Insert the unit all the way until it is fully locked in place. Otherwise it may fly out of place during collisions and other jolts.
- When extending the ignition, battery or ground cables, make sure to use automotive-grade cables or other cables with an area of 0.75mm² (AWG18) or more to prevent cable deterioration and damage to the cable coating.
- To prevent short circuits, never put or leave any metallic objects (e.g., coins or metal tools) inside the unit.
- If the unit starts to emit smoke or strange smells, turn off the power immediately and consult your Kenwood dealer.
- Make sure not to get your fingers caught between the faceplate and the unit.
- Be careful not to drop the unit or subject it to strong shock.
The unit may break or crack because it contains glass parts.
- Do not touch the liquid crystal fluid if the LCD is damaged or broken due to shock. The liquid crystal fluid may be dangerous to your health or even fatal.
If the liquid crystal fluid from the LCD contacts your body or clothing, wash it off with soap immediately.

▲CAUTION

To prevent damage to the machine, take the following precautions:

- Make sure to ground the unit to a negative 12V DC power supply.
- Do not open the top or bottom covers of the unit.
- Do not install the unit in a spot exposed to direct sunlight or excessive heat or humidity. Also avoid places with too much dust or the possibility of water splashing.
- Do not set the removed faceplate or the faceplate case in areas exposed to direct sunlight, excessive heat or humidity. Also avoid places with too much dust or the possibility of water splashing.
- To prevent deterioration, do not touch the terminals of the unit or faceplate with your fingers.
- Do not subject the faceplate to excessive shock, as it is a piece of precision equipment.
- When replacing a fuse, only use a new one with the prescribed rating. Using a fuse with the wrong rating may cause your unit to malfunction.
- To prevent short circuits when replacing a fuse, first disconnect the wiring harness.
- Do not place any object between the faceplate and the unit.
- During installation, do not use any screws except for the ones provided. The use of improper screws might result in damage to the main unit.

IMPORTANT INFORMATION

About the disc changer to be connected:

To connect a disc changer having the "O-N" switch to this unit, set the "O-N" switch to "N".

To connect a disc changer having no "O-N" switch to this unit, the converter cord CA-DS100 and/or switching adapter KCA-S210A are required as options.

If a model with no "O-N" switch is connected, some unavailable functions and information that cannot be displayed are generated, such as the DNPS, DNPP, Magazine random play, and CD Text display. Note that none of the KDC-C100, KDC-C302, C205, C705, and non-Kenwood CD changers can be connected.

▲CAUTION

You can damage both your unit and the CD changer if you connect them incorrectly.

*Manufactured under license from Dolby Laboratories.
"Dolby" and the double-D symbol are trademarks of Dolby Laboratories.*

Safety precautions

NOTE

- If you experience problems during installation, consult your Kenwood dealer.
- If the unit does not seem to be working right, try pressing the reset button first. If that does not solve the problem, consult your Kenwood dealer.

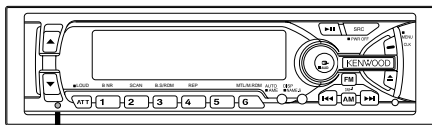

Reset button

- Characters in the LCD may become difficult to read in temperatures below 41 °F (5 °C).
- The illustrations of the display and the panel appearing in this manual are examples used to explain more clearly how the controls are used. Therefore, what appears on the display in the illustrations may differ from what appears on the display on the actual equipment, and some of the illustrations on the display may represent something impossible in actual operation.
- The functions that can be used and the information that can be displayed will differ depending on the external disc players being connected.

Cleaning the Faceplate Terminals

If the terminals on the unit or faceplate get dirty, wipe them with a dry, soft cloth.

Cleaning the Unit

If the faceplate of this unit is stained, wipe it with a dry soft cloth such as a silicon cloth. If the faceplate is stained badly, wipe the stain off with a cloth moistened with neutral cleaner, then wipe neutral detergent off.

CAUTION

Applying spray cleaner directly to the unit may affect its mechanical parts. Wiping the faceplate with a hard cloth or using a volatile liquid such as thinner or alcohol may scratch the surface or erases characters.

Cleaning the Tape Head

After you have used the tape player many times over a long period, magnetic powder from the tapes and dust accumulates on the tape head, causing noise and a deterioration in sound quality. Clean the tape head using a cleaning tape or cleaning kit designed for use in car audio systems.

Handling Cassette Tapes

- Do not play a cassette whose tape has gone slack. In such a case, wind it tight using a pencil or the like in one of the spools. Playing slack cassette tapes can result in the tape tangling around the capstan and/or pinch rollers, causing trouble.
- Do not play a deformed cassette or one whose label is starting to come off, as it can cause the unit to malfunction.
- Do not leave tapes in hot places, such as above the fascia panel (dashboard) and other spots exposed to direct sunlight, or near heater outlets. They can deform the cassette.
- Avoid using extremely long cassette tapes, such as 100-minute-long tapes. Such tapes are very thin, and can tangle easily around the pinch rollers or other parts inside the unit, causing unit failure.
- Remove a cassette tape from the unit when not listening to it for a whilst. If you leave a tape in the unit too long, it may stick to the tape head and cause unit malfunction.

General features

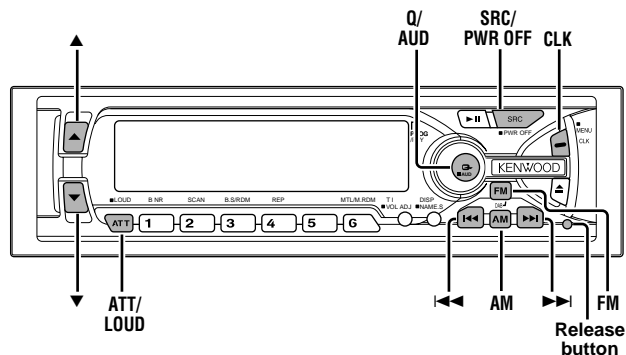

KRC-V679R

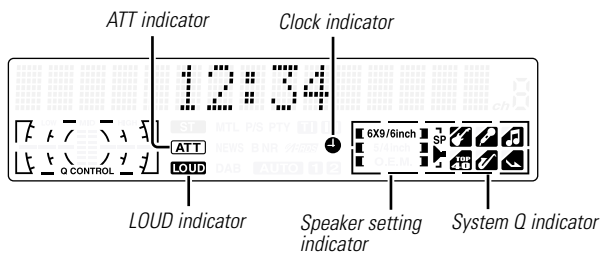

KRC-679R/KRC-579R/KRC-579B

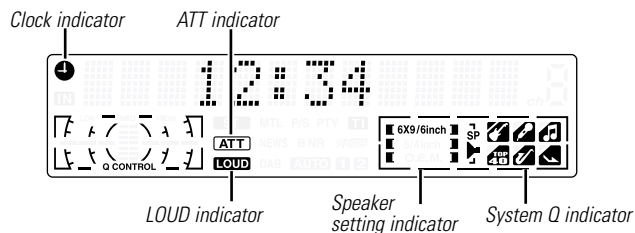

Power

Turning on the power:

Press the SRC button.

NOTE

Turn the power on before carrying out the following procedures.

Turning off the power:

Hold down the PWR OFF button for one second or more.

NOTE

The status of the Code Security Function (page 26) is displayed whenever the power is switched on.

"CODE ON" : Security Code has been registered

"CODE OFF" : Security Code has not been registered

Volume

Increasing Volume:

Press the ▲ button to turn up the volume.

Decreasing Volume:

Press the ▼ button to turn down the volume.

General features

Switching Modes

Switching Modes:

Each time you press the SRC button, the mode switches as follows:

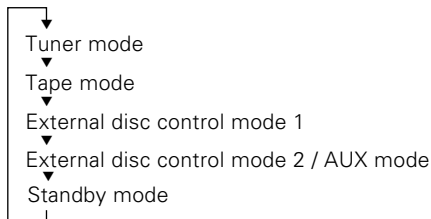

Selecting the standby mode:

Press the SRC button repeatedly to select to "ALL OFF". When "ALL OFF" is displayed, the standby mode is turned on. The standby mode turns all functions off although leaving the unit's power on. Use this mode when you want to have the display illuminated but do not want to listen to anything.

NOTE

- The mode switches to the next mode from any mode which cannot be used.
- The external disc control mode will differ depending on the unit that is connected.
- To enable the selection of External disc control mode 2/AUX mode, you should connect optional switching adapter KCA-S210A (which allows you to select both External disc control mode 2 and AUX mode) or CD changer (KDC-CPS87, KDC-CX87, KDC-CPS85, KDC-CX85, KDC-CPS82 or KDC-CX82) or switching adapter CA-C1AX (which allows you to select AUX mode only).

During the AUX mode, "AUX" (or AUX-name display) will show in the display. When the CA-C1AX is being used, the AUX Mode will replace the External Disc Control Mode.

- If you have selected Standby mode, the timer function that turns the power off automatically will be activated. To find out how to set the time on the timer, and how to cancel the timer function, refer to the section on the Power OFF Timer

function under Menu settings (page 32).

The Power OFF Timer function is enabled only after the security code (page 26) is set up.

NOTE

Selecting AUX-name display

Holding down the DISP button for two seconds or more during the AUX mode, AUX-name display is blinked for AUX-name selection mode.

Pressing ◀◀ or ▶▶ button during this mode allows you to select "AUX", "TV", "VCP", "GAME" or "PORTABLE" in the AUX mode.

The AUX-name selection mode can be exited by pressing the DISP button or doing nothing for 10 seconds.

Attenuator

This function allows you to turn down the volume quickly.

Turning Attenuator On/Off:

Press the ATT button to switch the attenuator on and off.

When the attenuator is on, the ATT indicator blinks.

When the attenuator is off, the volume returns to the original level.

NOTE

Turning the volume up, or turning it all the way down deactivates the attenuator function.

Loudness

This function amplifies low and high tones when the volume is turned down.

The LOUD indicator lights up, when the loudness function is on.

Turning Loudness On/Off:

Hold down the LOUD button for one second or more to switch the loudness on and off.

System Q

You can recall the best audio setting preset for different types of the music.

Switching the Preset Sound Setting:

Each time you press the Q button, the preset sound setting switches as follows:

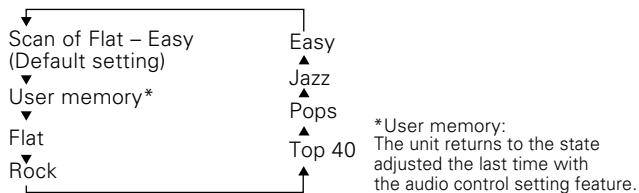

As you proceed, each indicator would go on.

NOTE

The System Q function changes the values of the following sound quality parameters:
Bass centre frequency, bass level, bass quality factor, bass extend, middle centre frequency, middle level, middle quality factor, treble centre frequency, and treble level.
Their setting values are different depending on the setting of the speaker setting mode.

with the System Q, according to types of speakers.

- 1 Press the SRC button repeatedly to select the standby mode. "ALL OFF" is displayed when the standby mode is selected.
- 2 Press the Q button to enter the speaker setting mode.
- 3 Press either the ◀◀ or ▶▶ button to select the type of speaker. The setting switches as follows.
Off ("SP OFF") / For 6/6x9 in. speaker ("SP 6*9/6inch") /
For 5/4 in. speaker ("SP 5/4inch")/
For the OEM speaker ("SP O.E.M.")
- 4 Press the Q button to end the speaker setting mode.

NOTE

Speaker setting function allows for tuning of bass, middle and treble.

Speaker Setting

This function allows you to adjust the setting that is recalled

General features

Audio Control Setting

Adjust various parameters of sound quality.

1 Hold down the AUD button for one second or more to enter the control mode.

2 *Selecting mode*

Press either the FM or AM button.

Each time the button is pressed, the adjustment mode will change as follows:

Pressing the FM button advances the display, and pressing the AM button reverses it.

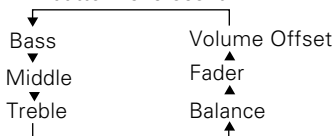

NOTE Source tone memory

Each source (tape, CD, MD, FM, AM and disc changer) has its own memory in which to store the bass, middle and treble tone settings.

The settings made for a particular source are then recalled automatically whenever you use that source (e.g., FM mode uses the tone settings made for FM, AM for AM, etc.).

3 *Adjust each mode*

Press the ◀◀/▶▶ button.

Look at the table to adjust the mode being displayed.

Adjustment mode (Display)	Operation of Audio control button	
	◀◀ button	▶▶ button
Bass ("Bass")	Bass decreased.	Bass increased.
Middle("Middle")	Middle decreased.	Middle increased.
Treble("Treble")	Treble decreased.	Treble increased.
Balance("Balance")	Left channel emphasized.	Right channel emphasized.
Fader ("Fader")	Rear channel increased.	Front channel increased.
Volume Offset ("V Offset")	The sound level of each source decreased.	The sound level of each source increased.

4 Press the AUD button to end the control mode.

NOTE

Determining the parameters in the audio control setting will clear all the adjustments made in the System Q and they are replaced with the values made in the audio control setting.

Clock display

Changing the Clock Display:

Each time you press the CLK button, the display switches between the clock and each mode display.

NOTE

The clock indicator lights whilst the clock is displayed.

TEL Mute

Shut down the audio system temporarily whenever an incoming call is received.

NOTE

The function will not work if a cable is not connected to the car phone.

When the telephone rings:

When a call is received, "CALL" is displayed and all the unit functions are temporarily interrupted.

Restoring Original Unit Source During Phone Call:

Press the SRC button.

"CALL" disappears from the display, and the volume of the original source is restored gradually.

Turning TEL Mute Function Off After Phone Call:

Hang the phone up.

"CALL" disappears from the display.

The original source (i.e., the one used before the phone call) is returned to automatically, and the volume restored gradually.

General features

Theft Deterrent Faceplate

The faceplate can be reversed to hide the control panel or detached from the unit, helping to deter theft.

Removing the Faceplate:

- When the control panel is visible:
Press the release button.
 - When the control panel has been hidden:
Press the upper side of the faceplate.
- Holding the centre part of the faceplate, pull it out.

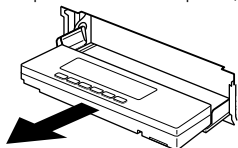

- Push back the bottom of the faceplate bracket until it locks.

CAUTION

- Do not apply excessive force to the faceplate bracket without attaching the faceplate. Doing so will cause the faceplate bracket to be deformed.
- Do not touch the connector on the faceplate bracket after removing the faceplate. Touching the connector may cause damage to the unit.

NOTE

- The faceplate is a precision piece of equipment and can be damaged by shocks or jolts. For that reason, keep the faceplate in its special storage case whilst detached.
- Do not expose the faceplate or its storage case to direct sunlight or excessive heat or humidity. Also avoid places with too much dust or the possibility of water splashing.

Reattaching the Faceplate:

- Hold the faceplate so that the control panel faces the front toward you and set the left side of the faceplate in the faceplate bracket.

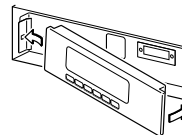

CAUTION

Do not set the right side of the faceplate in the faceplate bracket first, when reattaching the faceplate. Doing so may cause the connector on the faceplate bracket to malfunction.

- Press the right side of the faceplate until it locks.

Hiding the control panel:

- Press the release button and slide open the faceplate.
- Push upward the back of the control panel and reverse the panel.

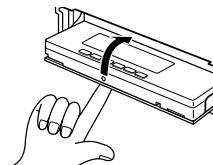

NOTE

The panel cannot be reversed when the faceplate is not attached.

Opening the control panel:

- Press the upper side of the faceplate.
The faceplate will open.
- Push the bottom of the control panel and close the faceplate.

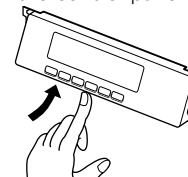

Tuner features

NOTE

Whilst the control panel is sliding, only available buttons are ▲, ATT, ▲, ▼ and SRC.

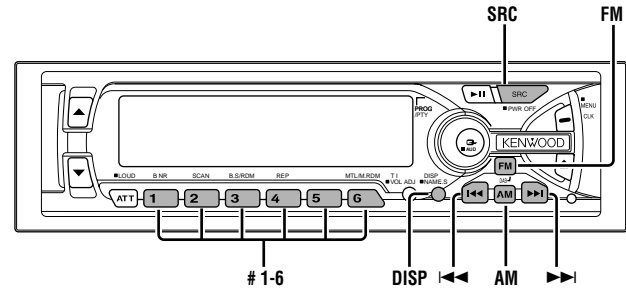

KRC-V679R

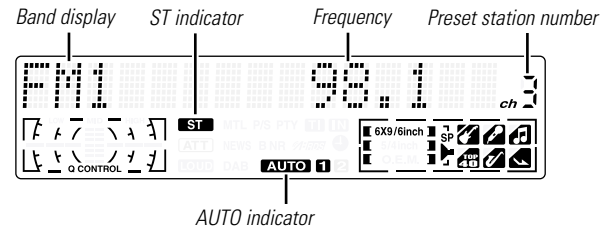

KRC-679R/KRC-579R/KRC-579B

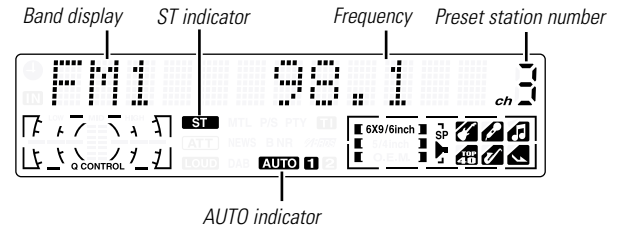

Tuner features

Tuning

- 1 Press the SRC button repeatedly until the tuner mode is obtained. "TUNER" is displayed only when the tuner mode is selected.
- 2 Press either the FM or AM button to select the band. Each time you press the FM button, the band switches between the FM1, FM2 and FM3. Press the AM button to select the MW and LW bands.
- 3
 - Auto Seek Tuning
Press the ►► button to seek increasing frequencies. Press the ◀◀ button to seek decreasing frequencies.
 - Preset station seek tuning
Press the ►► button to move to the next preset station (i.e., the one with the next highest number), and the ◀◀ button to move to the last preset station (i.e., the one with the next lowest number).

NOTE

If the frequencies stored at the preset numbers receive stations which were not originally memorized when travelling long distances, the preset number is not displayed. In such cases, pressing the ◀◀/►► button to use preset station seek will receive channel 1.

- Manual Tuning
Press the ►► button to increase the frequency by one step. Press the ◀◀ button to decrease the frequency by one step.

NOTE

- The ST indicator lights up when stereo broadcasts are being received.
- Please see the menu settings about selecting tuning mode. (page 30)

Station Preset Memory

Store the frequency of the station currently being listened to.

You can then recall that station with a single touch of a button.

- 1 Select the band/station that you want to have stored.
- 2 Hold down the button (#1-6) that you want to use for the station, for two seconds or more.
The button number blinks once in the display to indicate that the data has been stored.

Recalling a Preset Station:

Press the preset station button (#1-6) for the desired station. The number of the recalled station is displayed.

NOTE

You can store 6 stations in each of the FM1, FM2, FM3, and AM (MW and LW) bands.

Switching Display for Tuner

You can change the display used when listening to the radio.

Switching the Display:

Each time you press the DISP button, the display changes as follows:

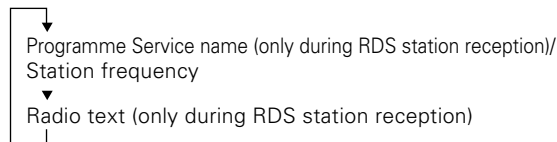

Displaying Frequencies during programme service name display:

Hold down the DISP button for one second or more. The frequency for the RDS station will be displayed for five seconds instead of the station name.

NOTE

If the RDS station currently tuned to is transmitting no text whilst the Radio Text Display mode is turned on, "NO TEXT" will appear

RDS features

in the display. Whilst awaiting reception, “Waiting” will be displayed.

▲WARNING

To prevent accidents, drivers should not look at the display whilst driving.

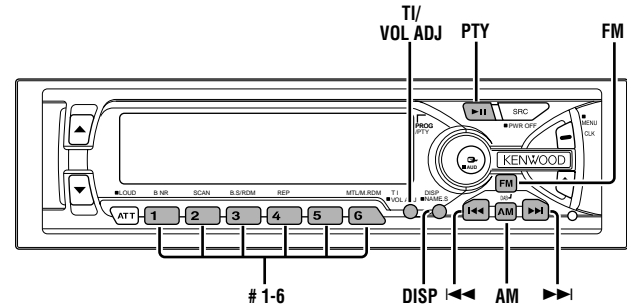

KRC-V679R

Band display

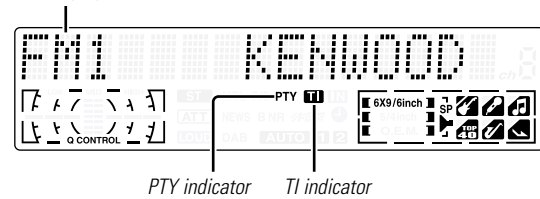

PTY indicator TI indicator

KRC-679R/KRC-579R/KRC-579B

Band display

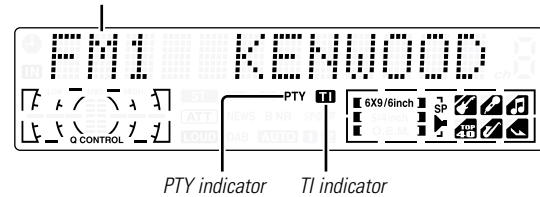

PTY indicator TI indicator

RDS features

RDS (Radio Data System)

RDS is a digital information system that lets you receive signals besides those of regular radio programmes, such as network information being transmitted from radio stations. When listening to an RDS station (ie, a station with RDS capability), the programme service name of the station is displayed along with the frequency, advising you quickly which station is being received.

RDS (Radio Data System) stations also transmit frequency data for the same station. When you are making long trips, this function automatically switches to the particular frequency with the best reception for the particular network of stations that you want to listen to. The data is automatically stored, allowing you to switch quickly to another RDS stations, broadcasting the same programme, that has better reception. These include stations stored in the station preset memory that you often listen to.

Enhanced Other Network

Stations that offer <Enhanced Other Network> also transmit information about other RDS stations that have traffic information. When you are tuned to a station that is not transmitting traffic information, but another RDS station starts transmitting a traffic bulletin, the tuner automatically switches to the other station for the duration of the bulletin.

Alarm

When an emergency transmission (announcing disasters, etc.) is sent, all current functions are interrupted to allow the warning to be received.

Traffic Information Function

You can listen to traffic information. If you are listening to tapes or discs, they will continue playing until a traffic bulletin is broadcast.

Turning TI function On/Off:

Press the TI button to turn the function on and off.

When the function is on, the TI indicator is turned on.

When none is being received, the TI indicator will blink on and off. When a traffic information station is being received, the TI indicator will turn on.

When a traffic bulletin begins to be broadcast, "Traffic Info" will be displayed, and reception will begin at the preset volume.

If you are listening to a tape or disc when a traffic bulletin begins, they will automatically be turned off. When the bulletin ends or poor reception is experienced, the tape or disc will begin playing again.

NOTE

Pressing the TI button whilst in the MW/LW band automatically switches reception to the FM band. However, the MW/LW band is not returned to when the TI button is pressed again.

Switching to a Different Traffic Information Station:

Use the ◀◀ / ▶▶ buttons to make an auto seek of the TI stations in a certain band.

NOTE

- When you are listening to a tape or disc, you cannot change to another TI station.
- When the auto TP seek function is turned on and reception starts to weaken, the tuner automatically seeks traffic information stations with better reception.
- If you are tuned to a station that is not a traffic information station itself but which provides <Enhanced Other Network> services, you can still have traffic information received.
- Holding down the TI button for one second or more when the TI function is on in the tape or disc mode results in a change to the frequency display of the traffic information station for five seconds.

Presetting Volume for Traffic Information/News

Preset the volume level to be used for traffic information and news broadcasts.

- 1 Tune into the station for which you want to set the volume.
- 2 Adjust the volume to the desired level.
- 3 Hold down the VOL ADJ button for two seconds or more. The volume level blinks once in the display to indicate that the data has been stored. Future traffic information/news broadcasts are heard at the preset level.

NOTE

- The volume cannot be lowered by this function during tuner reception. The volume is only set when it is louder than the listening volume of the tuner.
- You can arrange only to listen to traffic information or news bulletins with at preset volume with the volume set at minimum.

NOTE

Please see the menu settings (page 32) about switching between manual scrolling and automatic scrolling.

Radio Text Scroll

This function permits the text to be scrolled and the entire text to be displayed. The scrolling method differs depending on the setting of scrolling in the menu.

To scroll manually:

- 1 Press the DISP button to display the Radio Text.
- 2 Holding down the DISP button for one second or more results in one scrolling display of the text.

To scroll automatically:

- 1 Press the DISP button to display the Radio Text. The text will be displayed in one scrolling display.
- 2 Holding down the DISP button for one second or more results in one scrolling display of the text.

RDS features

Programme Type (PTY) Function

Conduct auto seek tuning only on those stations with selected kinds of programmes.

- 1 Press the PTY button.
"PTY" is displayed, and the Programme Type Selection (PTY) Mode entered.

If you make no key input in 30 seconds, the mode will automatically turn off.

NOTE

You cannot use this function whilst the traffic bulletin is received.

2 Select the type of programme to be received

- Press either the FM or AM button repeatedly until the type of programme you want to listen to.

The selection includes:

	<i>Speech</i>	(<i>Speech</i>)
	<i>Music</i>	(<i>Music</i>)
1.	News	(News)
2.	Current Affairs	(Affairs)
3.	Information	(Info)
4.	Sports	(Sport)
5.	Education	(Educate)
6.	Drama	(Drama)
7.	Culture	(Culture)
8.	Science	(Science)
9.	Varied	(Varied)
10.	Pop Music	(Pop M)
11.	Rock Music	(Rock M)
12.	Easy Listening Music	(Easy M)
13.	Light Classical	(Light M)
14.	Serious Classical	(Classics)
15.	Other Music	(Other M)
16.	Weather	(Weather)
17.	Finance	(Finance)
18.	Children's programmes	(Children)
19.	Social Affairs	(Social)
20.	Religion	(Religion)
21.	Phone In	(Phone In)
22.	Travel	(Travel)
23.	Leisure	(Leisure)

24.	Jazz Music	(Jazz)
25.	Country Music	(Country)
26.	National Music	(Nation M)
27.	Oldies Music	(Oldies)
28.	Folk Music	(Folk M)
29.	Documentary	(Document)
	(<i>Speech</i>1~9,16~23, 29, <i>Music</i>10~15, 24~28)	

- You can select the type of programme directly by pressing a preset button. The buttons are factory-set to the following type of programmes:

1. <i>Music</i>	2. <i>Speech</i>	3. News
4. Other Music	5. Serious Classical	6. Varied

NOTE

Changing the Preset Button Settings for Programme Type
After selecting the type of programme to be stored in a certain preset button, hold down that button for two seconds or more. The previously stored data for that button are erased and the new programme type is stored.

3 Seeking the selected programme type

Press the ◀◀ or ▶▶ button to make a seek of frequencies with your selected type of programme.
The display blinks and the seek starts.

If your selected type of programme is found, the name of the station is displayed and the station is tuned into.

"PTY Found" is displayed for about 30 seconds.

If you make no key input in 30 seconds, the PTY selection mode will turn off automatically.

NOTE

If no programme can be found, "NO PTY" is displayed.
If you want to select another type of programme, repeat steps 2 and 3 above.

Switching to Other Stations with the Same Type of Programme:

When "PTY Found" is displayed, perform auto seek tuning.
The tuner scans for another station with the same type of programme.

Cancelling Programme Type Function During Its Operation:

Press the PTY button.

Changing Language for Programme Type(PTY) Function

Changing the display language to another language.

- 1 Press the PTY button.
"PTY" is displayed, and the Programme Type Selection (PTY) Mode entered.
- 2 **Enter the Changing Language Mode**
Press the DISP button to enter the changing language mode.
- 3 **Changing the Display Language**
Press the FM or AM button.
Each time the button is pressed, the display language will change as follows:

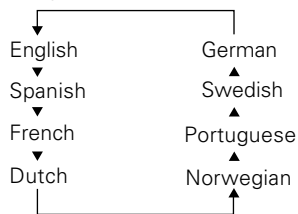

- 4 Press the DISP button to end the changing language mode.

Cassette player features

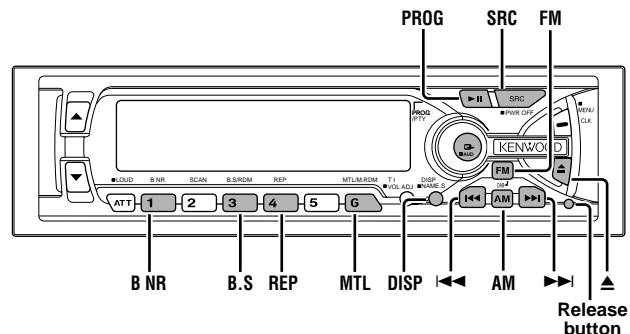

KRC-V679R

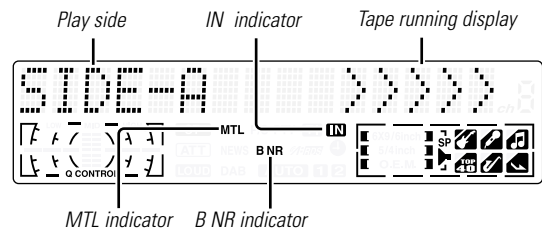

KRC-679R/KRC-579R/KRC-579B

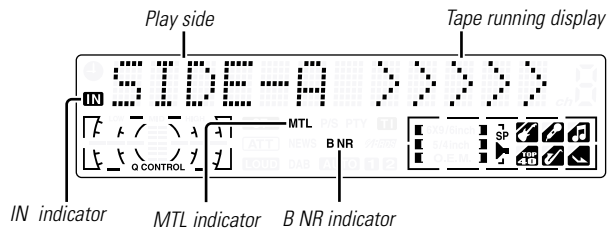

Cassette player features

Playing Cassette Tapes

Loading and Playing Cassettes:

Press the release button to slide open the faceplate, showing the cassette insertion slot.

Holding the cassette with the tape exposed to the right, insert it in the slot. The tape will start playing.

Push back the bottom of the faceplate with your hand until it locks.

The IN indicator lights up when a cassette has been loaded.

⚠CAUTION

When inserting a cassette make sure the cassette has been completely drawn in before pushing back the faceplate. Failing to do so might deform the tape.

Playing Cassettes Already Loaded:

Press the SRC button repeatedly until the tape mode is obtained.

"TAPE" is displayed when the tape mode has been selected.

The tape will start playing.

Listening to the other side:

Press the PROG button.

Tape play switches to the other side.

Ejecting Cassettes:

Press the release button and slide open the faceplate.

Press the ▲ button.

The tape stops playing and the cassette ejects.

Push back the bottom of the faceplate with your hand until it locks.

⚠CAUTION

- When the faceplate has been slid open, it might interfere with the gear lever or something else. If this happens, pay attention to safety and move the gear lever or take an appropriate action, then operate the unit.
- Do not use the unit with the faceplate in the open condition. Doing so will cause breakdown.

NOTE

- Remove a cassette from the unit when not listening to it for a whilst. If you leave it in the unit too long, the tape may stick to

the tape head and cause the unit to malfunction.

- Whilst the control panel is sliding, only available buttons are ▲, ATT, ▲, ▼ and SRC.

Fast Forwarding and Rewinding Cassette Tapes

Fast Forwarding Tapes:

Press the FM button.

Rewinding Tapes:

Press the AM button.

Cancelling:

Press the PROG button.

Normal tape play returns.

Using Dolby B Noise Reduction

Listen to tapes recorded using the Dolby B NR system.

Turning Dolby NR On/Off:

Press the B NR button to switch Dolby B NR on and off.

The B NR indicator lights up when Dolby B NR is turned on.

Switching Tape Types

Select type of tape being played.

Switching Tape Types:

Press the MTL button to switch the MTL indicator on and off and to select the tape type.

Turn the MTL indicator off for normal tape (Type I) playback.
Turn the MTL indicator on for the following tape types:
CrO₂ (Type II) FeCr (Type III) Metal (Type IV)
Selecting the wrong tape type may cause sound quality to suffer.

Using DPSS (Direct Programme Search System)

Skip forwards or backwards to other tracks during playback.

Skipping to Beginning of Current Track or to Previous Tracks (Rewind DPSS):

Press the **I◀◀** button.

Press once to rewind to the beginning of the current track, twice to rewind to the beginning of the previous track, and so forth.

You can skip up to 9 tracks this way.

Playback is continued after the tape is rewound by the indicated number of tracks.

Skipping to Later Tracks (Fast Forward DPSS):

Press the **▶▶I** button.

Press once to fast forward to the next one track, twice to fast forward to the track after that, and so forth.

Up to 9 tracks can be skipped.

Playback is continued after the tape is fast forwarded by the indicated number of tracks.

NOTE

- During the first 5 seconds of each track, the previous track is considered the "current" track (i.e., the "0" track). If you press the **I◀◀** button during that period, the tape rewinds to the beginning of the previous track and not the one you are listening to.
- The DPSS function "knows" where a track begins by detecting the blank space preceding it (i.e., the space between tracks). However, when the blank space lasts for less than 4 seconds or contains noise, DPSS may not operate correctly. Furthermore, quiet intervals within a song are detected as "blank spaces" if

they last for 4 seconds or more.

Cancelling DPSS During Its Operation:

Press the PROG button.

Blank Skip

Automatically fast forwards to the beginning of the next track when long blank spaces (10 seconds or more) are detected, continuing tape playback. This function is on, when unit is first powered on.

Turning Blank Skip Function On/Off:

Press the B.S button to switch the blank skip function on and off.

"B.Skip ON" is displayed when the blank skip function is turned on.

NOTE

- If the blank space contains hiss noise, the blank skip function may not work correctly.
- Sections recorded at low levels may trigger the blank skip function if they last for 10 seconds or more.

Cassette player features

Music Repeat

Repeatedly plays the current track.

Turning Music Repeat Function On/Off:

Press the REP button to switch the music repeat function on and off.

"Repeat ON" is displayed when music repeat is turned on.

Cancelling Music Repeat Function:

Press either the REP or PROG button.

NOTE

The music repeat function "knows" where a track begins by detecting the blank space preceding it (i.e., the space between tracks). However, when the blank space lasts for less than 4 seconds or contains noise, this function may not operate correctly. Furthermore, sections recorded at low levels may trigger the function if they last for 4 seconds or more.

Switching Display for Cassette Tapes

Switch the display that appears whilst tapes are playing.

Switching the Tape display:

Each time you press the DISP button, the display during tape play switches as follows:

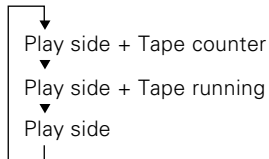

NOTE

The tape counter is not exact, but only represents an approximation of the elapsed time.

External disc control features

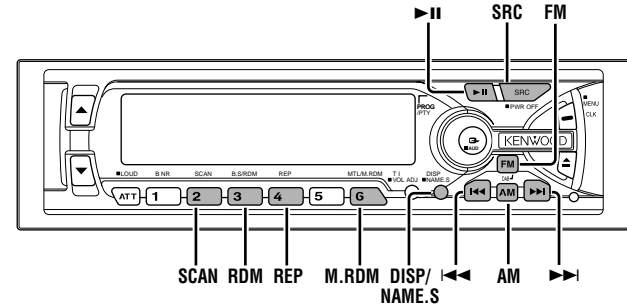

KRC-V679R

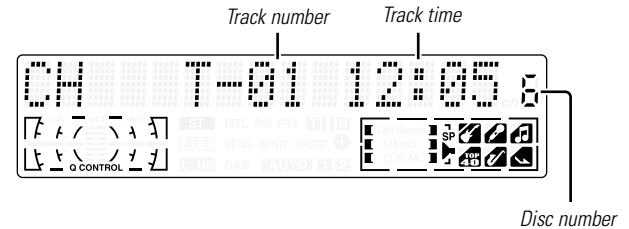

KRC-679R/KRC-579R/KRC-579B

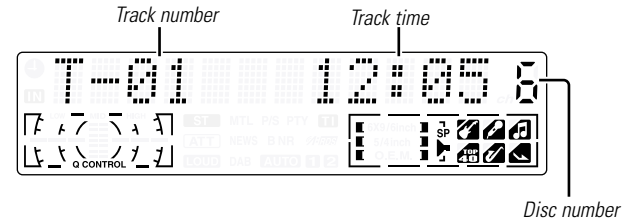

Playing Disc mode

This function permits the connection of optional players and the playing of discs.

Playing Discs:

Press the SRC button repeatedly to select the external disc control mode.

The disc will start playing.

NOTE

The external disc control mode will differ, depending on the unit that is connected.

Mode Display Examples

- "CD" ...when a CD player is connected
- "DISC" ...when a disc changer is connected
- "DISC-1" , "DISC-2" ...when two disc changers are connected

Pausing and Restarting Disc Play:

Press the ►|| button to make the disc pause.

Press the same button again to start play again.

NOTE

- When one disc has finished playing its last track, the next disc in the changer starts playing. When the last disc in the changer has finished, the player returns to the first disc and starts playing it.
- Disc #10 is displayed as "0".

Switching Display for Discs

Switch the display that appears whilst discs are playing.

Switching Display for Discs:

Each time you press the DISP button, the display during disc play switches as follows:

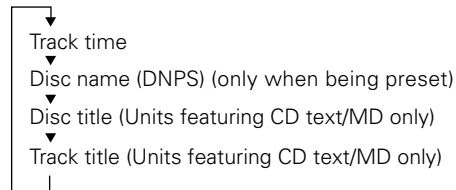

NOTE

- You can give names to discs through the presetting disc name function (page 24).
Note that depending on the unit, display may not be possible.
- If you try to display the name of a disc that does not have one, "NO NAME" is displayed instead.
- When there is an attempt to display the title of a disc for which the disc title/track title has not been recorded, "NO TEXT" is displayed for CD and "NO TITLE/NO NAME" is displayed for MD.
- If you attempt to display disc title/track title when connecting the CD changer not supported for CD text feature, caution messages such as "NO TEXT" or "Reading" may be displayed.
- Depending on the type of characters of the CD Text, some characters may not be displayable.

External disc control features

Fast Forwarding and Reversing Disc Play

Fast Forwarding Disc Play:

Hold down on the ►► button.

Release your finger to play the disc at that point.

Reversing Disc Play:

Hold down on the ◀◀ button.

Release your finger to play the disc at the point.

NOTE

You cannot use reverse play between tracks depending on the model being connected. Instead, the reverse play function is cancelled when it reaches the beginning of a track, at which point normal play automatically resumes.

Track Search

Search forwards or backwards through the tracks on the disc until you reach the one that you want to listen to.

Making a Reverse Track Search:

Press the ◀◀ button to display the desired track number.

Press once to search back to the beginning of the current track, twice to search back to the beginning of the previous track, and so forth.

Play starts at the beginning of the displayed track number.

NOTE

(For disc changers)

Pressing the ◀◀ button whilst listening to track 1 only searches back to the beginning of that track. The reverse search is not "recycled" to the last track on the disc.

Making a Forward Track Search:

Press the ►► button to display the desired track number.

Press once to fast forward to the next track, twice to fast forward to the track after that, and so forth.

Play starts at the beginning of the displayed track number.

NOTE

(For disc changers)

You cannot make a forward track search when listening to the last track on a disc.

Disc Search

Search forwards or backwards through the discs in a disc changer until you reach the one that you want to listen to.

Making a Reverse Disc Search:

Press the AM button to display the desired disc number.

Each time the button is pressed, the displayed disc number decreases by one.

Play starts at the beginning of the displayed disc.

Making a Forward Disc Search:

Press the FM button to display the desired disc number.

Each time the button is pressed, the displayed disc number increases by one.

Play starts at the beginning of the displayed disc.

NOTE

"Load" is displayed when discs are being exchanged on the disc changer.

Track / Disc Repeat

Repeat playing the current track or disc.

Turning Repeat Play Function On/Off:

Press the REP button to switch the repeat play function on and off as follows :

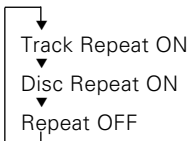

“Repeat ON”/“T-Repeat ON” is displayed and the track number blinks in the display when track repeat is on.
“Disc Repeat ON”/“D-Repeat ON” is displayed and the disc number blinks in the display when disc repeat is on.

NOTE

Repeat play is cancelled when you eject the disc.

Track Scan

Successively play the beginning of each track on a disc until you find the track that you want to listen to.

Starting the Track Scan:

Press the SCAN button. “Scan ON” is displayed and the first 10 seconds of each track are played, and the tracks are played in order.

The track number currently being heard blinks in the display.

Stopping to Listen to the Track Being Scanned:

Press the SCAN button again to stop the scan and keep on listening to a track normally.

NOTE

- The track scan function is cancelled when you eject the disc.
- The track scan function only scans each track on a disc once.

Random Play

Play all the tracks on the current disc in random order.

- 1 Press the RDM button to switch the random play function on and off.
“Random ON” is displayed when random play is turned on. The display of the track number changes continuously as the next track is being selected.
When the track has been selected, play starts.
The selected track number blinks in the display as it is being played.

NOTE

When all the tracks on a certain disc have been played using the random play function, the next disc on the changer starts playing (with the random play function still turned on).

- 2 To change the track being heard, press the ►► button.
Another track is selected and played.

NOTE

Random play is cancelled when you eject the disc.

External disc control features

Magazine Random Play

Play the tracks on all the discs in the disc changer in random order.

- 1 Press the M.RDM button to switch the magazine random play function on and off.
"M.Random ON" is displayed when magazine random play is turned on.
The display of the disc and track numbers change continuously as the next track is being selected.
When the disc/track has been selected, play starts.
The selected disc/track number blinks in the display as it is being played.
- 2 To change the track being heard, press the ►► button.
Another disc/track is selected and played.

NOTE

- Magazine random play is cancelled when you eject the disc.
- The time needed for random selection depends on the number of discs loaded in the disc magazine.

Text / Title Scroll

This function permits the text to be scrolled and the entire text to be displayed. The scrolling method differs depending on the setting of scrolling in the menu.

To scroll manually:

- 1 Press the DISP button to display the disc title or the track title.
- 2 Holding down the DISP button for one second or more results in one scrolling display of the titles.

To scroll automatically:

- 1 Press the DISP button to display the disc title or the track title.
The titles will be displayed in one scrolling display.

NOTE

When the disc or track to be played changes, the title is displayed in one scrolling display.

- 2 Holding down the DISP button for one second or more results in one scrolling display of the titles.

NOTE

- Please see the menu settings (page 32) about switching between manual scrolling and automatic scrolling.
- Only units with a CD text feature permit title display.
- You cannot use the text scroll function during magazine random play.

Presetting Disc Names (DNPS)

Store the names of discs to be displayed when played.

- 1 Play the disc whose name you want to preset.

NOTE

- This function is not available for disc changers that do not feature the Disc Name Preset function.
 - The Disc Name Preset function cannot be used during the Magazine random play as well as whilst a disc title or track title is displayed.
- 2 Hold down the NAME.S button for two seconds or more.
"NAME SET" is displayed and the disc name preset mode is entered.
The cursor blinks in the position where character input can be made.
 - 3 Press either the ◀◀ or ►► button to move the cursor to the desired position.
The ◀◀ button moves the cursor to the left, and the ►► button to the right.
 - 4 Each time the ►► button is pressed, the characters to be entered change as listed below.
Press the FM or AM button to display the desired character.

Characters that can be displayed are as follows.

- Alphabet (upper case): A ~ Z
- Alphabet (lower case): a ~ z
- Numerals and symbols: 0~9 @ " ' ` % & * + - = , . / \ < > []
- Special characters: á â é è ì í ó ô õ ù ñ ç ö ð ñ ò ñ ò ñ ò ñ ò ñ ò ñ

- 5 Continue steps 3 and 4 until all the characters are chosen for the name.
- 6 Press the NAME.S button.
The disc name is stored and the disc name preset mode is cancelled.
If you make no entry in a 10-second period, the name will be stored with the characters input so far.

NOTE

- The number of characters and discs whose names can be stored will differ depending on the disc changer that is connected. Please see your disc changer manual for details.
- Discs are identified by their total length and number of tracks. If another disc happens to have the same specifications as one that you have already stored a name for, the name will be displayed for it, too.
- If you want to change the name of a disc, repeat steps 1 and 2 to display the name, and then repeat steps 3 and 4 to input the changes.
- Pressing the reset button does not erase the disc names stored in a disc changer.

Menu settings

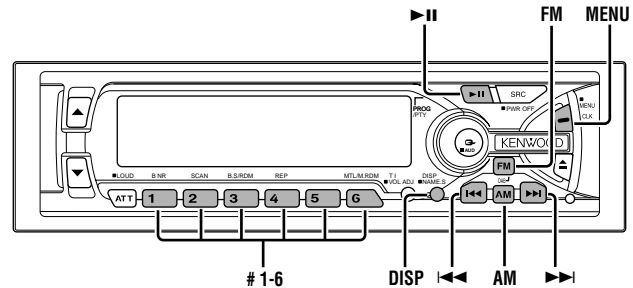

KRC-V679R

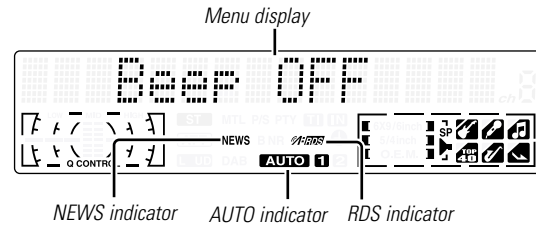

KRC-679R/KRC-579R/KRC-579B

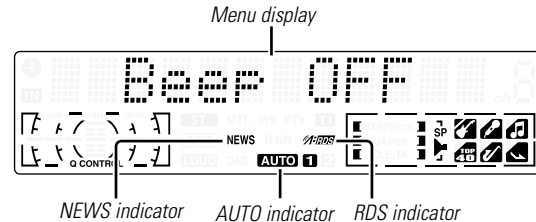

Menu settings

Menu System

You can set the defaults for additional functions in the menu mode. Make a setting for each function, referring to the following operations.

1 Enter the menu mode

Hold down the MENU button for one second or more. "MENU" is displayed when the menu mode is entered. The function that you can adjust is indicated with the current settings displayed.

2 Selecting function to set

Press the FM button to search through the functions until you see the one you want to adjust in the display. Press the AM button to search through the functions backward.

Function items change in the order of features that follow in the menu system.

Example: If you want to switch the setting of the touch sensor tone function from on to off, first search through the functions until you see "Beep ON" in the display.

3 Changing setting for currently displayed function

Press either the ◀◀ or ▶▶ button.

The setting will change for each function.

Example: The setting of the touch sensor tone will switch from on to off, and "Beep OFF" is displayed.

4 Ending the menu mode

Press the MENU button.

NOTE

Make sure to end the menu mode when finished.

If you fail to end the menu mode, several functions may not operate properly, including the Traffic Information function, the News Bulletin function with PTY news timeout setting, and the Alarm function.

Code Security Function

After a security code has been registered, power cannot be restored if the battery is disconnected from the unit unless the code is first input.

NOTE

All the steps in this procedure (1 through 7) must be completed before the code security function can be turned on. However, once the procedure is finished, it need not be repeated. Once the code security function has been activated, "Security" disappears from the MENU system. Note that it will no longer be possible to cancel this function afterwards.

- Press the SRC button repeatedly to select the standby mode. "ALL OFF" is displayed when the standby mode is selected.
- Hold down the MENU button for one second or more. "MENU" is displayed first and then "Security" is displayed.
- Hold down either the ◀◀ or ▶▶ button for two seconds or more. "ENTER" will appear in the display for one second, indicating the code setting mode has been entered. When "CODE" appears in the display, you can start inputting the code.
- Press the preset button and enter your security code. Use the security code shown on your Car Audio Passport. Example: Enter "3510" as your code, pressing the buttons as follows:

Step	Button to press	# Times pressed	Display
1	#1	4	"3"
2	#2	6	"5"
3	#3	2	"1"
4	#4	1	"0"

- Hold down the DISP button for three seconds or more. The security code will be set. "RE-ENTER" will appear in the display for one second, asking you to enter the code once again for confirmation. When

"CODE" appears in the display, you can start inputting the code.

- 6 Press the Preset button and input the security code again.
- 7 Hold down the DISP button again for three seconds or more. "APPROVED" will appear in the display, with the code security function turning on. From this point on, if the unit is disconnected from the battery, the security code must be entered the first time that the unit's power is turned on. "ENTER" and "CODE" will appear in the display, asking you to input the code.

NOTE

If you input an incorrect security code, the code setting mode will be cancelled automatically. Follow the steps from 3 to 7 above again.

If you press the RESET button or remove the battery:

The first time you turn the unit on again, "CODE" will appear in the display, asking you to input the security code.

Repeat steps 6 and 7 above, and input the security code.

You can start operating the unit again when "APPROVED" appears in the display.

NOTE

If you enter the wrong code, "Waiting" is displayed and you cannot make further input of the code for a fixed interval (see table below), which grows longer each time you enter the wrong code.

When "CODE" is displayed, you can make input again.

Number of wrong inputs	Interval until next input is allowed
1	-
2	5 minutes
3	1 hour
4	24 hours

The number of wrong inputs is displayed.

Touch Sensor Tone

This function produces a beep sound that accompanies button operation. It can be switched on or off.

Display and setting:

"Beep ON" : Beep setting is on. (Default setting)

"Beep OFF" : Beep setting is off.

NOTE

The beep sound is not output from the preout jacks.

Manual Time Adjustment

Adjust the time manually.

NOTE

This adjustment is available only when the automatic time adjustment is set to off. (page 28)

Display and setting:

- 1 Select the display "Clock Adjust" during the selecting function in the menu system.
- 2 Hold down either the ◀◀ or ▶▶ button for one second or more to enter the Manual time adjustment mode. The time display will blink.
- 3
 - Adjusting the hours
Press the FM button to advance the hours, or press the AM button to make the hours go back.
 - Adjusting the minutes
Press the ▶▶ button to advance the minutes, or press the ◀◀ button to make the minutes go back.
- 4 Press the MENU button to end the Manual Time Adjustment mode. Exiting the Manual Time Adjustment mode would start the clock counting.

Menu settings

Automatic Time Adjustment

With automatic time adjustment, you can set the clock time automatically according to time data sent from RDS stations (after receiving RDS signals for several minutes). You can also set the time manually if the automatic time adjustment function is turned off.

Display and setting:

"SYNC ON" : Automatic time adjustment (Default setting)

"SYNC OFF" : Manual time adjustment

Adjusting Time Automatically:

Tune into an RDS station for 3 or 4 minutes.

The time adjusts automatically to the correct local time.

NOTE

The time is not adjusted when the RDS station you are tuned to is not transmitting a time signal. Choose another RDS station in such a case.

Selectable Illumination

You can switch the colour of the button illumination between green and red.

Display and setting:

"Button Green" : The colour of the illumination is green.

"Button Red" : The colour of the illumination is red.

Switching Graphic Display

This function allows you to turn off the lower part of the display if there is too much information in the display.

Display and setting:

"Graphic ON" : The display will turn on by using the whole part of the display. (Default setting)

"Graphic OFF" : The display will turn on by using only the upper part of the display and the IN indicator .

Function of the KRC-V679R

Variable Illumination Colour Setting

You can set the display to a desired colour.

Display and setting:

- 1 Select the display "Color" during the selecting function in the menu mode.
- 2 **To set a colour manually:**
Hold down on the I◀◀ or ▶▶I button.
Pressing the ▶▶I button advances the colour, and pressing the I◀◀ button reverses it.
When the desirable colour is appeared, release the button.
- 3 **To make the popular colours appear:**
Press the preset button(#1-4) for the desired color.
The buttons #1-4 are preset for the following four colours:
#1: White
#2: Red
#3: Blue
#4: Blue Green
- 4 **To switch colours depending on the situation: (Situational Mode)**
Each time you press the #6 button, the mode switches as follows:

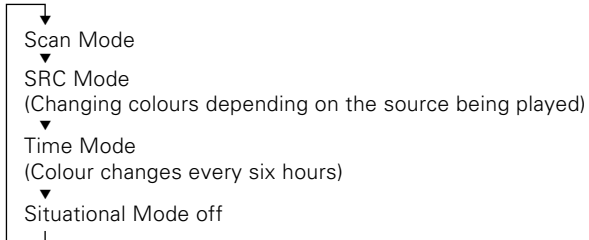

When the Situational Mode is off, the original colour setting resumes.

5 To finely adjust blue: (Blue Adjust Mode)

Press the #3 button for two seconds or more to enter the blue adjust mode.

The ◀◀ and ▶▶ buttons are used to adjust the blue color tones, respectively.

Press the #3 button to end the blue adjust mode.

6 To store the colour setting in the memory: (colour preset memory)

After adjusting the illumi colours, press the #5 button for two seconds to store the colour setting in the memory.

Pressing the #5 button again recalls the stored colours from the memory.

NOTE

The Blue Adjust mode setting cannot be stored in memory.

7 Press the MENU button to end the Variable Illumination Colour Setting mode.

Contrast Adjustment

This adjustment permits easy viewing of the display.

Display and setting:

"Contrast 0" – "Contrast 10"

NOTE

The initial setting value is "5".

Dimmer

You can dim the display.

NOTE

The dimmer function is not available for units if the dimmer cable is not connected.

Display and setting:

"Dimmer ON" : The dimmer setting is on. (Default setting)

"Dimmer OFF" : The dimmer setting is off.

Function of the KRC-V679R/KRC-679R

External Amp Control

Adjust the bass boost level of the external amplifier using the main unit.

Display and setting:

"AMP Bass FLT" : Bass boost level is flat. (Default setting)

"AMP Bass +6" : Bass boost level is low (+6dB).

"AMP Bass +12" : Bass boost level is high (+12dB).

NOTE

As of December 2000, the power amplifiers controllable by the main unit are as follows:

KAC-X501F/PS501F/X401M/PS401M/X301T/PS301T/X201T/PS201T

Menu settings

News Bulletin Function with PTY News Timeout Setting

You can arrange to have news bulletins interrupt your current listening source, including other radio stations. When the News Bulletin function is on, the PTY News Timeout setting allows you to set the interval during which further news interruption cannot take place. You can adjust the PTY news interruption period from 10 to 90 minutes for each journey.

Display and setting:

"News OFF" (Default setting) , "News 00min" - "News 90min"

(min= minutes)

: When you select the news interruption timeout interval, the News function turns on and the NEWS indicator lights up. When a news bulletin is received, "NEWS" will be displayed and reception will begin at the preset volume.

NOTE

- If you choose the "20min" setting, further news bulletins will not be received for 20 minutes once the first news bulletin is received.
- This function is only available if the desired station sends PTY-code for news bulletin or belongs to <Enhanced Other Network>-Network sending PTY-code for news bulletin.
- If you turn on the news bulletin function in the MW/LW band, the band is switched automatically to the FM band. However, the MW/LW band is not returned to when you turn off the function.

Local Seek Function <In Tuner mode>

With the local seek function turned on, auto seek tuning skips stations with relatively poor reception.

Display and setting:

"Local.S ON" : The local seek function is on.

"Local.S OFF" : The local seek function is off. (Default setting)

Selecting Tuning Mode <In Tuner mode>

You can choose from three tuning modes: auto seek, preset station seek, and manual. The "AUTO 1" indicator lights up when auto seek tuning is selected, and the "AUTO 2" indicator lights when preset station seek tuning is selected.

Display and setting:

"Auto 1" : Auto seek tuning mode (Default setting)

"Auto 2" : Preset station seek tuning mode

"Manual" : Manual tuning mode

Auto Memory Entry <In Tuner mode>

You can automatically store all the receivable frequencies in the band currently being listened to, and then recall them with the touch of a button later. This function is especially useful when you are travelling and do not know what stations are available. Up to 6 frequencies can be stored this way.

Display and setting:

- 1 Select the display "Auto-Memory" during the selecting function in the menu system.
- 2 Hold down either the ◀◀ or ▶▶ button for two seconds or more to start auto memory function.
The numbers of the preset station buttons showed in order. When all the stations in a certain band are stored in the preset memory, the auto memory entry stops. The tuner then plays the last station received.

NOTE

- When the AF function is turned on whilst auto memory entry takes place, only RDS stations (i.e., stations with RDS capability) are stored. RDS stations that have been preset for FM1 cannot also be preset in FM2 or FM3.
- When the local seek function is turned whilst auto memory entry takes place, stations with poor reception are not stored.
- When the Traffic Information function is on, only the local traffic

information station frequency will be stored.

Cancelling Auto Memory Entry During Its Operation:

Press the **I◀◀/▶▶I** button whilst auto memory entry is taking place to stop the process.

Recalling a Preset Station:

Press the preset station button (#1-6) for the desired station. The number of the recalled station is displayed.

AF (Alternative Frequency) Function

When poor reception is experienced, automatically switch to another frequency broadcasting the same programme in the same RDS network with better reception. The RDS indicator lights up when the AF function is turned on.

Display and setting:

"AF ON" : The AF function is on. (Default setting)

"AF OFF" : The AF function is off.

NOTE

When no other stations with stronger reception are available for the same programme in the RDS network, you may hear the incoming broadcast in bits and snatches. Turn off the AF function in such a case.

Restricting RDS Region (Region Restrict Function)

You can choose whether or not to restrict the RDS channels, received with the AF function for a particular network, to a specific region. When the Region Restrict Function is on, the region is restricted.

Display and setting:

"Regional ON" : The Region Restrict Function is on. (Default setting)

"Regional OFF" : The Region Restrict Function is off.

NOTE

Sometimes stations in the same network broadcast different programmes or use different programme service names.

Auto TP Seek Function

When the TI function is on and poor reception conditions are experienced when listening to a traffic information station, another traffic information station with better reception will be searched for automatically. This function is on, when unit is first powered on.

Display and setting:

"ATPS ON" : The Auto TP Seek Function is on.

If the traffic information station you are tuned to experiences poor reception, this function automatically seeks another TP station. (Default setting)

"ATPS OFF" : The Auto TP Seek Function is off.

Menu settings

Monaural Reception <In FM reception of Tuner mode>

When poor stereo reception is experienced, this function will reduce noise and improve listening conditions.

Display and setting:

“MONO ON” : The monaural reception is on.

“MONO OFF” : The monaural reception is off. (Default setting)

The Power OFF Timer function is enabled only after the security code (page 26) is set up.

Text Scroll <In FM or External disc control mode>

This function permits the CD text, MD title, and Radio text to be scrolled and the entire text to be displayed. Switching between manual scrolling and automatic scrolling is permitted.

Display and setting:

“Scroll Auto” : Automatic scrolling

“Scroll MANU/Scroll Manual” : Manual scrolling (Default setting)

Power OFF Timer

Set the time for the OFF Timer function activated when you selected Standby mode.

If the predefined time elapses, this unit's power is automatically turned off.

Display and setting:

“OFF ----” : Power OFF Timer function is cancelled.



“OFF 20min” : Unit's power goes OFF after 20 minutes.
(Default setting)

“OFF 40min” : Unit's power goes OFF after 40 minutes.

“OFF 60min” : Unit's power goes OFF after 60 minutes.

NOTE

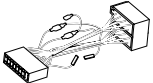
Accessories

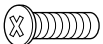
	External view	Number of items
①	1
②	2
③	1
④	1

▲CAUTION

The use of any accessories except for those provided might result in damage to the unit. Make sure only to use the accessories shipped with the unit, as shown above.

Installation Procedure

1. To prevent short circuits, remove the key from the ignition and disconnect the ⊖ terminal of the battery.
2. Make the proper input and output cable connections for each unit.
3. Connect the cable on the wiring harness.
4. Take Connector B on the wiring harness and connect it to the speaker connector in your vehicle.
5. Take Connector A on the wiring harness and connect it to the external power connector on your vehicle.
6. Connect the wiring harness connector to the unit.
7. Install the unit in your car.
8. Reconnect the ⊖ terminal of the battery.
9. Press the reset button.

▲CAUTION

- If your car is not prepared for this special connection-system, consult your Kenwood dealer.
- Only use antenna conversion adapters (ISO-JASO) when the antenna cord has an ISO plug.
- Make sure that all cable connections are securely made by inserting jacks until they lock completely.
- If your vehicle's ignition does not have an ACC position, or if the ignition cable is connected to a power source with constant voltage such as a battery cable, the power will not be linked with the ignition (i.e., it will not turn on and off along with the ignition). If you want to link the unit's power with the ignition, connect the ignition cable to a power source that can be turned on and off with the ignition key.
- If the fuse blows, first make sure that the cables have not caused a short circuit, then replace the old fuse with one with the same rating.
- Do not let unconnected cables or terminals touch metal on the car or anything else conducting electricity. To prevent short circuits, also do not remove the caps on the ends of the unconnected cables or the terminals.
- Connect the speaker cables correctly to the terminals to which they correspond. The unit may receive damage or fail to work if you share the ⊖ cables and/or ground them to any metal part in the car.
- After the unit is installed, check whether the brake lamps, indicators, wipers, etc. on the car are working properly.
- Insulate unconnected cables with vinyl tape or other similar material.
- Some disc changers need conversion cables for connection. See the section on "Safety Precautions" for details.
- If the console has a lid, make sure to install the unit so that the faceplate does not hit the lid when closing and opening.

Connecting Cables to Terminals

English

Connector Function Guide		
Pin Numbers for ISO Connectors	Cable Colour	Functions
External Power Connector		
A-4	Yellow	Battery
A-5	Blue/White	Power Control Dimmer
A-6	Orange/White	Ignition (ACC)
A-7	Red	Earth (Ground) Connection
A-8	Black	
Speaker Connector		
B-1	Purple	Rear Right (+)
B-2	Purple/Black	Rear Right (-)
B-3	Gray	Front Right (+)
B-4	Gray/Black	Front Right (-)
B-5	White	Front Left (+)
B-6	White/Black	Front Left (-)
B-7	Green	Rear Left (+)
B-8	Green/Black	Rear Left (-)

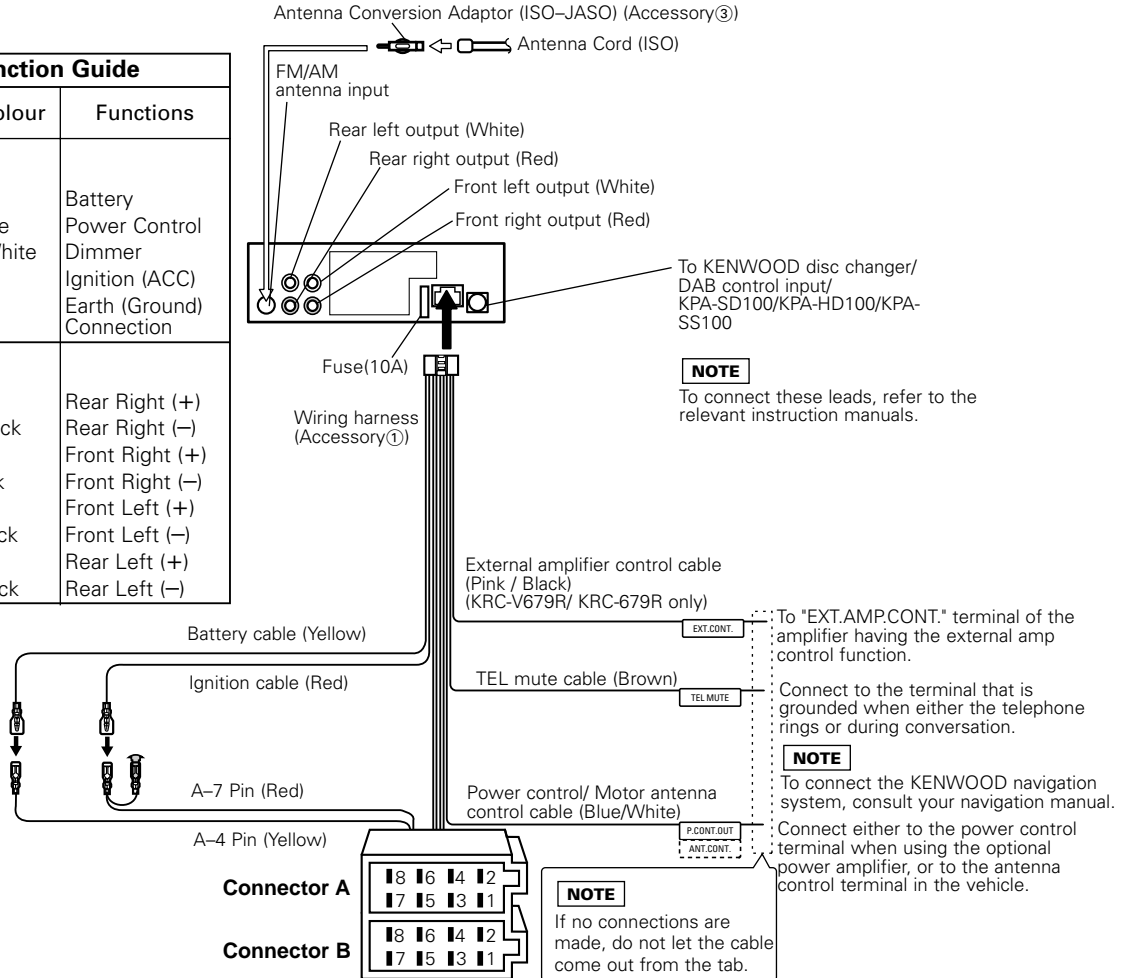

Connecting Cables to Terminals

⚠ WARNING Connecting the ISO Connector (see p.34)

The pin arrangement for the ISO connectors depends on the type of vehicle you drive. Make sure to make the proper connections to prevent damage to the unit.

The default connection for the wiring harness is described in 1 below. If the ISO connector pins are set as described in 2 or 3, make the connection as illustrated.

- 1 (Default setting) The A-7 pin (red) of the vehicle's ISO connector is linked with the ignition, and the A-4 pin (yellow) is connected to the constant power supply.

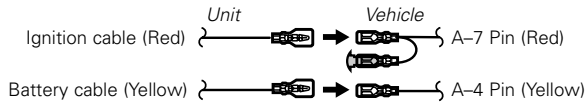

- 2 The A-7 pin (red) of the vehicle's ISO connector is connected to the constant power supply, and the A-4 pin (yellow) is linked to the ignition.

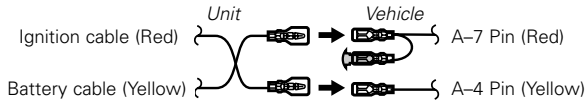

- 3 The A-4 pin (yellow) of the vehicle's ISO connector is not connected to anything, while the A-7 pin (red) is connected to the constant power supply (or both the A-7 (red) and A-4 (yellow) pins are connected to the constant power supply).

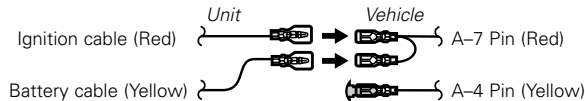

NOTE

When the connection is made as in 3 above, the unit's power will not be linked to the ignition key. For that reason, always make sure to turn off the unit's power when the ignition is turned off. To link the unit's power to the ignition, connect the ignition cable (ACC...red) to a power source that can be turned on and off with the ignition key.

Installation

■ Installation

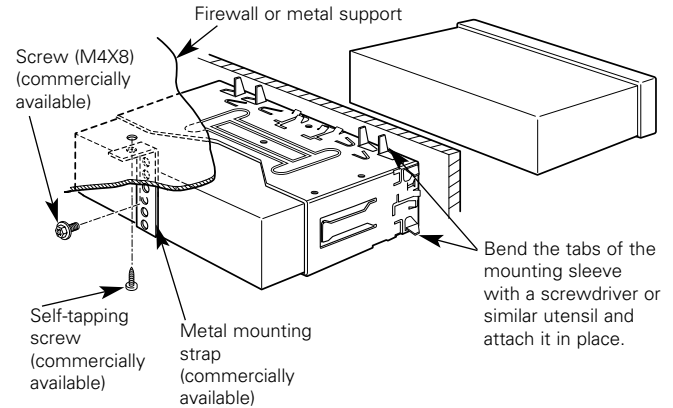

NOTE

Make sure that the unit is installed securely in place. If the unit is unstable, it may malfunction (eg, the sound may skip).

■ Removing the hard rubber frame

- 1 Refer to the section "Theft deterrent faceplate (P. 10)" and then remove the faceplate.
- 2 Engage the catch pins on the removal tool and remove the two locks on the upper level. Push upward the frame and pull it forward as shown in the figure.

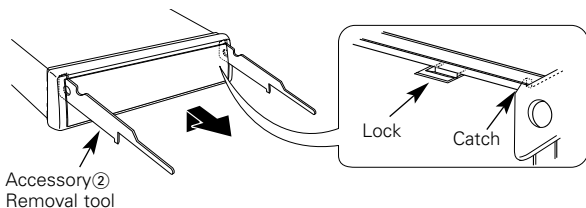

- 3 When the upper level is removed, remove the lower two locations.

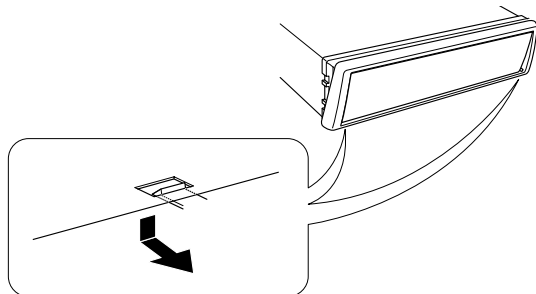

NOTE

The frame can be removed from the bottom side in the same manner.

■ Removing the Unit

- 1 Refer to the section "Removing the hard rubber frame (P. 36)" and then remove the hard rubber frame.
- 2 Remove the Hex-head screw with integral washer (M4x8) on the back panel.
- 3 Insert the two removal tools deeply into the slots on each side, as shown.

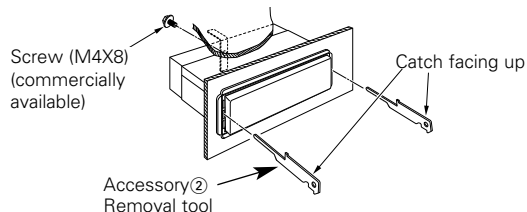

- 4 Push upward the removal tool toward the top, and pull out the unit halfway whilst pressing towards the inside.

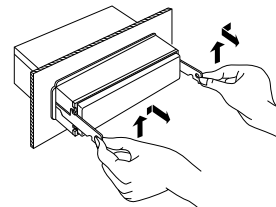

CAUTION

Be careful to avoid injury from the catch pins on the removal tool.

- 5 Pull the unit all the way out with your hands, being careful not to drop it.

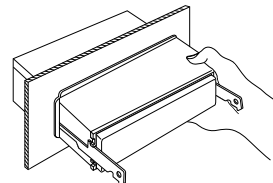

■ Locking the faceplate to the unit

If you want to lock the faceplate to the unit so that it does not fall off, follow the directions below.

- 1 Refer to the function "Theft deterrent faceplate" (page 10) and remove the faceplate.
- 2 Insert the provided screw into the hole at the centre of the bottom side of the faceplate which you have removed from the unit.

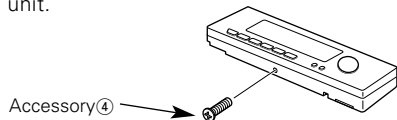

- 3 Push back the bottom of the faceplate bracket unit it locks.
- 4 Refer to the section "Theft deterrent faceplate (page 10)" and then reattaching the faceplate.

▲CAUTION

Never insert the tapite screws ($\varnothing 2 \times 4$ mm) in any other screw holes than the one specified. If you insert it in another hole, it will contract and may cause damage to the mechanical parts inside the unit.

Troubleshooting Guide

What might appear to be a malfunction in your unit may just be the result of slight misoperation or miswiring. Before calling service, first check the following table for possible problems.

PROBLEM	POSSIBLE CAUSE	SOLUTION
The power does not turn on.	The fuse has blown.	After checking for short circuits in the cables, replace the fuse with one having the same rating.
	No ACC position on vehicle ignition.	Connect the same cable to the ignition as the battery cable.
If you have selected Standby mode, the power will go OFF automatically.	The Power Off Timer function has been activated.	If you do not want the power to go OFF automatically, cancel the Power Off Timer function.
Nothing happens when the buttons are pressed.	The computer chip in the unit is not functioning normally.	Press the reset button on the unit (see page 4).
Radio reception is poor.	The car antenna is not extended.	Pull out the antenna all the way.
	The antenna control cable is not connected.	Connect the cable correctly, referring to the section on "Connecting Cables to Terminals".
The memory is erased when the ignition is turned off.	The battery cable has not been connected to the proper terminal.	Connect the cable correctly, referring to the section on "Connecting Cables to Terminals".
	The ignition and battery cable are incorrectly connected.	Connect the cable correctly, referring to the section on "Connecting Cables to Terminals".
The TEL mute function does not work.	The TEL mute cable is not connected properly.	Connect the cable correctly, referring to the section on "Connecting Cables to Terminals".
The TEL mute function turns on even though the TEL mute cable is not connected.	The TEL mute cable is touching a metal part of the car.	Pull the TEL mute cable away from the metal part of the car.
Free switching of the sound quality.	The system Q function is set on Scan mode.	Refer to the "System Q" page and switch it to a function other than Scan mode. (see p. 7).
Audio control setting cannot be achieved.	The system Q function is set on Scan mode.	Refer to the "System Q" page and switch it to a function other than Scan mode.(see p. 7).

Troubleshooting Guide

PROBLEM	POSSIBLE CAUSE	SOLUTION
No sound can be heard, or the volume is low.	The Attenuator function is turned on.	Turn off the Attenuator function.
	The fader and/or balance settings are set all the way to one side.	Reset the fader and/or balance settings.
	The input/output cables or wiring harness are connected incorrectly.	Reconnect the input/output cables and/or the wiring harness correctly. See the section on "Connecting Cables to Terminals".
	The cassette tape is bad.	Try playing another cassette tape. If no problem is experienced, the first tape was bad.
	The values of Volume offset are low.	Increase the values of Volume offset. (see p. 8)
The tape does not go in. / No sound can be heard even though the tape display is made.	The car ignition was turned off during tape eject; or the tape was pulled out during loading, switching the mode to tape mode even though no tape is in.	Press the Eject button.
The sound quality is poor or distorted.	The tape head is dirty.	Clean the tape head, referring to the section on "Cleaning the tape head" (see page 4).
	A speaker cable may be pinched by a screw in the car.	Check the speaker wiring.
	The speakers are not wired correctly.	Reconnect the speaker cables so that each output terminal is connected to a different speaker.
Can't remove tape.	The cause is that more than 10 minutes has elapsed since the vehicle ACC switch was turned OFF.	The tape can only be removed within 10 minutes of the ACC switch being turned OFF. If more than 10 minutes has elapsed, turn the ACC switch ON again and press the Eject button.

External disc control mode

PROBLEM	POSSIBLE CAUSE	SOLUTION
The disc control mode cannot be selected.	No cable has been connected to the disc changer input terminal on the unit.	Connect the cable to the disc changer input terminal on the unit.
The specified disc does not play, but another one plays instead.	The specified CD is very dirty.	Clean the CD.
	The CD is upside-down.	Load the CD with the labelled side up.
	The disc is loaded in a different slot from that specified.	Eject the disc magazine and check the number for the specified disc.
	The disc is severely scratched.	Try another disc instead.
The sound skips.	Something is touching the disc changer.	Remove whatever is touching it.
	The CD is scratched or dirty.	If skipping happens at the same place when the car is stopped, something is wrong with the CD. Clean the CD.
The display shows that the changer is being played, but no sound can be heard.	The computer chip in the unit is not functioning normally.	Press the reset button on the unit (see page 4).
The specified track does not play.	Random play or magazine random play has been selected.	Turn off the random play or magazine random play function.
Track repeat, disc repeat, track scan, random play, and magazine random play start by themselves.	The setting is not cancelled.	The settings for these functions remain on until the setting to off or the disc ejected, even if the power is turned off or the source changed.
Cannot play CD-R or CD-RW	Finalization processing is not being conducted for CD-R/CD-RW.	Conduct finalization processing with CD recorder.
	A non-compatible CD changer is being used to play the CD-R/CD-RW.	Use a CD changer compatible with CD-R/CD-RW to play.

If the following situations, consult your nearest service centre:

- Even though the disc changer is connected, the Disc Changer Mode is not on, with "AUX" showing in the display during the Changer Mode.
- Even though no device (KCA-S210A, CA-C1AX, KDC-CPS87, KDC-CX87, KDC-CPS85, KDC-CX85, KDC-CPS82 or KDC-CX82) is connected, the AUX Mode is entered when switching modes.

Troubleshooting Guide

The following messages are displayed when certain problems are occurring in your system. Take the recommended actions.

Eject	No disc magazine has been loaded in the changer. The disc magazine is not completely loaded. ⇒ Load the disc magazine properly. No CD in the unit. ⇒ Insert the CD.
No Disc	No disc has been loaded in the disc magazine. ⇒ Load a disc into the disc magazine.
TOC Error	No disc has been loaded in the disc magazine. ⇒ Load a disc into the disc magazine. The CD is very dirty. The CD is upside-down. The CD is scratched a lot. ⇒ Clean the CD and load it correctly.
Blank Disc	Nothing has been recorded on the MD.
No Tr Disc	No tracks are recorded on the MD, although it has a title.
NO PANEL	The faceplate of the slave unit being connected to this unit has been removed. ⇒ Replace it.
E-77	The unit is malfunctioning for some reason. ⇒ Press the reset button on the unit. If the "E- 77", code does not disappear, consult your nearest service centre.
Mecha Error	Something is wrong with the disc magazine. Or the unit is malfunctioning for some reason. ⇒ Check the disc magazine. And then, press the reset button on the unit. If the "Mecha Error" code does not disappear, consult your nearest service center.
Hold Error	The protective circuit in the unit activates when the temperature inside the automatic disc changer exceeds 60°C (140°F), stopping all operation. ⇒ Cool down the unit by opening the windows or turning on the air conditioner. As the temperature falls below 60°C (140°F), the disc starts playing again.
IN	If this indicator continues blinking, it is possible that the tape has become jammed or tangled. ⇒ Contact the Kenwood dealer if the tape cassette cannot be ejected.

Specifications

Specifications subject to change without notice.

FM tuner section

Frequency range (50 kHz space)	87.5 MHz – 108.0 MHz
Usable sensitivity (S/N = 26dB)	0.7 μ V/75 Ω
Quieting Sensitivity (S/N = 46dB)	1.6 μ V/75 Ω
Frequency response (± 3 dB)	30 Hz – 15 kHz
Signal to Noise ratio (MONO)65 dB
Selectivity (DIN) (± 400 kHz)	≥ 80 dB
Stereo separation (1 kHz)35 dB

MW tuner section

Frequency range (9 kHz Space)	531 kHz – 1611 kHz
Usable sensitivity (S/N = 20dB)25 μ V

LW tuner section

Frequency range	153 kHz – 281 kHz
Usable sensitivity (S/N = 20dB)45 μ V

Cassette player section

Tape Speed	4.76 cm/sec.
Wow & Flutter (WRMS)	0.08 %
Frequency response (± 3 dB) (70 μ s)	30 Hz – 20 kHz
Separation (1 kHz)43 dB
Signal to Noise ratio	
Dolby NR OFF57 dB
Dolby B NR ON65 dB

Audio section

Maximum output power	47 W \times 4
Output power (DIN 45324, +B=14.4V)	29 W \times 4
Tone action	
Bass :	100 Hz ± 10 dB
Middle :	1 kHz ± 10 dB
Treble :	10 kHz ± 10 dB
Preout level / Load (during disc play)	1800 mV / 10 k Ω
Preout impedance	$\leq 600 \Omega$

General

Operating voltage (11 – 16V allowable)	14.4 V
Current consumption	10 A
Installation Size (W x H x D)	182 x 53 x 158 mm
Weight	1.5 kg

KENWOOD

Free Manuals Download Website

<http://myh66.com>

<http://usermanuals.us>

<http://www.somanuals.com>

<http://www.4manuals.cc>

<http://www.manual-lib.com>

<http://www.404manual.com>

<http://www.luxmanual.com>

<http://aubethermostatmanual.com>

Golf course search by state

<http://golfingnear.com>

Email search by domain

<http://emailbydomain.com>

Auto manuals search

<http://auto.somanuals.com>

TV manuals search

<http://tv.somanuals.com>