

STEREO CASSETTE TAPE DECK

KX-W6030

INSTRUCTION MANUAL

KENWOOD CORPORATION

KENWOOD

Introduction

Your choice of this product indicates that you are a devotee to excellence in sound reproduction.

We appreciate your patronage and take pride in the long tradition of quality components that our company represents.

So that you can get the most out of your unit, we suggest that you take the time to read through this manual before you hook up and operate your system. This will acquaint you with operating features and system-connection considerations so that your listening pleasure will be enhanced right from the start. You will notice that in all aspects of planning, engineering, styling, operating convenience and adaptability we have sought to anticipate your needs and desires.

Keep this manual handy for future reference.

For your records

Record the serial number, found on the back of the unit, in the spaces designated on the warranty card, and in the space provided below. Refer to the model and serial numbers whenever you call upon your dealer for information or service on this product.

Model _____ Serial Number _____

Unpacking

Unpack the unit carefully and make sure that all accessories are put aside so they will not be lost.

Examine the unit for any possibility of shipping damage. If your unit is damaged or fails to operate, notify your dealer immediately. If your unit was shipped to you directly, notify the shipping company without delay. Only the consignee (the person or company receiving the unit) can file a claim against the carrier for shipping damage.

We recommend that you retain the original carton and packing materials for use should you transport or ship the unit in the future.

WARNING NOTICE:

IN MOST CASES IT IS AN INFRINGEMENT OF COPYRIGHT TO MAKE COPIES OF TAPES OR DISCS WITHOUT THE PERMISSION OF THE COPYRIGHT OWNERS. ANYONE WISHING TO COPY COMMERCIALY AVAILABLE TAPES OR DISCS SHOULD CONTACT THE MECHANICAL COPYRIGHT PROTECTION SOCIETY LIMITED OR THE PERFORMING RIGHTS SOCIETY LIMITED.

Dolby noise reduction manufactured under license from Dolby Laboratories Licensing Corporation.
"DOLBY" and the double-D symbol  are trademarks of Dolby Laboratories Licensing Corporation.

Accessories

Audio cord 2



System control cord..... 1

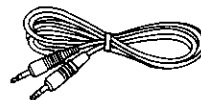

Contents

Caution: Read the pages marked  carefully to ensure safe operation.

Introduction.....	2	DPSS operation	12
▲ Before applying power	3	How to record	13
▲ Safety precautions.....	3	Synchro recording	16
▲ IMPORTANT SAFEGUARDS	4	Recording of CD playback (CCRS).....	18
Before operation	6	Tape dubbing operation.....	20
System connections.....	7	Timer operations	21
Controls and indicators	8	In case of difficulty.....	23
Listening to cassette tapes.....	10	Specifications	25

Before applying power

For the U.S.A. and Canada

Important!

Units shipped to the U.S.A. and Canada are designed for operation on 120 volts AC only.

CAUTION: TO PREVENT ELECTRIC SHOCK DO NOT USE THE AC PLUG WITH AN EXTENSION CORD, RECEPTACLE OR OTHER OUTLET UNLESS THE BLADES CAN BE FULLY INSERTED TO PREVENT BLADE EXPOSURE.

For Australia and Europe

Important!

Units shipped to Australia are designed for operation on 240 V AC only.

Units shipped to Europe are designed for operation on 230 V AC only.

For the United Kingdom

Important!

Units shipped to the U.K. are designed for operation on 240 volts AC only.

The mains plug must be removed from the wall socket prior to any internal examination.

The wires in this mains lead are coloured in accordance with the following code:

Blue Neutral
Brown Live

The wires in this mains lead must be connected to the terminals in the plug as follows:

Wire colour	Plug terminal marking
Blue	N or Black
Brown	L or Red

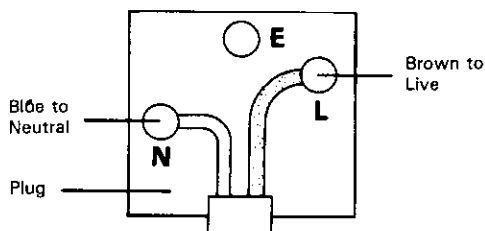

Notes:

1. If a 13-amp plug is used, this must be fitted with a 5-amp fuse.
2. If a 3-pin plug with earthing contact is used, no wire must be connected to the E terminal.

For other countries

Important!

Units shipped to countries other than the above countries are equipped with an AC voltage selector switch on the rear panel. Refer to the following paragraph for the proper setting of this switch.

AC voltage selection

This unit operates on 110-120 or 220-240 volts AC. The AC voltage selector switch Type A or Type B on the rear panel is set to the voltage that prevails in the area to which the unit is shipped. Before connecting the power cord to your AC outlet, make sure that the setting position of this switch matches your line voltage. If not, it must be set to your voltage in accordance with the following direction.

Note:

Our warranty does not cover damage caused by excessive line voltage due to improper setting of the AC voltage selector switch.

AC voltage selector switch

Type A

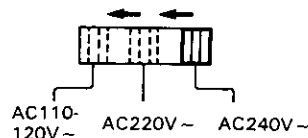



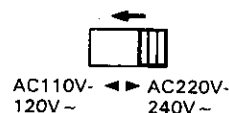

Type B



Move switch lever to match your line voltage with a small screwdriver or other pointed tool.

Safety precautions

WARNING: TO PREVENT FIRE OR ELECTRIC SHOCK, DO NOT EXPOSE THIS APPLIANCE TO RAIN OR MOISTURE.

 <div data-bbox="251 1596 503 1690" style="border: 1px solid black; padding: 5px; text-align: center;"> <p>CAUTION RISK OF ELECTRIC SHOCK DO NOT OPEN</p> </div> 	<p>CAUTION: TO REDUCE THE RISK OF ELECTRIC SHOCK, DO NOT REMOVE COVER (OR BACK). NO USER-SERVICEABLE PARTS INSIDE, REFER SERVICING TO QUALIFIED SERVICE PERSONNEL.</p>
	<p>THE LIGHTNING FLASH WITH ARROWHEAD SYMBOL, WITHIN AN EQUILATERAL TRIANGLE, IS INTENDED TO ALERT THE USER TO THE PRESENCE OF UNINSULATED "DANGEROUS VOLTAGE" WITHIN THE PRODUCT'S ENCLOSURE THAT MAY BE OF SUFFICIENT MAGNITUDE TO CONSTITUTE A RISK OF ELECTRIC SHOCK TO PERSONS.</p>
	<p>THE EXCLAMATION POINT WITHIN AN EQUILATERAL TRIANGLE IS INTENDED TO ALERT THE USER TO THE PRESENCE OF IMPORTANT OPERATING AND MAINTENANCE (SERVICING) INSTRUCTIONS IN THE LITERATURE ACCOMPANYING THE APPLIANCE.</p>

IMPORTANT SAFEGUARDS

 **Caution : Read this page carefully to ensure safe operation.**

Please read all of the safety and operating instructions before operating this unit. For best results, follow all warnings placed on the unit and adhere to the operating and use instructions. These safety and operating instructions should be retained for future reference.

1. Power sources — The unit should be connected to a power supply only of the type described in the operating instructions or as marked on the appliance.

2. Power-cord protection — Power-supply cords should be routed so that they are not likely to be walked on or pinched by items placed upon or against them, pay particular attention to cords at plugs, convenience receptacles, and the point where they exit from the unit.

Never pull or stretch the cord.

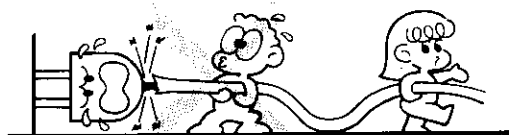

3. Grounding or polarization — The precautions should be taken so that the grounding or polarization means of this unit is not defeated.

4. Ventilation — The unit should be situated so that its location or position does not interfere with its proper ventilation.

To maintain good ventilation, do not put records or a table-cloth on the unit. Place the unit at least 10 cm away from the walls.

Do not use the unit on a bed, sofa, rug or similar surface that may block the ventilation openings.

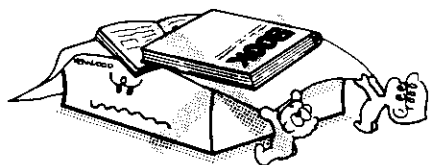

5. Water and moisture — The unit should not be used near water — for example, near a bathtub, washbowl, kitchen sink, laundry tub, in a wet basement, or near a swimming pool, etc.

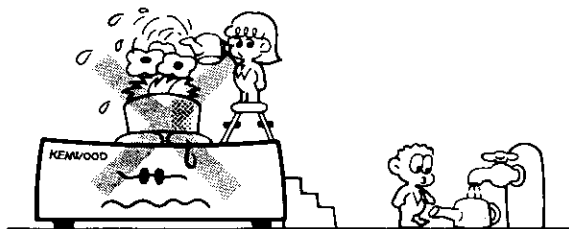

6. Temperature — The unit may not function properly if used at extremely low, or freezing temperatures. The ideal ambient temperature is above +5°C (41°F).

7. Heat — The unit should be situated away from heat sources such as radiators, heat registers, stoves, or other units (including amplifiers) that produce heat.

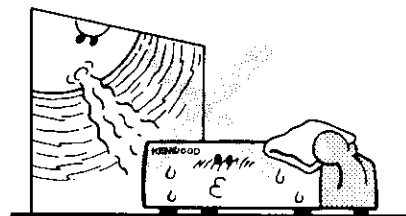

8. Electric shock — Care should be taken so that objects do not fall and liquid is not spilled into the enclosure through openings. If a metal object, such as a hair pin or a needle, comes into contact with the inside of this unit, a dangerous electric shock may result. For families with children, never permit children to put anything, especially metal, inside this unit.

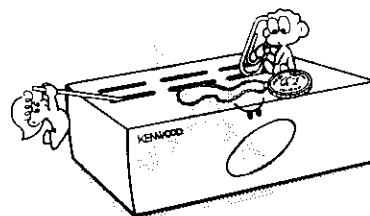

9. Enclosure removal — Never remove the enclosure. If the internal parts are touched accidentally, a serious electric shock might occur.

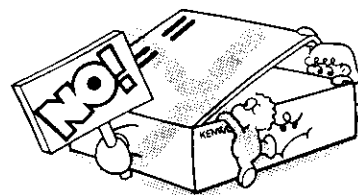

10. Magnetic fields — Keep the unit away from sources of magnetic fields such as TV sets, speaker systems, radios, motorized toys or magnetized objects.

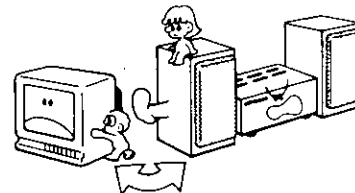

11. Cleaning — Do not use volatile solvents such as alcohol, paint thinner, gasoline, or benzine, etc. to clean the cabinet. Use a clean dry cloth.

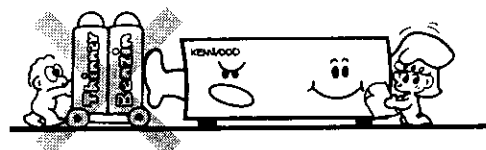

12. Carts and stands — An appliance and cart combination should be moved with care. Quick stops, excessive force, and uneven surfaces may cause the appliance and cart combination to overturn.



13. Nonuse periods — The power cord of the unit should be unplugged from the outlet when left unused for a long period of time.

14. Abnormal smell — If an abnormal smell or smoke is detected, immediately turn the power OFF and pull out the power cord. Contact your dealer or nearest service center.

POWER OFF!

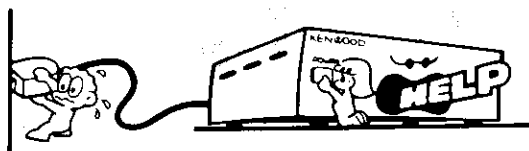

15. Damage requiring service — The unit should be serviced by qualified service personnel when:

- A.** The power-supply cord or the plug has been damaged; or
- B.** Objects have fallen, or liquid has been spilled into the unit; or
- C.** The unit has been exposed to rain; or
- D.** The unit does not appear to operate normally or exhibits a marked change in performance; or
- E.** The unit has been dropped, or the enclosure damaged.

16. Servicing — The user should not attempt to service the unit beyond that described in the operating instructions. All other servicing should be referred to qualified service personnel.

17. Outdoor antenna grounding — If an outside antenna is connected to the receiver, be sure the antenna system is grounded so as to provide some protection against voltage surges and built up static charges. Section 810 of the National Electrical Code, ANSI/ NFPA No. 70—1984, provides information with respect to proper grounding of the mast and supporting structure, grounding of the lead-in wire to an antenna discharge unit, size of grounding con-

ductors, location of antenna-discharge unit, connection to grounding electrodes, and requirements for the grounding electrode. See Figure.

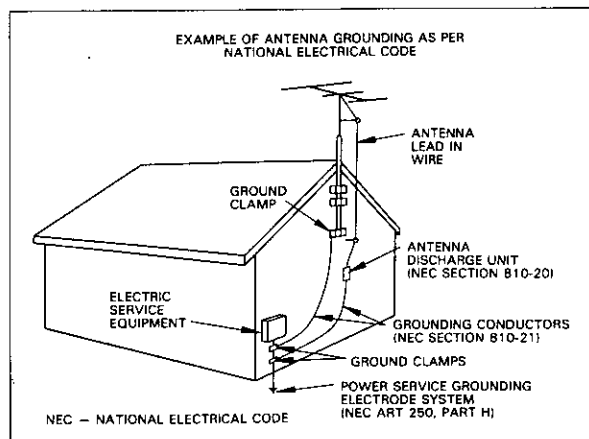

18. Power lines — An outdoor antenna should be located away from power lines.

Notes:

- 1. Item 3 is not required except for grounded or polarized equipment.**
- 2. Item 17 and 18 are not required except for units provided with antenna terminals.**
- 3. Item 17 complies with UL in the U.S.A.**

Before operation

Notes on cassette tape

Safety tab (accidental erasure prevention tab)

After an important recording has been finished, break the safety tab, to prevent the recorded contents from being erased or recorded on accidentally.

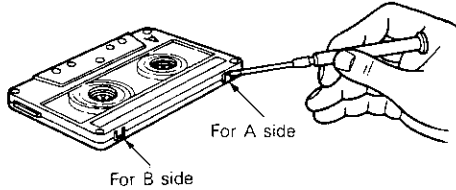

To store cassette tapes

Do not store the tapes in a place which is subject to direct sunlight, or near equipment that generates heat. Keep the cassette tapes away from any magnetic field.

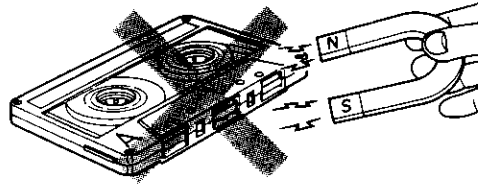

When there is slack in the tape

In such a case, insert a pencil into the reel hole and wind the reel hub to remove the slack.

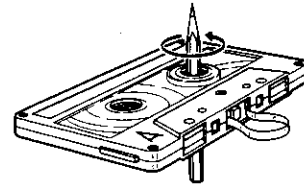
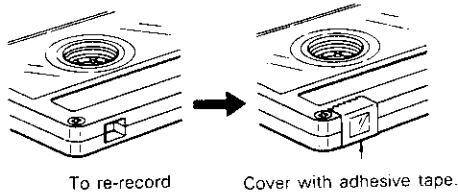

Notes:

1. 120-minute cassette tape

Since a 120-minute cassette tape is very thin, the tape could adhere to the pinch roller or be easily cut. It is recommended that these tapes not be used with this unit to prevent possible damage.

2. Endless tapes

Do not use an endless tape, as this could damage the mechanism of the unit.

Cleaning the head section

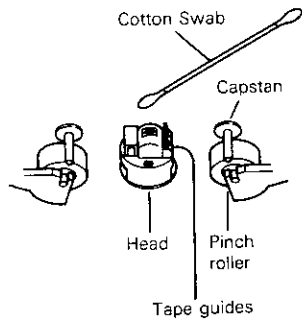

Cleaning the heads and peripheral components

For maintaining the best condition of the deck and for longer service life, always keep the head (recording/playback/erase), capstan and pinch roller clean. To clean them, perform the following:

1. Open the cassette holder.
2. Using a cotton swab dipped in alcohol, clean the head (recording/playback/erase), capstan and pinch roller carefully.

Demagnetizing the head

When the recording/playback head is magnetized, the sound quality will be deteriorated. In such a case, demagnetize the head using a commercially available demagnetizer (head eraser).

Note:

There are precisely aligned parts around the heads, including the tape guides.

When cleaning, pay special attention so as not to apply shock to them.

Beware of condensation

When water vapor comes into contact with the surface of cold material, water drops are produced.

If condensation occurs, correct operation may not be possible, or the unit may not function correctly.

This is not a malfunction, however, and the unit should be dried. (To do this, turn the POWER switch ON and leave the unit as it is for several hours.)

Be specially careful in the following conditions:

- When the unit is brought from a cold place to a warm place, and there is a large temperature difference.
- When a heater starts operating.
- When the unit is brought from an air-conditioned place to a place of high temperature with high humidity.
- When there is a large difference between the internal temperature of the unit and ambient temperature, or in conditions where condensation occurs easily.

System connections

Make connection as shown below. When connecting the related system components, refer also to the instruction manuals of the related components.

Do not plug in the power lead until all connections are completed.

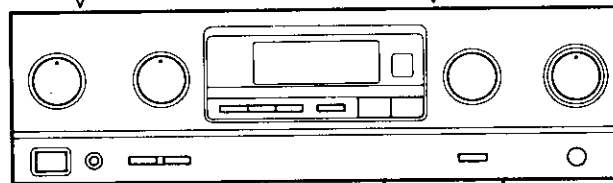
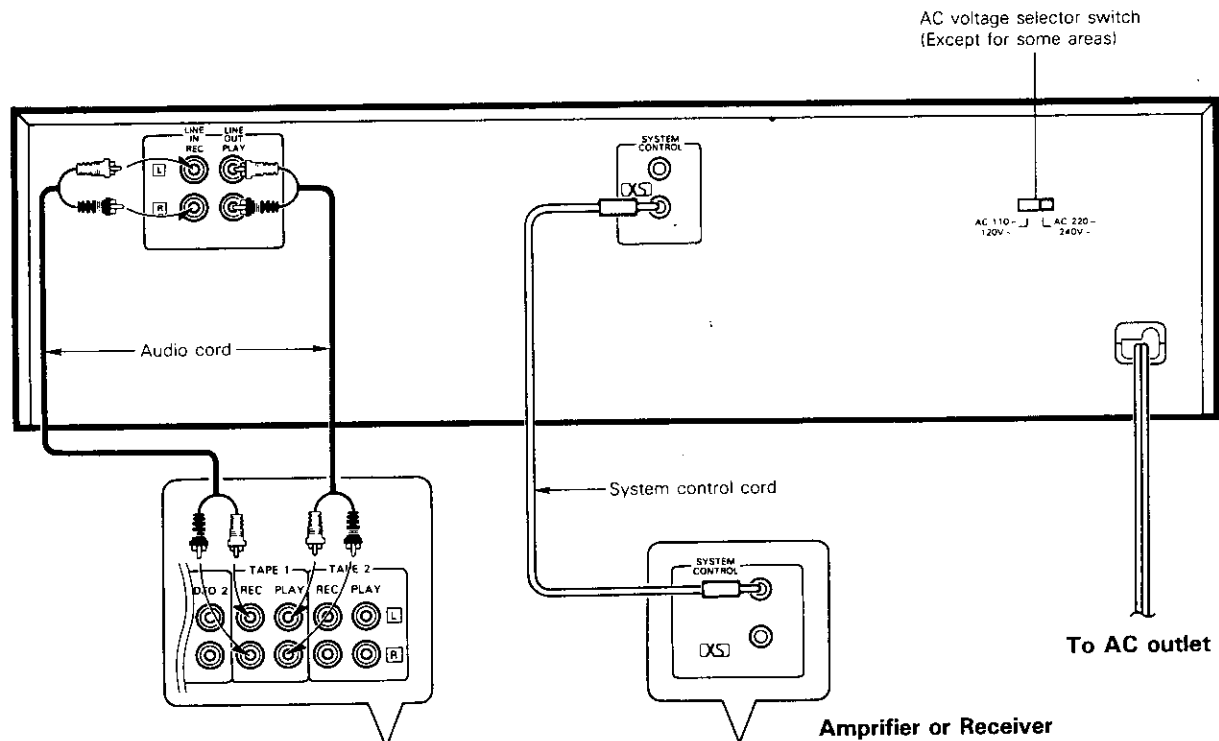

Amplifier or Receiver

Turntable

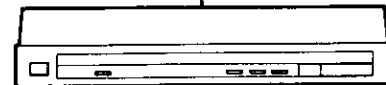

CD player



System control connection

When connected to an amplifier or receiver having KENWOOD SYSTEM CONTROL terminals, system operation such as remote control is made possible. For details, refer to the instruction manual of the amplifier or receiver. In addition, when system control cords are also connected to the CD player or turntable, other functions such as synchro recording (see page 16) and CCRS recording (see page 18) become possible.

If your amplifier or receiver is not equipped with the SYSTEM CONTROL terminals, do not connect anything to any SYSTEM CONTROL terminal.

Do not connect the unit in any system configuration other than specified.

X

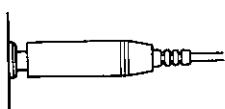

O

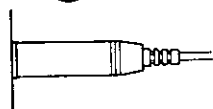

- Be sure to insert the system control cord plugs fully into the SYSTEM CONTROL terminals.
- If the system control cord and audio cords are not connected properly, the automatic system governing remote control and system functions will not operate.

Notes:

1. Connect all cords firmly. If connections are loose there could be loss of sound or noise produced.
2. When plugging and unplugging connection cords, be sure to first remove the power cord from the AC outlet. Plugging/unplugging connection cords without removal of the power cord can cause malfunctions or damage to the unit.

Controls and indicators

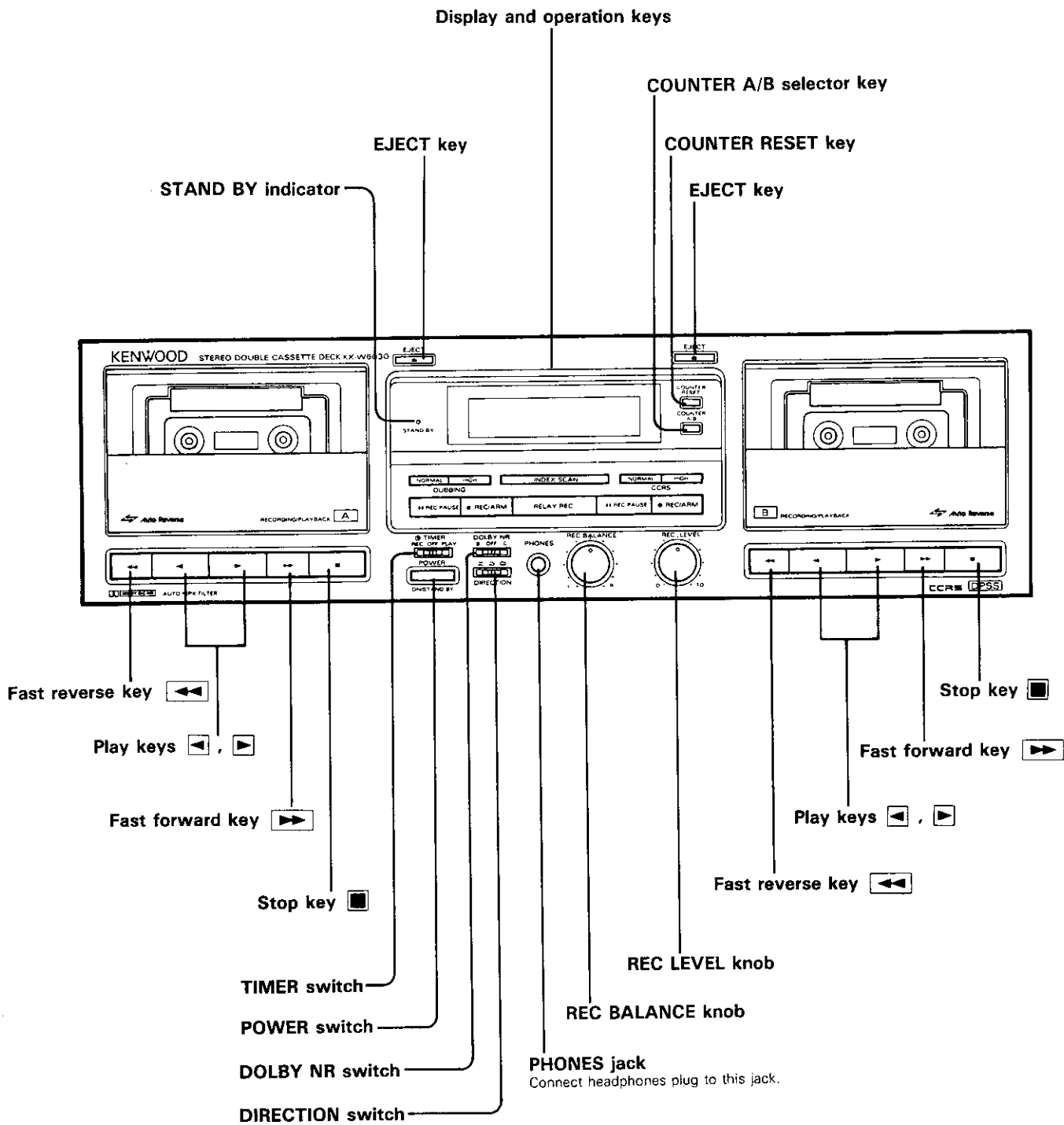

STAND BY mode of POWER switch

When the power cord of this unit is plugged into an AC outlet, the STAND BY indicator lights up regardless of the ON/OFF setting of the POWER switch. This indicates that a small amount of current is being supplied to the unit to back up the memory contents. This mode is referred to as the Stand By mode.

■ Display section

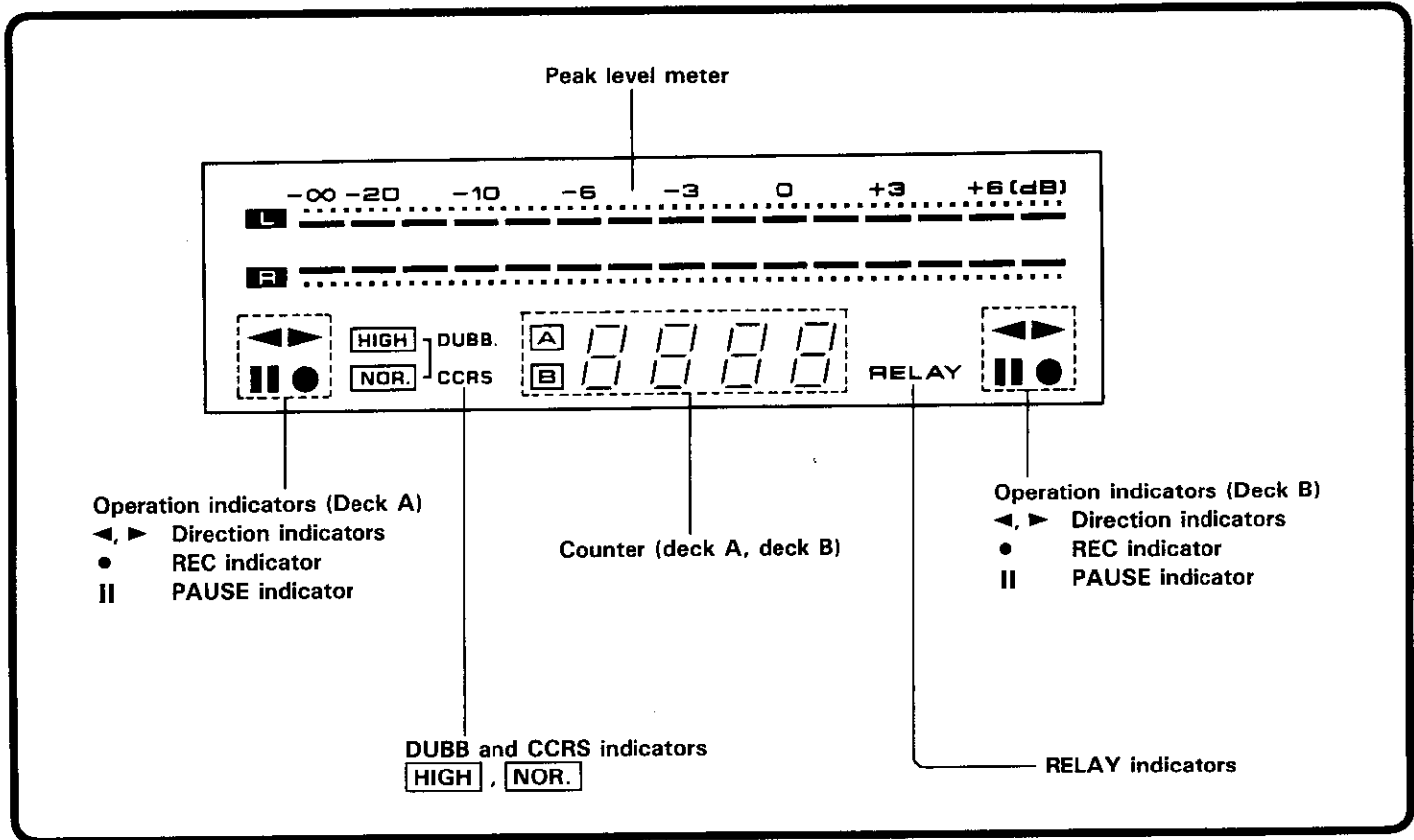

■ Operation key section

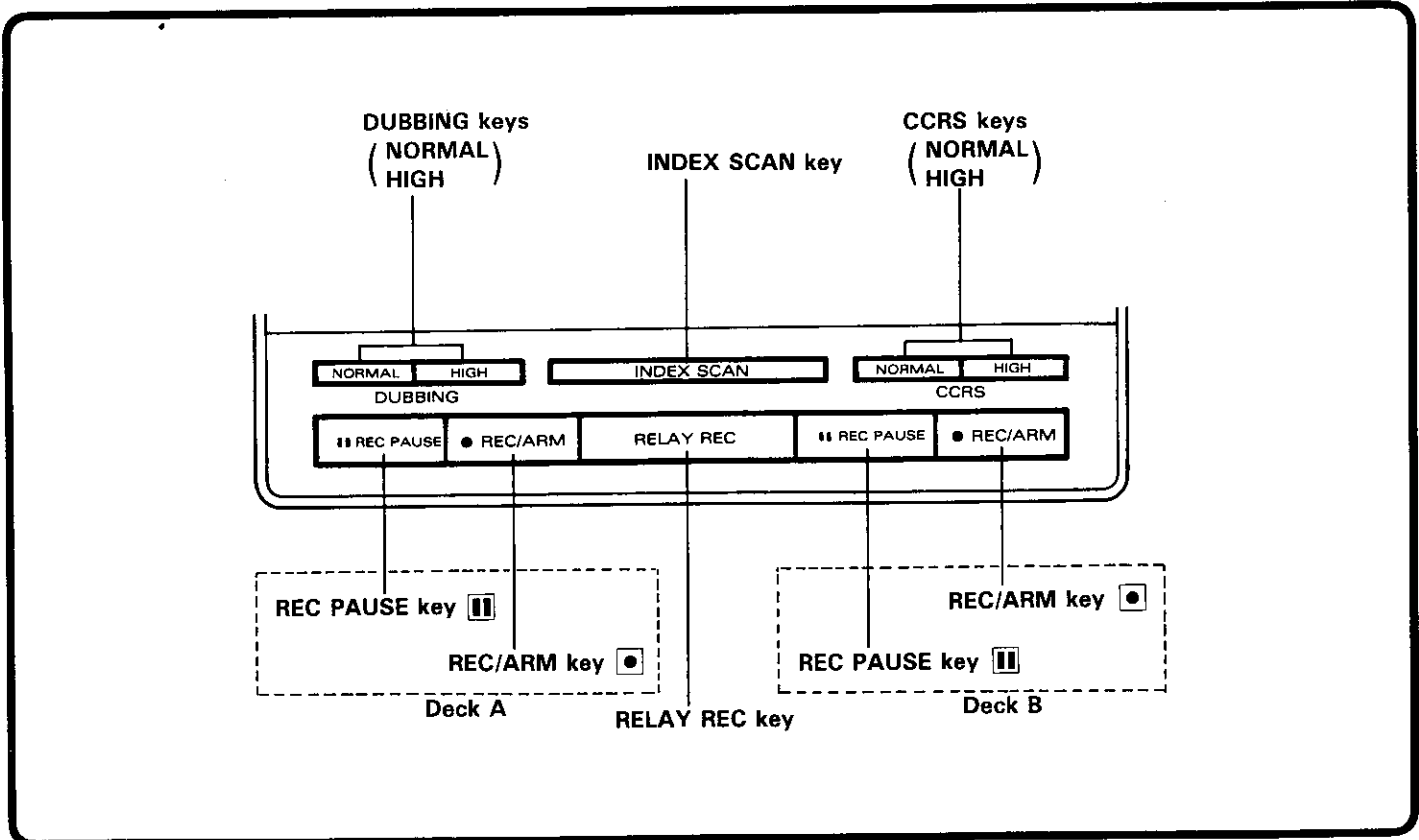

Listening to cassette tapes

Before starting playback.

Set the **TIMER** switch to OFF.

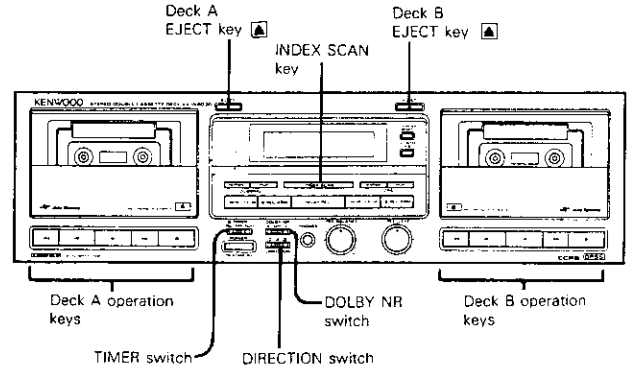

■ To playback a tape

1 Insert a cassette tape.

Press the EJECT key.

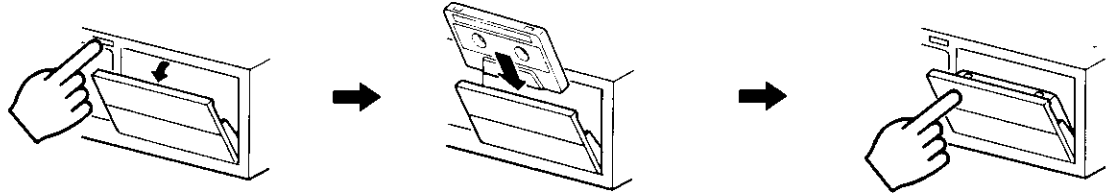

- The type of tape, Normal, Chrome or Metal, is detected and set automatically.
- Be sure to remove tape slack before insertion.

Close securely by pressing upper inside.

2 Determine the playback conditions.

① Select the playback mode.



- ⤴..... To play both sides endlessly.
- ➡..... To stop after playing both sides of tape.
- ➡..... To stop after playing one side of tape.

② Select the Dolby NR mode.

Select according to the tape to be played.

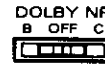

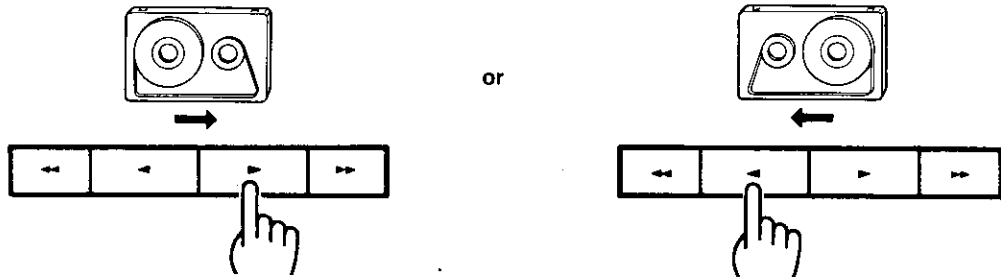

3 Start playback.



To stop playback, press the  key.

- Do not press the EJECT key  until the tape has stopped completely.

Tape transport direction indicators

The   indicators show the direction of tape transport in its playback or recording. The direction selected when the tape was stopped the last time is maintained even after the power is turned off. When the tape is started automatically by the automatic play operation, etc., the transport starts with the direction shown by the direction indicator. If you want to change the transport direction for the next time the power is turned on, press the play key of the opposite direction before turning power off.

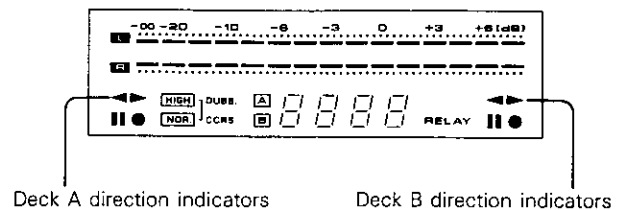

■ To wind the tape at high speed

1 Stop playback.



2 Press the ◀ key or ▶ key.

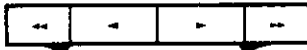

◀◀ : Fast tape winding in the ← direction ▶▶ : Fast tape winding in the → direction

To stop fast tape winding:

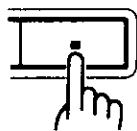

■ Index scan operation (Deck A only)

Index scan plays the first about 10 seconds of every tune on a tape.

Press the INDEX SCAN key.

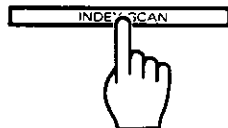

To return to normal playback.

Press the ▶ key or ◀ key.

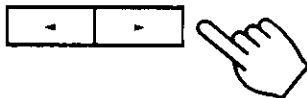

- Normal playback starts from the position where the key is pressed.

To stop Index scan.



■ Relay playback

This function plays back the tapes in both decks A and B continuously and repeatedly.

1 Insert tapes.

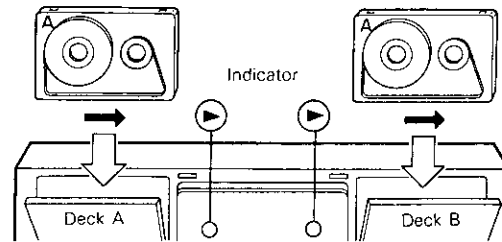

- Tapes are played in the directions indicated by their respective indicators on the display.

2 Select the playback mode.



- ▷ ... Relay playback of both sides of tapes in decks A and B is repeated.
- ≡ ... Relay playback of only one side of tapes in decks A and B is repeated.
- Relay playback cannot be performed if the DIRECTION mode is set to "◁".

3 Start playback.

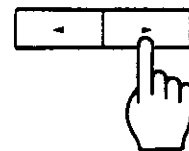

- The playback starts with the deck the play key of which is pressed.

Notes:

1. The tape direction of Index scan is indicated by the lighting direction indicator. To reverse the Index scan direction, press play key ▶ or ◀ then immediately press the INDEX SCAN key.
2. If the DIRECTION switch is set to "▷" or "◁", Index scan is performed on both sides of tape.

DPSS operation

The DPSS (Direct Program Search System) enables the following convenient operations according to the instructions of the operation keys (these operation are however not available on both decks simultaneously). The DPSS functions are based on the detection of non-recorded spaces of 4 seconds or more between tunes.

1. Skip play:

By specifying a tune located several tunes beyond (or behind) the tune being played, skips tunes between the current tune and the selected tune and starts playback from the beginning of the selected tune. Up to 16 tunes can be skipped in Skip Search.

2. Single-tune repeated playback:

One single tune is played back repeatedly up to 16 times.

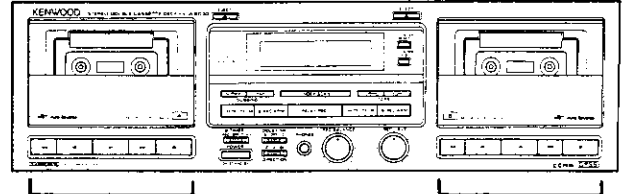
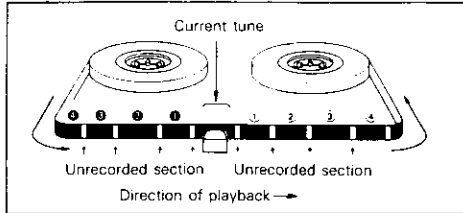

■ Skip play operation

The example below shows the case in which the direction indicated by the tape transport direction indicator is ►. If the direction indicated by the tape direction indicator is ◀, always press the keys for the opposite directions to those shown in the illustrations below.

To play a tune located immediately after the tune being played:

Press once during the playback.

To play the tune being played from the beginning:

Press once during the playback.

To play a tune located 4 tunes beyond:

Press 4 times during the playback.

To play the tune located 4 tunes behind:

Press 5 times during the playback.

■ Single-tune repeated playback operation

1 Play the tune to be repeated.

2 Press the play key of the same direction as the current tape transport direction.

When direction of tape direction indicator is ►:

- Normal playback resumes after repeating the same tune for 16 times.

Index scan and DPSS will not function properly with the following types of tape.

- Tapes containing spaces of 4 seconds or more, such as conversations and speeches.
- Tape containing extremely low levels or non-recorded spaces in the middle of tunes, such as classical music.
- Tapes containing recording of large noise between tunes.
- Tapes recorded with low recording level.
- Tapes recorded using Cross-fade recording.

To cancel the playback above in the middle:

Press once.

- Playback is stopped and canceled.

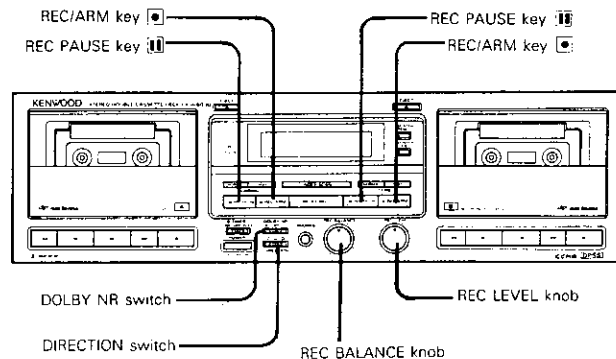

■ Ordinary recording

1 Set up the cassette deck.

- ① Insert a tape in deck A or B.

- ② Set the tape transport direction.

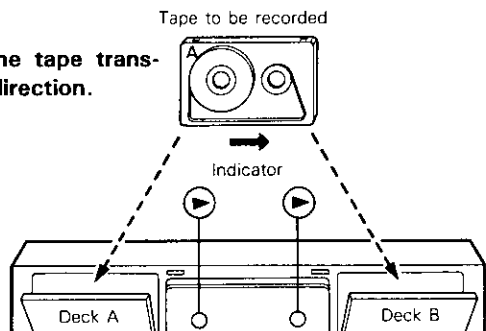

- ③ Select one-side or two-side recording.



1 Two-side recording
2 One-side recording

- ④ Select the Dolby NR mode.



2 Select the source to be recorded.

3 Set the recording level.

- ① Play a music source.

- ② Enter the record-pause mode.



- ③ Adjust the recording balance and recording level.

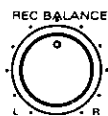

- Adjust so that segments around the +3 dB segment of the peak level meter light up at times.

- ④ Stop playing the source.

4 Start recording.

- ① Play the music source from the beginning.

- ② Press the  key.



Press once.

- The deck enters the stop mode automatically when the tape has been recorded till the end.

Dolby noise reduction system

The Dolby noise reduction system was developed to reduce the tape hiss noise generated during playback.

The optimum effect of the Dolby NR system is obtained when the same type NR system is used for both recording and playback. If a different type NR system is used, playback is not performed correctly. Make sure that the same type noise reduction system is used for both recording and playback.

Dolby B NR

The most popular noise reduction system used in home audio components. Usually, Dolby NR system corresponds to B NR.

Dolby C NR

Dolby C NR offers improved noise reduction performance over that of the Dolby B NR. It features a superior noise reduction effect. Use Dolby C NR to record or playback with this unit.

It is recommended that tapes recorded with the Dolby NR system be marked "B" or "C", so that they can easily be distinguished.

■ To pause recording temporarily

• The  indicator lights up.



To resume recording

•  REC/ARM

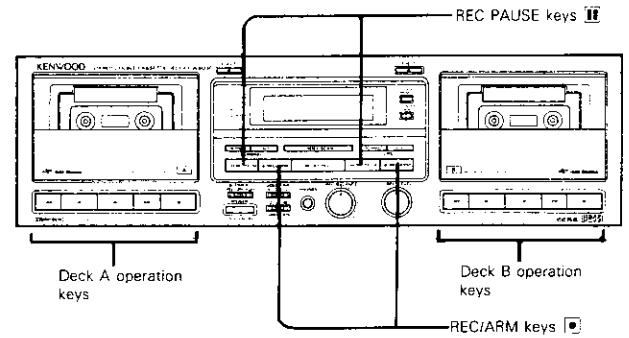
■ To stop recording

1

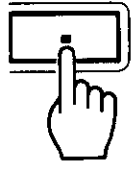

2 Stop playing the source component.

■ How to provide non-recorded blanks between programs

To make a non-recorded blank of about 4 seconds:

Press the  key twice in succession.



• After leaving a non-recorded blank of about 4 seconds, the deck enters the record-pause mode.

To make a non-recorded blank during recording:

Press the  key once during recording.



• After running to make a non-recorded blank of about 4 seconds from the point where the key is pressed, the deck enters the record-pause mode.

■ To re-start recording after mistake

A non-recorded space of 4 seconds or more should be reserved before the position where recording was started.

1 Stop recording and rewind tape.

During recording in the  direction:

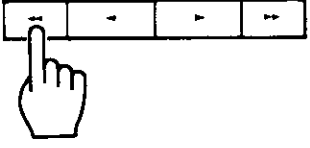

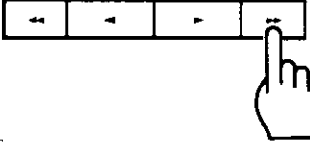

During recording in the  direction:



• The recording is aborted, the tape is rewound to the position where the recording was started, and the deck enters the stop mode after leaving a non-recorded space of about 2 seconds from the end of the previous tune.

2 Re-start recording.

① Press the  key twice.



• A non-recorded space of 4 seconds is reserved on tape, then the tape transport stops.

② Press the  key once.



• Recording starts.

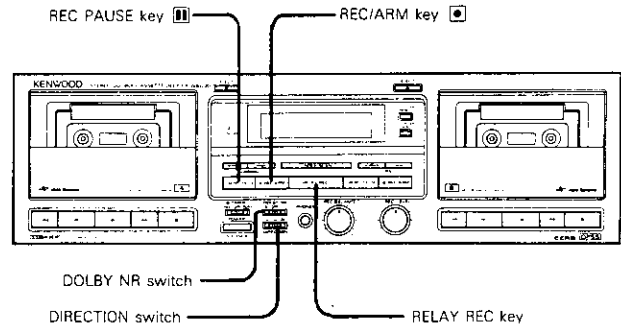

■ Relay recording

This function allows to record sound continuously from deck A to B.

1 Insert tapes in both decks A and B.

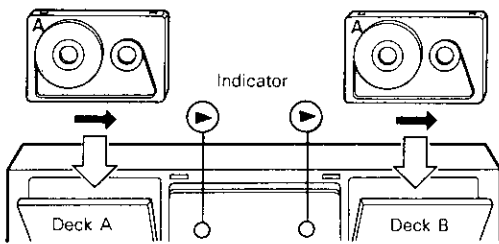

2 Set the recording condition.

① Select the recording mode.



..... Two-side recording
 One-side recording

② Select the Dolby NR mode.

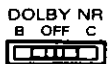

3 Set the relay recording mode.

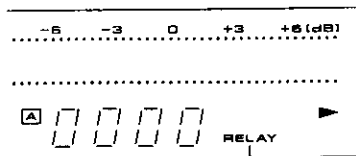
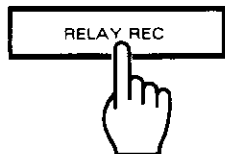

RELAY Lights up.

4 Adjust the recording level.

① Play the music source.

② Enter the record-pause mode (deck A).

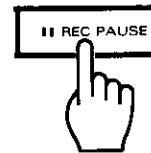

③ Adjust the recording balance and recording level.

- Adjust so that the +3 dB segments of the peak level meter lights at times.

④ Stop playing the music source.

5 Start recording.

① Play the music source from the beginning.

② Press the REC/ARM key (deck A).

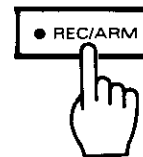

- Recording on deck B starts immediately after recording on deck A has completed.

Note:

Relay recording cannot be performed if the DIRECTION switch is set to " ".

Synchro recording

By connecting this unit with a KENWOOD XS type amplifier (receiver) with a SYSTEM CONTROL jack and a KENWOOD CD player with a SYSTEM CONTROL jack using system control cords, recording on this unit and playback on the CD player can be started simultaneously.

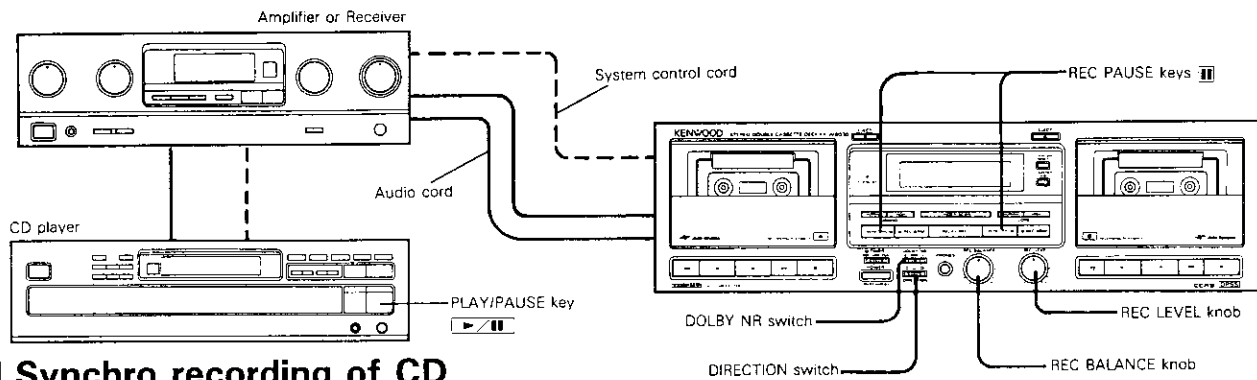

■ Synchro recording of CD

1 Make preparations for recording.

① Insert a tape in deck A or B.

② Adjust the tape transport direction.

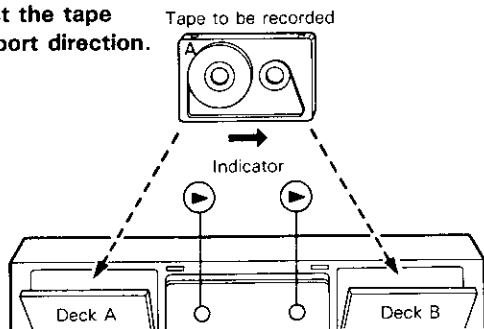

③ Select the side(s) to be recorded onto.

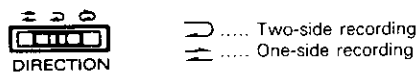

④ Select the Dolby NR mode.



2 Adjust the recording level.

① Play a CD.

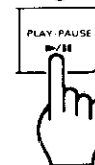

② Enter the record-pause mode.

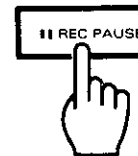

③ Adjust the recording balance and recording level.

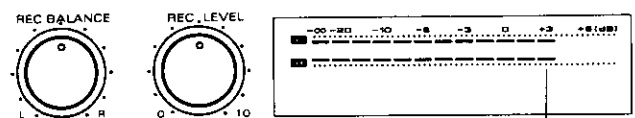

Adjust so that these segments light at times.

④ Stop playing the CD.

3 Set the record-pause mode.

4 Start playing the CD.

Press the key or the numeric key corresponding to the track No. to start recording with.

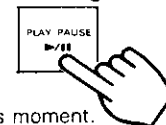

- Recording starts at this moment.
- When the CD player has completed playback, the deck stops recording and enters the stop mode.

To pause Press the key of the CD player.
 To restart recording Press the key of the CD player.
 To stop Press the key of the CD player.

- If the stop key of the cassette deck is pressed, the cassette deck enters the stop mode but the CD player does not.

By connecting this unit with a KENWOOD XS type amplifier (receiver) with a SYSTEM CONTROL jack and a KENWOOD turntable with a SYSTEM CONTROL jack using system control cords, recording on this unit and playback on the turntable can be started simultaneously.

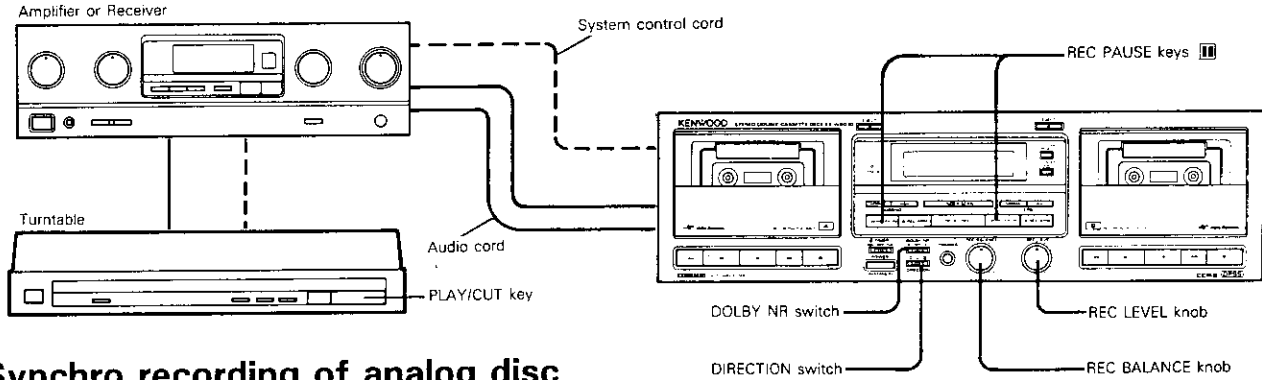

■ Synchro recording of analog disc

1 Make preparations for recording.

- ① Insert a tape in deck A or B.
- ② Adjust the tape transport direction.

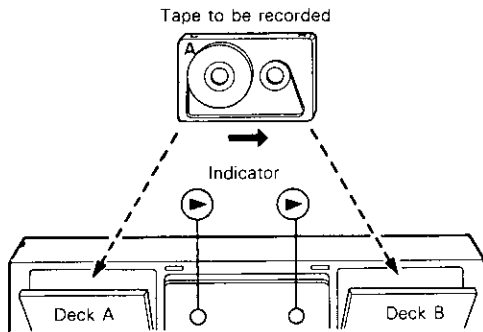

- ③ Select the side(s) to be recorded onto.



..... Two-side recording
 One-side recording

- ④ Select the Dolby NR mode.

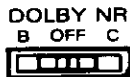

2 Adjust the recording level.

- ① Start playing an analog disc.

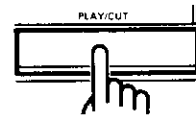

- ② Enter the record-pause mode.

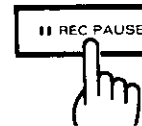

- ③ Adjust the recording balance and recording level.



Adjust so that these segments light at times.

- ④ Stop playing the analog disc.

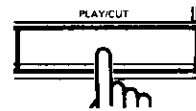

- The cassette deck returns to the stop mode.

3 Set the record-pause mode.

4 Start playing the analog disc.

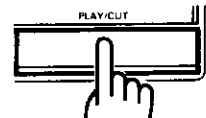

- Recording starts at this moment.
- When the turntable has completed the play, the deck stops recording and enters the stop mode.

To stop recording in the middle:

Press the **PLAY/CUT** key of the turntable.

- If the stop key of the cassette deck is pressed, the cassette deck enters the stop mode but the turntable does not.

Recording of CD playback (CCRS)

About CCRS (Computer Controlled CD Recording System)

When connected with a CD player provided with " [X] " marking through the system control cord, this unit allows to use the CCRS (Computer-controlled CD Recording System), which starts recording automatically after setting the optimum recording level for the CD and tape to be used in recording.

CCRS (Computer-controlled CD Recording System)

When the CCRS key is pressed, the following operations occur automatically and CD sound is recorded on tape.

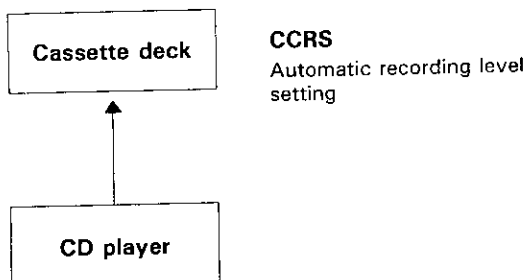

1. The CD starts to be played, and the peak value is sampled from the levels of the signals on the CD.
2. The optimum recording level for the specific CD is determined and set based on the peak value sampled.
3. The recording preparation steps above take about 20~200 seconds, after which the actual recording starts.
4. After recording (when the CD player is stopped or when the tape has run out), both the cassette deck and CD player stop.

- With CD players equipped with the EDIT function, it is possible to make recordings in which the last songs on sides A and B are not cut off in the middle and in which the recording capacity of the tape is used to the fullest extent. (Set the DIRECTION switch of the deck to " > ")

■ CCRS recording (deck B only)

1 Set the input selector switches of the amplifier (receiver) for the CD source.

2 Place a CD in the CD player.

- When edited recording is required, press the EDIT key on the CD player.

3 Insert a tape in deck B.

4 Press the CCRS key.

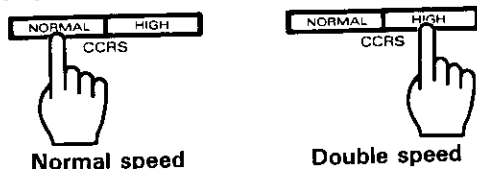

- When this unit is connected to KENWOOD DP-R791, press the SPEED key so that the SPEED indicator goes off.
- When performing CCRS recording with a CD player which can be loaded multiple compact discs, set the CD player to TRACK mode, press the disc select key and press the CCRS key.
- The Dolby NR does not work if the HIGH key is pressed.
- The CCRS indicator blinks, and actual recording starts in about 20 to 200 seconds (after creating a non-recorded blank of about 8 seconds).

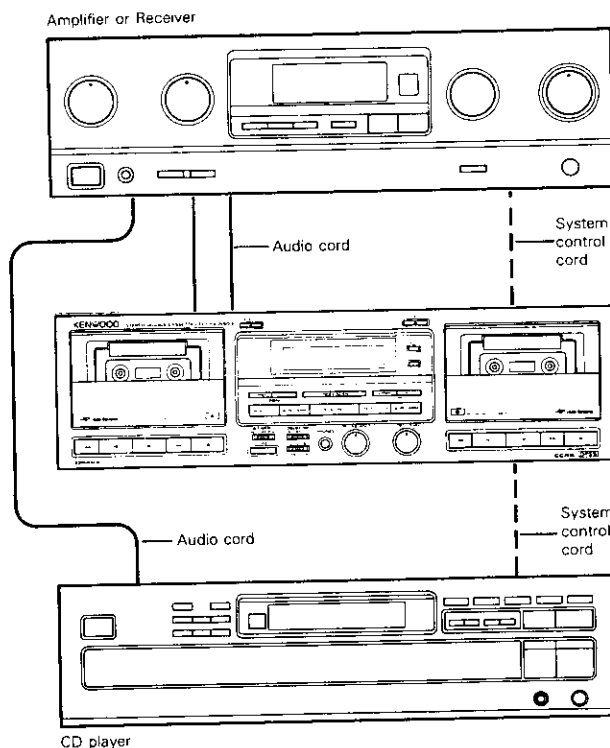

How to cancel CCRS

During recording level setting:
Press the Stop key of the CD player or the stop key of the cassette deck.

During CCRS recording:
Press the Stop key of the CD player.

After completion of CCRS recording:
Press the OPEN/CLOSE key of the CD player.

- After completion of CCRS recording, be sure to cancel the CCRS and ensure that the CCRS indicator has gone off.
- After recording, the cassette deck and CD player enter the stop mode automatically.

■ CCRS relay recording

Used when the EDIT 1 and EDIT 2 operation is carried out with the CD player in which multiple compact discs can be loaded.

1 Set the input selector switches of the amplifier (receiver) for the CD source.

2 Place a CD in the CD player.

3 Insert tapes in both decks A and B.

4 Edit the CD.

- For details, read the instruction manual of the CD player.

5 Press the RELAY REC key.



6 Press the CCRS key.

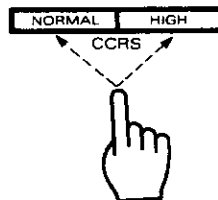

- The Dolby NR does not work if the HIGH key is pressed.
- When the HIGH key is pressed, recording is performed at twice the normal speed.
- Recording starts with deck A then continues on deck B.

How to cancel CCRS

During recording level setting:
Press the Stop key of the CD player or the stop key of the cassette deck.

During CCRS recording:
Press the Stop key of the CD player.

After completion of CCRS recording:
Press the OPEN/CLOSE key of the CD player.

- After completion of CCRS recording, be sure to cancel the CCRS and ensure that the CCRS indicator has gone off.
- After recording, the cassette deck and CD player enter the stop mode automatically.

Notes:

1. If the CCRS key is pressed during CD playback, playback stops and CCRS operation begins.
2. If the remaining amount of tape is small, CCRS may not function correctly or CCRS operation may be canceled in mid-operation.
3. Once the CCRS recording level has been set, the recording balance and recording level cannot be adjusted while the CCRS operation is being carried out.
4. The CCRS function sets the peak level for the entire CD in approx. 20~200 seconds. On very rare occasions, however, the function may not be able to set the optimum recording level. If this occurs, carry out recording manually referring to the "Ordinary recording" section (page 13).
5. The CCRS recording level setting is canceled when the OPEN/CLOSE key of the CD player is pressed or when the power is switched OFF.

Tape dubbing operation

The dubbing refers to the copy of the recorded contents of a tape to another tape (tape in Deck A → tape in Deck B).
Normal-speed dubbing: Copy at normal tape speed.
High-speed dubbing: Copy at double the normal speed.

1 Insert tapes in the cassette decks.

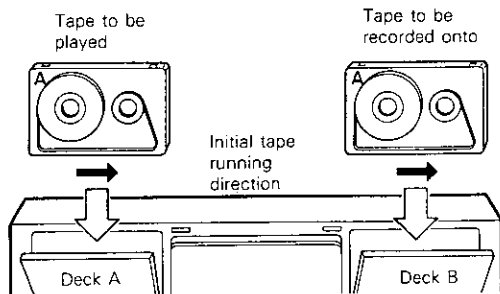

2 Set the same tape transport direction for both tapes.

- Refer to page 10.

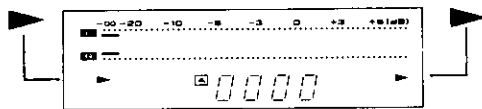

3 Select one-way or two-way dubbing mode.



➤ For two-way dubbing

➤ For one-way dubbing

4 Start dubbing.

For normal-speed dubbing

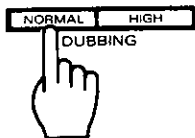

For high-speed dubbing

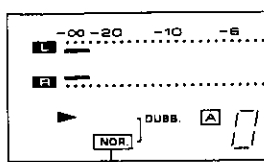
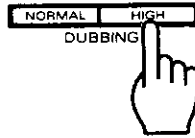

Lights up.

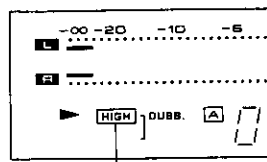

Lights up.

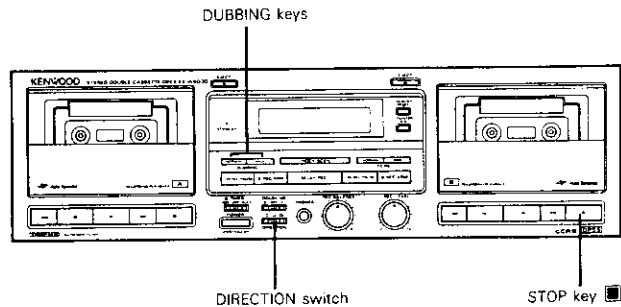

To stop dubbing

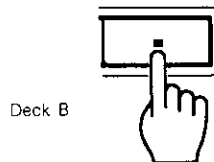

- Both Decks A and B enter the stop mode.

To pause dubbing

Normal-speed dubbing: Press the **NORMAL** key.

High-speed dubbing: Press the **HIGH** key.

- Only deck B enters the record-pause mode after leaving a non-recorded space of about 4 seconds in case of normal-speed dubbing, or about 6 seconds in case of high-speed dubbing.
- To skip tunes you do not want to dub on another tape during dubbing, press the key of Deck A.
- To resume dubbing after pause, press the same DUBBING key as above (**NORMAL** or **HIGH**) again.

Notes:

1. The recording balance and recording level cannot be adjusted for dubbing.
2. The DOLBY NR switch does not function during dubbing.
 - * The tape recorded by dubbing features the same NR system as the original tape in Deck A.
3. Noise from TV may interfere with dubbed sound if high-speed dubbing is executed near a TV set. To prevent this, install the system farther from the TV set.
4. If the original tape was recorded at a high level, the sound quality may be degraded, if high-speed dubbing is used. In such a case, use normal-speed dubbing.

Timer operations

This unit incorporates a built-in timer standby function. By using an audio timer optionally available in the market, wake-up playback and unattended recording of tape can be started at any time of the day.

Preparations for timer playback and recording

Connect the power cords of the components directly or indirectly to the timer so that their powers can be turned on via the timer.

The timer setup operation varies depending on the timer. Also read carefully the instruction manual of your audio timer.

When operating the unit other than CD player using an audio timer, be sure to remove the disc from the CD player.

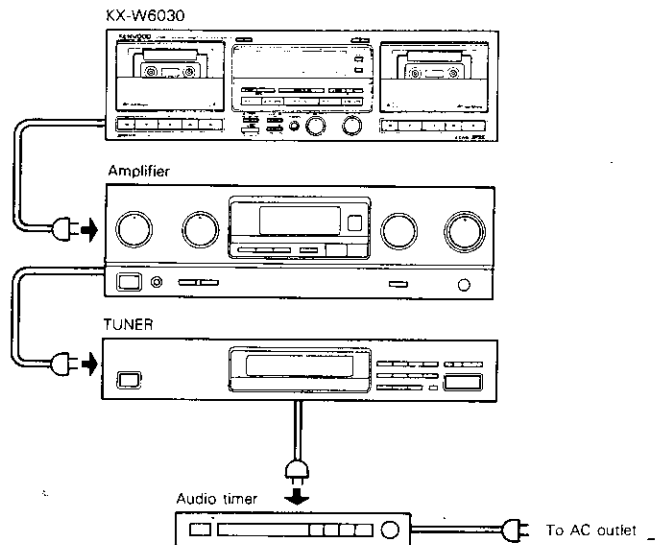

■ Timer playback

1 Set the power switches of the components used in timer playback to ON.

2 Insert a cassette tape(s).

- The type of tape, that is, Normal, Chrome or Metal, is set automatically.
- Remove the tape slack before insertion.
- If relay playback is required, insert tapes in both decks A and B.

3 Set the playback condition.

① Select the playback mode.

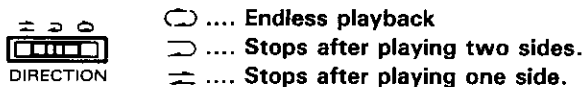

- If relay playback is required, set to "▷" or "◁".

② Select the Dolby NR mode.

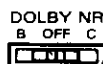

- Set according to the tape(s) to be played.

4 Start playback.

5 Adjust the volume of the amplifier.

6 Rewind the tape(s) to the start position.

7 Set the timer so that the tape starts at the desired time of the day.

8 Set the TIMER switch to PLAY.



- When the set time comes, tape playback starts automatically.

Note:

If tapes are inserted in both decks A and B, timer playback starts with deck A.

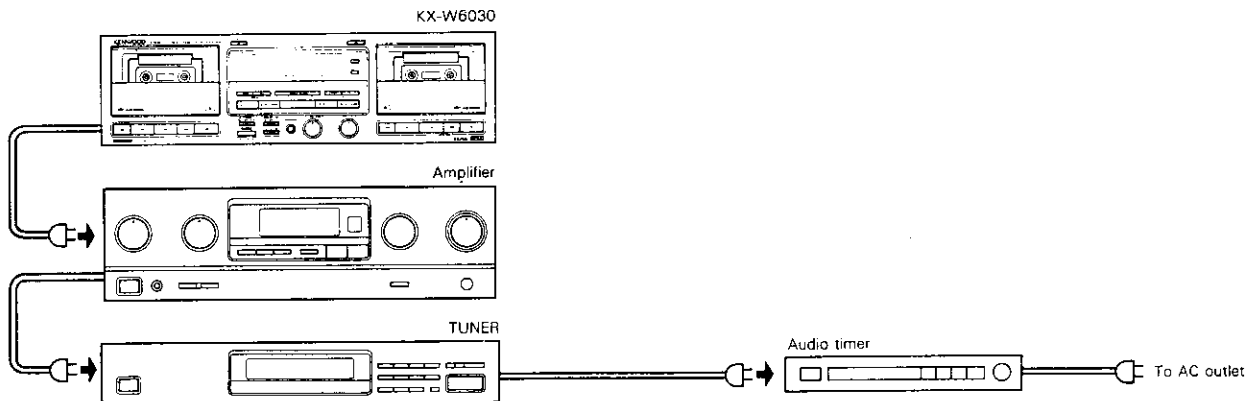

■ Timer recording of tuner broadcast

1 Set the power switches of the components used in timer recording to ON.

2 Receive the desired radio station with the tuner.

3 Make preparations of the cassette deck.

① Insert a tape(s) in a cassette deck.

- Insert a tape into either deck A or deck B.
- For relay recording, insert tapes into both decks A and B (refer to page 15).

② Adjust the tape transport direction.



↔ Two-side recording

→ One-side recording

④ Select the Dolby NR mode.

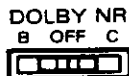

4 Adjust the recording level.

① Enter the record-pause mode.

② Adjust the recording level.

- Adjust so that the +3 dB segments of the peak level meter lights at times.

5 Set the relay recording as required.

- Refer to page 15.
- Relay recording, if selected, starts with deck A and continues on deck B.

6 Set the amplifier volume to the minimum position.

7 Set the time when the recording is to be started.

- For the time setup operation, read the instruction manual of your timer.

8 Set the TIMER switch to REC.



- When the set time comes, the powers of the related components are turned ON and recording starts.
- Recording stops when the end of tape is reached.

Note:

To ensure that the cassette deck's automatic shut off switch operates before the power is shut off, set the timer so that it operates for a little longer than the playing time of the tape.

In case of difficulty

What appears to be a malfunction may not always be serious. If your unit should not perform as expected, consult the table below to see if the problem can be corrected before seeking help from your dealer or service representative.

Symptom	Cause	Remedy
Sounds is not produced when the Play key is pressed.	<ul style="list-style-type: none"> The connection cords are connected improperly. The head is dirty. Tape is irregularly wound and hard to take up. A non-recorded tape is being played. 	<ul style="list-style-type: none"> Connect the cords properly referring to "System connections". Clean the head referring to "Cleaning the head section". Replace the tape. Play a recorded tape.
The deck does not work when an operation key is pressed.	<ul style="list-style-type: none"> The cassette holder is not closed completely. The operation key was pressed immediately after closing the cassette holder. The operation key was pressed within less than 3 seconds after the power was turned on. Tape is not inserted. Tape is irregularly wound and hard to take up. Tape has been fully wound to reel. 	<ul style="list-style-type: none"> Close the cassette holder completely. Press the desired operation key in a few seconds after closing the cassette holder. Press the desired operation key in more than 3 seconds after turning the power on. Insert a tape. Replace the tape. Change the tape transport direction or insert the tape inversely.
DPSS malfunctions.	<ul style="list-style-type: none"> The tape is not suitable for DPSS operation, for example the spaces between tunes are too short. 	<ul style="list-style-type: none"> Read "DPSS operation".
CCRS does not work.	<ul style="list-style-type: none"> A recordable tape is not inserted in Deck B. A disc is not placed in the CD player. The disc is dirty. 	<ul style="list-style-type: none"> Insert a recordable tape in Deck B and press the CCRS key. Place a disc in the CD player and press the CCRS key. Clean the disc, place it in the CD player, and press the CCRS key.
The dubbing on Deck A and Deck B ends at different timing.	<ul style="list-style-type: none"> This is due to the difference in tape length or to the characteristics of the cassette deck mechanisms. 	<ul style="list-style-type: none"> A small time difference is not regarded as a failure.
The cassette holder does not open when the EJECT key is pressed.	<ul style="list-style-type: none"> The key is pressed during recording or playback. 	<ul style="list-style-type: none"> Press in the Stop mode.
Sound is hoarse, or high frequencies are not audible.	<ul style="list-style-type: none"> The head is dirty. The tape is stretched or wrinkled. 	<ul style="list-style-type: none"> Clean the head referring to "Cleaning the head section". Replace the tape.
Sound is distorted.	<ul style="list-style-type: none"> The recording level was too high. A tape recorded with distorted sound is being played. 	<ul style="list-style-type: none"> Adjust the recording level referring to "How to record". Replace the tape.
Recording is not initiated when the REC key is pressed.	<ul style="list-style-type: none"> The protection tab on the cassette has been broken. The cassette holder is not closed completely. The recording level is set to the minimum position. The TAPE A or B input selector is selected on the amplifier. Tape has been fully wound to a reel. 	<ul style="list-style-type: none"> Use a cassette with unbroken tab. or close the hole. Close the cassette holder completely. Adjust the recording level referring to "How to record". Press the input selector key of the source to be recorded. Change the tape transport direction of Deck or insert the tape inversely.

Symptom	Cause	Remedy
Noise level is high.	<ul style="list-style-type: none"> ● The head is magnetized. ● External noise is induced. ● The recording level was too low. ● A tape recorded with Dolby NR ON is being played with Dolby NR OFF. 	<ul style="list-style-type: none"> ● Demagnetize the head referring to "Cleaning the head section". ● Install the system apart from other electrical appliances and TV set. ● Adjust the recording level referring to "How to record". ● Press the DOLBY NR switch to B or C.
Sound is vibrating.	<ul style="list-style-type: none"> ● The capstans or pinch rollers are dirty. ● Tape is irregularly wound. 	<ul style="list-style-type: none"> ● Clean the head referring to "Cleaning the head section". ● Wind the tape regularly by fast forwarding, rewinding or playing it fully from one reel to another.
Playback or recording starts immediately when the power is switched ON.	<ul style="list-style-type: none"> ● The TIMER switch is set to PLAY or REC. 	<ul style="list-style-type: none"> ● Set the TIMER switch to OFF unless timer playback or timer recording is required.

Notes:

1. This unit is microprocessor-controlled, so malfunction may occur due to external noise or interference noise. In such a case, unplug the power cord, plug it and turn power on again.
2. Do not use contact cleaners because it could cause a malfunction. Be specially careful against contact cleaners containing oil, for they may deform the plastic components.
3. With some tapes, a squeaky noise is produced when the tape is stopped automatically. This is due to the tape protection function, and not a malfunction.
4. Do not use 120-minute tapes, for the tape is too thin and gets easily tangled.

**For the U.S.A.
FCC WARNING**

This equipment may generate or use radio frequency energy. Changes or modifications to this equipment may cause harmful interference unless the modifications are expressly approved in the instruction manual. The user could lose the authority to operate this equipment if an unauthorized change or modification is made.

NOTE:

This equipment has been tested and found to comply with the limits for a Class B digital device, pursuant to Part 15 of the FCC Rules. These limits are designed to provide reasonable protection against harmful interference in a residential installation. This equipment may cause harmful interference to radio communications, if it is not installed and used in accordance with the instructions. However, there is no guarantee that interference will not occur in a particular installation. If this equipment does cause harmful interference to radio or television reception, which can be determined by turning the equipment off and on, the user is encouraged to try to correct the interference by one or more of the following measures:

- Reorient or relocate the receiving antenna.
- Increase the separation between the equipment and receiver.
- Connect the equipment into an outlet on a circuit different from that to which the receiver is connected.
- Consult the dealer or an experienced radio/TV technician for help.

**For CANADA
DOC REGULATION**

"This digital apparatus does not exceed the CLASS B limits for radio noise emissions from digital apparatus as set out in the radio interference regulations of the Canadian Department of Communications."

Specifications

Track System	4-track, 2-channel stereo
Recording System	AC bias (Frequency: 105 kHz)
Heads	A DECK Playback/recording head..... 1 Erasing head..... 1
	B DECK Playback/recording head..... 1 Erasing head..... 1
Motors	A DECK..... DC motor × 1 B DECK..... DC motor × 1
Fast Winding Time	Approx. 110 seconds (C-60 tape)
Frequency Response:	
Normal Tape	20 Hz to 18,000 Hz, ± 3 dB
CrO ₂ Tape	20 Hz to 18,000 Hz, ± 3 dB
Metal Tape	20 Hz to 20,000 Hz, ± 3 dB
Signal-to Noise Ratio:	
Dolby C NR ON.....	72 dB (Metal tape)
Dolby B NR ON.....	65 dB (Metal tape)
Dolby NR OFF.....	57 dB (Metal tape)
Harmonic Distortion.....	Less than 0.6% (at 1 kHz, 3rd H.D., Normal tape)
Wow and Flutter.....	0.08% (W.R.M.S.) ± 0.22% (DIN)
Input sensitivity/Impedance:	
LINE IN	77.5 mV/50 kΩ
Output Level/Impedance:	
LINE OUT	390 mV/3.9 kΩ
Headphones.....	0.2 mW/8 Ω

[GENERAL]

Power Consumption.....	20 W
Dimensions.....	W: 440 mm (17-5/16") H: 137 mm (5-3/8") D: 269 mm (10-9/16")
Weight (Net).....	4.5 kg (9.9 lb)

Note:

KENWOOD follows a policy of continuous advancements in development. For this reason specifications may be changed without notice.

Note:

The unit's power supply is secondarily connected. Note following. The unit is not completely disconnected from the mains as long as the power cord is connected to a wall outlet.

Observera:

Apparatens strömförsörjning kopplas från sekundärt. V.g. ge akt på följande.
Apparaten fränkopplas inte helt och hållet från strömnätet medan apparatens nätsladd är ansluten till växelströmsuttaget.

Huom:

Virta yksikköön on kytketty pois sekundaaripuoleilta. Huomioi seuraava. Tämä yksikkö ei ole kokonaan kypketty pois pää virranjakajasta kun pää katkaisin on liitettynä virtatiiriin.

Bemærk:

Strømmen til apparatet afbrydes på den sekundære side. Vær opmærksom på følgende.
Denne enhed er ikke fullstendig koblet fra lysnettet så længe stikket er tilsluttet stikkontakten.

Anmerkning:

Strømmen til apparatet er slått av på sekundærsiden. Vær oppmerksom på det følgende.
Dette apparatet koples ikke fullstendig fra nettet så lenge støpselet står i en stikkontakt, selv om strømbryteren settes i av-stilling.

Free Manuals Download Website

<http://myh66.com>

<http://usermanuals.us>

<http://www.somanuals.com>

<http://www.4manuals.cc>

<http://www.manual-lib.com>

<http://www.404manual.com>

<http://www.luxmanual.com>

<http://aubethermostatmanual.com>

Golf course search by state

<http://golfingnear.com>

Email search by domain

<http://emailbydomain.com>

Auto manuals search

<http://auto.somanuals.com>

TV manuals search

<http://tv.somanuals.com>