

**KENWOOD**

VHF FM TRANSCEIVER

**TH-205AT**

**TH-205A**

**TH-205E**

---

# INSTRUCTION MANUAL

KENWOOD CORPORATION

©PRINTED IN JAPAN B50-8087-30(K, M, W, X)(T)  
87/12 11 10 9 8 7 6 5 4 3 2 1 86/12 11

Thank you for purchasing the new TH-205AT/205A/205E transceiver.

## IMPORTANT

Please read this instruction manual carefully before placing your transceiver in service.

This Instruction Manual covers the following models:

KENWOOD TH-205AT:	144 MHz FM transceiver with DTMF Pad.
KENWOOD TH-205A:	144 MHz FM transceiver without DTMF Pad.
KENWOOD TH-205E:	144 MHz FM transceiver with Tone.
TRIO TH-205E:	144 MHz FM transceiver with Tone Burst.
(U.K. version)	

**SAVE THIS INSTRUCTION MANUAL.**

# CONTENTS

SPECIFICATIONS.....	3
ACCESSORIES .....	3
BATTERY PACK .....	4
Ni-Cd battery	
Recharging the Battery Pack	
Manganese/Alkaline batteries	
Memory Back-up battery	
CONTROLS AND FUNCTIONS .....	5
OPERATION.....	7
Frequency selection	
Receive	
Transmit	
Repeater Operations	
Transmitter Offsets	
Reverse Function	
Tone Operation.....	8
Autopatch Operations (with the TH-205AT)	
Scan.....	9
Memory Entry	
Memory Recall	
Auto Battery Saver	
MAINTENANCE .....	10
In case of difficulty	
Service	
OPTIONAL ACCESSORIES	
Tone Squelch Unit TSU-3 .....	11
BLOCK DIAGRAM.....	another sheet
SCHEMATIC DIAGRAM	

# SPECIFICATIONS

GENERAL	FREQUENCY		TH-205AT 144.000 ~ 147.995	
	RANGE (MHz)	TH-205A 144.000 ~ 147.995 TH-205E 144.000 ~ 145.995		
	MODE		F3 (FM)	
	OPERATING TEMPERATURE			-20°C ~ +50°C (-4°F ~ 122°F)
	ANTENNA IMPEDANCE			50 Ω
	POWER REQUIREMENT	BATTERY PACK	6.3 V ~ 15 VDC (8.4 VDC nominal)	
		DC IN	7.2 V ~ 16 VDC	
	CURRENT DRAIN	Hi TRANSMIT MODE 2.5 W	Approx. 1 A (8.4 V)	
		Hi TRANSMIT MODE 5 W	Less than 1.7 A (13.8 V)	
		Low TRANSMIT MODE	Less than 0.7 A	
RECEIVE MODE WITH NO SIGNAL		Approx. 50 mA		
BATTERY SAVER MODE		Approx. 20 mA		
DIMENSIONS (mm)	W × H × D	67 × 173 × 37		
	(PROJECTIONS INCLUDED)	69.5 × 180.5 × 38.2		
WEIGHT		Approx. 500 g (With manganese battery and antenna) Approx. 520 g (With Ni-Cd battery and antenna)		
TRANSMITTER	OUTPUT POWER	Hi	5 W (13.8 VDC)	
			5 W (with PB-1) 2.5 W (with PB-2)	
			1.5 W (with PB-3, PB-4)	
	Low	Approx. 500 mW		
		MODULATION		
	MAXIMUM FREQUENCY DEVIATION			± 5 kHz
	SPURIOUS RADIATION			Less than -60 dB
	INCLUDED MICROPHONE			Capacitor type
RECEIVER	CIRCUITRY			DOUBLE CONVERSION SUPERHETERODYNE
	INTERMEDIATE FREQUENCY	1st IF	16.3 MHz	
		2nd IF	455 kHz	
	SENSITIVITY	12 dB SINAD	Less than 0.2 μV	
		S + N/N	More than 28 dB (At 0.5 μV input)	
	SQUELCH SENSITIVITY			Less than 0.1 μV
	SELECTIVITY	-6 dB	More than 12 kHz	
		-40 dB	Less than 28 kHz	
AUDIO OUTPUT POWER			More than 400 mW (across 8 Ω load 10% distortion)	

**NOTE:** Circuit and ratings are subject to change without notice, due to development in technology.

# ACCESSORIES

Unpack your TH-205AT/205A/205E carefully and confirm that it is supplied with the following accessories.

- 1 Antenna..... T90-0352-05..... 1 ea.
  - 2 Rubber cap..... B09-0307-04..... 1 ea.
  - 3 Belt Hook (U.S.A. version)..... J29-0417-04..... 1 ea.
  - 4 Self Tapping Screw (U.S.A. version)..... N35-3005-41..... 2 ea.
  - 5 Spring washer (U.S.A. version) ..... N16-0030-41..... 2 ea.
  - 6 Ni-Cd Battery pack (PB-2)..... W09-0361-05..... 1 ea.
- or
- AA Manganese/Alkaline Battery case ..... A02-0728-03..... 1 ea.
  - 7 Battery charger (120 V)..... W09-0315-05..... 1 ea. (U.S.A. version) or  
Battery charger (220 V)..... W09-0317-05..... 1 ea. (European version) or  
Battery charger (240 V)..... W09-0318-05..... 1 ea. (U.K. version) or  
Battery charger (240 V)..... W09-0319-05..... 1 ea. (Oceania version)
  - 8 Instruction Manual..... B50-8087-20..... 1 ea. or  
Instruction Manual..... B50-8114-10..... 1 ea. (U.K. version)
  - 9 Warranty Card (U.S.A. only)..... 1 ea.

## BATTERY PACK

### Installing the battery pack

Match the concave part at the bottom of the radio to the convex part at the top of the battery pack.

Turn the battery pack clockwise until it clicks.

Be sure the pack and transceiver are locked together.

### Removing

Pressing the battery release button, turn the battery pack counterclockwise.

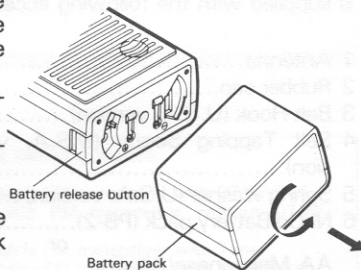

## Ni-Cd BATTERY PACK (PB-2)

### NOTE:

This battery pack has not been charged at the factory in order to provide you with the greatest number of charge/discharge cycles. You must charge the battery before use. The battery pack will require several charge/discharge cycles before you can expect to see the maximum operating period between charges. If the battery will be stored for greater than 2 months it should be recharged before use.

## RECHARGING THE BATTERY PACK

Insert the charge plug from the BC-2 into the receptacle on the rear of the battery pack. Then plug the BC-2 into the AC line. The LED on the BC-2 will illuminate to show that the pack is charging. The LED will remain on as long as the BC-2 is connected to the AC power source and the battery, indicating that the pack is still being charged. Therefore, do not forget to unplug the charger after approximately 15 hours. RECHARGING TIME: Approx. 15 Hours

### NOTES:

- Turn off the power switch before charging.
- Recharging should be done within ambient temperature between 10°C-40°C. Recharging performed out of this range may not fully charge the battery.
- Excessive charging, if happened, the battery performance and its life may lessen.

## MANGANESE or ALKALINE BATTERIES

Load 6 SUM-3 manganese or alkaline batteries in series in the supplied battery case. (Be sure to observe the polarities.)

(We recommend use of high-performance manganese batteries.) Battery pack (1) can be inserted into case (2) only in a specific direction. Check the shape (top and bottom) after moving the stopper on the rear side, then insert the battery correctly. Inserting the battery by force without checking the shape may damage the case.

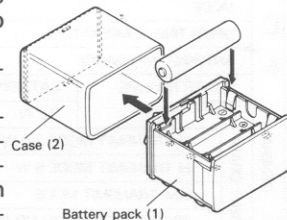

## MEMORY BACK-UP BATTERY

The TH-205AT/205A/205E includes a lithium back-up battery to retain memory in the microprocessor. When changing batteries, or if the Ni-Cd batteries should fully discharge, memory will always be retained.

If the display should begin to show erroneous information or numbers, the lithium battery needs replacement.

This should be performed by an authorized KENWOOD dealer since these components are easily damaged by static electricity.

# CONTROLS AND FUNCTIONS

## ① ANTENNA CONNECTOR

This jack is used to connect the supplied antenna. Twist to lock with the BNC connector.

## ② DC IN terminal

This terminal is used for external power supply (7.2 ~ 16 V). You should turn the power switch OFF when connecting this terminal. Pay attention to the polarity.

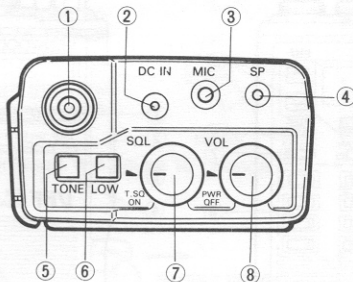

**CAUTION:** For safety do not remove the battery pack when a external power supply is used. Surely use KENWOOD optional cable (PG-2V or PG-3C).

## ③ External MIC Jack

## ④ SP Jack

This jack is used for an earphone or external speaker.

## ⑤ TONE switch

U.S. version: This switch is used to activate the sub-audible tone encoder.

European version: This switch is used to transmit a TONE signal. When this switch is pressed the repeater control signal of 1750 Hz is activated.

## ⑥ HI $\blacksquare$ /LOW $\blacksquare$ switch

This switch is used to select the transmit output power.

## ⑦ SQL (Squelch) control

The SQL control is used to eliminate noise during no signal periods. Normally, this control is adjusted clockwise until the noise just disappears and the BUSY indicator goes OFF (Threshold level). For scan operation, this control must be set to the threshold point. When an incoming signal is weak or unstable, readjust the squelch for optimum reception.

## ⑧ Power ON/OFF Switch and Volume Control

## ⑨ LCD display

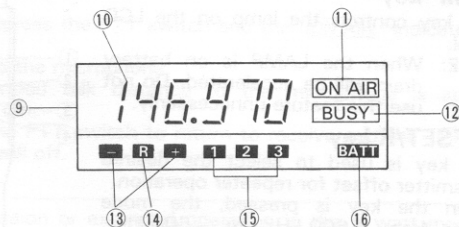

## ⑩ Frequency Display

Displays the operating frequency to the nearest kHz.

## ⑪ ON AIR indicator

This indicator lights during transmit.

## ⑫ BUSY indicator

This indicator lights whenever the squelch opens during receive. The indicator will be on all the time if the squelch control is rotated fully counterclockwise, and the T.SQ is off.

## ⑬ OFFSET symbol “-” “+”

Displays the selected offset, “-” for minus 600 kHz, “+” for plus 600 kHz, and no indicator for simplex.

## ⑭ REVERSE indicator “R”

Lights whenever the REVERSE switch is depressed.

## ⑮ Memory channel indicator

Indicates the selected memory channel 1-3.

## ⑯ BATT indicator

Lights when the battery voltage falls below the level for good communications. Recharge/replace the battery pack when this indicator comes on.

## ① MEMORY CHANNEL keys

These keys are used to select the desired memory channel.

## ② LAMP key

This key controls the lamp on the LCD panel.

**NOTE:** When the LAMP is on battery drain will be accelerated. Do not use this feature unnecessarily.

## ③ OFFSET/R key

This key is used to select the desired transmitter offset for repeater operation. When the key is pressed, the mode cycles from +600 kHz, to -600 kHz, to simplex, and back to +600 kHz.

## R (REVERSE)

First press the **M** key and then **OFFSET/R** key to reverse the transmit/receive frequencies during repeater operation.

## ④ SCAN key

This key is used to initiate the SCAN.

## ⑤ UP/DOWN keys

These keys are used to select the operating frequency.

## ⑥ M (Memory enter) key

This key is used to enter a frequency into memory.

## ⑦ F. LOCK key

Place this switch ON and the selected frequency will remain unchanged by keyboard operation except PTT switch and LAMP key.

This feature is convenient when carrying the radio.

## ⑧ DTMF KEY PAD (With the TH-205AT)

To operate DTMF key pad press the PTT switch and dial the desired number.

After the first number has been entered the transceiver will remain keyed for approximately 2 seconds, thus allowing the release of the PTT switch.

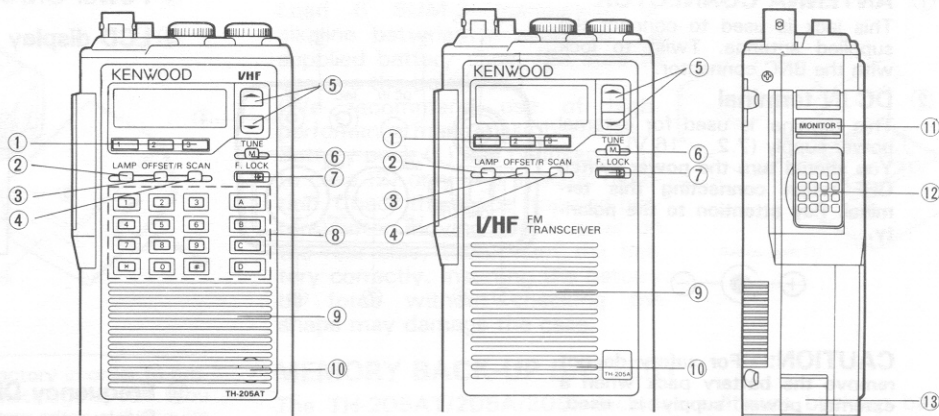

## ⑨ Speaker

## ⑩ Microphone

## ⑪ MONITOR key

During this key is pressed, squelch is released.

## ⑫ PTT (Push To Talk) switch

For transmission, press this switch and speak into the microphone.

## ⑬ RELEASE Button

This button is used to release the battery case for removal.

# OPERATION

## ■ FREQUENCY SELECTION

- Pressing either the ▲ or the ▼ key momentarily will cause the displayed frequency to change 5 kHz up or down, respectively.
- Pressing the ▲ or the ▼ key for more than one second will cause to change up or down continuously.
- Holding the ▲ and the ▼ keys depressed will cause to change rapidly.

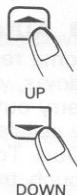

Repeating these operation shifts the displayed frequency as shown below.

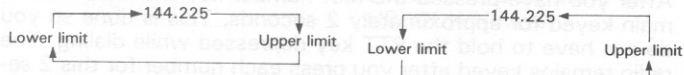

## ■ RECEIVE

After power and antenna connections have been completed, set the switches as follows:

- Turn the POWER/VOL switch clockwise to turn on power. The frequency on the LCD display will show the transceiver is operating.
- As the POWER/VOL switch is turned clockwise, either background noise or a QSO will be heard.
- To eliminate the no-signal noise turn the SQL switch clockwise.
- Enter the desired frequency using ▲ or ▼ key.
- Adjust the SQL control to the comfortable noise level.

## ■ TRANSMIT

**Precaution:** Check the intended transmit frequency before operating to prevent interference with other stations.

- Simply depress the PTT switch and the **ON AIR** indicator will light.
- Speak into the microphone. Recommended talk distance to the microphone is approximately 5 cm.
- Release the PTT switch to return to receive and the **ON AIR** indicator will off.

## CAUTION:

Long transmission or extended operation in the 5 watt mode might cause the rear of this transceiver to get warm. Do not place the transceiver where the heat sink (rear panel) might come in contact with plastic or vinyl surfaces.

## ■ REPEATER OPERATIONS

### ● Transmitter offsets

All amateur radio repeater utilize a separate receiver and transmitter section. The receiver frequency may be either above or below the transmitter frequency. For most repeaters this offset is  $\pm 600$  kHz. The TH-205AT/205A/205E allows you to store the frequency and offset in memory, or you can select the offset from the keyboard.

To select the desired offset press the OFFSET/R key. Each time you press the key the radio will advance from one offset to the other, i.e. "+" to "-" to no offset or simplex.

### ● REVERSE Function

Some repeater utilize a "reverse pair", i.e. the transmit/receive frequencies are exactly the reverse of another repeater. For example repeater A uses 146.000 for a transmit frequency (OUTPUT) and 146.600 for receive (INPUT). Repeater B uses 146.000 for its receive and 146.600 for its transmit. It would be inconvenient to have to reprogram the radio each time if you were in range of both repeaters.

The REVERSE key has been provided to allow you to reverse the transmit and receive frequencies.

To use the REVERSE function first press the "M" key and then press the OFFSET/R key. The REVERSE indicator **R** will light in the display.

To return to normal offsets press the "M" and OFFSET/R key again. This function is also useful to check the input frequency of the repeater so that you can determine if you are within SIMPLEX range.

### ● TONE Operation

Some repeaters require the use of a control signal to activate the repeater. Several versions are currently in use worldwide. In Europe a 1750 Hz tone is used in transmit. In the United Kingdom a 1750 Hz tone burst at the beginning of each transmission is used. Since use of these tones is required in the U.K. and in Europe the tone encoder is included as standard equipment.

Use of subaudible tones is optional in the United States, so the TSU-3 is made available as an optional accessory. This unit provides for both Encode and Decode. The decode section allows for T.SQ operations. With this option you will only hear those stations that transmit the same subaudible tone. Other stations will not open the squelch of your radio. In the United States 37 standard tone frequencies are available.

The TH-205AT/205A/205E provides for all three tone types. To activate the appropriate tone signalling device depress the TONE switch on the top of the radio.

### ● Autopatch operations (with the TH-205AT)

Some repeaters offer a service known as AUTOPATCH. This allows you to dial a telephone number from your radio and carry out a telephone conversation, much like a car telephone, or cellular telephone. This function requires the use of a DTMF (Dual Tone Multi Frequency) pad. This is also known as a touch tone pad. It operates just like the touch tone pad on your home telephone. In addition to the normal 12 keys that are found on your telephone the TH-205AT also provides 4 additional keys A, B, C, and D. These keys are required by some repeater systems for various control functions. You should check with the control operator of your repeater to determine if their use is required. A chart is provided that lists the tones that are generated when you press each key.

To use the touch tone pad you should first key the radio using the PTT switch. Then simply press the numbers corresponding to the telephone number you want to dial. Some repeaters will require a special sequence of keys to activate the autopatch. Again you should check with the control operator of your repeater for this sequence.

After you have pressed the first number key the radio will remain keyed for approximately 2 seconds. This is done so you do not have to hold the PTT key depressed while dialing. The radio remains keyed after you press each number for this 2 second interval.

Audio tones (Hz)

Column \ Row	1215.9	1331.7	1471.9	1645.0
701.3	1	2	3	A
771.4	4	5	6	B
857.2	7	8	9	C
935.1	*	0	#	D



## ■ SCAN

For scan to operate properly, adjust the SQL control clockwise to silence noise.

Press the **▲** key and **[SCAN]** key in this order increment the displayed frequency in 5 kHz step.

When a signal is present and squelch is open, scan is released.

Press **[SCAN]** key or PTT switch to clear scan mode.

Also **[CALL]** key, **[M]** key, **▲** key and **▼** key can clear scan mode. These keys continue their own functions.

## ■ MEMORY ENTRY

Three memory channels have been provided in the TH-205AT/205A/205E for storing frequency, offset, and reverse switch status.

To store data into memory press the **[M]** key and then the desired channel number (1, 2, or 3).

### Example:

Store 145.250 MHz into memory channel 1 with a -600 offset.

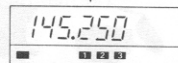
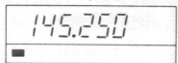
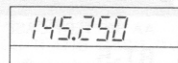

1. Select 145.250 using the UP/ DOWN keys.

2. Select -600 offset using the OFFSET/R key.

3. Press the **[M]** key.

## ■ MEMORY RECALL

To recall data from memory you only need to press the desired memory channel key. For example the display is currently showing 144.000 MHz.

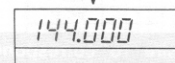
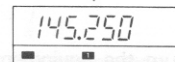

4. Press the desired memory channel number within 5 seconds of pressing the **[M]** key, this will actually store the information into memory.

1. Press the "1" key.

2. The data that was previously stored will now appear in the display, and the radio will switch to this frequency.

To return to the original operating frequency press the "1" key again.

## ■ AUTO BATTERY SAVER (ABS)

The Auto Battery Saver function provides to conserve battery power during reception and this extends operation time. The function activates automatically 1 minute after the last key operation during squelch is closed.

When a signal is received, the function is automatically released.

# MAINTENANCE

## ■ IN CASE OF DIFFICULTY

Indicator does not light and frequency is not displayed when power switch is pressed.

Wrong power polarities. Be sure to observe the polarities.

Display is dark. ([BATT] lights.)

Input voltage is low. Check voltage.

No sound from the speaker. No signal can be received.

1. Squelch is closed. Turn the SQL knob counterclockwise.
2. T.SQ is activated. Turn the SQL knob clockwise past the detent position.
3. PTT switch of microphone is pressed setting the unit in the transmit mode. Turn PTT switch off.

No control works.

LOCK is ON. Press F. LOCK key.

No output

1. Microphone jack is not fully plugged in. Insert the plug fully.
2. Poor antenna connection. Connect antenna securely.

Memory loss.

Backup battery voltage is low. Contact the authorized dealer.

All the indicators go out of the display.

Turn the power switch OFF and then ON.

## ■ SERVICE

Should it ever become necessary to return the equipment to your dealer or service center for repair, pack in its original box and packing, and include a full description of the problems involved. Also include your telephone number. You need not return accessory items unless directly related to the service problem.

**Service note:** Dear OM, if you desire to correspond on a technical or operational problem, please make your note short, complete, and to the point. And PLEASE make it readable.

Please list: Model and serial number.

The question or problem you are having.

When claiming warranty service, a photocopy of the bill of sale, or other proof of purchase showing the date of sale must accompany the radio.

## OPTION

SWIVEL HOOK

**BH-5**

TELESCOPIC ANTENNA

**RA-3**

EXTERNAL SPEAKER/  
MICROPHONE

**SMC-30**



SOFT CARRYING CASE

**SC-13**

(for PB-1/4)



TONE SQUELCH UNIT

**TSU-3**



SOFT CARRYING CASE

**SC-12**



ULTRA-LIGHT  
HEADPHONES

**HS-7**

MICRO HEADPHONE

**HS-8**

MOBILE BRACKET

**MB-4**

DC LINE  
NOISE FILTER

**PG-3C**

(for MOBIL  
CIGAR OUTLET)



DC CABLE

**PG-2V**



## POWER SUPPLY

Ni-Cd RECHARGEABLE  
BATTERY PACK

**PB-1**

12V 800mAh



Ni-Cd RECHARGEABLE  
BATTERY PACK

**PB-3**

7.2V 800mAh



AA BATTERY CASE

**BT-5**



Ni-Cd RECHARGEABLE  
BATTERY PACK

**PB-2**

8.4V 500mAh



Ni-Cd RECHARGEABLE  
BATTERY PACK

**PB-4**

7.2V 1600mAh



BATTERY CHARGER

**BC-2**

(for PB-2 only)

RAPID CHARGER

**BC-7**

(for PB-1/2/3/4)



COMPACT CHARGER

**BC-8**

(for PB-1/2/3/4)



NOTE: Some optional accessories may not be available in your areas.

## ■ TONE SQUELCH UNIT (TSU-3)

Tone squelch (CTCSS) enables you to listen only for those stations that transmit the proper code frequency. The TSU-3 provides any one of 37 possible tones from 67.0 to 250.3 Hz. To actuate the tone squelch function (decode), turn the Squelch control fully counterclockwise past the detent. Squelch will now open only when the radio receives the same subtone frequency.

To return to normal noise activated squelch turn the Squelch control clockwise past the detent.

To activate the transmit tone section of the TSU-3 the TONE switch on the top of the radio must be ON.

It is good operating practice to check the frequency of operation before transmitting. A MONITOR switch has been provided for this purpose when using the TONE SQUELCH function. Pressing this switch will open the squelch so you can check for activity.

## ● INSTALLATION

1. Remove the four phillips head screws from the rear corners of the radio.
2. Turn the case over and gently remove the front panel. The panel should be rotated away from the PTT switch side.
3. Install the tone squelch unit between the bottom of the set and the main circuit board. The TSU-3 should be placed so that the DIP switch is visible thru the opening in the bottom of the case.
4. Attach the cable from the TSU-3 as shown in the diagram. The cable should be routed under the ribbon cable that goes to the front panel.
5. Remove the backing from the foam cushion that was provided with the TSU-3 and attach the cushion to the back of the TSU-3.
6. Replace the covers and tighten the screws to complete the installation.

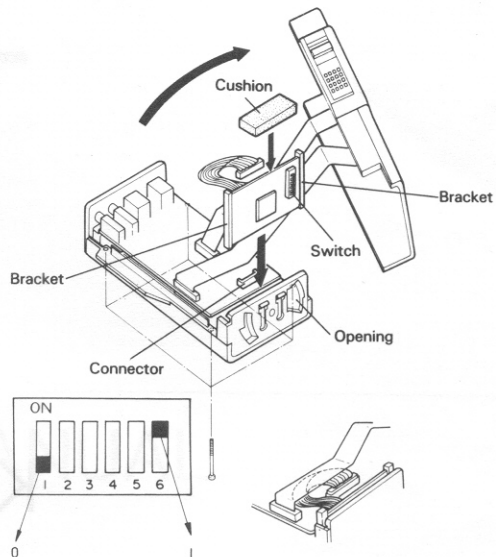

Frequency code

	1	2	3	4	5	6
67.0Hz	0	1	0	0	0	1
71.9Hz	1	1	0	0	0	1
74.4Hz	0	0	1	0	0	1
77.0Hz	1	0	1	0	0	1
79.7Hz	0	1	1	0	0	1
82.5Hz	1	1	1	0	0	1
85.4Hz	0	0	0	1	0	1
88.5Hz	1	0	0	1	0	1
91.5Hz	0	1	0	1	0	1
94.8Hz	0	1	1	0	0	0
100.0Hz	1	1	1	0	0	0
103.5Hz	0	0	0	1	0	0
107.2Hz	1	0	0	1	0	0
110.9Hz	0	1	0	1	0	0
114.8Hz	1	1	0	1	0	0
118.8Hz	0	0	1	1	0	0
123.0Hz	1	0	1	1	0	0
127.3Hz	0	1	1	1	0	0
131.8Hz	1	1	1	1	0	0

	1	2	3	4	5	6
136.5Hz	0	0	0	0	1	0
141.3Hz	1	0	0	0	1	0
146.2Hz	0	1	0	0	1	0
151.4Hz	1	1	0	0	1	0
156.7Hz	0	0	1	0	1	0
162.2Hz	1	0	1	0	1	0
167.9Hz	0	1	1	0	1	0
173.8Hz	1	1	1	0	1	0
179.9Hz	0	0	0	1	1	0
186.2Hz	1	0	0	1	1	0
192.8Hz	0	1	0	1	1	0
203.5Hz	1	1	0	1	1	0
210.7Hz	0	0	1	1	1	0
218.1Hz	1	0	1	1	1	0
225.7Hz	0	1	1	1	1	0
233.6Hz	1	1	1	1	1	0
241.8Hz	0	0	0	0	0	1
250.3Hz	1	0	0	0	0	1

# MAINTENANCE

## IN CASE OF DEFECT

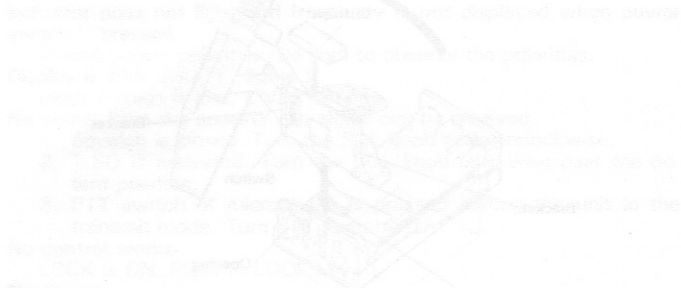

1. Turn the cover over and gently remove the front panel. The front panel should be set away from the switch tab.

2. Insert the tone squelch switch between the bottom of the set and the main circuit board. The TSU-3 should be placed so that the DIP switch is visible thru the opening in the bottom of the case.

3. Attach the cable to the TSU-3 as shown in the diagram. The cable should be mounted under the ribbon cable that goes to the front panel.

4. Remove the backing from the foam cushion that was provided with the TSU-3 and attach the cushion to the back of the TSU-3.

5. Replace the cover and tighten the screws to complete the installation.

# KENWOOD

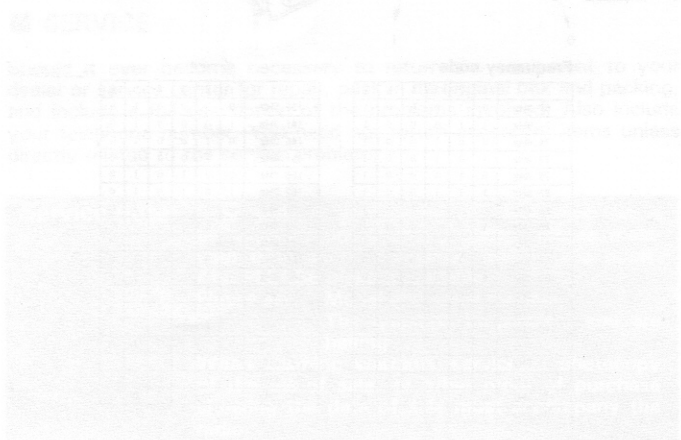

## TONE SQUELCH UNIT (TSU-3)

This special TCT-281 enables you to listen only for those tones that have the proper code frequency. The TSU-3 provides any of the 21 possible tones from 87.0 to 250.3 Hz. To activate the tone squelch function (should you detect a squelch code), fully counter-clockwise pull the detent. Squelch will now open only when the radio receives the same squelch frequency.

To operate normally once activated squelch turn the squelch code to clockwise past the detent.

To activate the transmit lock function of the TSU-3, flip the switch on the top of the radio, set to ON.

It is good operating practice to check the frequency of operation before transmitting. A METER DR switch has been provided for the rigging whenever the TONE SQUELCH function. Pressing the switch will turn the squelch so you can check for accuracy.

## INSTALLATION

1. Turn the cover over and gently remove the front panel. The front panel should be set away from the switch tab.

2. Insert the tone squelch switch between the bottom of the set and the main circuit board. The TSU-3 should be placed so that the DIP switch is visible thru the opening in the bottom of the case.

3. Attach the cable to the TSU-3 as shown in the diagram. The cable should be mounted under the ribbon cable that goes to the front panel.

4. Remove the backing from the foam cushion that was provided with the TSU-3 and attach the cushion to the back of the TSU-3.

5. Replace the cover and tighten the screws to complete the installation.

## Free Manuals Download Website

<http://myh66.com>

<http://usermanuals.us>

<http://www.somanuals.com>

<http://www.4manuals.cc>

<http://www.manual-lib.com>

<http://www.404manual.com>

<http://www.luxmanual.com>

<http://aubethermostatmanual.com>

Golf course search by state

<http://golfingnear.com>

Email search by domain

<http://emailbydomain.com>

Auto manuals search

<http://auto.somanuals.com>

TV manuals search

<http://tv.somanuals.com>