



DESIGNED SMART. BUILT SOLID.®

## INSTALLATION AND OPERATING INSTRUCTIONS

### Manual Heavy Duty Gas Griddles

**Models: HMG-2424i, HMG-2436i, HMG-2448i, HMG-2460i, HMG-2472i**

(US & Canadian units are convertible and are assembled for Natural Gas)

(European units are not convertible and assembled for the appropriate gas)



**WARNING:** California Residents Only. This product can expose you to chemicals including chromium which is known to the State of California to cause cancer and birth defects or other reproductive harm. For more information go to [www.P65Warnings.ca.gov](http://www.P65Warnings.ca.gov).



**FOR YOUR SAFETY:** Do not store or use gasoline or other flammable vapors and liquids in the vicinity of this or any other appliance.



**WARNING:** Improper installation, operation, service or maintenance can cause property damage, injury or death. Read and understand these instructions thoroughly before positioning, installing, maintaining or servicing this equipment.



**WARNING:** Instructions must be posted in a prominent location. All safety precautions must be taken in the event the user smells gas. Safety information can be obtained from your local gas supplier.

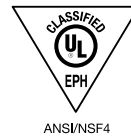





P/N 8822241 Rev 09/18



**APW Wyott Food Service Equipment Company**  
1307 N. Watters Road, Suite 180 • Allen, TX 75013



972.908.6100 Phone  
214.565.0976 Fax

+1.800.527.2100  
[www.apwwyott.com](http://www.apwwyott.com)

 **CAUTION:** These models are designed, built, and sold for commercial use. If these models are positioned so the general public can use the equipment, make sure that cautions, warnings, and operating instructions are clearly posted near each unit so that anyone using the equipment will use it correctly and not injure themselves or harm the equipment. 

 **WARNING:** Improper installation, adjustment, alteration, service or maintenance can cause property damage, injury or death. Read the installation, operating and maintenance instructions thoroughly before installing or servicing this equipment. 



 **WARNING:** For your safety do not store or use gasoline or other flammable vapors and liquids in the vicinity of this or any other appliance. Keep the area free and clear of combustibles. (See ANZI Z83. 14B, 1991). 

 **NOTICE:** Instructions to be followed if anyone smells gas should be posted in a prominent place. These may be obtained from the gas supplier. 

**GAS PRESSURE**

The appliance and its individual shutoff valve (to be supplied by user) must be disconnected from the gas supply piping system during any pressure testing of that system at test pressures in excess of 1/2 psi (3.45 kPa).

The appliance must be isolated from the gas supply piping system by closing its individual manual shut-off valve during any pressure testing of the gas supply piping system at test pressures equal to or less than 1/2 psi (3.45 kPa).

 **WARNING:** A factory authorized agent should handle all maintenance and repair. Before doing any maintenance or repair, contact APW Wyott. 

Congratulations on your purchase of APW Wyott® commercial cooking or refrigeration equipment. APW Wyott takes pride in the design and quality of our products. When used as intended and with proper care and maintenance, you will experience years of reliable operation from this equipment. To ensure best results, it is important that you read and follow the instructions in this manual carefully.

**TABLE OF CONTENTS**

<b>ITEM</b>	<b>PAGE</b>	<b>ITEM</b>	<b>PAGE</b>
Safety Precautions .....	3	Cleaning/Maintenance .....	9
General Installation Instructions .....	4	Service/Repair .....	9
Specifications & Dimensions.....	5	Troubleshooting Guide .....	10
Conversion .....	6	Replacement Parts Lists & Exploded Views ....	11
Lighting Instructions.....	7	Warranty .....	16
Operating Instructions.....	8		

**Location Of Data Plate**

The data plate is located on the rear panel.

## Immediately Inspect For Shipping Damage

All containers should be examined for damage before and during unloading. The freight carrier has assumed responsibility for its safe transit and delivery. If equipment is received damaged, either apparent or concealed, a claim must be made with the delivering carrier.

- A) Apparent damage or loss must be noted on the freight bill at the time of delivery. It must then be signed by the carrier representative (Driver). If this is not done, the carrier may refuse the claim. The carrier can supply the necessary forms.
- B) Concealed damage or loss if not apparent until after equipment is uncrated, a request for inspection must be made to the carrier within 15 days. The carrier should arrange an inspection. Be certain to hold all contents and packaging material.

















Installation and start-up should be performed by a qualified installer who thoroughly read, understands and follows these instructions.

If you have questions concerning the installation, operation, maintenance or service of this product, write Technical Service Department APW Wyott, 1307 N Watters Rd # 180, Allen, TX 75013

## SAFETY PRECAUTIONS

Before installing and operating this equipment be sure everyone involved in its operation is fully trained and is aware of all precautions. Accidents & problems can result by a failure to follow fundamental rules and precautions.

The following words and symbols, found in this manual, alert you to hazards to the operator, service personnel or the equipment. The words are defined as follows:

	<b>DANGER:</b> This symbol warns of imminent hazard which will result in serious injury or death.	
	<b>WARNING:</b> This symbol refers to a potential hazard or unsafe practice, which could result in serious injury or death.	
	<b>CAUTION:</b> This symbol refers to a potential hazard or unsafe practice, which may result in or moderate injury or product or property damage	
	<b>NOTICE:</b> This symbol refers to information that needs special attention or must be fully understood even though not dangerous.	
	<b>NOTICE:</b> This product is intended for commercial use only. Not for household use.	
	<b>CAUTION:</b> These models are designed, built, and sold for commercial use. If these models are positioned so the general public can use the equipment make sure that cautions, warnings, and operating instructions are clearly posted near each unit so that anyone using the equipment will use it correctly and not injure themselves or harm the equipment.	
	<b>WARNING:</b> Improper installation, operation, service or maintenance can cause property damage, injury or death. Read and understand these instructions thoroughly before positioning, installing, maintaining or servicing this equipment.	
	<b>WARNING:</b> Keep the appliance free & clear of all combustible substances. If gas odor is detected at any time, immediately shut unit down at the main shutoff valve. Do not permit any open flames in the area of the appliance. Immediately contact an authorized Service Agency or your local Gas Supplier for service.	



**WARNING:** Do not obstruct either the air inlet (underneath unit) or the ventilation air (back of unit). Provisions must be provided to provide an adequate air supply to the griddle.



**NOTICE:** Local codes regarding installation vary greatly from one area to another. The National Fire Protection Association, Inc., states in its NFPA96 latest edition that local codes are “Authority Having Jurisdiction” when it comes to requirement for installation of equipment. Therefore, installation should comply with all local codes.



## GENERAL INSTALLATION INSTRUCTIONS

Ensure gas supply and gas type, as shown on unit nameplate agree.

Unit installation must conform with the National Fuel Gas Code, ANSI Z223.1/NFPA 54, the National Gas Installation Code, CSA-B149.1, or the Propane Installation Code, CSA-B149.2 as applicable and in accordance with local codes.

Screw legs into the permanently fastened nuts on the four corners of the unit and tighten by hand. Level the unit by turning the adjustment screw at the bottom of each leg. Do not slide unit with legs mounted, lift if necessary to move unit.

Pipe threading compound must be resistant to the action of liquefied petroleum gases.

**Caution:** DO NOT use an open flame to check for leaks. Check all gas piping for leaks with a soap and water solution before operating unit.

### **THESE UNITS ARE SUITABLE FOR INSTALLATION ON NON-COMBUSTIBLE SURFACES ONLY.**

Noncombustible clearances:

0” sides (0 mm) 0” rear (0 mm) 4” floor (102mm)

Do not obstruct the flow of combustion and ventilation air, under the unit by the legs or behind the unit by the flue.

Adequate clearance for air openings into the combustion chamber is required. Do not place objects between the bottom of the unit and the counter top.

There must be adequate clearance for removal of the front panel. All major parts except the burners are removable thru the front if the gas line is disconnected.

Unit must have adequate clearances for servicing. (Sides = 0”, Rear = 0”, Floor = 4”).

### **European Community Installation Instructions:**

“THIS APPLIANCE MUST BE FITTED BY A COMPETENT PERSON. IN THE UK, CORGI REGISTERED INSTALLERS (INCLUDING THE REGIONS OF BRITISH GAS) UNDERTAKE TO WORK TO SAFE AND SATISFACTORY STANDARDS. THIS APPLIANCE MUST BE INSTALLED IN ACCORDANCE WITH THE GAS SAFETY (INSTALLATION AND USE) REGULATIONS AND THE RELEVANT BUILDING REGULATIONS / IEE. REGULATIONS. DETAILED RECOMMENDATIONS ARE CONTAINED IN THE FOLLOWING BRITISH STANDARD CODES OF PRACTICE - BS 6172, BS 5440 PART 2, BS 6891”

“THIS APPLIANCE MUST BE INSTALLED IN ACCORDANCE WITH THE RULES IN FORCE”

“MUST BE INSTALLED IN A WELL VENTILATED AREA. Ventilation requirements ie. B.S. 5440.”

## SPECIFICATIONS AND DIMENSIONS

MODEL	WIDTH IN. (MM)	DEPTH IN. (MM)	HEIGHT IN. (MM)	# OF BURNERS	BTU/kW BURNER	TOTAL BTU/kW HOUR	W.C IN. ("Mbar")
HMG-2424i	23.844" (605.6)	24" (609.6)	15.437" (392.1)	2	32,000 (9.78)	64,000 (18.8)	5 (12.4)
HMG-2436i	35.844" (910.4)	24" (609.6)	15.437" (392.1)	3	32,000 (9.78)	96,000 (28.1)	5 (12.4)
HMG-2448i	47.844" (1215.2)	24" (609.6)	15.437" (392.1)	4	32,000 (9.78)	128,000 (37.5)	5 (12.4)
HMG-2460i	59.844" (1520.0)	24" (609.6)	15.437" (392.1)	5	32,000 (9.78)	160,000 (46.9)	5 (12.4)
HMG-2472i	71.844" (1824.8)	24" (609.6)	15.437" (392.1)	6	32,000 (9.78)	192,000 (56.3)	5 (12.4)

MODEL	WIDTH (A)	DEPTH (B)	HEIGHT (C)	Leg Spacing (D)	Leg Spacing (E)
HMG-2424i	24" (609.6)	33.3" (846)	15.5" (392.1)	21.0" (533)	23.6" (600)
HMG-2436i	36" (914.4)	33.3" (846)	15.5" (392.1)	33.0" (838)	23.6" (600)
HMG-2448i	48" (1219.2)	33.3" (846)	15.5" (392.1)	45.0" (1143)	23.6" (600)
HMG-2460i	60" (1524.0)	33.3" (846)	15.5" (392.1)	57.0" (1448)	23.6" (600)
HMG-2472i	72" (1828.8)	33.3" (846)	15.5" (392.1)	69.0" (1753)	23.6" (600)

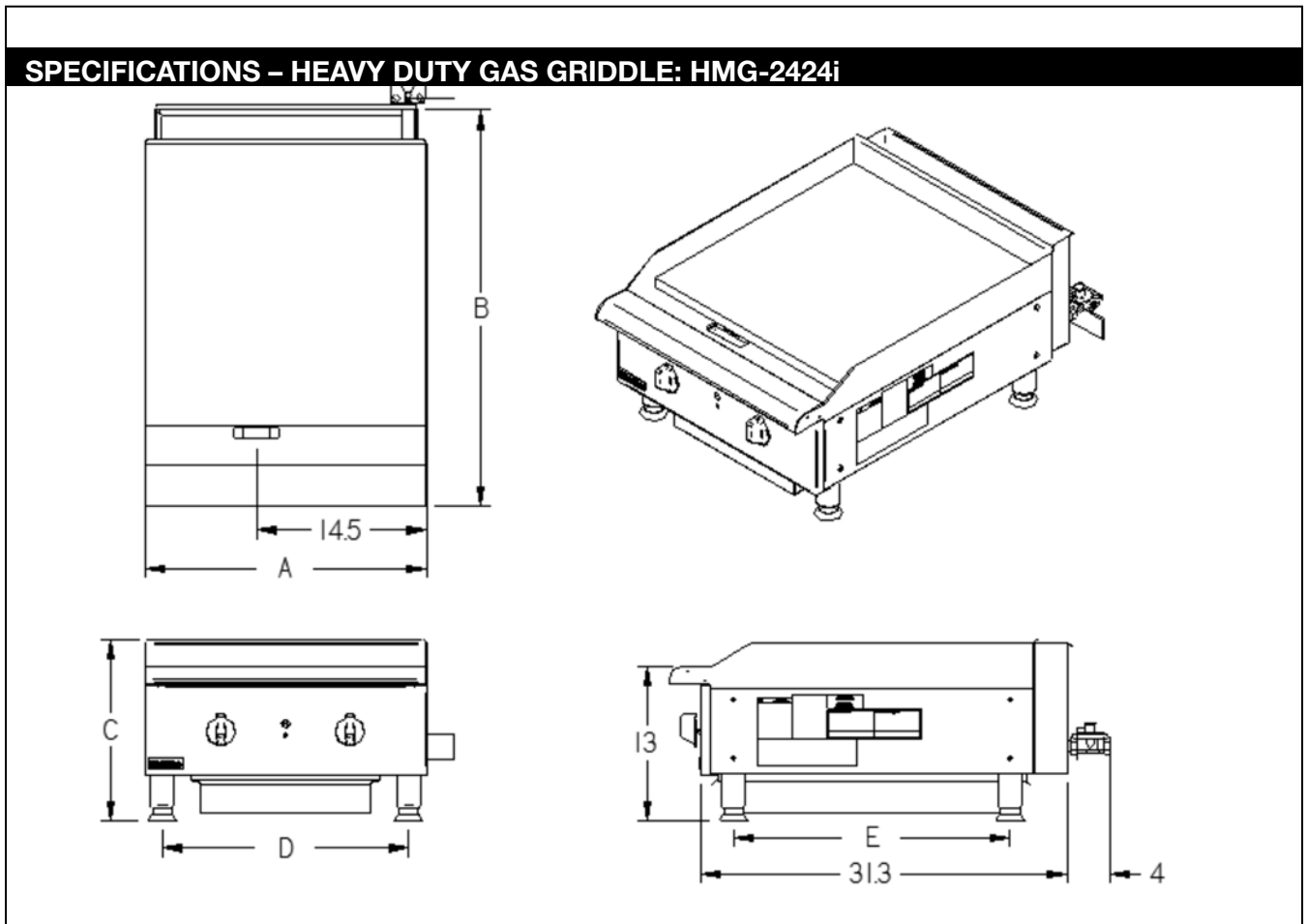

## CONVERSION

- Instructions are for conversion from Natural Gas to Propane (L.P.) on all models HMG.
- The conversion should be done before connecting the unit to the gas supply.
- Units are shipped from the factory equipped for use on natural gas. Orifices necessary for LP (propane) are provided in a bag tied to the valve on the front panel.
  1. Remove the knobs and front panel.
  2. Remove the orifice fittings from the valve. Change the orifices to the size recommended for propane (L.P.).
  3. Replace the orifice fittings into the valve.
- To change the regulator:

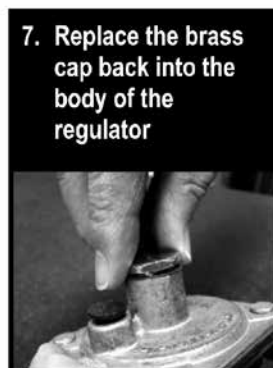

- Connect the regulator to the unit, connect gas and check for leaks.  
**WARNING:** Do not use an open flame to check for leaks.
- Check the system pressure. With the front panel removed remove the plug from the manifold.
- Place a fitting in the plug opening and connect a manometer.
- For Natural gas the pressure in the manifold should be 5" water column or 12.4 millibar. For LP the pressure in the manifold should be 10" water Column of 24.9 millibar.
- To adjust the pressure, remove the brass cap and turn the white plastic part inside the stem of the regulator. See picture regulator 8.
- Take a wide straight screw driver and place it in the two notches shown in picture regulator 7. Turn clockwise to increase pressure and counter-clockwise to reduce pressure. See picture regulator 8.
- Once the pressure has been adjusted replace the brass cap.
- Note the blue cap on the regulator, this is the vent there are openings below the top rim.  
**NEVER** block these openings your regulator will fail to operate correctly. On at least a monthly basis blow off any dust or grease which may accumulate around this cap. The openings must remain open for the regulator to function. Clean more often in a very greasy atmosphere.

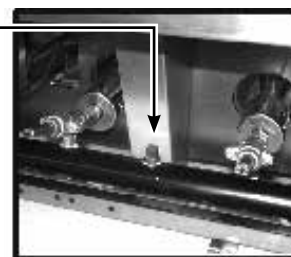

## LIGHTING INSTRUCTIONS

HMG Griddles are furnished with either a pilot safety valve or a standing pilot (not available in the European Community). Please follow the instructions for your unit. HMG Griddles are furnished with either a flame failure pilot or a standing pilot (not available in the European community).

### **Pilot Operation Flame Failure Gas Valve:**

Operation of the gas valve pilot:

1. Turn knob on the main gas valve to the pilot position
2. Depress knob to start gas flow to the pilot valve
3. Light pilot valve
  - a. Using a match or taper
4. Hold in knob for 15 to 30 seconds to heat up the thermocouple
5. Release knob and turn to the desired gas flow position
  - a. If pilot goes out repeat steps 1-4, some thermocouples will take longer to heat up

### **Standing Pilot Lighting Instructions: (Not Available in the European Community)**

The pilot lights on the broilers have been set at the factory. A screwdriver may be required for the first lighting to adjust the flame for your elevation.

1. Turn off the manual shut off valve and wait 5 minutes to clear the gas.
2. Turn all knobs to the "OFF" position.
5. The valve can be accessed through an opening in the front panel or remove the cooking grates and light the pilot from above.
4. Turn the manual shut off valve on.
5. Hold an ignition source (match) to both openings on the pilot tube. When the flames are established, remove the ignition source.
6. Turn the burner knobs to "HI". If the burner does not ignite, promptly open the pilot valve more. If the pilot flame appears larger than necessary, turn it down and reset burner ignition. The pilot flame should be as small as possible but large enough to guarantee reliable ignition of the burners when the knobs are turned to "HI".

### **Relighting Pilot**

If the pilot light should go out for any reason:

- Promptly shut off all gas at the manual shut off valve.
- Turn off all knobs and pilot valves; wait 5 minutes to clear gas.
- Relight following steps 4 through 6 under Standing Pilot Lighting Instructions.

### **HMG Lighting Main Burner:**

Since the burner is lit from constantly burning pilot, turn knobs to "HI" to put the unit in operation; then adjust to any desired position between "LO" and "HI".

- To light burner, turn knob to "max." then back off to the desired flame level. The range of adjustment is virtually infinite between high and off. (At the small flame, there is a pre-set low).
- When the broiler is first heated, it will smoke until oil used in manufacturing, preservation and dust from storage and shipping are burned off. An hour at "max." on all burners is usually sufficient.
- Turn knobs off and let cool.

- For first cooking, set the grates at maximum tilt position and preheat before broiling. You will have to experiment with knob settings and grate position for each particular item.
- Keep the grease/water pan with sufficient water to cover the entire bottom.
- Clean regularly. Grates may be removed for washing in the sink. Brush out carbonized particles. Thoroughly wash the grease/water pan.

**European Community:**

**If adjustment becomes necessary in the field, it should be done by a factory authorized and trained technician who should seal the screw after the adjustment to safeguard against unauthorized tampering by the end user.**

All burners are lit from constantly burning pilots. Turning the valve to the desired flame height is all that is required to put the unit in service.

Do not permit fans to blow directly at the unit. Wherever possible, avoid open windows next to the units' sides or back. Avoid wall type fans which create air cross-currents within a room.

It is also necessary that sufficient air should be allowed to enter the room to compensate for the amount of air removed by any ventilating system. Otherwise, a subnormal atmospheric pressure will occur, affecting operation and causing undesirable working conditions.

A properly designed and installed hood will act as the heart of the ventilating system for the room or area in which the unit is installed, and will leave the unit independent of changing draft conditions.

All valves must be checked and lubricated periodically. This must be done by an authorized service representative in your area.



**OPERATING INSTRUCTIONS**



**Season Griddle**

Heat to low temperature (300 - 350 F/150-180C) and pour on a small amount of cooking oil, about one ounce (30cc) per square foot of surface. Spread the oil over the entire griddle surface with a cloth to create a thin film. Wipe off any excess oil with a cloth. Repeat this procedure 2 to 3 times until the griddle has a slick, mirror-like surface.

**Operation**

Turn the burners on about 15-20 minutes before cooking for preheating. Set the knobs to the desired flame height (HMG). Each valve will control the gas flow to the burner to bring that area of the plate up to the set temperature. If different temperature settings are to be used, adjoining areas should be set at progressively higher temperatures using the lowest temperatures on the outside burners. A uniform and systematic approach to the loading of the griddle will produce the most consistent product results.

	<b>CAUTION:</b> Do not turn on gas valves without lighting the pilots. This could cause a build up of gas and potential explosion.	
---	--	---

	<b>NOTICE:</b> Due to heat transfer thru the griddle plate, adjoining zones can be no more than 25° different.	
---	--	---



## CLEANING / MAINTENANCE

### Initial Cleaning:

Prior to operating your new griddle, thoroughly wash the griddle surface and the exterior with a mild detergent or soap solution. Do not use abrasive cleaners since this might damage the cabinet finish. If the stainless steel surfaces become discolored, scrub by rubbing only in the direction of the finished grain.

### Cleaning:

1. Always turn unit off and allow it to cool completely before cleaning. Clean thoroughly before first use.
2. After each use, clean the griddle with wire brush or flexible spatula.
3. Once a day, thoroughly clean splash back, sides and front. Remove the grease drawer, empty it and wash it out.
4. Once a week, clean the griddle surface thoroughly. If necessary, use a griddle stone, wire brush or steel wool on the surface. Rub with the grain of the metal while the griddle is still warm. A detergent may be used on the plate surface to help clean it; but, care must be taken to be sure the detergent is thoroughly removed. After removal of the detergent, the surface of the plate should then be covered with a thin film of oil to prevent rusting. Clean stainless surfaces with a damp cloth and polish with a soft dry cloth. To remove discoloration, use a nonabrasive cleaner. After each "weekly" cleaning, the griddle must be seasoned again. If the griddle usage is very high, the "weekly" cleaning procedures may be done more often than once a week.

### EXTENDED SHUTDOWN

Turn the manual shutoff valve to "OFF"; (field installed valve not supplied by the manufacturer); turn all control knobs to the "OFF" position; and shut off the pilot flame by turning the adjustment on the pilot valve.

**\*NOTE:** Gas shutoff valve is supplied by the manufacturer on CE or European Community models. If the griddle is to be shut down for an extended period, put a heavy coat of grease over the griddle plate.

### SERVICE / REPAIR

**NOTE:** THIS APPLIANCE MUST ONLY BE SERVICED BY AN AUTHORIZED AGENT.

NOTE: Parts protected by the manufacturer or his agent are not to be adjusted by the installer unless the installer is an authorized service agent.

**If you have any questions or problems contact your nearest APW Wyott Service Representative.**

## TROUBLESHOOTING GUIDE

PROBLEM	POSSIBLE CAUSE
Heat does not come on when thermostat is turned on.	Thermostat is bad.
	Pilot burner not lit.
	Gas valve is bad.
Pilot burner will not light.	Obstructed pilot orifice.
	Pilot gas turned off at automatic pilot.
	Automatic pilot valve is bad.
Pilot burner will not stay lit.	Thermocouple is bad.
	Thermocouple is not hot enough.
	Obstructed or wrong size pilot orifice.
	Gas supply is not purged of air.
	Air is blowing pilot light out.
	Automatic pilot valve is bad.
Fat appears to smoke excessively.	Heat is set too high.
	Moisture in the food may be turning into steam.
Food sticks to griddle.	Heat is set too high.
	Griddle surface needs cleaning and/or seasoning.
	Surface under food may not have been covered with enough cooking oil.
Food burned around edges or contains dark specks.	Heat is set too high.
	Griddle surface needs cleaning and/or seasoning.
	Surface under food may not have been covered with enough cooking oil.
Food is undercooked inside.	Heat is set too high.
	Food may not have been cooked for long enough time.
Food tastes greasy or has objectionable off-flavor.	Food itself may have off flavor.
	Food may have been stored improperly before cooking.
	Too much griddle fat used.
	Heat is set too low.
Noticeable build-up of gum on griddle.	Heat is set too high
	Griddle surface needs cleaning and/or seasoning.
	Too much griddle fat used.

# HMG GRIDDLES (DOMESTIC) - EXPLODED VIEW & PARTS LIST

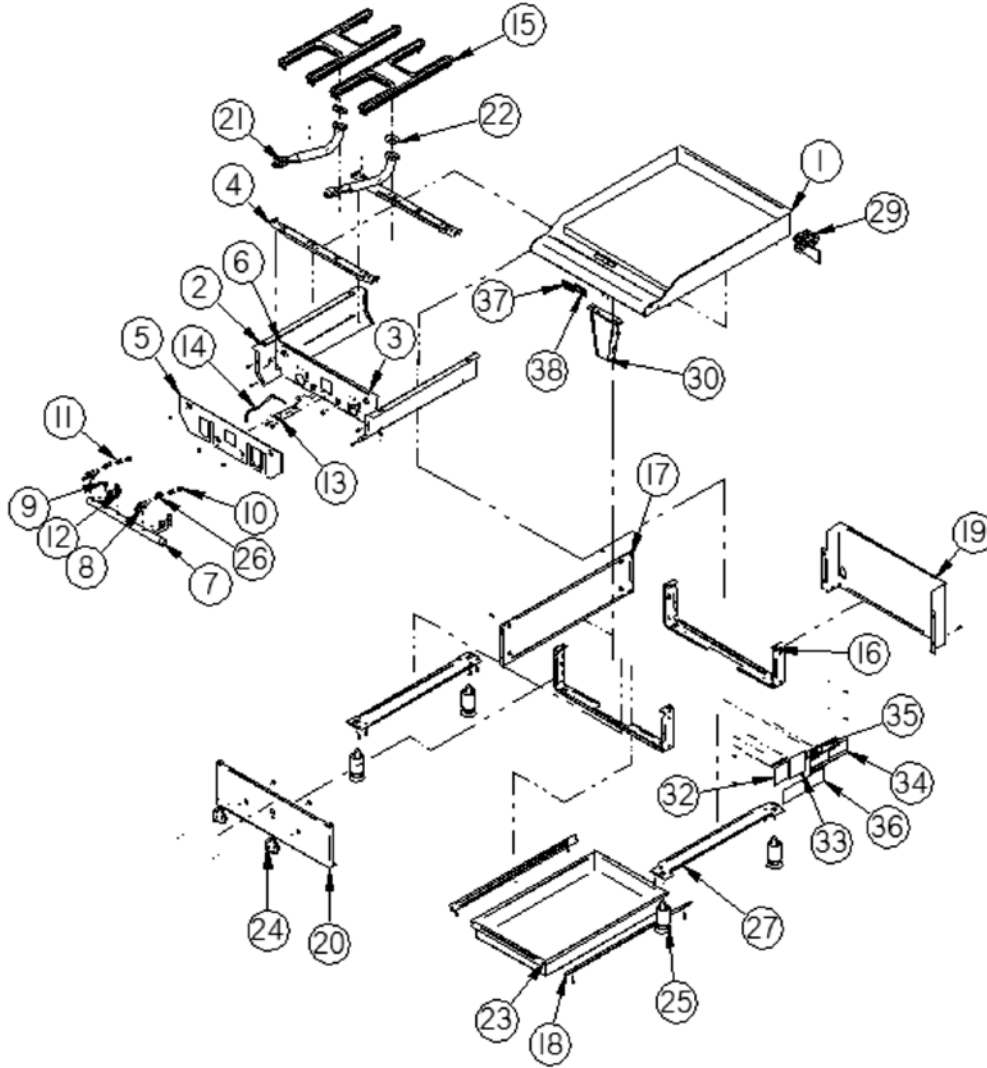

Item	P/N	Description	HMG-2424i	HMG-2436i	HMG-2448i	HMG-2460i	HMG-2472i
1	22241254	Weldm't, Griddle Plate	1				
	22241374	Weldm't, Griddle Plate		1			
	22241494	Weldm't, Griddle Plate			1		
	22241614	Weldm't, Griddle Plate				1	
	22241734	Weldm't, Griddle Plate					1
2	21826433	Side, Firebox	2	2	2	2	2
3	21826022	Body, 24" Firebox	1				
	21826122	Body, 36" Firebox		1			
	21826222	Body, 48" Firebox			1		
	21826322	Body, 60" Firebox				1	
	21826422	Body, 72" Firebox					1
4	21826017	Support, Burner	2				
	21826117	Support, Burner		2			
	21826217	Support, Burner			2		
	21826317	Support, Burner				2	
	21826427	Support, Burner					2
5	21826027	Baffle, Front Heat	1				
	21826127	Baffle, Front Heat		1			
	21826227	Baffle, Front Heat			1		
	21826327	Baffle, Front Heat				1	
	21826427	Baffle, Front Heat					1

Item	P/N	Description	HMG-2424i	HMG-2436i	HMG-2448i	HMG-2460i	HMG-2472i
6	21813085	Spacer	4	4	5	5	6
7	21830725	Manifold, 24"	1				
	21830825	Manifold, 36"		1			
	21830925	Manifold, 48"			1		
	21831025	Manifold, 60"				1	
	21831125	Manifold, 72"					1
8	2068500	Valve, Gas 210° On/Off	2	3	4	5	6
9	2092517	Plug, 1/8 NPTM	1	1	1	1	1
10	2066834	Hood, Orifice #34	2	3	4	5	6
11	2066851	Hood, Orifice #51	2	3	4	5	6
12	2068002	Valve, Pilot 90°	1	2	2	3	3
13	21825113	Bracket, Pilot	1	2	2	3	3
14	21830712	Burner, Pilot	1	2	2	3	3
15	2065846	Burner Cast H	2	3	4	5	6
16	22400010	Support, Leg 24"	2				
	22400015	Support, Leg 36"		2			
	22400020	Support, Leg 48"			2		
	22400025	Support, Leg 60"				2	
	22400030	Support, Leg 72"					2
17	21826053	Panel, Right & Left Side	2	2	2	2	2
18	21825011	Guide, Grease Slide	2	2	2	2	2
19	21826052	Panel Back 24"	1				
	21826652	Panel, Back 36"		1			
	21826252	Panel, Back 48"			1		
	21826332	Panel, Back 60"				1	
	21826452	Panel, Back 72"					1
20	22241253	Panel, Control 24"	1				
	22241373	Panel, Control 36"		1			
	22241493	Panel, Control 48"			1		
	22241613	Panel, Control 60"				1	
	22241733	Panel, Control 72"					1
21	2065849	Venturi, Hvy Dty Griddles	2	3	4	5	6
22	2065916	Gasket, Burner	2	3	4	5	6
23	2425310	Pan, Grease 24"	1	1	1	1	1
24	8706300	Knob, Metal Cookline .375 D Shaft, no Logo	2	3	4	5	6
25	8633700	Leg, 2" Dia. Hvy Dty	4	4	4	4	4
26	2065839	Adapter, 15° Angle Elbow	2	3	4	5	6
27	22400003	Brace, Leg	2	2	2	2	2
28*	21826134	Channel, Stiffener	NA	1			
	21826234	Channel, Stiffener			1		
	21826334	Channel, Stiffener				1	
	21826434	Channel, Stiffener					1
29	2067600	Regulator, 5" WC. & 10" WC.	1	1	1	1	1
30	21825012	Side, Grease Chute	2	2	2	2	2
31	2065847	APW Wyott Casted Logo	1	1	1	1	1
32	8861000	Label, Spec	1	1	1	1	1
33	8809920	Decal, Improper Installation	1	1	1	1	1
34	8837134	Label, Orifice Size	1	1	1	1	1
35	8825300	Decal, Leg	1	1	1	1	1
36	8837130	Decal, Operating Instructions	1	1	1	1	1
37	43813103	Label, Hot Surface	1	1	1	1	1
38	43813149	Label, Hot Surface (French)	1	1	1	1	1
39	8835410	Inst/Op Manual (N/S)	1	1	1	1	1

# HMG GRIDDLES (CE) - EXPLODED VIEW & PARTS LIST

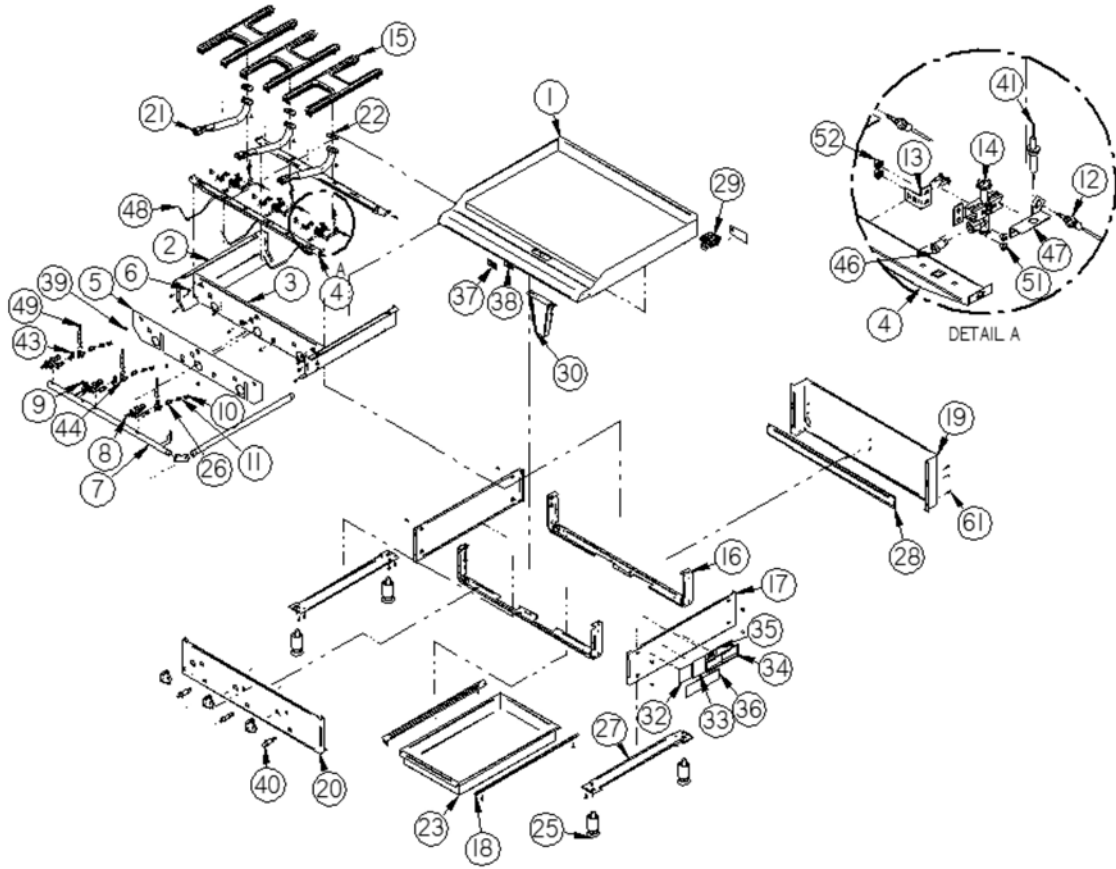

ITEM	P/N	DESCRIPTION	HMG-2424i	HMG-2436i	HMG-2448i	HMG-2460i	HMG-2472i
1	22241254	Weldm't, Griddle Plate	1				
	22241374	Weldm't, Griddle Plate		1			
	22241494	Weldm't, Griddle Plate			1		
	22241614	Weldm't Griddle Plate				1	
	22241734	Weldm't, Griddle Plate					1
2	21826433	Side, Firebox	2	2	2	2	2
3	21826036	Body, 24" Firebox	1				
	21826136	Body, 36" Firebox		1			
	21826236	Body, 48" Firebox			1		
	21826336	Body, 60" Firebox				1	
	21826436	Body, 72" Firebox					1
4	21826017	Support, Burner	2				
	21826117	Support, Burner		2			
	21826217	Support, Burner			2		
	21826317	Support, Burner				2	
	21826417	Support, Burner					2
5	21826037	Baffle, Front Heat	1				
	21826137	Baffle, Front Heat		1			
	21826237	Baffle, Front Heat			1		
	21826337	Baffle, Front Heat				1	
	21826437	Baffle, Front Heat					1
6	21813085	Spacer	4	4	5	5	6
7	21830735	Manifold, 24"	1				
	21830835	Manifold, 36"		1			
	21830935	Manifold, 48"			1		
	21831035	Manifold, 60"				1	
	21831135	Manifold, 72"					1
8	2068300	Valve, Gas 210° On/Off	2	3	4	5	6

ITEM	P/N	DESCRIPTION	HMG-2424i	HMG-2436i	HMG-2448i	HMG-2460i	HMG-2472i
9	2092517	Plug, 1/8 NPTM	1	1	1	1	1
10	2066834	Hood, Orifice #34	2	3	4	5	6
11	2066851	Hood, Orifice #51	2	3	4	5	6
12	1473700	Thermocouple, CE Valve 600mm	2	3	4	5	6
13	21826413	Bracket, Pilot	2	3	4	5	6
14	20932100	Burner, Pilot	2	3	4	5	6
15	2065846	Burner, Cast H	2	3	4	5	6
16	22400010	Support, Leg 24"	2				
	22400015	Support, Leg 36"		2			
	22400020	Support, Leg 48"			2		
	22400025	Support, Leg 60"				2	
	22400030	Support, Leg 72"					2
17	21826053	Panel, Right & Left Side	2	2	2	2	2
18	21825011	Guide, Grease Slide	2	2	2	2	2
19	21826052	Panel, Back 24"	1				
	21826652	Panel, Back 36"		1			
	21826252	Panel, Back 48"			1		
	21826332	Panel, Back 60"				1	
	21826452	Panel, Back 72"					1
20	22243253	Panel, Control 24" CE	1				
	22243373	Panel, Control 36" CE		1			
	22243493	Panel, Control 48" CE			1		
	22243613	Panel, Control 60" CE				1	
	22243733	Panel, Control 72" CE					1
21	2065849	Venturi, Hvy Dty Griddles	2	3	4	5	6
22	2065916	Gasket, Burner	2	3	4	5	6
23	2425310	Pan Grease 24"	1	1	1	1	1
24	8706300	Knob, Metal Cookline .375 D Shaft	2	3	4	5	6
25	8633700	Leg, 2" Dia. Hvy Dty	4	4	4	4	4
26	2065839	Adapter, 15° Angle Elbow	2	3	4	5	6
27	22400003	Brace, Leg	2	2	2	2	2
28	21826134	Channel, Stiffener	NA	1			
	21826234	Channel, Stiffener			1		
	21826334	Channel, Stiffener				1	
	21826434	Channel, Stiffener					1
29	2067600	Regulator, 5" W.C. & 10" W.C.	1	1	1	1	1
30	21825012	Side, Grease Chute	2	2	2	2	2
31	2065847	APW Wyott Casted Logo	1	1	1	1	1
32	8861000	Label, Spec	1	1	1	1	1
33	8809920	Decal, Improper Installation	1	1	1	1	1
34	8837134	Label, Orifice Size	1	1	1	1	1
35	8825300	Decal, Leg	1	1	1	1	1
36	8837130	Decal, Operating Instructions	1	1	1	1	1
37	43813103	Label, Hot Surface	1	1	1	1	1
38	43813149	Label, Hot Surface (French)	1	1	1	1	1
39	8835410	Lnst/Op Manual (N/S)	1	1	1	1	1
40	2065884	Ignitor	2	3	4	5	6
41	2065885	Electrode, Spark	2	3	4	5	6
42	2069700	Valve, Ball 3/4" 90°	1	1	1	1	1
43	2092612	Elbow, Brass 3/8-27f x 3/8 C	2	3	4	5	6
44	2092614	Elbow, Brass 3/8c x 3/8-27m Brass	2	3	4	5	6
45	2092626	Pipe, Inlet	1	1	1	1	1
46	20932101	Nut, Compression & Ferrule	2	3	4	5	6
47	21826016	Bracket, Thermocouple	2	3	4	5	6
48	21830817	Tube, Pilot Supply CE	2	3	4	5	6
49	21830847	Tube, Orifice Supply	2	3	4	5	6
50	8806070	Label, Delivery CE Gas Units (N/S)	1	1	1	1	1
51	8806075	Label, Packaging CE Gas Units (N/s)	1	1	1	1	1
52	8806080	Label, CE Ventilation (N/S)	1	1	1	1	1



## APW Wyott EQUIPMENT LIMITED WARRANTY

APW Wyott Foodservice Equipment Company warrants its equipment against defects in materials and workmanship, subject to the following conditions:

This warranty applies to the original owner only and is not assignable.

Should any product fail to function in its intended manner under normal use within the limits defined in this warranty, at the option of APW Wyott such product will be repaired or replaced by APW Wyott or its Authorized Service Agency. APW Wyott will only be responsible for charges incurred or service performed by its Authorized Service Agencies. The use of other than APW Wyott Authorized Service Agencies will void this warranty and APW Wyott will not be responsible for such work or any charges associated with same. The closest APW Wyott Authorized Service Agent must be used.

This warranty covers products shipped into the 48 contiguous United States, Hawaii, metropolitan areas of Alaska and Canada. There will be no labor coverage for equipment located on any island not connected by roadway to the mainland.

Warranty coverage on products used outside the 48 contiguous United States, Hawaii, and metropolitan areas of Alaska and Canada may vary. Contact the international APW Wyott distributor, dealer, or service agency for details.

### Time Period

One year for parts and one year for labor, effective from the date of purchase by the original owner. The Authorized Service Agency may, at their option, require proof of purchase. Parts replaced under this warranty are warranted for the un-expired portion of the original product warranty only.

### Exceptions

- \* Gas/Electric Cookline: Models GCB, GCRB, GF, GGM, GGT, CHP-H, EF, EG, EHP. Three (3) Year Warranty on all component parts, except switches and thermostats. (2 additional years on parts only. No labor on second or third year.)
- \* Broiler Briquettes, Rock Grates, Cooking Grates, Burner Shields, Fireboxes: 90 Day Material Only. No Labor.
- \* Heat Strips: Models FD, FDL, FDD, FDDL. Two (2) Year Warranty on element only. No labor second year.
- \* Glass Windows, Doors, Seals, Rubber Seals, Light Bulbs: 90 Day Material Only. No Labor.

In all cases, parts covered by extended warranty will be shipped FOB the factory after the first year.

### Portable Carry In Products

Equipment weighing over 70 pounds or permanently installed will be serviced on-site as per the terms of this warranty. Equipment weighing 70 pounds or under, and which is not permanently installed, i.e. with cord and plug, is considered portable and is subject to the following warranty handling limitations. If portable equipment fails to operate in its intended manner on the first day of connection, or use, at APW Wyott's option or its Authorized Service Agency, it will be serviced on site or replaced.

From day two through the conclusion of this warranty period, portable units must be taken to or sent prepaid to the APW Wyott Authorized Service Agency for in-warranty repairs. No mileage or travel charges are allowed on portable units after the first day of use. If the customer wants on-site service, they may receive same by paying the travel and mileage charges. Exceptions to this rule: (1) countertop warmers and cookers, which are covered under the Enhanced Warranty Program, and (2) toasters or rollergrills which have in store service.

### Exclusions

The following conditions are not covered by warranty:

- \* Equipment failure relating to improper installation, improper utility connection or supply and problems due to ventilation.
- \* Equipment that has not been properly maintained, calibration of controls, adjustments, damage from improper cleaning and water damage to controls.
- \* Equipment that has not been used in an appropriate manner, or has been subject to misuse or misapplication, neglect, abuse, accident, alteration, negligence, damage during transit, delivery or installation, fire, flood, riot or act of god.
- \* Equipment that has the model number or serial number removed or altered.

If the equipment has been changed, altered, modified or repaired by other than an Authorized Service Agency during or after the warranty period, then the manufacturer shall not be liable for any damages to any person or to any property, which may result from the use of the equipment thereafter.

This warranty does not cover services performed at overtime or premium labor rates. Should service be required at times which normally involve overtime or premium labor rates, the owner shall be charged for the difference between normal service rates and such premium rates. APW Wyott does not assume any liability for extended delays in replacing or repairing any items beyond its control.

In all cases, the use of other than APW Wyott Authorized OEM Replacement Parts will void this warranty.

This equipment is intended for commercial use only. Warranty is void if equipment is installed in other than commercial application.

### Water Quality Requirements

Water supply intended for a unit that has in excess of 3.0 grains of hardness per gallon (GPG) must be treated or softened before being used. Water containing over 3.0 GPG will decrease the efficiency and reduce the operation life of the unit.

**Note: Product failure caused by liming or sediment buildup is not covered under warranty.**

**“THE FOREGOING WARRANTY IS IN LIEU OF ANY AND ALL OTHER WARRANTIES EXPRESSED OR IMPLIED INCLUDING ANY IMPLIED WARRANTY OF MERCHANTABILITY OR FITNESS FOR PARTICULAR PURPOSES AND CONSTITUTES THE ENTIRE LIABILITY OF APW WYOTT. IN NO EVENT DOES THE LIMITED WARRANTY EXTEND BEYOND THE TERMS STATED HEREIN.”**

9/05



## Free Manuals Download Website

<http://myh66.com>

<http://usermanuals.us>

<http://www.somanuals.com>

<http://www.4manuals.cc>

<http://www.manual-lib.com>

<http://www.404manual.com>

<http://www.luxmanual.com>

<http://aubethermostatmanual.com>

Golf course search by state

<http://golfingnear.com>

Email search by domain

<http://emailbydomain.com>

Auto manuals search

<http://auto.somanuals.com>

TV manuals search

<http://tv.somanuals.com>