

E10594
Revised Edition V4
August 2015



HDMI[™]
HIGH-DEFINITION MULTIMEDIA INTERFACE

Notebook PC

E-Manual

ASUS[®]
IN SEARCH OF INCREDIBLE

COPYRIGHT INFORMATION

No part of this manual, including the products and software described in it, may be reproduced, transmitted, transcribed, stored in a retrieval system, or translated into any language in any form or by any means, except documentation kept by the purchaser for backup purposes, without the express written permission of ASUSTeK COMPUTER INC. ("ASUS").

ASUS PROVIDES THIS MANUAL "AS IS" WITHOUT WARRANTY OF ANY KIND, EITHER EXPRESS OR IMPLIED, INCLUDING BUT NOT LIMITED TO THE IMPLIED WARRANTIES OR CONDITIONS OF MERCHANTABILITY OR FITNESS FOR A PARTICULAR PURPOSE. IN NO EVENT SHALL ASUS, ITS DIRECTORS, OFFICERS, EMPLOYEES OR AGENTS BE LIABLE FOR ANY INDIRECT, SPECIAL, INCIDENTAL, OR CONSEQUENTIAL DAMAGES (INCLUDING DAMAGES FOR LOSS OF PROFITS, LOSS OF BUSINESS, LOSS OF USE OR DATA, INTERRUPTION OF BUSINESS AND THE LIKE), EVEN IF ASUS HAS BEEN ADVISED OF THE POSSIBILITY OF SUCH DAMAGES ARISING FROM ANY DEFECT OR ERROR IN THIS MANUAL OR PRODUCT.

Products and corporate names appearing in this manual may or may not be registered trademarks or copyrights of their respective companies, and are used only for identification or explanation and to the owners' benefit, without intent to infringe.

SPECIFICATIONS AND INFORMATION CONTAINED IN THIS MANUAL ARE FURNISHED FOR INFORMATIONAL USE ONLY, AND ARE SUBJECT TO CHANGE AT ANY TIME WITHOUT NOTICE, AND SHOULD NOT BE CONSTRUED AS A COMMITMENT BY ASUS. ASUS ASSUMES NO RESPONSIBILITY OR LIABILITY FOR ANY ERRORS OR INACCURACIES THAT MAY APPEAR IN THIS MANUAL, INCLUDING THE PRODUCTS AND SOFTWARE DESCRIBED IN IT.

Copyright © 2015 ASUSTeK COMPUTER INC. All Rights Reserved.

LIMITATION OF LIABILITY

Circumstances may arise where because of a default on ASUS' part or other liability, you are entitled to recover damages from ASUS. In each such instance, regardless of the basis on which you are entitled to claim damages from ASUS, ASUS is liable for no more than damages for bodily injury (including death) and damage to real property and tangible personal property; or any other actual and direct damages resulted from omission or failure of performing legal duties under this Warranty Statement, up to the listed contract price of each product.

ASUS will only be responsible for or indemnify you for loss, damages or claims based in contract, tort or infringement under this Warranty Statement.

This limit also applies to ASUS' suppliers and its reseller. It is the maximum for which ASUS, its suppliers, and your reseller are collectively responsible.

UNDER NO CIRCUMSTANCES IS ASUS LIABLE FOR ANY OF THE FOLLOWING: (1) THIRD-PARTY CLAIMS AGAINST YOU FOR DAMAGES; (2) LOSS OF, OR DAMAGE TO, YOUR RECORDS OR DATA; OR (3) SPECIAL, INCIDENTAL, OR INDIRECT DAMAGES OR FOR ANY ECONOMIC CONSEQUENTIAL DAMAGES (INCLUDING LOST PROFITS OR SAVINGS), EVEN IF ASUS, ITS SUPPLIERS OR YOUR RESELLER IS INFORMED OF THEIR POSSIBILITY.

SERVICE AND SUPPORT

Visit our multi-language web site at <http://support.asus.com>

Table of Contents

About this manual.....	6
Conventions used in this manual	8
Icons	8
Typography.....	8
Safety precautions.....	9
Using your Notebook PC.....	9
Caring for your Notebook PC	10
Proper disposal.....	11

Chapter 1: Hardware Setup

Getting to know your Notebook PC	14
Top View.....	14
Bottom.....	19
Right Side	21
Left Side	23
Front Side	25

Chapter 2: Using your Notebook PC

Getting started	28
Install the battery pack. (on selected models).....	28
Charge your Notebook PC.....	29
Lift to open the display panel.....	31
Press the power button.....	31
Using the touchpad	32
Using the keyboard.....	36
Function keys	36
Windows® 10 keys.....	37
Multimedia control keys	38
Using the numeric keypad	39
Using the optical drive.....	40

Chapter 3: Working with Windows® 10

Starting for the first time.....	44
Start menu	45
Launching the Start menu	46
Opening programs from the Start menu	46
Windows® apps	47
Working with Windows® apps	48
Customizing Windows® apps.....	48
Task view	51
Snap feature	52
Snap hotspots.....	52
Action Center	54
Other keyboard shortcuts	55
Connecting to wireless networks	57
Wi-Fi.....	57
Bluetooth	58
Airplane mode.....	59
Connecting to wired networks	60
Configuring a dynamic IP/PPPoE network connection	60
Configuring a static IP network connection	61
Turning your Notebook PC off.....	62
Putting your Notebook PC to sleep	63

Chapter 4: Power-on Self Test (POST)

The Power-on Self Test (POST)	66
Using POST to access BIOS and Troubleshoot.....	66
BIOS	66
Accessing BIOS	66
BIOS Settings.....	67
Recovering your system.....	77
Performing a recovery option.....	78

Chapter 5: Upgrading your Notebook PC

Installing a Random-access Memory module (on selected models)	82
Replacing the Hard Disk Drive (on selected models)	85
Installing a new battery pack (on selected models)	91

Appendices

DVD-ROM Drive Information (on selected models)	96
Blu-ray ROM Drive Information (on selected models)	98
Internal Modem Compliancy	98
Overview	99
Network Compatibility Declaration	99
Non-Voice Equipment	99
Federal Communications Commission Interference Statement	101
FCC Radio Frequency (RF) Exposure Caution Statement	102
Declaration of Conformity (R&TTE directive 1999/5/EC)	103
CE Marking	103
IC Radiation Exposure Statement for Canada	104
Déclaration d'Industrie Canada relative à l'exposition aux ondes radio ...	105
Wireless Operation Channel for Different Domains	106
France Restricted Wireless Frequency Bands	106
UL Safety Notices	108
Power Safety Requirement	109
TV Notices	109
REACH	109
Macrovision Corporation Product Notice	109
Prevention of Hearing Loss	109
Nordic Lithium Cautions (for lithium-ion batteries)	110
Optical Drive Safety Information	111
CTR 21 Approval (for Notebook PC with built-in Modem)	112
ENERGY STAR complied product	114
Global Environmental Regulation Compliance and Declaration	114
ASUS Recycling/Takeback Services	115
Regional notice for Singapore	115

About this manual

This manual provides information about the hardware and software features of your Notebook PC, organized through the following chapters:

Chapter 1: Hardware Setup

This chapter details the hardware components of your Notebook PC.

Chapter 2: Using your Notebook PC

This chapter shows you how to use the different parts of your Notebook PC.

Chapter 3: Working with Windows® 10

This chapter provides an overview of using Windows® 10 in your Notebook PC.

Chapter 4: Power-on Self-test (POST)

This chapter shows you how to use POST to change the settings of your Notebook PC.

Chapter 5: Upgrading your Notebook PC

This chapter guides you through the process of replacing and upgrading parts of your Notebook PC.

Tips and FAQs

This section presents some recommended tips, hardware FAQs, and software FAQs you can refer to for maintaining and fixing common issues with your Notebook PC.

Appendices

This section includes notices and safety statements for your Notebook PC.

Conventions used in this manual

To highlight key information in this manual, some text are presented as follows:

IMPORTANT! This message contains vital information that must be followed to complete a task.

NOTE: This message contains additional information and tips that can help complete tasks.

WARNING! This message contains important information that must be followed to keep you safe while performing tasks and prevent damage to your Notebook PC's data and components.

Icons

The icons below indicate the devices you can use for completing a series of tasks or procedures on your Notebook PC.



= Use the touchpad.



= Use the keyboard.

Typography

Bold = This indicates a menu or an item that must be selected.

Italic = This indicates sections that you can refer to in this manual.

Safety precautions

Using your Notebook PC



This Notebook PC should only be used in environments with ambient temperatures between 5°C (41°F) and 35°C (95°F).



Refer to the rating label on the bottom of your Notebook PC and ensure that your power adapter complies with this rating.



Do not leave your Notebook PC on your lap or near any part of your body to prevent discomfort or injury from heat exposure.



Do not use damaged power cords, accessories, and other peripherals with your Notebook PC.



While powered on, ensure that you do not carry or cover your Notebook PC with any materials that can reduce air circulation.



Do not place your Notebook PC on uneven or unstable work surfaces.



You can send your Notebook PC through x-ray machines (used on items placed on conveyor belts), but do not expose them to magnetic detectors and wands.



Contact your airline provider to learn about related in-flight services that can be used and restrictions that must be followed when using your Notebook PC in-flight.

Caring for your Notebook PC



Disconnect the AC power and remove the battery pack (if applicable) before cleaning your Notebook PC. Use a clean cellulose sponge or chamois cloth dampened with a solution of nonabrasive detergent and a few drops of warm water. Remove any extra moisture from your Notebook PC using a dry cloth.



Do not use strong solvents such as thinners, benzene, or other chemicals on or near your Notebook PC.



Do not place objects on top of your Notebook PC.



Do not expose your Notebook PC to strong magnetic or electrical fields.



Do not use or expose your Notebook PC near liquids, rain, or moisture.



Do not expose your Notebook PC to dusty environments.



Do not use your Notebook PC near gas leaks.

Proper disposal



Do not throw your Notebook PC in municipal waste. This product has been designed to enable proper reuse of parts and recycling. The symbol of the crossed out wheeled bin indicates that the product (electrical, electronic equipment and mercury-containing button cell battery) should not be placed in municipal waste. Check local regulations for disposal of electronic products.



Do not throw the battery in municipal waste. The symbol of the crossed out wheeled bin indicates that the battery should not be placed in municipal waste.

Chapter 1:

Hardware Setup

Getting to know your Notebook PC

Top View

NOTE: The keyboard's layout may vary per region or country. The top view may also vary in appearance depending on the Notebook PC model.

15" model

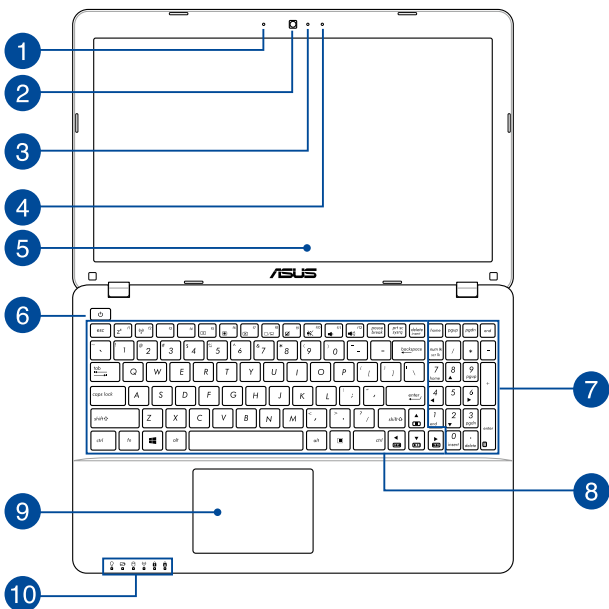

- 1 Microphone**

The built-in microphone can be used for video conferencing, voice narrations, or simple audio recording.
- 2 Camera**

The built-in camera allows you to take pictures or record videos using your Notebook PC.
- 3 Camera indicator**

The camera indicator lights up when the built-in camera is in use.
- 4 Microphone (on selected models)**

The built-in microphone can be used for video conferencing, voice narrations, or simple audio recording.
- 5 Display panel**

This high-definition display panel provides excellent viewing features for photos, videos, and other multimedia files on your Notebook PC.
- 6 Power button**

Press the power button to turn your Notebook PC on or off. You can also use the power button to put your Notebook PC to sleep or hibernate mode and wake it up from sleep or hibernate mode.

In the event that your Notebook PC becomes unresponsive, press and hold the power button for at least four (4) seconds until your Notebook PC shuts down.

7 Numeric keypad (on selected models)

The numeric keypad toggles between these two functions: for numeric input and as pointer direction keys.

NOTE: For more details, refer to the *Numeric keypad (on selected models)* section in this manual.

8 Keyboard

The keyboard provides full-sized QWERTY keys with a comfortable travel depth for typing. It also enables you to use the function keys, allows quick access to Windows®, and controls other multimedia functions.

NOTE: The keyboard layout differs by model or territory.

9 Touchpad

The touchpad allows the use of multi-gestures to navigate onscreen, providing an intuitive user experience. It also simulates the functions of a regular mouse.

NOTE: For more details, refer to the *Using the touchpad* section in this manual.

10

Status indicators

The status indicators help identify the current hardware status of your Notebook PC.



Power indicator

The power indicator lights up when the Notebook PC is turned on and blinks slowly when the Notebook PC is in sleep mode.

Two-color battery charge indicator

The two-color LED provides a visual indication of the battery's charge status. Refer to the following table for details:

Color	Status
Solid Green	The Notebook PC is plugged to a power source and the battery power is between 95% and 100%.
Solid Orange	The Notebook PC is plugged to a power source, charging its battery, and the battery power is less than 95%.
Blinking Orange	The Notebook PC is running on battery mode and the battery power is less than 10%.
Lights off	The Notebook PC is running on battery mode and the battery power is between 10% to 100%.

 **Drive activity indicator**

This indicator lights up when your Notebook PC is accessing the internal storage drives.

 **Bluetooth / Wireless indicator**

This indicator lights up when your Notebook PC's wireless function (Bluetooth or Wi-Fi) is enabled.

 **Number lock indicator (on selected models)**

This indicator lights up when the number lock function is activated. This allows you to use some of the keys on your keyboard for numeric input.

 **Capital lock indicator**

This indicator lights up when the capital lock function is activated. Using capital lock allows you to type capitalized letters (such as A, B, C) using your Notebook PC's keyboard.

Bottom

NOTE: The bottom side may vary in appearance depending on model.

WARNING!

- The bottom of the Notebook PC can get warm to hot while in use or while charging the battery pack. When working on your Notebook PC, do not place it on surfaces that can block the vents.
 - Only ASUS-authorized technicians should remove the battery inside the device.
-

IMPORTANT! Battery time varies by usage and by the specifications for this Notebook PC. The battery pack cannot be disassembled.

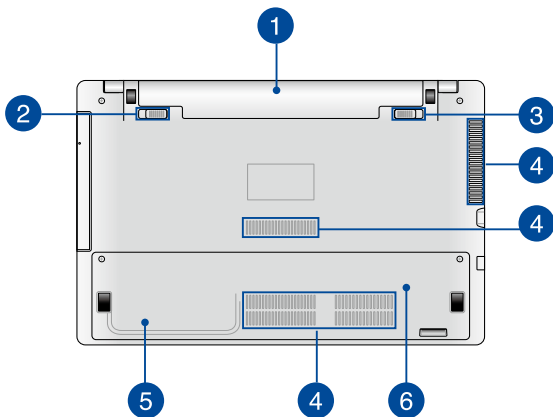

1 Battery pack

The battery pack is automatically charged when your Notebook PC is connected to a power source. When charged, the battery pack supplies power to your Notebook PC.

2 Spring battery lock (on selected models)

The spring battery lock automatically locks the battery pack in place once it is inserted into the battery slot.

IMPORTANT! This lock should be held in an unlocked position when removing the battery pack.

3 Manual battery lock (on selected models)

The manual battery lock is used to keep the battery pack secured. This lock should be manually moved to a locked or unlocked position to insert or remove the battery pack.

4 Air vents

The air vents allow cool air to enter and warm air to exit the Notebook PC.

WARNING! Ensure that paper, books, clothing, cables, or other objects do not block any of the air vents or else overheating may occur.

5 Hard disk drive compartment (on selected models)

This compartment is a reserved space for the HDD (hard disk drive) of your Notebook PC.

6 Random-access memory module compartment (on selected models)

This compartment allows you to add RAM (random-access memory) modules to increase the memory capacity of your Notebook PC.

Right Side

15" and 14" model

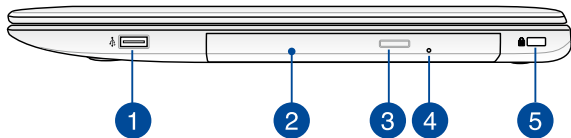

1 USB 2.0 port (on selected models)

The USB (Universal Serial Bus) port is compatible with USB 2.0 or USB 1.1 devices such as keyboards, pointing devices, flash disk drives, external HDDs, speakers, cameras and printers.

2 Optical drive

Your Notebook PC's optical drive may support several disc formats such as CDs, DVDs, recordable discs, or rewritable discs.

3 Optical disc drive eject button

Press this button to eject the optical drive tray.

4

Optical disc drive manual eject hole

The manual eject hole is used to eject the drive tray in case the electronic eject button does not work.

WARNING! Use the manual eject hole only when the electronic eject button does not work.

NOTE: For more details, refer to the *Using the optical drive* section in this manual.

5

Kensington® security slot

The Kensington® security slot allows you to secure your Notebook PC using Kensington® compatible Notebook PC security products.

Left Side

15" and 14" model

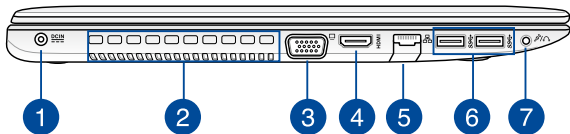

1 Power (DC) input port

Insert the bundled power adapter into this port to charge the battery pack and supply power to your Notebook PC.

WARNING! The adapter may become warm to hot while in use. Do not cover the adapter and keep it away from your body while it is connected to a power source.

IMPORTANT! Use only the bundled power adapter to charge the battery pack and supply power to your Notebook PC.

2 Air vents

The air vents allow cool air to enter and warm air to exit the Notebook PC.

WARNING! Ensure that paper, books, clothing, cables, or other objects do not block any of the air vents or else overheating may occur.

3 VGA port

This port allows you to connect your Notebook PC to an external display.

4

HDMI port

This port is for the HDMI (High-Definition Multimedia Interface) connector and is HDCP compliant for HD DVD, Blu-ray, and other protected content playback.

5

LAN port

Insert the network cable into this port to connect to a local area network.

6

USB 3.0 port

The USB 3.0 (Universal Serial Bus 3.0) port provides a transfer rate up to 5 Gbit/s and is backward compatible to USB 2.0.

7

Headphone outputjack/microphone input combo port

This port allows you to connect your tablet to amplified speakers or headphones. You can also use this port to connect your tablet to an external microphone.

NOTE: This port does not support three-conductor 3.5mm microphone.

Front Side

NOTE: The front side may vary in appearance depending on model.

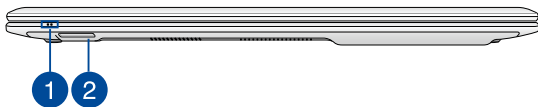

1

Status indicators

The status indicators help identify the current hardware status of your Notebook PC.

2

Memory card reader

This built-in memory card reader supports SD and SDHC card formats.

Chapter 2: ***Using your Notebook PC***

Getting started

NOTE: If your Notebook PC does not have its battery pack installed, use the following procedures for installation.

Install the battery pack (on selected models)

- A. Move the manual battery lock to the unlocked position.
- B. Align and insert the battery pack into the Notebook PC's battery slot.
- C. Move the manual battery lock back to the locked position after inserting the battery pack.

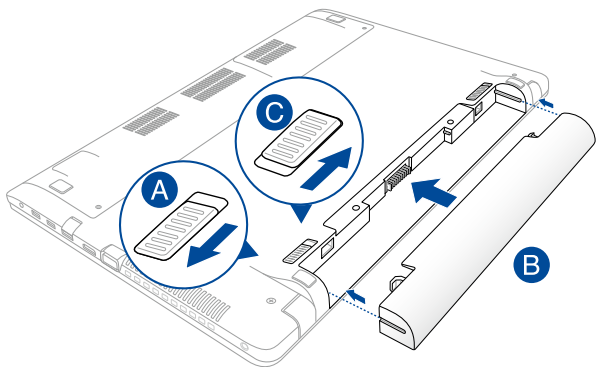

Charge your Notebook PC

- A. Connect the AC power cord to the AC/DC adapter.
- B. Plug the AC power adapter into a 100V~240V power source.
- C. Connect the DC power connector into your Notebook PC's power (DC) input.



Charge the Notebook PC for **3 hours** before using it in battery mode for the first time.

NOTE: The power adapter may vary in appearance, depending on models and your region.

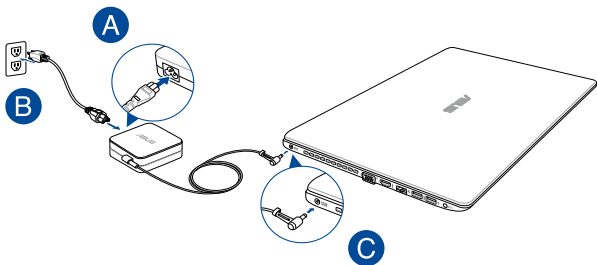

IMPORTANT!

- Locate the input/output rating label on your Notebook PC and ensure that it matches the input/output rating information on your power adapter. Some Notebook PC models may have multiple rating output currents based on the available SKU.
 - Ensure that your Notebook PC is connected to the power adapter before turning it on for the first time. We strongly recommend that you use a grounded wall socket while using your Notebook PC on power adapter mode.
 - The socket outlet must be easily accessible and near your Notebook PC.
 - To disconnect your Notebook PC from its main power supply, unplug your Notebook PC from the power socket.
-

WARNING!

Read the following precautions for your Notebook PC's battery.

- The battery used in this device may present a risk of fire or chemical burn if removed or disassembled.
 - Follow the warning labels for your personal safety.
 - Risk of explosion if battery is replaced by an incorrect type.
 - Do not dispose of in fire.
 - Never attempt to short-circuit your Notebook PC's battery.
 - Never attempt to disassemble and reassemble the battery.
 - Discontinue usage if leakage is found.
 - The battery and its components must be recycled or disposed of properly.
 - Keep the battery and other small components away from children.
-

Lift to open the display panel

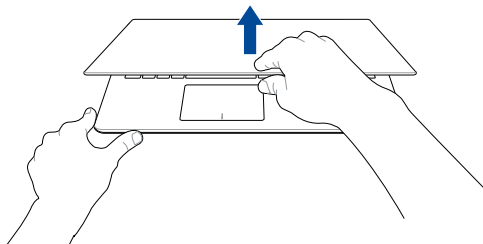

Press the power button

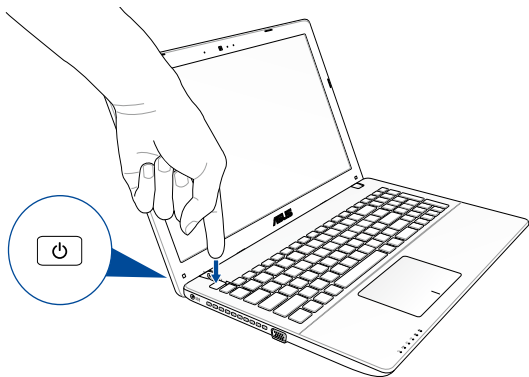

Using the touchpad

Moving the pointer

You can tap anywhere on the touchpad to activate its pointer, then slide your finger on the touchpad to move the pointer onscreen.

Slide horizontally

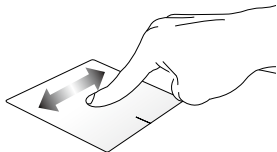

Slide vertically

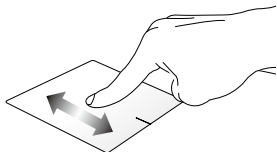

Slide diagonally

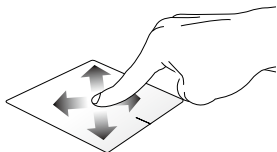

One-finger gestures

Tap/Double-tap

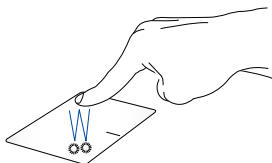

- Tap an app to select it.
- Double-tap an app to launch it.

Drag and drop

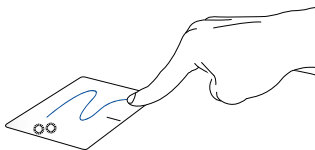

Double-tap an item, then slide the same finger without lifting it off the touchpad. To drop the item to its new location, lift your finger from the touchpad.

Left-click

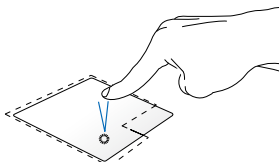

- Click an app to select it.
- Double-click an app to launch it.

Right-click

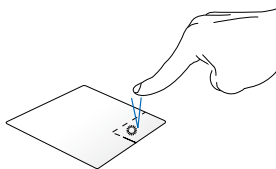

Click this button to open the right-click menu.

NOTE: The areas inside the dotted line represent the locations of the left mouse button and the right mouse button on the touchpad.

Two-finger gestures

Two-finger scroll (up/down)

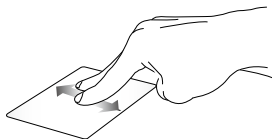

Slide two fingers to scroll up or down.

Two-finger scroll (left/right)



Slide two fingers to scroll left or right.

Zoom out

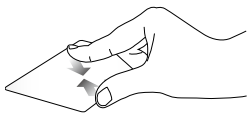

Bring together your two fingers on the touchpad.

Zoom in

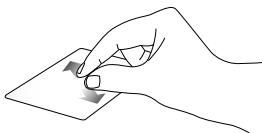

Spread apart your two fingers on the touchpad.

Drag and drop

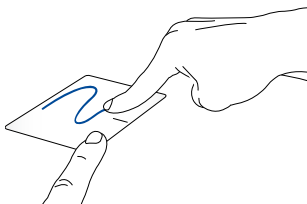

Select an item then press and hold the left button. Using your other finger, slide on the touchpad to drag the item, lift your finger off the button to drop the item.

Using the keyboard

Function keys

The function keys on your Notebook PC's keyboard can trigger the following commands:

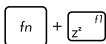

Puts the Notebook PC into **Sleep mode**



Turns **Airplane mode** on or off

NOTE: When enabled, the **Airplane mode** disables all wireless connectivity.



Decreases display brightness



Increases display brightness







Turns the display panel off







Toggles the display mode

NOTE: Ensure that the second display is connected to your Notebook PC.

 +  Enables or disables the touchpad

 +  Turns the speaker on or off

 +  Turns the speaker volume down

 +  Turns the speaker volume up

Windows® 10 keys

There are two special Windows® keys on your Notebook PC's keyboard used as below:

 Press this key to launch the Start menu

 Press this key to simulate the right-click functions

Multimedia control keys

The multimedia control keys allow you to control multimedia files, such as audios and videos, when played in your Notebook PC.

Press  in combination with the arrow keys on your Notebook PC, illustrated as below.

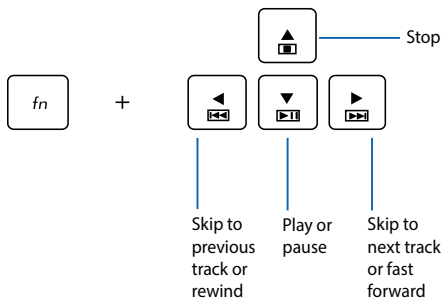

Using the numeric keypad

NOTE: The numeric keypad layout may differ by model or territory but the usage procedures remain the same.

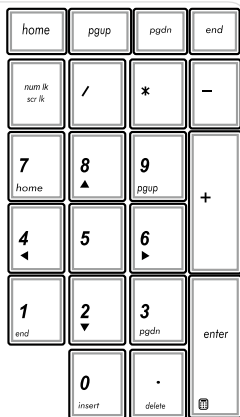

A numeric keypad is available on selected Notebook PC models. You can use this keypad for numeric input or as pointer direction keys.



Press

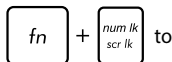

toggle between using the keypad as number keys or as pointer direction keys.

Using the optical drive

NOTE:

- The actual location of the electronic eject button may vary depending on your Notebook PC model.
 - The actual appearance of the Notebook PC optical drive may also vary depending on model but usage procedures remain the same.
 - The optical drive is available on selected models.
-

Inserting an optical disc

1. While the Notebook PC is on, press the electronic eject button to partially eject the optical drive tray.

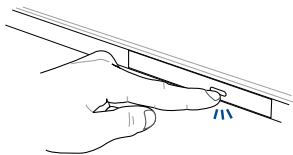

2. Gently pull out the drive tray.

IMPORTANT! Be careful not to touch the optical drive lens. Ensure that there are no objects that may get jammed under the drive tray.

3. Hold the disc by the edge with its printed side up, then gently place it inside the hub.

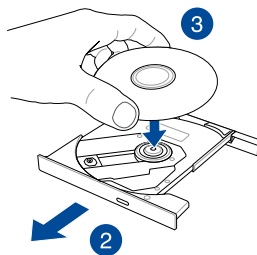

4. Push down the disc's plastic hub until it snaps onto the optical drive hub.

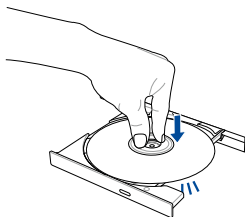

5. Push the drive tray gently to close the optical drive.

NOTE: While data is being read, it is normal to hear some spinning and vibrating in the optical drive.

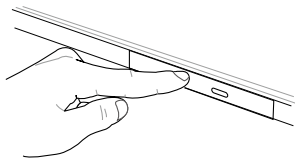

Using the manual eject hole

The manual eject hole is located on the optical drive door and is used to eject the optical drive tray in case the electronic eject button does not work.

To manually eject the optical drive tray, insert a straightened paper clip into the manual eject hole until the drive tray opens.

WARNING! Use the manual eject hole only when the electronic eject button does not work.

Chapter 3:

Working with Windows® 10

Starting for the first time

When you start your Notebook PC for the first time, a series of screens appear to guide you in configuring your Windows® 10 operating system.

To start your Notebook PC for the first time:

1. Press the power button on your Notebook PC. Wait for a few minutes until the setup screen appears.
2. From the setup screen, pick your region and a language to use on your Notebook PC.
3. Carefully read the License Terms. Select **I accept**.
4. Follow the onscreen instructions to configure the following basic items:
 - Personalize
 - Get online
 - Settings
 - Your account
5. After configuring the basic items, Windows® 10 proceeds to install your apps and preferred settings. Ensure that your Notebook PC is kept powered on during the setup process.
6. Once the setup process is complete, the Desktop appears.

NOTE: The screenshots in this chapter are for reference only.

Start menu

The Start menu is the main gateway to your Notebook PC's programs, Windows® apps, folders, and settings.

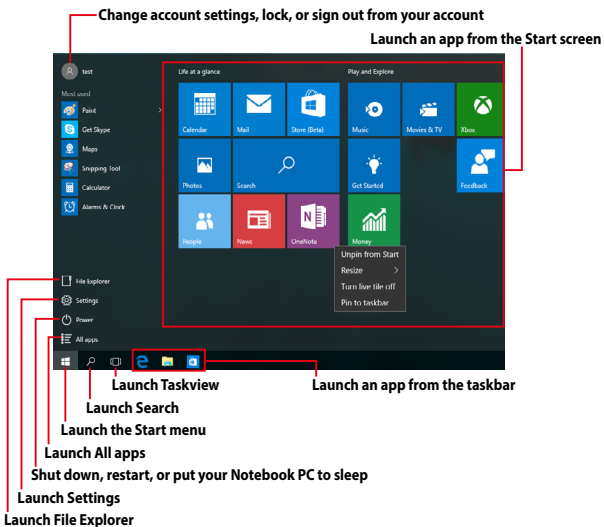

You can use the Start menu to do these common activities:

- Start programs or Windows® apps
- Open commonly used programs or Windows® apps
- Adjust Notebook PC settings
- Get help with the Windows operating system
- Turn off your Notebook PC
- Log off from Windows or switch to a different user account

Launching the Start menu



Position your mouse pointer over the Start button  in the lower-left corner of your desktop then click it.



Press the Windows logo key  on your keyboard.

Opening programs from the Start menu

One of the most common uses of the Start menu is opening programs installed on your Notebook PC.



Position your mouse pointer over the program then click to launch it.



Use the arrow keys to browse through the programs.
Press  to launch it.

NOTE: Select **All apps** at the bottom of the left pane to display a full list of programs and folders on your Notebook PC in alphabetical order.

Windows® apps

These are apps pinned on the right pane of the Start menu and displayed in tiled-format for easy access.

NOTE: Some Windows® apps require signing in to your Microsoft account before they are fully launched.

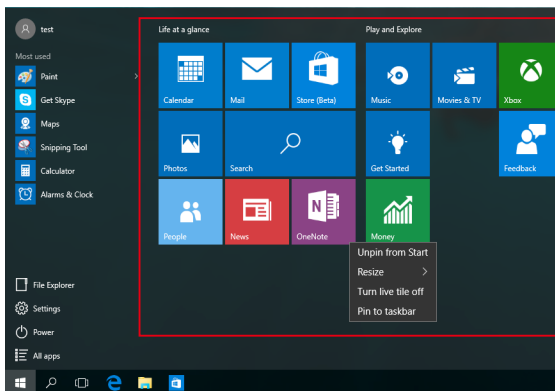

Working with Windows® apps

Use your Notebook PC's touchpad or keyboard to launch, customize, and close apps.

Launching Windows® apps from the Start menu



Position your mouse pointer over the app then click to launch it.



Use the arrow keys to browse through the apps. Press



to launch an app.

Customizing Windows® apps

You can move, resize, unpin, or pin apps to the taskbar from the Start menu using the following steps:

Moving apps



Position your mouse pointer over the app, then drag and drop the app to a new location.

Resizing apps



Position your mouse pointer over the app and right-click it, then click **Resize** and select an app tile size.



Use the arrow keys to navigate to the app. Press , then select **Resize** and select an app tile size.

Unpinning apps



Position your mouse pointer over the app and right-click it, then click **Unpin from Start**.



Use the arrow keys to navigate to the app. Press , then select **Unpin from Start**.

Pinning apps to the taskbar



Position your mouse pointer over the app and right-click it, then click **Pin to taskbar**.



Use the arrow keys to navigate to the app. Press , then select **Pin to taskbar**.

Pinning more apps to the Start menu



From **All apps**, position your mouse pointer over the app you want to add to the Start menu and right-click it, then click **Pin to Start**.



From **All apps**, press  on the app that you want to add to the Start menu, then select **Pin to Start**.

Task view

Quickly switch between opened apps and programs using the task view feature, you can also use task view to switch between desktops.

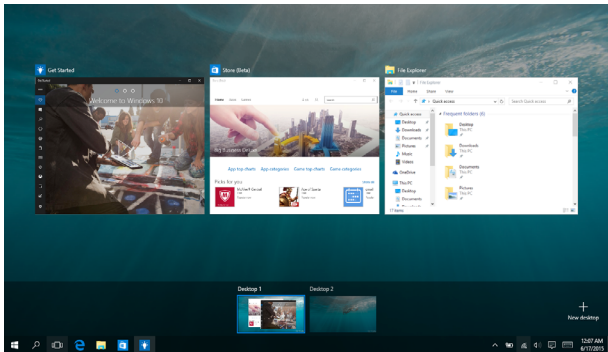

Launching task view



Position your mouse pointer over the  icon on the taskbar and click it.



Press  +  on your keyboard.

Snap feature

The Snap feature displays apps side-by-side, allowing you to work or switch between apps.

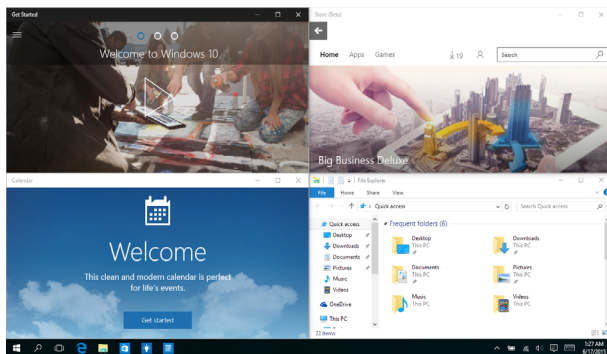

Snap hotspots

You can drag and drop apps to these hotspots to snap them into place.

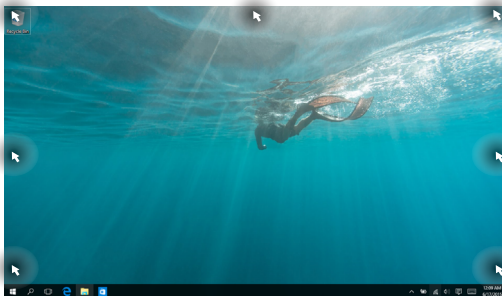

Using Snap



1. Launch the app you wish to snap.
2. Drag the title bar of your app and drop the app to the edge of the screen to snap.
3. Launch another app and repeat the above steps to snap another app.



1. Launch the app you wish to snap.
2. Press and hold the  key, then use the arrow keys to snap the app.
3. Launch another app and repeat the above steps to snap another app.

Action Center

Action Center consolidates notifications from apps and presents a single place where you can interact with them. It also has a really useful Quick Actions section at the bottom.

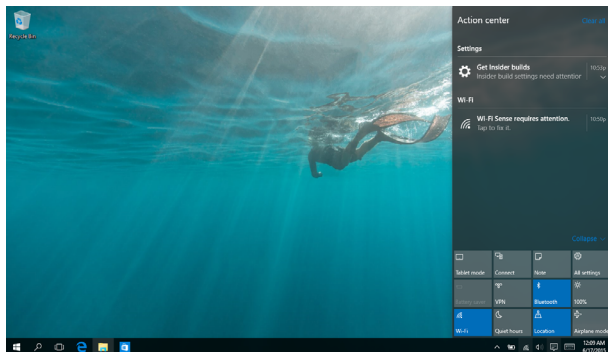



Launching Action Center



Position your mouse pointer over the  icon on the taskbar and click it.



Press  +  on your keyboard.

Other keyboard shortcuts

Using the keyboard, you can also use the following shortcuts to help you launch applications and navigate Windows® 10.



Launches **Start menu**



Launches **Action Center**

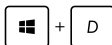

Launches the desktop



Launches the **File Explorer**



Opens the **Share** panel



Launches **Settings**



Launches **Connect** panel



Activates the Lock screen

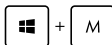

Minimizes all currently active windows



Launches **Search**



Launches **Project** panel

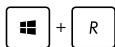

Opens the **Run** window



Opens **Ease of Access Center**



Opens the context menu of the Start button



Launches the magnifier icon and zooms in your screen



Zooms out your screen



Opens **Narrator Settings**

Connecting to wireless networks

Wi-Fi



Access emails, surf the Internet, and share applications via social networking sites using your Notebook PC's Wi-Fi connection.

IMPORTANT! Airplane mode disables this feature. Ensure that **Airplane mode** is turned off before enabling the Wi-Fi connection of your Notebook PC.

Connecting Wi-Fi

Connect your Notebook PC to a Wi-Fi network by using the following steps:



1. Select the  icon from the taskbar.
2. Select the  icon to enable Wi-Fi.
3. Select an access point from the list of available Wi-Fi connections.
4. Select **Connect** to start the network connection.

NOTE: You may be prompted to enter a security key to activate the Wi-Fi connection.

Bluetooth

Use Bluetooth to facilitate wireless data transfers with other Bluetooth-enabled devices.

IMPORTANT! Airplane mode disables this feature. Ensure that **Airplane mode** is turned off before enabling the Bluetooth connection of your Notebook PC.

Pairing with other Bluetooth-enabled devices

You need to pair your Notebook PC with other Bluetooth-enabled devices to enable data transfers. Connect your devices by using the following steps:



1. Launch **Settings** from the Start menu.
2. Select **Devices**, then select **Bluetooth** to search for Bluetooth-enabled devices.
3. Select a device from the list. Compare the passcode on your Notebook PC with the passcode sent to your chosen device. If they are the same, select **Yes** to successfully pair your Notebook PC with the device.

NOTE: For some Bluetooth-enabled devices, you may be prompted to key in the passcode of your Notebook PC.

Airplane mode

Airplane mode disables wireless communication, allowing you to use your Notebook PC safely while in-flight.



NOTE: Contact your airline provider to learn about related in-flight services that can be used and restrictions that must be followed when using your Notebook PC in-flight.

Turning Airplane mode on



1. Launch **Action Center** from the taskbar.
2. Select the  icon to enable Airplane mode.



Press  + .

Turning Airplane mode off



1. Launch **Action Center** from the taskbar.
2. Select the  icon to disable Airplane mode.



Press  + .

Connecting to wired networks

You can also connect to wired networks, such as local area networks and broadband Internet connection, using your Notebook PC's LAN port.

NOTE: Contact your Internet Service Provider (ISP) for details or your network administrator for assistance in setting up your Internet connection.

To configure your settings, refer to the following procedures.

IMPORTANT! Ensure that a network cable is connected between your Notebook PC's LAN port and a local area network before performing the following actions.

Configuring a dynamic IP/PPPoE network connection



1. Launch **Settings**.
2. Select **Network & Internet**.
3. Select **Ethernet > Network and Sharing Center**.
4. Select your LAN then select **Properties**.
5. Select **Internet Protocol Version 4(TCP/IPv4)** then select **Properties**.
6. Select **Obtain an IP address automatically** then select **OK**.

NOTE: Proceed to the next steps if you are using PPPoE connection.

7. Return to the **Network and Sharing Center** window then select **Set up a new connection or network**.
8. Select **Connect to the Internet** then select **Next**.
9. Select **Broadband (PPPoE)**.
10. Type your User name, Password, and Connection name then select **Connect**.
11. Select **Close** to finish the configuration.
12. Select  on the taskbar then select the connection you just created.
13. Type your user name and password then select **Connect** to start connecting to the Internet.

Configuring a static IP network connection





1. Repeat steps 1 to 5 under *Configuring a dynamic IP/PPPoE network connection*.
2. Select **Use the following IP address**.
3. Type the IP address, Subnet mask and Default gateway from your service provider.
4. If needed, you can also type the preferred DNS server address and alternate DNS server address then select **OK**.



Turning your Notebook PC off

You can turn off your Notebook PC by doing either of the following procedures:



- Launch the Start menu, then select  **Power** > **Shut down** to do a normal shutdown.
- From the log-in screen, select  > **Shut down**.





- Press  +  to launch Shut Down Windows. Select **Shut Down** from the drop-down list then select **OK**.
- If your Notebook PC is unresponsive, press and hold the power button for at least four (4) seconds until your Notebook PC turns off.



Putting your Notebook PC to sleep

To put your Notebook PC to Sleep mode:



- Launch the Start menu, then select  **Power** > **Sleep** to put your Notebook PC to sleep.
- From the log-in screen, select  > **Sleep**.



Press  +  to launch Shut Down Windows.
Select **Sleep** from the drop-down list then select **OK**.

NOTE: You can also put your Notebook PC to Sleep mode by pressing the power button once.

Chapter 4:

Power-on Self Test (POST)

The Power-on Self Test (POST)

The POST (Power-on Self Test) is a series of software-controlled diagnostic tests that run when you turn on or restart your Notebook PC. The software that controls the POST is installed as a permanent part of the Notebook PC's architecture.

Using POST to access BIOS and Troubleshoot

During POST, you can access the BIOS settings or run troubleshooting options using the function keys of your Notebook PC. You may refer to the following information for more details.

BIOS

The BIOS (Basic Input and Output System) stores system hardware settings that are needed for system startup in the Notebook PC.

The default BIOS settings apply to most conditions of your Notebook PC. Do not change the default BIOS settings except in the following circumstances:

- An error message appears onscreen during system bootup and requests you to run the BIOS Setup.
- You have installed a new system component that requires further BIOS settings or updates.

WARNING: Using inappropriate BIOS settings may result to system instability or boot failure. We strongly recommend that you change the BIOS settings only with the help of a trained service personnel.

Accessing BIOS



Restart your Notebook PC then press  during POST.

BIOS Settings

NOTE: The BIOS screens in this section are for reference only. The actual screens may differ by model and territory.

Boot

This menu allows you to set your boot option priorities. You may refer to the following procedures when setting your boot priority.

1. On the **Boot** screen, select **Boot Option #1**.

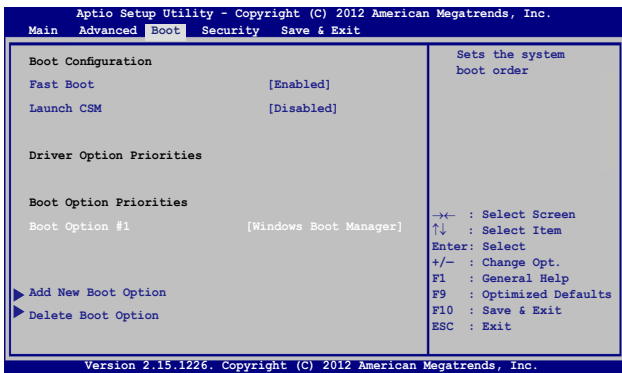

2. Press  and select a device as the **Boot Option #1**.

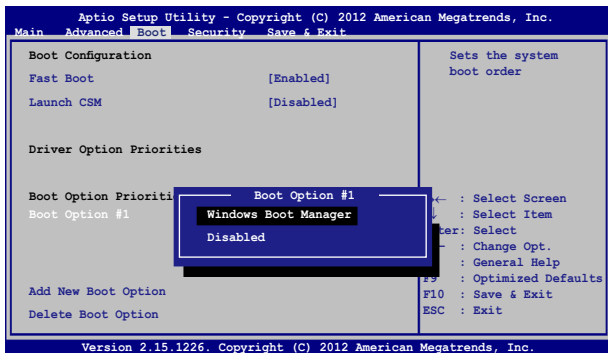

Security



This menu allows you to set up the administrator and user password of your Notebook PC. It also allows you to control the access to your Notebook PC's hard disk drive, input/output (I/O) interface, and USB interface.

NOTE:

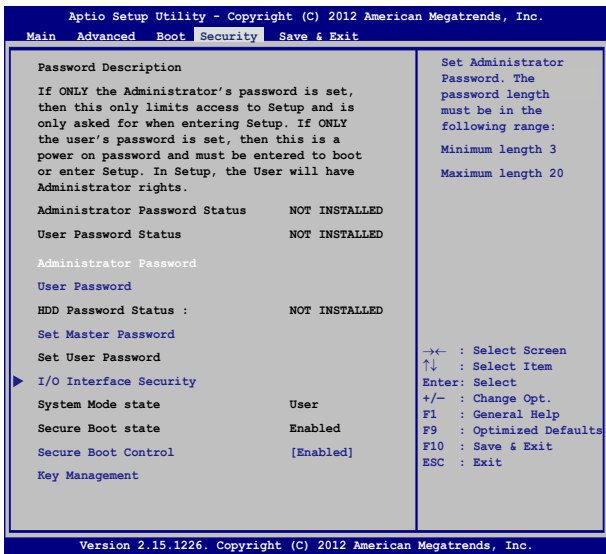

- If you install a **User Password**, you will be prompted to input this before entering your Notebook PC's operating system.
- If you install an **Administrator Password**, you will be prompted to input this before entering BIOS.



To set the password:

1. On the **Security** screen, select **Administrator Password** or **User Password**.
2. Type in a password then press .
3. Re-type to confirm the password then press .

To clear the password:

1. On the **Security** screen, select **Administrator Password** or **User Password**.
2. Type in the current password then press .
3. Leave the **Create New Password** field blank then press .
4. Select **Yes** in the confirmation box then press .

I/O Interface Security

In the Security menu, you can access I/O Interface Security to lock or unlock some interface functions of your Notebook PC.

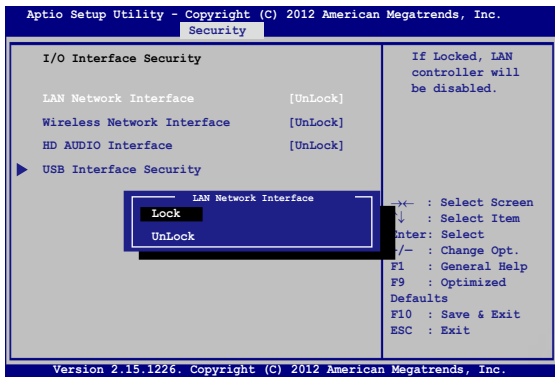

To lock an interface:

1. On the **Security** screen, select **I/O Interface Security**.
2. Select an interface you would like to lock then press



3. Select **Lock**.

USB Interface Security

Through the I/O Interface Security menu, you can also access USB Interface Security to lock or unlock ports and devices.

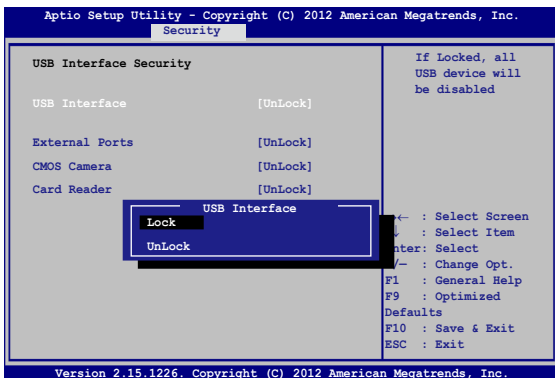

To lock the USB interface:

1. On the **Security** screen, select **I/O Interface Security > USB Interface Security**.
2. Select an interface that you would like to lock then select **Lock**.



NOTE: Setting the **USB Interface** to **Lock** also locks and hides the **External Ports** and other devices included under **USB Interface Security**.

Set Master Password

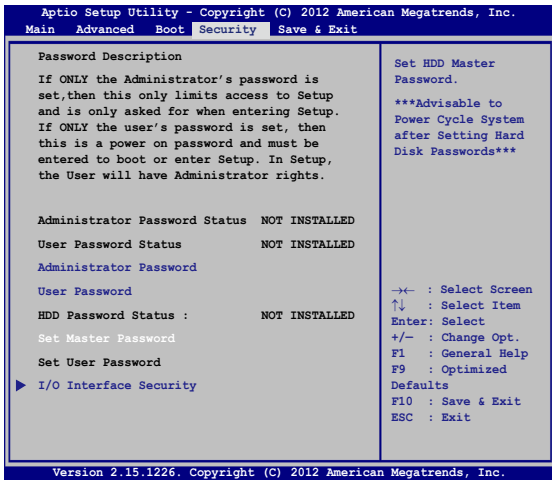
In the Security menu, you can use **Set Master Password** to set up a password-enabled access to your hard disk drive.



To set the HDD password:



1. On the **Security** screen, select **Set Master Password**.
2. Type in a password then press .
3. Re-type to confirm the password then press .
4. Select **Set User Password** then repeat the previous steps to set up the user password.

Save & Exit

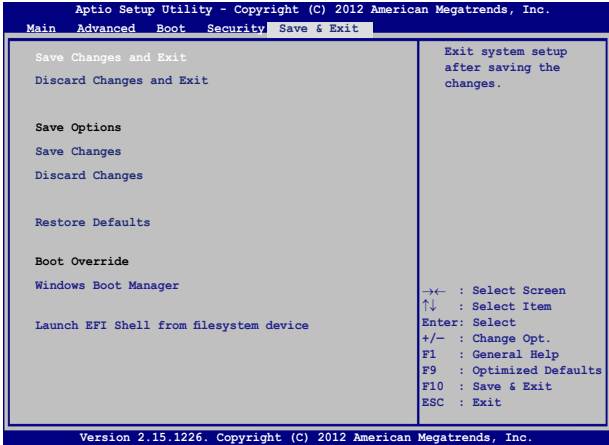
To keep your configuration settings, select **Save Changes and Exit** before exiting the BIOS.



To update the BIOS:

1. Verify the Notebook PC's exact model then download the latest BIOS file for your model from the ASUS website.
2. Save a copy of the downloaded BIOS file to a flash disk drive.
3. Connect your flash disk drive to your Notebook PC.
4. Restart your Notebook PC then press  during POST.
5. From the BIOS menu, Select **Advanced > Start Easy Flash**, then press .

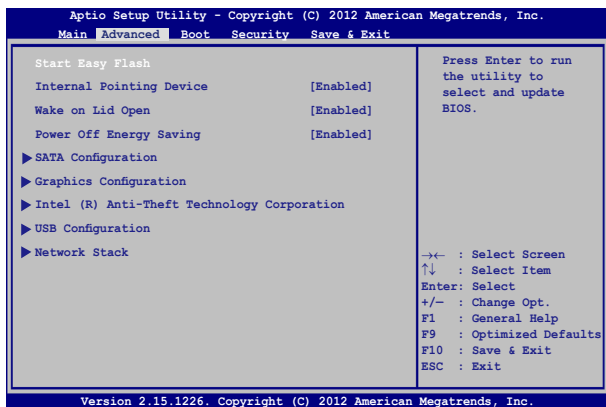

6. Locate your downloaded BIOS file in the flash disk drive then press .

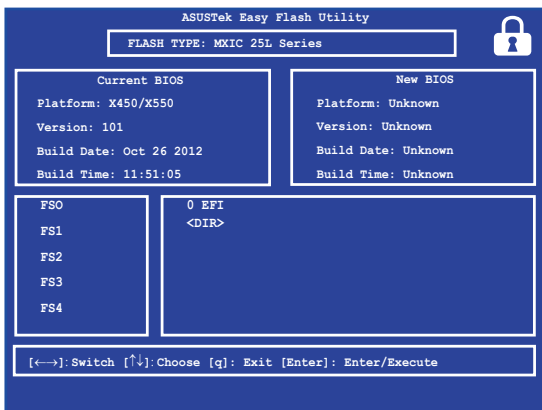

7. After the BIOS update process, select **Exit > Restore Defaults** to restore the system to its default settings.

Recovering your system

Using recovery options on your Notebook PC allows you to restore the system to its original state or simply refresh its settings to help improve performance.

IMPORTANT!

- Backup all your data files before doing any recovery option on your Notebook PC.
 - Note down important customized settings such as network settings, user names, and passwords to avoid data loss.
 - Ensure that your Notebook PC is plugged in to a power source before resetting your system.
-

Windows® 10 allows you to do any of the following recovery options:

- **Keep my files** - This option allows you refresh your Notebook PC without affecting personal files (photos, music, videos, documents).

Using this option, you can restore your Notebook PC to its default settings and delete other installed apps.

- **Remove everything** - This option resets your Notebook PC to its factory settings. You must backup your data before doing this option.

- **Go back to an earlier build** - This option allows you to go back to an earlier build. Use this option if this build is not working for you.
- **Advanced startup** - Using this option allows you to perform other advanced recovery options on your Notebook PC such as:
 - Using a USB drive, network connection or Windows recovery DVD to startup your Notebook PC.
 - Using **Troubleshoot** to enable any of these advanced recovery options: System Restore, System Image Recovery, Startup Repair, Command Prompt, UEFI Firmware Settings, and Startup Settings.

Performing a recovery option

Refer to the following steps if you want to access and use any of the available recovery options for your Notebook PC.

1. Launch **Settings** and select **Update and security**.

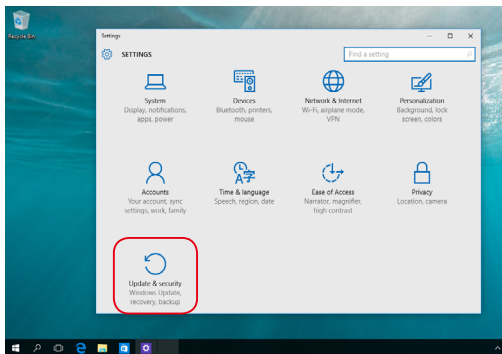

2. Under the **Update and security** option, select **Recovery** then select the recovery option you would like to perform.

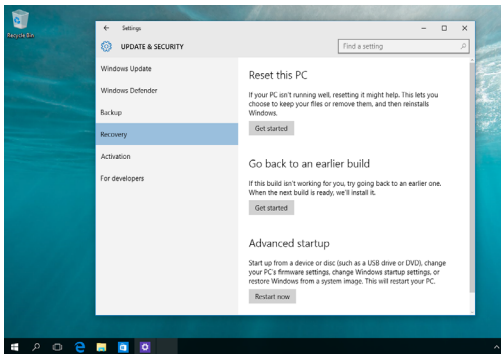

Chapter 5: ***Upgrading your Notebook PC***

Installing a Random-access Memory module (on selected models)

Upgrade the memory capacity of your Notebook PC by installing a RAM (random-access memory module) in the memory module compartment. The following steps show you how to install a RAM module into your Notebook PC:

WARNING! Disconnect all the connected peripherals, any telephone or telecommunication lines and power connector (such as external power supply, battery pack, etc.) before removing the compartment cover.

IMPORTANT! Visit an authorized service center or retailer for information on RAM module upgrades for your Notebook PC. Purchase RAM modules from authorized retailers of this Notebook PC to ensure maximum compatibility and reliability.

NOTE: The appearance of your Notebook PC's bottom side and RAM module may vary per model but the RAM module installation remains the same.

- A. Loosen the screw of the Notebook PC's compartment cover.
- B. Pull out the compartment cover and remove it completely from your Notebook PC.

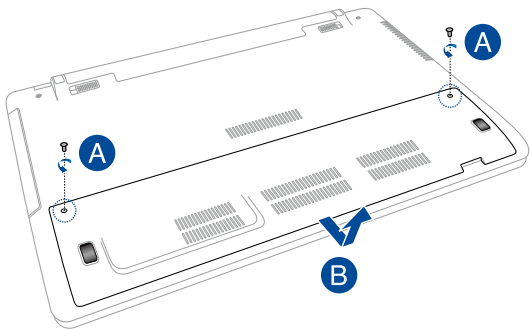

- C. Align and insert the RAM module into the RAM module slot.
- D. Push down the RAM module until it clicks in place.

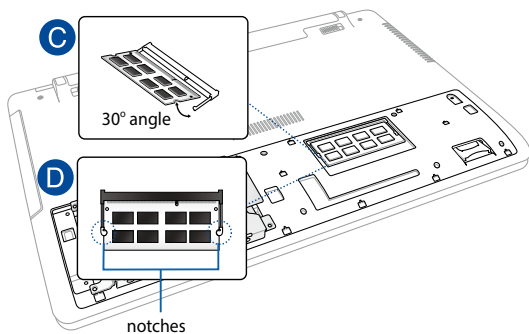

- E. Align then push down the compartment cover back into place.
- F. Reattach and tighten the screw that you removed earlier.

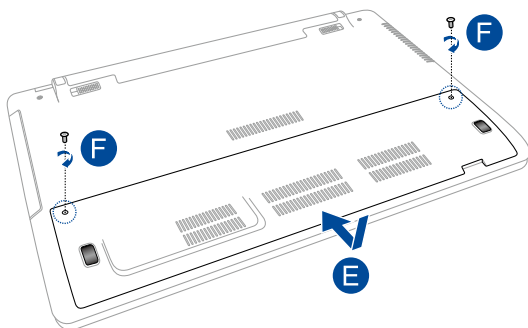

Replacing the Hard Disk Drive (on selected models)

Refer to the following steps if you need to replace the HDD (hard disk drive) of your Notebook PC.

IMPORTANT! Purchase an HDD from authorized retailers of this Notebook PC to ensure maximum compatibility and reliability. It is recommended that you replace the HDD under professional supervision. You may also visit an authorized service center for further assistance.

WARNING! Disconnect all the connected peripherals, any telephone or telecommunication lines and power connector (such as external power supply, battery pack, etc.) before removing the compartment cover.

NOTE: The appearance of your Notebook PC's bottom side and HDD may vary per model but the HDD installation remains the same.

- A. Loosen the screw of the Notebook PC's compartment cover.
- B. Pull out the compartment cover and remove it completely from your Notebook PC.

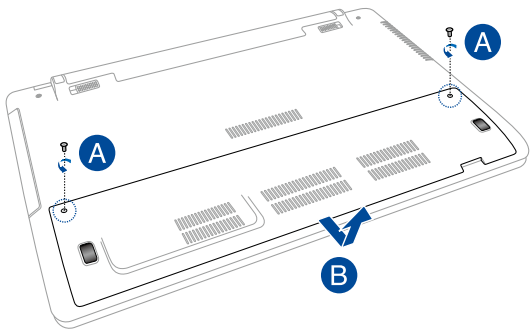

- C. Remove the screws securing the HDD bay to the compartment.
- D. Disconnect the HDD bay from the HDD port then remove the HDD bay from the compartment.

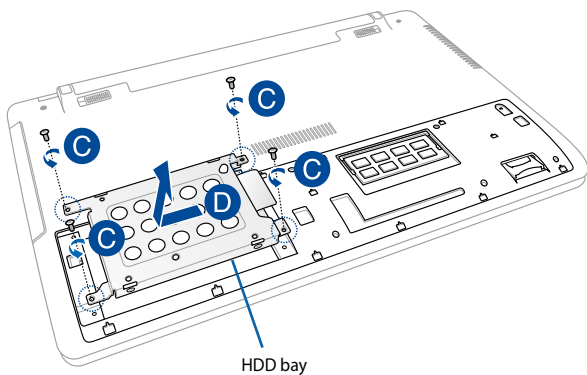

- E. Turn the HDD bay upside down then remove the screws.
- F. Remove the old HDD from the HDD bay.

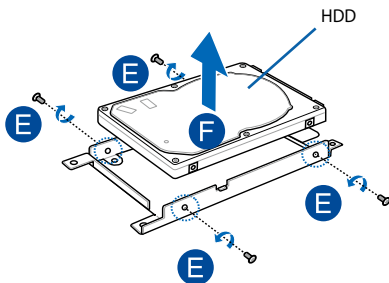

- G. Place the new HDD with its PCB (printed circuit board) facing the HDD bay. Ensure that the port connectors of your HDD are not obstructed by any part of the HDD bay.
- H. Reattach and secure the HDD with the screws you removed earlier.

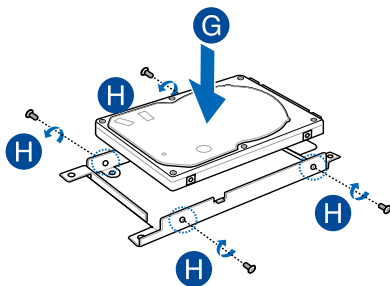

- I. Replace the HDD bay back in the compartment, with the HDD connector aligned with the Notebook PC's HDD port. Push the HDD bay until it connects with the Notebook PC.
- J. Secure the HDD bay with the screws you removed earlier.

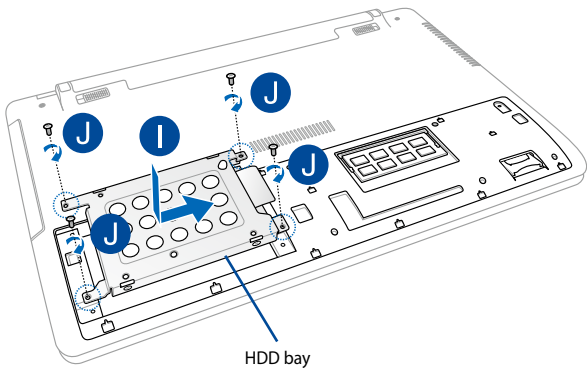

- K. Align then push down the compartment cover back into place.
- L. Reattach and tighten the screw that you removed earlier.

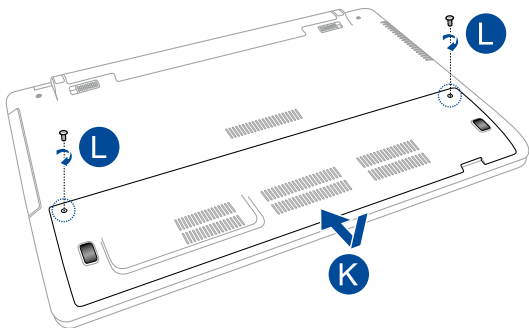

Installing a new battery pack (on selected models)

WARNING! Turn off your Notebook PC and disconnect all connected peripherals, any telephone or telecommunication lines and power connector, before removing the battery pack.

IMPORTANT! Purchase battery packs from authorized retailers of this Notebook PC to ensure maximum compatibility and reliability.

NOTE: The following steps are also applicable for removing and replacing the battery pack of your Notebook PC.

Refer to the following steps when installing a new battery pack for your Notebook PC.

- A. Move the manual battery lock to the unlocked position.
- B. Move and hold the spring battery lock to an unlocked position.
- C. Pull out the old battery pack from the battery slot then release your hold on the spring battery lock.

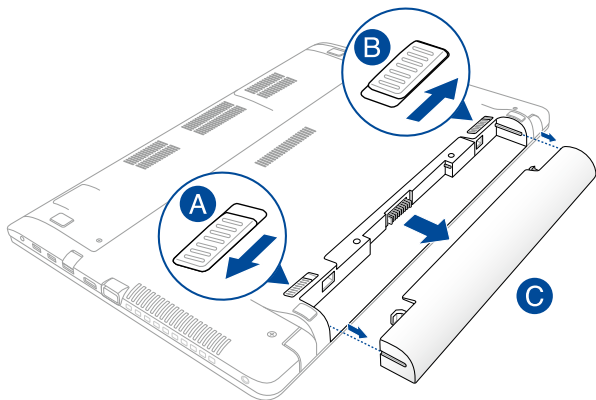

- D. Move the manual battery lock to the unlocked position.
- E. Align and insert the new battery pack into the Notebook PC's battery slot.
- F. Move the manual battery lock back to the locked position after inserting the battery pack.

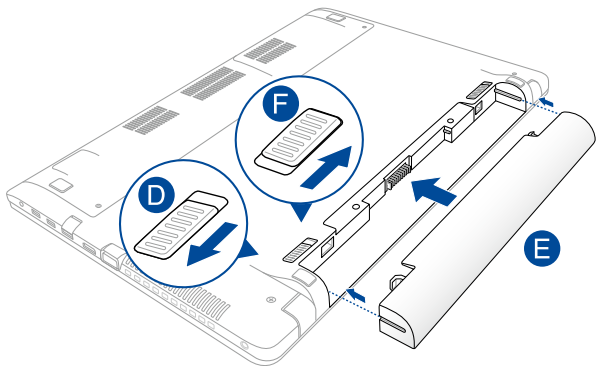

Appendices

DVD-ROM Drive Information (on selected models)

The DVD-ROM drive allows you to view and create your own CDs and DVDs. You can purchase an optional DVD viewer software to view DVD titles.

Regional Playback Information

Playback of DVD movie titles involves decoding MPEG2 video, digital AC3 audio and decryption of CSS protected content. CSS (sometimes called copy guard) is the name given to the content protection scheme adopted by the motion picture industry to satisfy a need to protect against unlawful content duplication.

Although the design rules imposed on CSS licensors are many, one rule that is most relevant is playback restrictions on regionalized content. In order to facilitate geographically staggered movie releases, DVD video titles are released for specific geographic regions as defined in "Region Definitions" below. Copyright laws require that all DVD movies be limited to a particular region (usually coded to the region at which it is sold). While DVD movie content may be released for multiple regions, CSS design rules require that any system capable of playing CSS encrypted content must only be capable of playing one region.

IMPORTANT! The region setting may be changed up to five times using the viewer software, then it can only play DVD movies for the last region setting. Changing the region code after that will require factory resetting which is not covered by warranty. If resetting is desired, shipping and resetting costs will be at the expense of the user.

Region Definitions

Region 1

Canada, US, US Territories

Region 2

Czech, Egypt, Finland, France, Germany, Gulf States, Hungary, Iceland, Iran, Iraq, Ireland, Italy, Japan, Netherlands, Norway, Poland, Portugal, Saudi Arabia, Scotland, South Africa, Spain, Sweden, Switzerland, Syria, Turkey, UK, Greece, Former Yugoslav Republics, Slovakia

Region 3

Burma, Indonesia, South Korea, Malaysia, Philippines, Singapore, Taiwan, Thailand, Vietnam

Region 4

Australia, Caribbean (Except US Territories), Central America, New Zealand, Pacific Islands, South America

Region 5

CIS, India, Pakistan, Rest of Africa, Russia, North Korea

Region 6

China

Blu-ray ROM Drive Information (on selected models)

The Blu-ray ROM Drive allows you to view high definition (HD) videos and other disc file formats such as DVDs and CDs.

Region Definitions

Region A

North, Central and South American countries, and their territories; Taiwan, Hong Kong, Macao, Japan, Korea (South and North), South East Asian countries and their territories.

Region B

European, African, and South West Asian countries and their territories; Australia and New Zealand.

Region C

Central, South Asian, Eastern European countries and their territories; China and Mongolia.

NOTE: Refer to Blu-ray Disc website at www.blu-raydisc.com/en/Technical/FAQs/Blu-rayDiscforVideo.aspx for more details.

Internal Modem Compliancey

The Notebook PC with internal modem model complies with JATE (Japan), FCC (US, Canada, Korea, Taiwan), and CTR21. The internal modem has been approved in accordance with Council Decision 98/482/EC for pan-European single terminal connection to the public switched telephone network (PSTN). However due to differences between the individual PSTNs provided in different countries, the approval does not, of itself, give an unconditional assurance of successful operation on every PSTN network termination point. In the event of problems you should contact your equipment supplier in the first instance.

Overview

On 4th August 1998 the European Council Decision regarding the CTR 21 has been published in the Official Journal of the EC. The CTR 21 applies to all non voice terminal equipment with DTMF-dialling which is intended to be connected to the analogue PSTN (Public Switched Telephone Network).

CTR 21 (Common Technical Regulation) for the attachment requirements for connection to the analogue public switched telephone networks of terminal equipment (excluding terminal equipment supporting the voice telephony justified case service) in which network addressing, if provided, is by means of dual tone multifrequency signalling.

Network Compatibility Declaration

Statement to be made by the manufacturer to the Notified Body and the vendor: "This declaration will indicate the networks with which the equipment is designed to work and any notified networks with which the equipment may have inter-working difficulties."

Statement to be made by the manufacturer to the user: "This declaration will indicate the networks with which the equipment is designed to work and any notified networks with which the equipment may have inter-working difficulties. The manufacturer shall also associate a statement to make it clear where network compatibility is dependent on physical and software switch settings. It will also advise the user to contact the vendor if it is desired to use the equipment on another network."

Up to now the Notified Body of CETECOM issued several pan-European approvals using CTR 21. The results are Europe's first modems which do not require regulatory approvals in each individual European country.

Non-Voice Equipment

Answering machines and loud-speaking telephones can be eligible as well as modems, fax machines, auto-dialers and alarm systems. Equipment in which the end-to-end quality of speech is controlled by regulations (e.g. handset telephones and in some countries also cordless telephones) is excluded.

This table shows the countries currently under the CTR21 standard.

Country	Applied	More Testing
Austria ¹	Yes	No
Belgium	Yes	No
Czech Republic	No	Not Applicable
Denmark ¹	Yes	Yes
Finland	Yes	No
France	Yes	No
Germany	Yes	No
Greece	Yes	No
Hungary	No	Not Applicable
Iceland	Yes	No
Ireland	Yes	No
Italy	Still Pending	Still Pending
Israel	No	No
Lichtenstein	Yes	No
Luxemburg	Yes	No
The Netherlands ¹	Yes	Yes
Norway	Yes	No
Poland	No	Not Applicable
Portugal	No	Not Applicable
Spain	No	Not Applicable
Sweden	Yes	No
Switzerland	Yes	No
United Kingdom	Yes	No

This information was copied from CETECOM and is supplied without liability. For updates to this table, you may visit http://www.cetecom.de/technologies/ctr_21.html

1 National requirements will apply only if the equipment may use pulse dialling (manufacturers may state in the user guide that the equipment is only intended to support DTMF signalling, which would make any additional testing superfluous).

In The Netherlands additional testing is required for series connection and caller ID facilities.

Federal Communications Commission Interference Statement

This device complies with FCC Rules Part 15. Operation is subject to the following two conditions:

- This device may not cause harmful interference.
- This device must accept any interference received, including interference that may cause undesired operation.

This equipment has been tested and found to comply with the limits for a class B digital device, pursuant to Part 15 of the Federal Communications Commission (FCC) rules. These limits are designed to provide reasonable protection against harmful interference in a residential installation. This equipment generates, uses, and can radiate radio frequency energy and, if not installed and used in accordance with the instructions, may cause harmful interference to radio communications. However, there is no guarantee that interference will not occur in a particular installation. If this equipment does cause harmful interference to radio or television reception, which can be determined by turning the equipment off and on, the user is encouraged to try to correct the interference by one or more of the following measures:

- Reorient or relocate the receiving antenna.
- Increase the separation between the equipment and receiver.

- Connect the equipment into an outlet on a circuit different from that to which the receiver is connected.
- Consult the dealer or an experienced radio/TV technician for help.

WARNING! The use of a shielded-type power cord is required in order to meet FCC emission limits and to prevent interference to the nearby radio and television reception. It is essential that only the supplied power cord be used. Use only shielded cables to connect I/O devices to this equipment. You are cautioned that changes or modifications not expressly approved by the party responsible for compliance could void your authority to operate the equipment.

(Reprinted from the Code of Federal Regulations #47, part 15.193, 1993. Washington DC: Office of the Federal Register, National Archives and Records Administration, U.S. Government Printing Office.)

FCC Radio Frequency (RF) Exposure Caution Statement

WARNING! Any changes or modifications not expressly approved by the party responsible for compliance could void the user's authority to operate this equipment. "The manufacture declares that this device is limited to Channels 1 through 11 in the 2.4GHz frequency by specified firmware controlled in the USA."

This equipment complies with FCC radiation exposure limits set forth for an uncontrolled environment. To maintain compliance with FCC RF exposure compliance requirements, please avoid direct contact to the transmitting antenna during transmitting. End users must follow the specific operating instructions for satisfying RF exposure compliance.

Declaration of Conformity (R&TTE directive 1999/5/EC)

The following items were completed and are considered relevant and sufficient:

- Essential requirements as in [Article 3]
- Protection requirements for health and safety as in [Article 3.1a]
- Testing for electric safety according to [EN 60950]
- Protection requirements for electromagnetic compatibility in [Article 3.1b]
- Testing for electromagnetic compatibility in [EN 301 489-1] & [EN 301 489-17]
- Effective use of the radio spectrum as in [Article 3.2]
- Radio test suites according to [EN 300 328-2]

CE Marking



CE marking for devices without wireless LAN/Bluetooth

The shipped version of this device complies with the requirements of the EEC directives 2004/108/EC “Electromagnetic compatibility” and 2006/95/EC “Low voltage directive”.



CE marking for devices with wireless LAN/ Bluetooth

This equipment complies with the requirements of Directive 1999/5/EC of the European Parliament and Commission from 9 March, 1999 governing Radio and Telecommunications Equipment and mutual recognition of conformity.

IC Radiation Exposure Statement for Canada

This equipment complies with IC radiation exposure limits set forth for an uncontrolled environment. To maintain compliance with IC RF exposure compliance requirements, please avoid direct contact to the transmitting antenna during transmitting. End users must follow the specific operating instructions for satisfying RF exposure compliance.

Operation is subject to the following two conditions:

- This device may not cause interference and
- This device must accept any interference, including interference that may cause undesired operation of the device.

To prevent radio interference to the licensed service (i.e. co-channel Mobile Satellite systems) this device is intended to be operated indoors and away from windows to provide maximum shielding. Equipment (or its transmit antenna) that is installed outdoors is subject to licensing.

This device complies with Industry Canada licence-exempt RSS standard(s).

CAN ICES-3(B)/NMB-3(B)

Déclaration d'Industrie Canada relative à l'exposition aux ondes radio

Cet appareil est conforme aux limites d'exposition aux radiations d'Industrie Canada définies pour un environnement non-contrôlé. Pour maintenir la conformité avec les exigences d'exposition RF d'IC, veuillez éviter tout contact direct avec l'antenne pendant l'émission. Les utilisateurs finaux doivent suivre les instructions de fonctionnement spécifiques pour satisfaire la conformité aux expositions RF.

Son utilisation est sujette aux deux conditions suivantes :

- Cet appareil ne peut pas causer d'interférence, et
- Cet appareil doit accepter toute interférence, y compris les interférences qui pourraient causer un fonctionnement non souhaité de l'appareil.

Pour éviter les interférences radio avec le service sous licence (c'est à-dire le partage de canal avec les systèmes de téléphonie satellite), cet appareil est destiné à être utilisé en intérieur et loin des fenêtres pour fournir un blindage maximal. Tout appareil (ou son antenne d'émission) qui est installé en extérieur est sujet à cette licence.

Le présent appareil est conforme aux CNR d'Industrie Canada applicables aux appareils radio exempts de licence.

CAN ICES-3(B)/NMB-3(B)

Wireless Operation Channel for Different Domains

N. America	2.412-2.462 GHz	Ch01 through CH11
Japan	2.412-2.484 GHz	Ch01 through Ch14
Europe ETSI	2.412-2.472 GHz	Ch01 through Ch13

France Restricted Wireless Frequency Bands

Some areas of France have a restricted frequency band. The worst case maximum authorized power indoors are:

- 10mW for the entire 2.4 GHz band (2400 MHz–2483.5 MHz)
- 100mW for frequencies between 2446.5 MHz and 2483.5 MHz

NOTE: Channels 10 through 13 inclusive operate in the band 2446.6 MHz to 2483.5 MHz.

There are few possibilities for outdoor use: on private property or on the private property of public persons, use is subject to a preliminary authorization procedure by the Ministry of Defense, with maximum authorized power of 100mW in the 2446.5–2483.5 MHz band. Use outdoors on public property is not permitted.

In the departments listed below, for the entire 2.4 GHz band:

- Maximum authorized power indoors is 100mW
- Maximum authorized power outdoors is 10mW

Departments in which the use of the 2400–2483.5 MHz band is permitted with an EIRP of less than 100mW indoors and less than 10mW outdoors:

01 Ain	02 Aisne	03 Allier
05 Hautes Alpes	08 Ardennes	09 Ariège
11 Aude	12 Aveyron	16 Charente
24 Dordogne	25 Doubs	26 Drôme
32 Gers	36 Indre	37 Indre et Loire
41 Loir et Cher	45 Loiret	50 Manche
55 Meuse	58 Nièvre	59 Nord
60 Oise	61 Orne	63 Puy du Dôme
64 Pyrénées Atlantique	66 Pyrénées Orientales	67 Bas Rhin
68 Haut Rhin	70 Haute Saône	71 Saône et Loire
75 Paris	82 Tarn et Garonne	84 Vaucluse
88 Vosges	89 Yonne	90 Territoire de Belfort
94 Val de Marne		

This requirement is likely to change over time, allowing you to use your wireless LAN card in more areas within France. Please check with ART for the latest information (www.arcep.fr)

NOTE: Your WLAN Card transmits less than 100mW, but more than 10mW.

UL Safety Notices

Required for UL 1459 covering telecommunications (telephone) equipment intended to be electrically connected to a telecommunication network that has an operating voltage to ground that does not exceed 200V peak, 300V peak-to-peak, and 105V rms, and installed or used in accordance with the National Electrical Code (NFPA 70).

When using the Notebook PC modem, basic safety precautions should always be followed to reduce the risk of fire, electric shock, and injury to persons, including the following:

- DO NOT use the Notebook PC near water, for example, near a bath tub, wash bowl, kitchen sink or laundry tub, in a wet basement or near a swimming pool.
- DO NOT use the Notebook PC during an electrical storm. There may be a remote risk of electric shock from lightning.
- DO NOT use the Notebook PC in the vicinity of a gas leak.

Required for UL 1642 covering primary (nonrechargeable) and secondary (rechargeable) lithium batteries for use as power sources in products. These batteries contain metallic lithium, or a lithium alloy, or a lithium ion, and may consist of a single electrochemical cell or two or more cells connected in series, parallel, or both, that convert chemical energy into electrical energy by an irreversible or reversible chemical reaction.

- Do not dispose the Notebook PC battery pack in a fire, as they may explode. Check with local codes for possible special disposal instructions to reduce the risk of injury to persons due to fire or explosion.
- Do not use power adapters or batteries from other devices to reduce the risk of injury to persons due to fire or explosion. Use only UL certified power adapters or batteries supplied by the manufacturer or authorized retailers.

Power Safety Requirement

Products with electrical current ratings up to 6A and weighing more than 3Kg must use approved power cords greater than or equal to: H05VV-F, 3G, 0.75mm² or H05VV-F, 2G, 0.75mm².

TV Notices

Note to CATV System Installer—Cable distribution system should be grounded (earthed) in accordance with ANSI/NFPA 70, the National Electrical Code (NEC), in particular Section 820.93, Grounding of Outer Conductive Shield of a Coaxial Cable – installation should include bonding the screen of the coaxial cable to the earth at the building entrance.

REACH

Complying with the REACH (Registration, Evaluation, Authorization, and Restriction of Chemicals) regulatory framework, we publish the chemical substances in our products at ASUS REACH website at <http://csr.asus.com/english/REACH.htm>.

Macrovision Corporation Product Notice

This product incorporates copyright protection technology that is protected by method claims of certain U.S.A. patents and other intellectual property rights owned by Macrovision Corporation and other rights owners. Use of this copyright protection technology must be authorized by Macrovision Corporation, and is intended for home and other limited viewing uses only *unless otherwise authorized by Macrovision Corporation*. Reverse engineering or disassembly is prohibited.

Prevention of Hearing Loss

To prevent possible hearing damage, do not listen at high volume levels for long periods.



Nordic Lithium Cautions (for lithium-ion batteries)

CAUTION! Danger of explosion if battery is incorrectly replaced. Replace only with the same or equivalent type recommended by the manufacturer. Dispose of used batteries according to the manufacturer's instructions. (English)

ATTENZIONE! Rischio di esplosione della batteria se sostituita in modo errato. Sostituire la batteria con un una di tipo uguale o equivalente consigliata dalla fabbrica. Non disperdere le batterie nell'ambiente. (Italian)

VORSICHT! Explosionsgefahr bei unsachgemäßen Austausch der Batterie. Ersatz nur durch denselben oder einem vom Hersteller empfohlenem ähnlichen Typ. Entsorgung gebrauchter Batterien nach Angaben des Herstellers. (German)

ADVARSEL! Lithiumbatteri - Eksplosionsfare ved fejlagtig håndtering. Udskiftning må kun ske med batteri af samme fabrikat og type. Levér det brugte batteri tilbage til leverandøren. (Danish)

WARNING! Explosionsfara vid felaktigt batteribyte. Använd samma batterityp eller en ekvivalent typ som rekommenderas av apparattillverkaren. Kassera använt batteri enligt fabrikantens instruktion. (Swedish)

VAROITUS! Paristo voi räjähtää, jos se on virheellisesti asennettu. Vaihda paristo ainoastaan laitevalmistajan suosittellemaan tyyppiin. Hävitä käytetty paristo valmistagan ohjeiden mukaisesti. (Finnish)

ATTENTION! Il y a danger d'explosion s'il y a remplacement incorrect de la batterie. Remplacer uniquement avec une batterie du même type ou d'un type équivalent recommandé par le constructeur. Mettre au rebut les batteries usagées conformément aux instructions du fabricant. (French)

ADVARSEL! Eksplosjonsfare ved feilaktig skifte av batteri. Benytt samme batteritype eller en tilsvarende type anbefalt av apparatfabrikanten. Brukte batterier kasseres i henhold til fabrikantens instruksjoner. (Norwegian)

標準品以外の使用は、危険の元になります。交換品を使用する場合、製造者に指定されるものを使って下さい。製造者の指示に従って処理して下さい。(Japanese)

ВНИМАНИЕ! При замене аккумулятора на аккумулятор иного типа возможно его возгорание. Утилизируйте аккумулятор в соответствии с инструкциями производителя. (Russian)

Optical Drive Safety Information

Laser Safety Information

CD-ROM Drive Safety Warning

CLASS 1 LASER PRODUCT

WARNING! To prevent exposure to the optical drive's laser, do not attempt to disassemble or repair the optical drive by yourself. For your safety, contact a professional technician for assistance.

Service warning label

WARNING! INVISIBLE LASER RADIATION WHEN OPEN. DO NOT STARE INTO BEAM OR VIEW DIRECTLY WITH OPTICAL INSTRUMENTS.

CDRH Regulations

The Center for Devices and Radiological Health (CDRH) of the U.S. Food and Drug Administration implemented regulations for laser products on August 2, 1976. These regulations apply to laser products manufactured from August 1, 1976. Compliance is mandatory for products marketed in the United States.

WARNING! Use of controls or adjustments or performance of procedures other than those specified herein or in the laser product installation guide may result in hazardous radiation exposure.

Coating Notice

IMPORTANT! To provide electrical insulation and maintain electrical safety, a coating is applied to insulate the device except on the areas where the I/O ports are located.

CTR 21 Approval (for Notebook PC with built-in Modem)

Danish

„Udstyret er i henhold til Rådets beslutning 98/482/EF EU-godkendt til at blive opkoblet på de offentlige telefonnet som enkeltforbundet terminal. På grund af forskelle mellem de offentlige telefonnet i de forskellige lande giver godkendelsen dog ikke i sig selv ubetinget garanti for, at udstyret kan fungere korrekt på samtlige nettermineringspunkter på de offentlige telefonnet.

I tilfælde af problemer bør De i første omgang henvende Dem til leverandøren af udstyret.

Dutch

„Dit apparaat is goedgekeurd volgens Beschikking 98/482/EG van de Raad voor de pan-Europese aansluiting van enkelvoudige eindapparatuur op het openbare geschakelde telefoonnetwerk (PSTN). Gezien de verschillen tussen de individuele PSTN's in de verschillende landen, biedt deze goedkeuring op zichzelf geen onvoorwaardelijke garantie voor een succesvolle werking op elk PSTN-netwerkaansluitpunt.

Neem bij problemen in eerste instantie contact op met de leverancier van het apparaat.

English

“The equipment has been approved in accordance with Council Decision 98/482/EC for pan-European single terminal connection to the public switched telephone network (PSTN). However, due to differences between the individual PSTNs provided in different countries, the approval does not, of itself, give an unconditional assurance of successful operation on every PSTN network termination point.

In the event of problems, you should contact your equipment supplier in the first instance.”

Finnish

”Tämä laite on hyväksytty neuvoston päätöksen 98/482/EY mukaisesti liitettäväksi yksittäisenä laitteena yleiseen kytkentäiseen puhelinverkkoon (PSTN) EU:n jäsenvaltioissa. Eri maiden yleisten kytkentäisten puhelinverkkojen välillä on kuitenkin eroja, joten hyväksyntä ei sellaisenaan takaa häiriötöntä toimintaa kaikkien yleisten kytkentäisten puhelinverkkojen liittytärpisteissä.

Ongelmien ilmetessä ottakaa viipymättä yhteyttä laitteen toimittajaan.”

French

•Cet équipement a reçu l'agrément, conformément à la décision 98/482/CE du Conseil, concernant la connexion paneuropéenne de terminal unique aux réseaux téléphoniques publics commutés (RTPC). Toutefois, comme il existe des différences d'un pays à l'autre entre les RTPC, l'agrément en soi ne constitue pas une garantie absolue de fonctionnement optimal à chaque point de terminaison du réseau RTPC.

En cas de problème, vous devez contacter en premier lieu votre fournisseur.

German

„Dieses Gerät wurde gemäß der Entscheidung 98/482/EG des Rates europaweit zur Anschaltung als einzelne Endeinrichtung an das öffentliche Fernsprechnetz zugelassen. Aufgrund der zwischen den öffentlichen Fernsprechnetzen verschiedener Staaten bestehenden Unterschiede stellt diese Zulassung an sich jedoch keine unbedingte Gewähr für einen erfolgreichen Betrieb des Geräts an jedem Netzabschlußpunkt dar.

Falls beim Betrieb Probleme auftreten, sollten Sie sich zunächst an ihren Fachhändler wenden.“

Greek

«Ο εξοπλισμός έχει εγκριθεί για πανευρωπαϊκή σύνδεση μεμονωμένου τερματικού με το δημόσιο τηλεφωνικό δίκτυο μεταγωγής (PSTN), σύμφωνα με την απόφαση 98/482/ΕΚ του Συμβουλίου· ωστόσο, επειδή υπάρχουν διαφορές μεταξύ των επιμέρους PSTN που παρέχονται σε διάφορες χώρες, η έγκριση δεν παρέχει απ' αυτής ανεπιφύλακτη εξασφάλιση επιτυχούς λειτουργίας σε κάθε σημείο απόληξης του δικτύου PSTN.

Εάν ανακύψουν προβλήματα, θα πρέπει κατ' αρχάς να απευθύνεστε στον προμηθευτή του εξοπλισμού σας.»

Italian

«La presente apparecchiatura terminale è stata approvata in conformità della decisione 98/482/CE del Consiglio per la connessione paneuropea come terminale singolo ad una rete analogica PSTN. A causa delle differenze tra le reti dei differenti paesi, l'approvazione non garantisce però di per sé il funzionamento corretto in tutti i punti di terminazione di rete PSTN.

In caso di problemi contattare in primo luogo il fornitore del prodotto.»

Portuguese

«Este equipamento foi aprovado para ligação pan-europeia de um único terminal à rede telefónica pública comutada (RTPC) nos termos da Decisão 98/482/CE. No entanto, devido às diferenças existentes entre as RTPC dos diversos países, a aprovação não garante incondicionalmente, por si só, um funcionamento correcto em todos os pontos terminais da rede da RTPC.

Em caso de problemas, deve entrar-se em contacto, em primeiro lugar, com o fornecedor do equipamento.»

Spanish

«Este equipo ha sido homologado de conformidad con la Decisión 98/482/CE del Consejo para la conexión paneuropea de un terminal simple a la red telefónica pública conmutada (RTPC). No obstante, a la vista de las diferencias que existen entre las RTPC que se ofrecen en diferentes países, la homologación no constituye por sí sola una garantía incondicional de funcionamiento satisfactorio en todos los puntos de terminación de la red de una RTPC.

En caso de surgir algún problema, procede ponerse en contacto en primer lugar con el proveedor del equipo.»

Swedish

”Utrustningen har godkänts i enlighet med rådets beslut 98/482/EG för alleuropeisk anslutning som enskild terminal till det allmänt tillgängliga kopplade telenätet (PSTN). På grund av de skillnader som finns mellan telenätet i olika länder utgör godkännandet emellertid inte i sig självt en absolut garanti för att utrustningen kommer att fungera tillfredsställande vid varje telenätsanslutningspunkt.

Om problem uppstår bör ni i första hand kontakta leverantören av utrustningen.”

ENERGY STAR complied product



ENERGY STAR is a joint program of the U.S. Environmental Protection Agency and the U.S. Department of Energy helping us all save money and protect the environment through energy efficient products and practices.

All ASUS products with the ENERGY STAR logo comply with the ENERGY STAR standard, and the power management feature is enabled by default. The monitor and computer are automatically set to sleep after 10 and 30 minutes of user inactivity. To wake your computer, click the mouse or press any key on the keyboard. Please visit <http://www.energy.gov/powermanagement> for detail information on power management and its benefits to the environment. In addition, please visit <http://www.energystar.gov> for detail information on the ENERGY STAR joint program.

NOTE: Energy Star is NOT supported on FreeDOS and Linux-based operating systems.

Global Environmental Regulation Compliance and Declaration

ASUS follows the green design concept to design and manufacture our products, and makes sure that each stage of the product life cycle of ASUS product is in line with global environmental regulations. In addition, ASUS disclose the relevant information based on regulation requirements.

Please refer to <http://csr.asus.com/english/Compliance.htm> for information disclosure based on regulation requirements ASUS is complied with:

Japan JIS-C-0950 Material Declarations

EU REACH SVHC

Korea RoHS

ASUS Recycling/Takeback Services

ASUS recycling and takeback programs come from our commitment to the highest standards for protecting our environment. We believe in providing solutions for you to be able to responsibly recycle our products, batteries, other components as well as the packaging materials. Please go to <http://csr.asus.com/english/Takeback.htm> for detailed recycling information in different regions.

Regional notice for Singapore

Complies with IDA Standards DB103778
--

This ASUS product complies with IDA Standards.

EC Declaration of Conformity



We, the undersigned,

Manufacturer:	ASUSTeK COMPUTER INC.
Address:	4F, No. 150, LI-TE Rd., PEITOU, TAIPEI 112, TAIWAN
Authorized representative in Europe:	ASUS COMPUTER GmbH
Address, City:	HARKORT STR. 21-23, 40880 RATINGEN
Country:	GERMANY

declare the following apparatus:

Product name :	Notebook PC
Model name :	X450L, F450L, A450L, K450L, R409L, Y481L, D451L, P450L, E450L, X452L, F452L, R412L, D452L, Y482L, E452L, X452E, F452E, R412E, D452E, X452V, F452V, R412V, D452V, X452C, F452C, R412C, D452C, Y482C, X452M, F452M, R412M, D452M, Y482M

conform with the essential requirements of the following directives:

2004/108/EC-EMC Directive

<input checked="" type="checkbox"/> EN 55022:2010+AC:2011	<input checked="" type="checkbox"/> EN 55024:2010
<input checked="" type="checkbox"/> EN 61000-3-2:2006+A2:2009	<input checked="" type="checkbox"/> EN 61000-3-3:2008
<input type="checkbox"/> EN 55013:2001+A1:2003+A2:2006	<input type="checkbox"/> EN 55020:2007+A11:2011

1999/5/EC-R&TTE Directive

<input checked="" type="checkbox"/> EN 300 328 V1.7.1(2006-10)	<input checked="" type="checkbox"/> EN 301 489-1 V1.9.2(2011-09)
<input type="checkbox"/> EN 300 440-1 V1.6.1(2010-08)	<input type="checkbox"/> EN 301 489-3 V1.4.1(2002-08)
<input type="checkbox"/> EN 300 440-2 V1.4.1(2010-08)	<input type="checkbox"/> EN 301 489-4 V1.4.1(2009-05)
<input type="checkbox"/> EN 301 511 V9.0.2(2003-03)	<input type="checkbox"/> EN 301 489-7 V1.3.1(2005-11)
<input type="checkbox"/> EN 301 908-1 V5.2.1(2011-05)	<input type="checkbox"/> EN 301 489-9 V1.4.1(2007-11)
<input type="checkbox"/> EN 301 908-2 V5.2.1(2011-07)	<input checked="" type="checkbox"/> EN 301 489-17 V2.2.1(2012-09)
<input type="checkbox"/> EN 301 893 V1.6.1(2011-11)	<input type="checkbox"/> EN 301 489-24 V1.5.1(2010-09)
<input type="checkbox"/> EN 302 544-2 V1.1.1(2009-01)	<input type="checkbox"/> EN 302 326-2 V1.2.2(2007-06)
<input type="checkbox"/> EN 302 623 V1.1.1(2009-01)	<input type="checkbox"/> EN 302 326-3 V1.3.1(2007-09)
<input type="checkbox"/> EN 50360:2001	<input type="checkbox"/> EN 301 357-2 V1.4.1(2008-11)
<input type="checkbox"/> EN 62479:2010	<input type="checkbox"/> EN 302 291-1 V1.1.1(2005-07)
<input type="checkbox"/> EN 50385:2002	<input type="checkbox"/> EN 302 291-2 V1.1.1(2005-07)
<input checked="" type="checkbox"/> EN 62311:2008	

2006/95/EC-LVD Directive

<input checked="" type="checkbox"/> EN 60950-1 / A12:2011	<input type="checkbox"/> EN 60065:2002 / A12:2011
---	---

2009/125/EC-ErP Directive

<input type="checkbox"/> Regulation (EC) No. 1275/2008	<input checked="" type="checkbox"/> Regulation (EC) No. 278/2009
<input type="checkbox"/> Regulation (EC) No. 642/2009	<input checked="" type="checkbox"/> Regulation (EC) No. 617/2013

2011/65/EU-RoHS Directive

Ver. 140331

CE marking



(EC conformity marking)

Position : **CEO**

Name : **Jerry Shen**

Signature : _____

Original Declaration Date: 01/08/2013

Corrected Declaration Date: 11/07/2014

Year to begin affixing CE marking: 2014

EC Declaration of Conformity



We, the undersigned,

Manufacturer:	ASUSTeK COMPUTER INC.
Address:	4F, No. 150, LI-TE Rd., PEITOU, TAIPEI 112, TAIWAN
Authorized representative in Europe:	ASUS COMPUTER GmbH
Address, City:	HARKORT STR. 21-23, 40880 RATINGEN
Country:	GERMANY

declare the following apparatus:

Product name :	Notebook PC
Model name :	X552W,K552W,F552W,A552W,R513W,Y582W,X550W,F550W,R510W,D552W,X550J,F550J,K550J,A550J,R510J,Y581J,X552M,F552M,K552M,A552M,R513M,D552M,Y582M,X552L,F552L,R513L,D552L,Y582L,Y581L,E550L,PRO550L,X550L,A550L,K550L,F550L,R510L,P550L

conform with the essential requirements of the following directives:

2004/108/EC-EMC Directive

<input checked="" type="checkbox"/> EN 55022:2010+AC:2011	<input checked="" type="checkbox"/> EN 55024:2010
<input checked="" type="checkbox"/> EN 61000-3-2:2006+A2:2009	<input checked="" type="checkbox"/> EN 61000-3-3:2008
<input type="checkbox"/> EN 55013:2001+A1:2003+A2:2006	<input type="checkbox"/> EN 55020:2007+A11:2011

1999/5/EC-R&TTE Directive

<input checked="" type="checkbox"/> EN 300 328 V1.7.1(2006-10)	<input checked="" type="checkbox"/> EN 301 489-1 V1.9.2(2011-09)
<input checked="" type="checkbox"/> EN 300 440-1 V1.6.1(2010-08)	<input type="checkbox"/> EN 301 489-3 V1.4.1(2002-08)
<input type="checkbox"/> EN 300 440-2 V1.4.1(2010-08)	<input type="checkbox"/> EN 301 489-4 V1.4.1(2009-05)
<input type="checkbox"/> EN 301 511 V9.0.2(2003-03)	<input type="checkbox"/> EN 301 489-7 V1.3.1(2005-11)
<input type="checkbox"/> EN 301 908-1 V5.2.1(2011-05)	<input type="checkbox"/> EN 301 489-9 V1.4.1(2007-11)
<input type="checkbox"/> EN 301 908-2 V5.2.1(2011-07)	<input checked="" type="checkbox"/> EN 301 489-17 V2.2.1(2012-09)
<input type="checkbox"/> EN 301 893 V1.6.1(2011-11)	<input type="checkbox"/> EN 301 489-24 V1.5.1(2010-09)
<input type="checkbox"/> EN 302 544-2 V1.1.1(2009-01)	<input type="checkbox"/> EN 302 326-2 V1.2.2(2007-06)
<input type="checkbox"/> EN 302 623 V1.1.1(2009-01)	<input type="checkbox"/> EN 302 326-3 V1.3.1(2007-09)
<input type="checkbox"/> EN 50360:2001	<input type="checkbox"/> EN 301 357-2 V1.4.1(2008-11)
<input type="checkbox"/> EN 62479:2010	<input type="checkbox"/> EN 302 291-1 V1.1.1(2005-07)
<input type="checkbox"/> EN 50385:2002	<input type="checkbox"/> EN 302 291-2 V1.1.1(2005-07)
<input checked="" type="checkbox"/> EN 62311:2008	

2006/95/EC-LVD Directive

<input checked="" type="checkbox"/> EN 60950-1 / A12:2011	<input type="checkbox"/> EN 60065:2002 / A12:2011
---	---

2009/125/EC-ErP Directive

<input checked="" type="checkbox"/> Regulation (EC) No. 1275/2008	<input checked="" type="checkbox"/> Regulation (EC) No. 278/2009
<input type="checkbox"/> Regulation (EC) No. 642/2009	<input type="checkbox"/> Regulation (EC) No. 617/2013

2011/65/EU-RoHS Directive

Ver. 140331

CE marking



(EC conformity marking)

Position : **CEO**

Name : **Jerry Shen**

Declaration Date: 30/05/2014

Year to begin affixing CE marking: 2014

Signature : _____



Free Manuals Download Website

<http://myh66.com>

<http://usermanuals.us>

<http://www.somanuals.com>

<http://www.4manuals.cc>

<http://www.manual-lib.com>

<http://www.404manual.com>

<http://www.luxmanual.com>

<http://aubethermostatmanual.com>

Golf course search by state

<http://golfingnear.com>

Email search by domain

<http://emailbydomain.com>

Auto manuals search

<http://auto.somanuals.com>

TV manuals search

<http://tv.somanuals.com>