

# Z9PR-D12 Series

**ASUS**<sup>®</sup>

# Motherboard

E7271

First Edition

April 2012

**Copyright © 2012 ASUSTeK COMPUTER INC. All Rights Reserved.**

No part of this manual, including the products and software described in it, may be reproduced, transmitted, transcribed, stored in a retrieval system, or translated into any language in any form or by any means, except documentation kept by the purchaser for backup purposes, without the express written permission of ASUSTeK COMPUTER INC. ("ASUS").

Product warranty or service will not be extended if: (1) the product is repaired, modified or altered, unless such repair, modification or alteration is authorized in writing by ASUS; or (2) the serial number of the product is defaced or missing.

ASUS PROVIDES THIS MANUAL "AS IS" WITHOUT WARRANTY OF ANY KIND, EITHER EXPRESS OR IMPLIED, INCLUDING BUT NOT LIMITED TO THE IMPLIED WARRANTIES OR CONDITIONS OF MERCHANTABILITY OR FITNESS FOR A PARTICULAR PURPOSE. IN NO EVENT SHALL ASUS, ITS DIRECTORS, OFFICERS, EMPLOYEES OR AGENTS BE LIABLE FOR ANY INDIRECT, SPECIAL, INCIDENTAL, OR CONSEQUENTIAL DAMAGES (INCLUDING DAMAGES FOR LOSS OF PROFITS, LOSS OF BUSINESS, LOSS OF USE OR DATA, INTERRUPTION OF BUSINESS AND THE LIKE), EVEN IF ASUS HAS BEEN ADVISED OF THE POSSIBILITY OF SUCH DAMAGES ARISING FROM ANY DEFECT OR ERROR IN THIS MANUAL OR PRODUCT.

SPECIFICATIONS AND INFORMATION CONTAINED IN THIS MANUAL ARE FURNISHED FOR INFORMATIONAL USE ONLY, AND ARE SUBJECT TO CHANGE AT ANY TIME WITHOUT NOTICE, AND SHOULD NOT BE CONSTRUED AS A COMMITMENT BY ASUS. ASUS ASSUMES NO RESPONSIBILITY OR LIABILITY FOR ANY ERRORS OR INACCURACIES THAT MAY APPEAR IN THIS MANUAL, INCLUDING THE PRODUCTS AND SOFTWARE DESCRIBED IN IT.

Products and corporate names appearing in this manual may or may not be registered trademarks or copyrights of their respective companies, and are used only for identification or explanation and to the owners' benefit, without intent to infringe.

# Contents

<b>Contents</b> .....	<b>iii</b>
<b>Notices</b> .....	<b>viii</b>
Federal Communications Commission Statement .....	viii
Canadian Department of Communications Statement .....	viii
REACH .....	viii
<b>Safety information</b> .....	<b>ix</b>
Electrical safety .....	ix
Operation safety .....	ix
<b>About this guide</b> .....	<b>x</b>
How this guide is organized .....	x
Where to find more information .....	x
Conventions used in this guide .....	xi
Typography .....	xi
<b>Z9PR-D12 series specifications summary</b> .....	<b>xii</b>

## **Chapter 1: Product introduction**

<b>1.1 Welcome!</b> .....	<b>1-3</b>
<b>1.2 Package contents</b> .....	<b>1-3</b>
<b>1.3 Serial number label</b> .....	<b>1-4</b>
<b>1.4 Special features</b> .....	<b>1-4</b>
1.4.1 Product highlights .....	1-4
1.4.2 Innovative ASUS features .....	1-6

## **Chapter 2: Hardware information**

<b>2.1 Before you proceed</b> .....	<b>2-3</b>
<b>2.2 Motherboard overview</b> .....	<b>2-4</b>
2.2.1 Placement direction .....	2-4
2.2.2 Screw holes .....	2-4
2.2.3 Motherboard layout .....	2-5
2.2.4 Layout contents .....	2-7
<b>2.3 Central Processing Unit (CPU)</b> .....	<b>2-9</b>
2.3.1 Installing the CPU .....	2-9
<b>2.4 System memory</b> .....	<b>2-14</b>
2.4.1 Overview .....	2-14
2.4.2 Memory Configurations .....	2-14

# Contents

<b>2.5</b>	<b>Expansion slots.....</b>	<b>2-17</b>
2.5.1	Installing an expansion card .....	2-17
2.5.2	Configuring an expansion card .....	2-17
2.5.3	Interrupt assignments .....	2-18
2.5.4	PCI Express x16 slot (x16 link) .....	2-18
2.5.5	PCI Express x8 slot (x8 link) .....	2-18
2.5.6	PIKE slots .....	2-19
2.5.7	Installing an ASUS PIKE RAID card .....	2-20
<b>2.6</b>	<b>Onboard LEDs.....</b>	<b>2-21</b>
<b>2.7</b>	<b>Jumpers.....</b>	<b>2-23</b>
<b>2.8</b>	<b>Connectors.....</b>	<b>2-27</b>
2.8.1	Rear panel connectors.....	2-27
2.8.2	Internal connectors .....	2-28
<b>Chapter 3: Powering up</b>		
<b>3.1</b>	<b>Starting up for the first time.....</b>	<b>3-3</b>
<b>3.2</b>	<b>Powering off the computer.....</b>	<b>3-4</b>
3.2.1	Using the OS shut down function.....	3-4
3.2.2	Using the dual function power switch.....	3-4
<b>Chapter 4: BIOS setup</b>		
<b>4.1</b>	<b>Managing and updating your BIOS.....</b>	<b>4-3</b>
4.1.1	ASUS CrashFree BIOS 3.....	4-3
4.1.2	ASUS EZ Flash 2.....	4-4
4.1.3	BUPDATER.....	4-5
<b>4.2</b>	<b>BIOS setup program.....</b>	<b>4-7</b>
4.2.1	BIOS menu screen.....	4-8
4.2.2	Menu bar.....	4-8
4.2.3	Menu items .....	4-9
4.2.4	Submenu items .....	4-9
4.2.5	Navigation keys.....	4-9
4.2.6	General help .....	4-9
4.2.7	Configuration fields .....	4-9
4.2.8	Pop-up window .....	4-9
4.2.9	Scroll bar.....	4-9
<b>4.3</b>	<b>Main menu.....</b>	<b>4-10</b>
4.3.1	System Date [Day xx/xx/xxxx].....	4-10



# Contents

4.3.2	System Time [xx:xx:xx] .....	4-10
<b>4.4</b>	<b>Advanced menu .....</b>	<b>4-11</b>
4.4.1	CPU Configuration .....	4-11
4.4.2	CPU Power Management Configuration .....	4-13
4.4.3	Chipset Configuration .....	4-15
4.4.4	PCH SATA Configuration .....	4-21
4.4.5	PCH SCU Configuration .....	4-22
4.4.6	PCI Subsystem Settings .....	4-23
4.4.7	Intel TXT(LT-SX) Configuration .....	4-26
4.4.8	USB Configuration .....	4-27
4.4.8	Trusted Computing.....	4-28
4.4.9	ACPI Settings.....	4-29
4.4.10	WHEA Configuration .....	4-30
4.4.11	APM setting.....	4-30
4.4.12	Serial Port Console Redirection .....	4-31
4.4.13	Onboard LAN Configuration.....	4-34
4.4.14	ME Subsystem .....	4-35
4.4.15	Legacy Devices Configuration .....	4-35
4.4.16	Runtime Error Logging.....	4-36
<b>4.5</b>	<b>Server Mgmt menu.....</b>	<b>4-37</b>
4.5.1	System Event Log .....	4-38
4.5.2	BMC network configuration.....	4-39
<b>4.6</b>	<b>Event Logs menu .....</b>	<b>4-40</b>
4.6.1	Change Smbios Event Log Settings .....	4-40
<b>4.7</b>	<b>Boot menu .....</b>	<b>4-42</b>
<b>4.8</b>	<b>Monitor menu .....</b>	<b>4-44</b>
<b>4.9</b>	<b>Security menu .....</b>	<b>4-45</b>
<b>4.10</b>	<b>Tool menu .....</b>	<b>4-46</b>
<b>4.11</b>	<b>Exit menu.....</b>	<b>4-47</b>
 <b>Chapter 5: RAID configuration</b>		
<b>5.1</b>	<b>Setting up RAID.....</b>	<b>5-3</b>
5.1.1	RAID definitions .....	5-3
5.1.2	Installing hard disk drives.....	5-4
5.1.3	Setting the RAID item in BIOS .....	5-4
5.1.4	RAID configuration utilities.....	5-4

# Contents

- 5.2 **LSI Software RAID Configuration Utility ..... 5-5**
  - 5.2.1 Creating a RAID set ..... 5-6
  - 5.2.2 Adding or viewing a RAID configuration ..... 5-12
  - 5.2.3 Initializing the virtual drives ..... 5-13
  - 5.2.4 Rebuilding failed drives..... 5-17
  - 5.2.5 Checking the drives for data consistency ..... 5-19
  - 5.2.6 Deleting a RAID configuration..... 5-22
  - 5.2.7 Selecting the boot drive from a RAID set..... 5-23
  - 5.2.8 Enabling WriteCache ..... 5-24
- 5.3 **Intel® Rapid Storage Technology enterprise SCU/SATA  
Option ROM Utility ..... 5-25**
  - 5.3.1 Creating a RAID set ..... 5-27
  - 5.3.2 Creating a Recovery set ..... 5-28
  - 5.3.3 Deleting a RAID set ..... 5-30
  - 5.3.4 Resetting disks to Non-RAID ..... 5-31
  - 5.3.5 Exiting the Intel® Rapid Storage Technology utility..... 5-32
  - 5.3.6 Rebuilding the RAID ..... 5-32
  - 5.3.7 Setting the Boot array in the BIOS Setup Utility..... 5-34
- 5.4 **Intel® Rapid Storage Technology enterprise Utility  
(Windows) ..... 5-35**
  - 5.4.1 Creating a RAID set ..... 5-36
  - 5.4.2 Changing a Volume Type ..... 5-38
  - 5.4.3 Deleting a volume ..... 5-39
  - 5.4.4 Preferences..... 5-40
- Chapter 6: Driver installation**
  - 6.1 **RAID driver installation ..... 6-3**
    - 6.1.1 Creating a RAID driver disk ..... 6-3
    - 6.1.2 Installing the RAID controller driver ..... 6-6
  - 6.2 **Intel® chipset device software installation..... 6-16**
  - 6.3 **Intel® Network Connections Software installation..... 6-19**
  - 6.4 **VGA driver installation..... 6-22**
  - 6.5 **Intel® C600 Series Chipset SCU SATA RAID Drivers..... 6-25**
  - 6.6 **Intel® Rapid Storage Technology enterprise 3.0 installation . 6-26**
  - 6.7 **Intel® WG82574L Gigabit Adapters Driver installation..... 6-29**
  - 6.8 **Management applications and utilities installation ..... 6-33**

6.8.1	Running the support DVD .....	6-33
6.8.2	Drivers menu .....	6-33
6.8.3	Utilities menu .....	6-34
6.8.4	Make disk menu .....	6-34
6.8.5	Contact information .....	6-34

**Appendix: Reference information**

<b>A.1</b>	<b>Z9PR-D12 block diagram .....</b>	<b>A-3</b>
<b>A.2</b>	<b>Z9PR-D12C block diagram .....</b>	<b>A-4</b>
	<b>ASUS contact information .....</b>	<b>1</b>

# Notices

## Federal Communications Commission Statement

This device complies with Part 15 of the FCC Rules. Operation is subject to the following two conditions:

- This device may not cause harmful interference, and
- This device must accept any interference received including interference that may cause undesired operation.

This equipment has been tested and found to comply with the limits for a Class B digital device, pursuant to Part 15 of the FCC Rules. These limits are designed to provide reasonable protection against harmful interference in a residential installation. This equipment generates, uses and can radiate radio frequency energy and, if not installed and used in accordance with manufacturer's instructions, may cause harmful interference to radio communications. However, there is no guarantee that interference will not occur in a particular installation. If this equipment does cause harmful interference to radio or television reception, which can be determined by turning the equipment off and on, the user is encouraged to try to correct the interference by one or more of the following measures:

- Reorient or relocate the receiving antenna.
- Increase the separation between the equipment and receiver.
- Connect the equipment to an outlet on a circuit different from that to which the receiver is connected.
- Consult the dealer or an experienced radio/TV technician for help.



---

The use of shielded cables for connection of the monitor to the graphics card is required to assure compliance with FCC regulations. Changes or modifications to this unit not expressly approved by the party responsible for compliance could void the user's authority to operate this equipment.

---

## Canadian Department of Communications Statement

This digital apparatus does not exceed the Class B limits for radio noise emissions from digital apparatus set out in the Radio Interference Regulations of the Canadian Department of Communications.

This class B digital apparatus complies with Canadian ICES-003.

## REACH

Complying with the REACH (Registration, Evaluation, Authorization, and Restriction of Chemicals) regulatory framework, we publish the chemical substances in our products at ASUS REACH website at <http://csr.asus.com/english/REACH.htm>.

# Safety information

## Electrical safety

- To prevent electrical shock hazard, disconnect the power cable from the electrical outlet before relocating the system.
- When adding or removing devices to or from the system, ensure that the power cables for the devices are unplugged before the signal cables are connected. If possible, disconnect all power cables from the existing system before you add a device.
- Before connecting or removing signal cables from the motherboard, ensure that all power cables are unplugged.
- Seek professional assistance before using an adapter or extension cord. These devices could interrupt the grounding circuit.
- Make sure that your power supply is set to the correct voltage in your area. If you are not sure about the voltage of the electrical outlet you are using, contact your local power company.
- If the power supply is broken, do not try to fix it by yourself. Contact a qualified service technician or your retailer.

## Operation safety

- Before installing the motherboard and adding devices on it, carefully read all the manuals that came with the package.
- Before using the product, make sure all cables are correctly connected and the power cables are not damaged. If you detect any damage, contact your dealer immediately.
- To avoid short circuits, keep paper clips, screws, and staples away from connectors, slots, sockets and circuitry.
- Avoid dust, humidity, and temperature extremes. Do not place the product in any area where it may become wet.
- Place the product on a stable surface.
- If you encounter technical problems with the product, contact a qualified service technician or your retailer.



---

**DO NOT** throw the motherboard in municipal waste. This product has been designed to enable proper reuse of parts and recycling. This symbol of the crossed out wheeled bin indicates that the product (electrical and electronic equipment) should not be placed in municipal waste. Check local regulations for disposal of electronic products.

---



---

**DO NOT** throw the mercury-containing button cell battery in municipal waste. This symbol of the crossed out wheeled bin indicates that the battery should not be placed in municipal waste.

---

# About this guide

This user guide contains the information you need when installing and configuring the motherboard.

## How this guide is organized

This user guide contains the following parts:

- **Chapter 1: Product introduction**  
This chapter describes the features of the motherboard and the new technologies it supports.
- **Chapter 2: Hardware information**  
This chapter lists the hardware setup procedures that you have to perform when installing system components. It includes description of the switches, jumpers, and connectors on the motherboard.
- **Chapter 3: Powering up**  
This chapter describes the power up sequence and ways of shutting down the system.
- **Chapter 4: BIOS setup**  
This chapter tells how to change system settings through the BIOS Setup menus. Detailed descriptions of the BIOS parameters are also provided.
- **Chapter 5: RAID configuration**  
This chapter provides instructions for setting up, creating, and configuring RAID sets using the available utilities.
- **Chapter 6: Driver installation**  
This chapter provides instructions for installing the necessary drivers for different system components.
- **Appendix: Reference information**  
This appendix includes additional information that you may refer to when configuring the motherboard.

## Where to find more information

Refer to the following sources for additional information and for product and software updates.

1. **ASUS websites**  
The ASUS website provides updated information on ASUS hardware and software products. Refer to the ASUS contact information.
2. **Optional documentation**  
Your product package may include optional documentation, such as warranty flyers, that may have been added by your dealer. These documents are not part of the standard package.

## Conventions used in this guide

To make sure that you perform certain tasks properly, take note of the following symbols used throughout this manual.



**DANGER/WARNING:** Information to prevent injury to yourself when trying to complete a task.



**CAUTION:** Information to prevent damage to the components when trying to complete a task.



**IMPORTANT:** Instructions that you **MUST** follow to complete a task.



**NOTE:** Tips and additional information to help you complete a task.

## Typography

**Bold text**

Indicates a menu or an item to select.

*Italics*

Used to emphasize a word or a phrase.

<Key>

Keys enclosed in the less-than and greater-than sign means that you must press the enclosed key.

Example: <Enter> means that you must press the Enter or Return key.

<Key1+Key2+Key3>

If you must press two or more keys simultaneously, the key names are linked with a plus sign (+).

Example: <Ctrl+Alt+Del>

**Command**

Means that you must type the command exactly as shown, then supply the required item or value enclosed in brackets.

Example: At the DOS prompt, type the command line: **format A: /S**

# Z9PR-D12 series specifications summary

Model Name		Z9PR-D12	Z9PR-D12C
Processor Support / System Bus		2 * Socket 2011 Intel® Xeon® processor E5-2600 product family QPI 6.4/ 7.2/ 8.0 GT/s	
Core Logic		Intel® C602-A PCH	
Form Factor		EEB, 12" x 13"	
ASUS Features	Fan Speed Control	V	
	Rack Ready (Rack and Pedestal dual use)	-	
	Rack Optimized (Dedicated for Rack)	V	
	ASWM Enterprise	V	
Memory	Total Slots	12 (4-channel per CPU, 8 DIMM for CPU1, 4 DIMM for CPU2)	
	Voltage	1.5V/ 1.35V	
	Capacity	Maximum up to 384GB	
	Memory Type	DDR3 800/1066/1333/1600 RDIMM/ ECC UDIMM/ Non-ECC UDIMM/ LR-DIMM	
	Memory Size	1GB, 2GB, 4GB, 8GB, 16GB, 32GB* (RDIMM) 1GB, 2GB, 4GB, 8GB* (UDIMM) 8GB, 16GB, 32GB* (LRDIMM)	
Expansion Slots	Total PCI/PCI-X/ PCI-E Slots	7	
	Slot Location 1	1 * PCI-E x8 (X8 Gen3 Link)	
	Slot Location 2	1 * PCI-E x8 (X8 Gen3 Link)	
	Slot Location 3	1 * PCI-E x8 (X8 Gen3 Link)	
	Slot Location 4	1 * PCI-E x8 (X8 Gen3 Link)	
	Slot Location 5	1 * PCI-E x8 (X8 Gen3 Link)	
	Slot Location 6	1 * PCI-E x16 (X16 Gen3 Link) (Auto switch to x8 Link if slot 5 is occupied )	
	Slot Location 7	1 * PCI-E x8 (X8 Gen3 Link)	
Additional Slot 1	1* PIKE Slot for Storage expansion		

(continued on the next page)



# Z9PR-D12 series specifications summary

Model Name	Z9PR-D12		Z9PR-D12C
Storage	SATA Controller	<b>Intel® C602-A:</b> <AHC> 4 SATA 3Gb/s ports; 2 SATA 6Gb/s ports Intel® RSTe (for Windows only) (Support software RAID 0, 1, 10 & 5) LSI® MegaRAID (for Linux/Windows) (Support software RAID 0, 1, 10)  <SCU> 4 SATA 3Gb/s ports Intel® RSTe (for Windows only) (Support software RAID 0, 1, 10 & 5 for all SATA ports)	
	SAS Controller	Optional kits: ASUS PIKE 2008 8-port SAS 6G RAID card ASUS PIKE 2008/IMR 8-port SAS 6G RAID card ASUS PIKE 2108 8-port SAS 6G HW RAID card	
Networking	LAN	2 * Intel 82574L 1 * Mgmt Port	2 * Intel 82574L
Graphic	VGA	ASPEED® AST2300 16MB	ASPEED® AST1300 64MB
Onboard I/O Connectors	TPM Header	1	
	PSU Connector	24-pin SSI power connector + 8-pin SSI 12V + 8-pin SSI 12V power connector	
	Management Connector	Onboard ASMB6	-
	USB Connectors	1 * USB connector (Type A USB socket) 2 * USB pin header (up to 4 devices)	
	Fan Header	8 * 4pin	
	SMBus	1	
	Chassis Intruder	1	
	Front LAN LED	2	
	Serial Port Header	2	
Rear I/O Connectors	External USB Port	2	
	VGA Port	1	
	RJ-45	2 * GbE LAN 1 * Mgmt LAN	2 * GbE LAN
	PS/2 KB/Mouse	1/1	
Management Solution	Software	ASWM Enterprise	
	Out of Band Remote Management	ASMB6-iKVM for KVM-over-Internet	-
Monitoring	CPU Temperature	V	
	FAN RPM	V	
Environment	Operation temperature: 10°C – 35°C Non operation temperature: -40°C – 70°C Non operation humidity: 20% – 90% (Non condensing)		

\*Refer to ASUS Server AVL for latest update. \*\*Specifications are subject to change without notice.



This chapter describes the motherboard features and the new technologies it supports.

# 1 Product introduction

## Chapter summary

# 1

1.1	Welcome! .....	1-3
1.2	Package contents.....	1-3
1.3	Serial number label .....	1-4
1.4	Special features.....	1-4

## 1.1 Welcome!

Thank you for buying an ASUS® Z9PR-D12 series motherboard!

The motherboard delivers a host of new features and latest technologies, making it another standout in the long line of ASUS quality motherboards!

Before you start installing the motherboard, and hardware devices on it, check the items in your package with the list below.

## 1.2 Package contents

Check your motherboard package for the following items.

### Z9PR-D12 series

		Standard Gift Box Pack	Standard Bulk Pack
I/O Shield		1	1
Cables	SATA DOM cable	1	--
	SATA cable	10	--
Support CD		1	1
Application CD	ASWM Enterprise SDVD	1	1
	ASMB6-iKVM SDVD	1 (Z9PR-D12 only)	1
Documentation	Motherboard User Guide	1	1
	ASMB6-iKVM User Guide	1 (Z9PR-D12 only)	1
Packing Qty.		1pc per carton	10pcs per carton



---

If any of the above items is damaged or missing, contact your retailer.

---

Optional items	Description
PIKE 2108	LSI 8-port SAS2 6G RAID card
PIKE 2008/IMR	LSI 8-port SAS2 6G RAID card
PIKE 2008	LSI 8-port SAS2 6G RAID card

## 1.3 Serial number label

For faster and quicker troubleshooting solutions from the ASUS Technical Support team, provide the product's serial number containing 12 characters such as **xxS2xxxxxxxx** as shown in the figure below.



## 1.4 Special features

### 1.4.1 Product highlights

#### Latest Processor Technology

The motherboard supports Intel Xeon® processor E5-2600 product family in LGA 2011 package with integrated memory controller to support 4 channel DDR3 memory (8 DIMM for CPU1, 4 DIMM for CPU2). Intel Xeon® processor E5-2600 product family supports Intel QuickPath Interconnect (QPI) with a system bus of up to 8.0GT/s.

#### Optimized Intel® Turbo Boost Technology

Optimized Intel® Turbo Boost Technology further optimizes the processor's performance and automatically allows it to run faster than the marked frequency if it is operating below power, temperature, and current limits.

#### Intel® Hyper Threading

The thread-level parallelism on each processor makes more efficient use of the processor resources, higher processing throughput, and improved performance on today's multi-threaded software.

#### Intel® EM64T

The motherboard supports Intel® processors with the Intel® EM64T (Extended Memory 64 Technology), feature which allows your computer to run on 64-bit operating systems and access larger amounts of system memory for faster and more efficient computing.

## **DDR3 memory support**

The motherboard supports the 4-channel DDR3 memory that features data transfer rates of DDR3 1600 / 1333 / 1066 MHz to boost the system's performance, and to meet the higher bandwidth requirements of server and workstation applications. The 4-channel DDR3 architecture also manages traffic with bandwidth of up to 52GB/s, and reduces voltage thus reducing power usage and heat generation.

## **PCI Express® 3.0**

PCI Express® 3.0 (PCIe 3.0) is the PCI Express bus standard that provides twice the performance and speed of PCIe 2.0. It provides an optimal graphics performance, unprecedented data speed, and seamless transition with its complete backward compatibility to PCIe 1.0/2.0 devices.

## **Intel® 82574L Gigabit LAN Solution**

This motherboard features the built-in dual server class Intel® Gigabit LAN ports, which helps reduce CPU usage, thus increasing throughput to achieve highly-reliable network connections, outstanding performance, and better support for diverse operating systems.

Intel® 82574L chipset is VMware-certified to support the virtualization technology.

## **Enhanced Intel SpeedStep Technology (EIST)**

The Enhanced Intel SpeedStep Technology (EIST) intelligently manages the CPU resources by automatically adjusting the CPU voltage and core frequency depending on the CPU loading and system speed or power requirement.

## **Serial ATA II technology**

The motherboard supports the Serial ATA II 3 Gb/s technology through the Serial ATA interface and Intel® C602 chipset. The Serial ATA II specification provides twice the bandwidth of the current Serial ATA products with a host of new features, including Native Command Queuing (NCQ), Power Management (PM) Implementation Algorithm, and Hot Swap. Serial ATA allows thinner, more flexible cables with lower pin count and reduced voltage requirements.

## **Serial ATA III technology**

The motherboard supports the Serial ATA III technology through the Serial ATA interface and Intel® C602 chipset, delivering up to 6Gb/s data transfer rates. Additionally, get enhanced scalability, faster data retrieval, double the bandwidth of current bus systems.

## **USB 2.0 technology**

The motherboard provides USB 2.0 accessibility, allowing you to experience the dramatic increase in connection speed from 12Mbps bandwidth on USB 1.1 to a fast 480 Mbps on USB 2.0. USB 2.0 is backward compatible with USB 1.1.

## **Temperature, fan, and voltage monitoring**

The CPU temperature is monitored to prevent overheating and damage. The system fan rotations per minute (RPM) is monitored for timely failure detection. The chip monitors the voltage levels to ensure stable supply of current for critical components.

### **1.4.2 Innovative ASUS features**

#### **ASUS Fan Speed control technology**

The ASUS Fan Speed control technology smartly adjusts the fan speeds according to the system loading to ensure quiet, cool, and efficient operation.

#### **PIKE (Proprietary I/O Kit Expansion)**

PIKE is an on-demand upgrade kit for users. This ASUS unique feature enables users to choose their preferred I/O solutions. ASUS provides multiple SAS solutions for different segments and purposes and PIKE saves lots of validation efforts and hardware cost for end users. Moreover, the special patent design offers multiple I/O solutions without occupying the PCI slot in 1U system.



This chapter lists the hardware setup procedures that you have to perform when installing system components. It includes description of the jumpers and connectors on the motherboard.

# Hardware <sup>2</sup> information

2.1	Before you proceed .....	2-3
2.2	Motherboard overview .....	2-4
2.3	Central Processing Unit (CPU) .....	2-9
2.4	System memory .....	2-14
2.5	Expansion slots.....	2-17
2.6	Onboard LEDs .....	2-21
2.7	Jumpers .....	2-23
2.8	Connectors .....	2-27

## 2.1 Before you proceed

Take note of the following precautions before you install motherboard components or change any motherboard settings.



- Unplug the power cord from the wall socket before touching any component.
- Use a grounded wrist strap or touch a safely grounded object or a metal object, such as the power supply case, before handling components to avoid damaging them due to static electricity.
- Hold components by the edges to avoid touching the ICs on them.
- Whenever you uninstall any component, place it on a grounded antistatic pad or in the bag that came with the component.
- Before you install or remove any component, ensure that the power supply is switched off or the power cord is detached from the power supply. Failure to do so may cause severe damage to the motherboard, peripherals, and/or components.

### Standby Power LED (SB\_PWR1)

The motherboard comes with a standby power LED. The green LED lights up to indicate that the system AC power cable is plugged or not plugged. This is a reminder that you should shut down the system and unplug the power cable before removing or installing any motherboard component.

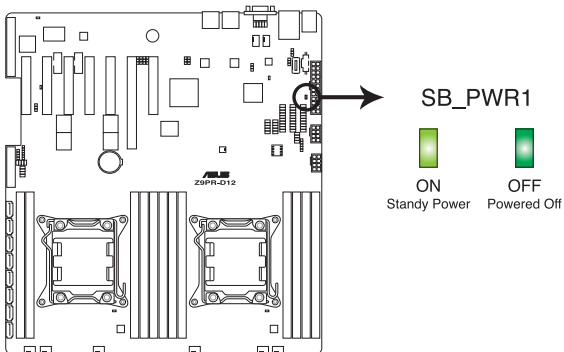

**Z9PR-D12 Series Onboard LED**

## 2.2 Motherboard overview

Before you install the motherboard, study the configuration of your chassis to ensure that the motherboard fits into it.

To optimize the motherboard features, we highly recommend that you install it in an ATX 2.2 compliant chassis.



Unplug the chassis power cord before installing or removing the motherboard. Failure to do so can cause you physical injury and damage motherboard components!

### 2.2.1 Placement direction

When installing the motherboard, ensure that you place it into the chassis in the correct orientation. The edge with external ports goes to the rear part of the chassis as indicated in the image below.

### 2.2.2 Screw holes

Place nine (9) screws into the holes indicated by circles to secure the motherboard to the chassis.



DO NOT overtighten the screws! Doing so can damage the motherboard.

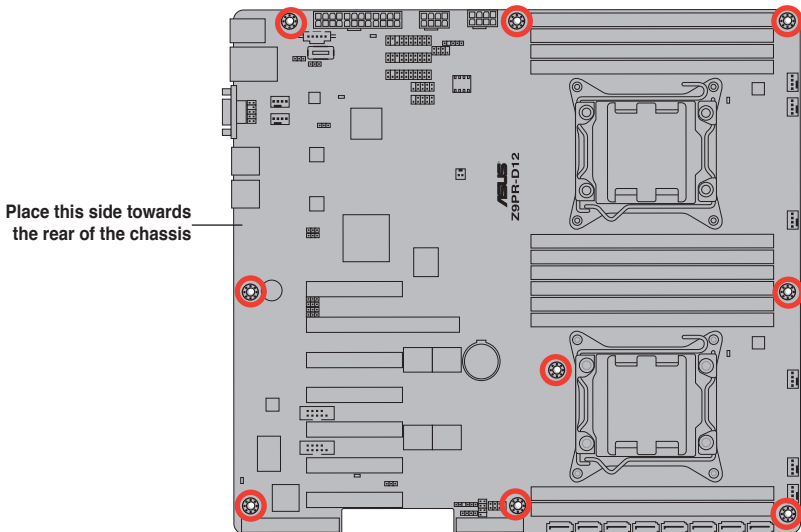

## 2.2.3 Motherboard layout

### Z9PR-D12

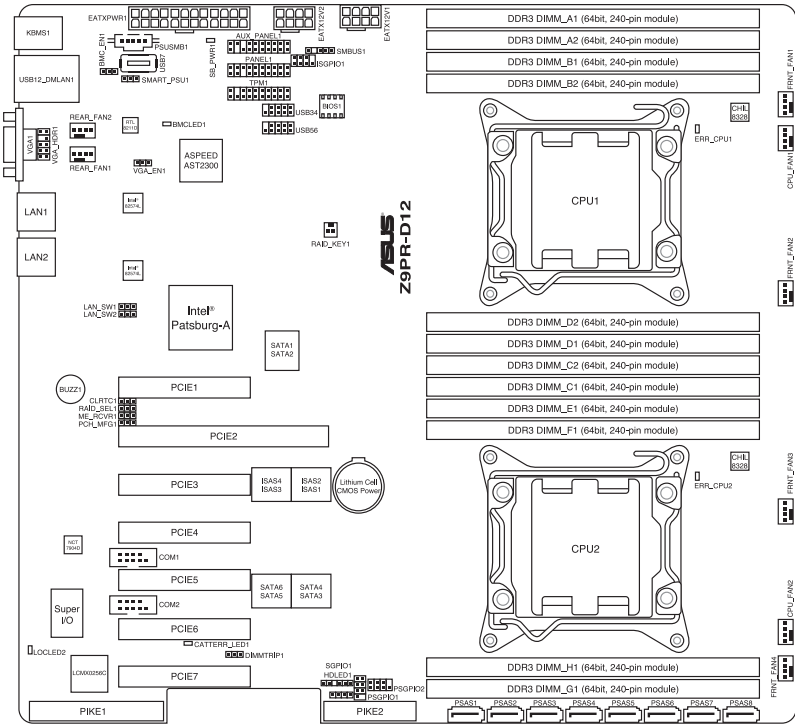

# Z9PR-D12C

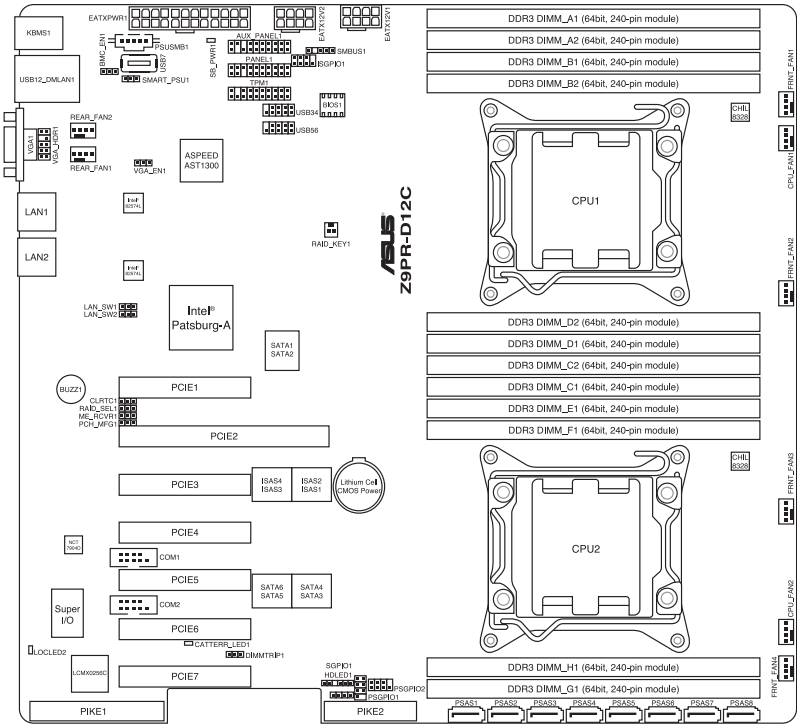

## 2.2.4 Layout contents

Slots/Socket	Page
1. CPU sockets	2-9
2. DDR3 sockets	2-14
3. PCI Express x8 / PCI Express x16 slots	2-17

Onboard LEDs	Page
1. Baseboard Management Controller LED (BMC_LED1)	2-21
2. CPU Warning LED (ERR_CPU1/2)	2-21
3. CATT Error LED (CATTERR_LED1)	2-22
4. Location LED (3-pin LOCLD2)	2-22

Jumpers	Page
1. Clear RTC RAM (CLRTC1)	2-23
2. VGA controller setting (3-pin VGA_EN1)	2-24
3. LAN controller setting (3-pin LAN_SW1, LAN_SW2)	2-24
4. LSI MegaRAID or Intel RSTe selection jumper (3-pin RAID_SEL1)	2-25
5. ME firmware force recovery setting (3-pin ME_RCVR1)	2-25
6. DDR3 thermal event setting (3-pin DIMMTRIP1)	2-26
7. PMBus 1.2 PSU select jumper (3-pin SMART_PSU1)	2-26

Rear panel connectors	Page
1. PS/2 mouse port (green)	2-27
2. DM_LAN 1 (RJ-45) port	2-27
3. PS/2 keyboard port (purple)	2-27
4. USB 2.0 ports 1 and 2	2-27
5. Video Graphics Adapter port	2-27
6. LAN 1 (RJ-45) port	2-27
7. LAN 2 (RJ-45) port	2-27

Internal connectors		Page
1.	Serial ATA 6.0/3.0 Gb/s connectors (7-pin SATA6G 1–2 [Blue]; 7-pin SATA3G 3–6 [Black])	2-28
2.	SAS connectors-ISAS connectors (7-pin ISAS1–4 [Gray])	2-29
3.	SAS connectors- PSAS connectors (7-pin PSAS1–8 [Light Blue])	2-29
4.	Hard disk activity LED connector (4-pin HDLED1)	2-30
5.	USB connectors (10-1 pin USB34, USB56; A-Type USB7)	2-30
6.	VGA connector (10-1 pin VGA_HDR1)	2-31
7.	CPU, front and rear fan connectors (4-pin CPU_FAN1-2, FRNT_FAN1–4, REAR_FAN1-2)	2-31
8.	Serial General Purpose Input/Output connectors (8-1 pin PSGPIO 1/2, ISGPIO1, SGPIO1)	2-32
9.	Serial port connectors (10-1 pin COM1/COM2)	2-33
10.	TPM connector (20-1-pin TPM1)	2-33
11.	EATX power connectors (24-pin EATXPWR1, 8-pin EATX12V1/EATX12V2)	2-34
12.	Power Supply SMBus (PSUSMB1)	2-35
13.	System panel connector (20-1 pin PANEL1)	2-36
14.	Auxiliary panel connector (20-2 pin AUX_PANEL1)	2-37



## 2.3 Central Processing Unit (CPU)

The motherboard comes with a surface mount LGA2011 socket designed for the Intel® Xeon E5-2600 processors.



- Upon purchase of the motherboard, ensure that the PnP cap is on the socket and the socket contacts are not bent. Contact your retailer immediately if the PnP cap is missing, or if you see any damage to the PnP cap/socket contacts/motherboard components. ASUS will shoulder the cost of repair only if the damage is shipment/transit-related.
- Keep the cap after installing the motherboard. ASUS will process Return Merchandise Authorization (RMA) requests only if the motherboard comes with the cap on the LGA2011 socket.
- The product warranty does not cover damage to the socket contacts resulting from incorrect CPU installation/removal, or misplacement/loss/incorrect removal of the PnP cap.

### 2.3.1 Installing the CPU

To install a CPU:

1. Locate the CPU socket on the motherboard.

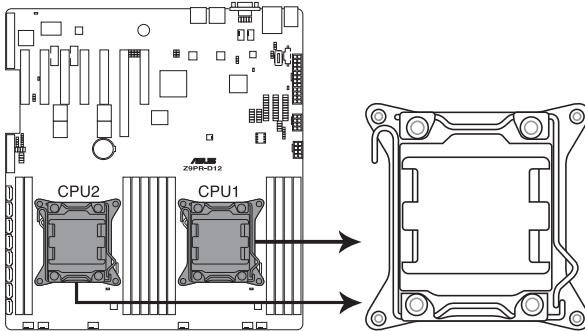

**Z9PR-D12 Series CPU LGA2011**

2. Press the left load lever with your thumb (A), then move it to the left (B) until it is released from the retention tab.



To prevent damage to the socket pins, do not remove the PnP cap unless you are installing a CPU.

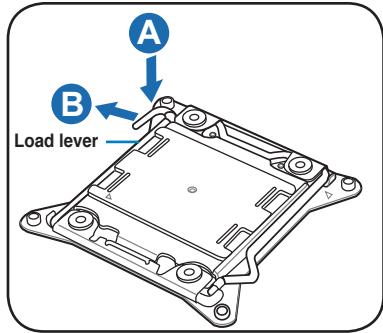

3. Slightly lift the load lever in the direction of the arrow.

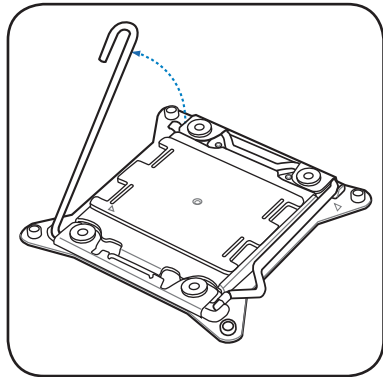

4. Press the right load lever with your thumb (C), then move it to the right (D) until it is released from the retention tab. Lift the load lever in the direction of the arrow (E).

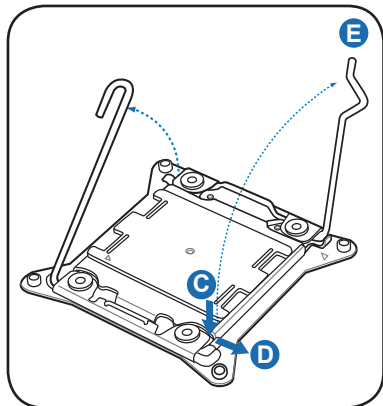

5. Push the left load lever (F) to lift the load plate (G).

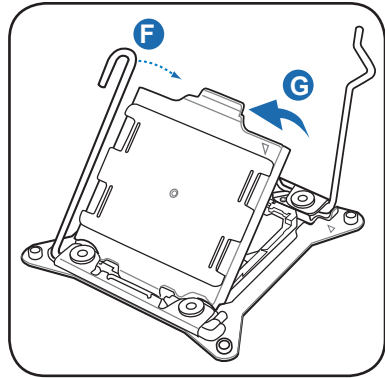

6. Position the CPU over the socket, ensuring that the triangle mark is on the top-right corner of the socket.

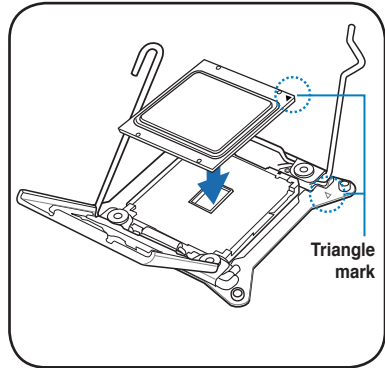

The CPU fits in only one correct orientation. **DO NOT** force the CPU into the socket to prevent bending the connectors on the socket and damaging the CPU!

7. Remove the PnP cap (H) from the CPU socket and close the load plate (I).

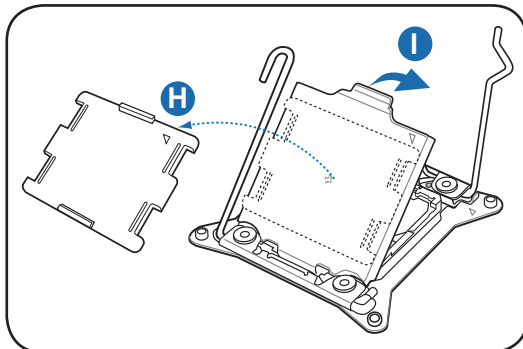

8. Push down the right load lever (J), ensuring that the edge of the load plate is fixed by the lever (K).

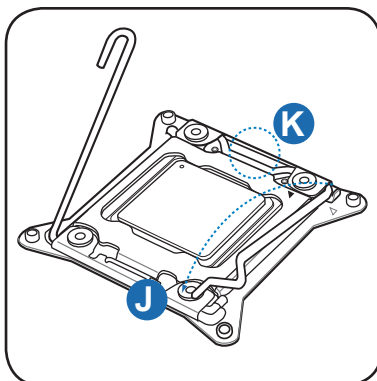

9. Insert the right load lever under the retention tab.

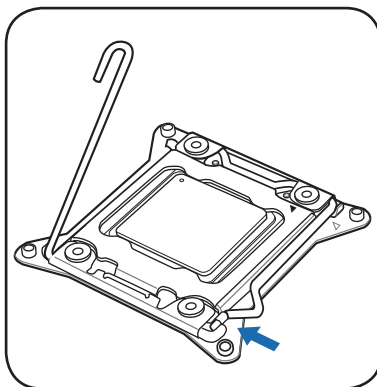

10. Push down the left load lever (L), and then insert the lever under the retention tab (M).

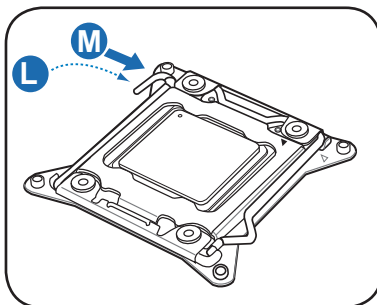

11. Apply some Thermal Interface Material to the exposed area of the CPU that the heatsink will be in contact with, ensuring that it is spread in an even thin layer.



Some heatsinks come with pre-applied thermal paste. If so, skip this step.

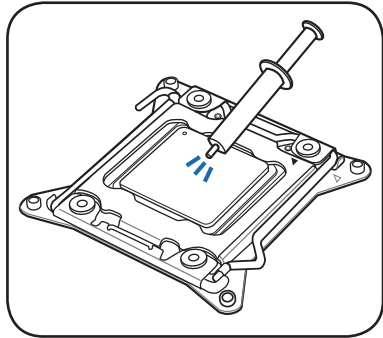

The Thermal Interface Material is toxic and inedible. DO NOT eat it. If it gets into your eyes or touches your skin, wash it off immediately, and seek professional medical help.

12. Connect the CPU fan cable to the connector on the motherboard labeled CPU\_FAN1 / CPU\_FAN2.

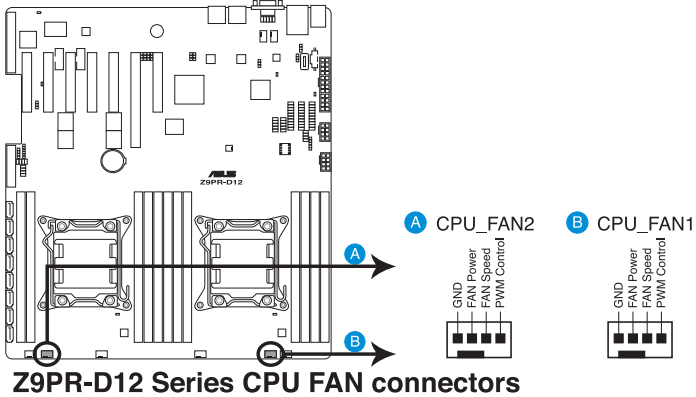

DO NOT forget to connect the CPU fan connector! Hardware monitoring errors can occur if you fail to plug this connector.

## 2.4 System memory

### 2.4.1 Overview

The motherboard comes with eight (for CPU1) and four (for CPU2) Double Data Rate 3 (DDR3) Dual Inline Memory Modules (DIMM) sockets.

A DDR3 module has the same physical dimensions as a DDR2 DIMM but is notched differently to prevent installation on a DDR2 DIMM socket. DDR3 modules are developed for better performance with less power consumption.

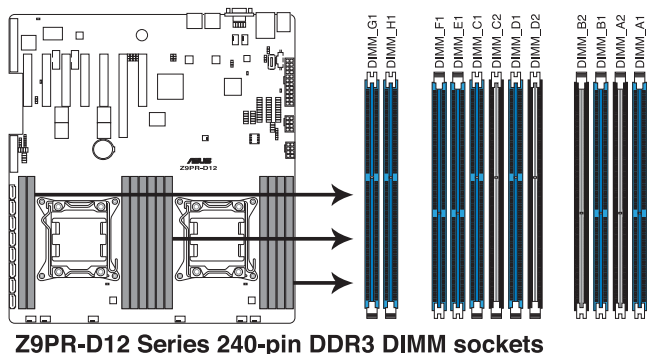

### 2.4.2 Memory Configurations

You may install 1GB, 2GB, 4GB, 8GB, 16GB and 32GB\* RDIMMs or 1GB, 2GB, 4GB and 8GB\* UDIMMs or 8GB, 16GB and 32GB\* LR-DIMMs into the DIMM sockets using the memory configurations in this section.

1 CPU Configuration (must on CPU1)								
	A1	A2	B1	B2	C1	C2	D1	D2
1 DIMMs	•							
2 DIMMs	•				•			
3 DIMMs			•		•			
4 DIMMs	•		•		•		•	
5 DIMMs	•	•	•		•		•	
6 DIMMs	•	•	•		•	•	•	
7 DIMMs	•	•	•	•	•	•	•	
8 DIMMs	•	•	•	•	•	•	•	•



- \*Refer to ASUS Server AVL for the latest update.
- Start installing the DIMMs from slot A1 and C1 (light blue).
- Always install DIMMs with the same CAS latency. For optimum compatibility, it is recommended that you obtain memory modules from the same vendor.

2 CPU Configuration												
	A1	A2	B1	B2	C1	C2	D1	D2	E1	F1	G1	H1
1 DIMMs	•											
2 DIMMs	•								•			
3 DIMMs	•				•				•			
4 DIMMs	•				•				•		•	
5 DIMMs	•		•		•				•		•	
6 DIMMs	•		•		•				•	•	•	
7 DIMMs	•		•		•		•		•	•	•	
8 DIMMs	•		•		•		•		•	•	•	•
9 DIMMs	•	•	•		•		•		•	•	•	•
10 DIMMs	•	•	•		•	•	•		•	•	•	•
11 DIMMs	•	•	•	•	•	•	•		•	•	•	•
12 DIMMs	•	•	•	•	•	•	•	•	•	•	•	•

## 2.4.3 Installing a DIMM on a single clip DIMM socket

1. Press the retaining clip outward to unlock a DIMM socket.
2. Align a DIMM on the socket such that the notch on the DIMM matches the DIMM slot key on the socket.

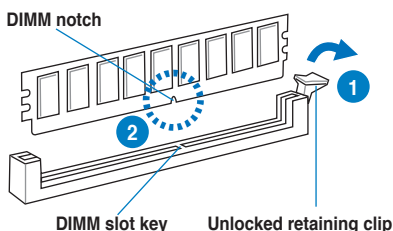

A DIMM is keyed with a notch so that it fits in only one direction. **DO NOT** force a DIMM into a socket in the wrong direction to avoid damaging the DIMM.

3. Hold the DIMM on both ends, then insert the DIMM vertically into the socket. Apply force to both ends of the DIMM simultaneously until the retaining clip snaps back into place, and the DIMM cannot be pushed in any further to ensure proper sitting of the DIMM.

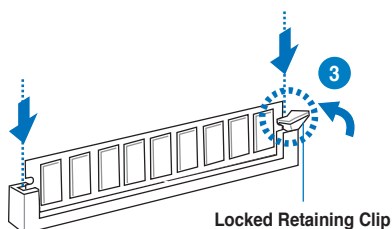

Always insert the DIMM into the socket **VERTICALLY** to prevent damage to the DIMM notch.



- To install two or more DIMMs, refer to the user guide bundled in the motherboard package.
- Refer to the user guide for qualified vendor lists of the memory modules.

## Removing a DIMM from a single clip DIMM socket

1. Press the retaining clip outward to unlock the DIMM.
2. Remove the DIMM from the socket.

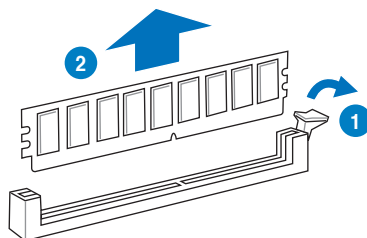

Support the DIMM lightly with your fingers when pressing the retaining clips. The DIMM might get damaged when it flips out with extra force.



## 2.5 Expansion slots



---

Unplug the power cord before adding or removing expansion cards. Failure to do so may cause you physical injury and damage motherboard components.

---

### 2.5.1 Installing an expansion card

To install an expansion card:

1. Before installing the expansion card, read the documentation that came with it and make the necessary hardware settings for the card.
2. Remove the system unit cover (if your motherboard is already installed in a chassis).
3. Remove the bracket opposite the slot that you intend to use. Keep the screw for later use.
4. Align the card connector with the slot and press firmly until the card is completely seated on the slot.
5. Secure the card to the chassis with the screw you removed earlier.
6. Replace the system cover.

### 2.5.2 Configuring an expansion card

After installing the expansion card, configure it by adjusting the software settings.

1. Turn on the system and change the necessary BIOS settings, if any. See Chapter 4 for information on BIOS setup.
2. Assign an IRQ to the card. Refer to the tables on the next page.
3. Install the software drivers for the expansion card.



---

When using PCI cards on shared slots, ensure that the drivers support “Share IRQ” or that the cards do not need IRQ assignments. Otherwise, conflicts will arise between the two PCI groups, resulting in an unstable system and an inoperable card.

---

## 2.5.3 Interrupt assignments

### Standard Interrupt assignments

IRQ	Priority	Standard function
0	1	System Timer
1	2	Keyboard Controller
2	-	Programmable Interrupt
3*	11	Communications Port (COM2)
4*	12	Communications Port (COM1)
5*	13	--
6	14	Floppy Disk Controller
7*	15	--
8	3	System CMOS/Real Time Clock
9*	4	ACPI Mode when used
10*	5	IRQ Holder for PCI Steering
11*	6	IRQ Holder for PCI Steering
12*	7	PS/2 Compatible Mouse Port
13	8	Numeric Data Processor
14*	9	Primary IDE Channel
15*	10	Secondary IDE Channel

\* These IRQs are usually available for ISA or PCI devices.

## 2.5.4 PCI Express x16 slot (x16 link)

The onboard PCIE2 slot provides one x16 Gen3 link to CPU1 and auto switches to x8 link if PCIE3 is occupied. This slot supports VGA cards and various server class high performance add-on cards.

## 2.5.5 PCI Express x8 slot (x8 link)

The onboard PCIE 1, 3, and 4 slots provide one x8 Gen3 link to CPU1. The onboard PCIE 5, 6, and 7 slots provide one x8 Gen3 link to CPU2. These slots support VGA Cards and various server class high performance add-on cards.

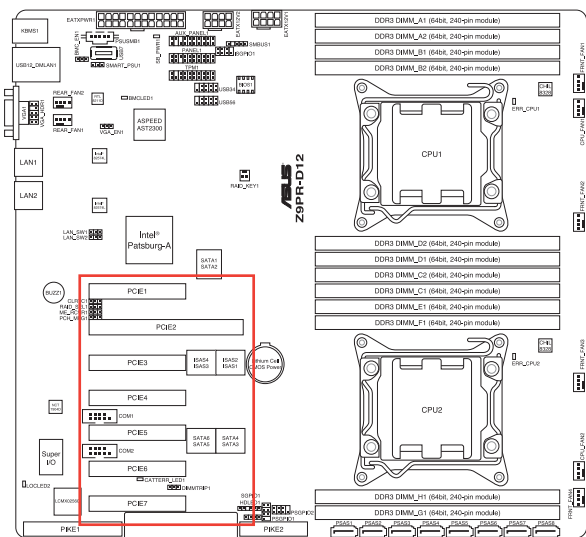

PCI-E 1	1 x PCI-E x 8 (Gen3 x8 link)
PCI-E 2	1 x PCI-E x 16 (Gen3 x16 link) (Auto switch to x8 Link if PCI-E3 is occupied)
PCI-E 3	1 x PCI-E x 8 (Gen3 x8 link)
PCI-E 4	1 x PCI-E x 8 (Gen3 x8 link)
PCI-E 5	1 x PCI-E x 8 (Gen3 x8 link)
PCI-E 6	1 x PCI-E x 8 (Gen3 x8 link)
PCI-E 7	1 x PCI-E x 8 (Gen3 x8 link)

## 2.5.6 PIKE slots

The PIKE slot allows you to choose and change your preferred SAS solution easily. Install an optional ASUS PIKE RAID card based on your needs.

## 2.5.7 Installing an ASUS PIKE RAID card

Follow the steps below to install an optional ASUS PIKE RAID card on your motherboard.

1. Locate the PIKE RAID card slot on the motherboard.

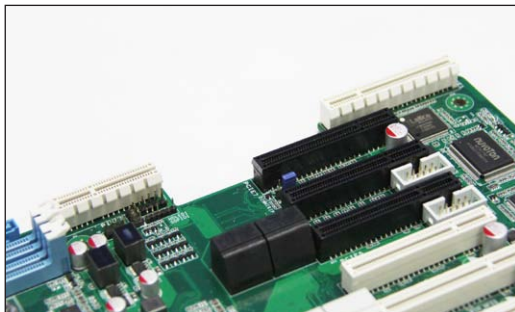

2. Align the golden fingers of the PIKE RAID card with the PIKE RAID card slot.

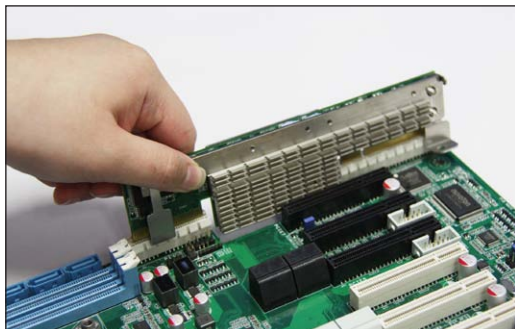

3. Insert the PIKE RAID card into the PIKE RAID card slot. Ensure that it is completely seated on the PIKE RAID card slot.

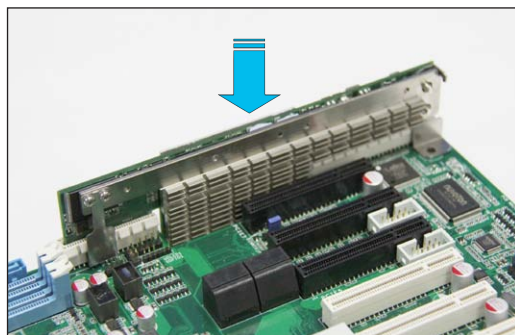

## 2.6 Onboard LEDs

### 1. Baseboard Management Controller LED (BMC\_LED1) (Z9PR-D12 only)

The BMC LED works with the ASUS ASMB6 management device and indicates its initiation status. When the PSU is plugged and the system is OFF, ASUS ASMB6 management device starts system initiation for about one (1) minute. The BMC LED blinks after system initiation finishes.

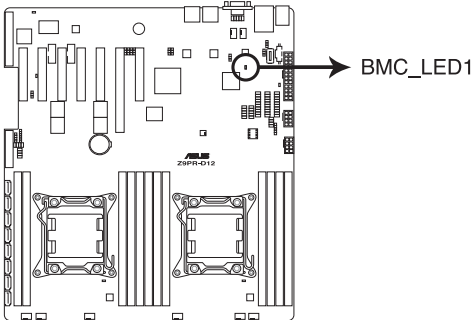

**Z9PR-D12 Series BMC LED**

### 2. CPU warning LED (ERR\_CPU1/2) (Z9PR-D12 only)

The CPU warning LEDs light up to indicate an impending failure of the corresponding CPU.

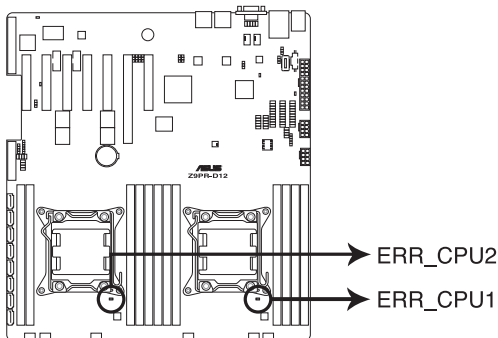

**Z9PR-D12 Series ERR CPU LED**

**3. CATT Error LED (CATTERR\_LED1)**

Indicates that the system has experienced a fatal or catastrophic error and cannot continue to operate.

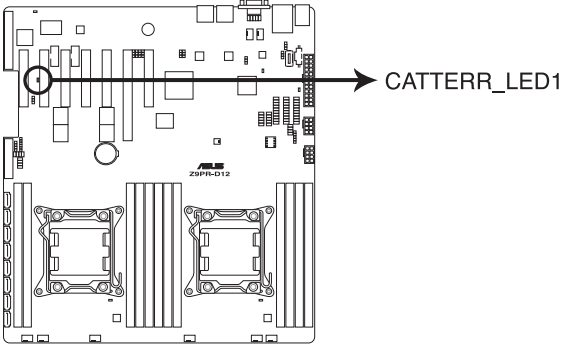

**Z9PR-D12 Series CATTERR LED**

**4. Location LED (LOCLED2)**

This LED allows you to know the server location.

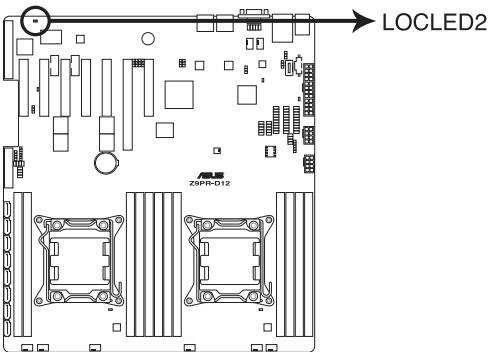

**Z9PR-D12 Series LOCLED**

## 2.7 Jumpers

### 1. Clear RTC RAM (CLRRTC1)

This jumper allows you to clear the Real Time Clock (RTC) RAM in CMOS. You can clear the CMOS memory of date, time, and system setup parameters by erasing the CMOS RTC RAM data. The onboard button cell battery powers the RAM data in CMOS, which include system setup information such as system passwords.

To erase the RTC RAM:

1. Turn OFF the computer and unplug the power cord.
2. Move the jumper cap from pins 1–2 (default) to pins 2–3. Keep the cap on pins 2–3 for about 5–10 seconds, then move the cap back to pins 1–2.
3. Plug the power cord and turn ON the computer.
4. Hold down the <Del> key during the boot process and enter BIOS setup to re-enter data.



---

Except when clearing the RTC RAM, never remove the cap on CLRRTC jumper default position. Removing the cap will cause system boot failure!

---



---

If the steps above do not help, remove the onboard battery and move the jumper again to clear the CMOS RTC RAM data. After the CMOS clearance, reinstall the battery.

---

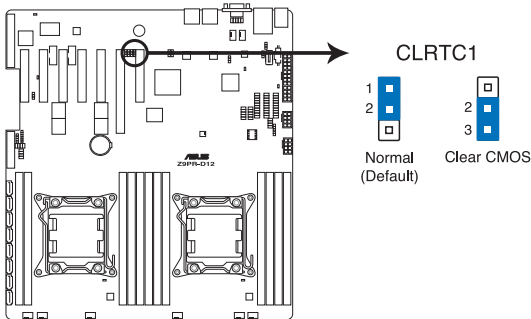

**Z9PR-D12 Series Clear RTC RAM**

## 2. VGA controller setting (3-pin VGA\_EN1)

This jumper allows you to enable or disable the onboard VGA controller. Set to pins 1–2 to activate the VGA feature.

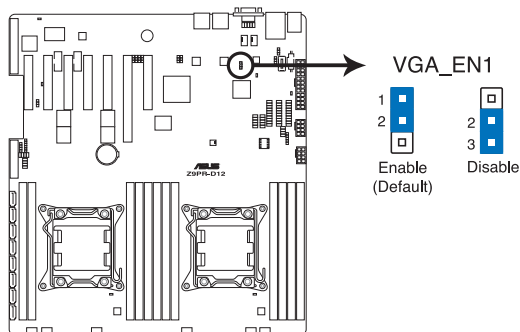

**Z9PR-D12 Series VGA setting**

## 3. LAN controller setting (3-pin LAN\_SW1/ LAN\_SW2)

These jumpers allow you to enable or disable the onboard Intel® 82574L Gigabit LAN controllers. Set to pins 1-2 to activate the Gigabit LAN feature.

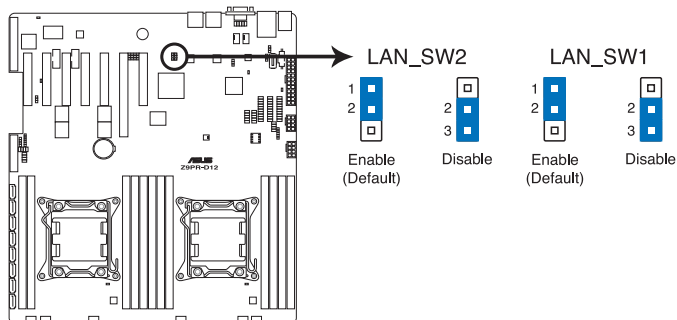

**Z9PR-D12 Series LAN setting**



#### 4. LSI MegaRAID or Intel RSTe selection jumper (3-pin RAID\_SEL1)

This jumper allows you to select the PCH SATA RAID mode to use LSI MegaRAID software or Intel® Rapid Storage Technology enterprise 3.0 RAID. Place the jumper caps over pins 1–2 if you want to use the LSI MegaRAID software RAID Utility (default). Otherwise, place the jumper caps to pins 2–3 to use the Intel® Rapid Storage Technology Enterprise Option ROM Utility.

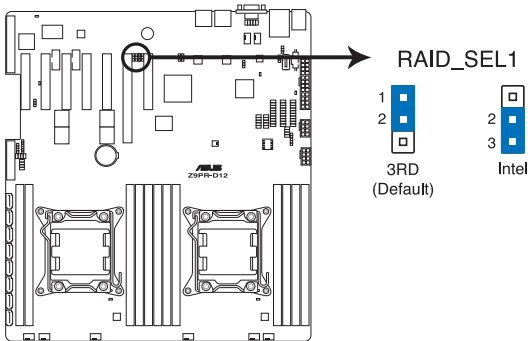

**Z9PR-D12 Series RAID setting**

#### 5. ME firmware force recovery setting (3-pin ME\_RCVR1)

This jumper allows you to force Intel Management Engine (ME) boot from recovery mode when ME become corrupted.

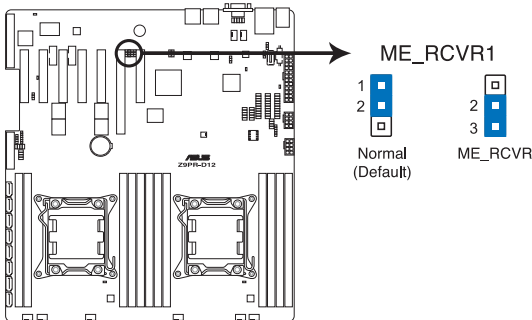

**Z9PR-D12 Series ME\_RCVR setting**

**6. DDR3 thermal event setting (3-pin DIMMTRIP1)**

This jumper allows you to enable/disable DDR3 DIMM thermal sensing event pin.

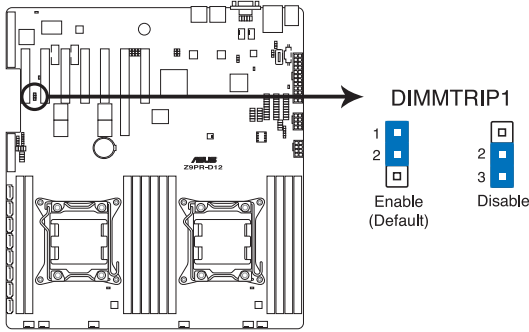

**Z9PR-D12 Series DIMM Thermaltrip setting**

**7. PMBus 1.2 PSU select jumper (3-pin SMART\_PSU1)**

This jumper allows you to select PSU PMBus version, Set to pins 1-2 for PMBus, set to pins 2-3 for Others.

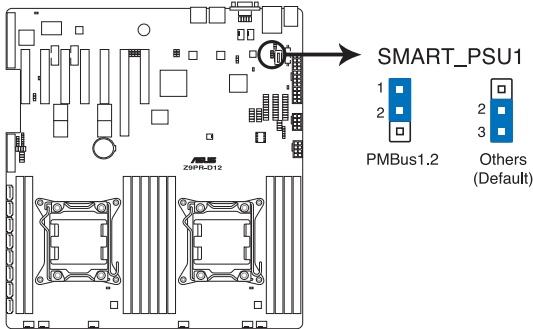

**Z9PR-D12 Series PMBus 1.2 PSU setting**

## 2.8 Connectors

### 2.8.1 Rear panel connectors

#### Z9PR-D12

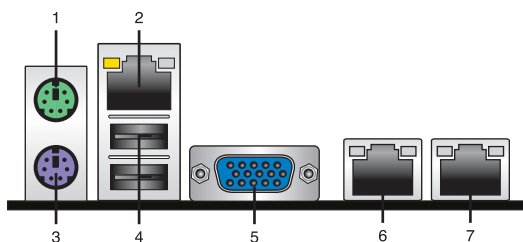

#### Z9PR-D12C

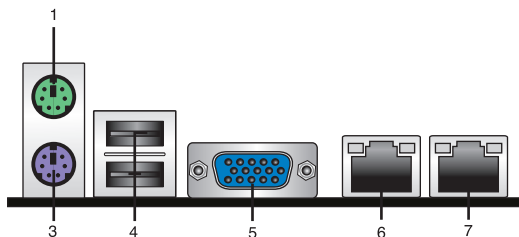

1. **PS/2 mouse port (green).** This port is for a PS/2 mouse.
2. **DM\_LAN 1 (RJ-45) port.** This port allows Gigabit connection to a Local Area Network (LAN) through a network hub for dedicated BMC Management function. Refer to the table on the next page for the DM\_LAN1 and LAN port LED indications.
3. **PS/2 keyboard port (purple).** This port is for a PS/2 keyboard.
4. **USB 2.0 ports 1 and 2.** These two 4-pin Universal Serial Bus (USB) ports are available for connecting USB 2.0 devices.
5. **Video Graphics Adapter (VGA) port.** This port is for a VGA monitor or other VGA-compatible devices.
6. **LAN 1 (RJ-45) port.** This port allows Gigabit connection to a Local Area Network (LAN) through a network hub. Refer to the table below for the LAN port LED indications.
7. **LAN 2 (RJ-45) port.** This port allows Gigabit connection to a Local Area Network (LAN) through a network hub. Refer to the table below for the LAN port LED indications.

## DM\_LAN1 port LED indications

Activity/Link LED		Speed LED	
Status	Description	Status	Description
OFF	No link	OFF	10 Mbps connection
Orange	Linked	Orange	100 Mbps connection
Blinking	Data activity	Green	1 Gbps connection

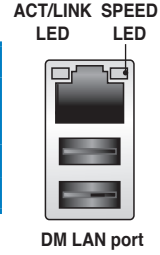

## LAN port LED indications

Activity/Link LED		Speed LED	
Status	Description	Status	Description
OFF	No link	OFF	10 Mbps connection
Green	Linked	Orange	100 Mbps connection
Blinking	Data activity	Green	1 Gbps connection

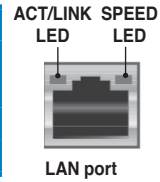

## 2.8.2 Internal connectors

### 1. Serial ATA 6.0/3.0 Gb/s connectors (7-pin SATA6G\_1-2 [blue]; 7-pin SATA3G\_3-6 [black])

These connectors connect to Serial ATA 6.0Gb/s or 3.0 Gb/s hard disk drives and optical disc drives via Serial ATA 6.0Gb/s or 3.0 Gb/s signal cables.

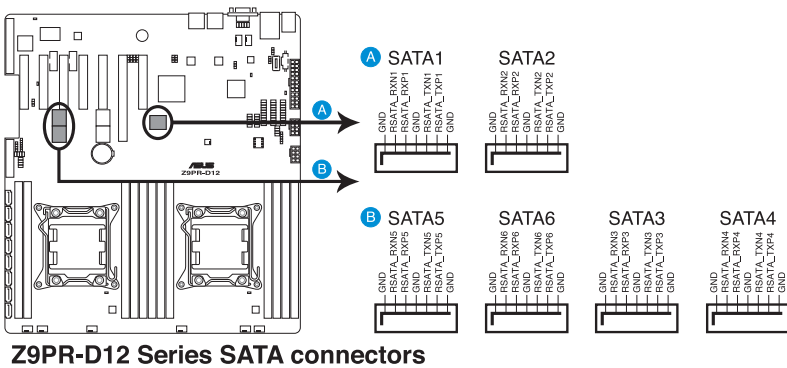

## 2. SATA connectors – ISAS connectors (7-pin ISAS1–4 [Gray])

Supported by the Intel® C602-A PCH, ISAS 1-4 connectors connect to Serial ATA 3.0 Gb/s hard disk drives and optical disk drives via Serial ATA 3.0 Gb/s signal cables.

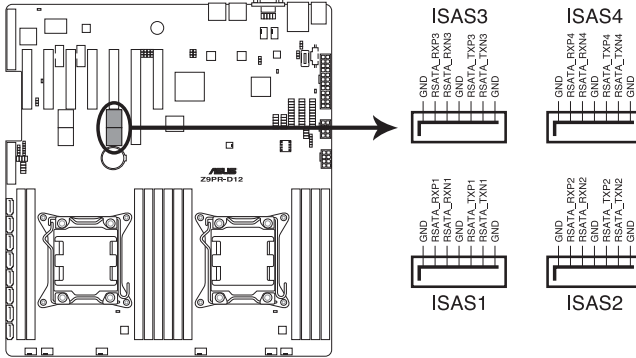

**Z9PR-D12 Series Intel® SATA connectors (SCU)**



The actual data transfer rate depends on the speed of SATA hard disks installed.

## 3. SAS connectors – PSAS connectors (7-pin PSAS1–8 [Light Blue])

Supported by the ASUS® PIKE Card, these connectors are for the SAS signal cables for SAS hard disk drives that allows up to 6Gb/s of data transfer rate.

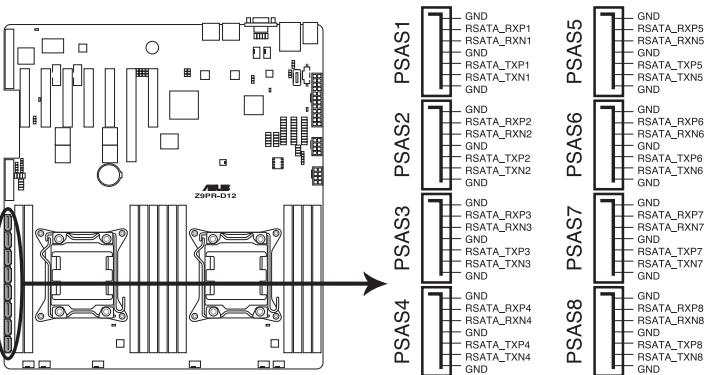

**Z9PR-D12 Series PSAS connectors**



The actual data transfer rate depends on the speed of SAS hard disks installed.

#### 4. Hard disk activity LED connector (4-pin HDLED1)

This LED connector is for the storage add-on card cable connected to the SATA or SAS add-on card. The read or write activities of any device connected to the SATA or SAS add-on card causes the front panel LED to light up.

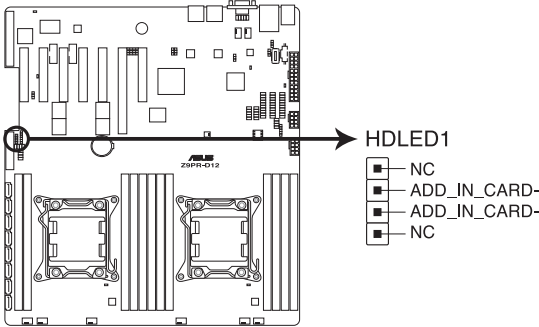

**Z9PR-D12 Series Storage card activity LED connector**

#### 5. USB connectors (10-1 pin USB34, USB56; A-Type USB7)

These connectors are for USB 2.0 ports. Connect the USB module cables to connectors USB34 and USB56, then install the modules to a slot opening at the back of the system chassis. These USB connectors comply with USB 2.0 specification that supports up to 480 Mbps connection speed.

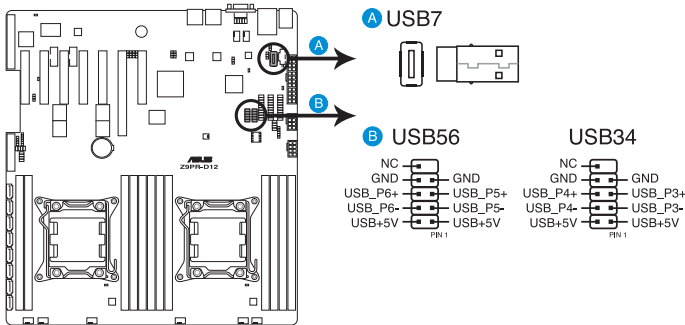

**Z9PR-D12 Series USB 2.0 connectors**

## 6. VGA connector (10-pin VGA\_HDR1)

This connector supports the VGA High Dynamic-Range interface.

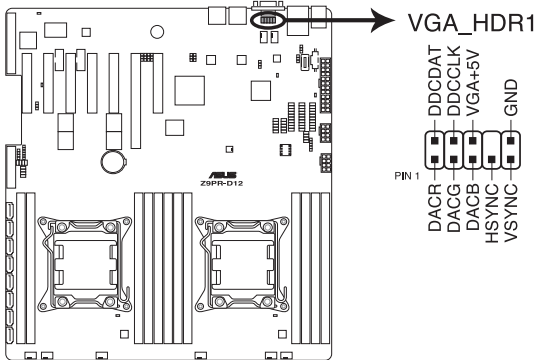

**Z9PR-D12 Series Internal VGA connector**

## 7. CPU, front and rear fan connectors (4-pin CPU\_FAN1-2, FRNT\_FAN1-4, REAR\_FAN1-2)

The fan connectors support cooling fans. Connect the fan cables to the fan connectors on the motherboard, ensuring that the black wire of each cable matches the ground pin of the connector.



- DO NOT forget to connect the fan cables to the fan connectors. Insufficient air flow inside the system may damage the motherboard components.
- These are not jumpers! DO NOT place jumper caps on the fan connectors!
- All fans feature the ASUS Fan Speed Control technology.

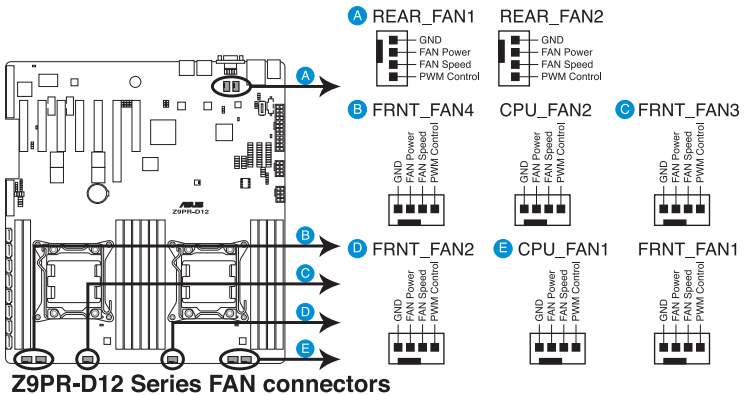

**Z9PR-D12 Series FAN connectors**

**8. Serial General Purpose Input/Output connectors (8-1 pin PSGPIO1/2, ISGPIO1, SGPIO1)**

The SGPIO 1 connectors are used for the Intel Rapid Storage Technology Enterprise SGPIO interface that controls the LED pattern generation, device information and general purpose data.



- The PSGPIO 1/2 connectors are used for PIKE card.
- The ISGPIO 1 connector is for SATA connectors—ISAS connectors.

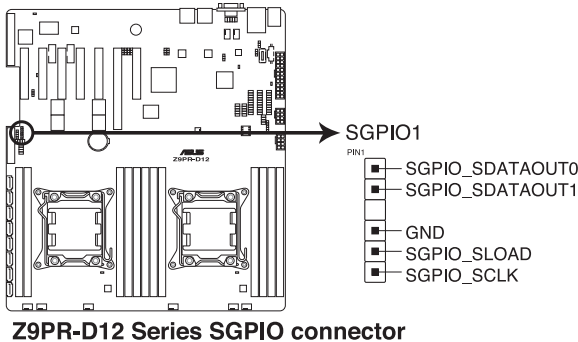
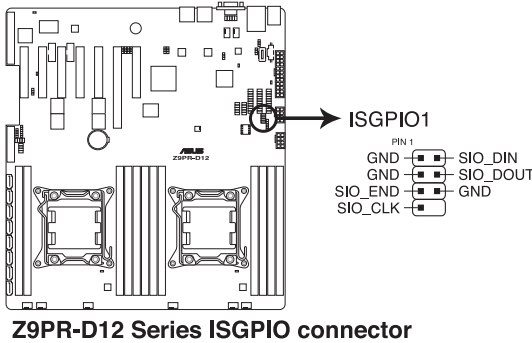
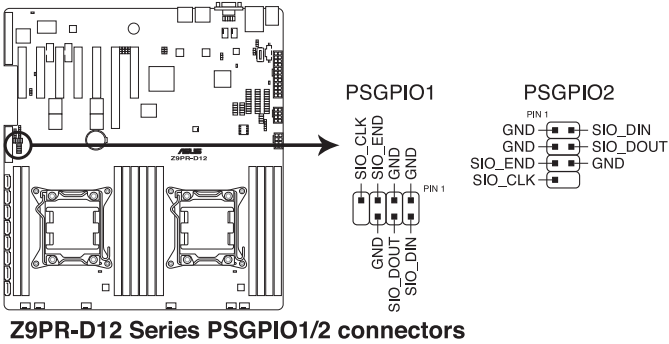



## 9. Serial port connectors (10-1 pin COM1/COM2)

These connectors are for the serial (COM) ports. Connect the serial port module cable to one of these connectors, then install the module to a slot opening at the back of the system chassis.

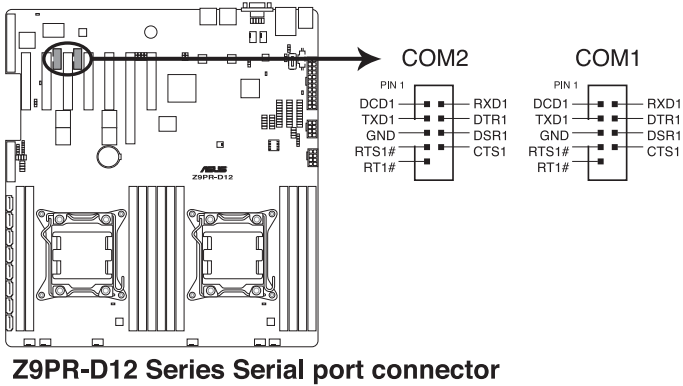

Only COM1 functions when BMC is Enabled.

## 10. TPM connector (20-1 pin TPM1)

This connector supports a Trusted Platform Module (TPM) system, which can securely store keys, digital certificates, passwords, and data. A TPM system also helps enhance network security, protects digital identities, and ensures platform integrity.

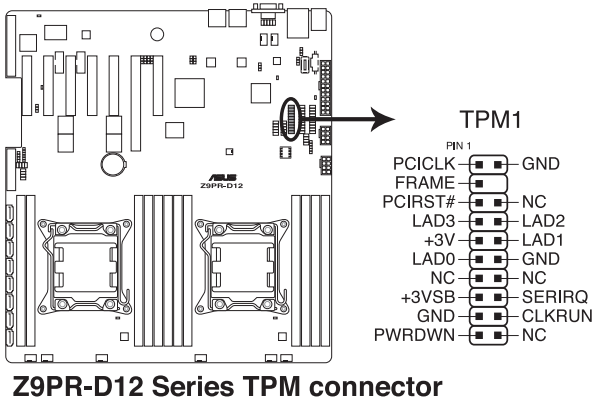

## 11. EATX power connectors (24-pin EATXPWR1, 8-pin EATX12V1/EATX12V2)

These connectors are for the EATX power supply plugs. The power supply plugs are designed to fit these connectors in only one orientation. Find the proper orientation and push down firmly until the connectors completely fit.



- DO NOT forget to connect the 24+8-pin power plugs. Otherwise, the system will not boot up.
- We recommend that you use a PSU with a higher power output when configuring a system with more power-consuming devices. The system may become unstable or may not boot up if the power is inadequate.
- This motherboard supports EATX2.0 PSU or later version.
- Ensure that your power supply unit (PSU) can provide at least the minimum power required by your system.

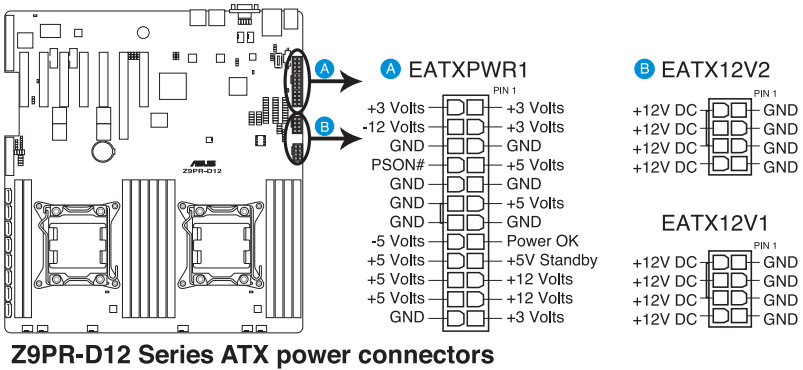

## 12. Power Supply SMBus connector (5-pin PSUSMB1)

This connector allows you to connect SMBus (System Management Bus) to the power supply unit to read PSU information. Devices communicate with an SMBus host and/or other SMBus devices using the SMBus interface.

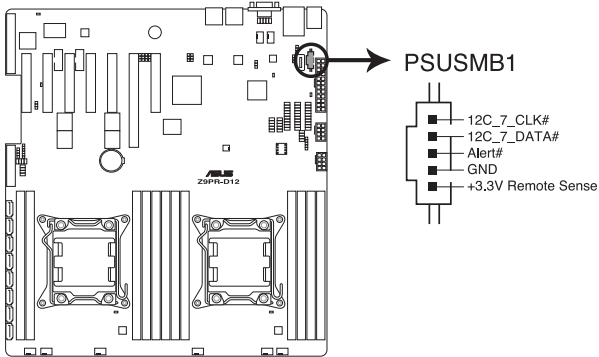

**Z9PR-D12 Series Power supply SMBus connector**

### 13. System panel connector (20-1 pin PANEL1)

This connector supports several chassis-mounted functions.

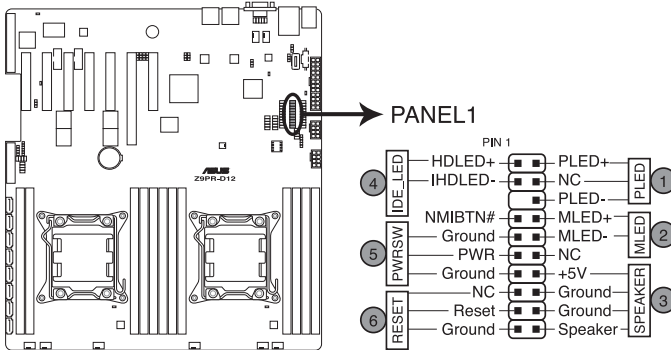

**Z9PR-D12 Series System panel connector**

#### 1) System power LED (3-pin PLED)

This 3-pin connector is for the system power LED. Connect the chassis power LED cable to this connector. The system power LED lights up when you turn on the system power, and blinks when the system is in sleep mode.

#### 2) Message LED (2-pin MLED)

This 2-pin connector is for the message LED cable that connects to the front message LED. The message LED is controlled by Hardware monitor to indicate an abnormal event occurrence.

#### 3) System warning speaker (4-pin SPEAKER)

This 4-pin connector is for the chassis-mounted system warning speaker. The speaker allows you to hear system beeps and warnings.

#### 4) Hard disk drive activity LED (2-pin HDDLED)

This 2-pin connector is for the HDD Activity LED. Connect the HDD Activity LED cable to this connector. The HDD LED lights up or flashes when data is read from or written to the HDD.

#### 5) Power button/soft-off button (2-pin PWRSW)

This connector is for the system power button. Pressing the power button turns the system on or puts the system in sleep or soft-off mode depending on the BIOS settings. Pressing the power switch for more than four seconds while the system is ON turns the system OFF.

#### 6) Reset button (2-pin RESET)

This 2-pin connector is for the chassis-mounted reset button for system reboot without turning off the system power.

#### 14. Auxiliary panel connector (20-2 pin AUX\_PANEL1)

This connector is for additional front panel features including front panel SMB, locator LED and switch, chassis intrusion, and LAN LEDs.

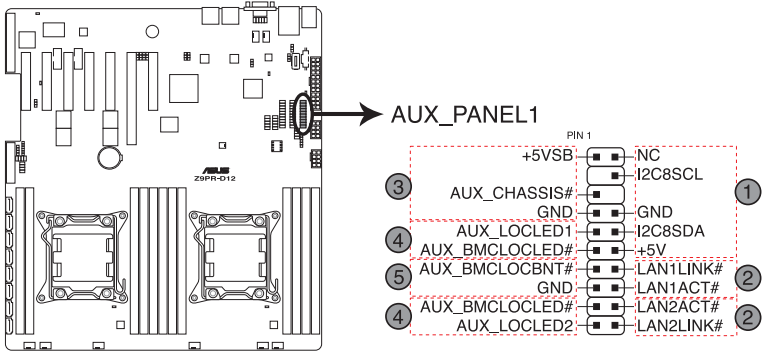

#### Z9PR-D12 Series Auxiliary panel connector

- 1) Front panel SMB (6-1 pin FPSMB)**  
These leads connect the front panel SMBus cable.
- 2) LAN activity LED (2-pin LAN1\_LED, LAN2\_LED)**  
These leads are for Gigabit LAN activity LEDs on the front panel.
- 3) Chassis intrusion (4-1 pin CHASSIS)**  
These leads are for the intrusion detection feature for chassis with intrusion sensor or microswitch. When you remove any chassis component, the sensor triggers and sends a high-level signal to these leads to record a chassis intrusion event. The default setting is short CASEOPEN and GND pin by jumper cap to disable the function.
- 4) Locator LED (2-pin LOCATORLED1 and 2-pin LOCATORLED2)**  
These leads are for the locator LED1 and LED2 on the front panel. Connect the Locator LED cables to these 2-pin connector. The LEDs will light up when the Locator button is pressed.
- 5) Locator Button/Switch (2-pin LOCATORBTN)**  
These leads are for the locator button on the front panel. This button queries the state of the system locator.



This chapter describes the power up sequence, and ways of shutting down the system.

# Powering up **3**

## Chapter summary

# 3

3.1	Starting up for the first time.....	3-3
3.2	Powering off the computer.....	3-4



## 3.1 Starting up for the first time

1. After making all the connections, replace the system case cover.
2. Ensure that all switches are off.
3. Connect the power cord to the power connector at the back of the system chassis.
4. Connect the power to a power outlet that is equipped with a surge protector.
5. Turn on the devices in the following order:
  - a. Monitor
  - b. External storage devices (starting with the last device on the chain)
  - c. System power
6. After applying power, the system power LED on the system front panel case lights up. For systems with ATX power supplies, the system LED lights up when you press the ATX power button. If your monitor complies with “green” standards or if it has a “power standby” feature, the monitor LED may light up or switch between orange and green after the system LED turns on.

The system then runs the power-on self-test or POST. While the tests are running, the BIOS beeps or additional messages appear on the screen. If you do not see anything within 30 seconds from the time you turned on the power, the system may have failed a power-on test. Check the jumper settings and connections or call your retailer for assistance.
7. At power on, hold down the <Del> key to enter the BIOS Setup. Follow the instructions in Chapter 4.

## 3.2 Powering off the computer

### 3.2.1 Using the OS shut down function

If you are using Windows® 2008 Server:

1. Click the **Start** button, move the cursor to the triangle on the right of **Log off**, and then click **Shut Down**.
2. From the **Shutdown Event Tracker**, select the option that best describes why you want to shut down the computer.
3. Tick **Planned**.
4. If necessary, key in comments.
5. Click **OK**.

### 3.2.2 Using the dual function power switch

While the system is ON, press the power switch for less than four seconds to put the system to sleep mode or to soft-off mode, depending on the BIOS setting.

This chapter tells how to change the system settings through the BIOS Setup menus. Detailed descriptions of the BIOS parameters are also provided.

# BIOS setup **4**

4.1	Managing and updating your BIOS .....	4-3
4.2	BIOS setup program .....	4-7
4.3	Main menu .....	4-10
4.4	Advanced menu .....	4-11
4.5	Server Mgmt menu.....	4-37
4.6	Event Logs menu .....	4-40
4.7	Boot menu .....	4-42
4.8	Monitor menu .....	4-44
4.9	Security menu .....	4-45
4.10	Tool menu .....	4-46
4.11	Exit menu .....	4-47

## 4.1 Managing and updating your BIOS

The following utilities allow you to manage and update the motherboard Basic Input/Output System (BIOS) setup:

1. **ASUS CrashFree BIOS 3** : Allows you to recover the BIOS using a bootable USB flash disk drive when the BIOS file fails or gets corrupted.
2. **ASUS EZ Flash 2** : Allows you to update the BIOS using a USB flash disk.
3. **BUPDATER utility** : Allows you to update the BIOS in DOS mode using a bootable USB flash disk drive.



---

**The BIOS ROM chip contains security protection settings and the BIOS ROM cannot be exchanged between motherboards, even if the motherboards belong to the same series.**

---



---

Save a copy of the original motherboard BIOS file to a bootable USB flash disk drive in case you need to restore the BIOS in the future. Copy the original motherboard BIOS using the BUPDATER utility.

---

### 4.1.1 ASUS CrashFree BIOS 3

ASUS CrashFree BIOS 3 is an auto recovery tool that allows you to restore the BIOS file when it fails or gets corrupted during the updating process. You can update a corrupted BIOS file using a USB flash drive that contains the updated BIOS file.



---

Prepare a USB flash drive containing the updated motherboard BIOS before using this utility.

---

### Recovering the BIOS from a USB flash drive

To recover the BIOS from a USB flash drive:

1. Insert the USB flash drive containing the original or new BIOS file to the USB port.
2. The utility will automatically recover the BIOS. It resets the system when the BIOS recovery is finished.



---

**DO NOT** shut down or reset the system while recovering the BIOS! Doing so would cause system boot failure!

---



---

The recovered BIOS may not be the latest BIOS version for this motherboard. Visit the ASUS website at [www.asus.com](http://www.asus.com) to download the latest BIOS file.

---

## 4.1.2 ASUS EZ Flash 2

The ASUS EZ Flash 2 allows you to update the BIOS without using a DOS-based utility.



Before you start using this utility, download the latest BIOS from the ASUS website at [www.asus.com](http://www.asus.com).

To update the BIOS using EZ Flash 2

1. Insert the USB flash disk that contains the latest BIOS file to the USB port.
2. Enter the BIOS setup program. Go to the **Tool** menu to select **ASUS EZ Flash 2 Utility** and press <Enter> to enable it.

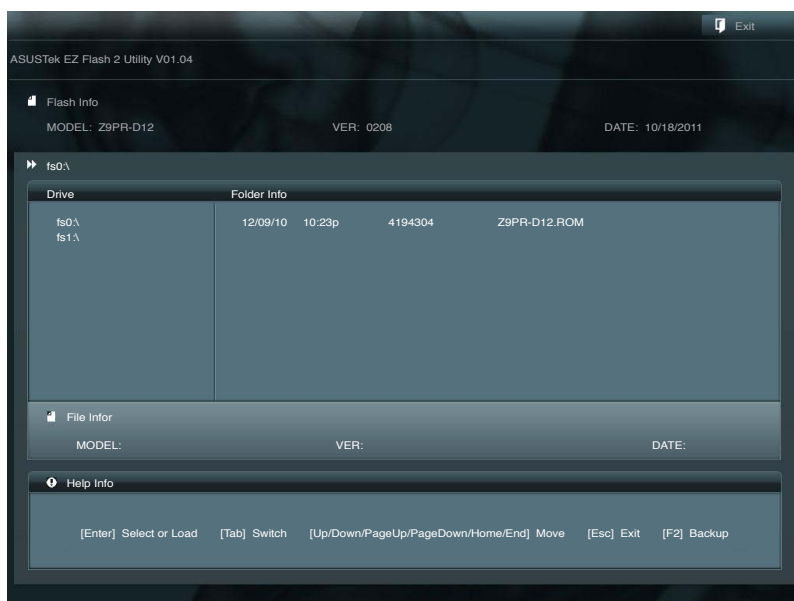

3. Press <Tab> to switch to the **Drive** field.
4. Press the Up/Down arrow keys to find the USB flash disk that contains the latest BIOS, and then press <Enter>.
5. Press <Tab> to switch to the **Folder Info** field.
6. Press the Up/Down arrow keys to find the BIOS file, and then press <Enter> to perform the BIOS update process. Reboot the system when the update process is done.



- 
- This function can support devices such as a USB flash disk with FAT 32/16 format and single partition only.
  - DO NOT shut down or reset the system while updating the BIOS to prevent system boot failure!
- 



---

Ensure to load the BIOS default settings to ensure system compatibility and stability. Press <F5> and select **Yes** to load the BIOS default settings.

---

### 4.1.3 BUPDATER



---

The succeeding BIOS screens are for reference only. The actual BIOS screen displays may not be the same as shown.

---

The BUPDATER utility allows you to update the BIOS file in DOS environment using a bootable USB flash disk drive with the updated BIOS file.

#### Updating the BIOS file

To update the BIOS file using BUPDATER:

1. Visit the ASUS website at [www.asus.com](http://www.asus.com) and download the latest BIOS file for the motherboard. Save the BIOS file to a bootable USB flash disk drive.
2. Copy the BUPDATER utility (BUPDATER.exe) from the ASUS support website at [support.asus.com](http://support.asus.com) to the bootable USB flash disk drive you created earlier.
3. Boot the system in DOS mode, then at the prompt, type:

```
BUPDATER /i [filename] .ROM
```

where [filename] is the latest or the original BIOS file on the bootable USB flash disk drive, then press <Enter>.

```
A:\>BUPDATER /i [file name] .ROM
```

The utility verifies the file, then starts updating the BIOS file.

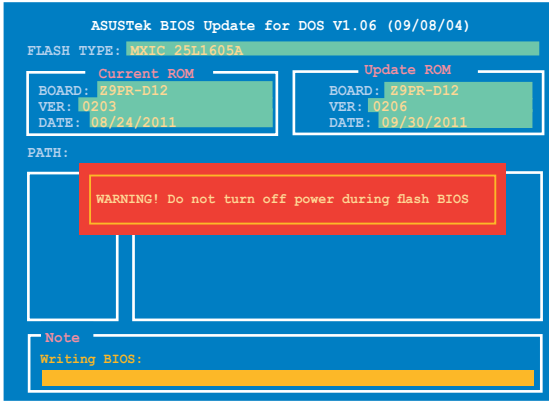

---

DO NOT shut down or reset the system while updating the BIOS to prevent system boot failure!

---

5. The utility returns to the DOS prompt after the BIOS update process is completed. Reboot the system from the hard disk drive.

```
The BIOS update is finished! Please restart your system.  
C:\>
```



## 4.2 BIOS setup program

This motherboard supports a programmable firmware chip that you can update using the provided utility described in section 4.1 **Managing and updating your BIOS**.

Use the BIOS Setup program when you are installing a motherboard, reconfiguring your system, or prompted to “Run Setup.” This section explains how to configure your system using this utility.

Even if you are not prompted to use the Setup program, you can change the configuration of your computer in the future. For example, you can enable the security password feature or change the power management settings. This requires you to reconfigure your system using the BIOS Setup program so that the computer can recognize these changes and record them in the CMOS RAM of the firmware chip.

The firmware chip on the motherboard stores the Setup utility. When you start up the computer, the system provides you with the opportunity to run this program. Press <Del> during the Power-On Self-Test (POST) to enter the Setup utility; otherwise, POST continues with its test routines.

If you wish to enter Setup after POST, restart the system by pressing <Ctrl+Alt+Delete>, or by pressing the reset button on the system chassis. You can also restart by turning the system off and then back on. Do this last option only if the first two failed.

The Setup program is designed to make it as easy to use as possible. Being a menu-driven program, it lets you scroll through the various sub-menus and make your selections from the available options using the navigation keys.



- 
- The default BIOS settings for this motherboard apply for most conditions to ensure optimum performance. If the system becomes unstable after changing any BIOS settings, load the default settings to ensure system compatibility and stability. Press <F5> and select **Yes** to load the BIOS default settings.
  - The BIOS setup screens shown in this section are for reference purposes only, and may not exactly match what you see on your screen.
  - Visit the ASUS website ([www.asus.com](http://www.asus.com)) to download the latest BIOS file for this motherboard.
-

## 4.2.1 BIOS menu screen

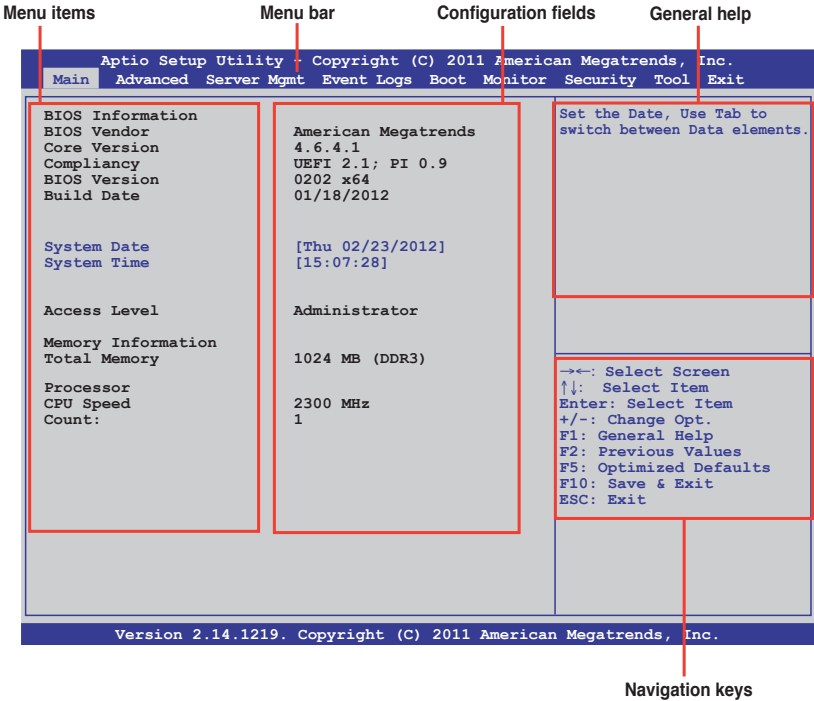

## 4.2.2 Menu bar

The menu bar on top of the screen has the following main items:

- Main** For changing the basic system configuration
- Advanced** For changing the advanced system settings
- Server Mgmt** For changing the Server Mgmt settings
- Event Logs** For changing the event log settings
- Boot** For changing the system boot configuration
- Monitor** For displaying the system temperature, power status, and changing the fan settings
- Security** For changing the security settings
- Tool** For configuring options for special functions
- Exit** For selecting the exit options

To select an item on the menu bar, press the right or left arrow key on the keyboard until the desired item is highlighted.

### 4.2.3 Menu items

The highlighted item on the menu bar displays the specific items for that menu. For example, selecting **Main** shows the Main menu items.

The other items (Event Logs, Advanced, Monitor, Boot, Tool, and Exit) on the menu bar have their respective menu items.

### 4.2.4 Submenu items

A solid triangle before each item on any menu screen means that the item has a submenu. To display the submenu, select the item and press <Enter>.

### 4.2.5 Navigation keys

At the bottom right corner of a menu screen are the navigation keys for the BIOS setup program. Use the navigation keys to select items in the menu and change the settings.

### 4.2.6 General help

At the top right corner of the menu screen is a brief description of the selected item.

### 4.2.7 Configuration fields

These fields show the values for the menu items. If an item is user-configurable, you can change the value of the field opposite the item. You cannot select an item that is not user-configurable.

A configurable field is enclosed in brackets, and is highlighted when selected. To change the value of a field, select it and press <Enter> to display a list of options.

### 4.2.8 Pop-up window

Select a menu item and press <Enter> to display a pop-up window with the configuration options for that item.

### 4.2.9 Scroll bar

A scroll bar appears on the right side of a menu screen when there are items that do not fit on the screen. Press the Up/Down arrow keys or <Page Up> /<Page Down> keys to display the other items on the screen.

## 4.3 Main menu

When you enter the BIOS Setup program, the Main menu screen appears. The Main menu provides you an overview of the basic system information, and allows you to set the system date, time settings.

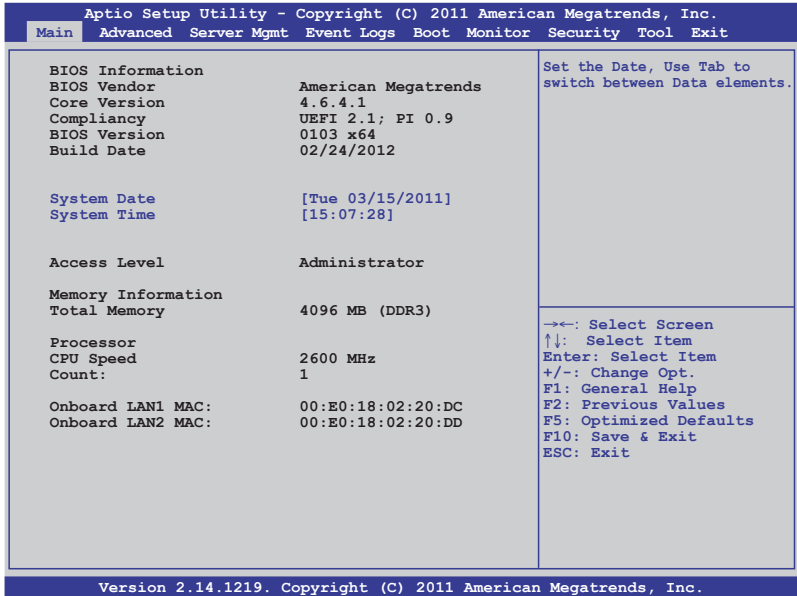

### 4.3.1 System Date [Day xx/xx/xxxx]

Allows you to set the system date.

### 4.3.2 System Time [xx:xx:xx]

Allows you to set the system time.

## 4.4 Advanced menu

The Advanced menu items allow you to change the settings for the CPU and other system devices.



Be cautious when changing the settings of the Advanced menu items. Incorrect field values can cause the system to malfunction.

Aptio Setup Utility - Copyright (C) 2011 American Megatrends, Inc.	
Main <b>Advanced</b> Server Mgmt Event Logs Boot Monitor Security Tool Exit	
<ul style="list-style-type: none"> <li>▶ CPU Configuration</li> <li>▶ CPU Power Management Configuration</li> <li>▶ Chipset Configuration</li> <li>▶ PCH SATA Configuration</li> <li>▶ PCH SCU Configuration</li> <li>▶ PCI Subsystem Settings</li> <li>▶ Intel TXT (LT-SX) Configuration</li> <li>▶ USB Configuration</li> <li>▶ Trusted Computing</li> <li>▶ ACPI Settings</li> <li>▶ WHEA Configuration</li> <li>▶ APM</li> <li>▶ Serial Port Console Redirection</li> <li>▶ Onboard LAN Configuration</li> <li>▶ ME Subsystem</li> <li>▶ Legacy Devices Configuration</li> <li>▶ Runtime Error Logging</li> </ul>	<p>CPU Configuration Parameters</p> <hr/> <p>→←: Select Screen            ↑↓: Select Item            Enter: Select Item            +/-: Change Opt.            F1: General Help            F2: Previous Values            F5: Optimized Defaults            F10: Save &amp; Exit            ESC: Exit</p>
Version 2.14.1219. Copyright (C) 2011 American Megatrends, Inc.	

### 4.4.1 CPU Configuration

Aptio Setup Utility - Copyright (C) 2011 American Megatrends, Inc.							
Advanced							
<p>CPU Configuration</p> <ul style="list-style-type: none"> <li>▶ Socket 1 CPU Information</li> </ul> <table style="width: 100%; border-collapse: collapse;"> <tr> <td style="width: 50%;">Socket 2</td> <td style="width: 50%;">Not Present</td> </tr> <tr> <td>CPU Speed</td> <td>2300 MHz</td> </tr> <tr> <td>64-bit</td> <td>Supported</td> </tr> </table> <ul style="list-style-type: none"> <li>Hyper Threading [Enabled]</li> <li>Active Processor Core [All]</li> <li>Limit CPUID Maximum [Disabled]</li> <li>Execute Disable Bit [Enabled]</li> <li>Server Class [Custom]</li> <li>Hardware Prefetcher [Enabled]</li> <li>Adjacent Cache Line Prefetch [Enabled]</li> <li>DCU Streamer Prefetcher [Enabled]</li> <li>DCU IP Prefetcher [Enabled]</li> <li>Intel Virtualization Technology [Enabled]</li> <li>Local APIC Mode [Auto]</li> </ul>	Socket 2	Not Present	CPU Speed	2300 MHz	64-bit	Supported	<p>Enter to view socket specific CPU Information.</p> <hr/> <p>→←: Select Screen            ↑↓: Select Item            Enter: Select Item            +/-: Change Opt.            F1: General Help            F2: Previous Values            F5: Optimized Defaults            F10: Save &amp; Exit            ESC: Exit</p>
Socket 2	Not Present						
CPU Speed	2300 MHz						
64-bit	Supported						
Version 2.14.1219. Copyright (C) 2011 American Megatrends, Inc.							

## Socket 1 CPU Information

Enter to view the CPU Information.

```
Aptio Setup Utility - Copyright (C) 2011 American Megatrends, Inc.
Advanced

Socket 1 CPU Information
Genuine Intel(R) CPU @ 2.60GHz

CPU Signature           206d5
Microcode Patch        513
Max CPU Speed           2600 MHz
Min CPU Speed           1200 MHz
Processor Cores         8
Intel HT Technology     Supported
Intel VT-X Technology   Supported
Intel SMX Technology    Supported

L1 Data Cache           32kB x8
L1 Code Cache           32kB x8
L2 Cache                 256kB x8
L3 Cache                20480 kB

-->: Select Screen
↑↓: Select Item
Enter: Select Item
+/-: Change Opt.
F1: General Help
F2: Previous Values
F5: Optimized Defaults
F10: Save & Exit
ESC: Exit

Version 2.14.1219. Copyright (C) 2011 American Megatrends, Inc.
```

### Hyper Threading [Enabled]

Allows you to enable or disable the Intel Hyper-Threading Technology function.

When disabled, only one thread per activated core is enabled.

Configuration options: [Disabled] [Enabled]

### Active Processor Cores [All]

Configuration options: [All] [1] [2] [4] [6]



---

Configuration code numbers vary with CPU models.

---

### Limit CPUID Maximum [Disabled]

Setting this item to [Enabled] allows legacy operating system to boot even without support for CPUs with extended CPUID functions.

Configuration options: [Disabled] [Enabled]

### Execute Disable Bit [Enabled]

XP can prevent certain classes of malicious buffer overflow attacks when combined with a supporting OS (Windows Server 2003 SP1, Windows XP SP2, SuSE Linux 9.2, Redhat Enterprise 3 Update 3). Configuration options: [Disabled] [Enabled]

### Server Class [Custom]

Use Intel recommended prefetch settings. Configuration options: [Enterprise] [High Performance(HPC)] [Custom]

### Hardware Prefetcher [Enabled]

This Item allows you to turn on/off the mid level cache(L2) streamer prefetcher.

Configuration options: [Disabled] [Enabled]

### Adjacent Cache Line Prefetch [Enabled]

This Item allows you to turn on/off prefetching of adjacent cache lines.

Configuration options: [Disabled] [Enabled]

### DCU Streamer Prefetcher [Enabled]

This Item allows you to enable/disable L1 data prefetcher.

Configuration options: [Disabled] [Enabled]

### DCU IP Prefetcher [Enabled]

This Item allows you to enable/disable L1 data prefetcher.

Configuration options: [Disabled] [Enabled]

### Intel Virtualization Technology [Enabled]

When enabled this item, a VMM can utilize the additional hardware capabilities provided by Vanderpool Technology.

Configuration options: [Disabled] [Enabled]

### APIC mode [Auto]

Allows you to select APIC mode.

Configuration options: [Auto][x2APIC] [xAPIC]

## 4.4.2 CPU Power Management Configuration

Aptio Setup Utility - Copyright (C) 2011 American Megatrends, Inc.	
Advanced	
CPU Power Management Configuration	
Power Technology	[Custom]
EIST	[Enabled]
Turbo Mode	[Enabled]
P-STATE Coordination	[HW ALL]
CPU C3 Report	[Disabled]
CPU C6 Report	[Enabled]
CPU C7 Report	[Disabled]
Package C State limit	[C6]
Energy Performance	[Balanced Performance]
Factory long duration power limit	115 Watts
Long duration power limit	0
Factory long duration maintained	1000 ms
Long duration power limit	0
Recommended short duration power1	1.2 * Long Duration
Short duration power limit	0
This item allows you to enabled power management features.  →←: Select Screen ↑↓: Select Item Enter: Select Item +/-: Change Opt. F1: General Help F2: Previous Values F5: Optimized Defaults F10: Save & Exit ESC: Exit	
Version 2.14.1219. Copyright (C) 2011 American Megatrends, Inc.	

### Power Technology [Custom]

This item allows you to enable power management features.

Configuration options: [Disabled] [Energy Efficient] [Custom]

### EIST [Enabled]

This item allows you to enable/disable Intel SpeedStep.

Configuration options: [Disabled] [Enabled]

### **Turbo Mode [Enabled]**

Configuration options: [Disabled] [Enabled]

### **P-STATE Coordination [HW\_ALL]**

This item allows you to change P-STATE Coordination type.

Configuration options: [HW\_ALL] [SW\_ALL] [SW\_ANY]

### **CPU C3 Report [Disabled]**

This item allows you to enable/disable CPU C3(ACPI C2) report.

Configuration options: [Disabled] [Enabled]

### **CPU C6 Report [Enabled]**

This item allows you to enable/disable CPU C6(ACPI C3) report.

Configuration options: [Disabled] [Enabled]

### **CPU C7 Report [Disabled]**

This item allows you to enable/disable CPU C7(ACPI C3) report.

Configuration options: [Disabled] [Enabled]

### **Package C State limit [C6]**

This item allows you to set package C State limit.

Configuration options: [C0] [C2] [C6] [C7] [No Limit]

### **Energy Performance [Balanced Performance]**

This item allows you to optimize between performance and power savings.

Configuration options: [Performance] [Balanced Performance] [Balanced Energy] [Energy Efficient]

**Factory long duration power limit 115 Watts**

**Long duration power limit 0**

Allows you to set long duration power limit in watts. Use the <+> and <-> keys to adjust the value.

**Factory long duration maintained 1000 ms**

**Long duration power limit 0**

Allows you to set time window which the long duration power is maintained. Use the <+> and <-> keys to adjust the value.

**Recommended short duration power1 1.2 \* Long Duration**

**Short duration power limit 0**

Allows you to set short duration power limit in watts. Use the <+> and <-> keys to adjust the value.



### 4.4.3 Chipset Configuration

Aptio Setup Utility - Copyright (C) 2011 American Megatrends, Inc.	
Advanced	
<ul style="list-style-type: none"><li>▶ QPI Configuration</li><li>▶ Memory Configuration</li><li>▶ CPU I/O Bridge Configuration</li><li>▶ PCH Configuration</li><li>▶ Intel(R) VT for Directed I/O Configuration</li></ul>	QPI Configuration Page

#### QPI Configuration

Aptio Setup Utility - Copyright (C) 2011 American Megatrends, Inc.		
Advanced		
Current QPI Link Speed	Slow	Enable/Disable Isoc
Current QPI Link Freq	Unknown	
Isoc	[Enabled]	
QPI Link Speed Mode	[Fast]	
QPI Link Frequency Select	[Auto]	
QPI Link0s	[Disabled]	
QPI Link0p	[Disabled]	
QPI Link1	[Enabled]	

#### Isoc [Enabled]

Configuration options: [Disabled] [Enabled]

#### QPI Link Speed Mode [Fast]

This item allows you to select the QPI link speed as either the fast mode or slow mode.

Configuration options: [Slow] [Fast]

#### QPI Link Frequency Select [Auto]

This item allows for selecting the QPI link frequency

Configuration options: [Auto] [6.4 GT/s] [7.2 GT/s (Fast Mode Only)] [8.0 GT/s (Fast Mode Only)]

#### QPI Link0s [Disabled]

Configuration options: [Disabled] [Enabled]

#### QPI Link0p [Disabled]

Configuration options: [Disabled] [Enabled]

#### QPI Link1 [Enabled]

Configuration options: [Disabled] [Enabled]

# Memory Configuration

Aptio Setup Utility - Copyright (C) 2011 American Megatrends, Inc.		
Advanced		
Compatibility RID	[Enabled]	Support for compatibility Revision ID (CRID) functionality mentioned in Sandybridge bios spec.
Memory Configuration		
Total Memory	4096 MB (DDR3)	→←: Select Screen ↑↓: Select Item Enter: Select Item +/-: Change Opt. F1: General Help F2: Previous Values F5: Optimized Defaults F10: Save & Exit ESC: Exit
Current Memory Mode	Independent	
Currently Memory Speed	1333 MHz	
Mirroring	Not Possible	
Sparing	Not Possible	
Memory Mode	[Independent]	
DDR Speed	[Auto]	
Channel Interleaving	[Auto]	
Rank Interleaving	[Auto]	
Patrol Scrub	[Disabled]	
Demand Scrub	[Enabled]	
Data Scrambling	[Enabled]	
Device Tagging	[Disabled]	
Thermal Throttling	[CLTT]	
Enable High Temp.	[Disabled]	
Allow 2x Refresh	[Enabled]	
Altitude	[300 M]	
Memory HOT sensor support	[Enabled]	
▶ DIMM Information		
Version 2.14.1219. Copyright (C) 2011 American Megatrends, Inc.		

## Compatibility RID [Enabled]

Support for compatibility revision ID (CRID) functionality mentioned in Sandy Bridge BIOS specification. Configuration options: [Enabled] [Disabled]

## Memory Mode [Independent]

Select the mode for memory initializer.

Configuration options: [Independent] [Mirroring] [Lock Step] [Sparing]

## DDR Speed [Auto]

Force DDR speed. Configuration options: [Auto] [Force DDR3 800] [Force DDR3 1066] [Force DDR3 1333] [Force DDR3 1600] [Force DDR3 1866]

## Channel Interleaving [Auto]

Select different channel interleaving setting.

Configuration options: [Auto] [1 Way] [2 Way] [3 Way] [4 Way]

## Rank Interleaving [Auto]

Select different rank interleaving setting.

Configuration options: [Auto] [1 Way] [2 Way] [4 Way] [8 Way]

**Patrol Scrub [Disabled]**

Allows you to Enable/Disable Patrol Scrub.  
Configuration options: [Disabled] [Enabled]

**Demand Scrub [Enabled]**

Allows you to Enable/Disable demand scrubbing feature.  
Configuration options: [Enabled] [Disabled]

**Data Scrambling [Enabled]**

Allows you to Enable/Disable data scrambling.  
Configuration options: [Enabled] [Disabled]

**Device Tagging [Disabled]**

Allows you to Enable/Disable device tagging.  
Configuration options: [Enabled] [Disabled]

**Thermal Throttling [CLTT]**

Configuration options: [Disabled] [OLTT] [CLTT]

**Enable High Temp [Disabled]**

Configuration options: [Disabled] [Enabled]

**Allow 2x Refresh [Enabled]**

Configuration options: [Disabled] [Enabled]

**Altitude [300 M]**

The system altitude above the sea level in meters.  
Configuration options: [Auto] [300 M] [900 M] [1500 M] [3000 M]

**Memory Hot sensor support [Enabled]**

Configuration options: [Disabled] [Enabled]

## DIMM Information

Aptio Setup Utility - Copyright (C) 2011 American Megatrends, Inc.		
Advanced		
CPU1 DIMM Information		
Node 0 Ch 0 Dimm A1	Not Present	
Node 0 Ch 0 Dimm A2	Not Present	
Node 0 Ch 0 Dimm B1	Not Present	
Node 0 Ch 0 Dimm B2	Not Present	
Node 0 Ch 0 Dimm C1	Not Present	
Node 0 Ch 0 Dimm C2	Not Present	
Node 0 Ch 0 Dimm D1	Present 40096 MB Indep	
Node 0 Ch 0 Dimm D2	Not Present	
CPU2 DIMM Information		

## CPU I/O Bridge Configuration

Aptio Setup Utility - Copyright (C) 2011 American Megatrends, Inc.		
Advanced		
Intel(R) I/OAT	[Disabled]	Enables/Disables Intel(R) I/O Acceleration Technology (I/OAT).
DCA Support	[Enabled]	
VGA Priority	[Offboard]	
TargetVGA	VGA From CPU 0	
		→←: Select Screen ↑↓: Select Item Enter: Select Item +/-: Change Opt. F1: General Help F2: Previous Values F5: Optimized Defaults F10: Save & Exit ESC: Exit
Version 2.14.1219. Copyright (C) 2011 American Megatrends, Inc.		

### Intel(R) I/OAT [Disabled]

Allows you to enable/disable Intel I/O acceleration technology.

Configuration options: [Disabled] [Enabled]

### DCA Support [Enabled]

Allows you to enable/disable DCA support.

Configuration options: [Disabled] [Enabled]

### VGA Priority [offboard]

Allows you to decide priority between onboard and 1st offboard video device found.

Configuration options: [Onboard] [Offboard]

## PCH Configuration

Aptio Setup Utility - Copyright (C) 2011 American Megatrends, Inc.		
Advanced		
Name Stepping	Patsburg 06 (C1 Stepping)	Support for PCH Compatibility Revision ID(CRID) functionality.
SB Chipset Configuration		
PCH Compatibility RID	[Disabled]	
Deep Sx	[Disabled]	
SCU devices	[Enabled]	
Onboard SATA RAID Oprom	[Enabled]	
High Precision Event Timer Configuration		
High Precision Timer	[Enabled]	
		→←: Select Screen ↑↓: Select Item Enter: Select Item +/-: Change Opt. F1: General Help F2: Previous Values F5: Optimized Defaults F10: Save & Exit ESC: Exit
Version 2.14.1219. Copyright (C) 2011 American Megatrends, Inc.		

### PCH Compatibility RID [Disabled]

Support for PCH compatibility.

Configuration options: [Disabled] [Enabled]

### Deep Sx [Disabled]

Configuration options: [Disabled] [Enabled in S5] [Enabled in S4 and S5]



Mobile platforms support deep S4/S5 in DC only and desktop platforms support deep S4/S5 in AC only.

### SCU devices [Enabled]

Allows you to enable/disable Patsburg SCU devices.

Configuration options: [Enabled] [Disabled]

### Onboard SATA RAID Oprom [Enabled]

Allows you to enable/disable onboard SATA RAID option rom if Launch Storage Oprom is enabled. Configuration options: [Disabled] [Enabled]

## High Precision Event Timer Configuration

### High Precision Timer [Enabled]

Allows you to enable/disable High Precision Event Timer.

Configuration options: [Disabled] [Enabled]

## Intel(R) VT for Directed I/O Configuration

Aptio Setup Utility - Copyright (C) 2011 American Megatrends, Inc.		
Advanced		
Intel(R) VT-d	[Disabled]	Enables or Disables BIOS ACPI Auto Configuration.

### Intel(R) VT-d [Disabled]

Allows you to enable or disable Intel VT-d.

Configuration options: [Enabled] [Disabled]



---

The following item appears only when you set **Intel(R) VT-d** to [Enabled].

---

#### Coherency Support [Disabled]

Allows you to enable/disable VT-d Engine Coherency support.

Configuration options: [Disabled] [Enabled]

#### ATS Support [Disabled]

Allows you to enable/disable VT-d Engine address translation services (ATS) support. Configuration options: [Disabled] [Enabled]

## 4.4.4 PCH SATA Configuration

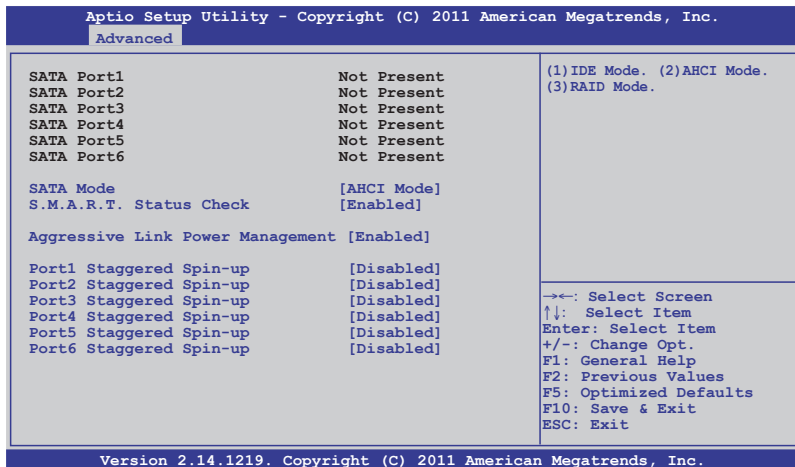

### SATA Mode [AHCI Mode]

Allows you to set the SATA configuration.

Configuration options: [Disabled] [IDE Mode] [AHCI Mode] [RAID Mode]



- If you want to use the Serial ATA hard disk drives as Parallel ATA physical storage devices, set this item to [IDE Mode].
- If you want the Serial ATA hard disk drives to use the Advanced Host Controller Interface (AHCI), keep the default setting [AHCI Mode]. The AHCI allows the onboard storage driver to enable advanced Serial ATA features that increases storage performance on random workloads by allowing the drive to internally optimize the order of commands.
- If you want to create RAID sets with LSI MegaRAID utility, or Intel® Rapid Storage Technology Enterprise from the Serial ATA hard disk drives, set this item to [RAID Mode].

### S.M.A.R.T. Status Check [Enabled]

S.M.A.R.T. (Self-Monitoring, Analysis and Reporting Technology) is a monitor system. When hard disk read/write errors occur, this feature allows the hard disk to report warning messages during the POST.

Configuration options: [Enabled] [Disabled]

### Aggressive Link Power Management [Enabled]

Configuration options: [Enabled] [Disabled]

### Port 1/2/3/4/5/6 Staggered Spin-up [Disabled]

AHCI supports staggered spin-up.

Configuration options: [Enabled] [Disabled]

## 4.4.5 PCH SCU Configuration

This menu automatically detects and displays Device 1-4.

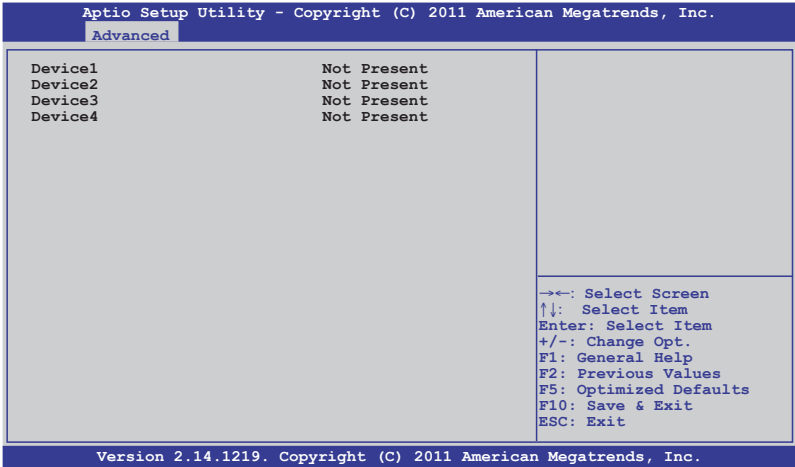



## 4.4.6 PCI Subsystem Settings

Aptio Setup Utility - Copyright (C) 2011 American Megatrends, Inc.		
Advanced		
PCI Bus Driver Version	V 2.05.00	In case of multiple Option ROMs (Legacy and EFI Compatible), specifies what PCI option ROM to lanuch.
PCI Option ROM Handling		
PCI ROM Priority	[EFI Compatible ROM]	
PCI Common Setting		
PCI Latency Timer	[32 PCI Bus Clocks]	
VGA Palette Snoop	[Disabled]	
PERR# Generation	[Disabled]	
SERR# Generation	[Disabled]	
Load RT32 Image	[Enabled]	
-><-: Select Screen ↑↓: Select Item Enter: Select Item +/-: Change Opt. F1: General Help F2: Previous Values F5: Optimized Defaults F10: Save & Exit ESC: Exit		
Version 2.14.1219. Copyright (C) 2011 American Megatrends, Inc.		

### PCI ROM Priority [EFI Compatible ROM]

In case of multiple option roms (Legacy and EFI Compatible), specifies what PCI option rom to lanuch. Configuration options: [Legacy ROM] [EFI Compatible ROM]

### PCI Latency Timer [32 PCI Bus Clocks]

Value to be programmed into PCI latency timer register.

Configuration options: [32 PCI Bus Clocks] [64 PCI Bus Clocks] [96 PCI Bus Clocks] [128 PCI Bus Clocks] [160 PCI Bus Clocks] [192 PCI Bus Clocks] [224 PCI Bus Clocks] [248 PCI Bus Clocks]

### VGA Palette Snoop [Disabled]

Enables or disables VGA pallette registers snooping.

Configuration options: [Disabled] [Enabled]

### PERR# Generation [Disabled]

Enables or disables PCI device to generate PERR#.

Configuration options: [Disabled] [Enabled]

### SERR# Generation [Disabled]

Enables or disables PCI device to generate SERR#.

Configuration options: [Disabled] [Enabled]

### Load RT32 Image [Disabled]

Enables or disables PCI device to load RT32 image.

Configuration options: [Disabled] [Enabled]

# PCI Express Settings

Aptio Setup Utility - Copyright (C) 2011 American Megatrends, Inc.	
Advanced	
PCI Express Link Register Settings	Enables or Disables PCI Express Device Relaxed Ordering.
ASPM Support [Disabled]	
WARNING: Enabling ASPM may cause some PCI-E device to fail	
	→←: Select Screen ↑↓: Select Item Enter: Select Item +/-: Change Opt. F1: General Help F2: Previous Values F5: Optimized Defaults F10: Save & Exit ESC: Exit
Version 2.14.1219. Copyright (C) 2011 American Megatrends, Inc.	

## PCI Express Link Register Settings

### ASPM Support [Disabled]

Allows to set the ASPM level. Configuration options: [Disabled] [Auto] [Force L0s]

[Force L0s] Force all links to L0s state.

[Auto] BIOS auto configure.

[Disabled] Disabled ASPM.

## PCIe Slot Option Rom Configuration

Aptio Setup Utility - Copyright (C) 2011 American Megatrends, Inc.		
Advanced		
Legacy OpROM Support Launch Storage OpROM	[Enabled]	Enables or disables boot option for legacy mass storage device with option ROM.
PCI E1 Option Rom	[Enabled]	
PCI E2 Option Rom	[Enabled]	
PCI E3 Option Rom	[Enabled]	
PCI E4 Option Rom	[Enabled]	
PCI E5 Option Rom	[Enabled]	
PCI E6 Option Rom	[Enabled]	
PCI E7 Option Rom	[Enabled]	
PIKE Option Rom	[Enabled]	
		→←: Select Screen ↑↓: Select Item Enter: Select Item +/-: Change Opt. F1: General Help F2: Previous Values F5: Optimized Defaults F10: Save & Exit ESC: Exit
Version 2.14.1219. Copyright (C) 2011 American Megatrends, Inc.		

### Launch Storage OpROM [Enabled]

Enables or disables boot option for legacy mass storage device with option ROM.

Configuration options: [Disabled] [Enabled]

### PCI E1 Option Rom [Enabled]

Configuration options: [Disabled] [Enabled]

### PCI E2 Option Rom [Enabled]

Configuration options: [Disabled] [Enabled]

### PCI E3 Option Rom [Enabled]

Configuration options: [Disabled] [Enabled]

### PCI E4 Option Rom [Enabled]

Configuration options: [Disabled] [Enabled]

### PCI E5 Option Rom [Enabled]

Configuration options: [Disabled] [Enabled]

### PCI E6 Option Rom [Enabled]

Configuration options: [Disabled] [Enabled]

### PCI E7 Option Rom [Enabled]

Configuration options: [Disabled] [Enabled]

### PIKE Option Rom [Enabled]

Configuration options: [Disabled] [Enabled]

## 4.4.7 Intel TXT(LT-SX) Configuration

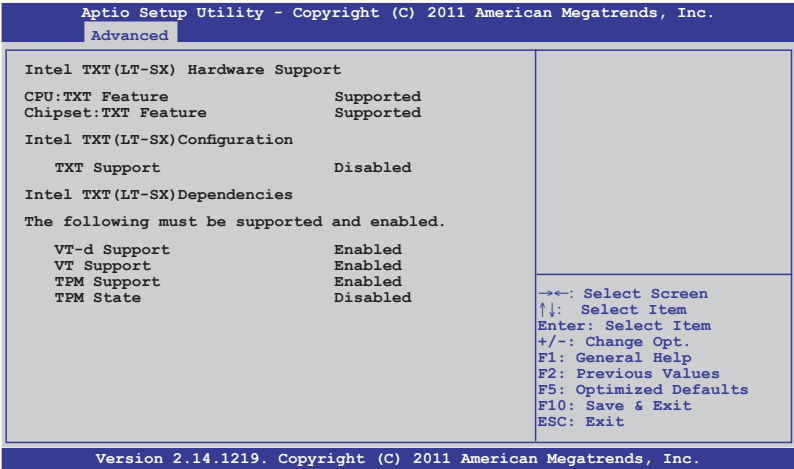

This is the Intel Trusted Execution Technology (TXT) feature. VT and VT-d support must be enabled before using this feature.



Install a Trusted Platform Module (TPM) on the motherboard to enal the Intel® TXT(LT) Hardware Support..

## 4.4.8 USB Configuration

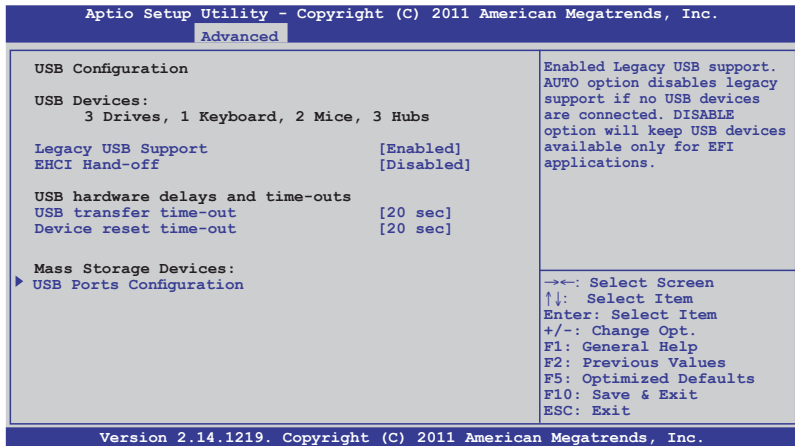

### Legacy USB Support [Enabled]

This item enables or disables Legacy USB device support.

Configuration options: [Enabled] [Disabled] [Auto]

### EHCI Hand-off [Disabled]

This is a workaround for OSes without EHCI ownership change should be claimed by EHCI driver.

Configuration options: [Disabled] [Enabled]

### USB Hardware Delays and Time-outs

#### USB transfer time-out [20 sec]

This item sets the time-out value for control, bulk, and interrupt transfer.

Configuration options: [1 sec] [5 sec] [10 sec] [20 sec]

#### Device reset time-out [20 sec]

USB mass storage device Start Unit command time-out.

Configuration options: [10 sec] [20 sec] [30 sec] [40 sec]

## USB Ports Configuration

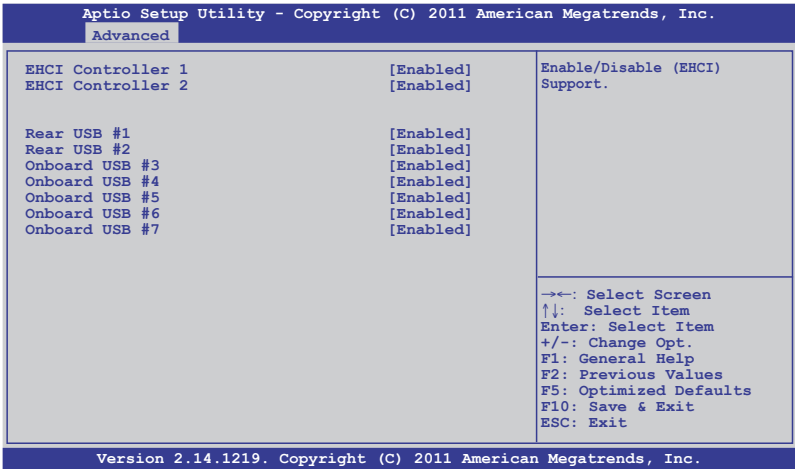

### EHCI Controller 1/2 [Enabled]

Allows you to enable or disable USB 2.0 (EHCI) Support. If we disable the EHCI Controller in BIOS > South Bridge > USB configuration, the USB device will all disable in OS.  
Configuration options: [Disabled] [Enabled]

### Rear USB 1/ 2 [Enabled]

Allows you to enable or disable rear USB ports.  
Configuration options: [Disabled] [Enabled]

### Onboard USB 1/ 2/ 3/ 4/ 5/ 6/ 7 [Enabled]

Allows you to enable or disable onboard USB ports.  
Configuration options: [Disabled] [Enabled]

## 4.4.8 Trusted Computing

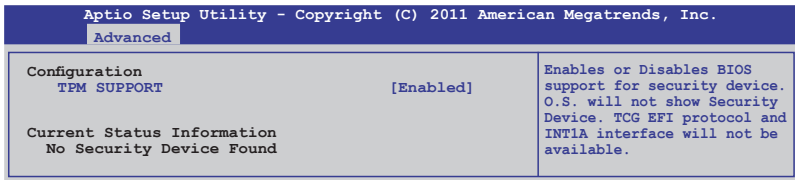

### TPM Support [Enabled]

Allows you to enable or disable the TPM support.  
Configuration options: [Disabled] [Enabled]

## 4.4.9 ACPI Settings

Aptio Setup Utility - Copyright (C) 2011 American Megatrends, Inc.	
Advanced	
<b>ACPI Settings</b>	Enables or Disables BIOS ACPI Auto Configuration.
Enable ACPI Auto Configuration [Disabled]	
Enabled Hibernation [Enabled]	
ACPI Sleep State [S1 (CPU Stop Clock)]	
Lock Legacy Resources [Disabled]	

### Enable ACPI Auto Configuration [Disabled]

Allows you to enable or disable BIOS ACPI Auto Configuration.  
Configuration options: [Disabled] [Enabled]



The following item appears only when you set **Enabled ACPI Auto Configuration** to [Disabled].

### Enable Hibernation [Enabled]

Enables or disables system ability to Hibernate (OS/S4 sleep state). This option may be not effective with some OS.  
Configuration options: [Disabled] [Enabled]

### ACPI Sleep State [S1 (CPU Stop Clock)]

Allows you to set the ACPI Sleep State.  
Configuration options: [Suspend Disabled] [S1 (CPU Stop Clock)] [S3 (Suspend to RAM)]

### Lock Legacy Resources [Disabled]

Allows you to enable or disable Lock Legacy Resources.  
Configuration options: [Disabled] [Enabled]

## 4.4.10 WHEA Configuration

Aptio Setup Utility - Copyright (C) 2011 American Megatrends, Inc.		
Advanced		
WHEA Support	[Enabled]	Enable or disable Windows Hardware Error Architecture.

### WHEA Support [Enabled]

Allows you to enable or disable the Windows Hardware Error Architecture support. Configuration options: [Disabled] [Enabled]

## 4.4.11 APM setting

Aptio Setup Utility - Copyright (C) 2011 American Megatrends, Inc.		
Advanced		
Restore AC Power Loss	[Last State]	Specify what state to go to when power is re-applied after a power failure (G3 state).
Power On By PCIE	[Disabled]	
Power On By Ring	[Disabled]	
Power On By RTC	[Disabled]	

### Restore AC Power Loss [Last State]

When set to [Power Off], the system goes into off state after an AC power loss. When set to [Power On], the system will reboot after an AC power loss. When set to [Last State], the system goes into either off or on state, whatever the system state was before the AC power loss. Configuration options: [Power Off] [Power On] [Last State]

### Power On By PCIE [Disabled]

[Disabled] Disables the PCIE devices from generating a wake event.

[Enabled] Enables the PCIE devices to generate a wake event.

### Power On By Ring [Disabled]

[Disabled] Disables the Ring devices from generating a wake event.

[Enabled] Enables the Ring devices to generate a wake event.

### Power On By RTC [Disabled]

[Disabled] Disables RTC from generating a wake event.

[Enabled] When set to [Enabled], the items **RTC Alarm Date (Days)** and **Hour/Minute/Second** will become user-configurable with set values.



## 4.4.12 Serial Port Console Redirection

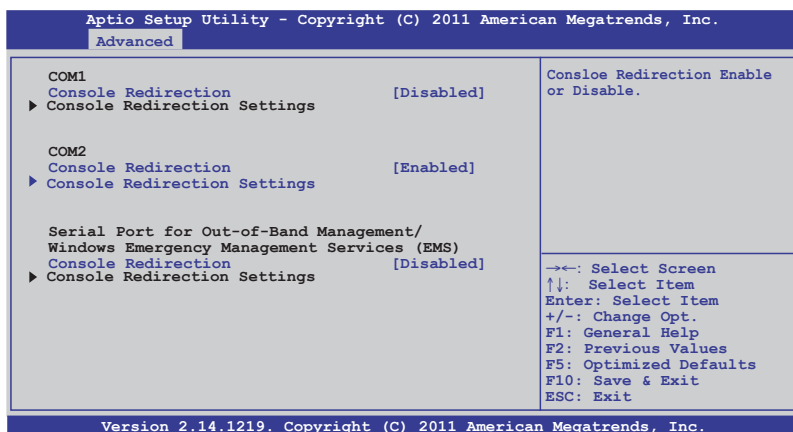

### COM1

#### Console Redirection [Disabled]

Enables or disables the console redirection feature.

Configuration options: [Disabled] [Enabled]



The following item appears only when you set **Console Redirection** to [Enabled].

#### Console Redirection Settings

This item becomes configurable only when you enable the **Console Redirection** item. The settings specify how the host computer and the remote computer (which the user is using) will exchange data. Both computers should have the same or compatible settings.

##### Terminal Type [VT-UTF8]

Allows you to set the terminal type.

[VT100] ASCII char set.

[VT100+] Extends VT100 to support color, function keys, et.

[VT-UTF8] Uses UTF8 encoding to map Unicode chars onto 1 or more bytes

[ANSI] Extended ASCII char set

##### Bits per second [57600]

Selects serial port transmission speed. The speed must be matched on the other side. Long or noisy lines may require lower speeds.

Configuration options: [9600] [19200] [38400] [57600] [115200]

### Data Bits [8]

Configuration options: [7] [8]

### Parity [None]

A parity bit can be sent with the data bits to detect some transmission errors. [Mark] and [Space] parity do not allow for error detection.

[None] No parity bit

[Even] parity bit is 0 if the num of 1's in the data bits is even

[Odd] parity bit is 0 if num of 1's in the data bits is odd

[Mark] parity bit is always 1

[Space] parity bit is always 0

### Stop Bits [1]

Stop bits indicate the end of a serial data packet. (A start bit indicates the beginning.) The standard setting is 1 stop bit. Communication with slow devices may require more than 1 stop bit. Configuration options: [1] [2]

### Flow Control [Hardware RTS/CTS]

Flow control can prevent data loss from buffer overflow. When sending data, if the receiving buffers are full, a "stop" signal can be sent to stop the data flow. Once the buffers are empty, a "start" signal can be sent to re-start the flow. Hardware flow control uses two wires to send start/stop signals.

Configuration options: [None] [Hardware RTS/CTS]

### Recorder Mode [Disabled]

With this mode enabled only text will be sent. This is to capture Terminal data.

Configuration options: [Disabled] [Enabled]

### Legacy OS Redirection Resolution [80x24]

Configures the number of rows and columns supported on legacy OS.

Configuration options: [80x24] [80x25]

## **COM2**

### **Console Redirection [Enabled]**

Enables or disables the console redirection feature.

Configuration options: [Disabled] [Enabled]

### **Console Redirection Settings**

Please refer to the description of the **Console Redirection Settings** item under COM1 for details.

## Serial Port for Out-of-Band Management/ Windows Emergency Management Services (EMS)

### Console Redirection [Disabled]

Enables or disables the console redirection feature.

Configuration options: [Disabled] [Enabled]



---

The following item appears only when you set Console Redirection to [Enabled].

---

### Console Redirection Settings

#### Out-of-Band Mgmt Port [COM1]

Microsoft Windows Emergency Management Services (EMS) allow for remote management of a Windows Server OS through a serial port.

Configuration options: [COM1] [COM2]

#### Terminal Type [VT-UTF8]

Microsoft Windows Emergency Management Services (EMS) allow for remote management of a Windows Server OS through a serial port.

Configuration options: [VT100] [VT100+] [VT-UTF8] [ANSI]

#### Bits per second [115200]

Microsoft Windows Emergency Management Services (EMS) allow for remote management of a Windows Server OS through a serial port.

Configuration options: [9600] [19200] [57600] [115200]

#### Flow Control [None]

Microsoft Windows Emergency Management Services (EMS) allow for remote management of a Windows Server OS through a serial port.

Configuration options: [None] [VT100] [Hardware RTS/CTS] [Software Xon/Xoff]

## 4.4.13 Onboard LAN Configuration

Aptio Setup Utility - Copyright (C) 2011 American Megatrends, Inc.		
Advanced		
Onboard LAN Configuration		Launch INTEL W82574L OpROM
Intel LAN ROM Type	[PXE]	
Intel LAN1 Enable	[Enabled]	
LAN1 Option ROM Support	[Enabled]	
Intel LAN2 Enable	[Enabled]	
LAN2 Option ROM Support	[Enabled]	

### Intel LAN ROM Type [PXE]

This item launches LAN ROM.

Configuration options: [Disabled] [PXE] [iSCSI]

### Intel LAN1 Enable [Enabled]

Enables or disables Intel LAN1 function.

Configuration options: [Disabled] [Enabled]

### LAN1 Option ROM Support [Enabled]

Configuration options: [Disabled] [Enabled]

### Intel LAN2 Enable [Enabled]

Enables or disables Intel LAN2 function.

Configuration options: [Disabled] [Enabled]

### LAN2 Option ROM Support [Enabled]

Configuration options: [Disabled] [Enabled]

## 4.4.14 ME Subsystem

Aptio Setup Utility - Copyright (C) 2011 American Megatrends, Inc.	
Advanced	
Intel ME Subsystem Configuration ME BIOS Interface Version 1.2	ME Subsystem Help.
ME Version 2.1.5.69	
ME FW Status Value : 0xf0345	
ME FW State : SPS ME FW Active	
ME FW Operation State: M0 without UMA	
ME FW Error Code: No Error	
ME Ext FW Status value: 0x3000e301	
BIOS Booting Mode: Performance Optimized	
Cores Disabled: 0	
ME FW SKU Information: SiEn NM	
	→←: Select Screen ↑↓: Select Item Enter: Select Item +/-: Change Opt. F1: General Help F2: Previous Values F5: Optimized Defaults F10: Save & Exit ESC: Exit
Version 2.14.1219. Copyright (C) 2011 American Megatrends, Inc.	

## 4.4.15 Legacy Devices Configuration

Aptio Setup Utility - Copyright (C) 2011 American Megatrends, Inc.	
Advanced	
▶ Serial Port 1 Configuration ▶ Serial Port 2 Configuration	Set Parameters of serial Port 1(COM1).

### Serial Port 1/2 Configuration

Aptio Setup Utility - Copyright (C) 2011 American Megatrends, Inc.	
Advanced	
Serial Port Configuration	Enable or Disable Serial Port(COM).
Serial Port [Enabled]	
Device Settings I0=3F8h; IRQ=4	
Device Mode [Standard Serial Po..]	

#### Serial Port [Enabled]

Allows you to enable or disable the serial port.

Configuration options: [Disabled] [Enabled]

#### Device Mode [Standard Serial Port Mode]

Allows you to change the serial port mode.

Configuration options: [Standard Serial Port Mode]

## 4.4.16 Runtime Error Logging

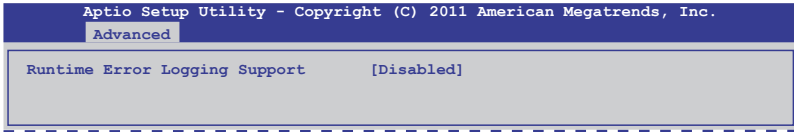

### Runtime Error Logging Support [Disabled]

This item allows you to enable or disable Runtime Error Logging Support.  
Configuration options: [Disabled] [Enabled]



---

The following item appears only when you set **Runtime Error Logging Support** to [Enabled].

---

### PCI Error Logging Support [Disabled]

Allows you to enable or disable PCI Error Logging.  
Configuration options: [Disabled] [Enabled].

## 4.5 Server Mgmt menu

The Server Mgmt menu displays the server management status, and allows you to change the settings.



The Server Mgmt menu appears only when you install ASMB card on the motherboard.

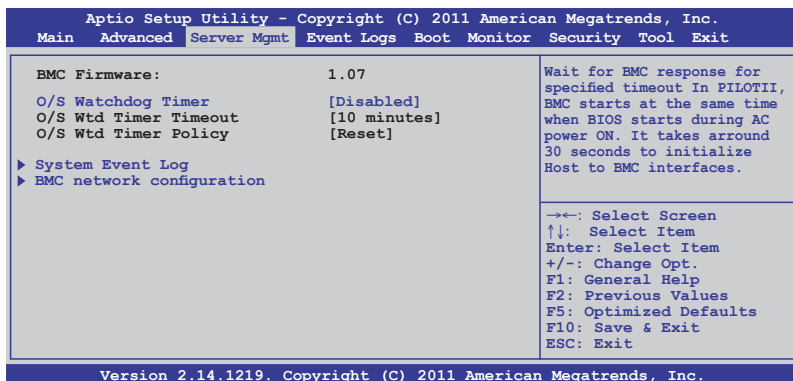

### O/S Watchdog Timer [Disabled]

If enabled, starts a BIOS timer which can only be shut off by Intel Management Software after the OS loads. Helps determine that the OS successfully loaded or follows the **O/S Boot Watchdog Timer Policy**.

Configuration options: [Enabled] [Disabled]

### O/S Wtd Timer Timeout [10 minutes]

Allows you to configure the length of the O/S Boot Watchdog Timer. Not available if **O/S Boot Watchdog Timer** is disabled.

Configuration options: [5 minutes] [10 minutes] [15 minutes] [20 minutes]

### O/S Wtd Timer Policy [Reset]

Allows you to configure how the system should respond if the **OS Boot Watchdog Timer** expires. Not available if **O/S Boot Watchdog Timer** is disabled.

Configuration options: [Do Nothing] [Reset] [Power Down]

## 4.5.1 System Event Log

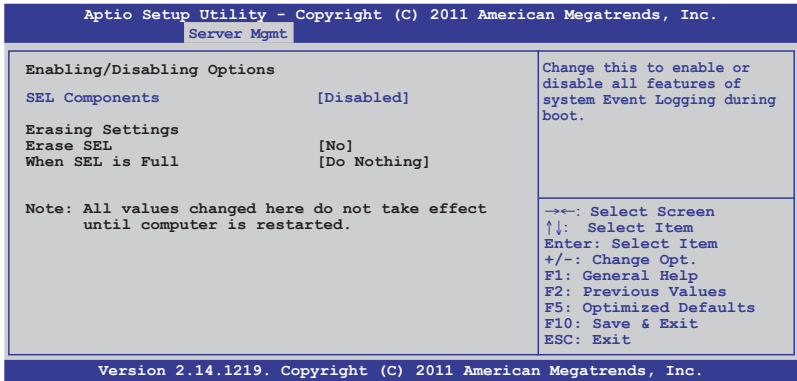

### SEL Components [Disabled]

Allows you to enable or disable all features of system Event Logging during boot.  
Configuration options: [Disabled] [Enabled]



- The following items appears only when you set **SEL Components** to [Enabled].
- All values changed here do not take effect until computer is restarted.

### Erase SEL [No]

Allows you to choose options for erasing SEL.  
Configuration options: [No] [Yes, On next reset] [Yes, On every reset]

### When SEL is Full [Do Nothing]

Allows you to choose options for reactions to a full SEL.  
Configuration options: [Do Nothing] [Erase Immediately]



## 4.5.2 BMC network configuration

Aptio Setup Utility - Copyright (C) 2011 American Megatrends, Inc.	
Server Mgmt	
<b>BMC network configuration</b>	Select to configure LAN channel parameters statically or dynamically (by BIOS or BMC). Unspecified option will not modify any BMC network parameters during BIOS phase
DM_LAN1	
DM_LAN1 IP Address in BMC: 000.000.000.000	
DM_LAN1 Subnet Mask in BMC: 000.000.000.000	
DM_LAN1 Gateway Address in BMC: 000.000.000.000	
DM_LAN1 MAC Address in BMC: 00.E0.18.02.21.DC	
DM_LAN1 Address Source in BMC: DHCP Mode	
Configuration Address source [Previous State]	
Lan1	→←: Select Screen ↑↓: Select Item Enter: Select Item +/-: Change Opt. F1: General Help F2: Previous Values F5: Optimized Defaults F10: Save & Exit ESC: Exit
Lan1 IP Address in BMC: 000.000.000.000	
Lan1 Subnet Mask in BMC: 000.000.000.000	
Lan1 Gateway Address in BMC: 000.000.000.000	
Lan1 MAC Address in BMC: 00.00.00.00.00.00	
Lan1 Address Source in BMC: DHCP Mode	
Configuration Address source [Previous State]	

Version 2.14.1219. Copyright (C) 2011 American Megatrends, Inc.

### Configuration Address source [Previous State]

Select to configure LAN channel parameters statically or dynamically (by BIOS or BMC). Unspecified option will not modify any BMC network parameters during BIOS phase.

Configuration options: [Previous State] [Static Mode] [DHCP Mode]



The following items appear only when you set **Configuration Address source** to [Static Mode].

#### Station IP address [0.0.0.0]

Allows you to key in Station IP address.

#### Subnet mask [0.0.0.0]

Allows you to key in Subnet mask.

#### Gateway IP address [0.0.0.0]

Allows you to key in Gateway IP address.

## 4.6 Event Logs menu

The Event Logs allows you to change or view the event log settings.

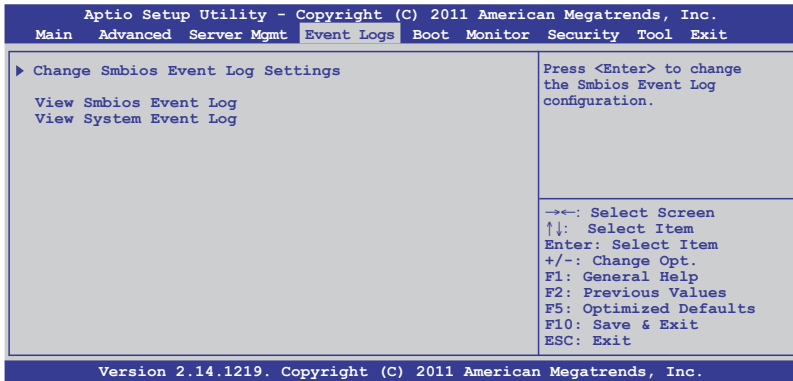

### 4.6.1 Change Smbios Event Log Settings

Press <Enter> to change the Smbios Event Log configuration.

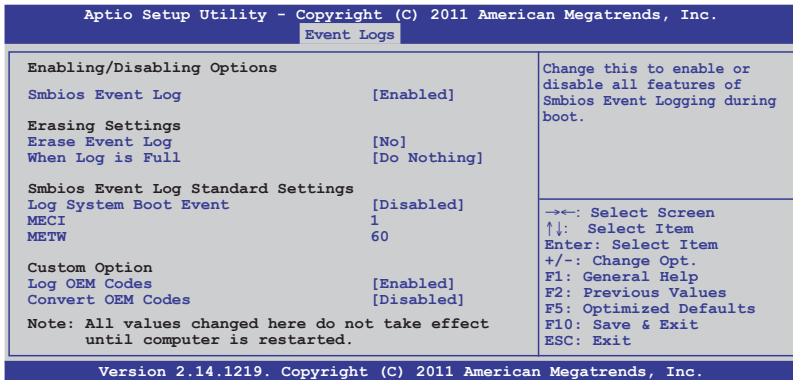

#### Enabling/Disabling Options

#### Smbios Event Log [Enabled]

Change this to enable or disable all features of Smbios Event Logging during boot. Configuration options: [Disabled] [Enabled]

#### Erasing Settings

#### Erase Event Log [No]

Choose the options for erasing Smbios Event Log. Erasing is done prior to any logging activation during reset.

Configuration options: [No] [Yes, Next reset] [Yes, Every reset]

When Log is Full [Do Nothing]

Allows you to choose the options for reactions to a full Smbios Event Log.  
Configuration options: [Do Nothing] [Erase Immediately]

Smbios Event Log Standard Settings

Log System Boot Event [Disabled]

Allows you to choose the options to enable/disable logging of System boot event.

Configuration options: [Enabled] [Disabled]

MECI [1]

Multiple Event Count Increment (MECI). The number of occurrences of a duplicate event that must pass before the multiple-event counter associated with the log entry is updated, specified as a numeric value ranging from 1 to 255.

METW [60]

Multiple Event Time Windows (METW). The number of minutes that must pass between duplicate log entries that utilize a multiple-event counter. The value ranges from 0 to 99 minutes.

Custom Option

Log OEM Codes [Enabled]

Enables or disables the logging of EFI Status Codes as OEM Codes (if not already converted to legacy).

Configuration options: [Disabled] [Enabled]

Convert OEM Codes [Disabled]

Enables or disables the converting of EFI Status Codes to Standard Smbios Types (Not all may be translated).

Configuration options: [Disabled] [Enabled]

## **View Smbios Event Log**

Press <Enter> to view all smbios event logs.

## **View System Event Log**

Press <Enter> to view all system event logs.

## 4.7 Boot menu

The Boot menu items allow you to change the system boot options.

Aptio Setup Utility - Copyright (C) 2011 American Megatrends, Inc.		
Main   Advanced   Server Mgmt   Event Logs   Boot   Monitor   Security   Tool   Exit		
Boot Configuration		Number of seconds to wait for setup activation key. 65535(0xFFFF) means indefinite waiting.
Setup Prompt Timeout	1	
Bootup NumLock State	[On]	
Full Screen Logo	[Enabled]	
CSM16 Module Version	07.68	
GateA20 Active	[Upon Request]	
Option ROM Messages	[Force BIOS]	
Interrupt 19 Capture	[Enabled]	
Boot Device Seeking	[Endless PXE]	
UEFI Boot	[Disabled]	
Boot Option Priorities		→←: Select Screen
Boot Option #1	[SATA P2: ASUS ...]	↑↓: Select Item
Boot Option #2	[SATA P3: WDC WD80...]	Enter: Select Item
Boot Option #3	[AMI Virtual Floppy...]	+/-: Change Opt.
Boot Option #4	[IBA GE Slot 0700 v...]	F1: General Help
CD/DVD ROM Drive BBS Priorities		F2: Previous Values
Floppy Drive BBS Priorities		F5: Optimized Defaults
Network Device BBS Priorities		F10: Save & Exit
		ESC: Exit

Version 2.14.1219. Copyright (C) 2011 American Megatrends, Inc.

### Setup Prompt Timeout [xx]

Use the <+> and <-> keys to adjust the number of seconds to wait for setup activation key.

### Bootup NumLock State [On]

Allows you to select the power-on state for the NumLock.

Configuration options: [Off] [On]

### Full Screen Logo [Enabled]

Allows you to enable or disable the full screen logo display feature.

Configuration options: [Disabled] [Enabled]



Set this item to [Enabled] to use the ASUS MyLogo2™ feature.

### CSM16 Module Version

### GateA20 Active [Upon Request]

[Upon Request] GA20 can be disabled using BIOS services.

[Always] Do not allow disable GA20. This option is useful when any RT code is executed above 1MB.

### Option ROM Messages [Force BIOS]

Allows you to set the display mode for Options ROM.

Configuration options: [Force BIOS] [Keep Current]

## Interrupt 19 Capture [Enabled]

Allows Option ROMs to trap interrupt 19.

Configuration options: [Disabled] [Enabled]

## Boot Device Seeking [Endless PXE]

[Endless PXE] Continuously searches for the remote boot image until it is found or the process is aborted (press Ctrl+Alt+Del).

[Normal] Searches for the remote boot image once, then stops.

## UEFI Boot [Disabled]

Enables or disables UEFI Boot.

Configuration options: [Disabled] [Enabled]

## Boot Option Priorities

These items specify the boot device priority sequence from the available devices.

The number of device items that appears on the screen depends on the number of devices installed in the system.



- 
- To select the boot device during system startup, press <F8> when ASUS Logo appears.
  - To access Windows OS in Safe Mode, please press <F8> after POST.
- 

Set the booting order of network devices.

Boot Option #1/#2/#3/#4 [SATA P2: ASUS ...]

Configuration options: [SATA P2: ASUS ...] [SATA P3: WDC WD80...] [AMI Virtual Floppy...] [IBA GE Slot 0700 v...]

CD/DVD ROM Drive BBS Priorities

Hard Drive BBS Priorities

Floppy Drive BBS Priorities

Network Device BBS Priorities

These items appear only when you connect SATA ODD or hard drive to the SATA ports and allow you to set the booting order of the SATA devices.

## 4.8 Monitor menu

The Monitor menu displays the system temperature/power status, and allows you to change the fan settings.

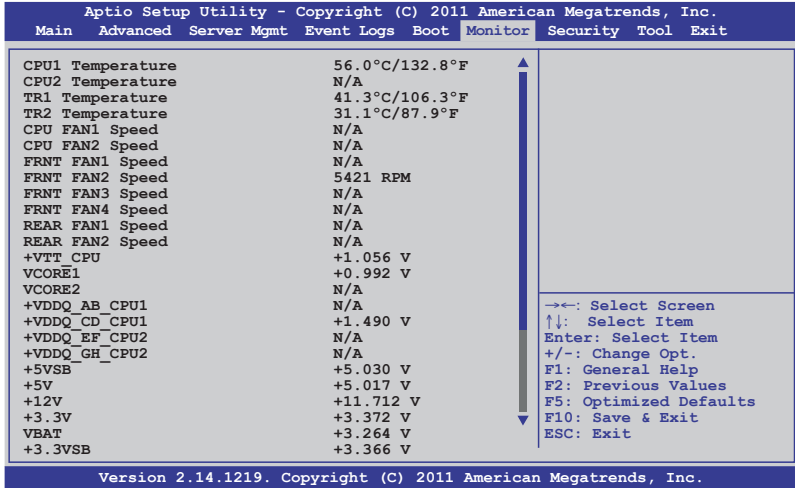

Scroll down to display the following items:

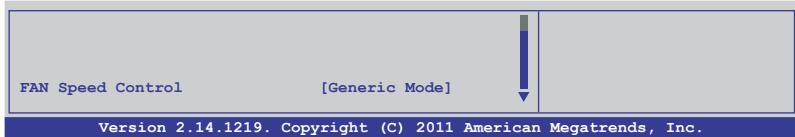

### CPU 1/2; TR1 1/2 Temperature [xxx°C/xxx°F]

The onboard hardware monitor automatically detects and displays the CPU and motherboard component temperatures.

### CPU FAN1/2 Speed; FRNT FAN1–4 Speed; REAR FAN1/2 Speed [xxxx RPM] or [N/A]

The onboard hardware monitor automatically detects and displays the speed of CPU fans, front fans, and rear fan in rotations per minute (RPM). If the fan is not connected to the motherboard, the field shows **N/A**.

### +VTT\_CPU Voltage, VCORE1/2 Voltage, +VDDQ\_AB/CD\_CPU1 Voltage, +VDDQ\_EF/GH\_CPU2 Voltage, +5VSB Voltage, +5V Voltage, +12V Voltage, +3.3V Voltage, VBAT Voltage, +3.3VSB Voltage

The onboard hardware monitor automatically detects the voltage output through the onboard voltage regulators.

## FAN Speed Control [Generic Mode]

Allows you to configure the ASUS Smart Fan feature that smartly adjusts the fan speeds for more efficient system operation.

Configuration options: [Generic Mode] [High Speed Mode] [Full Speed Mode]

## 4.9 Security menu

The Security menu items allow you to change the system security settings.

Aptio Setup Utility - Copyright (C) 2011 American Megatrends, Inc.	
Main Advanced Server Mgmt Event Logs Boot Monitor Security Tool Exit	
<b>Password Description</b>	<b>Set Setup Administrator Password</b>
If ONLY the Administrator's password is set, then this only limits access to Setup and is only asked for when entering Setup	
If ONLY the User's password is set, then this is a power on password and must be entered to boot or enter Setup. In Setup the User will have Administrator rights	
The password length must be in the following range:	
Minimum length	3
Maximum length	20
<b>Administrator Password</b>	
<b>User Password</b>	



If you have forgotten your BIOS password, erase the CMOS Real Time Clock (RTC) RAM to clear the BIOS password. See section 2.6 Jumpers for information on how to erase the RTC RAM.

### Administrator Password

If you have set an administrator password, we recommend that you enter the administrator password for accessing the system. Otherwise, you might be able to see or change only selected fields in the BIOS setup program.

To set an administrator password:

1. Select the **Administrator Password** item and press <Enter>.
2. From the **Create New Password** box, key in a password, then press <Enter>.
3. Confirm the password when prompted.

To change an administrator password:

1. Select the **Administrator Password** item and press <Enter>.
2. From the **Enter Current Password** box, key in the current password, then press <Enter>.
3. From the **Create New Password** box, key in a new password, then press <Enter>.
4. Confirm the password when prompted.

To clear the administrator password, follow the same steps as in changing an administrator password, but press <Enter> when prompted to create/confirm the password.

### User Password

If you have set a user password, you must enter the user password for accessing the system.

To set a user password:

1. Select the **User Password** item and press <Enter>.
2. From the **Create New Password** box, key in a password, then press <Enter>.
3. Confirm the password when prompted.

To change a user password:

1. Select the **User Password** item and press <Enter>.
2. From the **Enter Current Password** box, key in the current password, then press <Enter>.
3. From the **Create New Password** box, key in a new password, then press <Enter>.
4. Confirm the password when prompted.

To clear the user password, follow the same steps as in changing a user password, but press <Enter> when prompted to create/confirm the password.

## 4.10 Tool menu

The Tool menu items allow you to configure options for special functions. Select an item then press <Enter> to display the submenu.

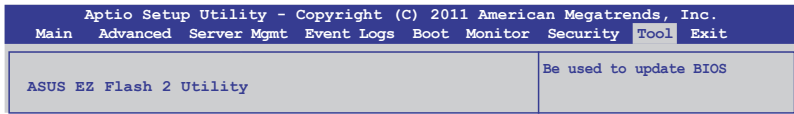

### ASUS EZ Flash 2 Utility

Allows you to run ASUS EZ Flash BIOS ROM Utility when you press <Enter>. Check section **4.1.2 ASUS EZ Flash 2 Utility** for details.



## 4.11 Exit menu

The Exit menu items allow you to save or discard your changes to the BIOS items.

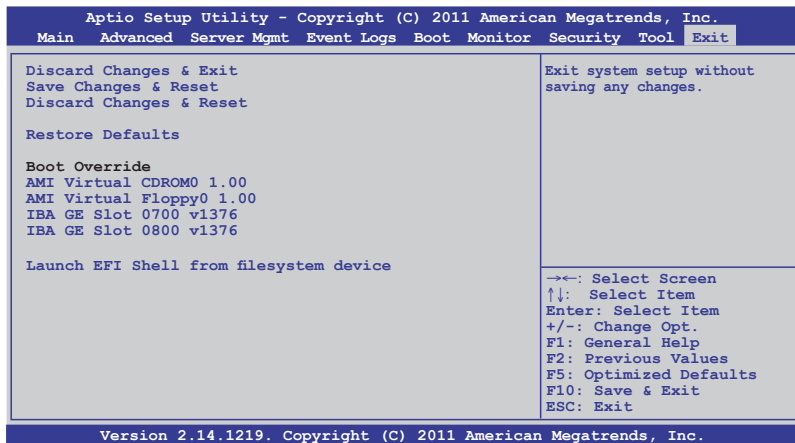

Pressing <Esc> does not immediately exit this menu. Select one of the options from this menu or <F10> from the legend bar to exit.

### Discard Changes & Exit

This option allows you to exit the Setup program without saving your changes. When you select this option or if you press <Esc>, a confirmation window appears. Select **Yes** to discard changes and exit.

### Save Changes & Reset

Once you are finished making your selections, choose this option from the Exit menu to ensure the values you selected are saved. When you select this option or if you press <F10>, a confirmation window appears. Select **Yes** to save changes and exit.

### Discard Changes & Reset

This option allows you to reset the Setup program without saving your changes. When you select this option, a confirmation window appears. Select **Yes** to discard changes and reset.

### Restore Defaults

This option allows you to restore/load defaults values for all the setup options. When you select this option or if you press <F5>, a confirmation window appears. Select **Yes** to load optimized defaults.

## **Boot Override**

These items displays the available devices. The device items that appears on the screen depends on the number of devices installed in the system. Click an item to start booting from the selected device.

## **Launch EFI Shell from filesystem device**

This item is for launching the EFI Shell application from one of the available filesystem devices.

This chapter provides instructions for setting up, creating, and configuring RAID sets using the available utilities.

# 5 RAID configuration

5.1	Setting up RAID.....	5-3
5.2	LSI Software RAID Configuration Utility .....	5-5
5.3	Intel® Rapid Storage Technology enterprise SCU/SATA Option ROM Utility .....	5-25
5.4	Intel® Rapid Storage Technology enterprise Utility (Windows) .....	5-35

## 5.1 Setting up RAID

The motherboard supports the following RAID solutions:

- **LSI MegaRAID software RAID Configuration Utility** with RAID 0, RAID 1, and RAID 10 support (for both Linux and Windows OS).
- **Intel Rapid Storage Technology enterprise SCU / SATA Option ROM Utility** with RAID 0, RAID 1, RAID 10, and RAID 5 support (for Windows OS only).

### 5.1.1 RAID definitions

**RAID 0 (Data striping)** optimizes two identical hard disk drives to read and write data in parallel, interleaved stacks. Two hard disks perform the same work as a single drive but at a sustained data transfer rate, double that of a single disk alone, thus improving data access and storage. Use of two new identical hard disk drives is required for this setup.

**RAID 1 (Data mirroring)** copies and maintains an identical image of data from one drive to a second drive. If one drive fails, the disk array management software directs all applications to the surviving drive as it contains a complete copy of the data in the other drive. This RAID configuration provides data protection and increases fault tolerance to the entire system. Use two new drives or use an existing drive and a new drive for this setup. The new drive must be of the same size or larger than the existing drive.

**RAID 1E (Enhanced RAID 1)** has a striped layout with each stripe unit having a secondary (or alternate) copy stored on a different disk. You can use three or more hard disk drives for this configuration.

**RAID 10** is data striping and data mirroring combined without parity (redundancy data) having to be calculated and written. With the RAID 10 configuration you get all the benefits of both RAID 0 and RAID 1 configurations. Use four new hard disk drives or use an existing drive and three new drives for this setup.

**RAID 5** stripes both data and parity information across three or more hard disk drives. Among the advantages of RAID 5 configuration include better HDD performance, fault tolerance, and higher storage capacity. The RAID 5 configuration is best suited for transaction processing, relational database applications, enterprise resource planning, and other business systems. Use a minimum of three identical hard disk drives for this setup.



- 
- If you want to boot the system from a hard disk drive included in a created RAID set, copy first the RAID driver from the support DVD to a floppy disk before you install an operating system to the selected hard disk drive.
  - Please refer to chapter 2 for how to select the RAID configuration utility. Move the jumper to choose between LSI MegaRAID and Intel® Rapid RAID.
-

## 5.1.2 Installing hard disk drives

The motherboard supports Serial ATA for RAID set configuration. For optimal performance, install identical drives of the same model and capacity when creating a disk array.

To install the SATA hard disks for RAID configuration:

1. Install the SATA hard disks into the drive bays following the instructions in the system user guide.
2. Connect a SATA signal cable to the signal connector at the back of each drive and to the SATA connector on the motherboard.
3. Connect a SATA power cable to the power connector on each drive.

## 5.1.3 Setting the RAID item in BIOS

You must set the RAID item in the BIOS Setup before you can create a RAID set from SATA hard disk drives attached to the SATA connectors supported by Intel® C602 chipset. To do this:

1. Enter the BIOS Setup during POST.
2. Go to the **Advanced Menu > PCH SATA Configuration**, then press <Enter>.
3. Set **SATA Mode** to [RAID Mode]
4. Press <F10> to save your changes and exit the BIOS Setup.



---

Refer to Chapter 4 for details on entering and navigating through the BIOS Setup.

---

## 5.1.4 RAID configuration utilities

Depending on the RAID connectors that you use, you can create a RAID set using the utilities embedded in each RAID controller. For example, use the **LSI Software RAID Configuration Utility** or the **Intel® Rapid Storage Technology** if you installed Serial ATA hard disk drives on the Serial ATA connectors supported by the Intel® C602 chipset.

Refer to the succeeding section for details on how to use the RAID configuration utility.

## 5.2 LSI Software RAID Configuration Utility

The LSI MegaRAID software RAID configuration utility allows you to create RAID 0, RAID 1, or RAID 10 set(s) from SATA hard disk drives connected to the SATA connectors supported by the motherboard southbridge chip.

To enter the LSI MegaRAID software RAID configuration utility:

1. Turn on the system after installing all the SATA hard disk drives.
2. During POST, the LSI MegaRAID software RAID configuration utility automatically detects the installed SATA hard disk drives and displays any existing RAID set(s). Press <Ctrl> + <M> to enter the utility.

```
LSI MegaRAID Software RAID BIOS Version A.10 09231523R
LSI SATA RAID Found at PCI Bus No:00 Dev No:1F
Device present at Port 0      ST3160812AS      152114MB
Device present at Port 1      ST3160812AS      152114MB
Device present at Port 2      ST3160812AS      152114MB
Device present at Port 3      ST3160812AS      152114MB
Press Ctrl-M or Enter to run LSI Software RAID Setup Utility.
```



- The LSI MegaRAID software RAID configuration utility automatically configures to RAID 1 when the SATA to RAID Mode is enabled.
- The RAID setup screens shown in this section are for reference only and may not exactly match the items on your screen due to the controller version difference.
- When you create RAID sets with the LSI MegaRAID software RAID configuration utility, the boot priority of the SATA optical drive has to be manually adjusted. Otherwise, the system will not boot from the connected SATA ODD.

3. The utility main window appears. Use the arrow keys to select an option from the **Management Menu** and then press <Enter>. Refer to the Management Menu descriptions on the next page.

At the bottom of the screen is the legend box. The keys on the legend box allow you to navigate through the setup menu options or execute commands. The keys on the legend box vary according to the menu level.

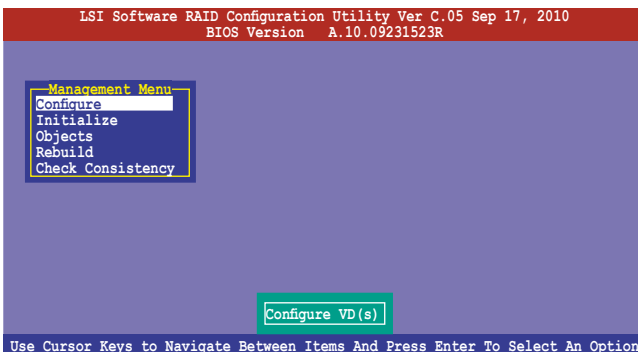

Menu	Description
<b>Configure</b>	Allows you to create RAID 0, RAID 1 or RAID 10 set using the Easy Configuration or the New Configuration command. This menu also allows you to view, add, or clear RAID configurations or select the boot drive
<b>Initialize</b>	Allows you to initialize the virtual drives of a created RAID set
<b>Objects</b>	Allows you to initialize virtual drives or change the virtual drive parameters
<b>Rebuild</b>	Allows you to rebuild failed drives
<b>Check Consistency</b>	Allows you to check the data consistency of the virtual drives of a created RAID set

## 5.2.1 Creating a RAID set

The LSI Software RAID Configuration Utility allows you to create a RAID 0, RAID 1, or RAID 10 set using these two types of configurations:

**Easy Configuration** : In this type, the virtual drive parameters are set automatically.

**New Configuration** : In this type, you manually set the virtual drive parameters.

### Using Easy Configuration

To create a RAID set using the **Easy Configuration** option:

1. From the **Management Menu**, select **Configure > Easy Configuration**, and then press <Enter>.

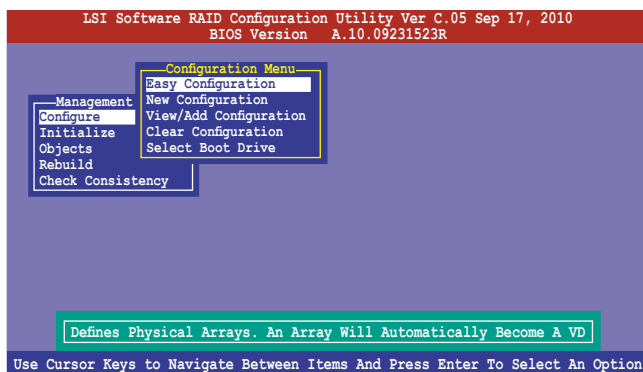



- The **ARRAY SELECTION MENU** displays the available drives connected to the SATA ports. Use the up/down arrow keys to select the drives you want to include in the RAID set, and then press <Space>. When selected, the drive indicator changes from **READY** to **ONLIN A[X]-[Y]**, where X is the array number, and Y is the drive number.

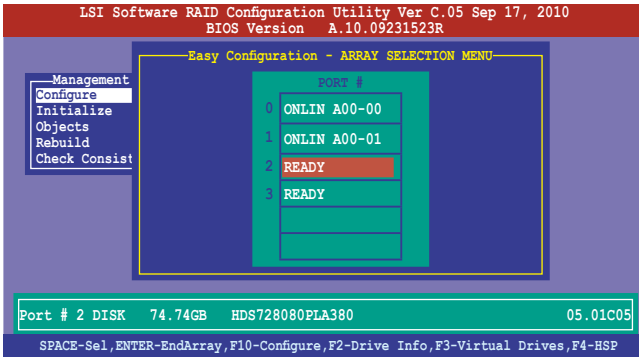

- The information of the selected hard disk drive displays at the bottom of the screen.
- You need at least two identical hard disk drives when creating a RAID 1 set.
- You need at least four identical hard disk drives when creating a RAID 10 set.

- Select all the drives required for the RAID set, and then press <F10> to configure array setting.
- Press <Space> to select the configurable array.

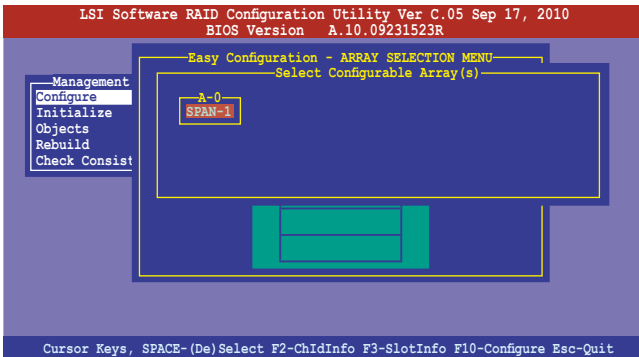

- Press <F10> again, the virtual drive information appears including a **Virtual Drive** menu that allows you to change the virtual drive parameters.

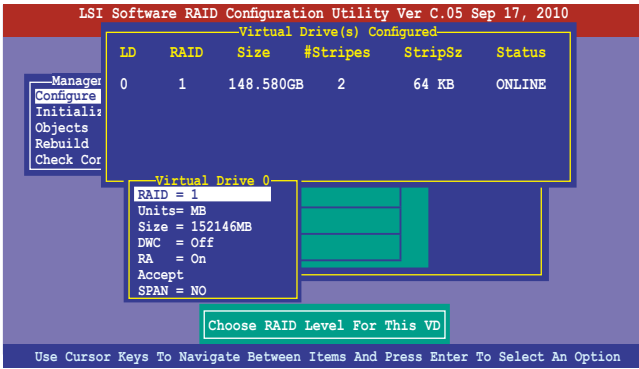

- Select **RAID** from the **Virtual Drive** sub-menu, and then press <Enter>.
- Select the **RAID** level from the menu, and then press <Enter>.

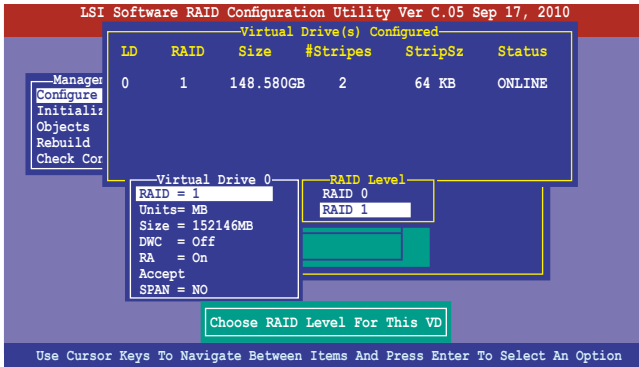

8. Select **Units** from the **Virtual Drive** sub-menu, and then press <Enter>.
9. Select the units for virtual drive size from the menu, and then press <Enter>.

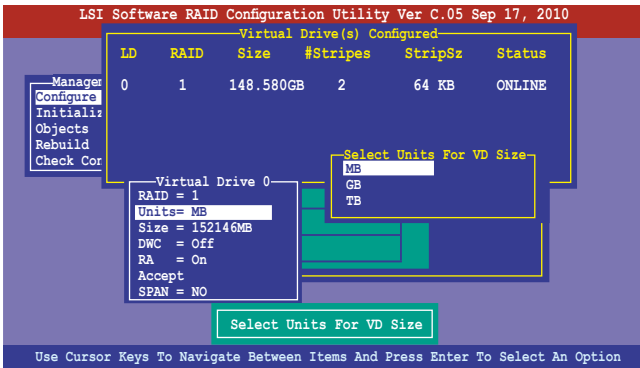

10. When creating a **RAID 1** or a **RAID 10** set, select **DWC** from the **Virtual Drive** menu, and then press <Enter>.  
When creating a **RAID 0** set, proceed to step 12.
11. Select **On** to enable the **Disk Write Cache** setting, and then press <Enter>.

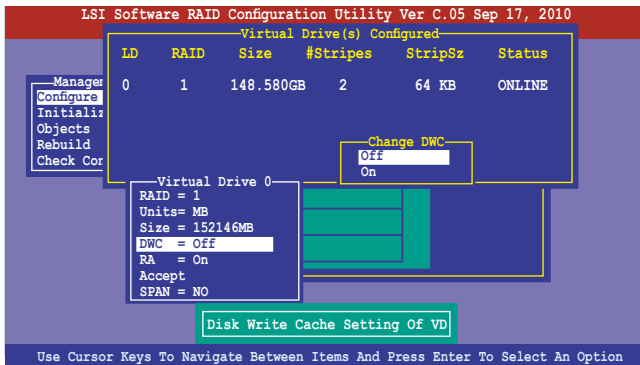

Enabling DWC can improve the performance, but with the risk of data loss.

12. When you have finished configuring the selected virtual drive, select **Accept** from the menu, and then press <Enter>.

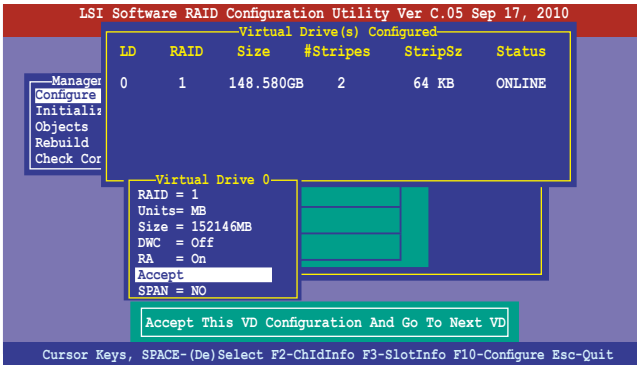

13. Follow step 2 to 12 to configure additional virtual drives.
14. Press <Esc> to finish RAID configuration. When prompted to save configuration, select **Yes** from the menu, and then press <Enter>.

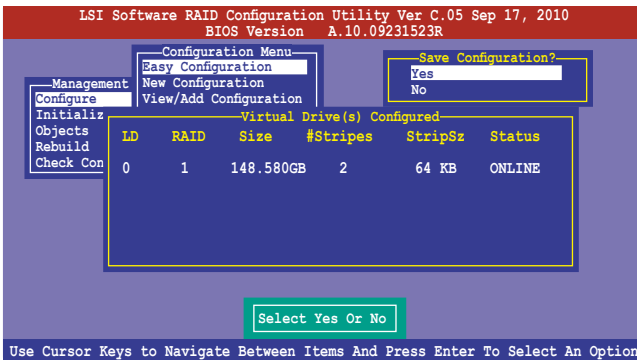

## Using New Configuration



When a RAID set already exists, using the **New Configuration** command erases the existing RAID configuration data. If you do not want to delete the existing RAID set, use the **View/Add Configuration** command to view or create another RAID configuration.

To create a RAID set using the **New Configuration** option

1. From the **Management Menu**, select **Configure > New Configuration**, and then press <Enter>.

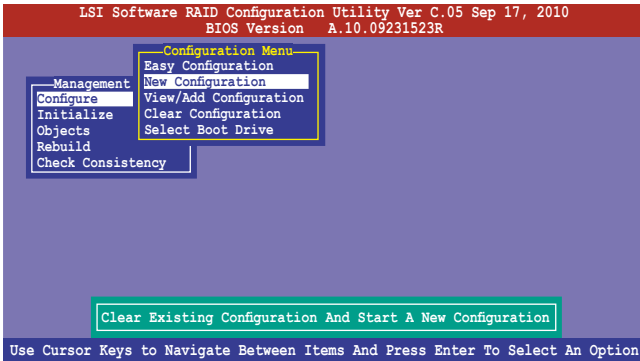

2. Follow steps 2 to 9 of the previous section **Using Easy Configuration**.
3. Select **Size** from the **Virtual Drive** menu, and then press <Enter>.
4. Key in the desired virtual drive size, and then press <Enter>.

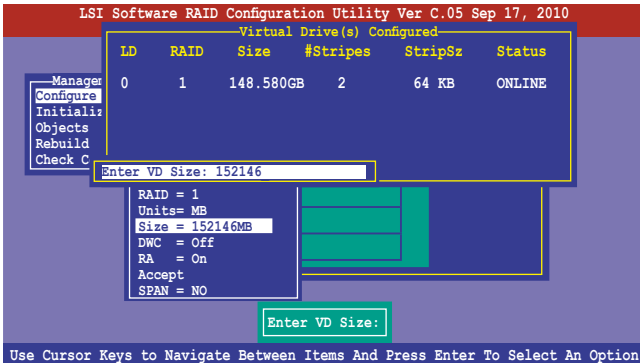

5. Follow steps 10 to 14 of the previous section: **Using Easy Configuration** to create the RAID set.

## 5.2.2 Adding or viewing a RAID configuration

You can add a new RAID configuration or view an existing configuration using the **View/Add Configuration** command.

### Adding a new RAID configuration

To add a new RAID configuration:

1. From the **Management Menu**, select **Configure > View/Add Configuration**, and then press <Enter>.

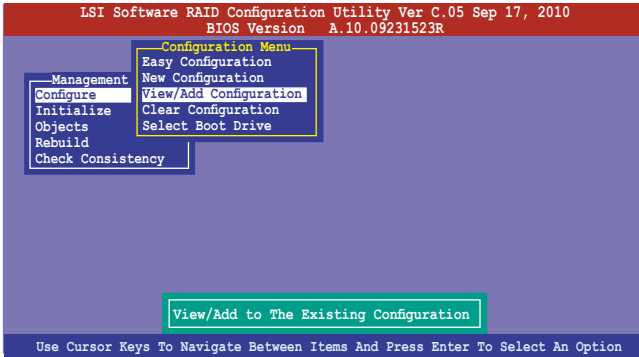

2. The **ARRAY SELECTION MENU** displays the available drives connected to the SATA ports. Select the drives that you want to include in the RAID set, then press <Space>. When selected, the drive indicator changes from **READY** to **ONLIN A[X]-[Y]**, where X is the array number, and Y is the drive number.

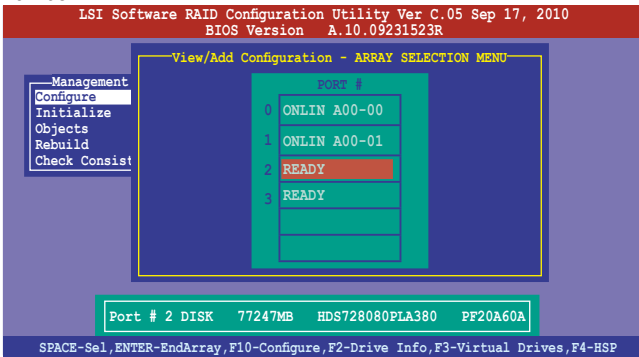

The information of the selected hard disk drive displays at the bottom of the screen.

3. Follow steps 3 to 12 of section **5.2.1 Creating a RAID set: Using Easy Configuration** to add a new RAID set.

## 5.2.3 Initializing the virtual drives

After creating the RAID sets, you must initialize the virtual drives. You may initialize the virtual drives of a RAID sets using the **Initialize** or **Objects** command on the **Management Menu**.

### Using the Initialize command

To initialize the virtual drive using the Initialize command:

1. From the **Management Menu**, select **Initialize**, and then press <Enter>.

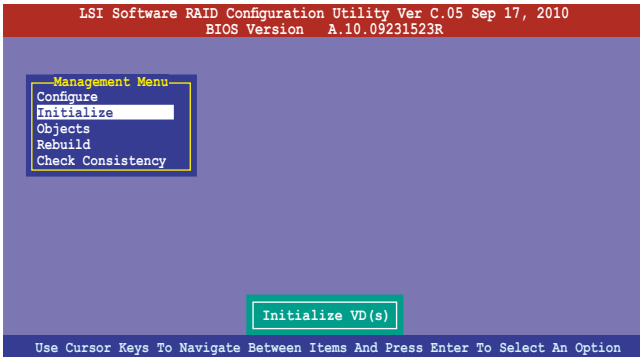

2. The screen displays the available RAID sets and prompts you to select the virtual drive to initialize. Use the arrow keys to select the virtual drive from the **Virtual Drive** selection, and then press <Space>.

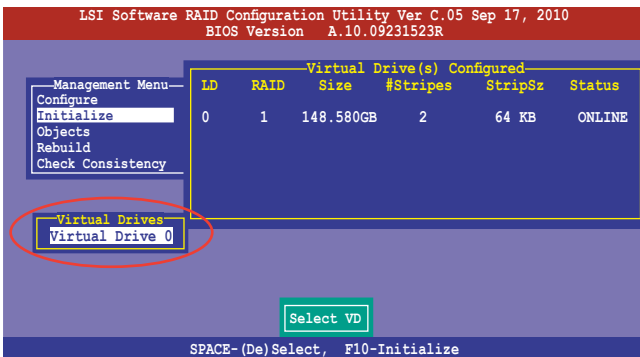

- Press <F10> to start initialization. When prompted, select **Yes** from the **Initialize?** dialog box, and then press <Enter>.

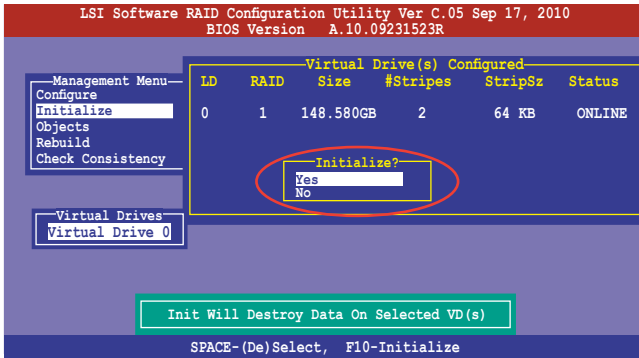

Initializing a virtual drive erases all data on the drive.

- A progress bar appears on screen. If desired, press <Esc> to abort initialization. When initialization is completed, press <Esc>.

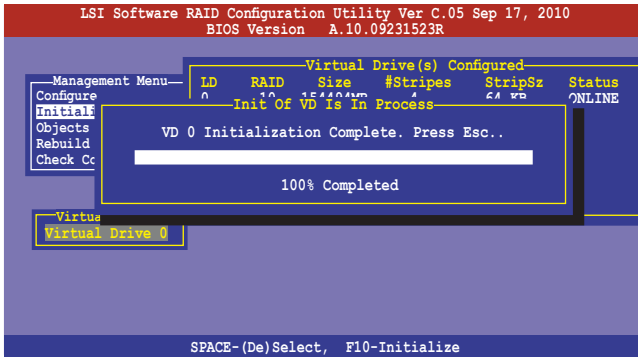



## Using the Objects command

To initialize the virtual drives using the **Objects** command

1. From the **Management Menu**, select **Objects > Virtual Drive**, and then press <Enter>.

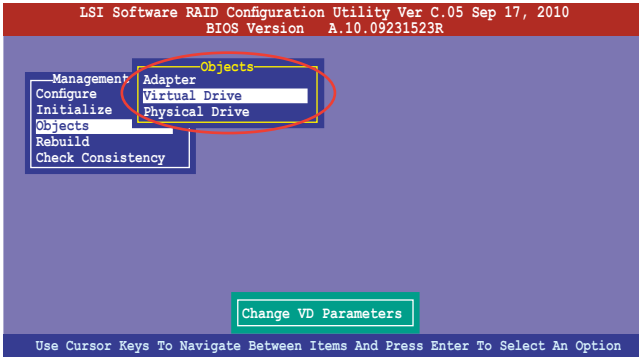

2. Select the virtual drive to initialize from the **Virtual Drives** sub-menu, and then press <Enter>.

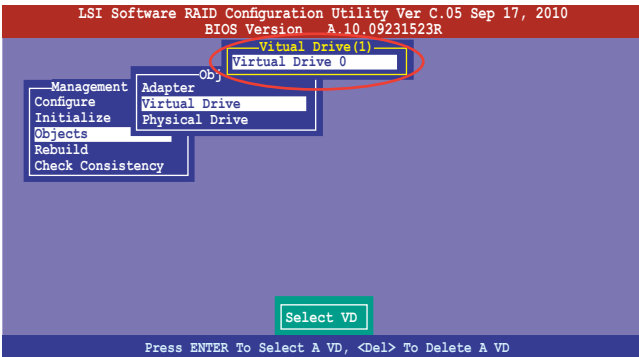

3. Select **Initialize** from the pop-up menu, and then press <Enter> to start initialization.

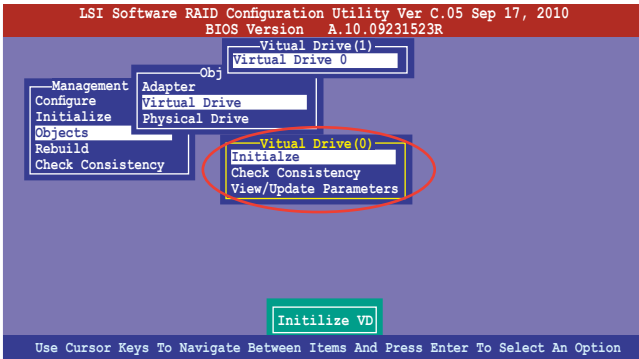

4. When prompted, press the <Space> to select **Yes** from the **Initialize?** dialog box, and then press <Enter>.

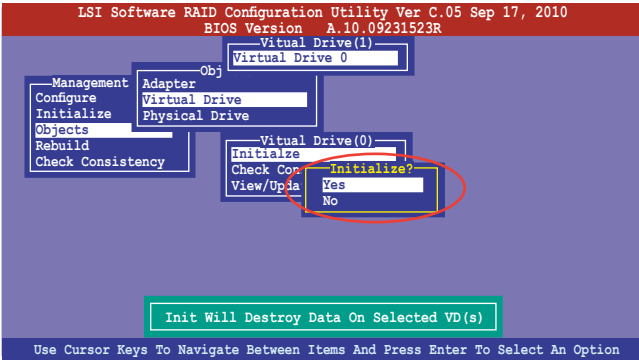

5. A progress bar appears on the screen. If desired, press <Esc> to abort initialization. When initialization is completed, press <Esc>.

## 5.2.4 Rebuilding failed drives

You can manually rebuild failed hard disk drives using the **Rebuild** command in the **Management Menu**.

To rebuild a failed hard disk drive:

1. From the **Management Menu**, select **Rebuild**, and then press <Enter>.

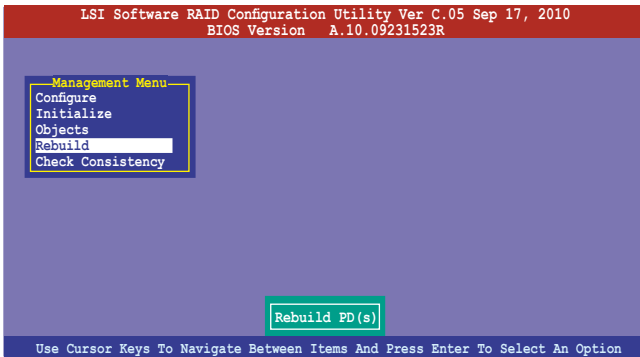

2. The **PHYSICAL DRIVES SELECTION MENU** displays the available drives connected to the SATA ports. Select the drive you want to rebuild, and then press <Space>.

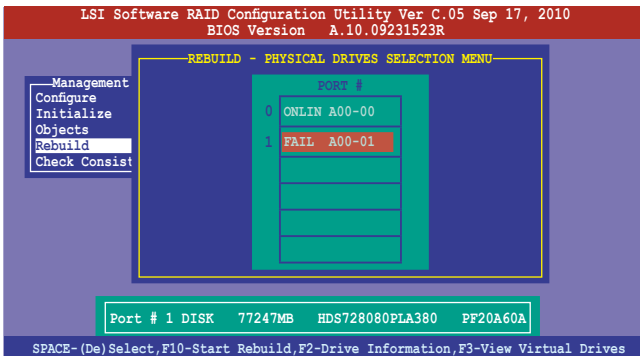

3. After selecting the drive to rebuild, press <F10>. When prompted, press <Y> to rebuild the drive.

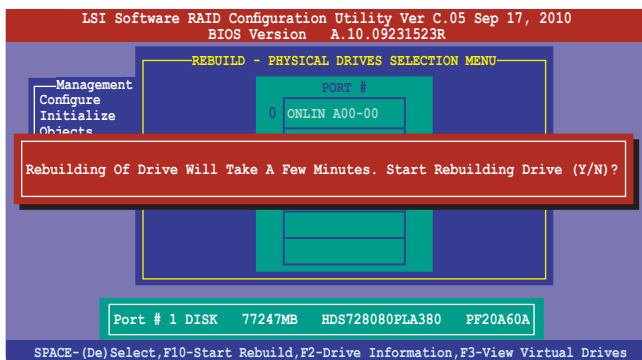

4. When rebuild is complete, press any key to continue.

## 5.2.5 Checking the drives for data consistency

You can check and verify the accuracy of data redundancy in the selected virtual drive. The utility can automatically detect and/or detect and correct any differences in data redundancy depending on the selected option in the **Objects > Adapter** menu.



The **Check Consistency** command is available only for virtual drives included in a RAID 1 or RAID 10 set.

### Using the Check Consistency Command

To check data consistency using the **Check Consistency** command:

1. From the **Management Menu**, select **Check Consistency**, and then press <Enter>.

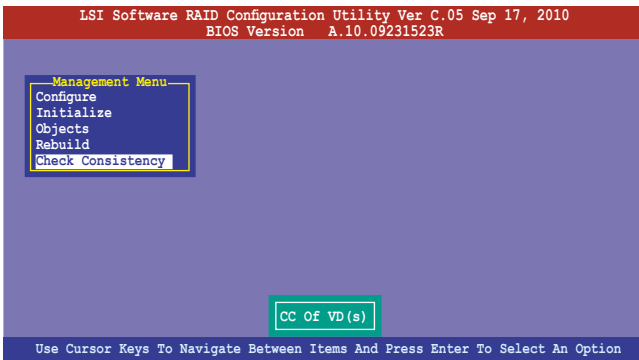

2. The screen displays the available RAID sets and prompts you to select the virtual drive to check. Press <Space> to select the virtual drive from the **Virtual Drive** sub-menu, and then press <F10>.

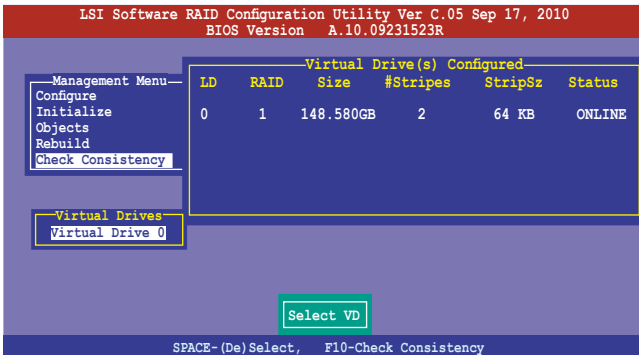

- When prompted, use the arrow keys to select **Yes** from the **Consistency Check?** dialog box, and then press <Enter>.

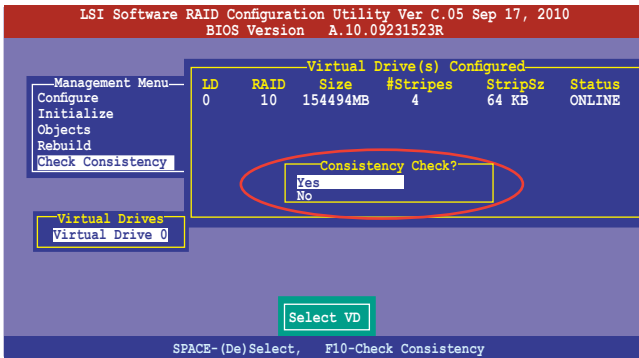

A progress bar appears on the screen.

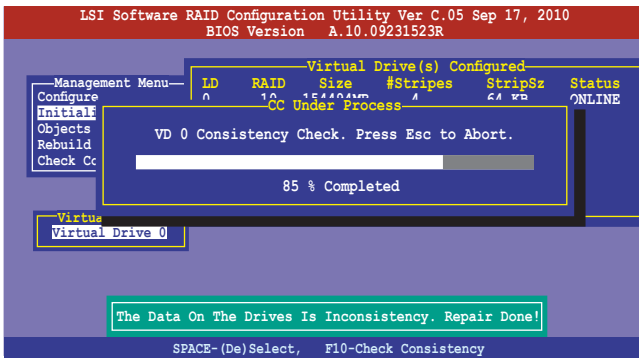

- While checking the disk consistency, press <Esc> to display the following options.
  - Stop** - Stops the consistency check. This utility stores the checked disk percentage, allowing you to resume checking the same disk from the last percentage completed.
  - Continue** - Continues the consistency check.
  - Abort** - Aborts the consistency check. When you resume checking, the process will start over from the beginning.
- When checking is complete, press any key to continue.

## Using the Objects command

To check data consistency using the **Objects** command:

1. From the **Management Menu**, select **Objects**, and then select **Virtual Drive** from the sub-menu.
2. Use the arrow keys to select the virtual drive you want to check, and then press <Enter>.
3. Select **Check Consistency** from the pop-up menu, and then press <Enter>.
4. When prompted, use the arrow keys to select **Yes** from the dialog box to check the drive.
5. When checking is complete, press any key to continue.

## 5.2.6 Deleting a RAID configuration

To delete a RAID configuration

1. From the **Management Menu**, select **Configure > Clear Configuration**, and then press <Enter>.

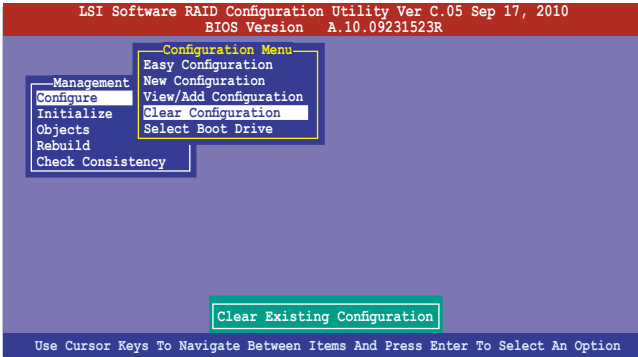

2. When prompted, use the arrow keys to select **Yes** from the **Clear Configuration?** dialog box, and then press <Enter>.

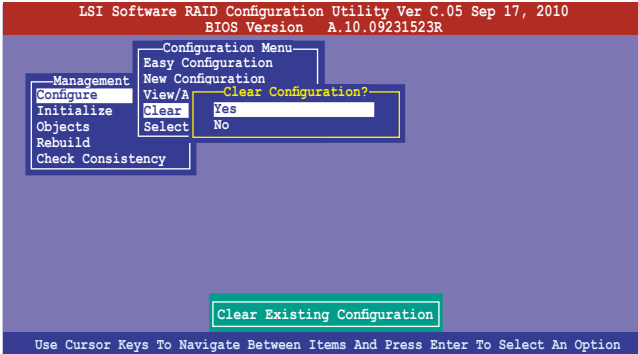

The utility clears all the current array.

3. Press any key to continue.



## 5.2.7 Selecting the boot drive from a RAID set



Create a new RAID configuration before selecting the boot drive from a RAID set. For more details, refer to 5.2.1 Creating a RAID set: Using New Configuration.

To select the boot drive from a RAID set:

1. From the **Management Menu**, select **Configure > Select Boot Drive**, and then press <Enter>.

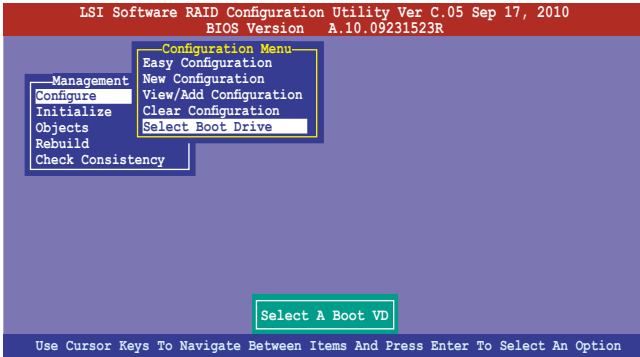

2. When prompted, use the arrow keys to select the bootable virtual drive from the list, then press <Enter>.

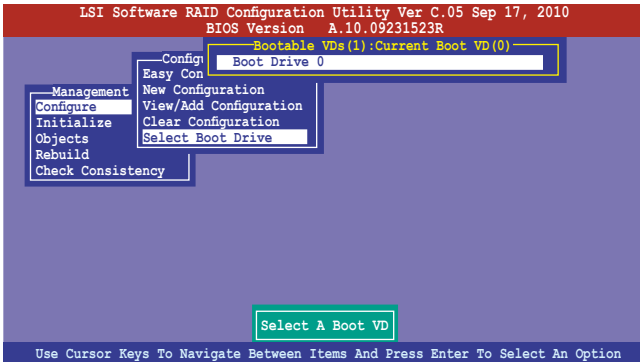

3. The virtual drive is selected as boot drive. Press any key to continue.

## 5.2.8 Enabling WriteCache

You may manually enable the RAID controller's WriteCache option after creating a RAID set to improve the data transmission performance.



When you enable WriteCache, you may lose data when a power interruption occurs while transmitting or exchanging data among the drives.

The WriteCache function is recommended for RAID 1 and RAID 10 sets.

To enable WriteCache:

1. From the **Management Menu**, select **Objects > Adapter**, select an existing adapter, and then press <Enter> to display the adapter properties.
2. Select **Disk WC**, and then press <Enter> to turn on the option.

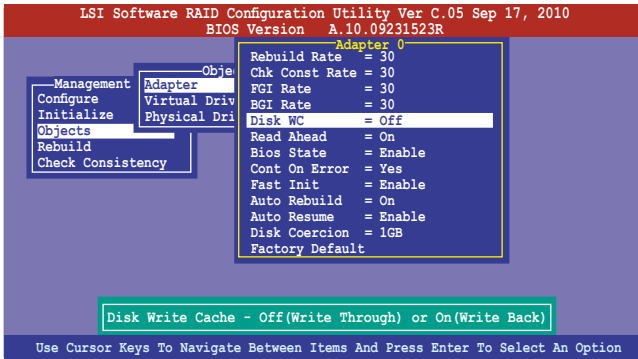

3. From the **Management Menu**, select **Objects > Virtual Drive**, select an existing adapter and press <Enter>. Select **View/Update Parameters** and press <Enter> to display the adapter properties.
4. Select **Disk WC**, and then press <Enter> to turn on the option.

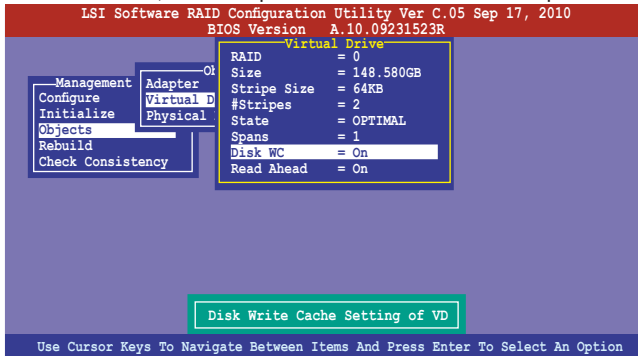

5. When finished, press any key to continue.

## 5.3 Intel® Rapid Storage Technology enterprise SCU/SATA Option ROM Utility

The Intel® Rapid Storage Technology enterprise SCU / SATA Option ROM utility allows you to create RAID 0, RAID 1, RAID 10 (RAID 1+0), and RAID 5 sets from Serial ATA hard disk drives that are connected to the Serial ATA connectors supported by the Southbridge.

### To use onboard SATA ports:

1. Install all the Serial ATA hard disk drives.
2. Turning on the system. During POST, press <Del>. to enter BIOS. Go to **Advanced Menu > PCH SATA Configuration > SATA Mode**, then press <Enter>.
3. Set **SATA Mode** to **RAID Mode** and save, then reboot system.
4. During POST, press <Ctrl+I> to display the utility main menu.

### To use SCU SATA ports:

1. Install all the SATA hard disk drives.
2. Confirm all the SATA hard disk drives you installed are correctly displayed, then reboot system.
3. During POST, press <Ctrl+I> to display the utility main menu.

To enter the Intel® Rapid Storage Technology enterprise SCU/SATA Option ROM utility:

1. Install all the Serial ATA hard disk drives.
2. Turn on the system.
3. During POST, press <Ctrl+I> to display the utility main menu.

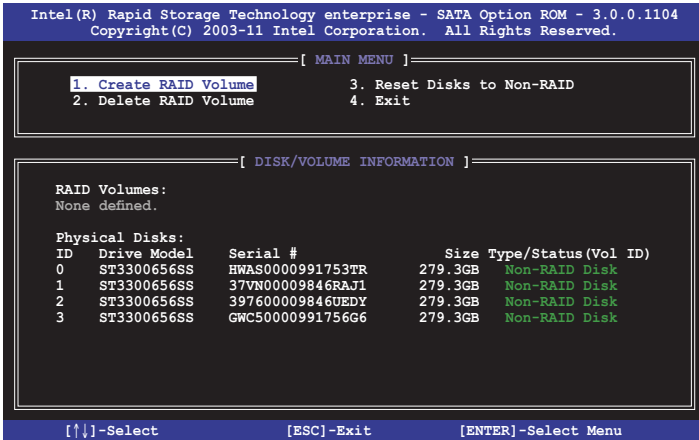

The navigation keys at the bottom of the screen allow you to move through the menus and select the menu options.



---

The RAID BIOS setup screens shown in this section are for reference only and may not exactly match the items on your screen.

---



---

The utility supports maximum four hard disk drives for RAID configuration.

---

### 5.3.1 Creating a RAID set

To create a RAID set

1. From the utility main menu, select **1. Create RAID Volume** and press <Enter>. The following screen appears.

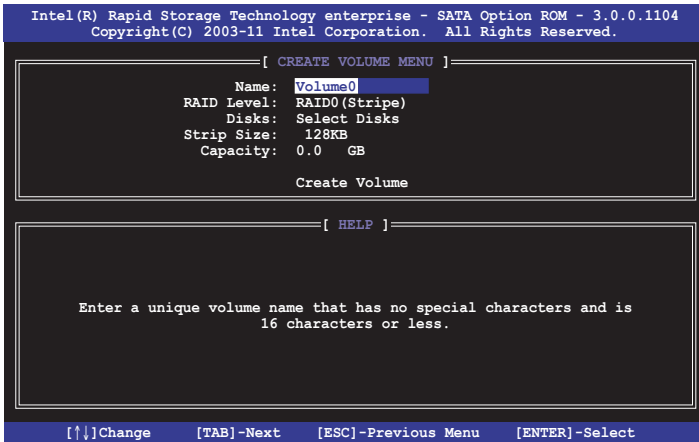

2. Enter a name for the RAID set and press <Enter>.
3. When the **RAID Level** item is selected, press the up/down arrow key to select a RAID level to create, and then press <Enter>.
4. When the **Disks** item is selected, press <Enter> to select the hard disk drives you want to include in the RAID set. The **SELECT DISKS** screen appears.

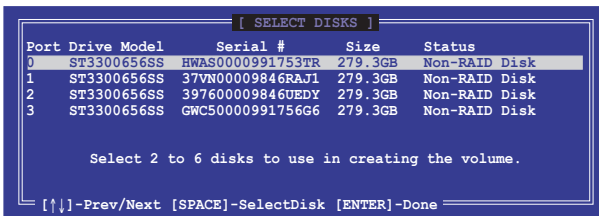

5. Use the up/down arrow key to select a drive, and then press <Space> to select. A small triangle marks the selected drive. Press <Enter> after completing your selection.

- Use the up/down arrow keys to select the stripe size for the RAID array (for RAID 0, 10 and 5 only), and then press <Enter>. The available stripe size values range from 4 KB to 128 KB. The following are typical values:  
RAID 0: 128KB  
RAID 10: 64KB  
RAID 5: 64KB



We recommend a lower stripe size for server systems, and a higher stripe size for multimedia computer systems used mainly for audio and video editing.

- When the **Capacity** item is selected, enter the RAID volume capacity that you want and press <Enter>. The default value indicates the maximum allowed capacity.
- When the **Create Volume** item is selected, press <Enter>. The following warning message appears.



- Press <Y> to create the RAID volume and return to the main menu, or <N> to go back to the **CREATE VOLUME** menu.

### 5.3.2 Creating a Recovery set

To create a recovery set:

- From the utility main menu, select **1. Create RAID Volume** and press <Enter>. The following screen appears.

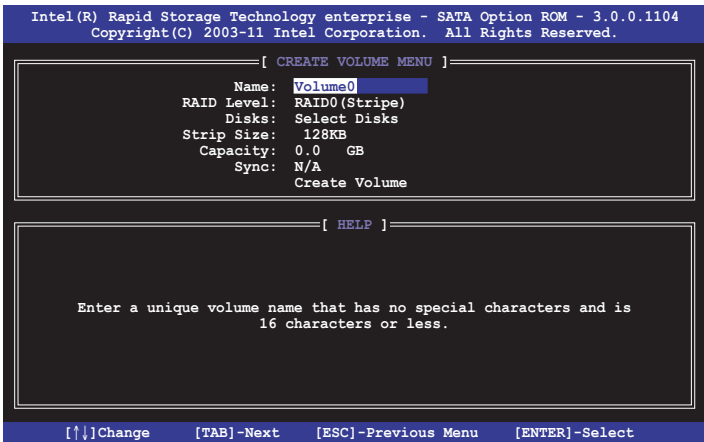

2. Enter a name for the recovery set and press <Enter>.
3. When the **RAID Level** item is selected, press the up/down arrow keys to select **Recovery**, and then press <Enter>.
4. When the **Disks** item is selected, press <Enter> to select the hard disk drives you want to include in the recovery set. The **SELECT DISKS** screen appears.



5. Use the up/down arrow keys to select a drive, press <TAB> to select a Master disk, and then press <SPACE> to select a Recovery disk. A small triangle marks the selected drive. Press <Enter> after completing your selection.
6. When the **Sync** item is selected, use the up/down arrow keys to select a sync option that you want and press <Enter>.
7. When the **Create Volume** item is selected, press <Enter>. The following warning message appears.



8. Press <Y> to create the recovery set and return to the main menu, or <N> to go back to the **CREATE VOLUME** menu.



If a recovery set is created, you cannot add more RAID sets even when you have more non-RAID disks installed in your system.

### 5.3.3 Deleting a RAID set



Be cautious when deleting a RAID set. You will lose all data on the hard disk drives when you delete a RAID set.

To delete a RAID set:

1. From the utility main menu, select **2. Delete RAID Volume** and press <Enter>. The following screen appears.

```
Intel(R) Rapid Storage Technology enterprise - SATA Option ROM - 3.0.0.1104
Copyright(C) 2003-11 Intel Corporation. All Rights Reserved.

[ DELETE VOLUME MENU ]

Name      Level      Drives  Capacity  Status  Bootable
Volume0   RAID0(Stripe)  2       298.0GB  Normal  Yes

[ HELP ]

Deleting a volume will reset the disks to non-RAID.
WARNING: ALL DISK DATA WILL BE DELETED.
(This does not apply to Recovery volumes)

[↑↓]-Select      [ESC]-Previous Menu  [DEL]-Delete Volume
```

2. Use the up/down arrow keys to select the RAID set you want to delete, and then press <Del>. The following warning message appears.

```
[ DELETE VOLUME VERIFICATION ]

ALL DATA IN THE VOLUME WILL BE LOST!
(This does not apply to Recovery volumes)

Are you sure you want to delete volume "Volume0"? (Y/N) :
```

3. Press <Y> to delete the RAID set and return to the utility main menu, or press <N> to return to the **DELETE VOLUME** menu.



## 5.3.4 Resetting disks to Non-RAID



Be cautious before you reset a RAID volume hard disk drive to non-RAID. Resetting a RAID volume hard disk drive deletes all internal RAID structure on the drive.

To reset a RAID set hard disk drive:

1. From the utility main menu, select **3. Reset Disks to Non-RAID** and press <Enter>. The following screen appears.

```
[ RESET RAID DATA ]

Resetting RAID disk will remove its RAID structures
and revert it to a non-RAID disk.

WARNING: Resetting a disk causes all data on the disk to be lost.
(This does not apply to Recovery volumes)

Port Drive Model      Serial #              Size   Status
0  ST3300656SS        HWAS0000991753TR   279.3GB Member Disk
1  ST3300656SS        37VN00009846RAJ1   279.3GB Member Disk

Select the disks that should be reset.

[↑↓]-Previous/Next [SPACE]-Selects [ENTER]-Selection Complete
```

2. Use the up/down arrow keys to select the RAID set drive(s) you want to reset, and then press <Space> to select.
3. Press <Enter> to reset the RAID set drives. A confirmation message appears.
4. Press <Y> to reset the drive(s) or press <N> to return to the utility main menu.

### 5.3.5 Exiting the Intel® Rapid Storage Technology utility

To exit the utility:

1. From the utility main menu, select **4. Exit**, and then press <Enter>. The following warning message appears.

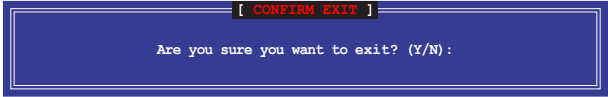

2. Press <Y> to exit or press <N> to return to the utility main menu.

### 5.3.6 Rebuilding the RAID



---

This option is only for the RAID 1 set.

---

#### Rebuilding the RAID with other non-RAID disk

If any of the SATA hard disk drives included in the RAID 1 array failed, the system displays the status of the RAID volume as “**Degraded**” during POST. You can rebuild the RAID array with other installed non-RAID disks.

To rebuild the RAID with other non-RAID disk:

1. At the prompt, press <Ctrl> + <I> to enter the Intel Rapid Storage Technology option ROM utility.
2. If there is a non-RAID SATA Hard Disk available, the utility will prompt to rebuild the RAID. Press <Enter>, and then use up/down arrow keys to select the destination disk or press <ESC> to exit.

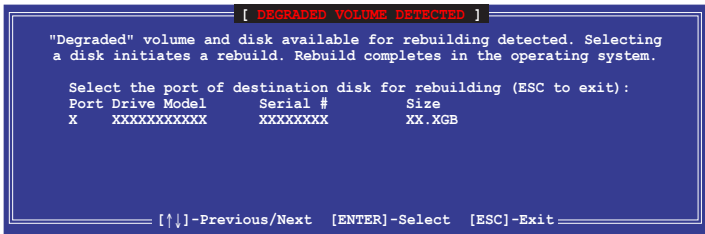

---

Select a destination disk with the same size as the original hard disk.

---

- The utility immediately starts rebuilding after the disk is selected. The status of the degraded RAID volume is changed to **“Rebuild”**.

```

Intel(R) Rapid Storage Technology enterprise - SATA Option ROM - 3.0.0.1104
Copyright(C) 2003-11 Intel Corporation. All Rights Reserved.

[ MAIN MENU ]
1. Create RAID Volume
2. Delete RAID Volume
3. Reset Disks to Non-RAID
4. Exit

[ DISK/VOLUME INFORMATION ]

RAID Volumes:
ID Name Level Strip Size Status Bootable
0 Volume0 RAID1 (Mirror) N/A 149.0GB Rebuild Yes
* = Data is Encrypted

Physical Devices:
Port Drive Model Serial # Size Type/Status (Vol ID)
1 ST3160812AS 9LS0F4HL 149.0GB Member Disk (0)
2 ST3160812AS 3LS0JYL8 149.0GB Member Disk (0)

Volumes with "Rebuild" status will be rebuilt within the operating system.

[↑↓]-Select [ESC]-Exit [ENTER]-Select Menu

```

- Exit Intel Rapid Storage Technology and reboot the system.
- Under Microsoft® Windows OS, select **Start > Programs > Intel Rapid Storage > Intel Rapid Storage Console** or click the **Intel Rapid Storage Technology** tray icon to load the Intel Rapid Storage Manager utility.
- From the **View** menu, select **Advanced Mode** to display the details of the Intel Rapid Storage Console.
- From the **Volumes view** option, select **RAID volume** to view the rebuilding status. When finished, the status is changed to **“Normal”**.

### Rebuilding the RAID with a new hard disk

If any of the SATA hard disk drives included in the RAID array failed, the system displays the status of the RAID volume as **“Degraded”** during POST. You may replace the disk drive and rebuild the RAID array.

To rebuild the RAID with a new hard disk:

- Remove the failed SATA hard disk and install a new SATA hard disk of the same specification into the same SATA Port.



---

Select a destination disk with the same size as the original hard disk.

---

- Reboot the system and then follow the steps in section **Rebuilding the RAID with other non-RAID disk**.

### 5.3.7 Setting the Boot array in the BIOS Setup Utility

You can set the boot priority sequence in the BIOS for your RAID arrays when creating multi-RAID using the Intel® Rapid Storage Technology.

To set the boot array in the BIOS:



---

To be able to boot from the hard disk, create at least one bootable array.

---

1. Reboot the system and press <Del> to enter the BIOS setup utility during POST.
2. Go to the **Boot** menu and select the boot option priority.
3. Use up/down arrow keys to select the boot priority and press <Enter>. See section **4.7 Boot menu** for details.
4. From the **Exit** menu, select **Save Changes & Exit**, then press <Enter>.
5. When the confirmation window appears, select **Yes**, then press <Enter>.

## 5.4 Intel® Rapid Storage Technology enterprise Utility (Windows)

The Intel® Rapid Storage Technology enterprise utility allows you to create RAID 0, RAID 1, RAID 10 (RAID 1+0), and RAID 5 set(s) from Serial ATA hard disk drives that are connected to the Serial ATA connectors supported by the Southbridge.



You need to manually install the Intel® Rapid Storage Technology enterprise utility on a Windows® operating system. Please refer to the installation instructions in Chapter 6.

To enter the Intel® Rapid Storage Technology enterprise utility under Windows operating system:

1. Turn on the system to windows desktop.
2. Click the **Intel® Rapid Storage Technology enterprise** icon to display the main menu.

Your storage system is configured for data protection, increased performance and optimal data storage capacity. You can create additional volumes to further optimize your storage system.

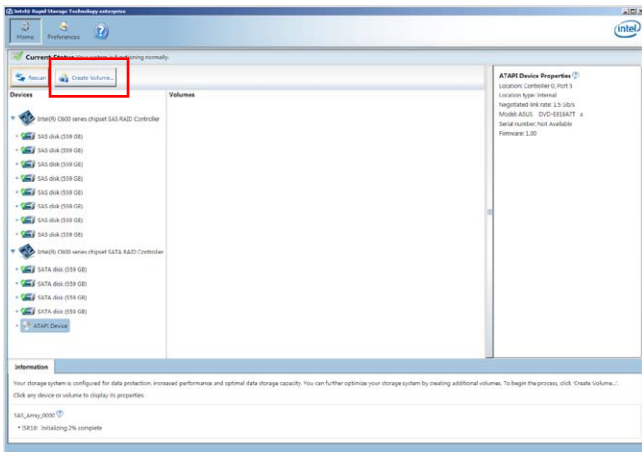

You can click **Rescan** to re-scan any attached hard disks.

# 5.4.1 Creating a RAID set

To create a RAID set:

1. From the utility main menu, select **Create Volume** and select volume type.
2. Click **Next**.

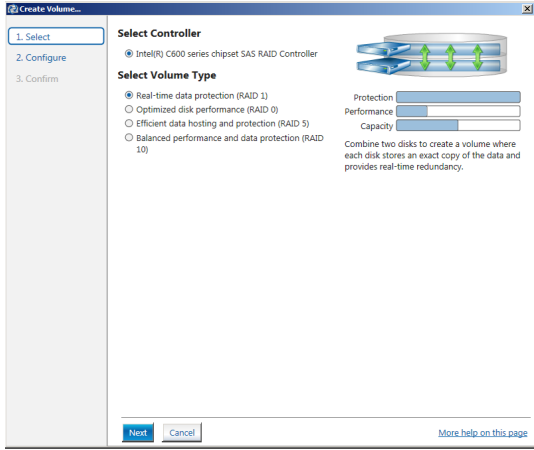

3. Enter a name for the RAID set, then select the array disks.
4. Select **Volume Size** tab, you can drag the bar to decide the volume size.
5. Click **Next**.

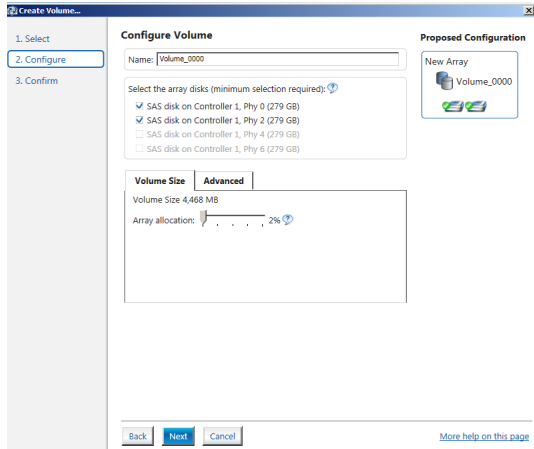

- If you do not want to keep the data on one of the selected disks, select **NO** when prompted.
- If you want to **Enable volume write-back cache** or **Initialize volume**, click **Advanced**.

6. Confirm the volume creation, then click **Create Volume** to continue.



This process could take a while depending on the number and size of the disks. You can continue using other applications during this time.

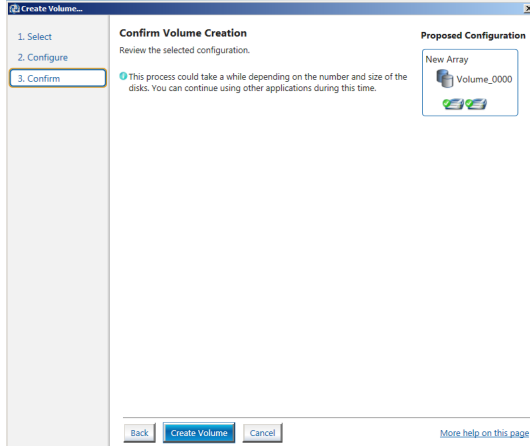

7. Wait until the process is completed, then click **OK** when prompted.

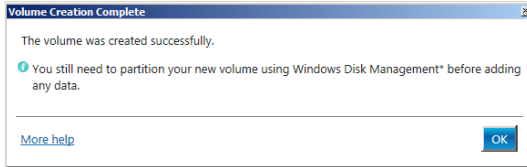

You still need to partition your new volume using Windows Disk Management before adding any data.

The RAID set is displayed in the **Volumes** list and you can change the settings in **Volume Properties**.

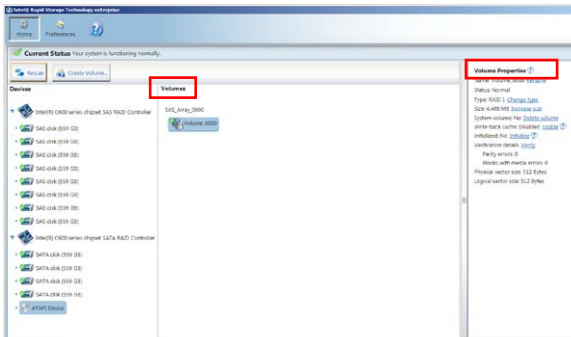

## 5.4.2 Changing a Volume Type

To change the volume type in **Volume Properties**:

1. Click the SATA array items you want to change in **Volumes** field.
2. From the **Volume Properties** field, select **Type:RAID 1 Change type**.

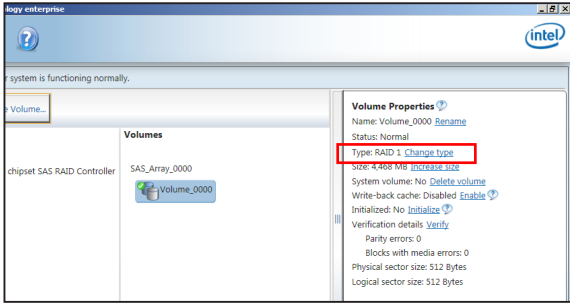

3. You can change the **Name**, **Select the new volume type**, and **Select additional disks to include in the new volume** if needed.
4. Select the **Data stripe size** for the RAID array (for RAID 0, 10 and 5 only), and click **OK**. The available stripe size values range from 4 KB to 128 KB. The following are typical values:  
RAID 0: 128KB  
RAID 10: 64KB  
RAID 5: 64KB

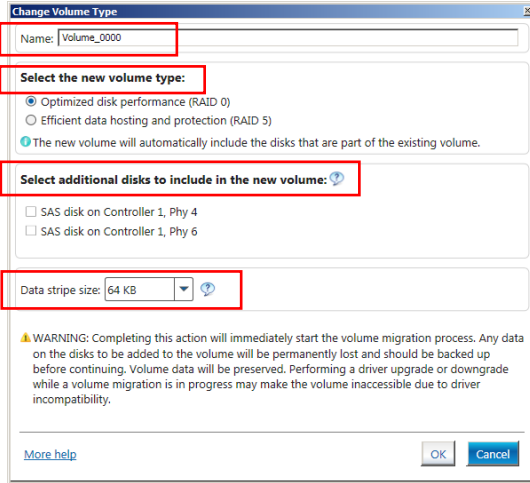

We recommend a lower stripe size for server systems, and a higher stripe size for multimedia computer systems used mainly for audio and video editing.



## 5.4.3 Deleting a volume



Be cautious when deleting a volume. You will lose all data on the hard disk drives. Before you proceed, ensure that you back up all your important data from your hard drives.

To delete a volume:

1. From the utility main menu, select the volume (exp. Volume\_0000) in **Volumes** field you want to delete.

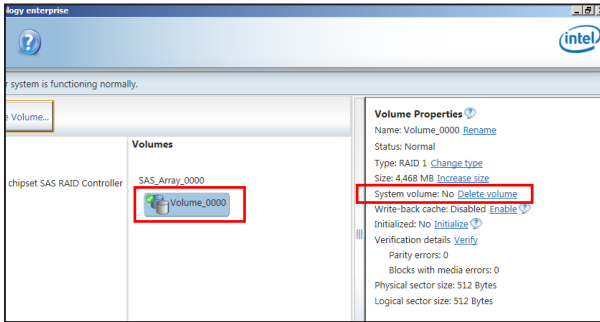

2. Select **Delete volume** in **Volume Properties** field. The following screen appears.

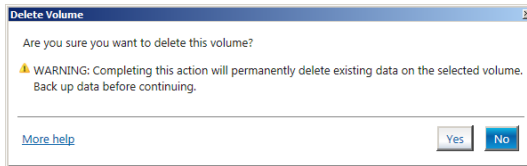

3. Click **Yes** to delete the volume and return to the utility main menu, or click **No** to return to the main menu.

# 5.4.4 Preferences

## System Preferences

Allow you to set to show the notification area icon and show system information, warning, or errors here.

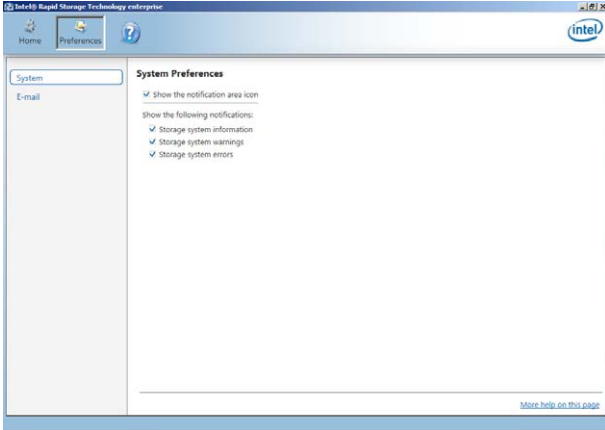

## E-Mail Preferences

Allow you to set to sent e-mail of the following events:

- Storage system information
- Storage system warnings
- Storage system errors

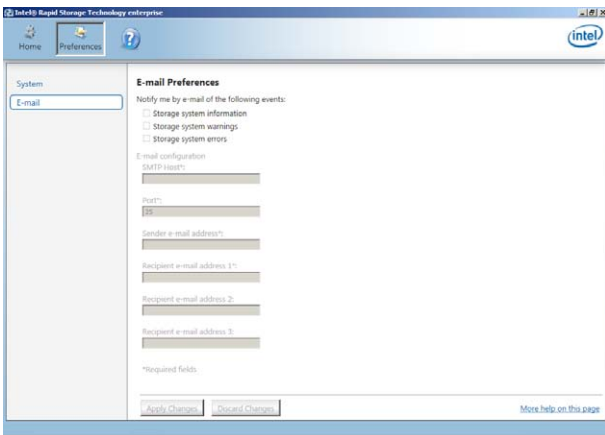

This chapter provides the instructions for installing the necessary drivers for different system components.

# 6 Driver installation

6.1	RAID driver installation .....	6-3
6.2	Intel® chipset device software installation.....	6-16
6.3	Intel® Network Connections Software installation.....	6-19
6.4	VGA driver installation.....	6-22
6.5	Intel® C600 Series Chipset SCU SATA RAID Drivers.....	6-25
6.6	Intel® Rapid Storage Technology enterprise 3.0 installation .	6-26
6.7	Intel® WG82574L Gigabit Adapters Driver installation.....	6-29
6.8	Management applications and utilities installation .....	6-33

## 6.1 RAID driver installation

After creating the RAID sets for your server system, you are now ready to install an operating system to the independent hard disk drive or bootable array. This part provides the instructions on how to install the RAID controller drivers during OS installation.

### 6.1.1 Creating a RAID driver disk



The system does not include a floppy drive. You have to use a USB floppy drive when creating a SATA RAID driver disk.



If you have created RAID sets with the LSI Software RAID configuration utility, the boot priority of the SATA optical disk drive has to be manually adjusted. Otherwise, the system will not boot from the connected SATA ODD.

A floppy disk with the RAID driver is required when installing Windows® XP / Server 2003 or Linux operating system on a hard disk drive that is included in a RAID set. You can create a RAID driver disk in DOS (using the Makedisk application in the support DVD).

To create a RAID driver disk in DOS environment

1. Place the motherboard support DVD in the optical drive.
2. Restart the computer, and then enter the BIOS Setup.
3. Select the optical drive as the first boot priority to boot from the support DVD. Save your changes, and then exit the BIOS Setup.
4. Restart the computer. The Makedisk menu appears.

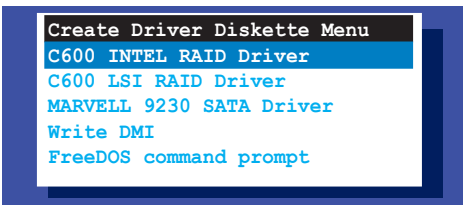

5. Use the arrow keys to select the type of RAID driver disk you want to create and press <Enter> to enter the sub-menu.

#### C600 INTEL RAID Driver

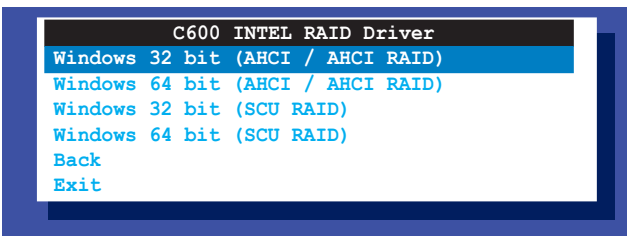

## LSI 2008 SAS2 Driver

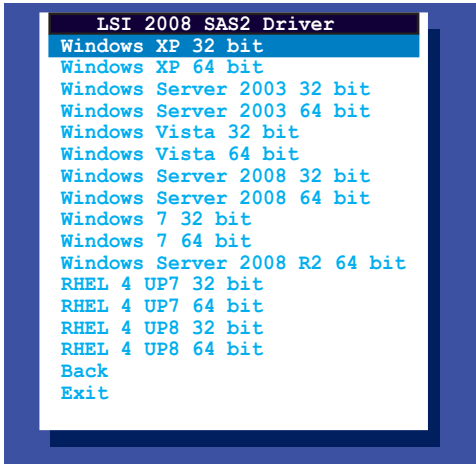

6. Locate the RAID driver and place a blank, high-density floppy disk to the floppy disk drive.
7. Press <Enter>.
8. Follow screen instructions to create the driver disk.

To create a RAID driver disk in Windows® environment

1. Start Windows®.
2. Place the motherboard support DVD into the optical drive.
3. Go to the **Make disk** menu, and then select the type of RAID driver disk you want to create.
4. Insert a floppy disk into the USB floppy disk drive.
5. Follow succeeding screen instructions to complete the process.



---

Write-protect the floppy disk to avoid computer virus infection.

---

To create a RAID driver disk in Red Hat® Enterprise Linux server environment

1. Insert a blank formatted high-density floppy disk to the USB floppy disk drive.
2. Type `dd if=XXX.img of=/dev/fd0` to decompress the file into the floppy disk from the following path in the support DVD:

For LSI MegaRAID Driver

**\\Drivers\C600 LSI RAID\Driver\makedisk\Linux**

3. Eject the floppy disk.

## 6.1.2 Installing the RAID controller driver

### During Windows® Server 2008 OS installation

To install the RAID controller driver when installing Windows® Server 2008 OS

1. Boot the computer using the Windows® Server 2008 OS installation disc. Follow the screen instructions to start installing Windows Server 2008.
2. When prompted to choose a type of installation, click **Custom (advanced)**.

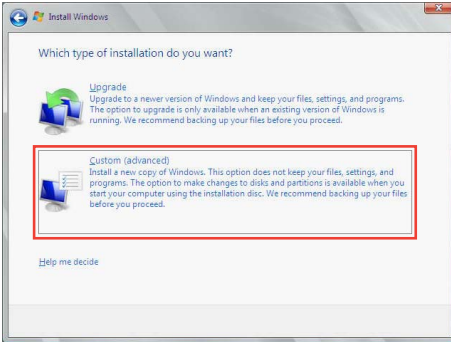

3. Click **Load Driver**.

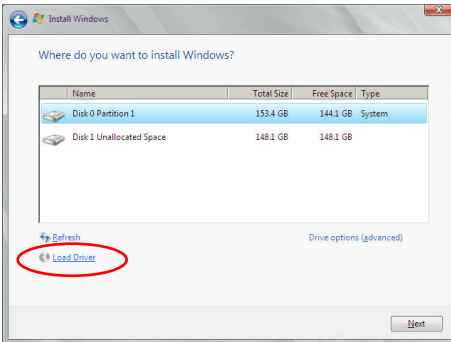



4. A message appears, reminding you to insert the installation media containing the driver of the RAID controller driver. If you have only one optical drive installed in your system, eject the Windows OS installation disc and replace with the motherboard Support DVD into the optical drive. Click **Browse** to continue.

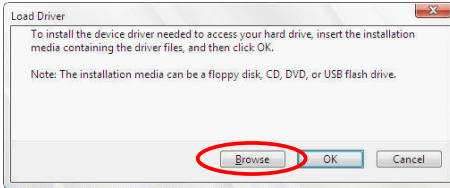

5. Locate the driver in the corresponding folder of the Support DVD, and then click **OK** to continue.
6. Select the RAID controller driver you need from the list and click **Next**.
7. When the system finishes loading the RAID driver, replace the motherboard Support DVD with the Windows Server installation disc. Select the drive to install Windows and click **Next**.

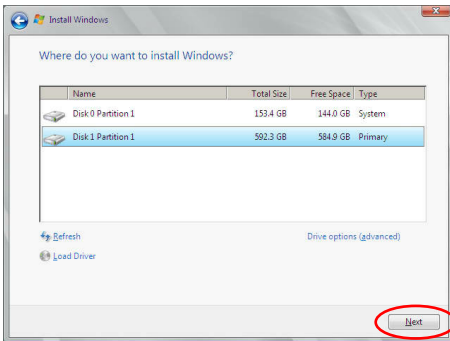

8. Setup then proceeds with the OS installation. Follow screen instructions to continue.

## Red Hat® Enterprise Linux OS 5.6

To install the LSI MegaRAID controller driver when installing Red Hat® Enterprise OS:

1. Boot the system from the Red Hat® OS installation CD.
2. At the `boot:`, type `linux dd noprobe=ata1 noprobe=ata2...`, then press `<Enter>`.



The number of ata varies with the hard disk drive number you have when building a RAID set. For example, if you want to build a RAID set with 6 hard disk drives, type command line: `linux dd noprobe=ata1 noprobe=ata2 noprobe=ata3 noprobe=ata4 noprobe=ata5 noprobe=ata6`.

```
- To install or upgrade in graphical mode, press the <ENTER> key.
- To install or upgrade in text mode, type: linux text <ENTER>.
- Use the function keys listed below for more information.
[F1-Main] [F2-Options] [F3-General] [F4-Kernel] [F5-Rescue]
boot: linux dd noprobe=ata1 noprobe=ata2
```

3. Select **Yes** using the `<Tab>` key when asked if you have the driver disk, then press `<Enter>`.

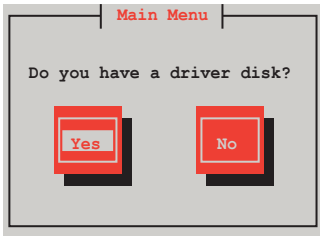

4. Insert the Red Hat® Enterprise RAID driver disk to the USB floppy disk drive, select **OK**, then press `<Enter>`.

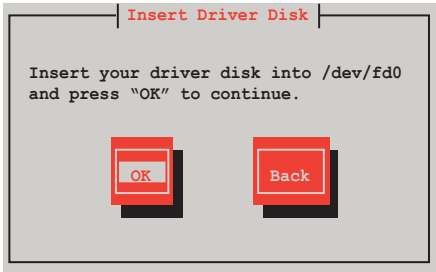

The drivers for the RAID card are installed to the system.

- When asked if you will load additional RAID controller drivers, select **No**, then press <Enter>.

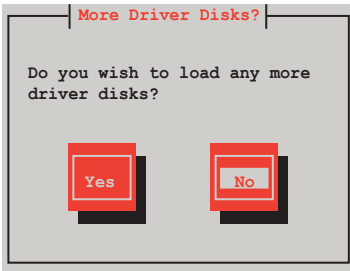

- Follow the onscreen instructions to finish the OS installation.
- When the installation is completed, DO NOT click **Reboot**. Press <Ctrl> + <Alt> + <F2> to switch to the command-line interface from graphic user interface.
- Type the following commands when using a Legacy floppy.

```
mkdir /mnt/driver
mount /dev/fd0 /mnt/driver
cd /mnt/driver
sh replace_ahci.sh
reboot
```

## Red Hat® Enterprise Linux OS 6.1

To install the LSI MegaRAID controller driver when installing Red Hat® Enterprise OS:

1. Boot the system from the Red Hat® OS installation CD.
2. Press <Tab> to edit options.

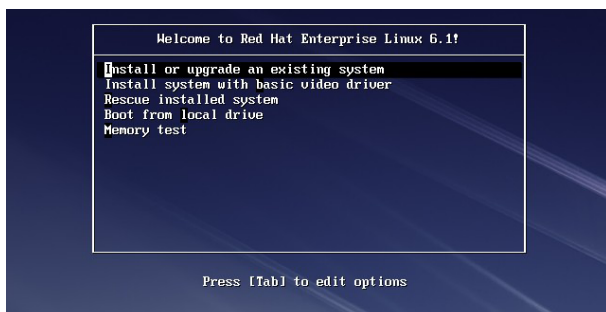

3. Entering the following command at the boot: `linux dd blacklist=iscsi blacklist=ahci nodmraid`, then press <Enter>.



4. Select **Yes** using the <Tab> key when asked if you have the driver disk, then press <Enter>.

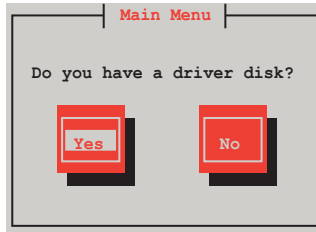

5. You have multiple devices which could serve as source for a driver disk. Choose one you like to use and select **OK**, then press <Enter>.

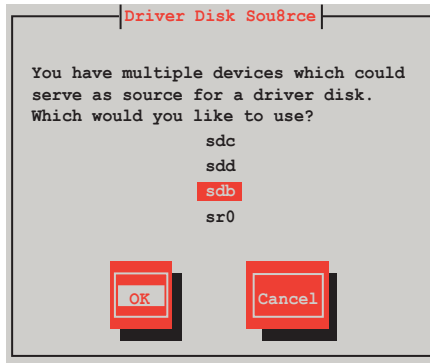

6. Insert the Red Hat® Enterprise RAID driver disk to the USB floppy disk drive, select **OK**, then press <Enter>.

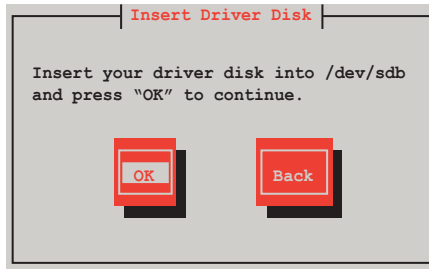

The drivers for the RAID card are installed to the system.

7. When asked if you will load additional RAID controller drivers, select **No**, then press <Enter>.

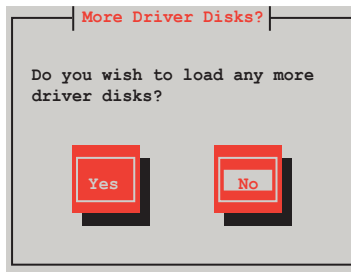

8. Follow the onscreen instructions to finish the OS installation.

## Preparing the Linux Driver

Ensure that there is another computer with a Linux-based OS to create the RAID driver. When creating the RAID driver, you may refer to the examples below which uses a 64bit SUSE Linux system to create a 64bit RAID driver for SUSE11 sp1.

1. Copy the image file into the Linux system.

Example: `megasr-15.00.0120.2012-1-sles11-ga-x86_64.img`

2. Create a folder.

Example: `image`

3. Mount the image file into the image folder using this command format:

`mount -o loop [image file name] image`

Example: `mount -o loop megasr-15.00.0120.2012-1-sles11-ga-x86_64.img image`



```
asus@linux-doe5 /tmp
File Edit View Terminal Tabs Help
asus@linux-doe5:/tmp> su -
Password:
linux-doe5:~ # ..
linux-doe5:~ # cd tmp
linux-doe5:/tmp # mount -o loop megasr-15.00.0120.2012-1-sles11-ga-x86_64.img image
linux-doe5:/tmp #
```

4. Copy the contents of the image directory, labeled as **01**, into a FAT32 USB drive.

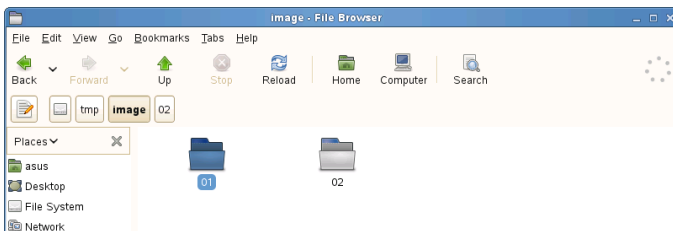

5. Rename the **01** folder to **CD Image**.

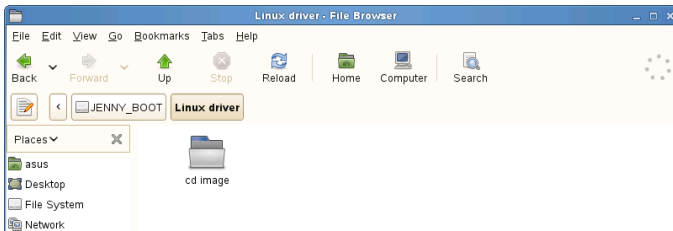

# SUSE Linux 11 OS

To install the LSI MegaRAID controller driver when installing SUSE Linux Enterprise Server OS:

1. Boot the system from the SUSE OS installation CD.
2. Use the arrow keys to select **Installation** from the **Boot Options** menu.



3. Press <F6>, then select **Yes** from the menu. Press <Enter>.





4. Use the USB drive to provide the third-party driver during the OS installation. Type the command **brokenmodules=ahci** in **Boot Options** field, and press <Enter>.

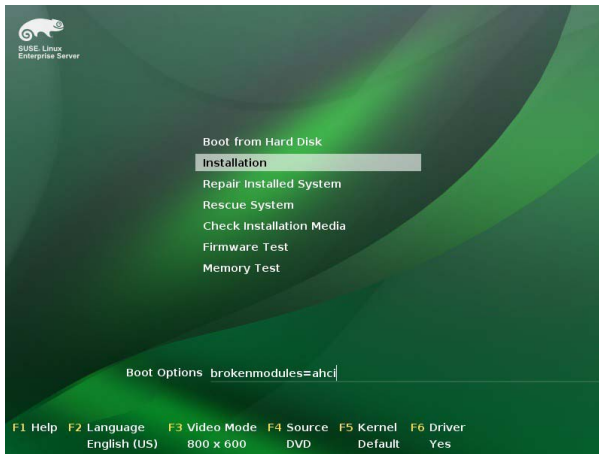

5. When below screen appears, select the USB floppy disk drive (sda) as the driver update medium. Select **OK**, then press <Enter>.

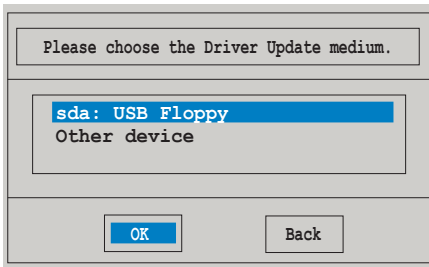

6. Select **Back** and follow the onscreen instructions to finish the installation.

## 6.2 Intel® chipset device software installation

This section provides the instructions on how to install the Intel® chipset device software on the system.

You need to manually install the Intel® chipset device software on a Windows operating system.

To install the Intel® chipset device software:

1. Restart the computer, and then log on with **Administrator** privileges.
2. Insert the motherboard/system support DVD to the optical drive. The support DVD automatically displays the **Drivers** menu if Autorun is enabled in your computer.



---

If Autorun is NOT enabled in your computer, browse the contents of the support DVD to locate the file **ASSETUP.EXE** from the **BIN** folder. Double-click the **ASSETUP.EXE** to run the support DVD.

---

3. Click the item **Intel Chipset Device Software** from the menu.



4. The **Intel(R) Chipset Device Software** window appears. Click **Next** to start installation.



5. Select **Yes** to accept the terms of the **License Agreement** and continue the process.



6. Read the **Readme File Information** and press **Next** to continue the installation.

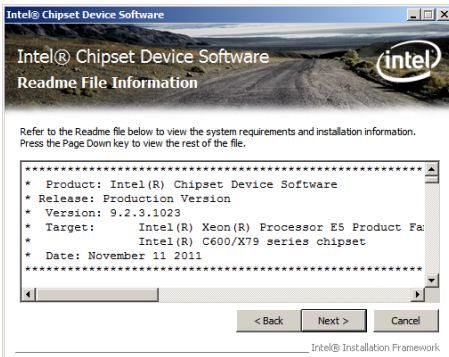

7. After completing the installation, click **Next** to complete the setup process.

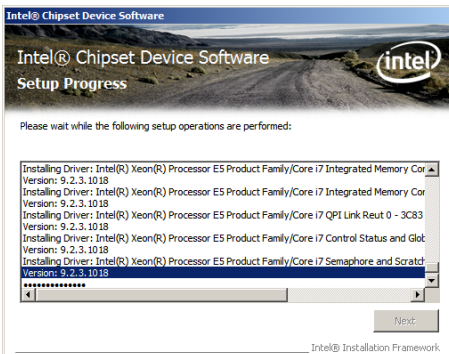

8. Select **Yes, I want to restart my computer now** and click **Finish** to restart your computer before using the program.



## 6.3 Intel® Network Connections Software installation

This section provides the instructions on how to install the Intel® Network Connections Software on the system.

You need to manually install the Intel® Network Connections Software on a Windows® operating system. To install the Intel® Network Connections Software:

1. Restart the computer, and then log on with **Administrator** privileges.
2. Insert the motherboard/system support DVD to the optical drive. The support DVD automatically displays the **Drivers** menu if Autorun is enabled in your computer.



- Windows® automatically detects the LAN controllers and displays a New Hardware Found window. Click **Cancel** to close this window.
- If Autorun is NOT enabled in your computer, browse the contents of the support DVD to locate the file **ASSETUP.EXE** from the **BIN** folder. Double-click the **ASSETUP.EXE** to run the DVD.

3. Click the **Intel® Network Connections Software** to begin installation.



4. Click **Install Drivers and Software** option to begin installation.

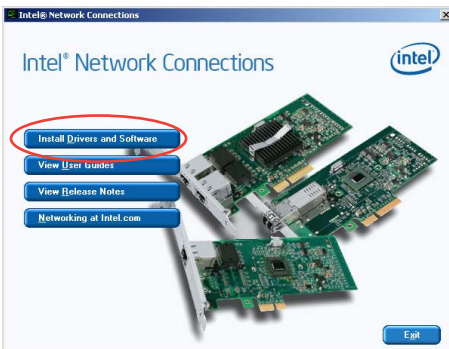

5. Click **Next** when the **Intel(R) Network Connections–InstallShield Wizard** window appears.



6. Select **Modify** and then click **Next** to continue.

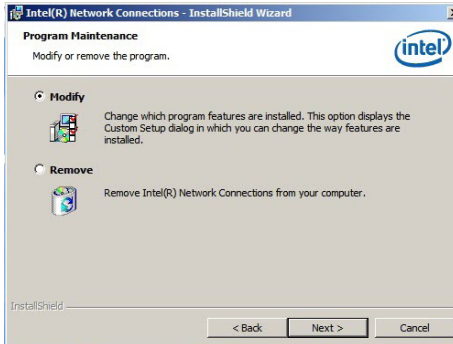

7. Click the **Intel(R) PROSet for Windows Device Manager** box, and then click **Next** to start the installation.

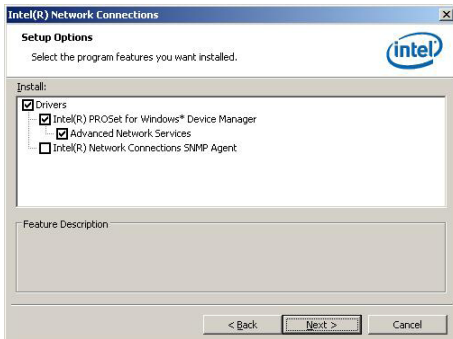

8. Follow the screen instructions to complete installation.

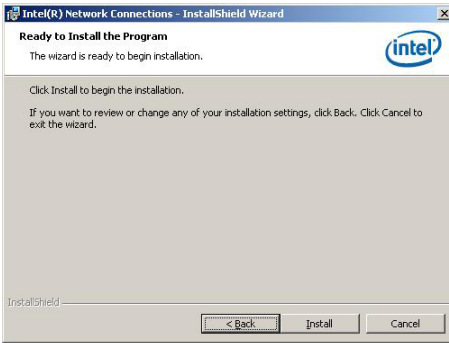

9. When finished, press **Finish** to continue.



## 6.4 VGA driver installation

This section provides the instructions on how to install the ASPEED Video Graphics Adapter (VGA) driver.

You need to manually install the ASPEED VGA driver on a Windows® operating system.

To install the ASPEED VGA driver:

1. Restart the computer, and then log on with **Administrator** privileges.
2. Insert the motherboard/system support DVD to the optical drive. The support DVD automatically displays the **Drivers** menu if Autorun is enabled in your computer.



If Autorun is NOT enabled in your computer, browse the contents of the support DVD to locate the file **ASSETUP.EXE** from the **BIN** folder. Double-click the **ASSETUP.EXE** to run the support DVD.

3. Click the **ASPEED AST2300 Display Driver** to begin installation.



4. When the **ASPEED Graphics** installation wizard appears, click **Next** to start the installation.

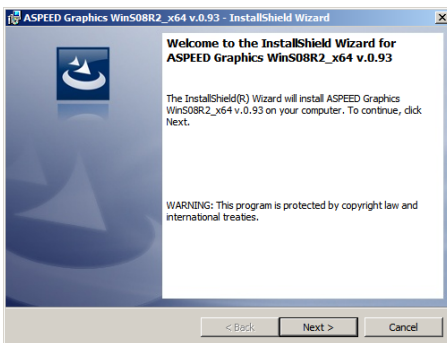



5. Toggle **I accept the terms in the license agreement** and click **Next** to continue.

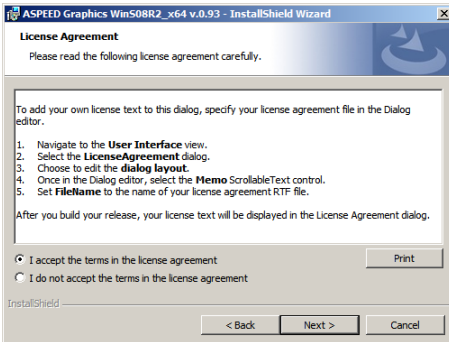

6. Enter the user information and click **Next** to continue.

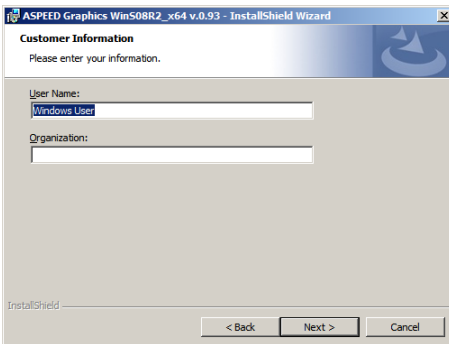

7. Select a setup type and click **Next** to continue.

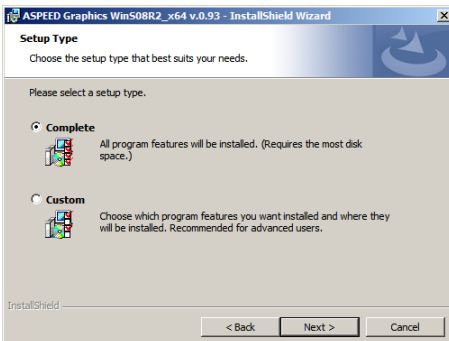

8. Click **Install** to start driver installation.

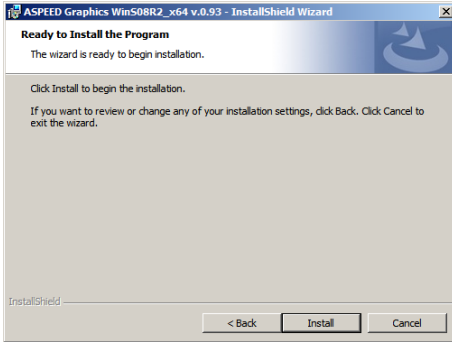

9. When the installation completes, click **Finish** to restart your computer before using the program.

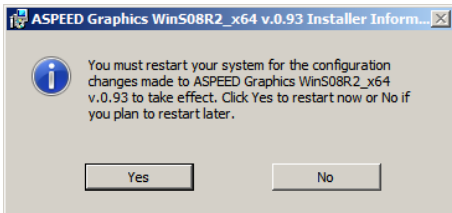
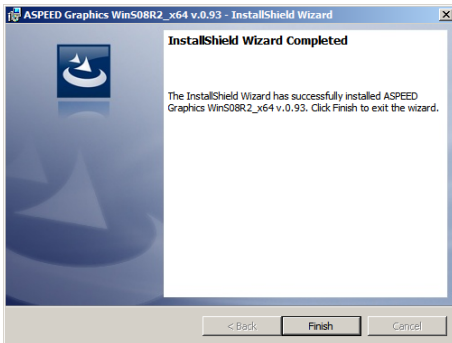

## 6.5 Intel® C600 Series Chipset SCU SATA RAID Drivers

This section provides the instructions on how to install the **Intel® C600 Series Chipset SCU SATA RAID Drivers** on the system.

You need to manually install the Intel® C600 Series Chipset SCU SATA RAID Drivers on a Windows operating system.

To install the drivers:

1. Restart the computer, and then log on with **Administrator** privileges.
2. Insert the motherboard/system support DVD to the optical drive. The support DVD automatically displays the **Drivers** menu if Autorun is enabled in your computer.



If Autorun is NOT enabled in your computer, browse the contents of the support DVD to locate the file **ASSETUP.EXE** from the **BIN** folder. Double-click the **ASSETUP.EXE** to run the support DVD.

3. Click the item **Intel® C600 Series Chipset SCU SATA RAID Drivers** from the menu, and then follow the onscreen instructions to complete the installation.



## 6.6 Intel® Rapid Storage Technology enterprise 3.0 installation

This section provides the instructions on how to install the Intel® Rapid Storage Technology enterprise 3.0 on the system.

You need to manually install the Intel® Rapid Storage Technology enterprise 3.0 utility on a Windows® operating system.

To install the Intel® Rapid Storage Technology enterprise 3.0 utility:

1. Restart the computer, and then log on with **Administrator** privileges.
2. Insert the motherboard/system support DVD to the optical drive. The support DVD automatically displays the **Drivers** menu if Autorun is enabled in your computer.



---

If Autorun is NOT enabled in your computer, browse the contents of the support DVD to locate the file **ASSETUP.EXE** from the **BIN** folder. Double-click the **ASSETUP.EXE** to run the support DVD.

---

3. Click the **Intel® Rapid Storage Technology enterprise 3.0** to begin installation.



4. When the **Welcome to the Setup Program** appears, click **Next** to start the installation.



5. Read the **Warning** message and click **Next** to continue.



6. Read the **License Agreement** and click **Yes** to continue.



7. Read the **Readme File Information** and click **Next** to continue.

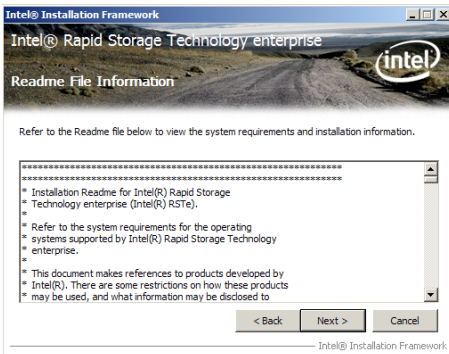

8. After completing the installation, click **Next** to complete the setup process.

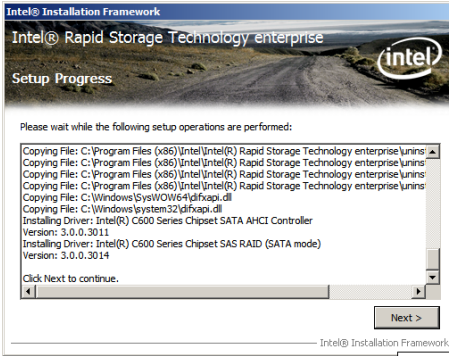

9. Select **Yes, I want to restart my computer now** and click **Finish** to restart your computer before using the program.



## 6.7 Intel® WG82574L Gigabit Adapters Driver installation

This section provides the instructions on how to install Intel® WG82574L Gigabit Adapters Driver.

To install the Intel® WG82574L Gigabit Adapters Driver on a Windows® OS:

1. Restart the computer, and then log on with **Administrator** privileges.
2. Insert the motherboard/system support DVD to the optical drive. The DVD automatically displays the **Drivers** menu if Autorun is enabled in your computer.



If **Autorun** is NOT enabled in your computer, browse the contents of the support DVD to locate the file **AUTORUN.EXE** and double-click the **AUTORUN.EXE** and follow step 4 to run the installation.

3. Click **Intel® WG82574L Gigabit Adapters Driver**.



4. When the **Intel® PRO Network Connections – InstallShield Wizard** window appears, click **Next** to start the installation.

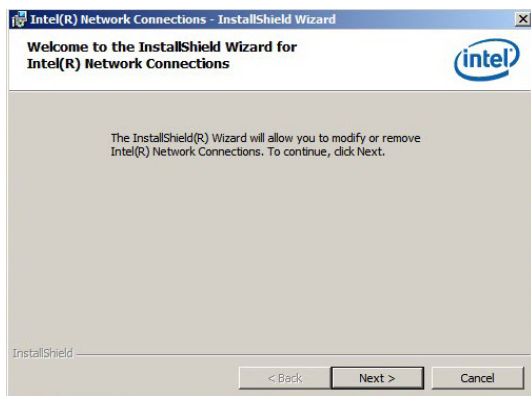

5. Select **Modify** and then click **Next** to continue.

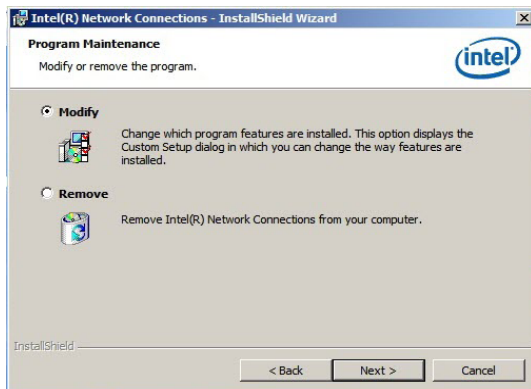



6. Select the programs you want to install and click **Next** to continue.

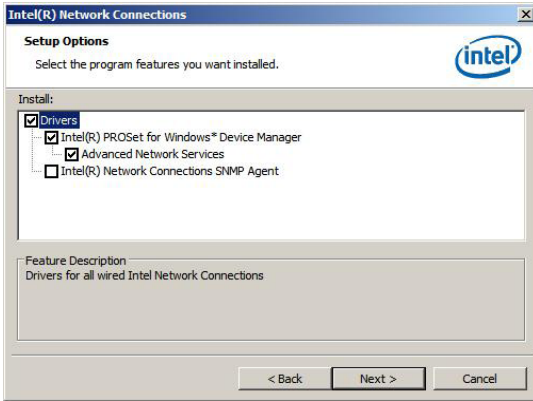

7. Click **Install** to start the installation.

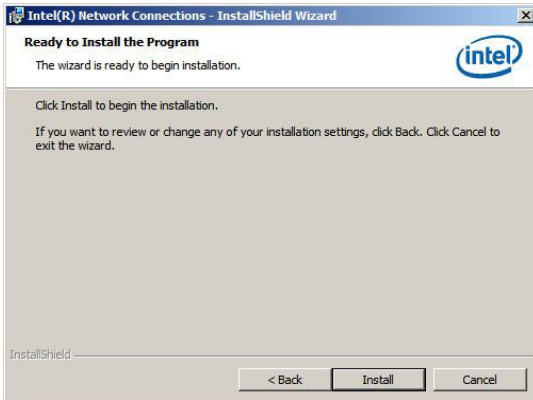

8. The programs you select are being installed.



9. Click **Finish** to finish the installation.

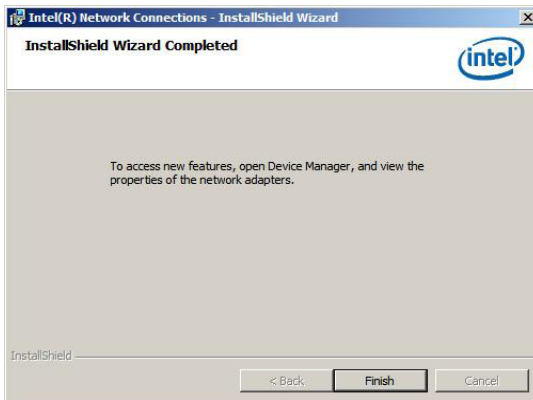

10. Restart your computer before using the program.

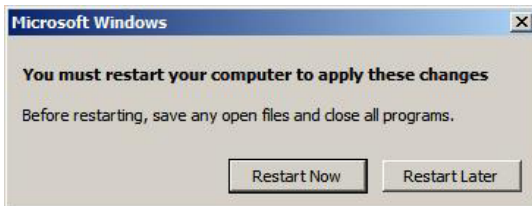

## 6.8 Management applications and utilities installation

The support DVD that came with the motherboard package contains the drivers, management applications, and utilities that you can install to avail all motherboard features.



The contents of the support DVD are subject to change at any time without notice. Visit the ASUS website ([www.asus.com](http://www.asus.com)) for updates.

### 6.8.1 Running the support DVD

Place the support DVD to the optical drive. The DVD automatically displays the Drivers menu if Autorun is enabled in your computer.



If Autorun is NOT enabled in your computer, browse the contents of the support DVD to locate the file **ASSETUP.EXE** from the **BIN** folder. Double-click the **ASSETUP.EXE** to run the support DVD.

### 6.8.2 Drivers menu

The Drivers menu shows the available device drivers if the system detects installed devices. Install the necessary drivers to activate the devices.



The screen display and driver options vary under different operating system versions.



### 6.8.3 Utilities menu

The Utilities menu displays the software applications and utilities that the motherboard supports. Click an item to install.



### 6.8.4 Make disk menu

The Make disk menu contains items to create the Intel RAID driver disks.

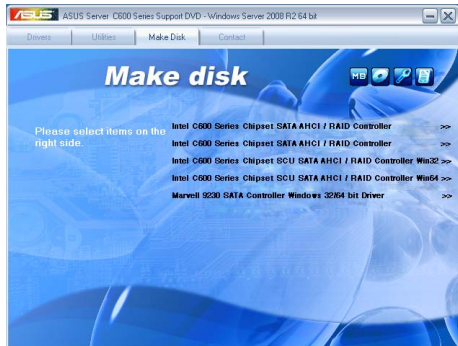

### 6.8.5 Contact information

Click the Contact tab to display the ASUS contact information. You can also find this information on the inside front cover of this user guide.

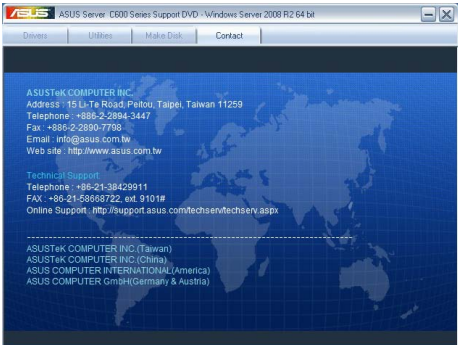

This appendix includes additional information that you may refer to when configuring the motherboard.

# Reference information



# Appendix summary



A.1	Z9PR-D12 block diagram.....	A-3
A.2	Z9PR-D12C block diagram .....	A-4

# A.1 Z9PR-D12 block diagram

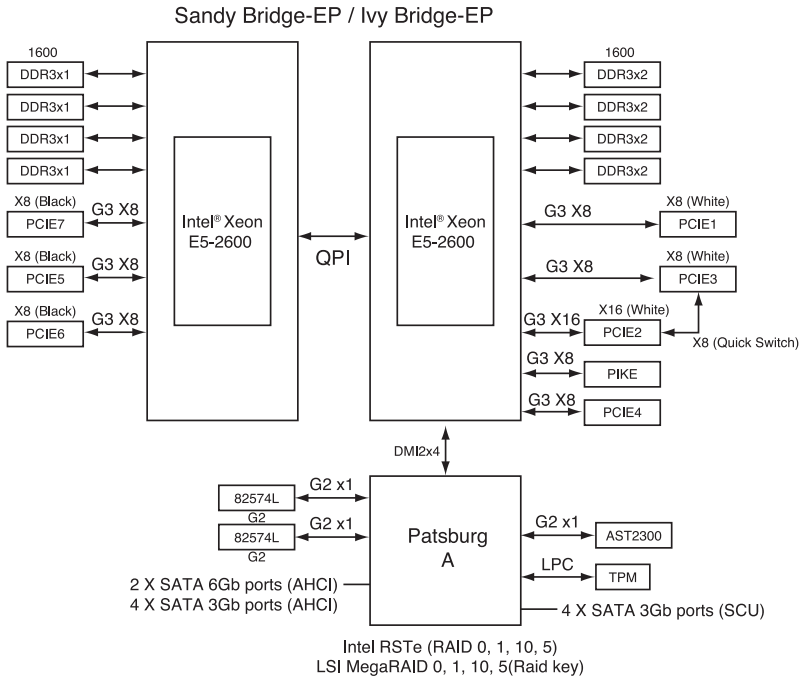

# A.2 Z9PR-D12C block diagram

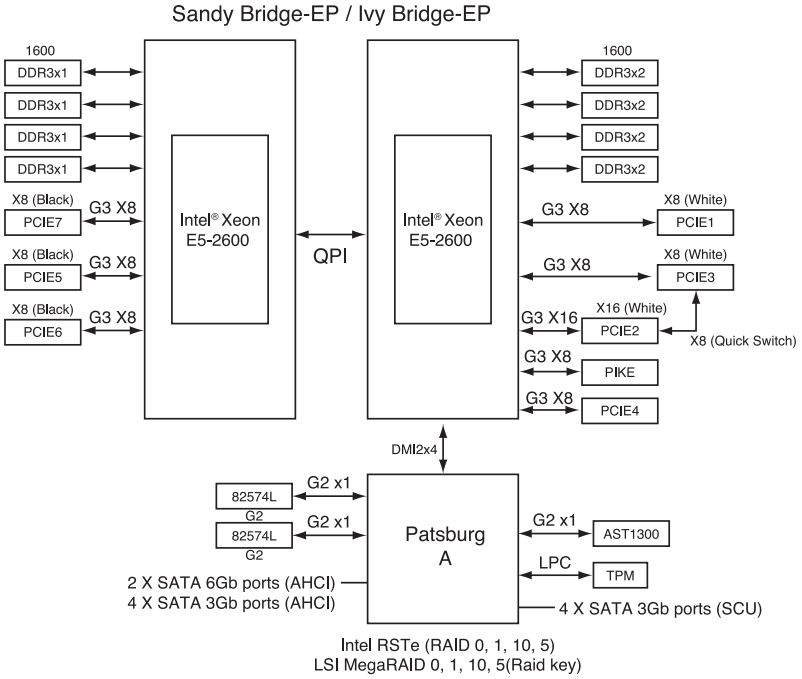



## **ASUS contact information**

### **ASUSTeK COMPUTER INC. (Taiwan)**

Address 15 Li-Te Road, Peitou, Taipei, Taiwan 11259  
Telephone +886-2-2894-3447  
Fax +886-2-2890-7798  
E-mail info@asus.com.tw  
Web site <http://www.asus.com.tw>

#### *Technical Support*

Telephone +886-2-2894-3447 (0800-093-456)  
Online Support <http://support.asus.com/techserv/techserv.aspx>

### **ASUSTeK COMPUTER INC. (China)**

Address No.508, Chundong Road, Xinzhuang Industrial Zone,  
Minhang District, Shanghai, China.  
Telephone +86-21-5442-1616  
Fax +86-21-5442-0099  
Web site <http://www.asus.com.cn>

#### *Technical Support*

Telephone +86-21-3407-4610 (800-820-6655)  
Online Support <http://support.asus.com/techserv/techserv.aspx>

### **ASUS COMPUTER INTERNATIONAL (America)**

Address 800 Corporate Way, Fremont, CA 94539, USA  
Fax +1-510-608-4555  
Web site <http://usa.asus.com>

#### *Technical Support*

Support fax +1-812-284-0883  
General support +1-812-282-2787  
Online support <http://support.asus.com/techserv/techserv.aspx>

### **ASUS COMPUTER GmbH (Germany and Austria)**

Address Harkort Str. 21-23, D-40880 Ratingen, Germany  
Fax +49-2102-959911  
Web site <http://www.asus.de>  
Online contact <http://www.asus.de/sales>

#### *Technical Support*

Telephone +49-1805-010923\*  
Support Fax +49-2102-959911  
Online support <http://support.asus.com/techserv/techserv.aspx>

\* EUR 0.14/minute from a German fixed landline; EUR 0.42/minute from a mobile phone.

# DECLARATION OF CONFORMITY

Per FCC Part 2, Section 2. 107.7(a)



Responsible Party Name: **Asus Computer International**

Address: **800 Corporate Way, Fremont, CA 94539.**

Phone/Fax No: **(510)739-3777/(510)608-4555**

hereby declares that the product

**Product Name : Motherboard**

**Model Number : Z9PR-D12**

Conforms to the following specifications:

- FCC Part 15, Subpart B, Unintentional Radiators
- FCC Part 15, Subpart C, Intentional Radiators
- FCC Part 15, Subpart E, Intentional Radiators

### Supplementary Information:

This device complies with part 15 of the FCC Rules. Operation is subject to the following two conditions: (1) This device may not cause harmful interference, and (2) this device must accept any interference received, including interference that may cause undesired operation.

Representative Person's Name : Steve Chang / President

Signature : Steve Chang  
Date : Mar. 23, 2012

Ver. 110101

# EC Declaration of Conformity



We, the undersigned,

Manufacturer : **ASUSTEK COMPUTER INC.**  
Address, City : **No. 150, LITE RD., PEITOU, TAIPEI 112, TAIWAN R.O.C.**  
Country : **TAIWAN**  
Authorized representative in Europe: **ASUS COMPUTER GmbH**  
Address, City: **HARKORT STR. 21-23, 40880 RATINGEN**  
Country: **GERMANY**

declare the following apparatus:

Product name : **Motherboard**  
Model name : **Z9PR-D12**

conform with the essential requirements of the following directives:

**2004/109/EC-EMC Directive**  
 EN 61000-3-2:2006+A1:2008+A2:2009  
 EN 61000-3-3:2008  
 EN 55013:2001+A1:2003+A2:2006  
 **1999/5/EC-R & TTE Directive**  
 EN 300 328 V1.7.1.(12006-10)  
 EN 300 440-1 V1.4.(12006-05)  
 EN 300 342 V1.3.1.(12006-05)  
 EN 301 511 V9.0.2.(2003-03)  
 EN 301 908-1 V3.2.(12007-05)  
 EN 301 908-2 V3.2.(12007-05)  
 EN 301 908-17 V2.1.1.(12009-05)  
 EN 301 908-18 V2.1.1.(12009-05)  
 EN 302 544-2 V1.1.(12009-01)  
 EN 50860:2001  
 EN 50371:2002  
 EN 50985:2002

**2009/5/EC-LVD Directive**  
 EN 60950-1/A11:2009  
 EN 60950-1/A12:2011  
 EN 60065:2002/A12:2011  
 EN 301 489-1 V1.6.(12008-04)  
 EN 301 489-3 V1.4.(12002-08)  
 EN 301 489-4 V1.3.(12002-08)  
 EN 301 489-7 V1.3.(12006-11)  
 EN 301 489-9 V1.4.(12007-11)  
 EN 301 489-17 V2.1.1.(12009-05)  
 EN 301 489-18 V2.1.1.(12009-05)  
 EN 302 328-2 V1.2.(2007-09)  
 EN 302 328-3 V1.3.(12007-09)  
 EN 301 857-2 V1.3.(12006-05)  
 EN 302 823 V1.1.(1209-01)

**2009/125/EC-ERP Directive**  
 EN 60950-1/A11:2009  
 EN 60950-1/A12:2011  
 EN 60065:2002/A12:2011

**Regulation (EC) No. 1275/2008**  
 EN 62301:2005  
 Regulation (EC) No. 642/2009  
 EN 62301:2005

### CE marking



(EC conformity marking)

Position : **CEO**  
Name : **Jerry Sheu**

Signature : Jerry Sheu  
Ver. 111121

Declaration Date: **Mar. 23, 2012**  
Year to begin affixing CE marking: **2012**

## Free Manuals Download Website

<http://myh66.com>

<http://usermanuals.us>

<http://www.somanuals.com>

<http://www.4manuals.cc>

<http://www.manual-lib.com>

<http://www.404manual.com>

<http://www.luxmanual.com>

<http://aubethermostatmanual.com>

Golf course search by state

<http://golfingnear.com>

Email search by domain

<http://emailbydomain.com>

Auto manuals search

<http://auto.somanuals.com>

TV manuals search

<http://tv.somanuals.com>