

User Guide

ASUS ZenWiFi AC

Wireless AC3000 Tri band Gigabit Router

Model: CT8

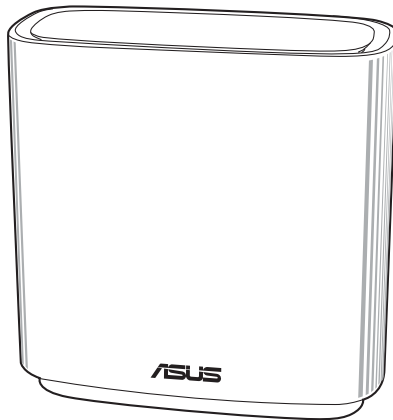

E16735

First Edition

May 2020

Copyright © 2020 ASUSTeK Computer Inc. All Rights Reserved.

No part of this manual, including the products and software described in it, may be reproduced, transmitted, transcribed, stored in a retrieval system, or translated into any language in any form or by any means, except documentation kept by the purchaser for backup purposes, without the express written permission of ASUSTeK Computer Inc. ("ASUS").

Product warranty or service will not be extended if: (1) the product is repaired, modified or altered, unless such repair, modification or alteration is authorized in writing by ASUS; or (2) the serial number of the product is defaced or missing.

ASUS PROVIDES THIS MANUAL "AS IS" WITHOUT WARRANTY OF ANY KIND, EITHER EXPRESS OR IMPLIED, INCLUDING BUT NOT LIMITED TO THE IMPLIED WARRANTIES OR CONDITIONS OF MERCHANTABILITY OR FITNESS FOR A PARTICULAR PURPOSE. IN NO EVENT SHALL ASUS, ITS DIRECTORS, OFFICERS, EMPLOYEES OR AGENTS BE LIABLE FOR ANY INDIRECT, SPECIAL, INCIDENTAL, OR CONSEQUENTIAL DAMAGES (INCLUDING DAMAGES FOR LOSS OF PROFITS, LOSS OF BUSINESS, LOSS OF USE OR DATA, INTERRUPTION OF BUSINESS AND THE LIKE), EVEN IF ASUS HAS BEEN ADVISED OF THE POSSIBILITY OF SUCH DAMAGES ARISING FROM ANY DEFECT OR ERROR IN THIS MANUAL OR PRODUCT.

SPECIFICATIONS AND INFORMATION CONTAINED IN THIS MANUAL ARE FURNISHED FOR INFORMATIONAL USE ONLY, AND ARE SUBJECT TO CHANGE AT ANY TIME WITHOUT NOTICE, AND SHOULD NOT BE CONSTRUED AS A COMMITMENT BY ASUS. ASUS ASSUMES NO RESPONSIBILITY OR LIABILITY FOR ANY ERRORS OR INACCURACIES THAT MAY APPEAR IN THIS MANUAL, INCLUDING THE PRODUCTS AND SOFTWARE DESCRIBED IN IT.

Products and corporate names appearing in this manual may or may not be registered trademarks or copyrights of their respective companies, and are used only for identification or explanation and to the owners' benefit, without intent to infringe.

Table of contents

1	Getting to know your wireless router	
1.1	Welcome!.....	6
1.2	Package contents	6
1.3	Your wireless router	7
1.4	Positioning your router	8
1.5	Setup Requirements.....	9
1.6	Router Setup	10
1.6.1	Wired connection.....	10
1.6.2	Wireless connection	11
2	Getting started	
2.1	Logging into the Web GUI.....	13
2.2	Quick Internet Setup (QIS) with Auto-detection.....	14
2.3	Connecting to your wireless network.....	18
3	Configuring the General settings	
3.1	Using the Network Map	19
3.1.1	Setting up the wireless security settings.....	20
3.1.2	Managing your network clients.....	21
3.1.3	Monitoring your USB device	22
3.2	Creating a Guest Network.....	25
3.3	AiProtection.....	27
3.3.1	Network Protection	28
3.3.2	Setting up Parental Controls.....	32
3.4	Using the Traffic Manager	35
3.4.1	Managing QoS (Quality of Service) Bandwidth.....	35
3.5	Traffic Analyzer	38
3.6	Using the USB Application.....	39
3.6.1	Using AiDisk.....	39
3.6.2	Using Servers Center.....	41
3.6.3	3G/4G	45

Table of contents

3.7	Using iCloud 2.0.....	47
3.7.1	Cloud Disk.....	48
3.7.2	Smart Access.....	49
3.7.3	iCloud Sync.....	50
4	Configuring the Advanced Settings	
4.1	Wireless.....	51
4.1.1	General.....	51
4.1.2	WPS.....	54
4.1.3	Bridge.....	56
4.1.4	Wireless MAC Filter.....	58
4.1.5	RADIUS Setting.....	59
4.1.6	Professional.....	60
4.2	LAN.....	63
4.2.1	LAN IP.....	63
4.2.2	DHCP Server.....	64
4.2.3	Route.....	66
4.2.4	IPTV.....	67
4.3	WAN.....	68
4.3.1	Internet Connection.....	68
4.3.2	Port Trigger.....	71
4.3.3	Virtual Server/Port Forwarding.....	73
4.3.4	DMZ.....	76
4.3.5	DDNS.....	77
4.3.6	NAT Passthrough.....	78
4.4	IPv6.....	79
4.5	Firewall.....	80
4.5.1	General.....	80
4.5.2	URL Filter.....	80
4.5.3	Keyword filter.....	81
4.5.4	Network Services Filter.....	82

Table of contents

4.6	Administration.....	84
4.6.1	Operation Mode	84
4.6.2	System.....	85
4.6.3	Firmware Upgrade.....	87
4.6.4	Restore/Save/Upload Setting	87
4.7	System Log	88
5	Utilities	
5.1	Device Discovery	89
5.2	Firmware Restoration.....	90
5.3	Setting up your printer server	91
5.3.1	ASUS EZ Printer Sharing	91
5.3.2	Using LPR to Share Printer	95
5.4	Download Master	100
5.4.1	Configuring Bit Torrent download settings	101
5.4.2	NZB settings.....	102
6	Troubleshooting	
6.1	Basic Troubleshooting	103
6.2	Frequently Asked Questions (FAQs)	106
	Appendices	
	Notices	115
	ASUS Contact information	152

1 Getting to know your wireless router

1.1 Welcome!

Thank you for purchasing an ASUS ZenWiFi AC Wireless Router! The ultra-thin and stylish ZenWiFi AC features a 2.4GHz, 5GHz-1, and 5GHz-2 triple bands for an unmatched concurrent wireless HD streaming; SMB server, UPnP AV server, and FTP server for 24/7 file sharing; a capability to handle 300,000 sessions; and the ASUS Green Network Technology, which provides up to 70% power-saving solution.

1.2 Package contents

- | | |
|--|---|
| <input checked="" type="checkbox"/> ZenWiFi AC Wireless Router | <input checked="" type="checkbox"/> Network cable (RJ-45) |
| <input checked="" type="checkbox"/> Power adapter | <input checked="" type="checkbox"/> Quick Start Guide |

NOTES:

- If any of the items are damaged or missing, contact ASUS for technical inquiries and support. Refer to the ASUS Support Hotline list at the back of this user manual.
 - Keep the original packaging material in case you would need future warranty services such as repair or replacement.
-

1.3 Your wireless router

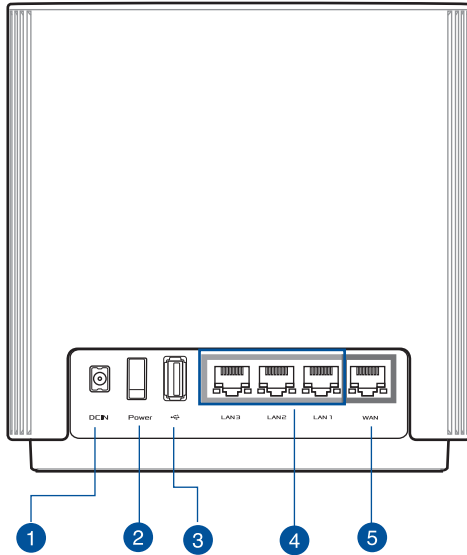

- 1 Power (DC-IN) port**
Insert the bundled AC adapter into this port and connect your router to a power source.
- 2 Power switch**
Switch to turn on or off the system.
- 3 USB 3.0/2.0 port**
Insert a USB 3.0/2.0 device such as a USB hard disk or a USB flash drive into this port.
- 4 LAN 1 ~ 3 ports**
Connect network cables into these ports to establish LAN connection.
- 5 WAN (Internet) port**
Connect a network cable into this port to establish WAN connection.

NOTES:

- Use only the adapter that came with your package. Using other adapters may damage the device.
- **Specifications:**

DC Power adapter	DC Output: +19V with max 1.75A current;		
Operating Temperature	0~40°C	Storage	0~70°C
Operating Humidity	50~90%	Storage	20~90%

1.4 Positioning your router

For the best wireless signal transmission between the wireless router and the network devices connected to it, ensure that you:

- Place the wireless router in a centralized area for a maximum wireless coverage for the network devices.
- Keep the device away from metal obstructions and away from direct sunlight.
- Keep the device away from 802.11g or 20MHz only Wi-Fi devices, 2.4GHz computer peripherals, Bluetooth devices, cordless phones, transformers, heavy-duty motors, fluorescent lights, microwave ovens, refrigerators, and other industrial equipment to prevent signal interference or loss.
- Always update to the latest firmware. Visit the ASUS website at <http://www.asus.com> to get the latest firmware updates.

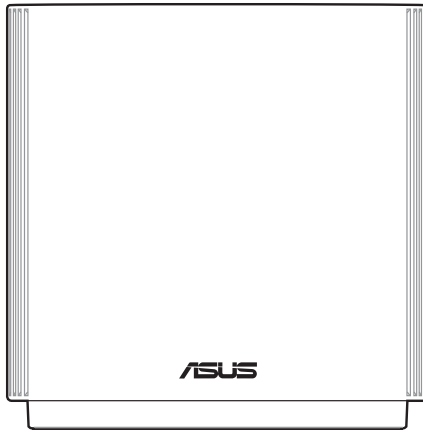

1.5 Setup Requirements

To set up your wireless network, you need a computer that meets the following system requirements:

- Ethernet RJ-45 (LAN) port (10Base-T/100Base-TX/1000BaseTX)
- IEEE 802.11a/b/g/n/ac wireless capability
- An installed TCP/IP service
- Web browser such as Internet Explorer, Firefox, Safari, or Google Chrome

NOTES:

- If your computer does not have built-in wireless capabilities, you may install an IEEE 802.11a/b/g/n/ac/ax WLAN adapter to your computer to connect to the network.
 - With its triple band technology, your wireless router supports 2.4GHz, 5GHz-1, and 5GHz-2 wireless signals simultaneously. This allows you to do Internet-related activities such as Internet surfing or reading/writing e-mail messages using the 2.4GHz band while simultaneously streaming high-definition audio/video files such as movies or music using the 5GHz band.
 - Some IEEE 802.11n devices that you want to connect to your network may or may not support 5GHz band. Refer to the device's manual for specifications.
 - The Ethernet RJ-45 cables that will be used to connect the network devices should not exceed 100 meters.
-

1.6 Router Setup

IMPORTANT!

- Use a wired connection when setting up your wireless router to avoid possible setup problems.
 - Before setting up your ASUS wireless router, do the following:
 - If you are replacing an existing router, disconnect it from your network.
 - Disconnect the cables/wires from your existing modem setup. If your modem has a backup battery, remove it as well.
 - Reboot your cable modem and computer (recommended).
-

1.6.1 Wired connection

NOTE: You can use either a straight-through cable or a crossover cable for wired connection.

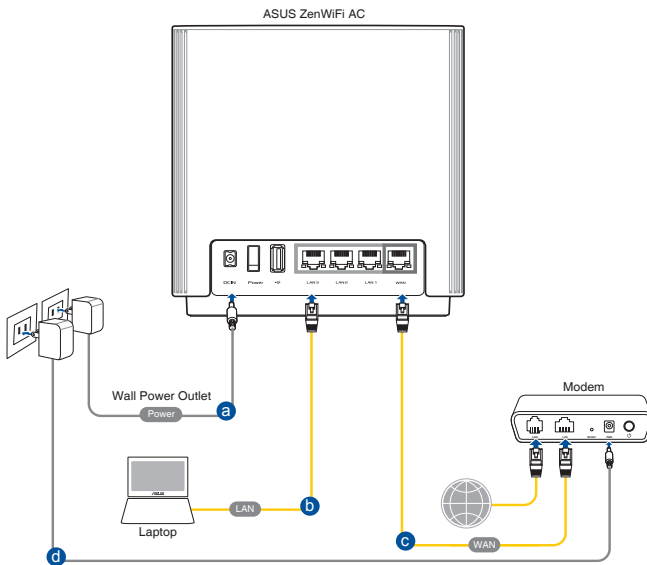

To set up your wireless router via wired connection:

1. Insert your wireless router's AC adapter to the DC-IN port and plug it to a power outlet.
2. Using the bundled network cable, connect your computer to your wireless router's LAN port.

IMPORTANT! Ensure that the LAN LED is blinking.

3. Using another network cable, connect your modem to your wireless router's WAN port.
4. Insert your modem's AC adapter to the DC-IN port and plug it to a power outlet.

1.6.2 Wireless connection

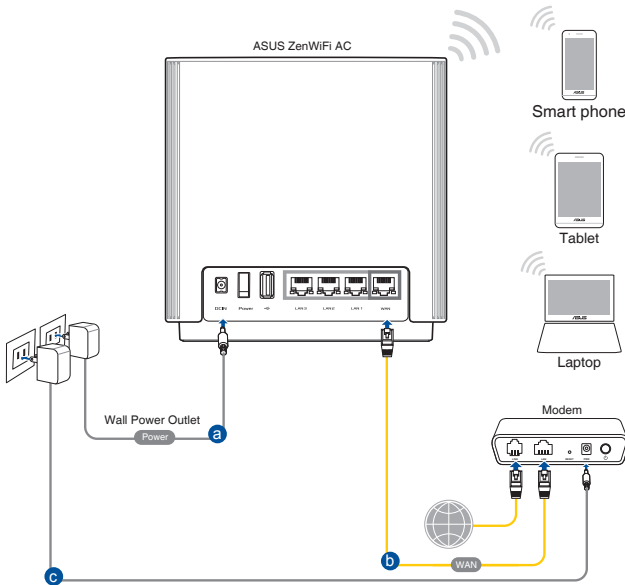

To set up your wireless router via wireless connection:

1. Insert your wireless router's AC adapter to the DC-IN port and plug it to a power outlet.
2. Using the bundled network cable, connect your modem to your wireless router's WAN port.

3. Insert your modem's AC adapter to the DC-IN port and plug it to a power outlet.
4. Install an IEEE 802.11a/b/g/n/ac WLAN adapter on your computer.

NOTES:

- For details on connecting to a wireless network, refer to the WLAN adapter's user manual.
 - To set up the security settings for your network, refer to the section **Setting up the wireless security settings** in Chapter 3 of this user manual.
-

2 Getting started

2.1 Logging into the Web GUI

Your ASUS Wireless Router comes with an intuitive web graphical user interface (GUI) that allows you to easily configure its various features through a web browser such as Internet Explorer, Firefox, Safari, or Google Chrome.

NOTE: The features may vary with different firmware versions.

To log into the web GUI:

1. On your web browser, enter <http://router.asus.com>.
2. On the login page, key in the default user name (**admin**) and password (**admin**).
3. You can now use the Web GUI to configure various settings of your ASUS Wireless Router.



NOTE: If you are logging into the Web GUI for the first time, you will be directed to the Quick Internet Setup (QIS) page automatically.

2.2 Quick Internet Setup (QIS) with Auto-detection

The Quick Internet Setup (QIS) function guides you in quickly setting up your Internet connection.

NOTE: When setting the Internet connection for the first time, press the Reset button on your wireless router to reset it to its factory default settings.

To use QIS with auto-detection:

1. Log into the Web GUI. The QIS page launches automatically.

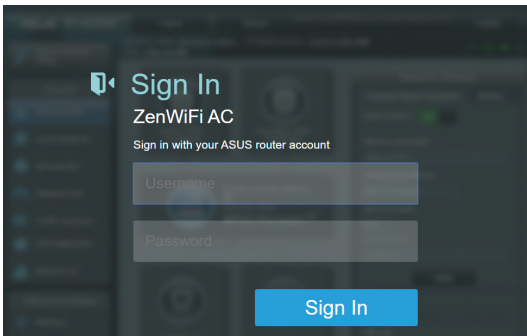

NOTES:

- For details on changing your wireless router's login username and password, refer to section **4.6.2 System**.
 - The wireless router's login username and password is different from the 2.4GHz/5GHz network name (SSID) and security key. The wireless router's login username and password allows you to log into your wireless router's Web GUI to configure your wireless router's settings. The 2.4GHz/5GHz network name (SSID) and security key allows Wi-Fi devices to log in and connect to your 2.4GHz/5GHz network.
-

2. The wireless router automatically detects if your ISP connection type is **Dynamic IP**, **PPPoE**, **PPTP**, **L2TP**, and **Static IP**. Key in the necessary information for your ISP connection type.

IMPORTANT! Obtain the necessary information from your ISP about the Internet connection type.

for Automatic IP (DHCP)

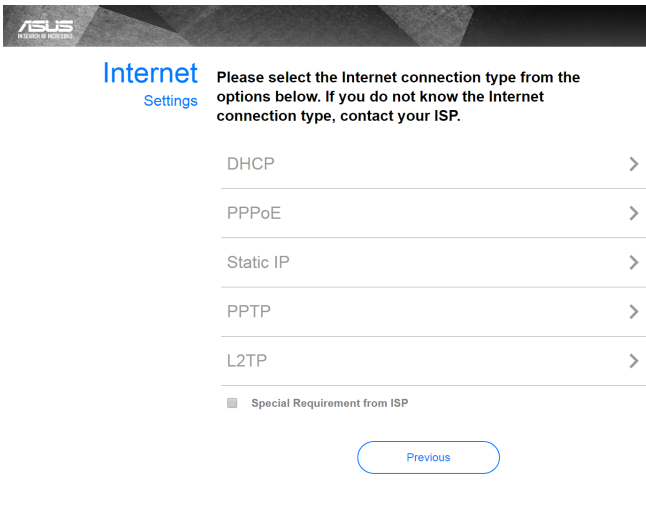

The screenshot shows the 'Internet Settings' page. At the top left is the ASUS logo with the tagline 'INSPIRED BY PROBLEMS'. The main heading is 'Internet Settings'. Below this, a message reads: 'Please select the Internet connection type from the options below. If you do not know the Internet connection type, contact your ISP.' There are five radio button options: 'DHCP', 'PPPoE', 'Static IP', 'PPTP', and 'L2TP', each with a right-pointing chevron. Below these is a checkbox labeled 'Special Requirement from ISP'. At the bottom right is a blue 'Previous' button.

for PPPoE, PPTP, and L2TP

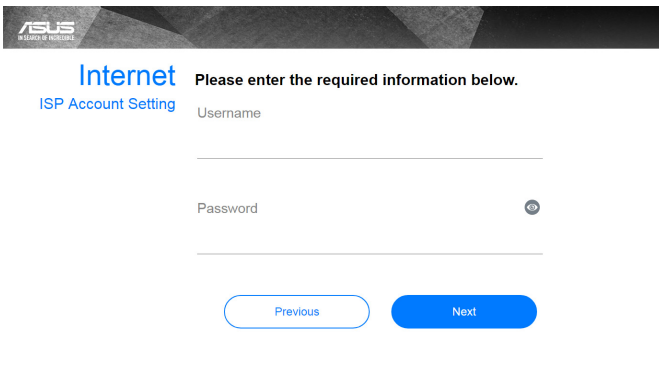

The screenshot shows the 'Internet Account Setting' page. At the top left is the ASUS logo with the tagline 'INSPIRED BY PROBLEMS'. The main heading is 'Internet ISP Account Setting'. Below this, a message reads: 'Please enter the required information below.' There are two input fields: 'Username' and 'Password'. The 'Password' field has a small eye icon to its right. At the bottom are two buttons: a blue 'Previous' button and a blue 'Next' button.

for Static IP



Internet
Static IP

Static IP allows your PC to use a fixed IP address provided by your ISP.

IP Address
192.168.1.215

Subnet Mask
255.255.255.0

Default Gateway
192.168.1.1

DNS Server1
192.168.1.1

DNS Server2

Previous Next

NOTES:

- The auto-detection of your ISP connection type takes place when you configure the wireless router for the first time or when your wireless router is reset to its default settings.
- If QIS failed to detect your Internet connection type, click **Skip to manual setting** and manually configure your connection settings.

3. Assign the wireless network name (SSID) and security key for your 2.4 GHz and 5 GHz wireless connection. Click **Apply** when done.

Wireless
Settings

Assign a unique name or SSID (Service Set Identifier) to help identify your wireless network.

Network Name (SSID)

Wireless Security

Separate 2.4GHz and 5GHz

NOTE: If you want to assign different SSIDs for your 2.4 GHz and 5 GHz wireless connection, tick **Separate 2.4GHz and 5 GHz**.

Wireless
Settings

Assign a unique name or SSID (Service Set Identifier) to help identify your wireless network.

2.4GHz Network Name (SSID)

2.4GHz Wireless Security

5GHz-1 Network Name (SSID)



5GHz-1 Wireless Security

Separate 2.4GHz and 5GHz

2.3 Connecting to your wireless network

After setting up your wireless router via QIS, you can connect your computer or other smart devices to your wireless network.

To connect to your network:

1. On your computer, click the network icon  in the notification area to display the available wireless networks.
2. Select the wireless network that you want to connect to, then click **Connect**.
3. You may need to key in the network security key for a secured wireless network, then click **OK**.
4. Wait while your computer establishes connection to the wireless network successfully. The connection status is displayed and the network icon displays the connected  status.

NOTES:

- Refer to the next chapters for more details on configuring your wireless network's settings.
 - Refer to your device's user manual for more details on connecting it to your wireless network.
-

3 Configuring the General settings

3.1 Using the Network Map

Network Map allows you to configure your network's security settings, manage your network clients, and monitor your USB device.



3.1.1 Setting up the wireless security settings

To protect your wireless network from unauthorized access, you need to configure its security settings.

To set up the wireless security settings:

1. From the navigation panel, go to **General** > **Network Map**.
2. On the Network Map screen and under **System status**, you can configure the wireless security settings such as SSID, security level, and encryption settings.

NOTE: You can set up different wireless security settings for 2.4GHz and 5GHz bands.

2.4GHz security settings

The screenshot shows the 'System Status' screen with the '2.4GHz' tab selected. The 'Smart Connect' toggle is turned off. The 'Wireless name(SSID)' field contains 'ASUS'. The 'Authentication Method' is set to 'WPA2-Personal'. The 'WPA Encryption' is set to 'AES'. The 'WPA-PSK key' field contains seven asterisks. An 'Apply' button is at the bottom.

5GHz-1 security settings

The screenshot shows the 'System Status' screen with the '5GHz-1' tab selected. The 'Smart Connect' toggle is turned off. The 'Wireless name(SSID)' field contains 'ASUS_5G-1'. The 'Authentication Method' is set to 'WPA2-Personal'. The 'WPA Encryption' is set to 'AES'. The 'WPA-PSK key' field contains seven asterisks. An 'Apply' button is at the bottom.

5GHz-2 security settings

The screenshot shows the 'System Status' screen with the '5GHz-2' tab selected. The 'Smart Connect' toggle is turned off. The 'Wireless name(SSID)' field contains 'ASUS_5G-2'. The 'Authentication Method' is set to 'WPA2-Personal'. The 'WPA Encryption' is set to 'AES'. The 'WPA-PSK key' field contains seven asterisks. An 'Apply' button is at the bottom.

3. On the **Wireless name (SSID)** field, key in a unique name for your wireless network.
4. From the **WEP Encryption** dropdown list, select the encryption method for your wireless network.

IMPORTANT! The IEEE 802.11n/ac standard prohibits using High Throughput with WEP or WPA-TKIP as the unicast cipher. If you use these encryption methods, your data rate will drop to IEEE 802.11g 54Mbps connection.

5. Key in your security passkey.
6. Click **Apply** when done.

3.1.2 Managing your network clients

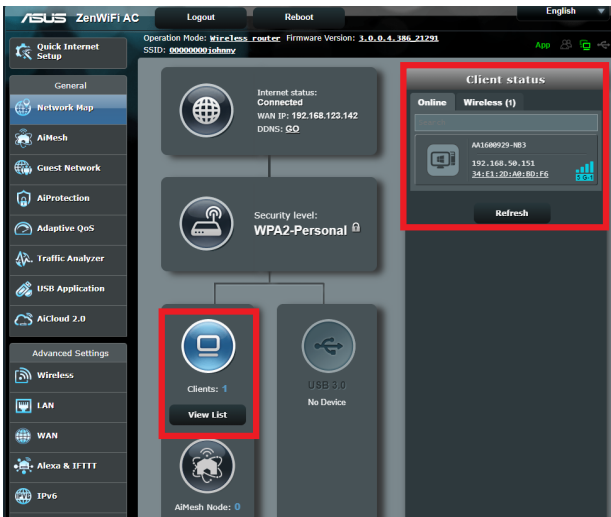

To manage your network clients:

1. From the navigation panel, go to **General > Network Map** tab.
2. On the Network Map screen, select the **Client Status** icon to display your network client's information.
3. To block a client's access to your network, select the client and click **block**.

3.1.3 Monitoring your USB device

The ASUS Wireless Router provides a USB port for connecting a USB device or a USB printer to allow you to share files and printer with clients in your network.

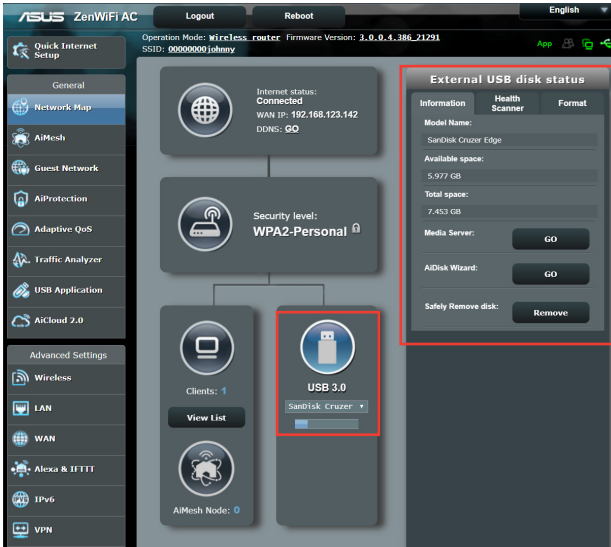

NOTE: To use this feature, you need to plug a USB storage device, such as a USB hard disk or a USB flash drive, to the USB 3.0 port on the rear panel of your wireless router. Ensure that the USB storage device is formatted and partitioned properly. Refer to the Plug-n-Share Disk Support List at <http://event.asus.com/networks/disksupport>.

IMPORTANT! You first need to create a share account and its permission /access rights to allow other network clients to access the USB device via an FTP site/third-party FTP client utility, Servers Center, Samba, or AiCloud 2.0. For more details, refer to the section **3.6 Using the USB Application** and **3.7 Using AiCloud 2.0** in this user manual.

To monitor your USB device:

1. From the navigation panel, go to **General > Network Map**.
2. On the Network Map screen, select the **USB Disk Status** icon to display your USB device's information.
3. On the AiDisk Wizard field, click **GO** to set up an FTP server for Internet file sharing.

NOTES:

- For more details, refer to the section **3.6.2 Using Servers Center** in this user manual.
 - The wireless router works with most USB HDDs/Flash disks (up to 2TB size) and supports read-write access for FAT16, FAT32, EXT2, EXT3, and NTFS.
-

Safely removing the USB disk

IMPORTANT: Incorrect removal of the USB disk may cause data corruption.

To safely remove the USB disk:

1. From the navigation panel, go to **General > Network Map**.
2. In the upper right corner, click  > **Eject USB disk**. When the USB disk is ejected successfully, the USB status shows **Unmounted**.

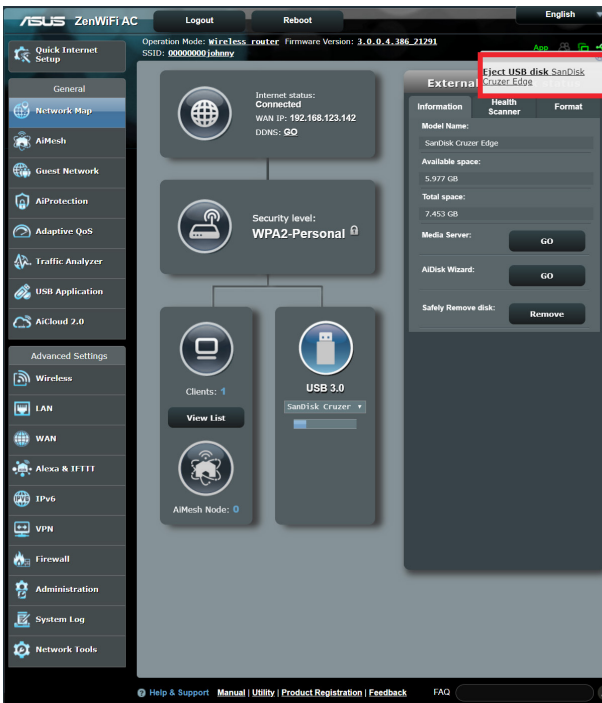

3.2 Creating a Guest Network

The Guest Network provides temporary visitors with Internet connectivity via access to separate SSIDs or networks without providing access to your private network.

NOTE: ZenWiFi AC supports up to nine SSIDs (three 2.4GHz, three 5GHz-1, and three 5GHz-2 SSIDs).

To create a guest network:

1. From the navigation panel, go to **General** > **Guest Network**.
2. On the Guest Network screen, select 2.4GHz or 5GHz frequency band for the guest network that you want to create.
3. Click **Enable**.

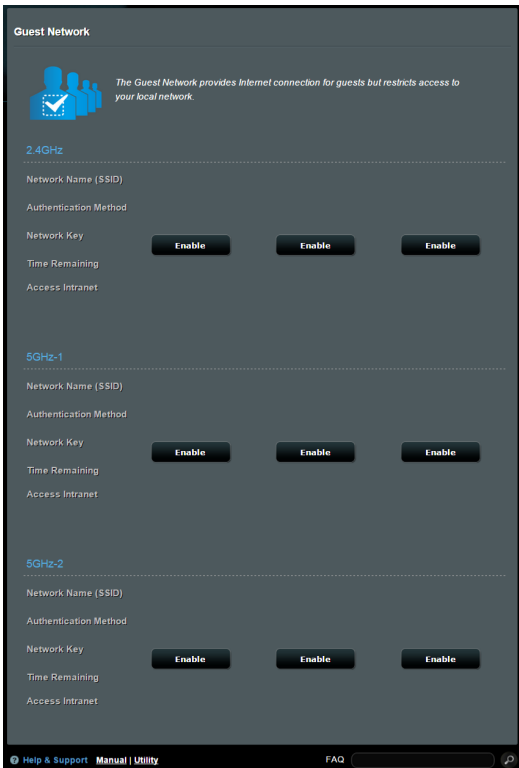

- To change a guest's settings, click the guest settings you want to modify. Click **Remove** to delete the guest's settings.
- Assign a wireless name for your temporary network on the Network Name (SSID) field.

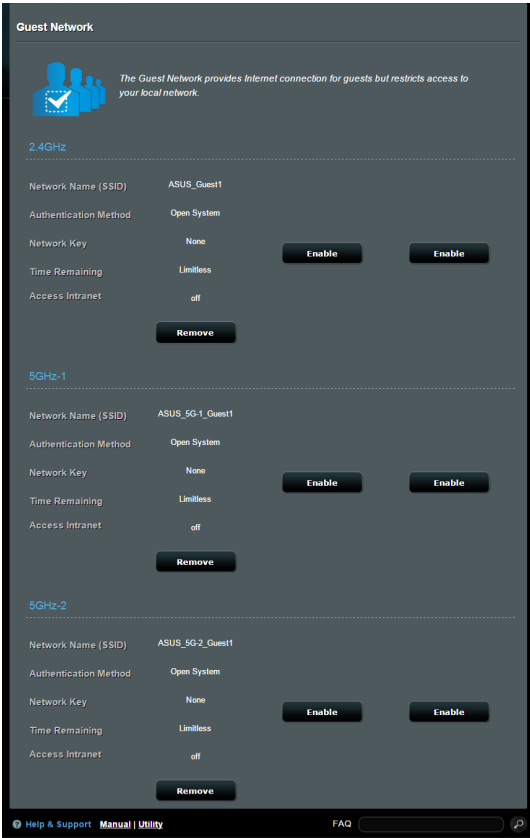

- Select an Authentication Method.
- If you select a WPA authentication method, select a WPA Encryption.
- Specify the Access time or choose **Limitless**.
- Select **Disable** or **Enable** on the Access Intranet item.
- When done, click **Apply**.

3.3 AiProtection

AiProtection provides real-time monitoring that detects malware, spyware, and unwanted access. It also filters unwanted websites and apps and allows you to schedule a time that a connected device is able to access the Internet.



3.3.1 Network Protection

Network Protection prevents network exploits and secures your network from unwanted access.



Configuring Network Protection

To configure Network Protection:

1. From the navigation panel, go to **General > AiProtection**.
2. From the **AiProtection** main page, click on **Network Protection**.
3. From the **Network Protection** tab, click **Scan**.

When done scanning, the utility displays the results on the **Router Security Assessment** page.

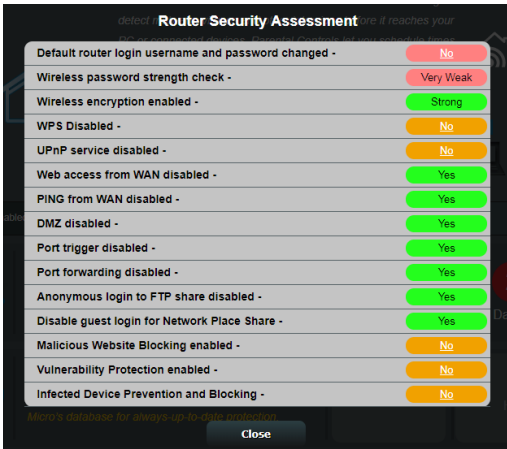

IMPORTANT! Items marked as **Yes** on the **Router Security Assessment** page is considered to be at a **safe** status. Items marked as **No**, **Weak**, or **Very Weak** is highly recommended to be configured accordingly.

4. (Optional) From the **Router Security Assessment** page, manually configure the items marked as **No**, **Weak**, or **Very Weak**. To do this:
 - a. Click an item.

NOTE: When you click an item, the utility forwards you to the item's setting page.

- b. From the item's security settings page, configure and make the necessary changes and click **Apply** when done.
 - c. Go back to the **Router Security Assessment** page and click **Close** to exit the page.
5. To automatically configure the security settings, click **Secure Your Router**.
6. When a message prompt appears, click **OK**.

Malicious Sites Blocking

This feature restricts access to known malicious websites in the cloud database for an always-up-to-date protection.

NOTE: This function is automatically enabled if you run the **Router Weakness Scan**.

To enable Malicious Sites Blocking:

1. From the navigation panel, go to **General > AiProtection**.
2. From the **AiProtection** main page, click on **Network Protection**.
3. From the **Malicious Sites Blocking** pane, click **ON**.

Two-Way IPS

Two-Way IPS (Intrusion Prevention System) protects your router from network attacks by both blocking malicious incoming packets and detecting suspicious outgoing packets.

NOTE: This function is automatically enabled if you run the **Router Weakness Scan**.

To enable Two-Way IPS:

1. From the navigation panel, go to **General > AiProtection**.
2. From the **AiProtection** main page, click on **Network Protection**.
3. From the **Two-Way IPS** pane, click **ON**.

Infected Device Prevention and Blocking

This feature prevents infected devices from communicating personal information or infected status to external parties.

NOTE: This function is automatically enabled if you run the **Router Weakness Scan**.

To enable Infected Device Prevention and Blocking:

1. From the navigation panel, go to **General > AiProtection**.
2. From the **AiProtection** main page, click on **Network Protection**.
3. From the **Infected Device Prevention and Blocking** pane, click **ON**.

To configure Alert Preference:

1. From the **Infected Device Prevention and Blocking** pane, click **Alert Preference**.
2. Select or key in the e-mail provider, e-mail account, and password then click **Apply**.

3.3.2 Setting up Parental Controls

Parental Control allows you to control the Internet access time or set the time limit for a client's network usage.

To go to the Parental Controls main page:

1. From the navigation panel, go to **General > AiProtection**.
2. From the **AiProtection** main page, click on the **Parental Controls** tab.



Web & Apps Filters

Web & Apps Filters is a feature of **Parental Controls** that allows you to block access to unwanted web sites or applications.

To configure Web & Apps Filters:

1. From the navigation panel, go to **General > AiProtection**.
2. From the **AiProtection** main page, click on the **Parental Controls** icon to go to the **Parental Controls** tab.
3. From the **Enable Web & Apps Filters** pane, click **ON**.
4. When the End Users License Agreement (EULA) message prompt appears, click **I agree** to continue.
5. From the **Client List** column, select or key in the client's name from the drop down list box.
6. From the **Content Category** column, select the filters from the four main categories: **Adult, Instant Message and Communication, P2P and File Transfer**, and **Streaming and Entertainment**.
7. Click  to add the client's profile.
8. Click **Apply** to save the settings.

Time Scheduling

Time Scheduling allows you to set the time limit for a client's network usage.

NOTE: Ensure that your system time is synchronized with the NTP server.

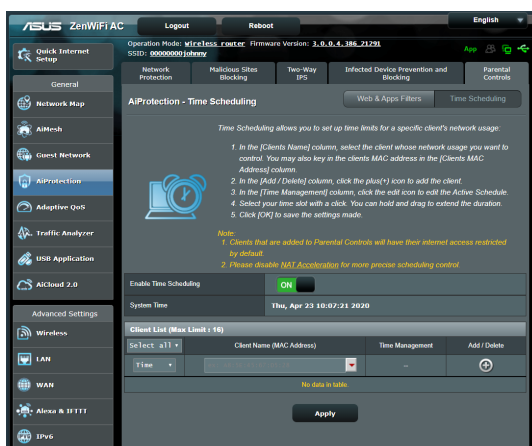

To configure Time Scheduling:

1. From the navigation panel, go to **General > AiProtection > Parental Controls > Time Scheduling**.
2. From the **Enable Time Scheduling** pane, click **ON**.
3. From the **Clients Name** column, select or key in the client's name from the drop down list box.

NOTE: You may also key in the client's MAC address in the **Client MAC Address** column. Ensure that the client name does not contain special characters or spaces as these may cause the router to function abnormally.

4. Click **+** to add the client's profile.
5. Click **Apply** to save the settings.

3.4 Using the Traffic Manager

3.4.1 Managing QoS (Quality of Service) Bandwidth

Quality of Service (QoS) allows you to set the bandwidth priority and manage network traffic.

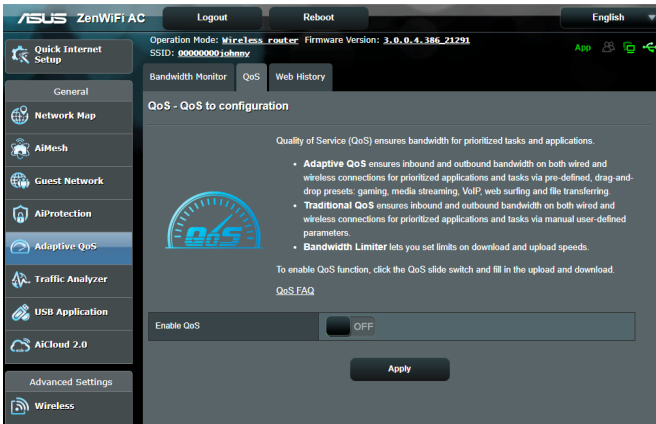

To set up bandwidth priority:

1. From the navigation panel, go to **General > Traffic Manager > QoS** tab.
2. Click **ON** to enable QoS. Fill in the upload and download bandwidth fields.

NOTE: Get the bandwidth information from your ISP.

3. Click **Save**.

NOTE: The User Specify Rule List is for advanced settings. If you want to prioritize specific network applications and network services, select **User-defined QoS rules** or **User-defined Priority** from the drop-down list on the upper-right corner.

4. On the **user-defined QoS rules** page, there are four default online service types – web surf, HTTPS and file transfers. Select your preferred service, fill in the **Source IP or MAC, Destination Port, Protocol, Transferred** and **Priority**, then click **Apply**. The information will be configured in the QoS rules screen.

NOTES:

- To fill in the source IP or MAC, you can:
 - a) Enter a specific IP address, such as "192.168.122.1".
 - b) Enter IP addresses within one subnet or within the same IP pool, such as "192.168.123.*", or "192.168.*.*"
 - c) Enter all IP addresses as "*.*.*.*" or leave the field blank.
 - d) The format for the MAC address is six groups of two hexadecimal digits, separated by colons (:), in transmission order (e.g. 12:34:56:aa:bc:ef)
 - For source or destination port range, you can either:
 - a) Enter a specific port, such as "95".
 - b) Enter ports within a range, such as "103:315", ">100", or "<65535".
 - The **Transferred** column contains information about the upstream and downstream traffic (outgoing and incoming network traffic) for one section. In this column, you can set the network traffic limit (in KB) for a specific service to generate specific priorities for the service assigned to a specific port. For example, if two network clients, PC 1 and PC 2, are both accessing the Internet (set at port 80), but PC 1 exceeds the network traffic limit due to some downloading tasks, PC 1 will have a lower priority. If you do not want to set the traffic limit, leave it blank.
-

5. On the **User-defined Priority** page, you can prioritize the network applications or devices into five levels from the **user-defined QoS rules'** dropdown list. Based on priority level, you can use the following methods to send data packets:
 - Change the order of upstream network packets that are sent to the Internet.
 - Under **Upload Bandwidth** table, set **Minimum Reserved Bandwidth** and **Maximum Bandwidth Limit** for multiple network applications with different priority levels. The percentages indicate the upload bandwidth rates that are available for specified network applications.

NOTES:

- Low-priority packets are disregarded to ensure the transmission of high-priority packets.
- Under **Download Bandwidth** table, set **Maximum Bandwidth Limit** for multiple network applications in corresponding order. The higher priority upstream packet will cause the higher priority downstream packet.
- If there are no packets being sent from high-priority applications, the full transmission rate of the Internet connection is available for low-priority packets.

-
6. Set the highest priority packet. To ensure a smooth online gaming experience, you can set ACK, SYN, and ICMP as the highest priority packet.

NOTE: Ensure to enable QoS first and set up the upload and download rate limits.

3.5 Traffic Analyzer

The traffic monitor feature allows you to access the bandwidth usage and speed of your Internet, wired, or wireless networks. It allows you to monitor network traffic in real-time or on a daily basis. It also offers an option to display the network traffic within the last 24 hours.

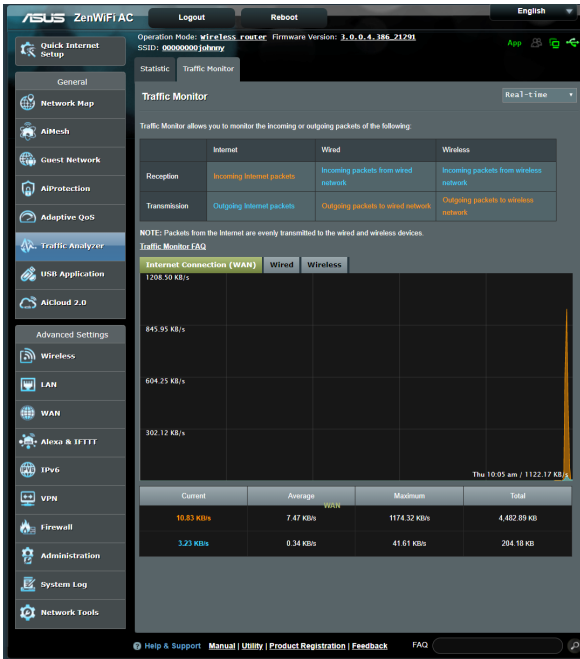

NOTE: Packets from the Internet are evenly transmitted to the wired and wireless devices.

3.6 Using the USB Application

The USB Applications function provides AiDisk, Servers Center, Network Printer Server and Download Master submenus.

IMPORTANT! To use the server functions, you need to insert a USB storage device, such as a USB hard disk or a USB flash drive, in the USB 3.0 port on the rear panel of your wireless router. Ensure that the USB storage device is formatted and partitioned properly. Refer to the ASUS website at <http://event.asus.com/2009/networks/disksupport/> for the file system support table.

3.6.1 Using AiDisk

AiDisk allows you to share files stored on a connected USB device through the Internet. AiDisk also assists you with setting up ASUS DDNS and an FTP server.

To use AiDisk:

1. From the navigation panel, go to **General > USB application**, then click the **AiDisk** icon.
2. From the Welcome to AiDisk wizard screen, click **Go**.

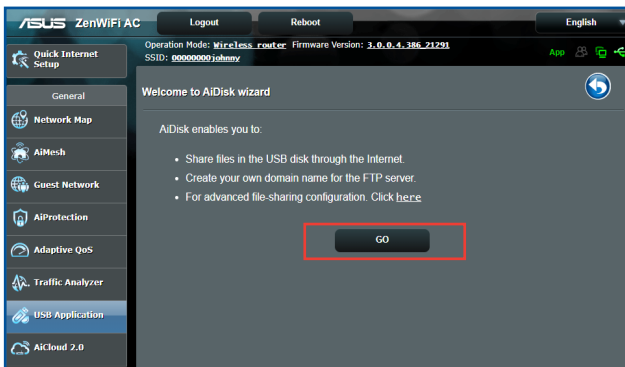

3. Select the access rights that you want to assign to the clients accessing your shared data.

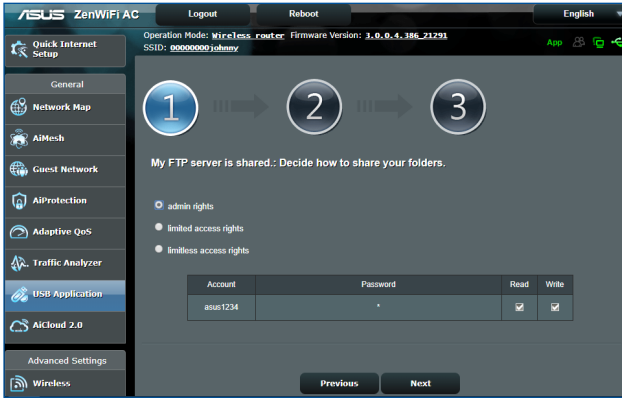

4. Create your domain name via the ASUS DDNS services, read the Terms of Service and then select **I will use the service and accept the Terms of service** and key in your domain name. When done, click **Next**.

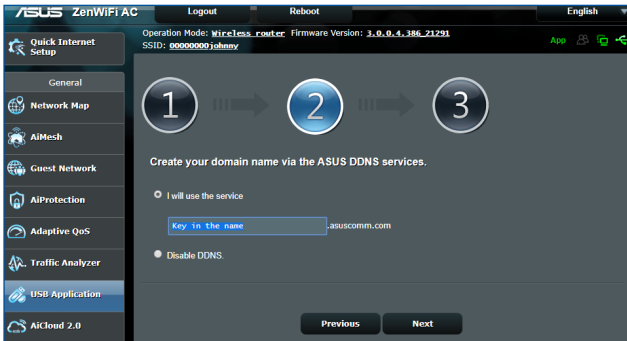

You can also select **Skip ASUS DDNS settings** then click **Next** to skip the DDNS setting.

5. Click **Finish** to complete the setting.
6. To access the FTP site that you created, launch a web browser or a third-party FTP client utility and key in the ftp link (**ftp://<domain name>.asuscomm.com**) you have previously created.

3.6.2 Using Servers Center

Servers Center allows you to share the media files from the USB disk via a Media Server directory, Samba share service, or FTP share service. You can also configure other settings for the USB disk in the Servers Center.

Using Media Server

Your wireless router allows DLNA-supported devices to access multimedia files from the USB disk connected to your wireless router.

NOTE: Before using the DLNA Media Server function, connect your device to ASUS ZenWiFi AC's network.

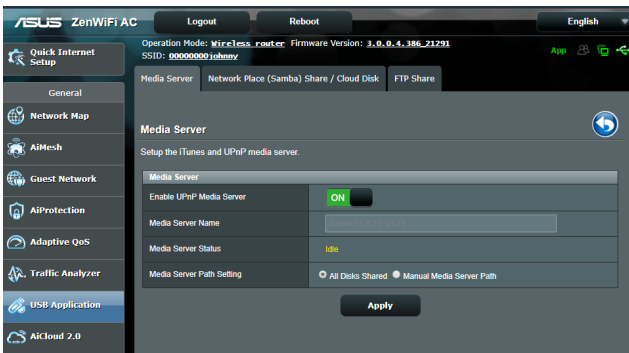

To launch the Media Server setting page, go to **General > USB application > Media Services and Servers > Media Servers** tab. Refer to the following for the descriptions of the fields:

- **Enable iTunes Server?:** Select ON/OFF to enable/disable the iTunes Server.
- **Media Server Status:** Displays the status of the media server.
- **Media Server Path Setting:** Select **All Disks Shared** or **Manual Media Server Path**.

Using Network Place (Samba) Share service

Network Place (Samba) Share allows you to set up the accounts and permissions for the Samba service.

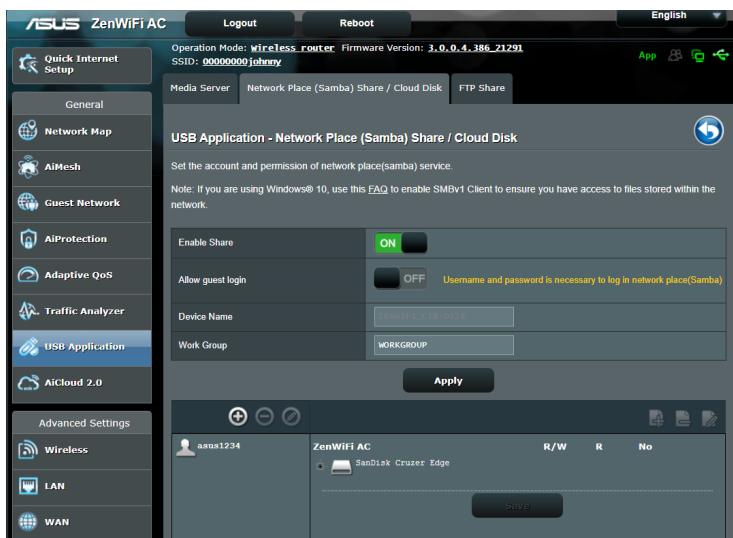

To use Samba share:

1. From the navigation panel, go to **General > USB application > Media Services and Servers > Network Place (Samba) Share / Cloud Disk** tab.

NOTE: Network Place (Samba) Share is enabled by default.

2. Follow the steps below to add, delete, or modify an account.

To create a new account:

- a) Click  to add new account.
- b) In the **Account** and **Password** fields, key in the name and password of your network client. Retype the password to confirm. Click **Add** to add the account to the list.

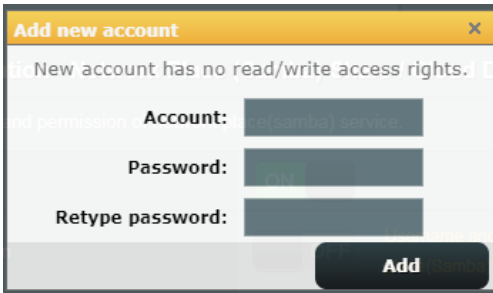

To delete an existing account:

- a) Select the account that you want to delete.
- b) Click .
- c) When prompted, click **Delete** to confirm the account deletion.

To add a folder:

- a) Click .
- b) Enter the folder name, and click **Add**. The folder that you created will be added to the folder list.

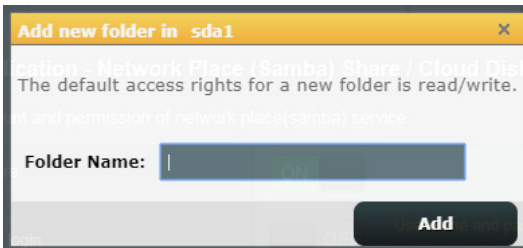

3. From the list of folders, select the type of access permission that you want to assign for specific folders:
 - **R/W:** Select this option to assign read/write access.
 - **R:** Select this option to assign read-only access.
 - **No:** Select this option if you do not want to share a specific file folder.
4. Click **Apply** to apply the changes.

Using the FTP Share service

FTP share enables an FTP server to share files from USB disk to other devices via your local area network or via the Internet.

IMPORTANT:

- Ensure that you safely remove the USB disk. Incorrect removal of the USB disk may cause data corruption.
 - To safely remove the USB disk, refer to the section **Safely removing the USB disk** under **3.1.3 Monitoring your USB device**.
-

To use FTP Share service:

NOTE: Ensure that you have set up your FTP server through AiDisk. For more details, refer to the section **3.6.1 Using AiDisk**.

1. From the navigation panel, click **General > USB application > Media Services and Servers > FTP Share** tab.
2. From the list of folders, select the type of access rights that you want to assign for specific folders:
 - **R/W:** Select to assign read/write access for a specific folder.
 - **W:** Select to assign write only access for a specific folder.
 - **R:** Select to assign read only access for a specific folder.
 - **No:** Select this option if you do not want to share a specific folder.
3. Click **Apply** to confirm the changes.
4. To access the FTP server, key in the ftp link **ftp://<hostname>.asuscomm.com** and your user name and password on a web browser or a third-party FTP utility.

3.6.3 3G/4G

3G/4G USB modems can be connected to ASUS ZenWiFi AC to allow Internet access.

NOTE: For a list of verified USB modems, please visit: <http://event.asus.com/2009/networks/3gsupport/>.

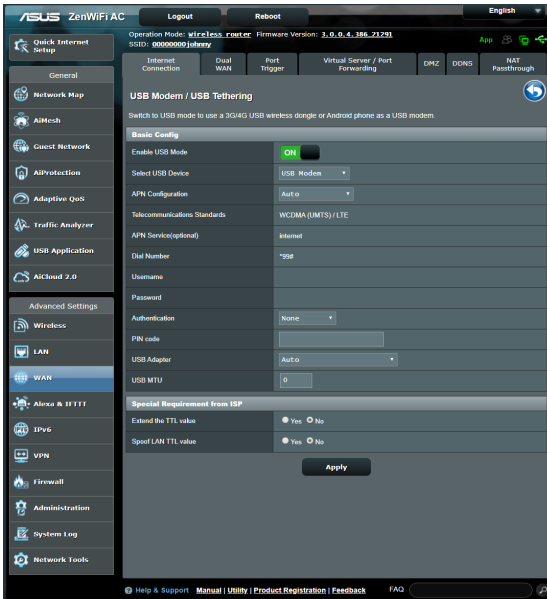

To set up 3G/4G internet access:

1. From the navigation panel, click **General > USB application > 3G/4G**.
2. In the **Enable USB Modem** field, select **Yes**.
3. Set up the following:
 - **Location:** Select your 3G/4G service provider's location from the dropdown list.
 - **ISP:** Select your Internet Service Provider (ISP) from the dropdown list.
 - **APN (Access Point Name) service (optional):** Contact your 3G/4G service provider for detailed information.
 - **Dial Number and PIN code:** The 3G/4G provider's access number and PIN code for connection.

NOTE: PIN code may vary from different providers.

- **Username / Password:** The username and password will be provided by the 3G/4G network carrier.
 - **USB Adapter:** Choose your USB 3G / 4G adapter from the dropdown list. If you are not sure of your USB adapter's model or the model is not listed in the options, select **Auto**.
4. Click **Apply**.

NOTE: The router will reboot for the settings to take effect.

3.7 Using AiCloud 2.0

AiCloud 2.0 is a cloud service application that allows you to save, sync, share, and access your files.

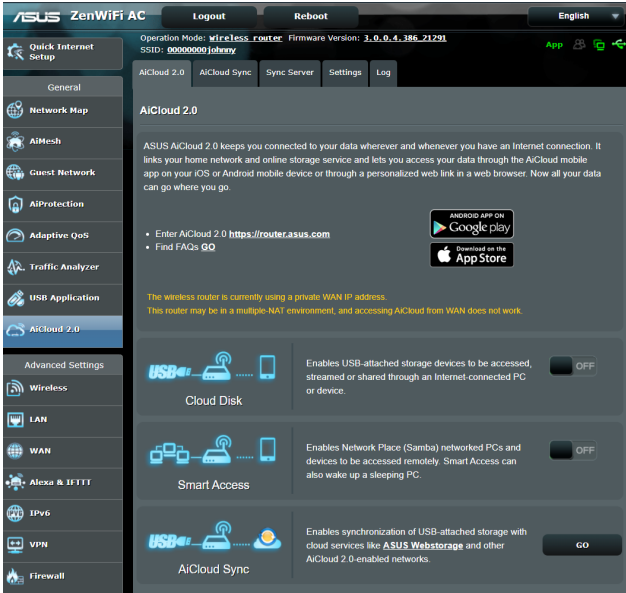

To use AiCloud 2.0:

1. From Google Play Store or Apple Store, download and install the ASUS AiCloud 2.0 app to your smart device.
2. Connect your smart device to your network. Follow the instructions to complete the AiCloud 2.0 setup process.

3.7.1 Cloud Disk

To create a cloud disk:

1. Insert a USB storage device into the wireless router.
2. Turn on **Cloud Disk**.

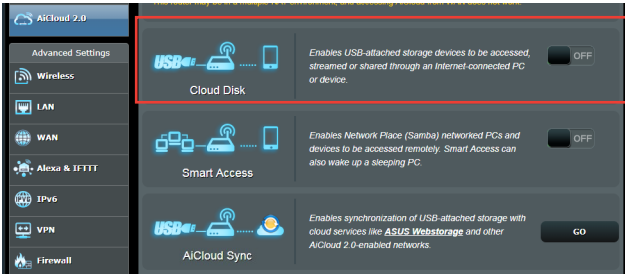

3. Go to <https://router.asus.com> and enter the router login account and password. For better user experience, we recommend that you use **Google Chrome** or **Firefox**.

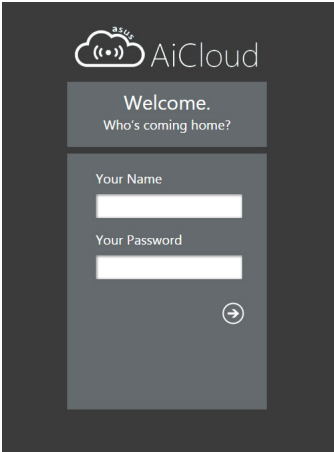

4. You can now start accessing Cloud Disk files on devices connected to the network.

NOTE: When accessing the devices that are connected to the network, you need to enter the device's user name and password manually, which will not be saved by AiCloud 2.0 for security reason.

3.7.2 Smart Access

The Smart Access function allows you to easily access your home network via your router's domain name.

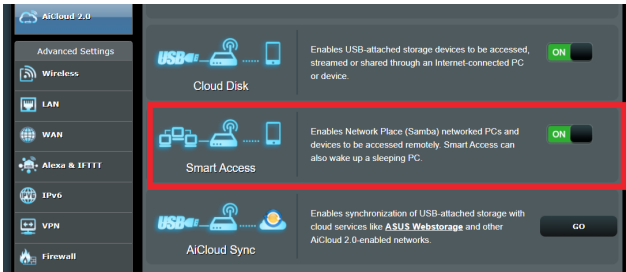

NOTES:

- You can create a domain name for your router with ASUS DDNS. For more details, refer to section **4.3.5 DDNS**.
 - By default, AiCloud 2.0 provides a secure HTTPS connection. Key in [https://\[yourASUSDDNSname\].asuscomm.com](https://[yourASUSDDNSname].asuscomm.com) for a very secure Cloud Disk and Smart Access usage.
-

3.7.3 AiCloud Sync

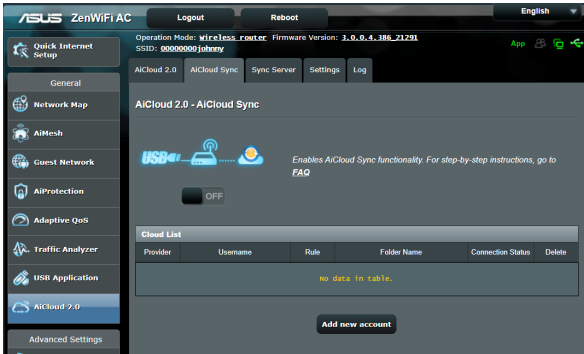

To use AiCloud Sync:

1. Launch AiCloud 2.0, click **AiCloud Sync**.
2. Select **ON** to enable AiCloud Sync.
3. Click **Add new account**.
4. Enter your ASUS WebStorage account password and select the directory that you want to sync with WebStorage.
5. Click **Apply**.

4 Configuring the Advanced Settings

4.1 Wireless

4.1.1 General

The General tab allows you to configure the basic wireless settings.

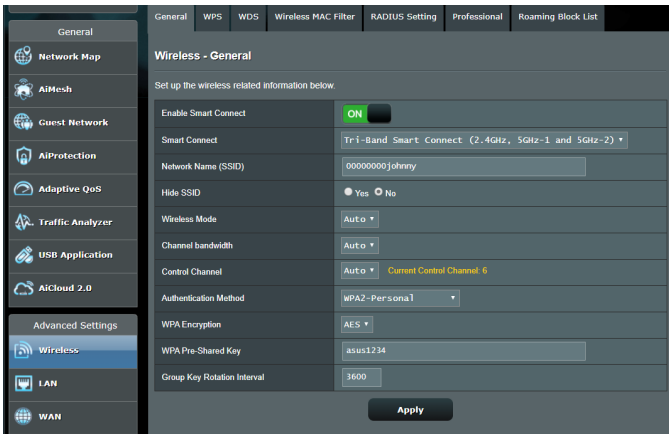

To configure the basic wireless settings:

1. From the navigation panel, go to **Advanced Settings > Wireless > General** tab.
2. Select 2.4GHz or 5GHz as the frequency band for your wireless network.
3. Assign a unique name containing up to 32 characters for your SSID (Service Set Identifier) or network name to identify your wireless network. Wi-Fi devices can identify and connect to the wireless network via your assigned SSID. The SSIDs on the information banner are updated once new SSIDs are saved to the settings.

NOTE: You can assign unique SSIDs for the 2.4 GHz and 5GHz frequency bands.

4. In the **Hide SSID** field, select **Yes** to prevent wireless devices from detecting your SSID. When this function is enabled, you would need to enter the SSID manually on the wireless device to access the wireless network.
5. Select any of these wireless mode options to determine the types of wireless devices that can connect to your wireless router:
 - **Auto:** Select **Auto** to allow 802.11AC, 802.11n, 802.11g, and 802.11b devices to connect to the wireless router.
 - **Legacy:** Select **Legacy** to allow 802.11b/g/n devices to connect to the wireless router. Hardware that supports 802.11n natively, however, will only run at a maximum speed of 54Mbps.
 - **N only:** Select **N only** to maximize wireless N performance. This setting prevents 802.11g and 802.11b devices from connecting to the wireless router.
6. Select any of these channel bandwidth to accommodate higher transmission speeds:
 - 40MHz:** Select this bandwidth to maximize the wireless throughput.
 - 20MHz (default):** Select this bandwidth if you encounter some issues with your wireless connection.
7. Select the operating channel for your wireless router. Select **Auto** to allow the wireless router to automatically select the channel that has the least amount of interference.
8. Select any of these authentication methods:
 - **Open System:** This option provides no security.
 - **Shared Key:** You must use WEP encryption and enter at least one shared key.

- **WPA/WPA2 Personal/WPA Auto-Personal:** This option provides strong security. You can use either WPA (with TKIP) or WPA2 (with AES). If you select this option, you must use TKIP + AES encryption and enter the WPA passphrase (network key).
- **WPA/WPA2 Enterprise/WPA Auto-Enterprise:** This option provides very strong security. It is with integrated EAP server or an external RADIUS back-end authentication server.
- **Radius with 802.1x**

NOTE: Your wireless router supports the maximum transmission rate of 54Mbps when the **Wireless Mode** is set to **Auto** and **encryption method** is **WEP** or **TKIP**.

9. Select any of these WEP (Wired Equivalent Privacy) Encryption options for the data transmitted over your wireless network:
 - **Off:** Disables WEP encryption
 - **64-bit:** Enables weak WEP encryption
 - **128-bit:** Enables improved WEP encryption
10. When done, click **Apply**.

4.1.2 WPS

WPS (Wi-Fi Protected Setup) is a wireless security standard that allows you to easily connect devices to a wireless network. You can configure the WPS function via the PIN code or WPS button.

NOTE: Ensure that the devices support WPS.

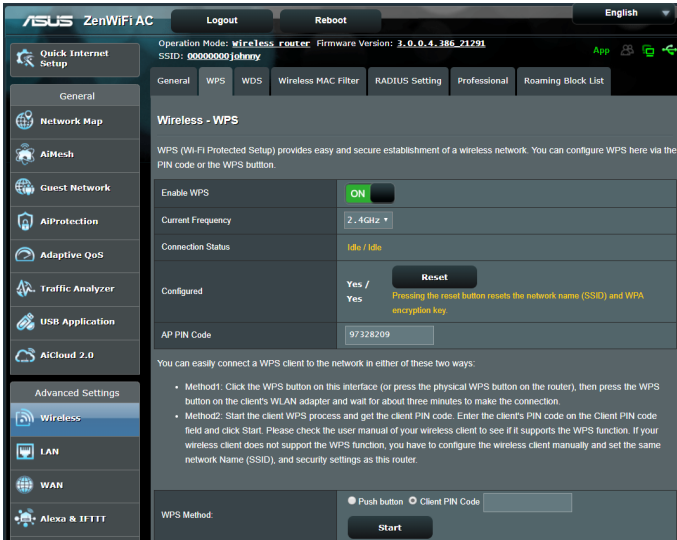

To enable WPS on your wireless network:

1. From the navigation panel, go to **Advanced Settings > Wireless > WPS** tab.
2. In the **Enable WPS** field, move the slider to **ON**.
3. WPS uses 2.4GHz by default. If you want to change the frequency to 5GHz, turn **OFF** the WPS function, click **Switch Frequency** in the **Current Frequency** field, and turn **WPS ON** again.

NOTE: WPS supports authentication using Open System, WPA-Personal, and WPA2-Personal. WPS does not support a wireless network that uses a Shared Key, WPA-Enterprise, WPA2-Enterprise, and RADIUS encryption method.

3. In the WPS Method field, select **Push Button** or **Client PIN** code. If you select **Push Button**, go to step 4. If you select **Client PIN** code, go to step 5.
4. To set up WPS using the router's WPS button, follow these steps:
 - a. Click **Start** or press the WPS button found at the rear of the wireless router.
 - b. Press the WPS button on your wireless device. This is normally identified by the WPS logo.

NOTE: Check your wireless device or its user manual for the location of the WPS button.

- c. The wireless router will scan for any available WPS devices. If the wireless router does not find any WPS devices, it will switch to standby mode.
5. To set up WPS using the Client's PIN code, follow these steps:
 - a. Locate the WPS PIN code on your wireless device's user manual or on the device itself.
 - b. Key in the Client PIN code on the text box.
 - c. Click **Start** to put your wireless router into WPS survey mode. The router's LED indicators quickly flash three times until the WPS setup is completed.

4.1.3 Bridge

Bridge or WDS (Wireless Distribution System) allows your ASUS wireless router to connect to another wireless access point exclusively, preventing other wireless devices or stations to access your ASUS wireless router. It can also be considered as a wireless repeater where your ASUS wireless router communicates with another access point and other wireless devices.

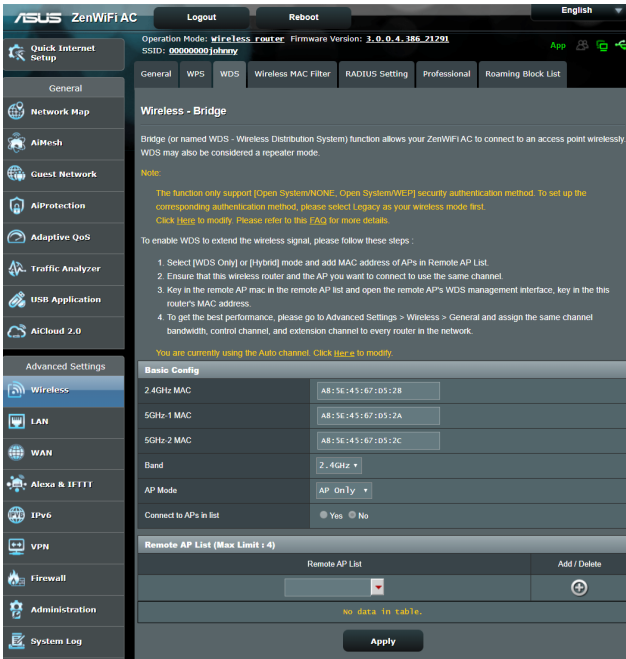

To set up the wireless bridge:

1. From the navigation panel, go to **Advanced Settings > Wireless > WDS** tab.
2. Select the frequency band for the wireless bridge.
3. In the **AP Mode** field, select any of these options:
 - **AP Only:** Disables the Wireless Bridge function.
 - **WDS Only:** Enables the Wireless Bridge feature but prevents other wireless devices/stations from connecting to the router.

- **HYBRID:** Enables the Wireless Bridge feature and allows other wireless devices/stations to connect to the router.

NOTE: In Hybrid mode, wireless devices connected to the ASUS wireless router will only receive half the connection speed of the Access Point.

4. In the **Connect to APs in list** field, click **Yes** if you want to connect to an Access Point listed in the Remote AP List.
5. In the **Control Channel** field, select the operating channel for the wireless bridge. Select **Auto** to allow the router to automatically select the channel with the least amount of interference.

NOTE: Channel availability varies per country or region.

6. On the Remote AP List, key in a MAC address and click the **Add** button  to enter the MAC address of other available Access Points.

NOTE: Any Access Point added to the list should be on the same Control Channel as the ASUS wireless router.

7. Click **Apply**.

4.1.4 Wireless MAC Filter

Wireless MAC filter provides control over packets transmitted to a specified MAC (Media Access Control) address on your wireless network.

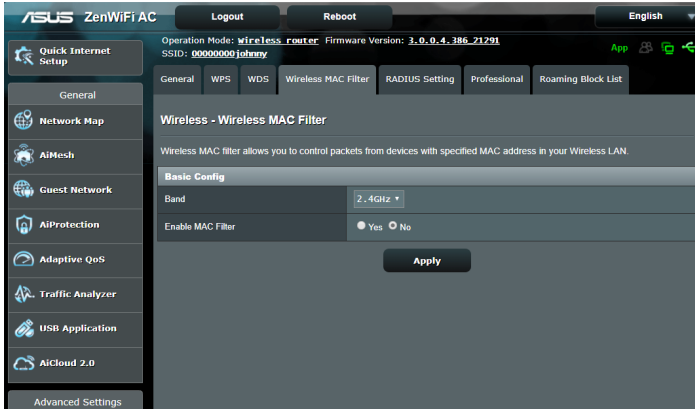

To set up the Wireless MAC filter:

1. From the navigation panel, go to **Advanced Settings > Wireless > Wireless MAC Filter** tab.
2. Tick **Yes** in the **Enable Mac Filter** field.
3. In the **MAC Filter Mode** dropdown list, select either **Accept** or **Reject**.
 - Select **Accept** to allow devices in the MAC filter list to access to the wireless network.
 - Select **Reject** to prevent devices in the MAC filter list to access to the wireless network.
4. On the MAC filter list, click the **Add**  button and key in the MAC address of the wireless device.
5. Click **Apply**.

4.1.5 RADIUS Setting

RADIUS (Remote Authentication Dial In User Service) Setting provides an extra layer of security when you choose WPA-Enterprise, WPA2-Enterprise, or Radius with 802.1x as your Authentication Mode.

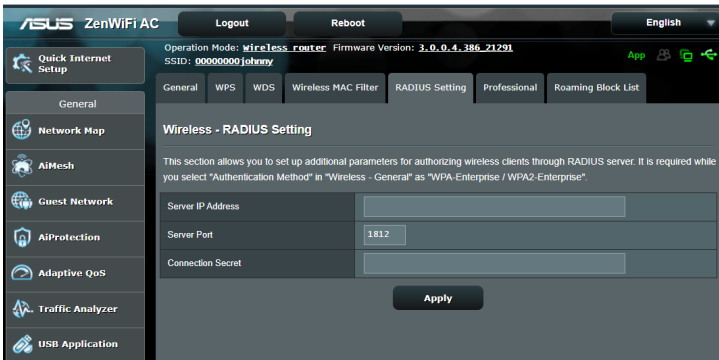

To set up wireless RADIUS settings:

1. Ensure that the wireless router's authentication mode is set to WPA-Enterprise, WPA2-Enterprise, or Radius with 802.1x.

NOTE: Please refer to section **4.1.1 General** section for configuring your wireless router's Authentication Mode.

2. From the navigation panel, go to **Advanced Settings > Wireless > RADIUS Setting**.
3. Select the frequency band.
4. In the **Server IP Address** field, key in your RADIUS server's IP Address.
5. In the **Connection Secret** field, assign the password to access your RADIUS server.
6. Click **Apply**.

4.1.6 Professional

The Professional screen provides advanced configuration options.

NOTE: We recommend that you use the default values on this page.

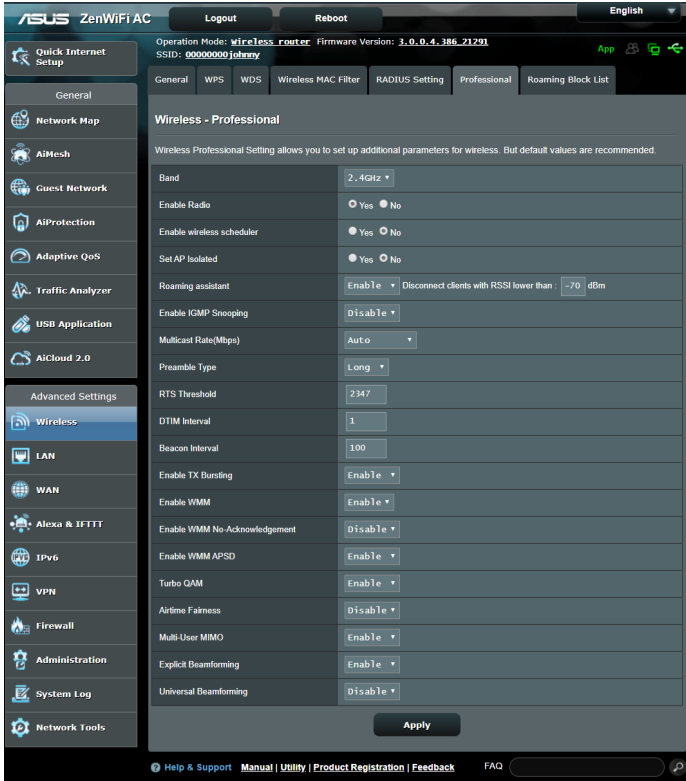

In the **Professional Settings** screen, you can configure the following:

- **Frequency:** Select the frequency band that the professional settings will be applied to.
- **Enable Radio:** Select **Yes** to enable wireless networking. Select **No** to disable wireless networking.
- **Enable wireless scheduler:** You can choose clock format as 24-hour or 12-hour. The color in the table indicates Allow or Deny. Click each frame to change the settings of the hour of the weekdays and click **OK** when done.

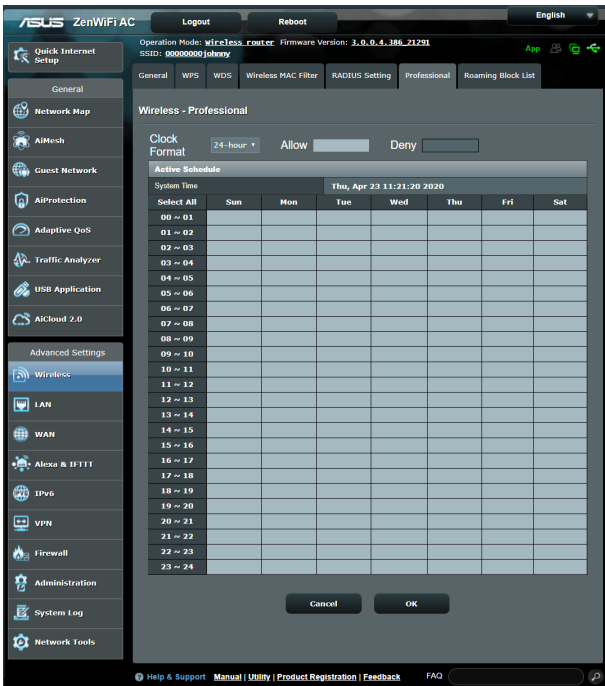

- **Set AP isolated:** The Set AP isolated item prevents wireless devices on your network from communicating with each other. This feature is useful if many guests frequently join or leave your network. Select **Yes** to enable this feature or select **No** to disable.
- **Multicast rate (Mbps):** Select the multicast transmission rate or click **Disable** to switch off simultaneous single transmission.
- **Preamble Type:** Preamble Type defines the length of time that the router spent for CRC (Cyclic Redundancy Check). CRC is a method of detecting errors during data transmission. Select **Short** for a busy wireless network with high network traffic. Select **Long** if your wireless network is composed of older or legacy wireless devices.

- **RTS Threshold:** Select a lower value for RTS (Request to Send) Threshold to improve wireless communication in a busy or noisy wireless network with high network traffic and numerous wireless devices.
- **DTIM Interval:** DTIM (Delivery Traffic Indication Message) Interval or Data Beacon Rate is the time interval before a signal is sent to a wireless device in sleep mode indicating that a data packet is awaiting delivery. The default value is three milliseconds.
- **Beacon Interval:** Beacon Interval is the time between one DTIM and the next. The default value is 100 milliseconds. Lower the Beacon Interval value for an unstable wireless connection or for roaming devices.
- **Enable TX Bursting:** Enable TX Bursting improves transmission speed between the wireless router and 802.11g devices.
- **Enable WMM APSD:** Enable WMM APSD (Wi-Fi Multimedia Automatic Power Save Delivery) to improve power management between wireless devices. Select **Disable** to switch off WMM APSD.

4.2 LAN

4.2.1 LAN IP

The LAN IP screen allows you to modify the LAN IP settings of your wireless router.

NOTE: Any changes to the LAN IP address will be reflected on your DHCP settings.

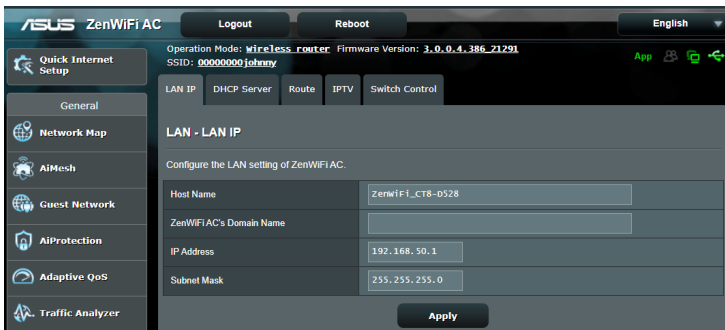

To modify the LAN IP settings:

1. From the navigation panel, go to **Advanced Settings > LAN > LAN IP** tab.
2. Modify the **IP address** and **Subnet Mask**.
3. When done, click **Apply**.

4.2.2 DHCP Server

Your wireless router uses DHCP to assign IP addresses automatically on your network. You can specify the IP address range and lease time for the clients on your network.

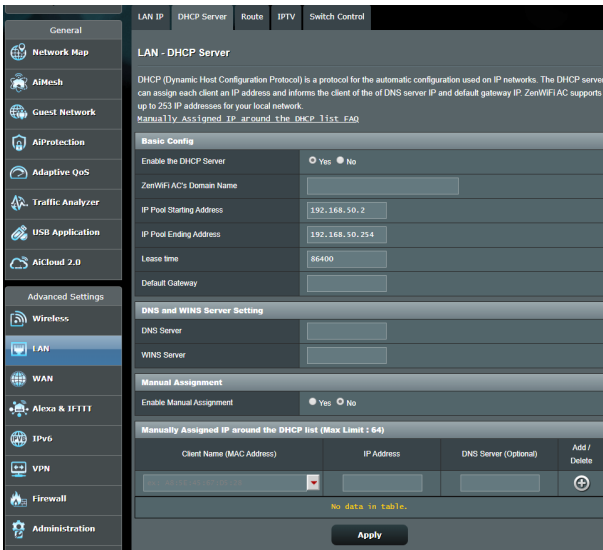

To configure the DHCP server:

1. From the navigation panel, go to **Advanced Settings > LAN > DHCP Server** tab.
2. In the **Enable the DHCP Server** field, tick **Yes**.
3. In the **Domain Name** text box, enter a domain name for the wireless router.
4. In the **IP Pool Starting Address** field, key in the starting IP address.
5. In the **IP Pool Ending Address** field, key in the ending IP address.
6. In the **Lease Time** field, specify in seconds when an assigned IP address will expire. Once it reaches this time limit, the DHCP server will then assign a new IP address.

NOTES:

- We recommend that you use an IP address format of 192.168.1.xxx (where xxx can be any number between 2 and 254) when specifying an IP address range.
 - An IP Pool Starting Address should not be greater than the IP Pool Ending Address.
-

7. In the **DNS and Server Settings** section, key in your DNS Server and WINS Server IP address if needed.
8. Your wireless router can also manually assign IP addresses to devices on the network. On the **Enable Manual Assignment** field, choose **Yes** to assign an IP address to specific MAC addresses on the network. Up to 32 MAC Addresses can be added to the DHCP list for manual assignment.



4.2.3 Route

If your network makes use of more than one wireless router, you can configure a routing table to share the same Internet service.

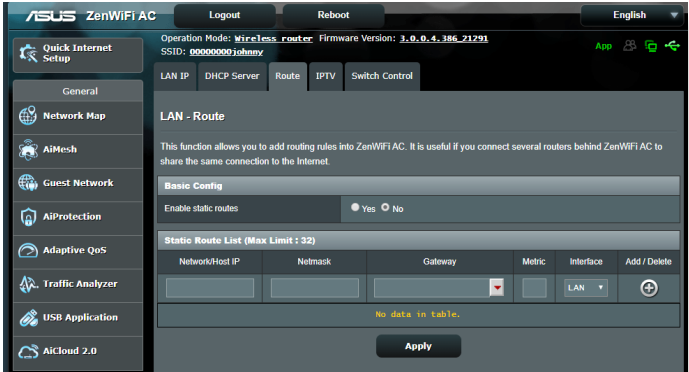
NOTE: We recommend that you do not change the default route settings unless you have advanced knowledge of routing tables.



To configure the LAN Routing table:

1. From the navigation panel, go to **Advanced Settings > LAN > Route** tab.
2. On the **Enable static routes** field, choose **Yes**.
3. On the **Static Route List**, enter the network information of other access points or nodes. Click the **Add**  or **Delete**  button to add or remove a device on the list.
4. Click **Apply**.

4.2.4 IPTV

The wireless router supports connection to IPTV services through an ISP or a LAN. The IPTV tab provides the configuration settings needed to set up IPTV, VoIP, multicasting, and UDP for your service. Contact your ISP for specific information regarding your service.

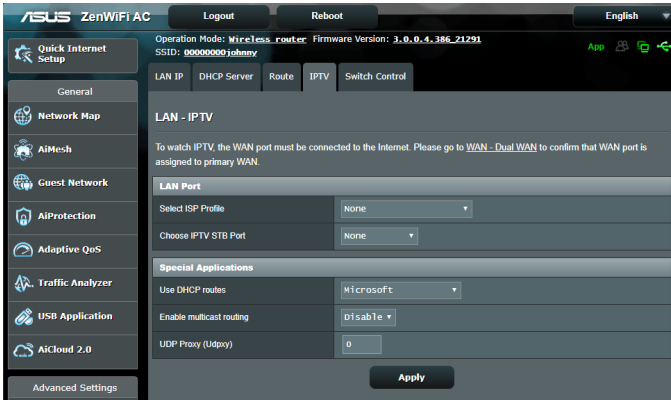

4.3 WAN

4.3.1 Internet Connection

The Internet Connection screen allows you to configure the settings of various WAN connection types.

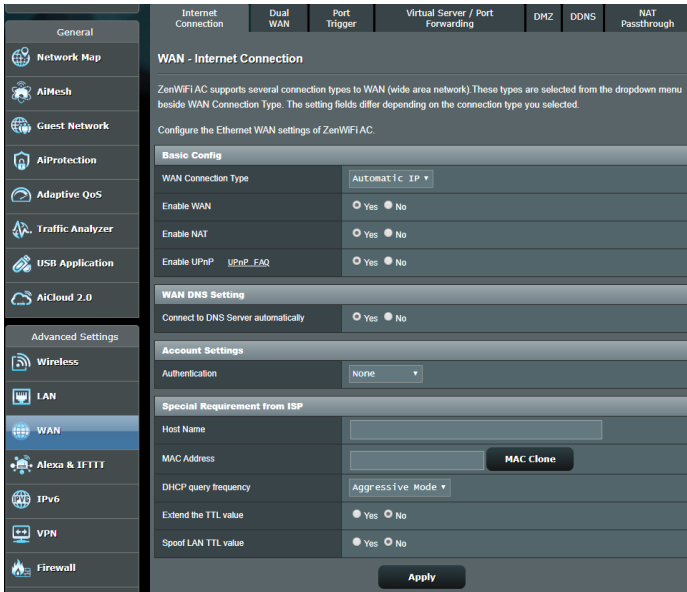

To configure the WAN connection settings:

1. From the navigation panel, go to **Advanced Settings > WAN > Internet Connection** tab.
2. Configure the following settings below. When done, click **Apply**.
 - **WAN Connection Type:** Choose your Internet Service Provider type. The choices are **Automatic IP**, **PPPoE**, **PPTP**, **L2TP** or **fixed IP**. Consult your ISP if the router is unable to obtain a valid IP address or if you are unsure the WAN connection type.
 - **Enable WAN:** Select **Yes** to allow the router Internet access. Select **No** to disable Internet access.

- **Enable NAT:** NAT (Network Address Translation) is a system where one public IP (WAN IP) is used to provide Internet access to network clients with a private IP address in a LAN. The private IP address of each network client is saved in a NAT table and is used to route incoming data packets.
- **Enable UPnP:** UPnP (Universal Plug and Play) allows several devices (such as routers, televisions, stereo systems, game consoles, and cellular phone), to be controlled via an IP-based network with or without a central control through a gateway. UPnP connects PCs of all form factors, providing a seamless network for remote configuration and data transfer. Using UPnP, a new network device is discovered automatically. Once connected to the network, devices can be remotely configured to support P2P applications, interactive gaming, video conferencing, and web or proxy servers. Unlike Port forwarding, which involves manually configuring port settings, UPnP automatically configures the router to accept incoming connections and direct requests to a specific PC on the local network.
- **Connect to DNS Server:** Allows this router to get the DNS IP address from the ISP automatically. A DNS is a host on the Internet that translates Internet names to numeric IP addresses.
- **Authentication:** This item may be specified by some ISPs. Check with your ISP and fill them in if required.
- **Host Name:** This field allows you to provide a host name for your router. It is usually a special requirement from your ISP. If your ISP assigned a host name to your computer, enter the host name here.

- **MAC Address:** MAC (Media Access Control) address is a unique identifier for your networking device. Some ISPs monitor the MAC address of networking devices that connect to their service and reject any unrecognized device that attempt to connect. To avoid connection issues due to an unregistered MAC address, you can:
 - Contact your ISP and update the MAC address associated with your ISP service.
 - Clone or change the MAC address of the ASUS wireless router to match the MAC address of the previous networking device recognized by the ISP.

4.3.2 Port Trigger

Port range triggering opens a predetermined incoming port for a limited period of time whenever a client on the local area network makes an outgoing connection to a specified port. Port triggering is used in the following scenarios:

- More than one local client needs port forwarding for the same application at a different time.
- An application requires specific incoming ports that are different from the outgoing ports.

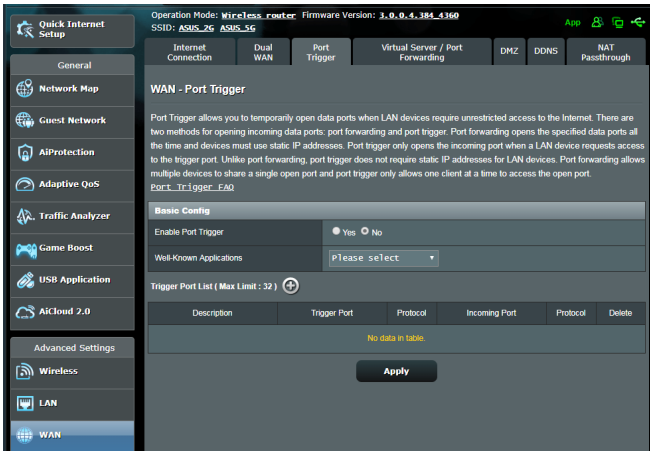

To set up Port Trigger:

1. From the navigation panel, go to **Advanced Settings > WAN > Port Trigger** tab.
2. Configure the following settings below. When done, click **Apply**.
 - **Enable Port Trigger:** Choose **Yes** to enable Port Trigger.
 - **Well-Known Applications:** Select popular games and web services to add to the Port Trigger List.
 - **Description:** Enter a short name or description for the service.

- **Trigger Port:** Specify a trigger port to open the incoming port.
- **Protocol:** Select the protocol, TCP, or UDP.
- **Incoming Port:** Specify an incoming port to receive inbound data from the Internet.

NOTES:

- When connecting to an IRC server, a client PC makes an outgoing connection using the trigger port range 66660-7000. The IRC server responds by verifying the username and creating a new connection to the client PC using an incoming port.
 - If Port Trigger is disabled, the router drops the connection because it is unable to determine which PC is requesting for IRC access. When Port Trigger is enabled, the router assigns an incoming port to receive the inbound data. This incoming port closes once a specific time period has elapsed because the router is unsure when the application has been terminated.
 - Port triggering only allows one client in the network to use a particular service and a specific incoming port at the same time.
 - You cannot use the same application to trigger a port in more than one PC at the same time. The router will only forward the port back to the last computer to send the router a request/trigger.
-

4.3.3 Virtual Server/Port Forwarding

Port forwarding is a method to direct network traffic from the Internet to a specific port or a specific range of ports to a device or number of devices on your local network. Setting up Port Forwarding on your router allows PCs outside the network to access specific services provided by a PC in your network.

NOTE: When port forwarding is enabled, the ASUS router blocks unsolicited inbound traffic from the Internet and only allows replies from outbound requests from the LAN. The network client does not have access to the Internet directly, and vice versa.

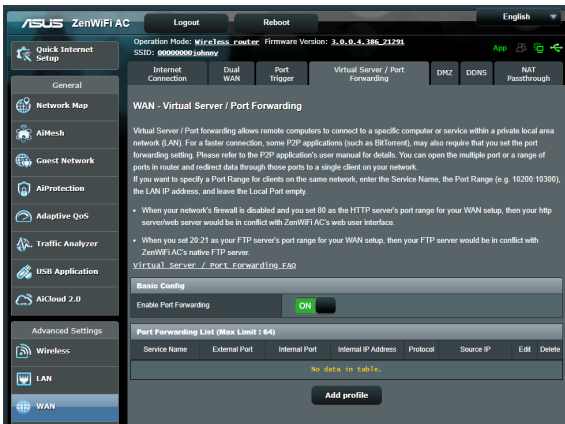

To set up Port Forwarding:

1. From the navigation panel, go to **Advanced Settings > WAN > Virtual Server / Port Forwarding** tab.
2. Slide the bar to **ON** to enable Port Forwarding, then click **Add Profile**. After configuring the following settings, click **OK**.

Quick Select	
Famous Server List	Please select ▾
Famous Game List	Please select ▾
Custom Configuration	
Service Name	<input type="text"/> * Optional
Protocol	TCP ▾
External Port	<input type="text"/>
Internal Port	<input type="text"/> * Optional
Internal IP Address	<input type="text"/> ▾
Source IP	<input type="text"/> * Optional
<p>* External Port The External Port accepts the following formats</p> <ol style="list-style-type: none"> 1. Port ranges using a colon ":" between the starting and ending port, such as 300:350. 2. Single ports using a comma "," between individual ports, such as 566, 789. 3. A Mix of port ranges and single ports, using colons ":" and commas ",", such as 1015:1024, 3021. <p>* Source IP If you want to open your port to a specific IP address from the internet, input the IP address you want to specify in the Source IP field.</p>	
<input type="button" value="Cancel"/> <input type="button" value="OK"/>	

- **Famous Server List:** Determine which type of service you want to access.
- **Famous Game List:** This item lists ports required for popular online games to work correctly.
- **Service Name:** Enter a service name.
- **Protocol:** Select the protocol. If you are unsure, select **BOTH**.
- **External Port:** Accept the following formats:
 - 1) A port range using a colon ":" in the middle to specify the upper and lower limits of the range, such as 300:350;
 - 2) Individual port numbers using a comma "," to separate them, such as 566, 789;
 - 3) A Mix of port ranges and individual ports, using colons ":" and commas ",", such as 1015:1024, 3021.
- **Internal Port:** Enter a specific port to receive forwarded packets. Leave this field blank if you want the incoming packets to be redirected to the specified port range.

- **Internal IP Address:** Key in the client's LAN IP address.
- **Source IP:** If you want to open your port to a specific IP address from the Internet, input the IP address you want to give access to in this field.

NOTE: Use a static IP address for the local client to make port forwarding work properly. Refer to section **4.2 LAN** for information.

To check if Port Forwarding has been configured successfully:

- Ensure that your server or application is set up and running.
- You will need a client outside your LAN but has Internet access (referred to as "Internet client"). This client should not be connected to the ASUS router.
- On the Internet client, use the router's WAN IP to access the server. If port forwarding has been successful, you should be able to access the files or applications.

Differences between port trigger and port forwarding:

- Port triggering will work even without setting up a specific LAN IP address. Unlike port forwarding, which requires a static LAN IP address, port triggering allows dynamic port forwarding using the router. Predetermined port ranges are configured to accept incoming connections for a limited period of time. Port triggering allows multiple computers to run applications that would normally require manually forwarding the same ports to each PC on the network.
- Port triggering is more secure than port forwarding since the incoming ports are not open all the time. They are opened only when an application is making an outgoing connection through the trigger port.

4.3.4 DMZ

Virtual DMZ exposes one client to the Internet, allowing this client to receive all inbound packets directed to your Local Area Network.

Inbound traffic from the Internet is usually discarded and routed to a specific client only if port forwarding or a port trigger has been configured on the network. In a DMZ configuration, one network client receives all inbound packets.

Setting up DMZ on a network is useful when you need incoming ports open or you want to host a domain, web, or e-mail server.

CAUTION: Opening all the ports on a client to the Internet makes the network vulnerable to outside attacks. Please be aware of the security risks involved in using DMZ.

To set up DMZ:

1. From the navigation panel, go to **Advanced Settings > WAN > DMZ** tab.
2. Configure the setting below. When done, click **Apply**.
 - **IP address of Exposed Station:** Key in the client's LAN IP address that will provide the DMZ service and be exposed on the Internet. Ensure that the server client has a static IP address.

To remove DMZ:

1. Delete the client's LAN IP address from the **IP Address of Exposed Station** text box.
2. When done, click **Apply**.

4.3.5 DDNS

Setting up DDNS (Dynamic DNS) allows you to access the router from outside your network through the provided ASUS DDNS Service or another DDNS service.

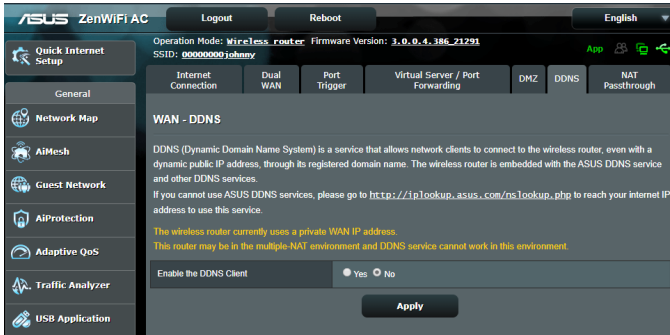

To set up DDNS:

1. From the navigation panel, go to **Advanced Settings > WAN > DDNS** tab.
2. Configure the following settings below. When done, click **Apply**.
 - **Enable the DDNS Client:** Enable DDNS to access the ASUS router via the DNS name rather than WAN IP address.
 - **Server and Host Name:** Choose ASUS DDNS or other DDNS. If you want to use ASUS DDNS, fill in the Host Name in the format of xxx.asuscomm.com (xxx is your host name).
 - If you want to use a different DDNS service, click FREE TRIAL and register online first. Fill in the User Name or E-mail Address and Password or DDNS Key fields.

- **Enable wildcard:** Enable wildcard if your DDNS service requires one.

NOTES:

DDNS service will not work under these conditions:

- When the wireless router is using a private WAN IP address (192.168.x.x, 10.x.x.x, or 172.16.x.x), as indicated by a yellow text.
 - The router may be on a network that uses multiple NAT tables.
-

4.3.6 NAT Passthrough

NAT Passthrough allows a Virtual Private Network (VPN) connection to pass through the router to the network clients. PPTP Passthrough, L2TP Passthrough, IPsec Passthrough and RTSP Passthrough are enabled by default.

To enable / disable the NAT Passthrough settings, go to the **Advanced Settings > WAN > NAT Passthrough** tab. When done, click **Apply**.

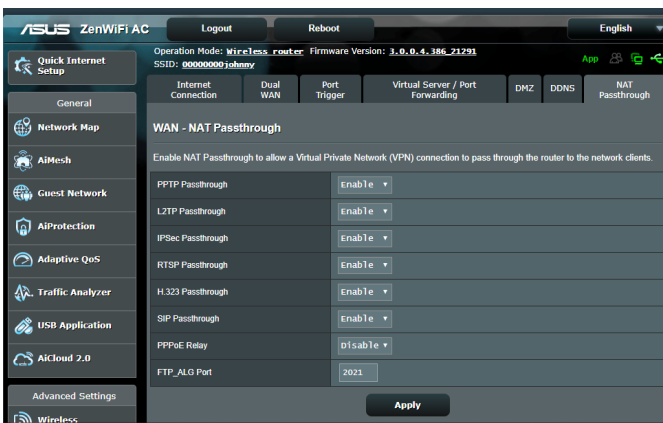

4.4 IPv6

This wireless router supports IPv6 addressing, a system that supports more IP addresses. This standard is not yet widely available. Contact your ISP if your Internet service supports IPv6.

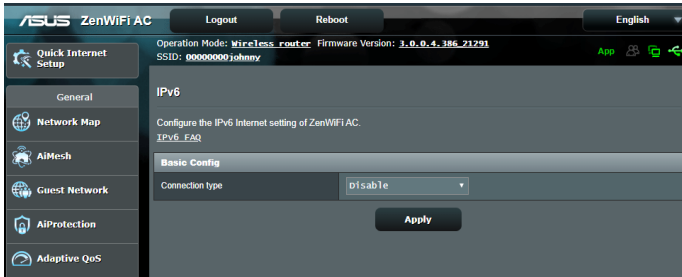

To set up IPv6:

1. From the navigation panel, go to **Advanced Settings** > **IPv6**.
2. Select your **Connection Type**. The configuration options vary depending on your selected connection type.
3. Enter your IPv6 LAN and DNS settings.
4. Click **Apply**.

NOTE: Please refer to your ISP regarding specific IPv6 information for your Internet service.

4.5 Firewall

The wireless router can serve as a hardware firewall for your network.

NOTE: The Firewall feature is enabled by default.

4.5.1 General

To set up basic Firewall settings:

1. From the navigation panel, go to **Advanced Settings > Firewall > General** tab.
2. On the **Enable Firewall** field, select **Yes**.
3. On the **Enable DoS** protection, select **Yes** to protect your network from DoS (Denial of Service) attacks though this may affect your router's performance.
4. You can also monitor packets exchanged between the LAN and WAN connection. On the Logged packets type, select **Dropped, Accepted, or Both**.
5. Click **Apply**.

4.5.2 URL Filter

You can specify keywords or web addresses to prevent access to specific URLs.

NOTE: The URL Filter is based on a DNS query. If a network client has already accessed a website such as <http://www.abcxxx.com>, then the website will not be blocked (a DNS cache in the system stores previously visited websites). To resolve this issue, clear the DNS cache before setting up the URL Filter.

To set up a URL filter:

1. From the navigation panel, go to **Advanced Settings > Firewall > URL Filter** tab.
2. On the Enable URL Filter field, select **Enabled**.
3. Enter a URL and click the  button.
4. Click **Apply**.

4.5.3 Keyword filter

Keyword filter blocks access to webpages containing specified keywords.

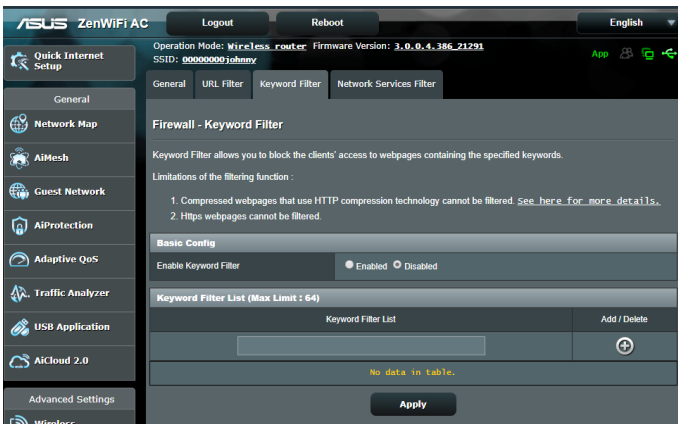

To set up a keyword filter:

1. From the navigation panel, go to **Advanced Settings > Firewall > Keyword Filter** tab.
2. On the Enable Keyword Filter field, select **Enabled**.

3. Enter a word or phrase and click the **Add** button.
4. Click **Apply**.

NOTES:

- The Keyword Filter is based on a DNS query. If a network client has already accessed a website such as `http://www.abcxxx.com`, then the website will not be blocked (a DNS cache in the system stores previously visited websites). To resolve this issue, clear the DNS cache before setting up the Keyword Filter.
- Web pages compressed using HTTP compression cannot be filtered. HTTPS pages also cannot be blocked using a keyword filter.

4.5.4 Network Services Filter

The Network Services Filter blocks LAN to WAN packet exchanges and restricts network clients from accessing specific web services such as Telnet or FTP.

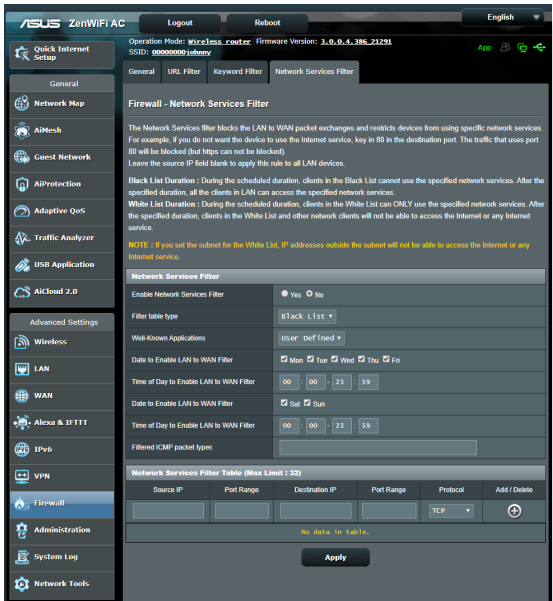

To set up a Network Service filter:

1. From the navigation panel, go to **Advanced Settings** > **Firewall** > **Network Service Filter** tab.
2. On the Enable Network Services Filter field, select **Yes**.
3. Select the Filter table type. **Black List** blocks the specified network services. **White List** limits access to only the specified network services.
4. Specify the day and time when the filters will be active.
5. To specify a Network Service to filter, enter the Source IP, Destination IP, Port Range, and Protocol. Click the  button.
6. Click **Apply**.

4.6 Administration

4.6.1 Operation Mode

The Operation Mode page allows you to select the appropriate mode for your network.



To set up the operating mode:

1. From the navigation panel, go to **Advanced Settings > Administration > Operation Mode** tab.
2. Select any of these operation modes:
 - **Wireless router mode (default):** In wireless router mode, the wireless router connects to the Internet and provides Internet access to available devices on its own local network.
 - **Repeater mode:** This mode turns the router into a wireless repeater to extend the range of your signal.
 - **Access Point mode:** In this mode, the router creates a new wireless network on an existing network.
3. Click **Save**.

NOTE: The router will reboot when you change the modes.

4.6.2 System

The **System** page allows you to configure your wireless router settings.

To set up the System settings:

1. From the navigation panel, go to **Advanced Settings > Administration > System** tab.
2. You can configure the following settings:
 - **Change router login password:** You can change the password and login name for the wireless router by entering a new name and password.
 - **USB setting:** You can Enable HDD Hibernation and change USB mode.
 - **WPS button behavior:** The physical WPS button on the wireless router can be used to activate WPS.
 - **Time Zone:** Select the time zone for your network.
 - **NTP Server:** The wireless router can access a NTP (Network time Protocol) server in order to synchronize the time.
 - **Network Monitoring:** You can enable DNS Query to check Resolve Hostname and Resolved IP Addresses, or enable Ping, then check your Ping Target.
 - **Auto Logout:** You can set the time of auto-logout.
 - **Enable WAN down browser redirect notice:** This feature allows the browser to display a warning page when the router is disconnected from Internet. When disabled, the warning page will not appear.
 - **Enable Telnet:** Click **Yes** to enable Telnet services on the network. Click **No** to disable Telnet.
 - **Authentication Method:** You can select HTTP, HTTPS, or both protocols to secure router access.
 - **Enable Reboot Scheduler:** When enabled, you can set the Date to Reboot and Time of Day to Reboot.
 - **Enable Web Access from WAN:** Select **Yes** to allow devices outside the network to access the wireless router GUI settings. Select **No** to prevent access.
 - **Enable Access Restrictions:** Click **Yes** if you want to specify

the IP addresses of devices that are allowed to access to the wireless router GUI settings from WAN/LAN.

- **Service:** This feature allows you to configure Enable Telnet/ Enable SSH/SSH Port/Allow Password Login/Authorized Keys/Idle Timeout.

3. Click **Apply**.

4.6.3 Firmware Upgrade

NOTE: Download the latest firmware from the ASUS website at <http://www.asus.com>.

To upgrade the firmware:

1. From the navigation panel, go to **Advanced Settings > Administration > Firmware Upgrade** tab.
 2. In the **New Firmware File** field, click **Browse** to locate the downloaded file.
 3. Click **Upload**.
-

NOTES:

- When the upgrade process is complete, wait for some time for the system to reboot.
 - If the upgrade process fails, the wireless router automatically enters rescue mode and the power LED indicator on the front panel starts flashing slowly. To recover or restore the system, refer to section **5.2 Firmware Restoration**.
-

4.6.4 Restore/Save/Upload Setting

To restore/save/upload wireless router settings:

1. From the navigation panel, go to **Advanced Settings > Administration > Restore/Save/Upload Setting** tab.
 2. Select the tasks that you want to do:
 - To restore to the default factory settings, click **Restore**, and click **OK** in the confirmation message.
 - To save the current system settings, click **Save**, navigate to the folder where you intend to save the file and click **Save**.
 - To restore from a saved system settings file, click **Browse** to locate your file, then click **Upload**.
-

If issues occur, upload the latest firmware version and configure new settings. Do not restore the router to its default settings.

4.7 System Log

System Log contains your recorded network activities.

NOTE: System log resets when the router is rebooted or powered off.

To view your system log:

1. From the navigation panel, go to **Advanced Settings > System Log**.
2. You can view your network activities in any of these tabs:
 - General Log
 - DHCP Leases
 - Wireless Log
 - Port Forwarding
 - Routing Table
 - IPv6
 - Connections

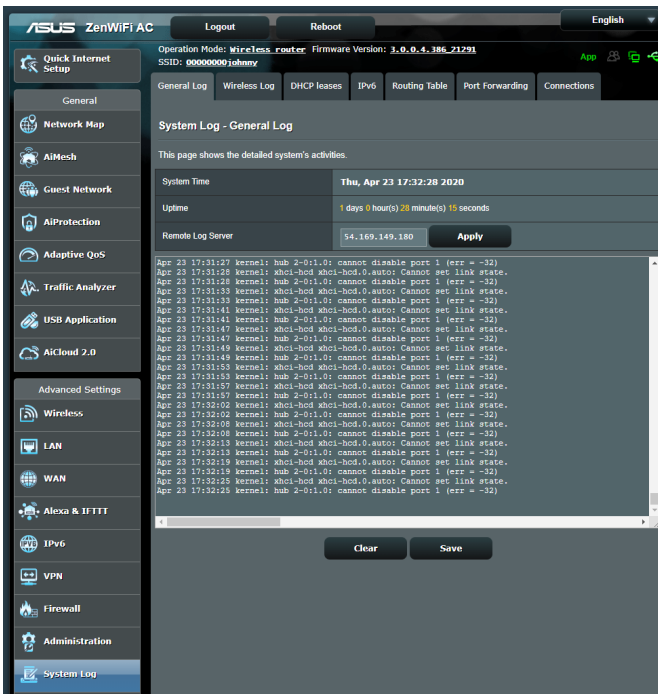

5 Utilities

NOTES:

- Download and install the wireless router's utilities from the ASUS website:
 - Device Discovery v1.4.7.1 at <http://dlcdnet.asus.com/pub/ASUS/LiveUpdate/Release/Wireless/Discovery.zip>
 - Firmware Restoration v1.9.0.4 at <http://dlcdnet.asus.com/pub/ASUS/LiveUpdate/Release/Wireless/Rescue.zip>
 - Windows Printer Utility v1.0.5.5 at <http://dlcdnet.asus.com/pub/ASUS/LiveUpdate/Release/Wireless/Printer.zip>
 - The utilities are not supported on MAC OS.
-

5.1 Device Discovery

Device Discovery is an ASUS WLAN utility that detects an ASUS wireless router device, and allows you to configure the wireless networking settings.

To launch the Device Discovery utility:

- From your computer's desktop, click **Start > All Programs > ASUS Utility > Wireless Router > Device Discovery**.

NOTE: When you set the router to Access Point mode, you need to use Device Discovery to get the router's IP address.

5.2 Firmware Restoration

Firmware Restoration is used on an ASUS Wireless Router that failed during its firmware upgrading process. It uploads the firmware that you specify. The process takes about three to four minutes.

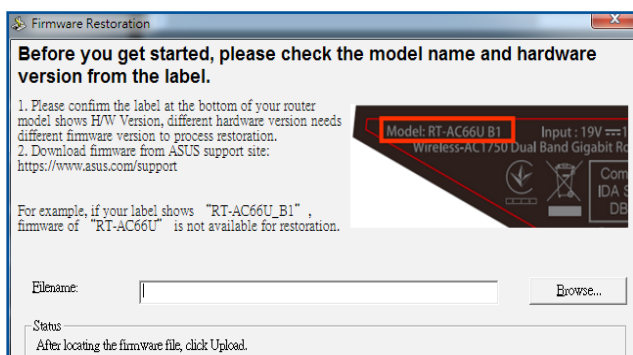

IMPORTANT: Launch the rescue mode on the router before using the Firmware Restoration utility.

NOTE: This feature is not supported on MAC OS.

To launch the rescue mode and use the Firmware Restoration utility:

1. Unplug the wireless router from the power source.
2. Hold the Reset button at the rear panel and simultaneously replug the wireless router into the power source. Release the Reset button when the Power LED at the front panel flashes slowly, which indicates that the wireless router is in the rescue mode.

3. Set a static IP on your computer and use the following to set up your TCP/IP settings:

IP address: 192.168.1.x

Subnet mask: 255.255.255.0

4. From your computer's desktop, click **Start > All Programs > ASUS Utility > Wireless Router > Firmware Restoration.**
5. Specify a firmware file, then click **Upload.**

NOTE: This is not a firmware upgrade utility and cannot be used on a working ASUS Wireless Router. Normal firmware upgrades must be done through the web interface. Refer to **Chapter 4: Configuring the Advanced Settings** for more details.

5.3 Setting up your printer server

5.3.1 ASUS EZ Printer Sharing

ASUS EZ Printing Sharing utility allows you to connect a USB printer to your wireless router's USB port and set up the print server. This allows your network clients to print and scan files wirelessly.

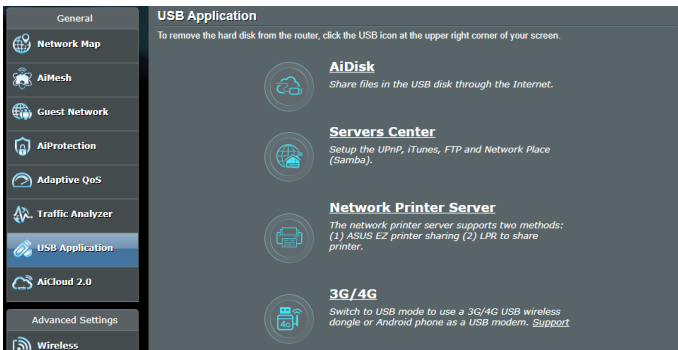

NOTE: The print server function is supported on Windows® 7, Windows® 8, Windows® 8.1, and Windows® 10.

To set up the EZ Printer sharing mode:

1. From the navigation panel, go to **General > USB Application > Network Printer Server**.
2. Click **Download Now!** to download the network printer utility.

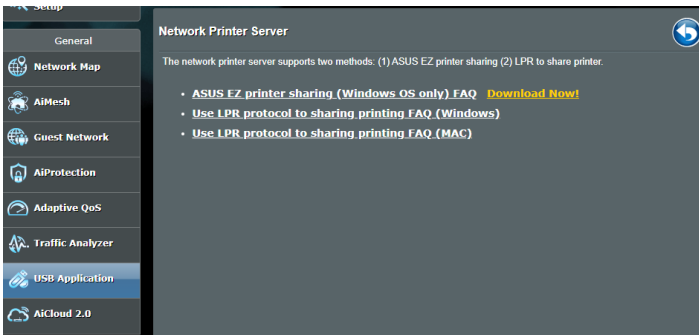

NOTE: Network printer utility is supported on Windows® 7, Windows® 8, Windows® 8.1, and Windows® 10 only. To install the utility on Mac OS, select **Use LPR protocol for sharing printer**.

3. Unzip the downloaded file and click the Printer icon to run the network printer setup program.

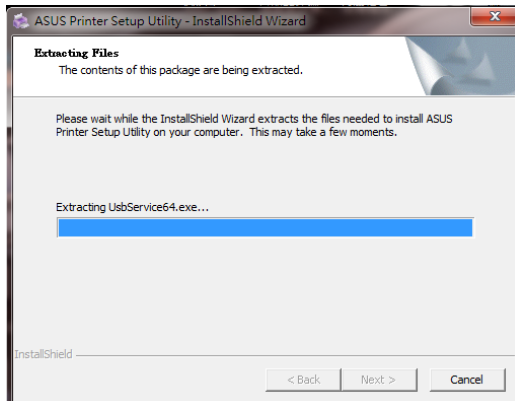
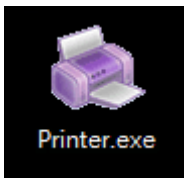

4. Follow the onscreen instructions to set up your hardware, then click **Next**.

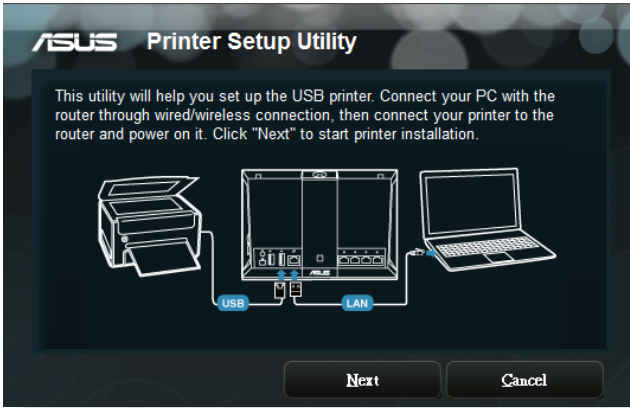

5. Wait a few minutes for the initial setup to finish. Click **Next**.
6. Click **Finish** to complete the installation.
7. Follow the Windows® OS instructions to install the printer driver.



8. After the printer's driver installation is complete, network clients can now use the printer.

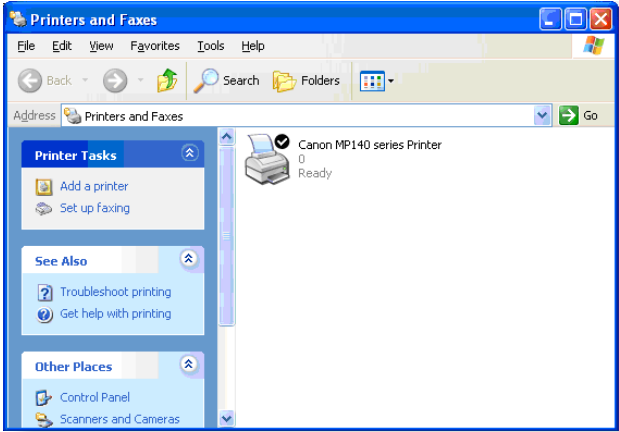

5.3.2 Using LPR to Share Printer

You can share your printer with computers running on Windows® and MAC operating system using LPR/LPD (Line Printer Remote/ Line Printer Daemon).

Sharing your LPR printer

To share your LPR printer:

1. From the Windows® desktop, click **Start > Devices and Printers > Add a printer** to run the **Add Printer Wizard**.

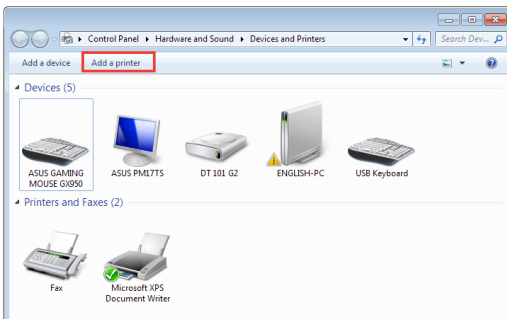

2. Select **Add a local printer** and then click **Next**.

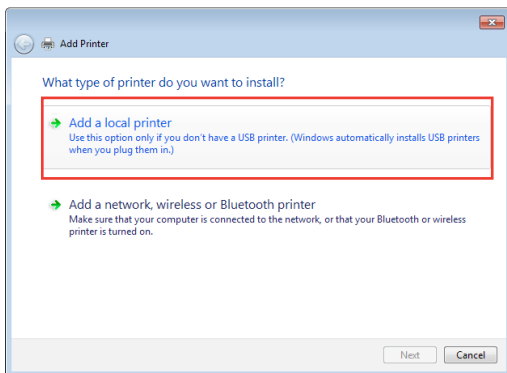

3. Select **Create a new port** then set **Type of Port** to **Standard TCP/IP Port**. Click **New Port**.

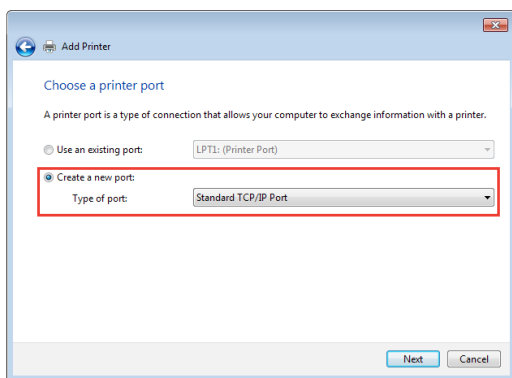

4. In the **Hostname or IP address** field, key in the IP address of the wireless router then click **Next**.

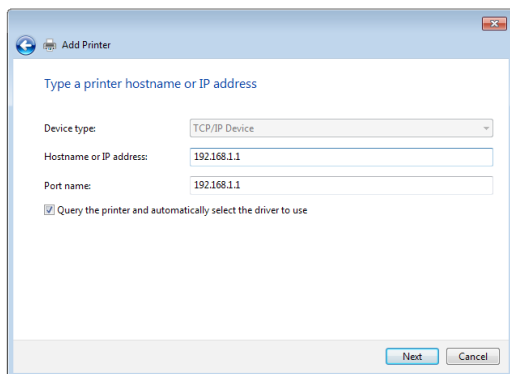

5. Select **Custom** then click **Settings**.

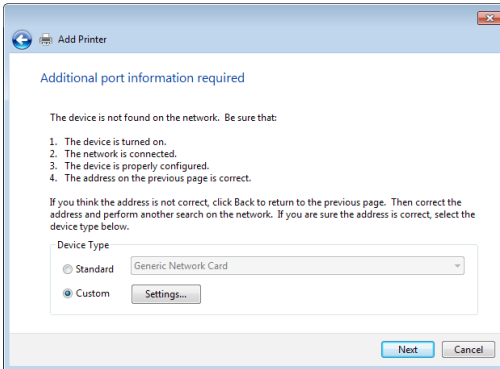

6. Set **Protocol** to **LPR**. In the **Queue Name** field, key in **LPRServer** then click **OK** to continue.

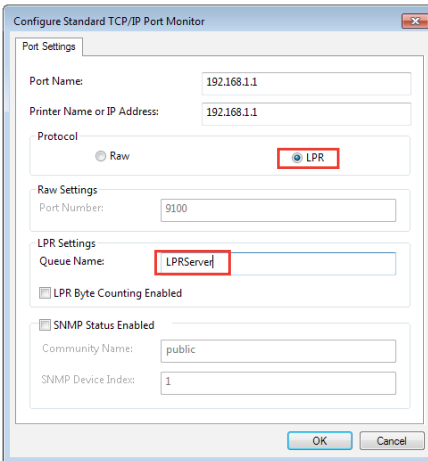

7. Click **Next** to finish setting up the standard TCP/IP port.

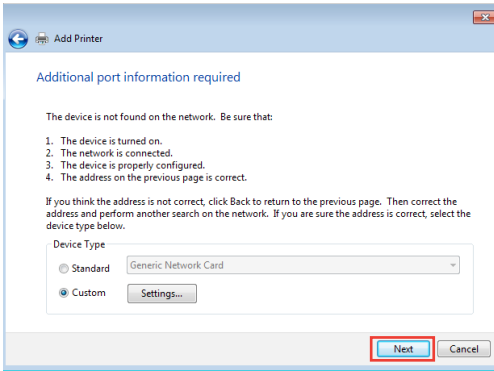

8. Install the printer driver from the vendor-model list. If your printer is not in the list, click **Have Disk** to manually install the printer drivers from a CD-ROM or file.

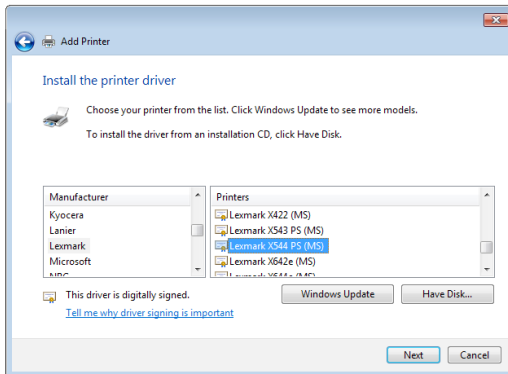

9. Click **Next** to accept the default name for the printer.

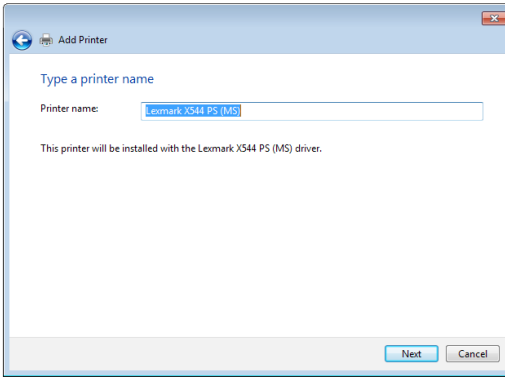

10. Click **Finish** to complete the installation.

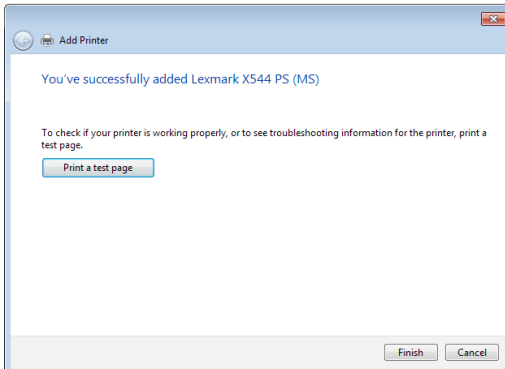

5.4 Download Master

Download Master is a utility that helps you download files even while your laptops or other devices are switched off.

NOTE: You need a USB device connected to the wireless router to use Download Master.

To use Download Master:

1. Click **General > USB application > Download Master** to download and install the utility automatically.

NOTE: If you have more than one USB drive, select the USB device you want to download the files to.

2. After the download process is finished, click the Download Master icon to start using the utility.
3. Click **Add** to add a download task.

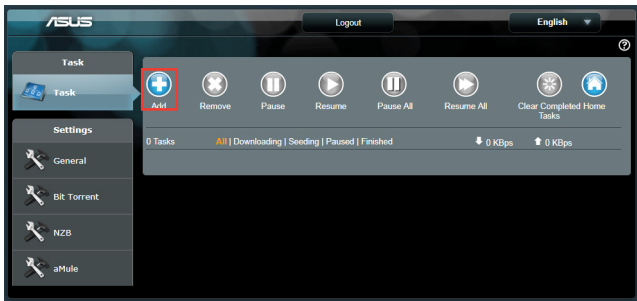

4. Select a download type such as BitTorrent, HTTP, or FTP. Provide a torrent file or a URL to begin downloading.

NOTE: For details on Bit Torrent, refer to section **5.4.1 Configuring the Bit Torrent download settings**.

5. Use the navigation panel to configure the advanced settings.

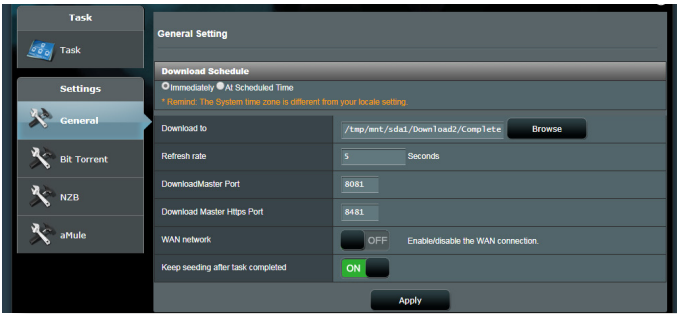

5.4.1 Configuring Bit Torrent download settings

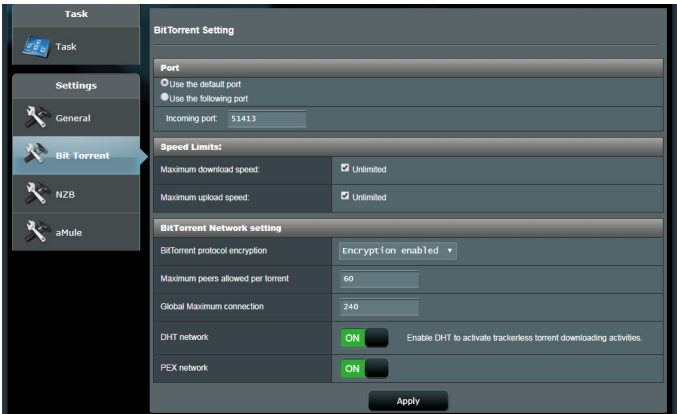

To configure BitTorrent download settings:

1. From Download Master's navigation panel, click **Bit Torrent** to launch the **Bit Torrent Setting** page.
2. Select a specific port for your download task.
3. To prevent network congestion, you can limit the maximum upload and download speeds under **Speed Limits**.
4. You can limit the maximum number of allowed peers and enable or disable file encryption during downloads.

5.4.2 NZB settings

You can set up a USENET server to download NZB files. After entering USENET settings, **Apply**.

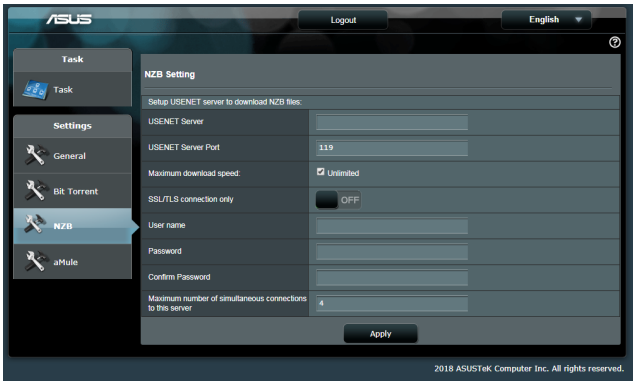

6 Troubleshooting

This chapter provides solutions for issues you may encounter with your router. If you encounter problems that are not mentioned in this chapter, visit the ASUS support site at:

<https://www.asus.com/support/> for more product information and contact details of ASUS Technical Support.

6.1 Basic Troubleshooting

If you are having problems with your router, try these basic steps in this section before looking for further solutions.

Upgrade Firmware to the latest version.

1. Launch the Web GUI. Go to **Advanced Settings** > **Administration** > **Firmware Upgrade** tab. Click **Check** to verify if the latest firmware is available.

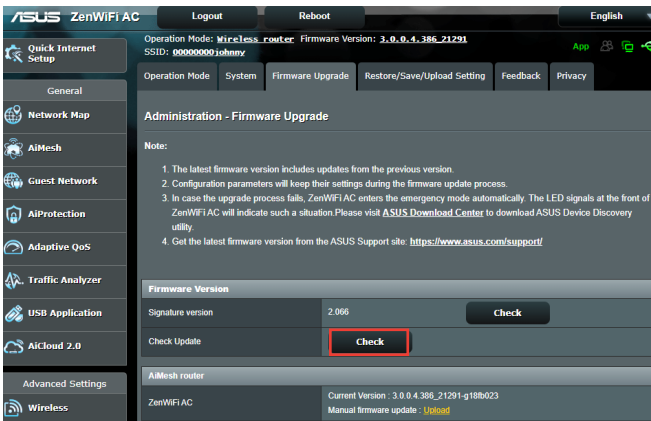

2. If the latest firmware is available, visit the ASUS global website at <https://www.asus.com/Mesh-WiFi-System/ZenWiFi-AC-CT8/HelpDesk/> to download the latest firmware.
3. From the **Firmware Upgrade** page, click **Browse** to upload the firmware file.
4. Click **Upload** to upgrade the firmware.

Restart your network in the following sequence:

1. Turn off the modem.
2. Unplug the modem.
3. Turn off the router and computers.
4. Plug in the modem.
5. Turn on the modem and then wait for 2 minutes.
6. Turn on the router and then wait for 2 minutes.
7. Turn on computers.

Check if your Ethernet cables are plugged properly.

- When the Ethernet cable connecting the router with the modem is plugged in properly, the WAN LED will be on.
- When the Ethernet cable connecting your powered-on computer with the router is plugged in properly, the corresponding LAN LED will be on.

Check if the wireless setting on your computer matches that of your computer.

- When you connect your computer to the router wirelessly, ensure that the SSID (wireless network name), encryption method, and password are correct.

Check if your network settings are correct.

- Each client on the network should have a valid IP address. ASUS recommends that you use the wireless router's DHCP server to assign IP addresses to computers on your network.

- Some cable modem service providers require you to use the MAC address of the computer initially registered on the account. You can view the MAC address in the web GUI, **Network Map > Clients** page, and hover the mouse pointer over your device in **Client Status**.



6.2 Frequently Asked Questions (FAQs)

I cannot access the router GUI using a web browser

- If your computer is wired, check the Ethernet cable connection and LED status as described in the previous section.
- Ensure that you are using the correct login information. The default factory login name and password is “admin/admin”. Ensure that the Caps Lock key is disabled when you enter the login information.
- Delete the cookies and files in your web browser. For Internet Explorer, follow these steps:
 1. Launch Internet Explorer, then click **Tools > Internet Options**.
 2. In the **General** tab, under **Browsing history**, click **Delete...**, select **Temporary Internet files and website files** and **Cookies and website data** then click **Delete**.

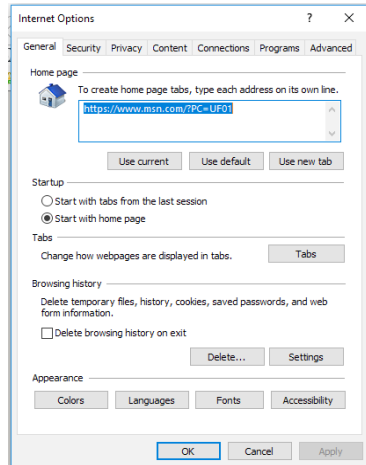

NOTES:

- The commands for deleting cookies and files vary with web browsers.
- Disable proxy server settings, cancel the dial-up connection, and set the TCP/IP settings to obtain IP addresses automatically. For more details, refer to Chapter 1 of this user manual.
- Ensure that you use CAT5e or CAT6 ethernet cables.

The client cannot establish a wireless connection with the router.

NOTE: If you are having issues connecting to 5GHz network, make sure that your wireless device supports 5GHz or features dual band capabilities.

- **Out of Range:**
 - Move the router closer to the wireless client.
 - Try to adjust antennas of the router to the best direction as described in section **1.4 Positioning your router.**
- **DHCP server has been disabled:**
 1. Launch the web GUI. Go to **General > Network Map > Clients** and search for the device that you want to connect to the router.
 2. If you cannot find the device in the **Network Map**, go to **Advanced Settings > LAN > DHCP Server, Basic Config** list, select **Yes** on the **Enable the DHCP Server.**

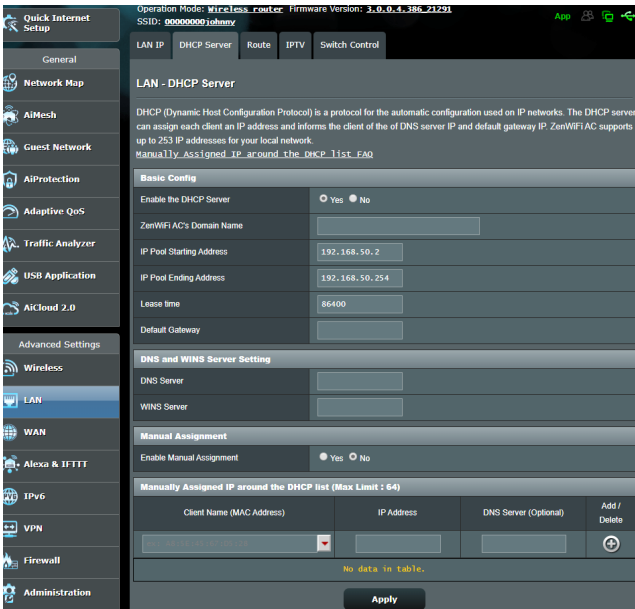

- SSID has been hidden. If your device can find SSIDs from other routers but cannot find your router's SSID, go to **Advanced Settings > Wireless > General**, select **No** on **Hide SSID**, and select **Auto** on **Control Channel**.

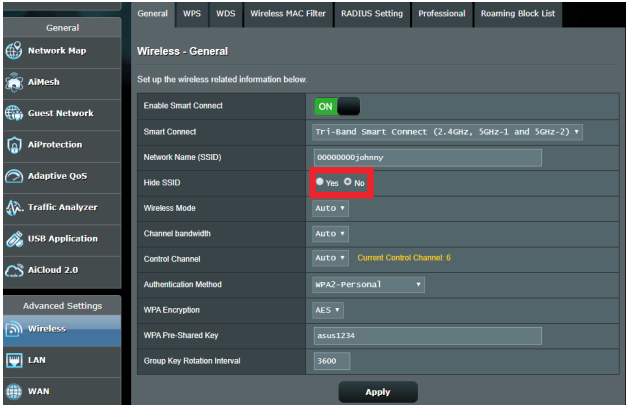

- If you are using a wireless LAN adapter, check if the wireless channel in use conforms to the channels available in your country/area. If not, adjust the channel, channel bandwidth, and wireless mode.
- If you still cannot connect to the router wirelessly, you can reset your router to factory default settings. In the router GUI, click **Administration > Restore/Save/Upload Setting** and click **Restore**.

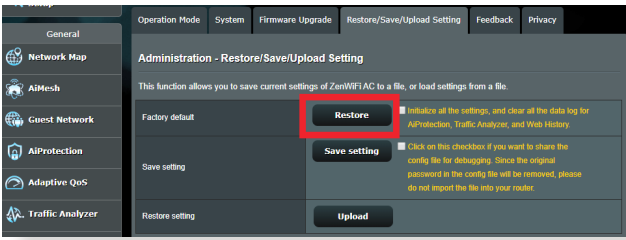

Internet is not accessible.

- Check if your router can connect to your ISP's WAN IP address. To do this, launch the web GUI and go to **General > Network Map**, and check the **Internet Status**.
- If your router cannot connect to your ISP's WAN IP address, try restarting your network as described in the section **Restart your network in following sequence** under **Basic Troubleshooting**.



- The device has been blocked via the Parental Control function. Go to **General > AiProtection > Parental Control** and see if the device is in the list. If the device is listed under **Client Name**, remove the device using the **Delete** button or adjust the Time Management Settings.



- If there is still no Internet access, try to reboot your computer and verify the network's IP address and gateway address.
- Check the status indicators on the ADSL modem and the wireless router. If the WAN LED on the wireless router is not ON, check if all cables are plugged properly.

You forgot the SSID (network name) or network password

- Setup a new SSID and encryption key via a wired connection (Ethernet cable). Launch the web GUI, go to **Network Map**, click the router icon, enter a new SSID and encryption key, and then click **Apply**.
- Reset your router to the default settings. Launch the web GUI, go to **Administration > Restore/Save/Upload Setting**, and click **Restore**. The default login account and password are both "admin".

How to restore the system to its default settings?

- Go to **Administration > Restore/Save/Upload Setting**, and click **Restore**.

The following are the factory default settings:

Enable DHCP:	Yes (if WAN cable is plugged in)
IP address:	192.168.50.1
Domain Name:	(Blank)
Subnet Mask:	255.255.255.0
DNS Server 1:	router.asus.com
DNS Server 2:	(Blank)
SSID:	ASUS_XX

Firmware upgrade failed.

Launch the rescue mode and run the Firmware Restoration utility. Refer to section **5.2 Firmware Restoration** on how to use the Firmware Restoration utility.

Cannot access Web GUI

Before configuring your wireless router, do the steps described in this section for your host computer and network clients.

A. Disable the proxy server, if enabled.

Windows®

1. Click **Start > Internet Explorer** to launch the browser.
2. Click **Tools > Internet options > Connections tab > LAN settings.**
3. From the Local Area Network (LAN) Settings screen, untick **Use a proxy server for your LAN.**
4. Click **OK** when done.

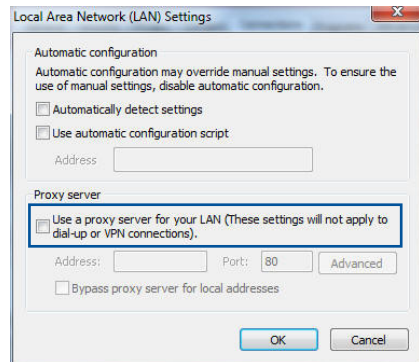
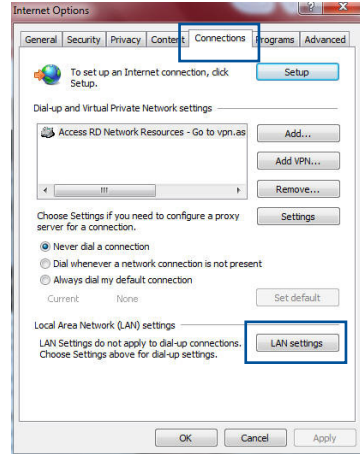

MAC OS

1. From your Safari browser, click **Safari > Preferences > Advanced > Change Settings...**
2. From the Network screen, deselect **FTP Proxy** and **Web Proxy (HTTP)**.
3. Click **Apply Now** when done.

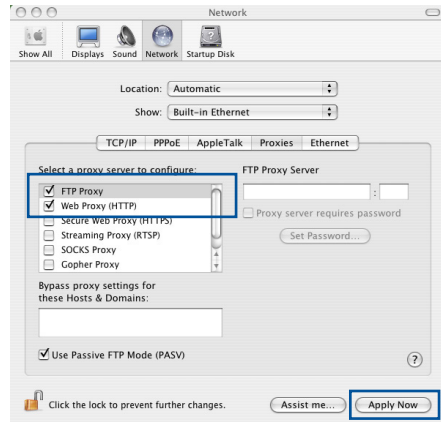

NOTE: Refer to your browser's help feature for details on disabling the proxy server.

B. Set the TCP/IP settings to automatically obtain an IP address.

Windows®

1. Click **Start > Control Panel > Network and Sharing Center**, then click the network connection to display its status window.

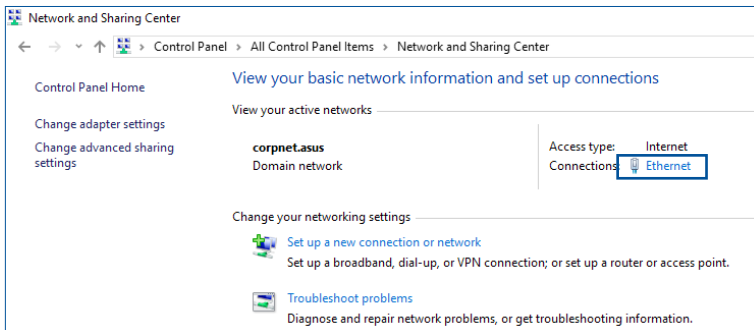

2. Click **Properties** to display the Ethernet Properties window.

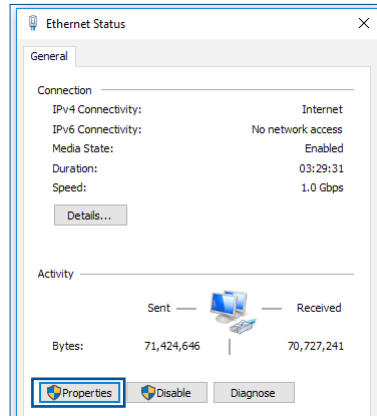

3. Select **Internet Protocol Version 4 (TCP/IPv4)** or **Internet Protocol Version 6 (TCP/IPv6)**, then click **Properties**.

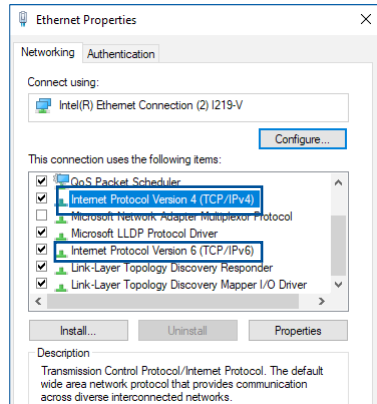

4. To obtain the IPv4 IP settings automatically, tick **Obtain an IP address automatically**.

To obtain the IPv6 IP settings automatically, tick **Obtain an IPv6 address automatically**.

5. Click **OK** when done.

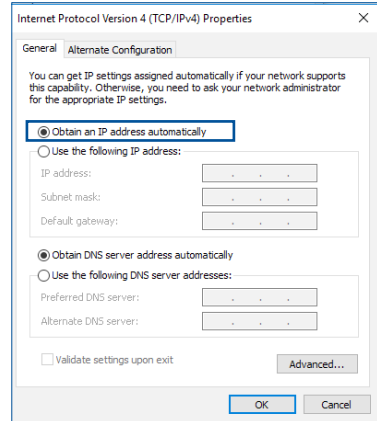

MAC OS

1. Click the Apple icon  located on the top left of your screen.
2. Click **System Preferences > Network > Configure...**
3. From the **TCP/IP** tab, select **Using DHCP** in the **Configure IPv4** dropdown list.
4. Click **Apply Now** when done.

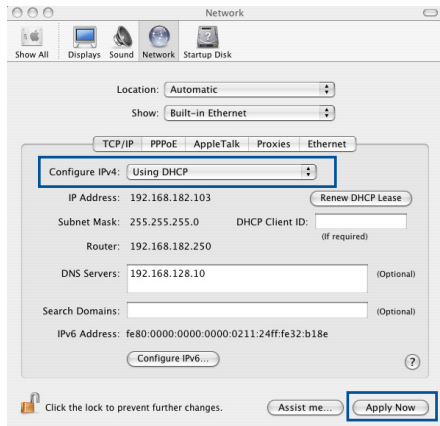

NOTE: Refer to your operating system's help and support feature for details on configuring your computer's TCP/IP settings.

C. Disable the dial-up connection, if enabled.

Windows®

1. Click **Start > Internet Explorer** to launch the browser.
2. Click **Tools > Internet options > Connections** tab.
3. Tick **Never dial a connection**.
4. Click **OK** when done.

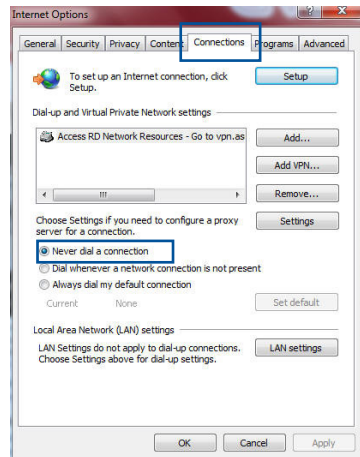

NOTE: Refer to your browser's help feature for details on disabling the dial-up connection.

Appendices

Notices

This device is an Energy Related Product (ErP) with High Network Availability (HiNA), the power consumption will be less than 12 watts when the system is in network standby mode (idle mode).

ASUS Recycling/Takeback Services

ASUS recycling and takeback programs come from our commitment to the highest standards for protecting our environment. We believe in providing solutions for you to be able to responsibly recycle our products, batteries, other components, as well as the packaging materials. Please go to <http://csr.asus.com/english/Takeback.htm> for the detailed recycling information in different regions.

REACH

Complying with the REACH (Registration, Evaluation, Authorisation, and Restriction of Chemicals) regulatory framework, we published the chemical substances in our products at ASUS REACH website at <http://csr.asus.com/english/index.aspx>

Federal Communications Commission Statement

This device complies with Part 15 of the FCC Rules. Operation is subject to the following two conditions:

- This device may not cause harmful interference.
- This device must accept any interference received, including interference that may cause undesired operation.

This equipment has been tested and found to comply with the limits for a class B digital device, pursuant to part 15 of the FCC

Rules. These limits are designed to provide reasonable protection against harmful interference in a residential installation.

This equipment generates, uses and can radiate radio frequency energy and, if not installed and used in accordance with the instructions, may cause harmful interference to radio communications. However, there is no guarantee that interference will not occur in a particular installation. If this equipment does cause harmful interference to radio or television reception, which can be determined by turning the equipment off and on, the user is encouraged to try to correct the interference by one or more of the following measures:

- Reorient or relocate the receiving antenna.
- Increase the separation between the equipment and receiver.
- Connect the equipment into an outlet on a circuit different from that to which the receiver is connected.
- Consult the dealer or an experienced radio/TV technician for help.

IMPORTANT! This device within the 5.15 ~ 5.25 GHz is restricted to indoor operations to reduce any potential for harmful interference to co-channel MSS operations.

CAUTION: Any changes or modifications not expressly approved by the party responsible for compliance could void the user's authority to operate the equipment.

Prohibition of Co-location

This device and its antenna(s) must not be co-located or operating in conjunction with any other antenna or transmitter.

IMPORTANT NOTE:

Radiation Exposure Statement: This equipment complies with FCC radiation exposure limits set forth for an uncontrolled environment. End users must follow the specific operating

instructions for satisfying RF exposure compliance. To maintain compliance with FCC exposure compliance requirement, please follow operation instruction as documented in this manual. This equipment should be installed and operated with a minimum distance of 15 cm between the radiator and any part of your body.

NCC 警語

經型式認證合格之低功率射頻電機，非經許可，公司、商號或使用者均不得擅自變更頻率、加大功率或變更原設計之特性及功能。

低功率射頻電機之使用不得影響飛航安全及干擾合法通信；經發現有干擾現象時，應立即停用，並改善至無干擾時方得繼續使用。

前項合法通信，指依電信法規定作業之無線電通信。

低功率射頻電機須忍受合法通信或工業、科學及醫療用電波輻射性電機設備之干擾。

「產品之限用物質含有情況」之相關資訊，請參考下表：

單元	限用物質及其化學符號					
	鉛 (Pb)	汞 (Hg)	鎘 (Cd)	六價鉻 (Cr ⁺⁶)	多溴聯苯 (PBB)	多溴二苯醚 (PBDE)
印刷電路板及電子組件	-	○	○	○	○	○
結構組件（金屬 / 塑膠）	○	○	○	○	○	○
其他組件（如天線/ 指示燈/連接線）	○	○	○	○	○	○
其他及其配件（如電源供應器）	-	○	○	○	○	○

備考1. “○” 係指該項限用物質之百分比含量未超出百分比含量基準值。
備考2. “-” 係指該項限用物質為排除項目。

安全說明：

- 請在溫度為 0° C (32° F) 至 40° C (104° F) 之間的環境中使用本產品。
- 請依照產品上的電源功率貼紙說明使用正確的電源適配器，如果使用錯誤規格的電源適配器可能會造成內部零件的損壞。
- 請勿將產品放置於不平坦或不穩定的表面，若產品的外殼損壞，請聯繫維修服務人員。
- 請勿在產品上放置其他物品，請勿將任何物品塞入產品內，以

避免引起組件短路或電路損壞。

- 請保持機器在干燥的環境下使用，雨水、濕氣、液體等含有礦物質會腐蝕電子線路，請勿在雷電天气下使用調製解調器。
- 請勿堵塞產品的通風孔，以避免因散熱不良而導致系統過熱。
- 請勿使用破損的電源線、附件或其他周邊產品。
- 如果電源已損壞，請不要嘗試自行修復，請將其交給專業技術服務人員或經銷商來處理。
- 為了防止電擊風險，在搬動主機前，請先將電源線插頭暫時從電源插座上拔除。

使用警語：

- 推薦您在環境溫度為 0° C (32° F) ~ 40° C (104° F) 的情況下使用本產品。
- 請依照產品底部的電源功率貼紙說明使用符合此功率的電源變壓器。
- 請勿將產品放置在不平坦或不穩定的物體表面。若產品外殼有所損毀，請將產品送修。
- 請勿將任何物體放置在產品上方，並不要將任何外物插入產品。
- 請勿將產品置於或在液體、雨天或潮濕的環境中使用。雷暴天氣請不要使用數據機。
- 請勿擋住產品的散熱孔，以防止系統過熱。
- 請勿使用損毀的電源線、配件或其他周邊裝置。
- 若電源變壓器已損毀，請不要嘗試自行修復，請聯絡專業的服務技術人員或您的零售商。
- 為防止觸電，在重新放置產品前，請從電源插座上拔下電源線。
- 無線資訊傳輸設備避免影響附近雷達系統之操作。

華碩聯絡資訊

華碩電腦公司 ASUSteK COMPUTER INC. (台灣)

市場訊息

地址：台灣臺北市北投區立德路 15 號 1 樓

電話：+886-2-2894-3447

傳真：+886-2-2890-7698

電子郵件：info@asus.com.tw

全球資訊網：<https://www.asus.com/tw>

技術支援

電話：+886-2-2894-3447 (0800-093-456)

線上支援：<https://www.asus.com/tw/support/>

Precautions for the use of the device

- a. Pay particular attention to the personal safety when use this device in airports, hospitals, gas stations and professional garages.
- b. Medical device interference: Maintain a minimum distance of at least 15 cm (6 inches) between implanted medical devices and ASUS products in order to reduce the risk of interference.
- c. Kindly use ASUS products in good reception conditions in order to minimize the radiation's level.
- d. Keep the device away from pregnant women and the lower abdomen of the teenager.

Précautions d'emploi de l'appareil

- a. Soyez particulièrement vigilant quant à votre sécurité lors de l'utilisation de cet appareil dans certains lieux (les avions, les aéroports, les hôpitaux, les stations-service et les garages professionnels).
- b. Évitez d'utiliser cet appareil à proximité de dispositifs médicaux implantés. Si vous portez un implant électronique (stimulateurs cardiaques, pompes à insuline, neurostimulateurs...), veuillez impérativement respecter une distance minimale de 15 centimètres entre cet appareil et votre corps pour réduire les risques d'interférence.
- c. Utilisez cet appareil dans de bonnes conditions de réception pour minimiser le niveau de rayonnement. Ce n'est pas toujours le cas dans certaines zones ou situations, notamment dans les parkings souterrains, dans les ascenseurs, en train ou en voiture ou tout simplement dans un secteur mal couvert par le réseau.
- d. Tenez cet appareil à distance des femmes enceintes et du bas-ventre des adolescents.

Условия эксплуатации:

- Температура эксплуатации устройства: 0-40 °С. Не используйте устройство в условиях экстремально высоких или низких температур.
- Не размещайте устройство вблизи источников тепла, например, рядом с микроволновой печью, духовым шкафом или радиатором.
- Использование несовместимого или несертифицированного адаптера питания может привести к возгоранию, взрыву и прочим опасным последствиям.
- При подключении к сети электропитания устройство следует располагать близко к розетке, к ней должен осуществляться беспрепятственный доступ.
- Утилизация устройства осуществляется в соответствии с местными законами и положениями. Устройство по окончании срока службы должны быть переданы в сертифицированный пункт сбора для вторичной переработки или правильной утилизации.
- Данное устройство не предназначено для детей. Дети могут пользоваться устройством только в присутствии взрослых.
- Не выбрасывайте устройство и его комплектующие вместе с обычными бытовыми отходами.



UA.TR.028

AEEE Yönetmeliğine Uygundur. IEEE Yönetmeliğine Uygundur.

- Bu Cihaz Türkiye analog şebekelerde çalışabilecek şekilde tasarlanmıştır.
- Cihazın ayrıntılı kurulum rehberi kutu içeriğinden çıkan CD içerisinde. Cihazın kullanıcı arayüzü Türkçe'dir.
- Cihazın kullanılması planlanan ülkelerde herhangi bir kısıtlaması yoktur. Ülkeler simgeler halinde kutu üzerinde belirtilmiştir.

Manufacturer	ASUSTeK Computer Inc. Tel: +886-2-2894-3447 Address: 4F, No. 150, LI-TE Rd, PEITOU, TAIPEI 112, TAIWAN
Authorised representative in Europe	ASUS Computer GmbH Address: HARKORT STR. 21-23, 40880 RATINGEN, GERMANY
Authorised distributors in Turkey	BOGAZICI BILGISAYAR TICARET VE SANAYI A.S. Tel./FAX No.: +90 212 331 10 00 / +90 212 332 28 90 Address: ESENTEPE MAH. BUYUKDERE CAD. ERCAN HAN B BLOK NO.121 SISLI, ISTANBUL 34394
	CIZGI Elektronik San. Tic. Ltd. Sti. Tel./FAX No.: +90 212 356 70 70 / +90 212 356 70 69 Address: GURSEL MAH. AKMAN SK.47B 1 KAGITHANE/ ISTANBUL
	KOYUNCU ELEKTRONİK BİLGİ İŞLEM SİST. SAN. VE DİŞ TIC. A.S. Tel. No.: +90 216 5288888 Address: EMEK MAH.ORDU CAD. NO:18, SARIGAZI, SANCAKTEPE ISTANBUL
	ENDEKS BİLİŞİM SAN VE DİŞ TIC LTD ŞTİ Tel./FAX No.: +90 216 523 35 70 / +90 216 523 35 71 Address: NECİP FAZİL BULVARI, KEYAP CARSI SITESİ, G1 BLOK, NO:115 Y.DUDULLU, UMRANIYE, ISTANBUL
	PENTA TEKNOLOJİ URUNLERİ DAGITIM TICARET A.S Tel./FAX No.: +90 216 528 0000 Address: ORGANİZE SANAYİ BOLGESİ NATO YOLU 4.CADDE NO:1 UMRANIYE, ISTANBUL 34775

GNU General Public License

Licensing information

This product includes copyrighted third-party software licensed under the terms of the GNU General Public License. Please see The GNU General Public License for the exact terms and conditions of this license. All future firmware updates will also be accompanied with their respective source code. Please visit our web site for updated information. Note that we do not offer direct support for the distribution.

GNU GENERAL PUBLIC LICENSE

Version 2, June 1991

Copyright (C) 1989, 1991 Free Software Foundation, Inc.

59 Temple Place, Suite 330, Boston, MA 02111-1307 USA

Everyone is permitted to copy and distribute verbatim copies of this license document, but changing it is not allowed.

Preamble

The licenses for most software are designed to take away your freedom to share and change it. By contrast, the GNU General Public License is intended to guarantee your freedom to share and change free software--to make sure the software is free for all its users. This General Public License applies to most of the Free Software Foundation's software and to any other program whose authors commit to using it. (Some other Free Software Foundation software is covered by the GNU Library General Public License instead.) You can apply it to your programs, too.

When we speak of free software, we are referring to freedom, not price. Our General Public Licenses are designed to make sure that you have the freedom to distribute copies of free software (and charge for this service if you wish), that you receive source code or

can get it if you want it, that you can change the software or use pieces of it in new free programs; and that you know you can do these things.

To protect your rights, we need to make restrictions that forbid anyone to deny you these rights or to ask you to surrender the rights. These restrictions translate to certain responsibilities for you if you distribute copies of the software, or if you modify it.

For example, if you distribute copies of such a program, whether gratis or for a fee, you must give the recipients all the rights that you have. You must make sure that they, too, receive or can get the source code. And you must show them these terms so they know their rights.

We protect your rights with two steps: (1) copyright the software, and (2) offer you this license which gives you legal permission to copy, distribute and/or modify the software.

Also, for each author's protection and ours, we want to make certain that everyone understands that there is no warranty for this free software. If the software is modified by someone else and passed on, we want its recipients to know that what they have is not the original, so that any problems introduced by others will not reflect on the original authors' reputations.

Finally, any free program is threatened constantly by software patents. We wish to avoid the danger that redistributors of a free program will individually obtain patent licenses, in effect making the program proprietary. To prevent this, we have made it clear that any patent must be licensed for everyone's free use or not licensed at all.

The precise terms and conditions for copying, distribution and modification follow.

Terms & conditions for copying, distribution, & modification

0. This License applies to any program or other work which contains a notice placed by the copyright holder saying it may be distributed under the terms of this General Public License.

The “Program”, below, refers to any such program or work, and a “work based on the Program” means either the Program or any derivative work under copyright law: that is to say, a work containing the Program or a portion of it, either verbatim or with modifications and/or translated into another language. (Hereinafter, translation is included without limitation in the term “modification”.) Each licensee is addressed as “you”.

Activities other than copying, distribution and modification are not covered by this License; they are outside its scope. The act of running the Program is not restricted, and the output from the Program is covered only if its contents constitute a work based on the Program (independent of having been made by running the Program). Whether that is true depends on what the Program does.

1. You may copy and distribute verbatim copies of the Program’s source code as you receive it, in any medium, provided that you conspicuously and appropriately publish on each copy an appropriate copyright notice and disclaimer of warranty; keep intact all the notices that refer to this License and to the absence of any warranty; and give any other recipients of the Program a copy of this License along with the Program.

You may charge a fee for the physical act of transferring a copy, and you may at your option offer warranty protection in exchange for a fee.

2. You may modify your copy or copies of the Program or any portion of it, thus forming a work based on the Program, and copy and distribute such modifications or work under the terms of Section 1 above, provided that you also meet all of these conditions:
 - a) You must cause the modified files to carry prominent notices stating that you changed the files and the date of any change.
 - b) You must cause any work that you distribute or publish, that in whole or in part contains or is derived from the Program or any part thereof, to be licensed as a whole at no charge to all third parties under the terms of this License.
 - c) If the modified program normally reads commands interactively when run, you must cause it, when started

running for such interactive use in the most ordinary way, to print or display an announcement including an appropriate copyright notice and a notice that there is no warranty (or else, saying that you provide a warranty) and that users may redistribute

the program under these conditions, and telling the user how to view a copy of this License. (Exception: if the Program itself is interactive but does not normally print such an announcement, your work based on the Program is not required to print an announcement.)

These requirements apply to the modified work as a whole. If identifiable sections of that work are not derived from the Program, and can be reasonably considered independent and separate works in themselves, then this License, and its terms, do not apply to those sections when you distribute them as separate works. But when you distribute the same sections as part of a whole which is a work based on the Program, the distribution of the whole must be on the terms of this License, whose permissions for other licensees extend to the entire whole, and thus to each and every part regardless of who wrote it.

Thus, it is not the intent of this section to claim rights or contest your rights to work written entirely by you; rather, the intent is to exercise the right to control the distribution of derivative or collective works based on the Program.

In addition, mere aggregation of another work not based on the Program with the Program (or with a work based on the Program) on a volume of a storage or distribution medium does not bring the other work under the scope of this License.

3. You may copy and distribute the Program (or a work based on it, under Section 2) in object code or executable form under the terms of Sections 1 and 2 above provided that you also do one of the following:
 - a) Accompany it with the complete corresponding machine-readable source code, which must be distributed under the terms of Sections 1 and 2 above on a medium customarily used for software interchange; or,

- b) Accompany it with a written offer, valid for at least three years, to give any third party, for a charge no more than your cost of physically performing source distribution, a complete machine-readable copy of the corresponding source code, to be distributed under the terms of Sections 1 and 2 above on a medium customarily used for software interchange; or,
- c) Accompany it with the information you received as to the offer to distribute corresponding source code. (This alternative is allowed only for noncommercial distribution and only if you received the program in object code or executable form with such an offer, in accord with Subsection b above.)

The source code for a work means the preferred form of the work for making modifications to it. For an executable work, complete source code means all the source code for all modules it contains, plus any associated interface definition files, plus the scripts used to control compilation and installation of the executable. However, as a special exception, the source code distributed need not include anything that is normally distributed (in either source or binary form) with the major components (compiler, kernel, and so on) of the operating system on which the executable runs, unless that component itself accompanies the executable.

If distribution of executable or object code is made by offering access to copy from a designated place, then offering equivalent access to copy the source code from the same place counts as distribution of the source code, even though third parties are not compelled to copy the source along with the object code.

- 4. You may not copy, modify, sublicense, or distribute the Program except as expressly provided under this License. Any attempt otherwise to copy, modify, sublicense or distribute the Program is void, and will automatically terminate your rights under this License. However, parties who have received copies, or rights, from you under this License will not have their licenses terminated so long as such parties remain in full compliance.
- 5. You are not required to accept this License, since you have

not signed it. However, nothing else grants you permission to modify or distribute the Program or its derivative works. These actions are prohibited by law if you do not accept this License.

Therefore, by modifying or distributing the Program (or any work based on the Program), you indicate your acceptance of this License to do so, and all its terms and conditions for copying, distributing or modifying the Program or works based on it.

6. Each time you redistribute the Program (or any work based on the Program), the recipient automatically receives a license from the original licensor to copy, distribute or modify the Program subject to these terms and conditions. You may not impose any further restrictions on the recipients' exercise of the rights granted herein. You are not responsible for enforcing compliance by third parties to this License.
7. If, as a consequence of a court judgment or allegation of patent infringement or for any other reason (not limited to patent issues), conditions are imposed on you (whether by court order, agreement or otherwise) that contradict the conditions of this License, they do not excuse you from the conditions of this License. If you cannot distribute so as to satisfy simultaneously your obligations under this License and any other pertinent obligations, then as a consequence you may not distribute the Program at all. For example, if a patent license would not permit royalty-free redistribution of the Program by all those who receive copies directly or indirectly through you, then the only way you could satisfy both it and this License would be to refrain entirely from distribution of the Program.

If any portion of this section is held invalid or unenforceable under any particular circumstance, the balance of the section is intended to apply and the section as a whole is intended to apply in other circumstances.

It is not the purpose of this section to induce you to infringe any patents or other property right claims or to contest validity of any such claims; this section has the sole purpose of protecting the integrity of the free software distribution system, which is implemented by public license practices. Many people have made generous contributions to the wide range of software distributed through that system in reliance

on consistent application of that system; it is up to the author/donor to decide if he or she is willing to distribute software through any other system and a licensee cannot impose that choice.

This section is intended to make thoroughly clear what is believed to be a consequence of the rest of this License.

8. If the distribution and/or use of the Program is restricted in certain countries either by patents or by copyrighted interfaces, the original copyright holder who places the Program under this License may add an explicit geographical distribution limitation excluding those countries, so that distribution is permitted only in or among countries not thus excluded. In such case, this License incorporates the limitation as if written in the body of this License.
9. The Free Software Foundation may publish revised and/or new versions of the General Public License from time to time. Such new versions will be similar in spirit to the present version, but may differ in detail to address new problems or concerns.

Each version is given a distinguishing version number. If the Program specifies a version number of this License which applies to it and “any later version”, you have the option of following the terms and conditions either of that version or of any later version published by the Free Software Foundation. If the Program does not specify a version number of this License, you may choose any version ever published by the Free Software Foundation.

10. If you wish to incorporate parts of the Program into other free programs whose distribution conditions are different, write to the author to ask for permission.

For software which is copyrighted by the Free Software Foundation, write to the Free Software Foundation; we sometimes make exceptions for this. Our decision will be guided by the two goals of preserving the free status of all derivatives of our free software and of promoting the sharing and reuse of software generally.

NO WARRANTY

11 BECAUSE THE PROGRAM IS LICENSED FREE OF CHARGE, THERE IS NO WARRANTY FOR THE PROGRAM, TO THE EXTENT PERMITTED BY APPLICABLE LAW. EXCEPT WHEN OTHERWISE STATED IN WRITING THE COPYRIGHT HOLDERS AND/OR OTHER PARTIES PROVIDE THE PROGRAM "AS IS" WITHOUT WARRANTY OF ANY KIND, EITHER EXPRESSED OR IMPLIED, INCLUDING, BUT NOT LIMITED TO, THE IMPLIED WARRANTIES OF MERCHANTABILITY AND FITNESS FOR A PARTICULAR PURPOSE. THE ENTIRE RISK AS TO THE QUALITY AND PERFORMANCE OF THE PROGRAM IS WITH YOU. SHOULD THE PROGRAM PROVE DEFECTIVE, YOU ASSUME THE COST OF ALL NECESSARY SERVICING, REPAIR OR CORRECTION.

12 IN NO EVENT UNLESS REQUIRED BY APPLICABLE LAW OR AGREED TO IN WRITING WILL ANY COPYRIGHT HOLDER, OR ANY OTHER PARTY WHO MAY MODIFY AND/OR REDISTRIBUTE THE PROGRAM AS PERMITTED ABOVE, BE LIABLE TO YOU FOR DAMAGES, INCLUDING ANY GENERAL, SPECIAL, INCIDENTAL OR CONSEQUENTIAL DAMAGES ARISING OUT OF THE USE OR INABILITY TO USE THE PROGRAM (INCLUDING BUT NOT LIMITED TO LOSS OF DATA OR DATA BEING RENDERED INACCURATE OR LOSSES SUSTAINED BY YOU OR THIRD PARTIES OR A FAILURE OF THE PROGRAM TO OPERATE WITH ANY OTHER PROGRAMS), EVEN IF SUCH HOLDER OR OTHER PARTY HAS BEEN ADVISED OF THE POSSIBILITY OF SUCH DAMAGES.

END OF TERMS AND CONDITIONS

[English] CE statement

EU Declaration of Conformity



We, the undersigned,

Manufacturer:

ASUSTeK COMPUTER INC.

Address:

4F, No. 150, LI-TE Rd., PEITOU, TAIPEI 112, TAIWAN

Authorized representative in Europe:

ASUS COMPUTER GmbH

Address, City:

HARKORT STR. 21-23, 40880 RATINGEN

Country:

GERMANY

declare the following apparatus:

Product name:

Wireless AC3000 Tri Band Gigabit Router

Model name:

CT8

Additional information: ANNEX I

The object of the declaration described above is in conformity with the relevant Union harmonisation legislation:

Radio Equipment Directive – 2014/53/EU

Article 3.1(a)

EN 50385:2017 , EN 50663:2017 , EN 50665:2017 , EN 60950-1:2006/A2:2013 , EN 62311:2008 , EN 62368-1:2014 , EN 62479:2010

Article 3.1(b)

Draft EN 301 489-1 V2.2.0 , Draft EN 301 489-17 V3.2.0 , EN 55024:2010/A1:2015 , EN 55032:2015/AC:2016

Article 3.2

EN 300 328 V2.1.1 , EN 301 893 V2.1.1

Radio Equipment Class

Class 2

Ecodesign Directive – 2009/125/EC

1275/2008/EC , 278/2009/EC , EU 801/2013

RoHS Directive – 2011/65/EU

2015/863/EU , EN 50581:2012

Signature:

S.y. Shian, CEO

Place of issue:

Taipei, Taiwan

Date of issue:

30/01/2020

[Danish] CE statement

EU Overensstemmelseserklæring



Vi, undertegnede,

Fabrikant: ASUSTeK COMPUTER INC.
Adresse: 4F, No. 150, LI-TE Rd., PEITOU, TAIPEI 112, TAIWAN
Autoriseret repræsentant i Europa: ASUS COMPUTER GmbH
Adresse, By: HARKORT STR. 21-23, 40880 RATINGEN
Land: GERMANY

erklærer, at følgende apparat:

Produktnavn: Wireless AC3000 Tri Band Gigabit Router
Modelnavn: CT8

Supplerende oplysninger: **ANNEX I**

Ovenstående produkt er i overensstemmelse med den relevante harmoniseringslovgivning for EU:

Radioudstyr Direktiv – 2014/53/EU

Artikel 3.1a
EN 50385:2017 , EN 50663:2017 , EN 50665:2017 , EN 60950-1:2006/A2:2013 , EN 62311:2008 , EN 62368-1:2014 ,
EN 62479:2010

Artikel 3.1b
Draft EN 301 489-1 V2.2.0 , Draft EN 301 489-17 V3.2.0 , EN 55024:2010/A1:2015 , EN 55032:2015/AC:2016
Artikel 3.2
EN 300 328 V2.1.1 , EN 301 893 V2.1.1

Radioudstyr klasse
Klasse 2

Miljøvenligt design Direktiv – 2009/125/EC

1275/2008/EC , 278/2009/EC , EU 801/2013

RoHS Direktiv – 2011/65/EU

2015/863/EU , EN 50581:2012

Underskrift:

S.y. Shian, Administrerende direktør/CEO

Udstedelsessted:

Taipei, Taiwan

Udstedelsesdato:

30/01/2020

[Dutch] CE statement

EU-conformiteitsverklaring



Wij, de ondergetekenden,

Fabrikant: ASUSTeK COMPUTER INC.
Adres: 4F, No. 150, LI-TE Rd., PEITOU, TAIPEI 112, TAIWAN
Geautoriseerde vertegenwoordiger in Europa: ASUS COMPUTER GmbH
Adres, plaats: HARKORT STR. 21-23, 40880 RATINGEN
Land: GERMANY

Verklaren dat het volgende apparaat:

Productnaam: Wireless AC3000 Tri Band Gigabit Router
Modelnaam: CT8

Aanvullende informatie: ANNEX I

Het onderwerp van de bovenstaande verklaring is in overeenstemming met de desbetreffende harmoniseringswetgeving van de Europese Unie:

Radioapparatuur Richtlijn – 2014/53/EU

Artikel 3.1a
EN 50385:2017 , EN 50663:2017 , EN 50665:2017 , EN 60950-1:2006/A2:2013 , EN 62311:2008 , EN 62368-1:2014 ,
EN 62479:2010

Artikel 3.1b
Draft EN 301 489-1 V2.2.0 , Draft EN 301 489-17 V3.2.0 , EN 55024:2010/A1:2015 , EN 55032:2015/AC:2016

Artikel 3.2
EN 300 328 V2.1.1 , EN 301 893 V2.1.1

Radio apparatuur Klasse
Klasse 2

Ecologisch ontwerp Richtlijn – 2009/125/EC
1275/2008/EC , 278/2009/EC , EU 801/2013

RoHS Richtlijn – 2011/65/EU
2015/863/EU , EN 50581:2012

Handtekening:

S.y. Shian, Directeur/CEO

Plaats van afgifte:

Taipei, Taiwan

Datum van afgifte:

30/01/2020

Déclaration UE de Conformité



Nous, soussignés,

Fabricant: ASUSTeK COMPUTER INC.
Address: 4F, No. 150, LI-TE Rd., PEITOU, TAIPEI 112, TAIWAN
Représentant autorisé en Europe: ASUS COMPUTER GmbH
Adresse, ville: HARKORT STR. 21-23, 40880 RATINGEN
Pays: GERMANY

Déclarons l'appareil suivant:

Nom du produit: Wireless AC3000 Tri Band Gigabit Router
Nom du modèle: CT8

Informations complémentaires: ANNEX I

L'objet de la déclaration décrit ci-dessus est conforme avec la législation d'harmonisation de l'Union applicable:

Directive Équipement Radioélectrique – 2014/53/EU

Article 3.1a
EN 50385:2017 , EN 50663:2017 , EN 50665:2017 , EN 60950-1:2006/A2:2013 , EN 62311:2008 , EN 62368-1:2014 ,
EN 62479:2010

Article 3.1b
Draft EN 301 489-1 V2.2.0 , Draft EN 301 489-17 V3.2.0 , EN 55024:2010/A1:2015 , EN 55032:2015/AC:2016

Article 3.2
EN 300 328 V2.1.1 , EN 301 893 V2.1.1

Classe d'équipement Radio
Classe 2

Directive écoconception – 2009/125/EC

1275/2008/EC , 278/2009/EC , EU 801/2013

Directive RoHS – 2011/65/EU

2015/863/EU , EN 50581:2012

Signature:

S.y. Shian, Directeur Général/CEO

Lieu de délivrance:

Taipei, Taiwan

Date d'émission:

30/01/2020

[Finnish] CE statement

EU-vaatimustenmukaisuusvakuutus



Me, allekirjoittaneet,

Valmistaja:

ASUSTeK COMPUTER INC.

Osoite:

4F, No. 150, LI-TE Rd., PEITOU, TAIPEI 112, TAIWAN

Valtuutettu edustaja Euroopassa:

ASUS COMPUTER GmbH

Osoite, kaupunki:

HARKORT STR. 21-23, 40880 RATINGEN

Maa:

GERMANY

ilmoitamme seuraavan laitteen:

Tuotenimi:

Wireless AC3000 Tri Band Gigabit Router

Mallinimi:

CT8

Lisätietoja: **ANNEX I**

Yllä olevan ilmoituksen kohde on asiaa koskevan unionin yhdenmukaistamislainsäädännön mukainen:

Radiolaitteet Direktiiv – 2014/53/EU

3.1a artikla

EN 50385:2017 , EN 50663:2017 , EN 50665:2017 , EN 60950-1:2006/A2:2013 , EN 62311:2008 , EN 62368-1:2014 ,
EN 62479:2010

3.1b artikla

Draft EN 301 489-1 V2.2.0 , Draft EN 301 489-17 V3.2.0 , EN 55024:2010/A1:2015 , EN 55032:2015/AC:2016

3.2 artikla

EN 300 328 V2.1.1 , EN 301 893 V2.1.1

Radio-laitteiden luokka
luokka 2

Ekologisella suunnittelulla Direktiiv – 2009/125/EC

1275/2008/EC , 278/2009/EC , EU 801/2013

RoHS Direktiiv – 2011/65/EU

2015/863/EU , EN 50581:2012

Allekirjoitus:

S.y. Shian, Toimitusjohtaja/CEO

Myöntämispaikka:

Taipei, Taiwan

Myöntämispäivä:

30/01/2020

[German] CE statement

EU Konformitätserklärung



Hiermit erklären wir,

Hersteller: ASUSTeK COMPUTER INC.
Anschrift: 4F, No. 150, LI-TE Rd., PEITOU, TAIPEI 112, TAIWAN
Bevollmächtigter: ASUS COMPUTER GmbH
Anschrift des Bevollmächtigten: HARKORT STR. 21-23, 40880 RATINGEN
Land: GERMANY

dass nachstehend bezeichnete Produkte:

Produktbezeichnung: Wireless AC3000 Tri Band Gigabit Router
Modellbezeichnung: CT8

Zusatzangaben: ANNEX I

mit den nachstehend angegebenen, für das Produkt geltenden Richtlinien/Bestimmungen übereinstimmen:

Funkanlagen Richtlinie – 2014/53/EU

Artikel 3.1a

EN 50385:2017 , EN 50663:2017 , EN 50665:2017 , EN 60950-1:2006/A2:2013 , EN 62311:2008 , EN 62368-1:2014 , EN 62479:2010

Artikel 3.1b

Draft EN 301 489-1 V2.2.0 , Draft EN 301 489-17 V3.2.0 , EN 55024:2010/A1:2015 , EN 55032:2015/AC:2016

Artikel 3.2

EN 300 328 V2.1.1 , EN 301 893 V2.1.1

Funkanlagen Klasse

Klasse 2

Ökodesign Richtlinie – 2009/125/EC

1275/2008/EC , 278/2009/EC , EU 801/2013

RoHS Richtlinie – 2011/65/EU

2015/863/EU , EN 50581:2012

Unterschrift:

S.y. Shian, Geschäftsführer/CEO

Ort:

Taipei, Taiwan

Datum:

30/01/2020

[Greek] CE statement

Δήλωση Συμμόρφωσης ΕΕ



Εμείς, τα υπογράφοντα μέλη,

Κατασκευαστής:

ASUSTeK COMPUTER INC.

Διεύθυνση:

4F, No. 150, LI-TE Rd., PEITOU, TAIPEI 112, TAIWAN

Εξουσιοδοτημένος αντιπρόσωπος στην Ευρώπη:

ASUS COMPUTER GmbH

Διεύθυνση, Πόλη:

HARKORT STR. 21-23, 40880 RATINGEN

Χώρα:

GERMANY

δηλώνουμε την εξής συσκευή:

Όνομα προϊόντος:

Wireless AC3000 Tri Band Gigabit Router

Όνομα μοντέλου:

CT8

Συμπληρωματικές πληροφορίες: ANNEX I

Το αντικείμενο της δήλωσης που περιγράφεται παραπάνω είναι σύμφωνο προς την σχετική ενωσιακή νομοθεσία εναρμόνισης:

Ραδιοεξοπλισμό Οδηγία – 2014/53/EU

Άρθρο 3.1a

EN 50385:2017, EN 50663:2017, EN 50665:2017, EN 60950-1:2006/A2:2013, EN 62311:2008, EN 62368-1:2014, EN 62479:2010

Άρθρο 3.1b

Draft EN 301 489-1 V2.2.0, Draft EN 301 489-17 V3.2.0, EN 55024:2010/A1:2015, EN 55032:2015/AC:2016

Άρθρο 3.2

EN 300 328 V2.1.1, EN 301 893 V2.1.1

Κατηγορία Ραδιοεξοπλισμού

Τάξη 2

Οικολογικός σχεδιασμός Οδηγία – 2009/125/EC

1275/2008/EC, 278/2009/EC, EU 801/2013

RoHS Οδηγία– 2011/65/EU

2015/863/EU, EN 50581:2012

Υπογραφή:

S.y. Shian, Διευθύνων Σύμβουλος/CEO

Τόπος έκδοσης:

Taipei, Taiwan

Ημερομηνία έκδοσης:

30/01/2020

Dichiarazione di conformità



I sottoscritti,

Produttore:
Indirizzo:
Rappresentante autorizzato per l'Europa:
Indirizzo, Città:
paese:

ASUSTeK COMPUTER INC.
4F, No. 150, LI-TE Rd., PEITOU, TAIPEI 112, TAIWAN
ASUS COMPUTER GmbH
HARKORT STR. 21-23, 40880 RATINGEN
GERMANY

dichiarano che il seguente apparecchio:

Nome prodotto: Wireless AC3000 Tri Band Gigabit Router
Nome modello: CT8

Informazioni supplementari: ANNEX I

L'oggetto della dichiarazione di cui sopra è conforme alla pertinente normativa di armonizzazione dell'Unione Europea

Apparecchi radio Directive – 2014/53/EU

Articolo 3.1a
EN 50385:2017 , EN 50663:2017 , EN 50665:2017 , EN 60950-1:2006/A2:2013 , EN 62311:2008 , EN 62368-1:2014 ,
EN 62479:2010
Articolo 3.1b
Draft EN 301 489-1 V2.2.0 , Draft EN 301 489-17 V3.2.0 , EN 55024:2010/A1:2015 , EN 55032:2015/AC:2016
Articolo 3.2
EN 300 328 V2.1.1 , EN 301 893 V2.1.1

Classe di apparecchiature radio
Classe 2

Progettazione ecocompatibile Direttiva – 2009/125/EC

1275/2008/EC , 278/2009/EC , EU 801/2013

RoHS Direttiva – 2011/65/EU

2015/863/EU , EN 50581:2012

Firma:

S.y. Shian, Amministratore delegato/CEO

Luogo:

Taipei, Taiwan

Data del rilascio:

30/01/2020

[Portuguese] CE statement

EU Declaration of Conformity



We, the undersigned,

Manufacturer: ASUSTeK COMPUTER INC.
Address: 4F, No. 150, LI-TE Rd., PEITOU, TAIPEI 112, TAIWAN
Authorized representative in Europe: ASUS COMPUTER GmbH
Address, City: HARKORT STR. 21-23, 40880 RATINGEN
Country: GERMANY

declare the following apparatus:

Product name: Wireless AC3000 Tri Band Gigabit Router
Model name: CT8

Additional information: ANNEX I

The object of the declaration described above is in conformity with the relevant Union harmonisation legislation:

Equipamento de rádio Diretiva – 2014/53/EU

Artigo 3.1a
EN 50385:2017 , EN 50663:2017 , EN 50665:2017 , EN 60950-1:2006/A2:2013 , EN 62311:2008 , EN 62368-1:2014 ,
EN 62479:2010

Artigo 3.1b
Draft EN 301 489-1 V2.2.0 , Draft EN 301 489-17 V3.2.0 , EN 55024:2010/A1:2015 , EN 55032:2015/AC:2016

Artigo 3.2
EN 300 328 V2.1.1 , EN 301 893 V2.1.1

Classe de equipamento de Rádio
Classe 2

Concepção Ecológica Diretiva – 2009/125/EC

1275/2008/EC , 278/2009/EC , EU 801/2013

RoHS Diretiva – 2011/65/EU

2015/863/EU , EN 50581:2012

Signature:

S.y. Shian, Diretor Executivo/CEO

Place of issue:

Taipei, Taiwan

Date of issue:

30/01/2020

[Spanish] CE statement

UE Declaración de



Nosotros, los abajo firmantes,

Fabricante: ASUSTeK COMPUTER INC.
Dirección: 4F, No. 150, LI-TE Rd., PEITOU, TAIPEI 112, TAIWAN
Representante autorizado en Europa: ASUS COMPUTER GmbH
Dirección, Ciudad: HARKORT STR. 21-23, 40880 RATINGEN
País: GERMANY

Declaramos el siguiente producto:

Nombre del aparato: Wireless AC3000 Tri Band Gigabit Router
Nombre del modelo: CT8

Información adicional: ANNEX I

El objeto de la declaración descrita anteriormente es conforme con la legislación de armonización pertinente de la Unión:

Equipos Radioeléctricos Directiva – 2014/53/EU

Artículo 3.1a
EN 50385:2017 , EN 50663:2017 , EN 50665:2017 , EN 60950-1:2006/A2:2013 , EN 62311:2008 , EN 62368-1:2014 ,
EN 62479:2010

Artículo 3.1b
Draft EN 301 489-1 V2.2.0 , Draft EN 301 489-17 V3.2.0 , EN 55024:2010/A1:2015 , EN 55032:2015/AC:2016

Artículo 3.2
EN 300 328 V2.1.1 , EN 301 893 V2.1.1

Clase de Equipos de Radio
Clase 2

Directiva Diseño Ecológico – 2009/125/EC

1275/2008/EC , 278/2009/EC , EU 801/2013

Directiva RoHS – 2011/65/EU

2015/863/EU , EN 50581:2012

Firma:

S.y. Shian, Director Ejecutivo/CEO

Lugar de emisión:

Taipei, Taiwan

Fecha de emisión:

30/01/2020

[Swedish] CE statement

Försäkran om överensstämmelse



Undertecknande,

Tillverkare: ASUSTeK COMPUTER INC.
Adress: 4F, No. 150, LI-TE Rd., PEITOU, TAIPEI 112, TAIWAN
Auktoriserad representant i Europa: ASUS COMPUTER GmbH
Adress, Ort: HARKORT STR. 21-23, 40880 RATINGEN
Land: GERMANY

förklarar att följande apparat:

Produktnamn: Wireless AC3000 Tri Band Gigabit Router
Produkttnamn: CT8

Ytterligare information: ANNEX I

Syftet med deklarationen som beskrivs ovan är i enlighet med relevant harmonisering av EU-lagstiftningen:

Radioutrustning Direktiv – 2014/53/EU

Artikel 3.1a
EN 50385:2017 , EN 50663:2017 , EN 50665:2017 , EN 60950-1:2006/A2:2013 , EN 62311:2008 , EN 62368-1:2014 ,
EN 62479:2010

Artikel 3.1b
Draft EN 301 489-1 V2.2.0 , Draft EN 301 489-17 V3.2.0 , EN 55024:2010/A1:2015 , EN 55032:2015/AC:2016

Artikel 3.2
EN 300 328 V2.1.1 , EN 301 893 V2.1.1

Radioutrustningsklass
Klass 2

Ekodesign Direktiv – 2009/125/EC

1275/2008/EC , 278/2009/EC , EU 801/2013

RoHS Direktiv – 2011/65/EU

2015/863/EU , EN 50581:2012

Namnteckning:

S.y. Shian, Verkställande director/CEO

Plats för utfärdande:

Taipei, Taiwan

Dag för utfärdande:

30/01/2020

[Bulgarian] CE statement



ЕС декларация за съответствие

Ние, долуподписаните,

Производител:

ASUSTeK COMPUTER INC.

Адрес:

4F, No. 150, LI-TE Rd., PEITOU, TAIPEI 112, TAIWAN

Упълномощен представител в Европа:

ASUS COMPUTER GmbH

Адрес, град:

HARKORT STR. 21-23, 40880 RATINGEN

Държава:

GERMANY

декларираме, че следният апарат:

Име на продукта :

Wireless AC3000 Tri Band Gigabit Router

Име на модела :

CT8

Допълнителна информация: ANNEX I

Предметът на декларацията, описан по-горе, съответства на съответното законодателство на Съюза за хармонизация:

Radio Equipment Directive – 2014/53/EU

Article 3.1(a)

EN 50385:2017, EN 50663:2017, EN 50665:2017, EN 60950-1:2006/A2:2013, EN 62311:2008, EN 62368-1:2014, EN 62479:2010

Article 3.1(b)

Draft EN 301 489-1 V2.2.0, Draft EN 301 489-17 V3.2.0, EN 55024:2010/A1:2015, EN 55032:2015/AC:2016

Article 3.2

EN 300 328 V2.1.1, EN 301 893 V2.1.1

Radio Equipment Class

Class 2

Ecodesign Directive – 2009/125/EC

1275/2008/EC, 278/2009/EC, EU 801/2013

RoHS Directive – 2011/65/EU

2015/863/EU, EN 50581:2012

Подпис:

S.y. Shian, Главен изпълнителен директор/CEO

Място на издаване:

Taipei, Taiwan

Дата на издаване:

30/01/2020

[Croatian] CE statement

EU izjava o sukladnosti



Mi, dolje potpisani,

Proizvoa: ASUSTeK COMPUTER INC.
Adresa: 4F, No. 150, LI-TE Rd., PEITOU, TAIPEI 112, TAIWAN
Ovlašteni predstavnik u Europi: ASUS COMPUTER GmbH
Adresa, grad: HARKORT STR. 21-23, 40880 RATINGEN
Zemlja: GERMANY

izjavljujemo da sjedeći ureaj:

Naziv proizvoda: Wireless AC3000 Tri Band Gigabit Router
Naziv modela: CT8

Dodatni podaci: ANNEX I

Predmet gore opisane izjave u sukladnosti je s relevantnim usklaenim zakonima Unije:

Radio Equipment Directive – 2014/53/EU

Article 3.1(a)
EN 50385:2017 , EN 50663:2017 , EN 50665:2017 , EN 60950-1:2006/A2:2013 , EN 62311:2008 , EN 62368-1:2014 ,
EN 62479:2010

Article 3.1(b)

Draft EN 301 489-1 V2.2.0 , Draft EN 301 489-17 V3.2.0 , EN 55024:2010/A1:2015 , EN 55032:2015/AC:2016

Article 3.2

EN 300 328 V2.1.1 , EN 301 893 V2.1.1

Radio Equipment Class
Class 2

Ecodesign Directive – 2009/125/EC

1275/2008/EC , 278/2009/EC , EU 801/2013

RoHS Directive – 2011/65/EU

2015/863/EU , EN 50581:2012

Potpis:

S.y. Shian, Glavni izvršni direktor/CEO

Mjesto potpisa:

Taipei, Taiwan

Datum izdavanja:

30/01/2020

EU Prohlášení o shod



Niže podepsaný,

Výrobce:

ASUSTeK COMPUTER INC.

Výrobce:

4F, No. 150, LI-TE Rd., PEITOU, TAIPEI 112, TAIWAN

Autorizovaný zástupce v Evropě:

ASUS COMPUTER GmbH

Adresa, místo:

HARKORT STR. 21-23, 40880 RATINGEN

Zem:

GERMANY

prohlašuje, že následující přístroj:

Název produktu:

Wireless AC3000 Tri Band Gigabit Router

Název modelu:

CT8

Další informace: ANNEX I

Výše uvedený předmět tohoto prohlášení vyhovuje příslušné unijní harmonizační legislativě:

Rádiová Zařízení Smrnice – 2014/53/EU

lánek 3.1a

EN 50385:2017 , EN 50663:2017 , EN 50665:2017 , EN 60950-1:2006/A2:2013 , EN 62311:2008 , EN 62368-1:2014 , EN 62479:2010

lánek 3.1b

Draft EN 301 489-1 V2.2.0 , Draft EN 301 489-17 V3.2.0 , EN 55024:2010/A1:2015 , EN 55032:2015/AC:2016

lánek 3.2

EN 300 328 V2.1.1 , EN 301 893 V2.1.1

Třída rádiových zařízení

Třída 2

Ekodesignu Smrnice – 2009/125/EC

1275/2008/EC , 278/2009/EC , EU 801/2013

RoHS Smrnice – 2011/65/EU

2015/863/EU , EN 50581:2012

Signature:

S.y. Shian, Výkonný editel/CEO

Místo vydání:

Taipei, Taiwan

Datum vydání:

30/01/2020

[Hungarian] CE statement

EU-megfelelségi nyilatkozat



Mi, alulírottak

Gyártó: ASUSTeK COMPUTER INC.
Cím: 4F, No. 150, LI-TE Rd., PEITOU, TAIPEI 112, TAIWAN
Hivatalos képviselő Európában: ASUS COMPUTER GmbH
Cím (város): HARKORT STR. 21-23, 40880 RATINGEN
Ország: GERMANY

kijelentjük, hogy az alábbi berendezés:

Terméknév: Wireless AC3000 Tri Band Gigabit Router
Tipusnév: CT8

További információk: ANNEX I

A fent ismertetett nyilatkozat tárgya megfelel az Unió ide vonatkozó összehangolt jogszabályainak:

Radio Equipment Directive – 2014/53/EU

Article 3.1(a)
EN 50385:2017 , EN 50663:2017 , EN 50665:2017 , EN 60950-1:2006/A2:2013 , EN 62311:2008 , EN 62368-1:2014 ,
EN 62479:2010

Article 3.1(b)
Draft EN 301 489-1 V2.2.0 , Draft EN 301 489-17 V3.2.0 , EN 55024:2010/A1:2015 , EN 55032:2015/AC:2016

Article 3.2
EN 300 328 V2.1.1 , EN 301 893 V2.1.1

Radio Equipment Class
Class 2

Ecodesign Directive – 2009/125/EC

1275/2008/EC , 278/2009/EC , EU 801/2013

RoHS Directive – 2011/65/EU

2015/863/EU , EN 50581:2012

Alíráás:

S.y. Shian, Vezérigazgató/CEO

Kiadás helye:

Taipei, Taiwan

Kiadás dátuma:

30/01/2020

[Latvian] CE statement

ES Atbilstbas deklaracija



Ms, zemk parakstjušies,

Ražotjs:

Adrese:

Pilnvarotais prstvis Eirop:

Adrese, pilsta:

Valsts:

paziojam, ka šda ierce:

Izstrdjuma nosaukums:

Modea nosaukums:

ASUSTeK COMPUTER INC.

4F, No. 150, LI-TE Rd., PEITOU, TAIPEI 112, TAIWAN

ASUS COMPUTER GmbH

HARKORT STR. 21-23, 40880 RATINGEN

GERMANY

Wireless AC3000 Tri Band Gigabit Router

CT8

Additional information: ANNEX I

Iepriekš mintais deklarcijas priekšmets atbilst attiecigajiem ES saskaošanas tiesbu aktiem:

Radio Equipment Directive – 2014/53/EU

Article 3.1(a)

EN 50385:2017 , EN 50663:2017 , EN 50665:2017 , EN 60950-1:2006/A2:2013 , EN 62311:2008 , EN 62368-1:2014 , EN 62479:2010

Article 3.1(b)

Draft EN 301 489-1 V2.2.0 , Draft EN 301 489-17 V3.2.0 , EN 55024:2010/A1:2015 , EN 55032:2015/AC:2016

Article 3.2

EN 300 328 V2.1.1 , EN 301 893 V2.1.1

Radio Equipment Class

Class 2

Ecodesign Directive – 2009/125/EC

1275/2008/EC , 279/2009/EC , EU 801/2013

RoHS Directive – 2011/65/EU

2015/863/EU , EN 50581:2012

Paraksts:

S.y. Shian, Izpilddirektors/CEO

Izdošanas vieta:

Taipei, Taiwan

Izdošanas datums:

30/01/2020

[Lithuanian] CE statement

ES atitikties deklaracija



Mes, toliau pasirašiusieji:

Gamintojas:	ASUSTeK COMPUTER INC.
Adresas:	4F, No. 150, LI-TE Rd., PEITOU, TAIPEI 112, TAIWAN
galiotasis atstovas Europoje:	ASUS COMPUTER GmbH
Adresas, miestas:	HARKORT STR. 21-23, 40880 RATINGEN
Šalis:	GERMANY

atsakingai pareiškiamo, kad šis prietaisas:

Gaminio pavadinimas:	Wireless AC3000 Tri Band Gigabit Router
Modelio pavadinimas:	CT8

Papildoma informacija: **ANNEX I**

Pirmiau nurodytas deklaracijos objektas atitinka taikytinus suderintus Sąjungos teisės aktus:

Radio Equipment Directive – 2014/53/EU

Article 3.1(a)
EN 50385:2017 , EN 50663:2017 , EN 50665:2017 , EN 60950-1:2006/A2:2013 , EN 62311:2008 , EN 62368-1:2014 ,
EN 62479:2010

Article 3.1(b)
Draft EN 301 489-1 V2.2.0 , Draft EN 301 489-17 V3.2.0 , EN 55024:2010/A1:2015 , EN 55032:2015/AC:2016

Article 3.2
EN 300 328 V2.1.1 , EN 301 893 V2.1.1

Radio Equipment Class
Class 2

Ecodesign Directive – 2009/125/EC

1275/2008/EC , 278/2009/EC , EU 801/2013

RoHS Directive – 2011/65/EU

2015/863/EU , EN 50581:2012

Parašas:

S.y. Shian, Vyriausiasis pareignas/CEO

Leidimo vieta:

Taipei, Taiwan

Leidimo data:

30/01/2020

Deklaracja zgodności UE



My, niej podpisani,

Producent:

ASUSTeK COMPUTER INC.

Adres:

4F, No. 150, LI-TE Rd., PEITOU, TAIPEI 112, TAIWAN

Autoryzowany przedstawiciel w Europie:

ASUS COMPUTER GmbH

Adres, miasto:

HARKORT STR. 21-23, 40880 RATINGEN

Kraj:

GERMANY

owiadczamy, e niniejsze urzdzenie:

Nazwa produktu:

Wireless AC3000 Tri Band Gigabit Router

Nazwa modelu:

CT8

Informacje dodatkowe: ANNEX I

bdce przedmiotem opisanej powyzej deklaracji spenia wymogi waciwych przepisow unijnego prawodawstwa harmonizacyjnego:

Urzdzenia radiowe Dyrektywa – 2014/53/EU

Artyku 3.1a

EN 50385:2017 , EN 50663:2017 , EN 50665:2017 , EN 60950-1:2006/A2:2013 , EN 62311:2008 , EN 62368-1:2014 , EN 62479:2010

Artyku 3.1b

Draft EN 301 489-1 V2.2.0 , Draft EN 301 489-17 V3.2.0 , EN 55024:2010/A1:2015 , EN 55032:2015/AC:2016

Artyku 3.2

EN 300 328 V2.1.1 , EN 301 893 V2.1.1

Klasa urzdze Radiowych

Klasa 2

Ekoprojekt Dyrektywa – 2009/125/EC

1275/2008/EC , 278/2009/EC , EU 801/2013

RoHS Dyrektywa – 2011/65/EU

2015/863/EU , EN 50581:2012

Podpis:

S.y. Shian, Dyrektor naczelny/CEO

Jackson Yen, Zastpca Wiceprzewodniczego:

Taipei, Taiwan

Data wystawienia:

30/01/2020

[Romanian] CE statement

Declaraia UE de Conformitate



Subsemnatul,

Subsemnatul:

ASUSTeK COMPUTER INC.

Adres:

4F, No. 150, LI-TE Rd., PEITOU, TAIPEI 112, TAIWAN

Reprezentant autorizat în Europa:

ASUS COMPUTER GmbH

Adres, Ora:

HARKORT STR. 21-23, 40880 RATINGEN

ar:

GERMANY

declar urmatorul aparat:

Nume Produs:

Wireless AC3000 Tri Band Gigabit Router

Nume Model:

CT8

Informații suplimentare: ANNEX I

Obiectul declarației descris mai sus este în conformitate cu legislația relevantă de armonizare a Uniunii:

Echipamentele radio Directiva – 2014/53/EU

Articolul 3.1a

EN 50385:2017 , EN 50663:2017 , EN 50665:2017 , EN 60950-1:2006/A2:2013 , EN 62311:2008 , EN 62368-1:2014 , EN 62479:2010

Articolul 3.1b

Draft EN 301 489-1 V2.2.0 , Draft EN 301 489-17 V3.2.0 , EN 55024:2010/A1:2015 , EN 55032:2015/AC:2016

Articolul 3.2

EN 300 328 V2.1.1 , EN 301 893 V2.1.1

Clasa echipamentului Radio

Clas 2

Ecologic Directiva – 2009/125/EC

1275/2008/EC , 278/2009/EC , EU 801/2013

RoHS Directiva – 2011/65/EU

2015/863/EU , EN 50581:2012

Semnătură:

S.y. Shian, Director executiv/CEO

Locul emiterii:

Taipei, Taiwan

Data emiterii:

30/01/2020

[Slovanian] CE statement

Izjava EU o skladnosti



Spodaj podpisani

Proizvajalec:

ASUSTeK COMPUTER INC.

Naslov:

4F, No. 150, LI-TE Rd., PEITOU, TAIPEI 112, TAIWAN

Pooblašeni zastopnik v Evropi:

ASUS COMPUTER GmbH

Naslov, mesto:

HARKORT STR. 21-23, 40880 RATINGEN

Država:

GERMANY

izjavljamo, da je ta naprava:

Ime izdelka:

Wireless AC3000 Tri Band Gigabit Router

Ime modela:

CT8

Dodatne informacije: ANNEX I

Predmet zgoraj navedene izjave je v skladu z ustrezno harmonizacijsko zakonodajo Unije:

Radio Equipment Directive – 2014/53/EU

Article 3.1(a)

EN 50385:2017 , EN 50663:2017 , EN 50665:2017 , EN 60950-1:2006/A2:2013 , EN 62311:2008 , EN 62368-1:2014 , EN 62479:2010

Article 3.1(b)

Draft EN 301 489-1 V2.2.0 , Draft EN 301 489-17 V3.2.0 , EN 55024:2010/A1:2015 , EN 55032:2015/AC:2016

Article 3.2

EN 300 328 V2.1.1 , EN 301 893 V2.1.1

Radio Equipment Class

Class 2

Ecodesign Directive – 2009/125/EC

1275/2008/EC , 278/2009/EC , EU 801/2013

RoHS Directive – 2011/65/EU

2015/863/EU , EN 50581:2012

Podpis:

S.y. Shian, izvršni direktor/CEO

Kraj izdaje:

Taipei, Taiwan

Datum izdaje:

30/01/2020

[Slovakian] CE statement

Vyhlasenie o zhode EÚ



My, dolu podpísaní,

Výrobca: ASUSTeK COMPUTER INC.
Adresa: 4F, No. 150, LI-TE Rd., PEITOU, TAIPEI 112, TAIWAN
Oprávnený zástupca v Európe: ASUS COMPUTER GmbH
Adresa, mesto: HARKORT STR. 21-23, 40880 RATINGEN
Krajina: GERMANY

týmto vyhlasujeme, že nasledovné zariadenie:

Názov výrobku: Wireless AC3000 Tri Band Gigabit Router
Názov modelu: CT8

Doplujúce informácie: ANNEX I

Predmet vyhlásenia, ktorý je vyššie opísaný, je v súlade s príslušnou harmonizáciou právnych predpisov v EÚ:

Radio Equipment Directive – 2014/53/EU

Article 3.1(a)
EN 50385:2017 , EN 50663:2017 , EN 50665:2017 , EN 60950-1:2006/A2:2013 , EN 62311:2008 , EN 62368-1:2014 ,
EN 62479:2010

Article 3.1(b)
Draft EN 301 489-1 V2.2.0 , Draft EN 301 489-17 V3.2.0 , EN 55024:2010/A1:2015 , EN 55032:2015/AC:2016

Article 3.2
EN 300 328 V2.1.1 , EN 301 893 V2.1.1

Radio Equipment Class
Class 2

Ecodesign Directive – 2009/125/EC

1275/2008/EC , 278/2009/EC , EU 801/2013

RoHS Directive – 2011/65/EU

2015/863/EU , EN 50581:2012

Podpis:

S.y. Shian, Výkonný riadite/CEO

Miesto vydania:

Taipei, Taiwan

Dátum vydania:

30/01/2020

[Turkish] CE statement

EU Uygunluk Beyan



Biz, bu imza altındaki

Üretici:

ASUSTeK COMPUTER INC.

Adres:

4F, No. 150, LI-TE Rd., PEITOU, TAIPEI 112, TAIWAN

Avrupa'daki Yetkili:

ASUS COMPUTER GmbH

Adres, ehir:

HARKORT STR. 21-23, 40880 RATINGEN

Ülke:

GERMANY

Aadaki ürünleri beyan ediyoruz:

Ürün ad:

Wireless AC3000 Tri Band Gigabit Router

Model ad:

CT8

Ek bilgi: ANNEX I

Yukarıda belirtilen beyan konusu birlik yasalarına göre uygundur:

Telsiz Donanım Direktifi – 2014/53/EU

Madde 3.1a

EN 50385:2017 , EN 50663:2017 , EN 50665:2017 , EN 60950-1:2006/A2:2013 , EN 62311:2008 , EN 62368-1:2014 , EN 62479:2010

Madde 3.1b

Draft EN 301 489-1 V2.2.0 , Draft EN 301 489-17 V3.2.0 , EN 55024:2010/A1:2015 , EN 55032:2015/AC:2016

Madde 3.2

EN 300 328 V2.1.1 , EN 301 893 V2.1.1

Radyo Ekipman sınıfı

Classe 2

Ekotasarım Direktif – 2009/125/EC

1275/2008/EC , 278/2009/EC , EU 801/2013

RoHS Direktif – 2011/65/EU

2015/863/EU , EN 50581:2012

mza:

S.y. Shian, Ba yöneticisi/CEO

Sürüm yeri:

Taipei, Taiwan

Sürüm tarihi:

30/01/2020

ASUS Contact information

ASUSTeK COMPUTER INC. (Asia Pacific)

Address 4F, NO. 150, LI-TE Rd., PEITOU, TAIPEI 112, TAIWAN
Telephone +886-2-2894-3447
Fax +886-2-2890-7798
Web site <https://www.asus.com>

Technical Support

Telephone +86-21-38429911
Online support <https://qr.asus.com/techserv>

ASUS COMPUTER INTERNATIONAL (America)

Address 48720 Kato Rd., Fremont, CA 94538, USA
Telephone +1-510-739-3777
Fax +1-510-608-4555
Web site <https://www.asus.com/us/>

Technical Support

Support fax +1-812-284-0883
Telephone +1-812-282-2787
Online support <https://qr.asus.com/techserv>

ASUS COMPUTER GmbH (Germany and Austria)

Address Harkortstrasse 21-23, 40880 Ratingen, Germany
Web site <https://www.asus.com/de>
Online contact <https://www.asus.com/support/Product/ContactUs/Services/questionform/?lang=de-de>

Technical Support

Telephone (DE) +49-2102-5789557
Telephone (AT) +43-1360-2775461
Online support <https://www.asus.com/de/support>

Free Manuals Download Website

<http://myh66.com>

<http://usermanuals.us>

<http://www.somanuals.com>

<http://www.4manuals.cc>

<http://www.manual-lib.com>

<http://www.404manual.com>

<http://www.luxmanual.com>

<http://aubethermostatmanual.com>

Golf course search by state

<http://golfingnear.com>

Email search by domain

<http://emailbydomain.com>

Auto manuals search

<http://auto.somanuals.com>

TV manuals search

<http://tv.somanuals.com>