

brother®

USER'S GUIDE

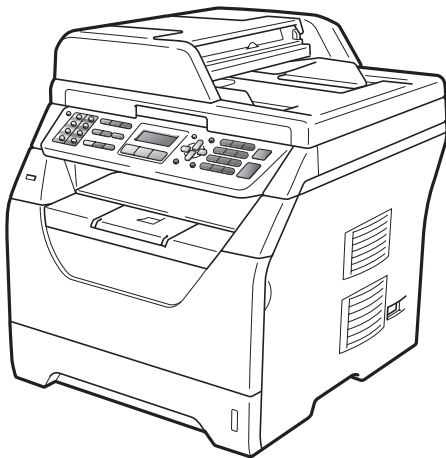

MFC-8370DN
MFC-8380DN

Version A

UK/IRE

If you need to call Customer Service

Please complete the following information for future reference:

Model Number: MFC-8370DN and MFC-8380DN
(Circle your model number)

Serial Number: ¹ _____

Date of Purchase: _____

Place of Purchase: _____

¹ The serial number is on the back of the unit. Retain this User's Guide with your sales receipt as a permanent record of your purchase, in the event of theft, fire or warranty service.

Register your product on-line at

<http://www.brother.com/registration/>

By registering your product with Brother, you will be recorded as the original owner of the product. Your registration with Brother:

- may serve as confirmation of the purchase date of your product should you lose your receipt; and
- may support an insurance claim by you in the event of product loss covered by insurance.

Approval Information and Compilation and Publication Notice

THIS EQUIPMENT IS DESIGNED TO WORK WITH A TWO WIRE ANALOGUE PSTN LINE FITTED WITH THE APPROPRIATE CONNECTOR.

APPROVAL INFORMATION

Brother advises that this product may not function correctly in a country other than where it was originally purchased, and does not offer any warranty in the event that this product is used on public telecommunication lines in other countries.

Compilation and Publication Notice

Under the supervision of Brother Industries Ltd., this manual has been compiled and published, covering the latest product descriptions and specifications.

The contents of this manual and the specifications of this product are subject to change without notice.

Brother reserves the right to make changes without notice in the specifications and materials contained herein and shall not be responsible for any damages (including consequential) caused by reliance on the materials presented, including but not limited to typographical and other errors relating to the publication.

EC Declaration of Conformity



EC Declaration of Conformity

Manufacturer

Brother Industries Ltd.,
15-1, Naeshiro-cho, Mizuho-ku, Nagoya 467-8561, Japan

Plant

Brother Technology (Shenzhen) Ltd.,
NO6 Gold Garden Ind. Nanling Buji, Longgang, Shenzhen, China

Herewith declare that:

Products description : Facsimile Machine
Type : Group3
Model Name : MFC-8370DN, MFC-8380DN

are in conformity with provisions of the R & TTE Directive (1999/5/EC) and we declare compliance with the following standards :

Harmonized standards applied :

Safety	EN60950-1:2006
EMC	EN55022:2006 Class B EN55024:1998 + A1:2001 + A2:2003 EN61000-3-2:2006 EN61000-3-3:1995 + A1:2001 + A2:2005

Year in which CE marking was first affixed : 2008

Issued by : Brother Industries, Ltd.

Date : 30th September, 2008

Place : Nagoya, Japan

Signature :

Junji Shiota
General Manager
Quality Management Dept.

Table of Contents

Section I General

1	General information	2
	Using the documentation	2
	Symbols and conventions used in the documentation	2
	Accessing the Software User's Guide and Network User's Guide	3
	Viewing documentation	3
	Accessing Brother Support (Windows®).....	5
	Control panel overview	6
	Data LED indications	9
2	Loading paper and documents	10
	Loading paper and print media	10
	Loading paper in the standard paper tray.....	10
	Loading paper in the multi-purpose tray (MP tray)	11
	Unprintable area	13
	Acceptable paper and other print media.....	14
	Recommended paper and print media	14
	Type and size of paper	15
	Handling and using special paper	17
	Loading documents	20
	Using the automatic document feeder (ADF)	20
	Using the scanner glass	21
3	General Setup	22
	Mode Timer.....	22
	Paper settings.....	22
	Paper Type	22
	Paper Size	23
	Tray Use in copy mode.....	23
	Tray Use in fax mode	24
	Tray Use in print mode	24
	Volume settings	25
	Ring volume.....	25
	Beeper volume	25
	Speaker volume.....	25
	Automatic daylight savings time	26
	Ecology features	26
	Toner Save	26
	Sleep Time	26
	LCD Contrast.....	27

4 Security features 28

Secure Function Lock 2.0 (MFC-8380DN)	28
Setting the password for the administrator	28
Changing the password for the administrator	29
Setting up the public user	29
Setting up restricted users	30
Turning Secure Function Lock on/off	30
Switching Users	31
Memory security (MFC-8370DN)	31
Setting up the password	32
Changing the Memory Security password	32
Turning Memory Security on/off	32
Setting Lock	33
Setting up the password	33
Changing your Setting Lock password	33
Turning Setting Lock on/off	34
Restricting dialling	34
Dial pad restriction	34
One Touch restriction	35
Speed Dial restriction	35

Section II Fax

5 Sending a fax 38

How to fax	38
Entering fax mode	38
Sending a single-sided fax from the ADF	38
Sending a 2-sided fax from the ADF (MFC-8380DN)	38
Sending a fax from the scanner glass	39
Faxing Letter size documents from the scanner glass	40
Cancelling a fax in progress	40
Broadcasting	40
Cancelling a Broadcast in progress	41
Additional sending operations	41
Sending faxes using multiple settings	41
Electronic cover page	42
Contrast	43
Changing Fax Resolution	43
Dual access	44
Real Time Transmission	44
Overseas Mode	44
Delayed Fax	45
Delayed batch transmission	45
Checking and cancelling waiting jobs	45
Sending a fax manually	45
Out of memory message	46
Maximum ADF output tray capacity	46

6 Receiving a fax 47

Receive modes	47
Choosing the Receive Mode	47
Using receive modes	48
Fax Only	48
Fax/Tel.....	48
Manual.....	48
External TAD	48
Receive Mode settings	49
Ring Delay	49
F/T Ring Time (Fax/Tel mode only).....	49
Fax Detect	50
Setting the Print Density	50
Additional receiving operations.....	51
Printing a reduced incoming fax	51
Duplex (2-sided) printing for Fax mode	51
Setting the Fax Receive Stamp	51
Receiving faxes into memory	52
Printing a fax from the memory	52
Out of Paper Reception	52

7 Telephone and external devices 53

Telephone line services.....	53
Setting the telephone line type	53
BT Call Sign (U.K. only).....	54
Connecting an external TAD	54
Connections.....	55
Recording an outgoing message (OGM).....	55
Multi-line connections (PBX)	56
External and extension telephones.....	57
Operating from external and extension telephones.....	57
For Fax/Tel mode only.....	57
Connecting an external or extension telephone	57
Using a non-Brother cordless external handset	59
Using Remote Codes	59

8 Dialling and storing numbers 60

How to dial	60
Manual dialling.....	60
One touch Dialling	60
Speed dialling	60
Search	61
Fax redial.....	61

Storing numbers	61
Storing a pause	61
Storing One Touch Dial numbers	61
Storing Speed Dial numbers	62
Changing One Touch and Speed Dial numbers	63
Setting up Groups for Broadcasting	63
Combining quick dial numbers	64
Tone or Pulse	64

9 Remote Fax Options 65

Fax Forwarding	65
Fax Storage	65
PC Fax Receive	66
Changing Remote Fax Options	67
Turning off Remote Fax Options	67
Remote retrieval	68
Setting a Remote Access Code	68
Using your Remote Access Code	68
Retrieving fax messages	69
Changing the Fax Forwarding number	69
Remote fax commands	70

10 Polling 71

Polling receive	71
Secure polling	71
Delayed polling	71
Sequential polling	72
Polled transmit	72
Setup for polled transmit	72
Setup for polled transmit with a secure code	73

11 Printing reports 74

Fax reports	74
Transmission verification report	74
Fax Journal	74
Reports	75
How to print a report	75

Section III Copy

12	Making copies	78
	How to copy	78
	Entering copy mode.....	78
	Making a single copy	78
	Making multiple copies	78
	Stop copying.....	78
	Copy options (temporary settings).....	79
	Enlarging or reducing the image copied	79
	Using the Options key	80
	Sorting copies using the ADF	81
	Improving copy quality.....	81
	Adjusting Contrast and Brightness	81
	Making N in 1 copies (page layout)	82
	Tray selection	83
	Duplex (2-sided) copying	84
	Duplex Copy (long edge flip)	84
	Advanced Duplex Copy (short edge flip)	85
	Out of memory message	86

Section IV Direct printing

13	Printing data from a USB Flash memory drive or a digital camera supporting mass storage	88
	Supported file formats.....	88
	Creating a PRN or PostScript® 3™ file for direct printing.....	88
	Printing data directly from the USB Flash memory drive or digital camera supporting mass storage	89
	Understanding the error messages	91

Section V Software

14	Software and Network features	94
	How to read the HTML User's Guide.....	94
	Windows®	94
	Macintosh	95

Section VI Appendixes

A	Safety and legal	98
	Choosing a location	98
	To use the machine safely	99
	Important safety instructions.....	103
	IEC60825-1+A2:2001 Specification.....	104
	Disconnect device	105
	Wiring information (U.K. only).....	105
	LAN connection	105
	Radio interference	105
	EU Directive 2002/96/EC and EN50419.....	106
	EU Directive 2006/66/EC - Removing or Replacing the Battery.....	106
	International ENERGY STAR® Compliance Statement.....	106
	Libtiff Copyright and License	107
	Trademarks.....	108
B	Options	109
	Optional paper tray (LT-5300) (MFC-8380DN)	109
	Memory board.....	109
	Installing extra memory	110
C	Troubleshooting and routine maintenance	111
	Troubleshooting	111
	If you are having difficulty with your machine	111
	Improving the print quality	120
	Setting Dial Tone detection	127
	Telephone line interference	127
	Error and maintenance messages.....	128
	Transferring your faxes or Fax Journal report	133
	Document jams.....	134
	Paper jams	135
	Routine maintenance.....	142
	Cleaning the outside of the machine	142
	Cleaning the scanner.....	143
	Cleaning the laser scanner window	144
	Cleaning the corona wire	145
	Cleaning the drum unit	146
	Replacing the consumable items	149
	Replacing a toner cartridge	150
	Replacing the drum unit.....	153

Replacing periodic maintenance parts.....	155
Machine Information	155
Checking the Serial Number.....	155
Checking the Page Counters.....	155
Checking the remaining life of parts	155
Reset	156
How to reset	156
Packing and shipping the machine	157
D Menu and features	159
On-screen programming.....	159
Menu table.....	159
Memory storage.....	159
Menu keys	159
How to access the menu mode	160
Menu table	161
Entering text	174
E Specifications	176
General	176
Print media.....	178
Fax.....	180
Copy	181
Scan	182
Print	183
Interfaces	184
Direct Print feature.....	184
Computer requirements	185
Consumable items	187
Ethernet wired network.....	188
F Glossary	190
G Index	194



General

General information	2
Loading paper and documents	10
General Setup	22
Security features	28

Using the documentation

Thank you for buying a Brother machine! Reading the documentation will help you make the most of your machine.

Symbols and conventions used in the documentation

The following symbols and conventions are used throughout the documentation.

Bold	Bold style identifies keys on the machine control panel or computer screen.
<i>Italics</i>	Italicized style emphasizes an important point or refers you to a related topic.
Courier New	Courier New font identifies the messages shown on the LCD of the machine.

WARNING

Warnings tell you what to do to prevent possible personal injury.

CAUTION

Cautions specify procedures you must follow or avoid to prevent possible minor injuries.

IMPORTANT

IMPORTANT describes procedures you must follow or avoid to prevent possible machine problems or damage to other objects.



Electrical Hazard icons alert you to a possible electrical shock.



Hot Surface icons warn you not to touch machine parts that are hot.



Notes tell you how you should respond to a situation that may arise or give tips about how the current operation works with other features.

Accessing the Software User's Guide and Network User's Guide

This User's Guide does not contain all the information about the machine such as how to use the advanced features of Fax, Printer, Scanner, PC Fax and Network. When you are ready to learn detailed information about these operations, read the **Software User's Guide** and **Network User's Guide**.

Viewing documentation

Viewing documentation (Windows®)

To view the documentation, from the **Start** menu, point to **Brother, MFC-XXXX** (where XXXX is your model name) from the program group, and then click **User's Guides in HTML format**.

If you have not installed the software, you can find the documentation by following the instructions below:

- 1 Turn on your PC. Insert the Brother CD-ROM labelled Windows® into your CD-ROM drive.
- 2 If the language selection screen appears, click your language.

- 3 If the model name screen appears, click your model name. The CD-ROM main menu will appear.



If this window does not appear, use Windows® Explorer to find and run the Start.exe program from the root directory of the Brother CD-ROM.

- 4 Click **Documentation**.
- 5 Click the documentation you want to read:
 - HTML documents (2 manuals): **Software User's Guide** and **Network User's Guide** in HTML format.

This format is recommended for viewing on your computer.
 - PDF documents (4 manuals): **User's Guide** for stand-alone operations, **Software User's Guide**, **Network User's Guide** and **Quick Setup Guide**.

This format is recommended for printing the manuals. Click to go to the Brother Solutions Center, where you can view or download the PDF documents. (Internet access and PDF Reader software are required.)

How to find scanning instructions

There are several ways you can scan documents. You can find the instructions as follows:

Software User's Guide:

- Scanning a document using the TWAIN driver in Chapter 2
- Scanning a document using the WIA driver (Windows® XP/Windows Vista®) in Chapter 2
- Using ControlCenter3 in Chapter 3
- Network Scanning in Chapter 4

ScanSoft™ PaperPort™ 11SE with OCR How-to-Guides:

- The complete ScanSoft™ PaperPort™ 11SE with OCR How-to-Guides can be viewed from the Help selection in the ScanSoft™ PaperPort™ 11SE application.

Viewing documentation (Macintosh)

- 1 Turn on your Macintosh. Insert the Brother CD-ROM labelled Macintosh into your CD-ROM drive.
- 2 The following window will appear.



- 3 Double-click the **Documentation** icon.
- 4 If the language selection screen appears, double-click your language.
- 5 Double-click the top page file to view the **Software User's Guide** and **Network User's Guide** in HTML format.
- 6 Click the documentation you want to read.
 - **Software User's Guide**
 - **Network User's Guide**



Note

The documents are also available in PDF format (4 manuals): **User's Guide** for stand-alone operations, **Software User's Guide**, **Network User's Guide** and **Quick Setup Guide**. The PDF format is recommended for printing the manuals.

Double-click **Brother Solutions Center** icon to go to the Brother Solutions Center, where you can view or download the PDF documents. (Internet access and PDF Reader software are required.)

How to find scanning instructions

There are several ways you can scan documents. You can find the instructions as follows:

Software User's Guide:

- Scanning in Chapter 9
- Using ControlCenter2 in Chapter 10
- Network Scanning in Chapter 11

Presto! PageManager User's Guide:

- The complete Presto! PageManager User's Guide can be viewed from the Help selection in the Presto! PageManager application.

Accessing Brother Support (Windows®)

You can find all the contacts you will need, such as Web support (Brother Solutions Center).

- Click **Brother Support** on the main menu. The following screen will appear:



- To access our web site (<http://www.brother.com/>) click **Brother Home Page**.
- For the latest news and product support information (<http://solutions.brother.com/>), click **Brother Solutions Center**.
- To visit our web site for original/genuine Brother supplies (<http://www.brother.com/original/>), click **Supplies Information**.
- To return to the main page, click **Back** or if you have finished, click **Exit**.

Control panel overview

MFC-8370DN and MFC-8380DN have the same keys.

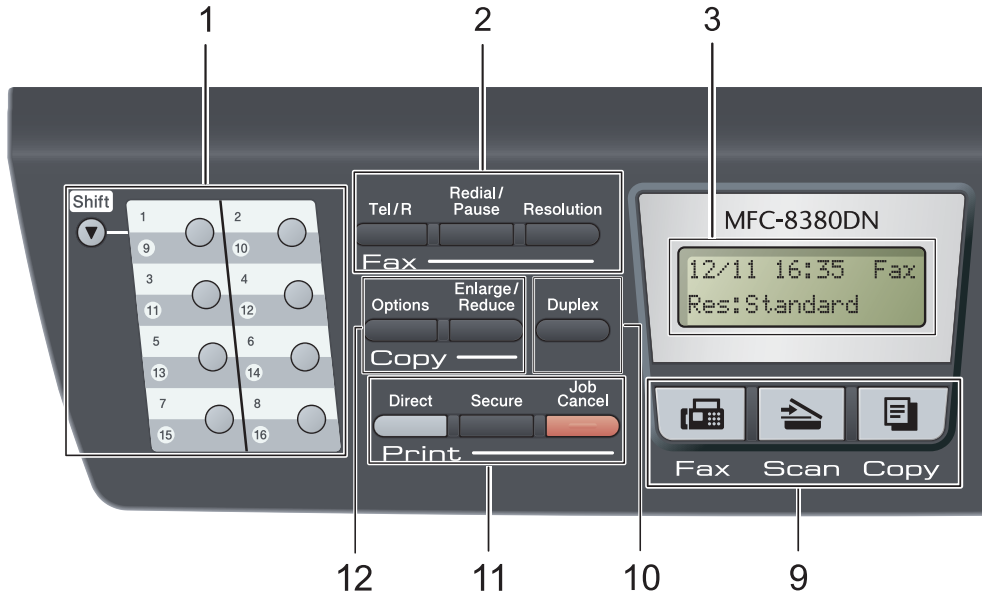

1 One Touch keys

These 8 keys give you instant access to 16 previously stored numbers.

Shift

Lets you access One Touch numbers 9 to 16 when held down.

2 Fax and telephone keys:

Tel/R

This key is used to have a telephone conversation after picking up the external handset during the F/T pseudo-ring.

When connected to a PBX, you can use this key to gain access to an outside line, to recall an operator, or to transfer a call to another extension.

Resolution

Sets the resolution when sending a fax.

Redial/Pause

Redials the last number called. It also inserts a pause when programming quick dial numbers or when dialing a number manually.

3 LCD

Displays messages to help you set up and use your machine.

4 Data LED

The LED will flash depending on the machine status.

5 Menu keys:

Menu

Lets you access the Menu to program your settings in this machine.

Clear/Back

Deletes entered data or lets you cancel the current setting.

OK

Lets you store your settings in the machine.

Volume Keys

◀ or ▶

Press to scroll backwards or forwards through menu selections. Press to change the volume when in fax or standby mode.

▲ or ▼

Press to scroll through the menus and options.



Lets you look up numbers stored in memory. It also lets you access speed dial numbers directly if you press , and then enter a three digit number.



6 Dial pad

Use these keys to dial telephone and fax numbers and as a keyboard for entering information into the machine.

The # key temporarily switches the dialling mode from Pulse to Tone during a telephone call.

7 Stop/Exit

Stops an operation or exits from a menu.

8 Start

Lets you start sending faxes, making copies or scanning.

9 Mode keys:



Fax

Puts the machine in Fax mode.



Scan

Puts the machine in Scan mode.

(For details about scanning, see the *Software User's Guide* on the CD-ROM.)



Copy

Puts the machine in Copy mode.

10 Duplex

You can choose Duplex to copy on both sides of the paper. (Scan and Print for MFC-8380DN, Print only for MFC-8370DN)

11 Print keys:

Direct

Lets you print data from a USB Flash memory drive connected directly to the machine. (See *Printing data directly from the USB Flash memory drive or digital camera supporting mass storage* on page 89)

Secure

You can print data saved in memory when you enter your four-digit password. (For details about using the Secure key, see the *Software User's Guide* on the CD-ROM.)

When using Secure Function Lock, you can switch restricted users by holding down **Shift** as you press **Secure**.

(See *Secure Function Lock 2.0* (MFC-8380DN) on page 28.)

Job Cancel

Cancels a programmed print job and clears it from the machine's memory.

To cancel multiple print jobs, hold down this key until the LCD shows

Job Cancel (All).

12 Copy keys:

Options

You can quickly and easily choose temporary settings for copying.



Enlarge/Reduce

Reduces or enlarges copies.

Data LED indications

The **Data** LED (light emitting diode) will flash and turn on or off depending on the machine's status.



LED	LED Status	Machine Status	Description
	LED is off.	Ready Mode	The machine is ready to print, in sleep mode, there is no print data, or the power switch is off.
	LED is on.	Data remaining in Memory	Print data remains in the machine memory.
	LED is blinking.	Receiving Data.	The machine is either receiving data from the computer, processing data in memory, or printing.

2

Loading paper and documents

Loading paper and print media

The machine can feed paper from the standard paper tray, optional lower tray (MFC-8380DN) or multi-purpose tray.

When you put paper into the paper tray, note the following:

- If your application software supports paper size selection on the print menu, you can select it through the software. If your application software does not support it, you can set the paper size in the printer driver or by using the control panel buttons.

Loading paper in the standard paper tray

Printing on plain paper, thin paper, bond paper, recycled paper or transparencies from the paper tray

- 1 Pull the paper tray completely out of the machine.



- 2 While pressing the blue paper-guide release lever (1), slide the paper guides to fit the paper size you are loading in the tray. Make sure that the guides are firmly in the slots.

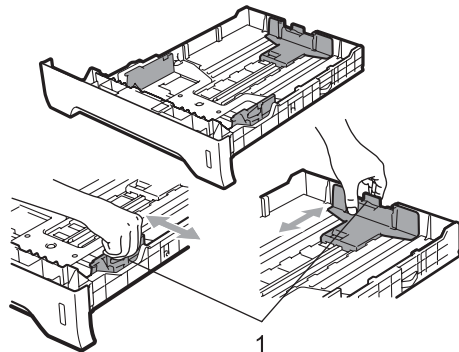

- 3 Fan the stack of paper well to avoid paper jams and misfeeds.

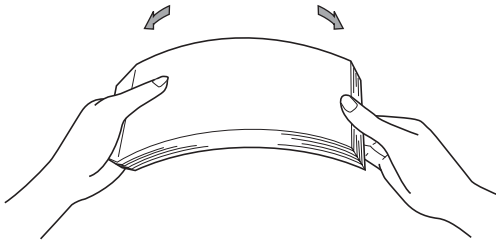

- 4 Put paper in the tray, and make sure that the paper is below the maximum paper mark (1). The side to be printed on must be face down.

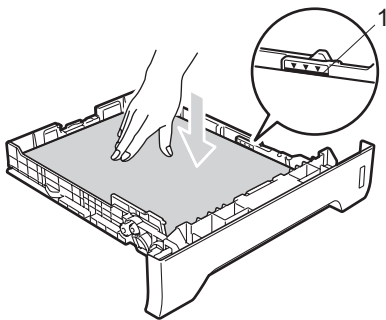

! IMPORTANT

Make sure the paper guides touch the sides of the paper so it will feed correctly.

- 5 Put the paper tray firmly back in the machine. Make sure that it is completely inserted into the machine.
- 6 Fold out the support flap (1) to prevent paper from sliding off the face-down output tray.

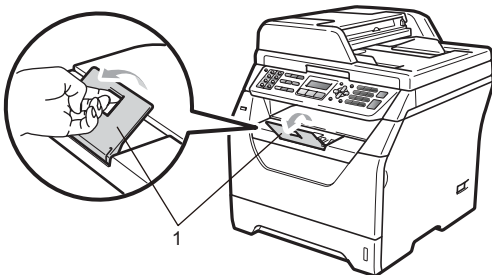

Loading paper in the multi-purpose tray (MP tray)

You can load up to 3 envelopes or special print media in the MP tray or up to 50 sheets of plain paper. Use this tray to print or copy on thick paper, bond paper, envelopes, labels or transparencies.

Printing on thick paper, bond paper, envelopes, labels and transparencies

Before loading, press the corners and sides of the envelopes to make them as flat as possible.

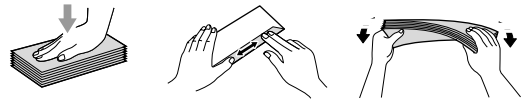

When the back output tray is pulled down, the machine has a straight paper path from the MP tray through to the back of the machine. Use this paper feed and output method when you want to print on thick paper, bond paper, envelopes, labels or transparencies.

! IMPORTANT

Remove each printed sheet or envelope immediately to prevent a paper jam.

- 1 Open the back cover (back output tray).

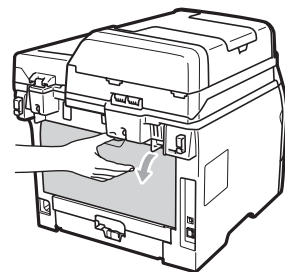

- 2 <For printing envelopes only> Pull down the two blue levers, one on the left-hand side and one on the right-hand side, toward you as shown in the illustration below.

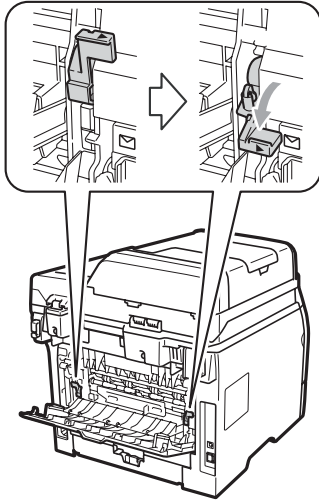

- 3 Open the MP tray and lower it gently.

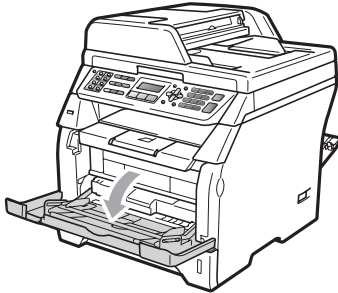

- 4 Pull out the MP tray support (1) and unfold the flap (2).

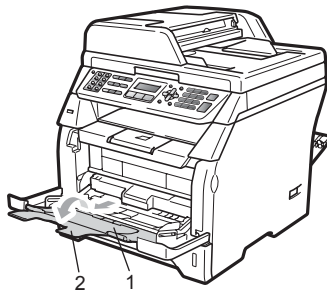

- 5 While pressing the paper side guide release lever, slide the paper guides to fit the width of the paper that you are going to use.

! IMPORTANT

Make sure the paper guides touch the sides of the paper so it will feed properly.

- 6 Put the envelopes (up to 3), thick paper, labels or transparencies in the MP tray with the top edge first and the print side face up. Make sure that the paper stays under the maximum paper mark (▼).

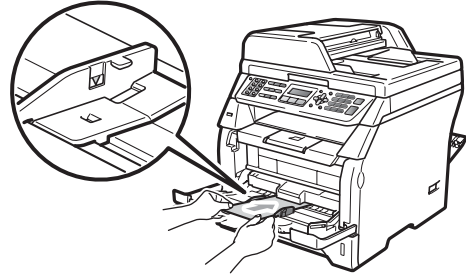

Unprintable area

Unprintable area for faxes and copies

The figures below show unprintable areas.

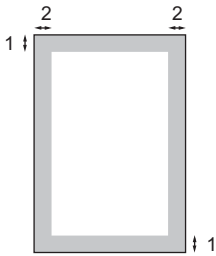

Usage	Document Size	Top (1)	Left (2)
		Bottom (1)	Right(2)
Fax	A4	3 mm	1 mm
	Letter	3 mm	4 mm
Copy	A4	3 mm	2 mm
	Letter	3 mm	4 mm



Note

(For copies) This unprintable area shown above is for a single copy or a 1 in 1 copy using A4 size paper. The unprintable area changes with the paper size.

Unprintable area when printing from a computer

When using the printer driver the printable area is smaller than the paper size, as shown below.

Portrait

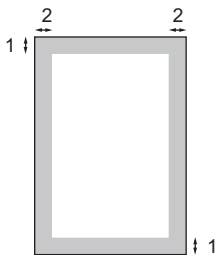

Landscape

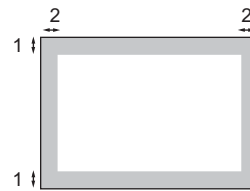

		Windows® printer driver and Macintosh printer driver	BRScript Driver for Windows® and Macintosh
Portrait	1	4.23 mm	4.23 mm
	2	6.35 mm	4.23 mm
Landscape	1	4.23 mm	4.23 mm
	2	5.08 mm	4.23 mm



Note

The unprintable area shown above is for A4 size paper. The unprintable area changes with the paper size.

Acceptable paper and other print media

Print quality may vary according to the type of paper you are using.

You can use the following types of print media: thin paper, plain paper, thick paper, bond paper, recycled paper, transparencies, labels or envelopes.

For best results, follow the instructions below:

- Use paper made for plain paper copying.
- Use paper that is 60 to 105 g/m².
- Use labels and transparencies which are designed for use in laser machines.
- DO NOT put different types of paper in the paper tray at the same time because it may cause paper jams or misfeeds.
- For correct printing, you must choose the same paper size from your software application as the paper in the tray.
- Avoid touching the printed surface of the paper immediately after printing.
- When you use transparencies remove each sheet immediately to prevent smudging or paper jams.
- Use long grain paper with a neutral Ph value, and a moisture content of approx. 5%.

Recommended paper and print media

To get the best print quality, we suggest using the following paper.

Paper Type	Item
Plain paper	Xerox Premier TCF 80 g/m ²
	Xerox Business 80 g/m ²
Recycled Paper	Xerox Recycled Supreme 80 g/m ²
Transparency	3M CG3300
Labels	Avery laser label L7163
Envelope	Antalis River series (DL)

Type and size of paper

The machine loads paper from the installed standard paper tray, optional lower tray (MFC-8380DN) or multi-purpose tray.

Standard paper tray

Since the standard paper tray is a universal type, you can use any of the paper sizes (one paper type and size at a time) listed in the table in *Paper capacity of the paper trays* on page 15. The standard paper tray can hold up to 250 sheets of Letter/A4 size paper (80 g/m²). Paper can be loaded up to the maximum paper mark on the sliding paper width guide.

Multi-purpose tray (MP tray)

The MP tray can hold up to 50 sheets of plain paper (80 g/m²) or up to 3 envelopes. Paper can be loaded up to the maximum paper mark on the sliding paper width guide.

Paper capacity of the paper trays

	Paper size	Paper types	No. of sheets
Paper Tray (Tray #1)	A4, Letter, Executive, A5, A5 (Long Edge), A6, B5, B6.	Plain paper, Thin paper, Bond paper and Recycled paper	up to 250 [80 g/m ²]
		Transparency	up to 10
Multi-purpose tray (MP tray)	Width: 69.8 to 216 mm Length: 116 to 406.4 mm	Plain paper, Thin paper, Thick paper, Bond paper, Recycled paper, Envelopes and Labels.	up to 50 [80 g/m ²] up to 3 (envelopes)
		Transparency	up to 10
Paper Tray (Tray#2) (MFC-8380DN)	A4, Letter, Executive, A5, B5 and B6.	Thin paper, Plain paper, Bond paper and Recycled paper	up to 250 [80 g/m ²]

Optional lower tray (LT-5300) (MFC-8380DN)

The optional lower tray can hold up to 250 sheets of Letter/A4 size paper (80 g/m²). Paper can be loaded up to the top line of the maximum paper mark on the sliding paper width guide.

The name for the paper trays in the printer driver in this Guide are as follows:

Tray and optional unit	Name
Standard paper tray	Tray 1
Optional lower tray (MFC-8380DN)	Tray 2
Multi-purpose tray	MP tray

Recommended paper specifications

The following paper specifications are suitable for this machine.

Basis weight	75-90 g/m ²
Thickness	80-110 μm
Roughness	Higher than 20 sec.
Stiffness	90-150 cm ³ /100
Grain direction	Long grain
Volume resistivity	10e ⁹ -10e ¹¹ ohm
Surface resistivity	10e ⁹ -10e ¹² ohm-cm
Filler	CaCO ₃ (Neutral)
Ash content	Below 23 wt%
Brightness	Higher than 80%
Opacity	Higher than 85%

Handling and using special paper

The machine is designed to work well with most types of xerographic and bond paper. However, some paper variables may have an effect on print quality or handling reliability. Always test samples of paper before purchasing to ensure desirable performance. Store paper in its original packaging and keep it sealed. Keep the paper flat and away from moisture, direct sunlight and heat.

Some important guidelines when selecting paper are:

- Do not use inkjet paper because it may cause a paper jam or damage your machine.
- Preprinted paper must use ink that can withstand the temperature of the machine's fusing process (200 degrees centigrade).
- If you use bond paper, paper having a rough surface or paper that is wrinkled or creased, the paper may exhibit degraded performance.

Types of paper to avoid

! IMPORTANT

Some types of paper may not perform well or may cause damage to your machine.

DO NOT use paper:

- that is highly textured
- that is extremely smooth or shiny
- that is curled or warped

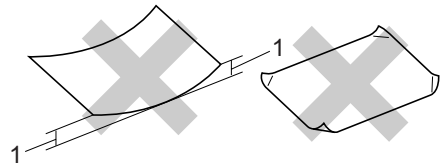

1 2mm or greater curl may cause jams to occur.

- that is coated or has a chemical finish
- that is damaged, creased or folded
- that exceeds the recommended weight specification in this guide
- with tabs and staples
- with letterheads using low temperature dyes or thermography
- that is multipart or carbonless
- that is designed for inkjet printing

If you use any of the types of paper listed above, they may damage your machine. This damage may not be covered under any Brother warranty or service agreement.

Envelopes

Most envelopes will be suitable for your machine. However, some envelopes may have feed and print-quality problems because of the way they have been made. A suitable envelope should have edges with straight, well-creased folds and the leading edge should not be thicker than two sheets of paper. The envelope should lie flat and not be of baggy or flimsy construction. You should buy quality envelopes from a supplier who understands that you will be using the envelopes in a laser machine.

Envelopes can only be fed from the MP tray. Do not print envelopes using duplex printing. We recommend that you print a test envelope to make sure the print results are what you want before you print or purchase a large quantity of envelopes.

Check the following:

- Envelopes should have a lengthwise sealing flap.
- The sealing flaps should be folded crisply and correctly (irregularly cut or folded envelopes may cause paper jams).
- Envelopes should consist of two layers of paper in the area circled in figure below.

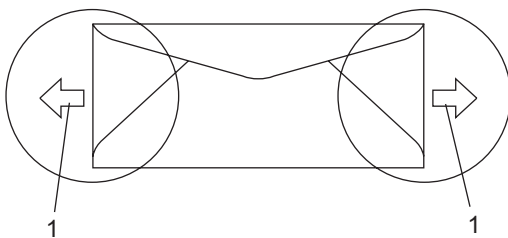

1 Feeding direction

- Envelope joints that are sealed by the manufacturer should be secure.
- We recommend that you do not print within 15 mm of the edges of envelopes.

Types of envelopes to avoid

! IMPORTANT

DO NOT use envelopes:

- that are damaged, curled, wrinkled or an unusual shape
- that are extremely shiny or textured
- with clasps, staples, snaps or tie strings
- with self-adhesive closures
- that are of a baggy construction
- that are not sharply creased
- that are embossed (have raised writing on them)
- that were previously printed by a laser machine
- that are pre-printed on the inside
- that cannot be arranged neatly when stacked
- that are made of paper that weighs more than the paper weight specifications for the machine
- with edges that are not straight or consistently square
- with windows, holes, cut-outs or perforations
- with glue on surface as shown in figure below

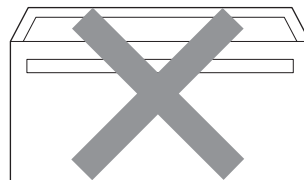

- with double flaps as shown in figure below

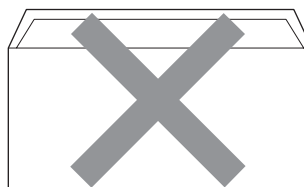

- with sealing flaps that have not been folded at purchase
- with sealing flaps as shown in figure below

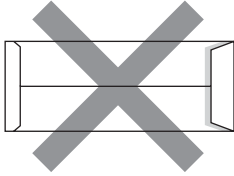

- with each side folded as shown in figure below

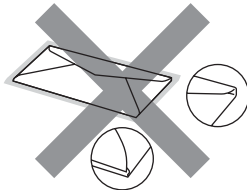

If you use any of the types of envelopes listed above, they may damage your machine. This damage may not be covered under any Brother warranty or service agreement.

Occasionally you may experience paper feed problems caused by the thickness, size and flap shape of the envelopes you are using.

Labels

The machine will print on most types of labels designed for use with a laser machine. Labels should have an adhesive that is acrylic-based since this material is more stable at the high temperatures in the fuser unit. Adhesives should not come in contact with any part of the machine, because the label stock may stick to the drum unit or rollers and cause jams and print quality problems. No adhesive should be exposed between the labels. Labels should be arranged so that they cover the entire length and width of the sheet. Using labels with spaces may result in labels peeling off and causing serious jams or print problems.

All labels used in this machine must be able to withstand a temperature of 392 degrees Fahrenheit (200 degrees centigrade) for a period of 0.1 seconds.

Label sheets should not exceed the paper weight specifications described in this User's Guide. Labels exceeding this specification may not feed or print correctly and may cause damage to your machine.

Labels can be fed from the MP Tray.

Types of labels to avoid

Do not use labels that are damaged, curled, wrinkled or an unusual shape.

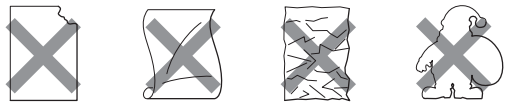

! IMPORTANT

DO NOT feed part used label sheets. The exposed carrier sheet will damage your machine.

Loading documents

Using the automatic document feeder (ADF)

The ADF can hold up to 20 pages of A4 size paper and feeds each sheet individually. Use standard 80 g/m² paper and always fan the pages before putting them in the ADF.

Recommended environment

Temperature: 20 to 30° C
 Humidity: 50% - 70%
 Paper: Xerox Premier TCF 80 g/m² or Xerox Business 80 g/m²

! IMPORTANT

- DO NOT leave thick documents on the scanner glass. If you do this, the ADF may jam.
- DO NOT use paper that is curled, wrinkled, folded, ripped, stapled, paper-clipped, pasted or taped.
- DO NOT use cardboard, newspaper or fabric.
- To avoid damaging your machine while using the ADF, DO NOT pull on the document while it is feeding.



Note

To scan documents that are not suitable for the ADF see *Using the scanner glass* on page 21.

- Make sure documents written with ink are completely dry.
- Documents to be faxed must be from 148 to 215.9 mm wide and from 148 to 355.6 mm long, and of a standard weight [80 g/m²].

- 1 Unfold the ADF output tray (1).

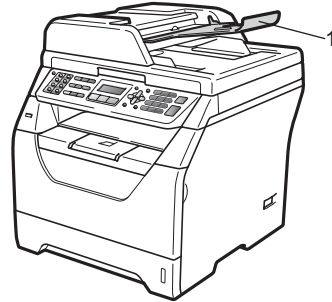

- 2 Fan the pages well.
- 3 Place your document **face down, top edge first** in the ADF until you feel it touch the feed roller.

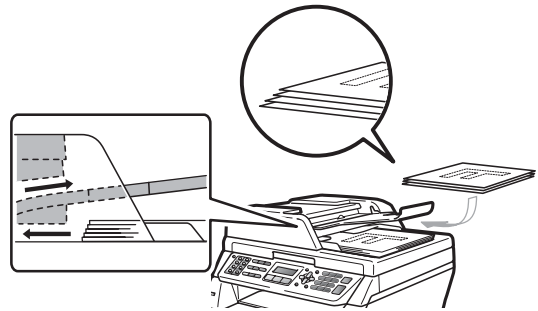

Note

Remove all printed documents from the ADF output tray before placing any new documents in the ADF.

- 4 Adjust the paper guides (1) to fit the width of your document.

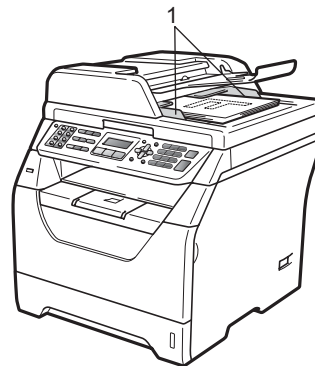

Using the scanner glass

You can use the scanner glass to fax, copy or scan pages of a book or one page at a time. Documents can be up to 215.9 mm wide and 297 mm long.



Note

To use the scanner glass, the ADF must be empty.

- 1 Lift the document cover.
- 2 Using the document guidelines on the left and top, place the document in the upper left hand corner with the document face down on the scanner glass.

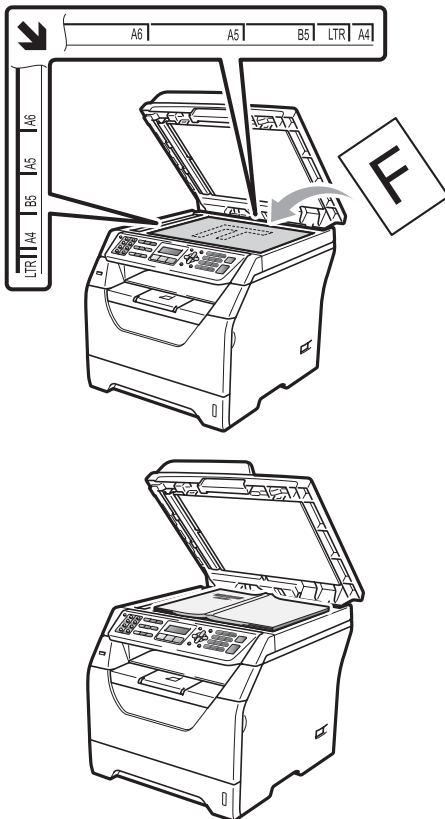

- 3 Close the document cover.

! IMPORTANT

If the document is a book or is thick do not slam the cover or press on it.

3

General Setup

Mode Timer

The machine has three mode keys on the control panel: **Fax**, **Scan**, and **Copy**.

You can set how much time the machine takes after the last Copy or Scan operation to return to Fax mode. If you choose **Off**, the machine will stay in the mode you used last.

This setting also sets the time the machine will change from individual user to the Public user when using Secure Function Lock. (See *Switching Users* on page 31.)

(MFC-8380DN)



Fax Scan Copy

- 1 Press **Menu**, **1**, **1**.
- 2 Press **▲** or **▼** to choose **0 Sec**, **30 Secs**, **1 Min**, **2 Mins**, **5 Mins** or **Off**. Press **OK**.
- 3 Press **Stop/Exit**.

Paper settings

Paper Type

Set up the machine for the type of paper you are using. This will give you the best print quality.

- 1 Do one of the following:
 - To set the paper type for the **MP Tray** press **Menu**, **1**, **2**, **1**, **1**.
 - To set the paper type for **Tray#1** press **Menu**, **1**, **2**, **1**, **2**.
 - To set the paper type for **Tray#2**¹ press **Menu**, **1**, **2**, **1**, **3** if you installed the optional tray.
- 2 Press **▲** or **▼** to choose **Thin**, **Plain**, **Thick**, **Thicker**, **Transparency** or **Recycled Paper**. Press **OK**.

¹ **Tray#2 Only** or **T2** appears only if the optional tray is installed. The optional tray is available for MFC-8380DN.

- 3 Press **Stop/Exit**.



Note

You can choose **Transparency** for **Tray#1** and the **MP Tray**.

Paper Size

You can use several different sizes of paper for printing copies: A4, Letter, Legal, Executive, A5, A5 L, A6, B5, B6 and Folio and for printing faxes: A4, Letter, Legal and Folio.

When you change the size of paper in the tray, you will also need to change the setting for paper size at the same time so your machine can fit the document or an incoming fax on the page.

- 1 Do one of the following:
 - To set the paper size for the MP Tray press **Menu, 1, 2, 2, 1**.
 - To set the paper size for Tray#1 press **Menu, 1, 2, 2, 2**.
 - To set the paper size for Tray#2 ¹ press **Menu, 1, 2, 2, 3**.
- ¹ Tray#2 Only or T2 appears only if the optional tray is installed. The optional tray is available for MFC-8380DN.

- 2 Press **▲** or **▼** to choose A4, Letter, Legal, Executive, A5, A5 L, A6, B5, B6, Folio or Any. Press **OK**.

- 3 Press **Stop/Exit**.



Note

- Legal, Folio and Any size appears only when you choose the MP tray.
- If you choose Any for the MP Tray Paper Size: You must choose MP Only for the Tray Use setting. You cannot use the Any Paper Size selection for the MP tray when making N in 1 copies. You must choose one of the other available Paper Size selections for the MP tray.
- A5 L and A6 size are not available for the optional Tray #2.
- If you chose Transparency for the Paper Type you will only be able to choose Letter, Legal, Folio or A4 size paper in step 2.

Tray Use in copy mode

You can change the priority tray that the machine will use for printing copies.

When you choose Tray#1 Only, MP Only or Tray#2 Only ¹, the machine pulls the paper only from that tray. If the selected tray is out of paper, No Paper will appear on the LCD. Insert the paper in the empty tray.

To change the tray setting follow the instructions below:

- 1 Press **Menu, 1, 6, 1**.
- 2 Press **▲** or **▼** to choose Tray#1 Only, Tray#2 Only ¹, MP Only, MP>T1>T2 ¹ or T1>T2 ¹>MP. Press **OK**.

¹ Tray#2 Only or T2 appears only if the optional tray is installed. The optional tray is available for MFC-8380DN.

- 3 Press **Stop/Exit**.



Note

- When loading the documents in the ADF and MP>T1>T2 or T1>T2>MP is selected, the machine looks for the tray with the most suitable paper and pulls paper from that tray. If no tray has suitable paper, the machine pulls paper from the higher priority tray.
- When using the scanner glass, your document is copied from the higher priority tray even if more suitable paper is in another paper tray.

Tray Use in fax mode

You can change the default tray that the machine will use for printing received faxes.

When you choose **Tray#1 Only**, **MP Only** or **Tray#2 Only**¹, the machine pulls the paper only from that tray. If the selected tray is out of paper, **No Paper** will appear on the LCD. Insert the paper in the empty tray.

When you choose **T1>T2**¹>**MP**, the machine pulls paper from **Tray #1** until it is empty, then from **Tray #2**, and then from the **MP** tray.

When you choose **MP>T1>T2**¹, the machine pulls paper from the **MP** tray until it is empty, then from **Tray #1**, and then from **Tray #2**.



Note

- You can use four sizes of paper for printing faxes: **A4**, **Letter**, **Legal**¹ or **Folio**¹. When a suitable size is not in any of the trays received faxes will be stored in the machine's memory and **Size mismatch** will appear on the LCD. (For details, see *Error and maintenance messages* on page 128.)
- If the tray is out of paper and received faxes are in the machine's memory, **No Paper** will appear on the LCD. Insert paper in the empty tray.

¹ You can choose **Legal** and **Folio** for **MP** Tray only.



Press **Menu, 1, 6, 2**.



Press **▲** or **▼** to choose **Tray#1 Only**, **Tray#2 Only**¹, **MP Only**, **MP>T1>T2**¹ or **T1>T2**¹>**MP**. Press **OK**.

¹ **Tray#2 Only** or **T2** appears only if the optional tray is installed. The optional tray is available for **MFC-8380DN**.



Press **Stop/Exit**.

Tray Use in print mode

You can change the default tray the machine will use for printing from your computer.



Press **Menu, 1, 6, 3**.



Press **▲** or **▼** to choose **Tray#1 Only**, **Tray#2 Only**¹, **MP Only**, **MP>T1>T2**¹ or **T1>T2**¹>**MP**. Press **OK**.

¹ **Tray#2 Only** or **T2** appears only if the optional tray is installed. The optional tray is available for **MFC-8380DN**.



Press **Stop/Exit**.



Note

- The setting in the printer driver will take priority over the setting made on the control panel.
- If the control panel is set to **Tray#1 Only**, **MP Only** or **Tray#2 Only**¹ and you choose **Auto Select** in the printer driver, the machine pulls the paper from that tray.

¹ **Tray#2 Only** appears only if the optional tray is installed. The optional tray is available for **MFC-8380DN**.

Volume settings

Ring volume

You can choose a ring volume level from a range of settings, from **High** to **Off**.

While in Fax mode press **⏪** or **⏩** to adjust the volume level. The LCD will show the current setting, and each key press will change the volume to the next level. The machine will keep the new setting until you change it.

You can also change the ring volume through the menu:

- 1 Press **Menu, 1, 3, 1**.
- 2 Press **▲** or **▼** to choose **Off, Low, Med** or **High**.
Press **OK**.
- 3 Press **Stop/Exit**.

Beeper volume

When the beeper is on, the machine will beep when you press a key, make a mistake, or after you send or receive a fax. You can choose a range of volume levels, from **High** to **Off**.

- 1 Press **Menu, 1, 3, 2**.
- 2 Press **▲** or **▼** to choose **Off, Low, Med** or **High**.
Press **OK**.
- 3 Press **Stop/Exit**.

Speaker volume

You can choose a range of speaker volume levels, from **High** to **Off**.

- 1 Press **Menu, 1, 3, 3**.
- 2 Press **▲** or **▼** to choose **Off, Low, Med** or **High**.
Press **OK**.
- 3 Press **Stop/Exit**.

Automatic daylight savings time

You can set the machine to change automatically for Daylight Savings Time. It will set itself forward one hour in the Spring, and back one hour in the Autumn.

- 1 Press **Menu**, **1**, **4**.
- 2 Press **▲** or **▼** to choose *On* or *Off*. Press **OK**.
- 3 Press **Stop/Exit**.

Ecology features

Toner Save

You can save toner using this feature. When you set Toner Save to *On*, prints appear lighter. The default setting is *Off*.

- 1 Press **Menu**, **1**, **5**, **1**.
- 2 Press **▲** or **▼** to choose *On* or *Off*. Press **OK**.
- 3 Press **Stop/Exit**.



Note

We do not recommend Toner Save for printing Photo or Greyscale images.

Sleep Time

The Sleep Time setting can reduce power consumption by turning off the fuser while the machine is idle.

You can choose how long the machine must be idle before it goes into sleep mode. When the machine receives a fax, computer data, or makes a copy, the timer will be reset. The default setting is 05 minutes.

While the machine is in sleep mode the LCD will display *Sleep*. When printing or copying in sleep mode, there will be a short delay while the fuser warms up.

- 1 Press **Menu**, **1**, **5**, **2**.
- 2 Enter the length of time the machine is idle before entering sleep mode. Press **OK**.
- 3 Press **Stop/Exit**.

LCD Contrast

You can change the contrast to make the LCD look lighter or darker.

- 1 Press **Menu**, **1**, **7**.
- 2 Press **▼** to make the LCD lighter. Or, press **▲** to make the LCD darker. Press **OK**.
- 3 Press **Stop/Exit**.

4

Security features

Secure Function Lock 2.0 (MFC-8380DN)

Secure Function Lock lets you restrict Public access to the following machine functions:

- PC Print ¹
- USB Direct Print
- Copy
- Fax Tx
- Fax Rx
- Scan
- Page Limit ²

¹ If you register the PC user login name by using Web Based Management, you can restrict PC print without the user entering a password. For more detail, see *Chapter 11* in the *Network User's Guide* on the CD-ROM.

² You can configure this feature from Web Based Management. See *Chapter 11* in the *Network User's Guide* on the CD-ROM.

This feature also prevents users from changing the Default settings of the machine by limiting access to the Menu settings.

Before using the security features you must first enter an administrator password.

Access to restricted operations can be enabled by creating a restricted user. Restricted users must enter a user password to use the machine.

Make a careful note of your password. If you forget it, you will have to reset the password stored in the machine. For more information about how to reset the password call your Brother dealer for service.



Note

- Secure Function Lock can be set manually at the control panel or by using Web Based Management. We recommend using Web Based Management to configure this feature. For more information, see the *Network User's Guide* on the CD-ROM.
- Only administrators can set limitations and make changes for each user.
- When Secure Function Lock is on, you can only use 1. Contrast or 7. Coverpg Setup in the Fax menu.
If Fax Tx is disabled, you cannot use any function in the Fax menu.
- Polling Receive is enabled only when both Fax Tx and Fax Rx are enabled.

Setting the password for the administrator

The password you set in these steps is for the administrator. This password is used to set up users and to turn Secure Function Lock on or off. (See *Setting up restricted users* on page 30 and *Turning Secure Function Lock on/off* on page 30.)

- 1 Press **Menu**, **1**, **8**, **1**.
- 2 Enter a four-digit number for the password using numbers 0-9. Press **OK**.
- 3 Re-enter the password when the LCD shows *Verify:.* Press **OK**.
- 4 Press **Stop/Exit**.

Changing the password for the administrator

- 1 Press **Menu**, **1**, **8**, **1**.
- 2 Press **▲** or **▼** to choose `Set Password`. Press **OK**.
- 3 Enter the registered four-digit password. Press **OK**.
- 4 Enter a four-digit number for the new password. Press **OK**.
- 5 If the LCD shows `Verify`: re-enter the new password. Press **OK**.
- 6 Press **Stop/Exit**.

Setting up the public user

Public user mode restricts the functions that are available for Public users. Public users do not need to enter a password to access features made available through this setting. You can set up one Public user.

- 1 Press **Menu**, **1**, **8**, **1**.
- 2 Press **▲** or **▼** to choose `Setup ID`. Press **OK**.
- 3 Enter the administrator password. Press **OK**.
- 4 Press **▲** or **▼** to choose `Public`. Press **OK**.
- 5 Press **▲** or **▼** to choose `On` or `Off` for `Fax Tx`. Press **OK**.
After you have set `Fax Tx`, repeat this step for `Fax Rx`, `Copy`, `Scan`, `USB Direct` and `PC Print`.
When you have finished changing settings press **◀** or **▶** to choose `Exit` and press **OK**.
- 6 Press **Stop/Exit**.

Setting up restricted users

You can set up users with restrictions and a password for functions that are available to them. You can set up more advanced restrictions, such as by page count or PC user login name, through Web Based Management. (For more information, see the *Network User's Guide* on the CD-ROM.) You can set up to 25 restricted users with restrictions and a password.

- 1 Press **Menu**, **1**, **8**, **1**.
- 2 Press **▲** or **▼** to choose `Setup ID`. Press **OK**.
- 3 Enter the administrator password. Press **OK**.
- 4 Press **▲** or **▼** to choose `User01`. Press **OK**.
- 5 Use the numeric keys to enter the user name. (See *Entering text* on page 174.) Press **OK**.
- 6 Enter a four-digit password for the user. Press **OK**.
- 7 Press **▲** or **▼** to choose `On` or `Off` for `Fax Tx`. Press **OK**.
After you have set `Fax Tx`, repeat this step for `Fax Rx`, `Copy`, `Scan`, `USB Direct` and `PC Print`.
When you have finished changing settings press **◀** or **▶** to choose `Exit` and press **OK**.
- 8 Repeat steps 4 to 7 for entering each additional user and password.
- 9 Press **Stop/Exit**.



Note

You cannot use the same name as another user's name.

Turning Secure Function Lock on/off

If you enter the wrong password, the LCD will show `Wrong Password`. Re-enter the correct password.

Turning Secure Function Lock on

- 1 Press **Menu**, **1**, **8**, **1**.
- 2 Press **▲** or **▼** to choose `Lock Off-On`. Press **OK**.
- 3 Enter your four-digit administrator password. Press **OK**.

Turning Secure Function Lock off

- 1 Press **Menu**, **1**, **8**, **1**.
- 2 Press **▲** or **▼** to choose `Lock On-Off`. Press **OK**.
- 3 Enter your four-digit administrator password. Press **OK**.

Switching Users

This setting allows you to switch between restricted users or Public mode when Secure Function Lock is turned on.

Changing to the restricted user Mode

- 1 Hold down **Shift** as you press **Secure**.
- 2 Press **▲** or **▼** to choose your name. Press **OK**.
- 3 Enter your four-digit password. Press **OK**.



Note

If you press a Mode key that is restricted, **Access Denied** will appear on the LCD and then the machine will ask your name. If you are a restricted user with access to this Mode, press **▲** or **▼** to choose your name and enter your four-digit password.

Changing to the Public Mode

After a restricted user has finished using the machine, it will return to the Public setting within the same time as the Mode Timer setting (**Menu, 1, 1**). (See *Mode Timer* on page 22.) You can also exit from the restricted user mode by pressing the current Mode key you are in. Then the LCD will ask you **Go to Public?** Press **1** to choose **Yes**. Press **OK**.

Memory security (MFC-8370DN)

Memory Security lets you prevent unauthorized access to the machine.

While Memory Security is on, the following operations are available:

- Receiving faxes into memory (limited by memory capacity)
- Fax Forwarding (if Fax Forwarding was already on)
- Remote Retrieval (if Fax Storage was already on)

While Memory Security is on, the following operations are NOT available:

- Printing received faxes
- Sending faxes
- Copying
- PC printing
- Scanning
- PC Fax Receive



Note

- To print the faxes in memory, turn off Memory Security.
- You must turn off PC Fax Receive before you can turn on Memory Security. (See *Turning off Remote Fax Options* on page 67)

Setting up the password



Note

- If you have already set the password, you will not need to set it, again.
- If you forget the Memory Security password, please call your Brother dealer.

- 1 Press **Menu**, **1**, **8**, **1**.
- 2 Enter a four-digit number for the password using number 0-9.
Press **OK**.
- 3 If the LCD shows `Verify:`, re-enter the new password.
Press **OK**.
- 4 Press **Stop/Exit**.

Changing the Memory Security password

- 1 Press **Menu**, **1**, **8**, **1**.
- 2 Press **▲** or **▼** to choose `Set Password`
Press **OK**.
- 3 Enter your four-digit password.
Press **OK**.
- 4 Enter a four-digit number for the new password.
Press **OK**.
- 5 If the LCD shows `Verify:`, re-enter the new password.
Press **OK**.
- 6 Press **Stop/Exit**.

Turning Memory Security on/off

If you enter the wrong password, when following the instruction below, the LCD will show `Wrong Password`. Re-enter the correct password.

Turning Memory Security on

- 1 Press **Menu**, **1**, **8**, **1**.
- 2 Press **▲** or **▼** to choose `Set Security`.
Press **OK**.
- 3 Enter the registered four-digit password.
Press **OK**.
The machine goes offline and the LCD shows `Secure Mode`.



Note

If there is a power failure the data will stay in memory for up to 4 days.

Turning Memory Security off

- 1 Press **Menu**.
Enter the registered four-digit password.
Press **OK**.
- 2 Memory Security is automatically turned off and the LCD shows the date and time.



Note

If you enter the wrong password, the LCD shows `Wrong Password` and stays offline. The machine will stay in `Secure Mode` until the registered password is entered.

Setting Lock

Setting Lock lets you set a password to stop other people from accidentally changing your machine settings.

Make a careful note of your password. If you forget it, you will have to reset the password stored in the machine. Please call your administrator or Brother dealer.

While Setting Lock is On, you cannot change the following settings without a password:

- Date/Time
- Station ID
- Address Book
- Mode Timer
- Paper Type
- Paper Size
- Volume
- Auto Daylight
- Ecology
- Tray Use
- LCD Contrast
- Document Scan
- Setting Lock
- Secure Function Lock (MFC-8380DN)
- Memory Security (MFC-8370DN)
- Dial Restriction

Setting up the password

- 1 Press **Menu**, **1**, **8**, **2**.
- 2 Enter a four-digit number for the password using numbers 0-9. Press **OK**.
- 3 Re-enter your password when the LCD shows *Verify:.* Press **OK**.
- 4 Press **Stop/Exit**.

Changing your Setting Lock password

- 1 Press **Menu**, **1**, **8**, **2**.
- 2 Press **▲** or **▼** to choose *Set Password*. Press **OK**.
- 3 Enter your four-digit password. Press **OK**.
- 4 Enter a four-digit number for the new password. Press **OK**.
- 5 Re-enter your new password when the LCD shows *Verify:.* Press **OK**.
- 6 Press **Stop/Exit**.

Turning Setting Lock on/off

If you enter the wrong password when following the instructions below, the LCD will show *Wrong Password*. Re-enter the correct password.

Turning Setting Lock on

- 1 Press **Menu**, **1**, **8**, **2**.
- 2 Press **▲** or **▼** to choose *On*. Press **OK**.
- 3 Enter your four-digit password. Press **OK**.
- 4 Press **Stop/Exit**.

Turning Setting Lock off

- 1 Press **Menu**, **1**, **8**, **2**.
- 2 Enter your four-digit password. Press **OK** twice.
- 3 Press **Stop/Exit**.

Restricting dialling

This feature is to prevent users from sending a fax or call to a wrong number by mistake. You can set the machine to restrict dialling by using the dial pad, One Touch and Speed Dial.

If you choose *Off*, the machine does not restrict the dialling method.

If you choose *Enter # twice*, the machine will prompt you to re-enter the number, and then if you re-enter the same number correctly, the machine will start dialling. If you re-enter the wrong number, the LCD will show an error message.

If you choose *On*, the machine will restrict all fax sending and outbound calls for that dialling method.

Dial pad restriction

- 1 Press **Menu**, **2**, **6**, **1**.
- 2 Press **▲** or **▼** to choose *Off*, *Enter # twice* or *On*. Press **OK**.
- 3 Press **Stop/Exit**.

One Touch restriction

- 1 Press **Menu, 2, 6, 2**.
- 2 Press ▲ or ▼ to choose **Off**,
Enter # twice or **On**.
Press **OK**.
- 3 Press **Stop/Exit**.

Speed Dial restriction

- 1 Press **Menu, 2, 6, 3**.
- 2 Press ▲ or ▼ to choose **Off**,
Enter # twice or **On**.
Press **OK**.
- 3 Press **Stop/Exit**.



Note

- The **Enter # twice** setting will not work if you lift an external phone or press **Tel/R** before entering the number.

You will not be asked to re-enter the number.

- If you choose **On** or **Enter # twice**, you cannot use the **Broadcasting** feature and cannot combine quick dial numbers when dialling.
-



Fax

Sending a fax	38
Receiving a fax	47
Telephone and external devices	53
Dialling and storing numbers	60
Remote Fax Options	65
Polling	71
Printing reports	74

5

Sending a fax

How to fax

Entering fax mode

To enter fax mode press  (Fax), and the key will glow blue.

Sending a single-sided fax from the ADF

Using the ADF to send your faxes is the easiest way. To cancel a fax in progress press **Stop/Exit**.

- 1 Make sure you are in Fax mode .
- 2 Unfold the ADF output tray and place your document *face down* in the ADF input tray.
- 3 Dial the fax number. (See *How to dial* on page 60.)
- 4 Press **Start**.
The machine scans the pages into memory and then sends the document.



Note

If the **Out of Memory** message appears while scanning a document into memory, press **Stop/Exit** to cancel or **Start** to send the scanned pages.

Sending a 2-sided fax from the ADF (MFC-8380DN)

You can send a 2-sided document from the ADF. To cancel a fax in progress press **Stop/Exit**.

- 1 Make sure you are in Fax mode .
- 2 Unfold the ADF output tray and place your document *face down* in the ADF input tray.
- 3 Press **Duplex**.
The display will show **Duplex Scan On**.
- 4 Dial the fax number. (See *How to dial* on page 60.)
- 5 Press **Start**.

The machine will now scan and send your document.





Note

Legal size 2-sided documents cannot be faxed from the ADF.



Changing a 2-sided fax layout

You need to choose the duplex scanning format before you send a fax. The format you choose will depend on the layout of your 2-sided document.

- 1 Press **Menu**, **1**, **9**, **3**.
- 2 Do one of the following:
 - If your document is flipped on the Long edge, press **▲** or **▼** to choose Long edge.
Press **OK**.

Long edge	
Portrait	Landscape
	

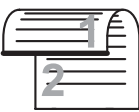
- If your document is flipped on the Short edge, press **▲** or **▼** to choose Short edge.
Press **OK**.

Short edge	
Portrait	Landscape
	

- 3 Press **Stop/Exit**.

Sending a fax from the scanner glass

You can use the scanner glass to fax the pages of a book, or a single page at a time. The documents can be Letter or A4 size. Press **Stop/Exit** to cancel a fax in progress.

- 1 Make sure you are in Fax mode .
- 2 Place your document *face down* on the scanner glass.
- 3 Dial the fax number. (See *How to dial* on page 60.)
- 4 Press **Start**.
The machine starts scanning the first page.
- 5 After the machine scans the page, the LCD will prompt you to choose one of the options below:

```
Next Page?
1.Yes 2.No(Send)
```

- Press **1** to send another page.
Go to step 6.
 - Press **2** or **Start** to send the document. Go to step 7.
- 6 Place the next page on the scanner glass, press **OK**. Repeat steps 5 and 6 for each additional page.

```
Set Next Page
Then Press OK
```

- 7 Your machine will automatically send the fax.



Note

When faxing multiple pages from the scanner glass, real time transmission should be set to **OFF**. (See *Real Time Transmission* on page 44.)

Faxing Letter size documents from the scanner glass

When faxing Letter size documents, you need to set the scan glass size to `Letter` otherwise a portion of your faxes will be missing.

- 1 Make sure you are in Fax mode .
- 2 Press **Menu**, **1**, **9**, **1**.
- 3 Press **▲** or **▼** to choose `Letter`. Press **OK**.
- 4 Press **Stop/Exit**.

Cancelling a fax in progress

Press **Stop/Exit** to cancel the fax. If you press **Stop/Exit** while the machine is dialling or sending, the LCD will ask you to choose 1. `Clear` or 2. `Exit`.

Press **1** to cancel the fax.

Broadcasting

Broadcasting lets you send the same fax message to more than one fax number. You can include Groups, One Touch, Speed Dial numbers and up to 50 manually dialled numbers in the same broadcast.

You can broadcast up to 366 different numbers. This will depend on how many groups, access codes or credit card numbers you have stored, and on how many delayed or stored faxes in memory.



Note

Use  to help you choose numbers easily.

- 1 Make sure you are in Fax mode .
- 2 Load your document.
- 3 Enter a number.
Press **OK**.
You can use either a One Touch, Speed Dial, a Group number, or a number manually entered using the dial pad. (See *How to dial* on page 60.)
- 4 Repeat step 3 until you have entered all the fax numbers you want to broadcast to.
- 5 Press **Start**.

After the broadcast is finished the machine will print a broadcast report to let you know the results.



Note

The scan profile of the One-Touch, Speed-Dial or Group number you chose first will be applied to the broadcast.

Cancelling a Broadcast in progress

While broadcasting you can cancel the fax currently being sent or the whole broadcast job.

- 1 Press **Menu**, **2**, **7**.
The LCD will display the Broadcast job number followed by the fax number being dialled (for example, #001 0123456789) and the broadcast job numbers (for example, Broadcast#001).
- 2 Press **▲** or **▼** to choose to cancel the fax being sent or the Broadcast job number. Press **OK**.
- 3 Press **1** to clear the job number or **2** to exit.
If you chose to only cancel the fax currently being sent in step 2, the machine will ask you if you want to cancel the broadcast. Press **1** to clear the whole broadcast job or **2** to exit.
- 4 Press **Stop/Exit**.

Additional sending operations

Sending faxes using multiple settings

Before you send a fax, you can change any combination of these settings: Contrast, Resolution, Overseas mode, Delayed fax timer, Polling transmission, Real time transmission or Cover page settings.

- 1 Make sure you are in Fax mode . After each setting is accepted, the LCD asks if you want to enter more settings.

Next
1.Yes 2.No

- 2 Do one of the following:
 - To choose more settings, press **1**.
The LCD returns to the **Setup Send** menu so you can choose another setting.
 - If you have finished choosing settings, press **2** and go to the next step for sending your fax.

Electronic cover page

This feature will *not* work unless you have already programmed your Station ID. (See the *Quick Setup Guide*.)

You can automatically send a cover page with every fax. Your cover page includes your Station ID, a comment, and the name (or number) stored in the One Touch or Speed Dial memory.

By choosing `Next Fax:On` you can also display the number of pages on the cover page.

You can choose one of the following preset comments.

1. `Comment Off`
2. `Please Call`
3. `Urgent`
4. `Confidential`

Instead of using one of the preset comments, you can enter two personal messages of your own, up to 27 characters long. Use the chart on page 174 for help entering characters.

(See *Composing your own comments* on page 42.)

5. (User Defined)
6. (User Defined)

Composing your own comments

You can set up two comments of your own.

- 1 Make sure you are in Fax mode .
- 2 Press **Menu, 2, 2, 8**.
- 3 Press **▲** or **▼** to choose 5 or 6 to store your own comment. Press **OK**.
- 4 Enter your own comment using the dial pad. Press **OK**.

Use the chart on page 174 for help entering characters.

Send a cover page for the next fax

If you want to send a cover page only for the next fax, your machine will ask you to enter the number of pages you are sending so it can be printed on the cover page.

- 1 Make sure you are in Fax mode .
- 2 Load your document.
- 3 Press **Menu, 2, 2, 7**.
- 4 Press **▲** or **▼** to choose `Next Fax:On` (or `Next Fax:Off`). Press **OK**.
- 5 Press **▲** or **▼** to choose a comment. Press **OK**.
- 6 Enter two digits to show the number of pages you are sending. Press **OK**.
For example, enter **0, 2** for 2 pages or **0, 0** to leave the number of pages blank. If you make a mistake, press **◀** or **Clear/Back** to back up and re-enter the number of pages.

Send a cover page for all faxes

You can set the machine to send a cover page whenever you send a fax.

- 1 Make sure you are in Fax mode .
- 2 Press **Menu, 2, 2, 7**.
- 3 Press **▲** or **▼** to choose `On` (or `Off`). Press **OK**.
- 4 Press **▲** or **▼** to choose a comment. Press **OK**.

Using a printed cover page

If you want to use a printed cover page that you can write on, you can print the sample page and attach it to your fax.

- 1 Make sure you are in Fax mode .
- 2 Press **Menu, 2, 2, 7**.
- 3 Press **▲** or **▼** to choose **Print Sample**. Press **OK**.
- 4 Press **Start**.
- 5 After the machine prints a copy of your cover page, press **Stop/Exit**.

Contrast

For most documents the default setting of **Auto** will give the best results. It automatically chooses the suitable contrast for your document.

If your document is very light or dark, changing the contrast may improve the quality of the fax.

Use **Dark** to make the faxed document lighter.

Use **Light** to make the faxed document darker.

- 1 Make sure you are in Fax mode .
- 2 Load your document.
- 3 Press **Menu, 2, 2, 1**.
- 4 Press **▲** or **▼** to choose **Auto, Light** or **Dark**. Press **OK**.



Note

Even if you choose **Light** or **Dark**, the machine will send the fax using the **Auto** setting if you choose **Photo** as the Fax Resolution.

Changing Fax Resolution

The quality of a fax can be improved by changing the Fax Resolution. Resolution can be changed for the next fax or for all faxes.

To change the Fax Resolution setting for the *next* fax

- 1 Make sure you are in Fax mode .
- 2 Load your document.
- 3 Press **Resolution**, then **▲** or **▼** to choose the resolution. Press **OK**.

To change the default Fax Resolution setting

- 1 Make sure you are in Fax mode .
- 2 Press **Menu, 2, 2, 2**.
- 3 Press **▲** or **▼** to choose the resolution you want. Press **OK**.



Note

You can choose four different resolution settings.

Standard: Suitable for most typed documents.

Fine: Good for small print and transmits a little slower than **Standard** resolution.

S.Fine: Good for small print or artwork and transmits slower than **Fine** resolution.

Photo: Use when the document has varying shades of grey or is a photograph. This has the slowest transmission time.

Dual access

You can dial a number, and start scanning the fax into memory—even when the machine is sending from memory, receiving faxes or printing PC data. The LCD will show the new job number.

The number of pages you can scan into the memory will vary depending on the data that is printed on them.



Note

If you get an *Out of Memory* message while scanning the first page of a fax, press **Stop/Exit** to cancel scanning. If you get an *Out of Memory* message while scanning a subsequent page, you can press **Start** to send the pages scanned so far, or press **Stop/Exit** to cancel the operation.

Real Time Transmission

When you are sending a fax, the machine will scan the documents into the memory before sending. Then, as soon as the telephone line is free, the machine will start dialling and sending.

If the memory is full, the machine will send the document in real time (even if *Real Time TX* is set to *Off*).

Sometimes, you may want to send an important document immediately, without waiting for memory transmission. You can set *Real Time TX* to *On* for all documents or *Next Fax:On* for the next fax only.



Note

In Real Time Transmission, the automatic redial feature does not work when using the scanner glass.

Sending in real time for all faxes

- 1 Make sure you are in Fax mode .
- 2 Press **Menu, 2, 2, 5**.
- 3 Press **▲** or **▼** to choose *On*. Press **OK**.

Sending in real time for the next fax only

- 1 Make sure you are in Fax mode .
- 2 Press **Menu, 2, 2, 5**.
- 3 Press **▲** or **▼** to choose *Next Fax:On*. Press **OK**.

Not sending in real time for the next fax only

- 1 Make sure you are in Fax mode .
- 2 Press **Menu, 2, 2, 5**.
- 3 Press **▲** or **▼** to choose *Next Fax:Off*. Press **OK**.

Overseas Mode

If you are having difficulty sending a fax overseas due to a bad connection, then turning on Overseas Mode may help.

This is a temporary setting, and will only be active for your next fax.

- 1 Make sure you are in Fax mode .
- 2 Load your document.
- 3 Press **Menu, 2, 2, 9**.
- 4 Press **▲** or **▼** to choose *On* or *Off*. Press **OK**.

Delayed Fax

You can store up to 50 faxes in the memory to be sent within a twenty four hour period.

- 1 Make sure you are in Fax mode .
- 2 Load your document.
- 3 Press **Menu, 2, 2, 3**.
- 4 Enter the time you want the fax to be sent (in 24-hour format).
(For example, enter 19:45 for 7:45 PM)
Press **OK**.



Note

The number of pages you can scan into the memory depends on the amount of data printed on each page.

Delayed batch transmission

Before sending the delayed faxes, your machine will help you economize by sorting all the faxes in the memory by destination and scheduled time.

All delayed faxes that are scheduled to be sent at the same time to the same fax number will be sent as one fax to save transmission time.

- 1 Make sure you are in Fax mode .
- 2 Press **Menu, 2, 2, 4**.
- 3 Press **▲** or **▼** to choose **On** or **Off**.
Press **OK**.
- 4 Press **Stop/Exit**.

Checking and cancelling waiting jobs

Check which jobs are still waiting in the memory to be sent. If there are no jobs, the LCD will show **No Jobs Waiting**. You can cancel a fax job that is stored and waiting in the memory.

- 1 Press **Menu, 2, 7**.
The number of jobs still to be sent will be displayed.
- 2 Do one of the following:
 - Press **▲** or **▼** to scroll though the waiting jobs, press **OK** to choose a job, and then press **1** to cancel it.
 - Press **2** to exit without cancelling.
- 3 When you have finished, press **Stop/Exit**.

Sending a fax manually

Manual transmission

Manual transmission lets you hear the dialling, ringing and fax-receiving tones while sending a fax.

- 1 Make sure you are in Fax mode .
- 2 Load your document.
- 3 Pick up the handset of an external telephone and listen for a dial tone.
- 4 Dial the fax number you want to call.
- 5 When you hear the fax tone, press **Start**.
 - If you are using the scanner glass, press **1** to send a fax.
- 6 Replace the handset.

Out of memory message

If you get an **Out of Memory** message while scanning the first page of a fax, press **Stop/Exit** to cancel the fax.

If you get an **Out of Memory** message while scanning a subsequent page, you will have the option to press **Start** to send the pages scanned so far, or to press **Stop/Exit** to cancel the operation.



Note

If you get an **Out of Memory** message while faxing and you do not want to delete your stored faxes to clear the memory, you can send the fax in real time. (See *Real Time Transmission* on page 44.)

Maximum ADF output tray capacity

If the maximum capacity of the output tray is reached during use, the machine will stop scanning and the LCD will show **20 Sheet Limit**.

Do one of the following:

- To send the pages scanned so far, press **1.Send**.
- To delete the scanned pages, press **2.Delete**.

If you send the pages already scanned and want to send the remaining pages, remove the scanned sheets from the ADF output tray, then dial the fax number and press **Start**.

Receive modes

You must choose a receive mode depending on the external devices and telephone services you have on your line. The diagrams below will help you choose the correct mode. (For more detailed information about the receive modes, see *Using receive modes* on page 48.)

Choosing the Receive Mode

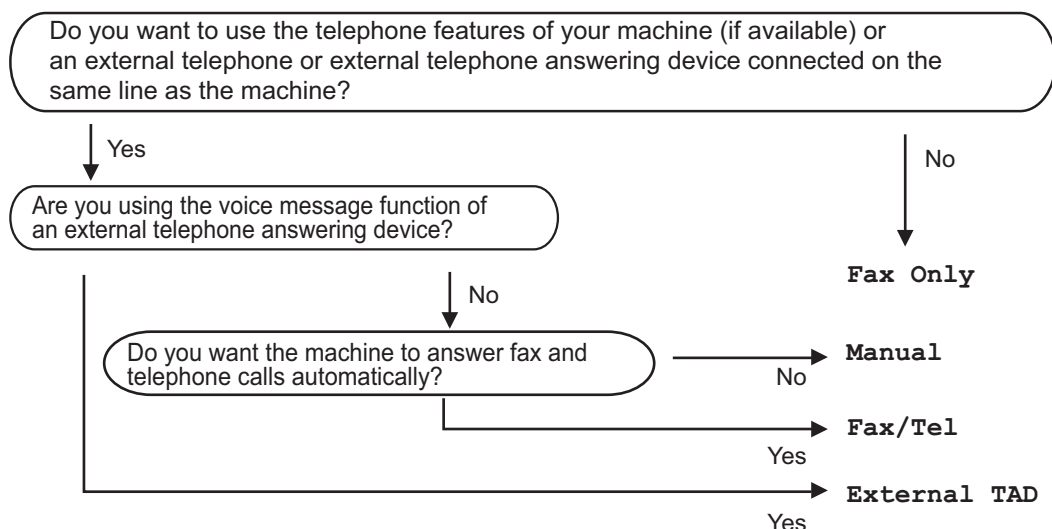

To set the receive mode follow the instructions below.

- 1 Press **Menu, 0, 1**.
- 2 Press **▲** or **▼** to choose the receive mode.
Press **OK**.
- 3 Press **Stop/Exit**.

The LCD will display the current receive mode.

Using receive modes

Some receive modes answer automatically (`Fax Only` and `Fax/Tel`). You may want to change the *Ring Delay* before using these modes. (See *Ring Delay* on page 49.)

Fax Only

`Fax Only` mode will automatically answer every call as a fax.

Fax/Tel

`Fax/Tel` mode helps you automatically manage incoming calls, by recognising whether they are fax or voice calls and dealing with them in one of the following ways:

- Faxes will be automatically received.
- Voice calls will start the *F/T* ring to tell you to pick up the line. The *F/T* ring is a fast double ring made by your machine.

(Also see *F/T Ring Time (Fax/Tel mode only)* on page 49 and *Ring Delay* on page 49.)

Manual

`Manual` mode turns off all automatic answering functions unless you are using the *BT Call Sign*¹ feature.

¹ *BT Call Sign* is for U.K. only.

To receive a fax in `Manual` mode lift the handset of the external telephone. When you hear fax tones (short repeating beeps), press **Start**, and then press **2** to receive a fax. You can also use the *Fax Detect* feature to receive faxes by lifting a handset on the same line as the machine.

(Also see *Fax Detect* on page 50.)

External TAD

`External TAD` mode lets an external answering device manage your incoming calls. Incoming calls will be dealt with in the following ways:

- Faxes will be automatically received.
- Voice callers can record a message on the external TAD.

(For more information see *Connecting an external TAD* on page 54.)

Receive Mode settings

Ring Delay

The Ring Delay setting sets the number of times the machine rings before it answers in Fax Only and Fax/Tel modes.

If you have external or extension telephones on the same line as the machine, choose the maximum number of rings. (See *Operating from external and extension telephones* on page 57 and *Fax Detect* on page 50.)

- 1 Make sure you are in Fax mode .
- 2 Press **Menu, 2, 1, 1**.
- 3 Press **▲** or **▼** to choose how many times the line rings before the machine answers.
Press **OK**.
- 4 Press **Stop/Exit**.

F/T Ring Time (Fax/Tel mode only)

When somebody calls your machine, you and your caller will hear the normal telephone ring sound. The number of rings is set by the Ring Delay setting.

If the call is a fax, then your machine will receive it; however, if it is a voice call the machine will sound the F/T ring (a fast double-ring) for the time you have set in the F/T Ring Time setting. If you hear the F/T ring it means that you have a voice caller on the line.

Because the F/T ring is made by the machine, extension and external telephones will *not* ring; however, you can still answer the call on any telephone. (For more information see *Using Remote Codes* on page 59.)

- 1 Make sure you are in Fax mode .
- 2 Press **Menu, 2, 1, 2**.
- 3 Press **▲** or **▼** to choose how long the machine will ring to alert you that you have a voice call (20, 30, 40 or 70 seconds).
Press **OK**.
- 4 Press **Stop/Exit**.

Fax Detect

If Fax Detect is On:

The machine can receive a fax automatically, even if you answer the call. When you see *Receiving* on the LCD or hear a click on the phone line through the handset you are using, just replace the handset. Your machine will do the rest.

If Fax Detect is Off:

If you are at the machine and answer a fax call by lifting an external handset, press **Start**, then press **2** to receive the fax.

If you answered at an extension telephone, press ***51**. (See *Operating from external and extension telephones* on page 57)



Note

- If this feature is set to **On**, but your machine does not connect a fax call when you lift an extension or external telephone handset, press the remote activation code ***51**.
- If you send faxes from a computer on the same telephone line and the machine intercepts them, set Fax Detect to **Off**.

- 1 Make sure you are in Fax mode .
- 2 Press **Menu, 2, 1, 3**.
- 3 Press **▲** or **▼** to choose **On** or **Off**. Press **OK**.
- 4 Press **Stop/Exit**.

Setting the Print Density

You can adjust the Print Density setting to make your printed pages darker or lighter.

- 1 Make sure you are in Fax mode .
- 2 Press **Menu, 2, 1, 7**.
- 3 Press **▲** to make the print darker. Or, press **▼** to make the print lighter. Press **OK**.
- 4 Press **Stop/Exit**.

Additional receiving operations

Printing a reduced incoming fax

If you choose **On**, the machine automatically reduces each page of an incoming fax to fit on one page of A4, Letter, Legal¹ or Folio¹ size paper.

¹ You can choose Legal and Folio for MP Tray only.

The machine calculates the reduction ratio by using the page size of the fax and your Paper Size setting (**Menu, 1, 2, 2**).

- 1 Make sure you are in Fax mode .
- 2 Press **Menu, 2, 1, 5**.
- 3 Press **▲** or **▼** to choose **On** or **Off**. Press **OK**.
- 4 Press **Stop/Exit**.

Duplex (2-sided) printing for Fax mode

Your machine can automatically print received faxes onto both sides of the paper when **Duplex** is set to **On**.

You can use A4 size of paper (60 to 105 g/m²) for this function.

- 1 Make sure you are in Fax mode .
- 2 Press **Menu, 2, 1, 0**.
- 3 Press **▲** or **▼** to choose **On** (or **Off**). Press **OK**.
- 4 Press **Stop/Exit**.



Note

When you turn on Duplex the Auto Reduction feature is also turned on.

6

Setting the Fax Receive Stamp

You can set the machine to print the received date and time in the top centre of each received fax page.

- 1 Make sure you are in Fax mode .
- 2 Press **Menu, 2, 1, 9**.
- 3 Press **▲** or **▼** to choose **On** or **Off**. Press **OK**.
- 4 Press **Stop/Exit**.



Note

Make sure you have set the current date and time in the machine.

Receiving faxes into memory

As soon as the paper tray becomes empty during fax reception, the screen will display **No Paper**, asking you to put paper in the paper tray. (See *Loading paper and print media* on page 10.) If you are unable to put paper in the paper tray the following will happen:

If Memory Receive is On:

The machine will carry on receiving the fax, with the remaining pages being stored in memory, if enough memory is available. Further incoming faxes will also be stored into memory until the memory is full. When the memory is full the machine will stop automatically answering calls. To print the faxes, put fresh paper in the tray.

If Memory Receive is Off:

The machine will carry on receiving the fax, with the remaining pages being stored in memory, if enough memory is available. The machine will then stop automatically answering calls until fresh paper is put in the paper tray. To print the last fax you received, put fresh paper in the tray.

- 1 Make sure you are in Fax mode .
- 2 Press **Menu, 2, 1, 6**.
- 3 Press **▲** or **▼** to choose **On** or **Off**. Press **OK**.
- 4 Press **Stop/Exit**.

Printing a fax from the memory

If you are using the Fax Storage feature (**Menu, 2, 5, 1**), you can still print a fax from the memory when you are at your machine. (See *Fax Storage* on page 65.)

- 1 Press **Menu, 2, 5, 3**.
- 2 Press **Start**.
- 3 Press **Stop/Exit**.

Out of Paper Reception

As soon as the paper tray becomes empty during fax reception, the LCD shows **No Paper**. Put some paper in the paper tray. (See *Loading paper and print media* on page 10.)

The machine will carry on receiving the fax, with the remaining pages being stored in memory, if enough memory is available.

Further incoming faxes will also be stored in to memory until the memory is full. When the memory is full the machine will stop automatically answering calls. To print the faxes, put fresh paper in the tray.

Telephone line services

Setting the telephone line type

If you are connecting the machine to a line that features a PBX or ISDN to send and receive faxes, it is necessary to change the Telephone Line Type accordingly by completing the following steps. If you are using a line that features a PBX, you can also set your machine to gain access to an outside line always or not.

- 1 Press **Menu**, **0**, **6**.
- 2 Press **▲** or **▼** to choose **ISDN**, **PBX** (or **Normal**). Press **OK**.
- 3 Do one of the following:
 - If you chose **ISDN** or **Normal**, go to step 6.
 - If you chose **PBX**, go to step 4.
- 4 Do one of the following:
 - If you want to change the current prefix number, press **1** and go to step 5.
 - If you do not want to change the current prefix number, press **2** and go to step 6.
- 5 Enter the prefix number (up to 5 digits) on the dial pad. Press **OK**. Press **▲** or **▼** to choose **On** or **Always**. Press **OK**.



Note

- You can use the numbers 0 to 9, #, * and !.
(Press **Tel/R** to display “!”.)
- If you choose **On**, pressing **Tel/R** (the screen displays “!”.) will let you access an outside line.
- If you choose **Always**, you can access an outside line without pressing **Tel/R**.

- 6 Press **Stop/Exit**.

PBX and TRANSFER

The machine is initially set to **Normal**, which lets the machine connect to a standard PSTN (Public Switched Telephone Network) line. However, many offices use a central telephone system or Private Branch Exchange (PBX). Your machine can be connected to most types of PBX. The machine's recall feature supports timed break recall only (TBR). TBR will work with most PBX systems allowing you to gain access to an outside line, or transfer calls to another extension. The feature works when **Tel/R** is pressed.

BT Call Sign (U.K. only)

The BT Call Sign subscriber service is a way to have a separate number for your machine, it allows you to have at least two separate telephone numbers on one phone line. Each phone number has its own distinctive ringing pattern.

You can set up your machine so that it only responds to the second number.

When you set the BT Call Sign feature to ON, the receive mode is set to `Manual` automatically. `Manual` mode will not respond to incoming telephone calls, since the number you use for telephone calls will use the normal ring pattern. If you turn the feature off, your receive mode will remain on `Manual`.

To enable the machine to work with BT Call Sign

This feature will only work with your external phone.

- 1 Press **Menu, 2, 0, 2**.
The screen displays the current setting.
- 2 Press **▲** or **▼** to choose `On` or `Off`.
Press **OK**.
- 3 Press **Stop/Exit**.

Connecting an external TAD

You can connect an external Telephone Answering Device (TAD) to the same line as your machine. When the TAD answers a call, your machine will “listen” for the CNG (fax calling) tones sent by a sending fax machine. If it hears them it will take over the call and receive the fax. If it does not hear them, it will let your TAD take a voice message and the display will show `Telephone`.

The external TAD must answer within four rings (we recommend you set it to two rings). This is because your machine cannot hear the CNG tones until the external TAD has picked up the call. The sending machine will send CNG tones for only eight to ten seconds longer. We do not recommend using the toll saver feature on your external TAD if it needs more than four rings to activate it.



Note

If you have problems receiving faxes, reduce the ring delay setting on your external TAD.

Connections

The external TAD must be connected as shown in the illustration below.

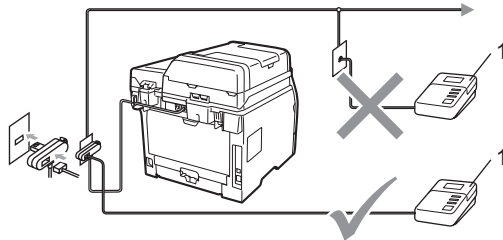

1 TAD

- 1 Set your external TAD to one or two rings. (The machine's Ring Delay setting does not apply.)
- 2 Record the outgoing message on your external TAD.
- 3 Set the TAD to answer calls.
- 4 Set the Receive Mode to *External TAD*. (See *Choosing the Receive Mode* on page 47.)

Recording an outgoing message (OGM)

- 1 Record 5 seconds of silence at the beginning of your message. This allows your machine time to listen for fax tones.
- 2 Limit your speaking to 20 seconds.
- 3 End your 20-second message by giving your Remote Activation code for people sending manual faxes. For example: "After the beep, leave a message or send a fax by pressing *51 and Start."



Note

- You need to turn the Remote Codes setting to on to use the Fax Receive Code *51. (See *Using Remote Codes* on page 59.)
- We recommend beginning your OGM with an initial 5 second silence because the machine cannot hear fax tones over a loud voice. You may try leaving out this pause, but if your machine has trouble receiving, then you should re-record the OGM to include it.

Multi-line connections (PBX)

We suggest you ask the company who installed your PBX to connect your machine. If you have a multi line system we suggest you ask the installer to connect the unit to the last line on the system. This prevents the machine being activated each time the system receives telephone calls. If all incoming calls will be answered by a switchboard operator we recommend that you set the Receive Mode to `Manual`.

We cannot guarantee that your machine will operate properly under all circumstances when connected to a PBX. Any difficulties with sending or receiving faxes should be reported first to the company who handles your PBX.

External and extension telephones



Note

You need to turn the Remote Codes setting to on to use the Remote Activation Code *51 and Remote Deactivation Code #51. (See *Using Remote Codes* on page 59.)

Operating from external and extension telephones

If you answer a fax call at an extension telephone, or an external telephone that is correctly connected to the machine into the correct socket on the machine, you can make your machine take the call by using the Remote Activation code. When you press the Remote Activation code *51 the machine starts to receive the fax.

If you answer a call and no one is on the line:

You should assume that you're receiving a manual fax.

Press *51 and wait for the chirp or until the LCD shows *Receiving*, and then hang up.



Note

You can also use the Fax Detect feature to make your machine take the call. (See *Fax Detect* on page 50.)

For Fax/Tel mode only

When the machine is in Fax/Tel mode, it will use the F/T Ring Time (pseudo/double-ringing) to alert you to pick up a voice call.

Lift the external telephone's handset, and then press **Tel/R** to answer.

If you are at an extension telephone, you will need to lift the handset during the F/T Ring Time and then press **#51** between the pseudo/double rings. If no one is on the line, or if someone wants to send you a fax, send the call back to the machine by pressing *51.

Connecting an external or extension telephone

You can connect a separate telephone directly to your machine as shown in the diagram below.

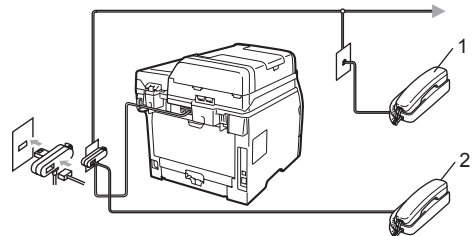

1 Extension telephone

2 External telephone

When you are using an external telephone, the LCD shows *Telephone*.

Using extension telephones (U.K. only)

Your premises may already be wired with parallel extension telephones (those connected to sockets in other rooms in the building), or perhaps you intend to add extension telephones to your line. While the simplest arrangement is a parallel connection, there are some reasons why this arrangement may cause problems.

The most common problem, is someone picking up an extension telephone while the machine is trying to send a fax.

Such problems can easily be eliminated, if you arrange modification of your extension wiring circuit, such that extension devices are connected “downstream” of your machine, in a master/slave configuration (see *figure 2*). In such a configuration, this machine can always detect whether a telephone is in use, so it will not attempt to seize the line during that time. This is known as “telephone off-hook detection”.

The inadvisable configuration is shown in *figure 1*, and the recommended master/slave configuration is shown in *figure 2*.

This new connection configuration can be arranged by contacting BT, Kingston upon Hull Telecommunications, your PBX maintainer or a qualified telephone installation company as appropriate. Simply explained, the extension telephone circuit should be terminated on a normal modular plug (BT 431A style), which in turn should be inserted into the modular socket of the white “T”-shaped connector provided as part of the line cord assembly.

Figure 1:

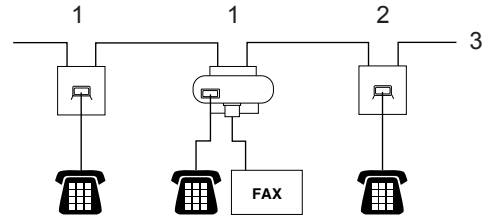

- 1 Extension socket
- 2 Master socket
- 3 Incoming line

Figure 2: Recommended connection of extension sockets

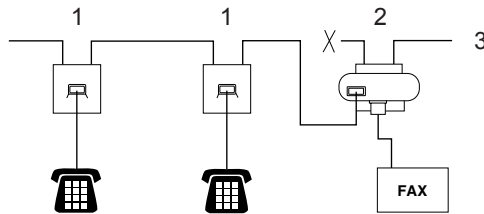

- 1 Extension socket
- 2 Master socket
- 3 Incoming line

These phones are now connected as *external devices* as shown on page 57, because they are connected to the fax machine via the T-connector.

Using a non-Brother cordless external handset

If your non-Brother cordless telephone is connected to the telephone line cord (see page 57) and you typically carry the cordless handset elsewhere, it is easier to answer calls during the Ring Delay.

If you let the machine answer first, you will have to go to the machine so you can press **Tel/R** to transfer the call to the cordless handset.

Using Remote Codes

Remote Activation Code

If you answer a fax call on an extension or external telephone, you can tell your machine to receive it by pressing the Remote Activation Code ***51**. Wait for the chirping sounds then replace the handset. (See *Fax Detect* on page 50.) Your caller will have to press start to send the fax.

If you answer a fax call at the external telephone, you can make the machine receive the fax by pressing **Start** and choosing *Receive*.

Remote Deactivation Code

If you receive a voice call and the machine is in F/T mode, it will start to sound the F/T (double-ring) after the initial ring delay. If you pick up the call on an extension telephone you can turn the F/T ring off by pressing **#51** (make sure you press this *between* the rings).

If the machine answers a voice call and pseudo/double-rings for you to take over, you can take the call at the external telephone by pressing **Tel/R**.

Turning on the Remote Codes

You need to turn the Remote Codes setting to on to use the Fax Receive Code and Telephone Answer Code.

- 1 Make sure you are in Fax mode .
- 2 Press **Menu, 2, 1, 4**.
- 3 Press **▲** or **▼** to choose *On*. Press **OK**.
- 4 If you do not want to change the Fax Receive Code, press **OK**.
- 5 If you do not want to change the Telephone Answer Code, press **OK**.
- 6 Press **Stop/Exit**.

Changing the Remote Codes

The preset Remote Activation Code is ***51**. The preset Remote Deactivation Code is **#51**. If you are always disconnected when accessing your External TAD, try changing the three-digit remote codes, for example **###** and 555.

- 1 Make sure you are in Fax mode .
- 2 Press **Menu, 2, 1, 4**.
- 3 Press **▲** or **▼** to choose *On* or *Off*. Press **OK**.
- 4 If you chose *On* in step 3, enter the new Remote Activation Code. Press **OK**.
- 5 Enter the new Remote Deactivation Code. Press **OK**.
- 6 Press **Stop/Exit**.

8

Dialling and storing numbers

How to dial

You can dial in any of the following ways.

Manual dialling

Use the dial pad to enter all the digits of the telephone or fax number.



One touch Dialling

Press the One Touch key that stores the number you want to call. (See *Storing One Touch Dial numbers* on page 61.)

To dial One Touch numbers 9 to 16, hold down **Shift** as you press the One Touch key.

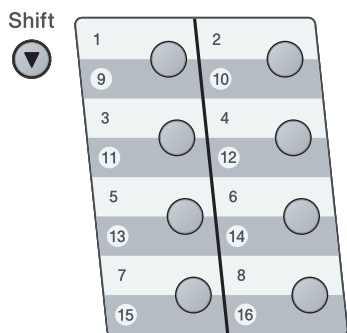

Speed dialling

Press  and then the three digit Speed Dial number. (See *Storing Speed Dial numbers* on page 62.)



Note

If the LCD shows *Register Now?* when you enter a One Touch or a Speed Dial number, it means that a number is not stored there.

Search

You can search alphabetically for names you have stored in the One Touch and Speed Dial memories. (See *Storing One Touch Dial numbers* on page 61 and *Storing Speed Dial numbers* on page 62.)

- 1 Press  twice.
- 2 Press the dial pad keys for the first few letters of the name. (Use the chart on *Entering text* on page 174 to help you enter letters.) Press **OK**.
- 3 Press **▲** or **▼** to scroll until you find the name you are looking for. Press **OK**.
- 4 Press **Start**.



Note

- If you do not enter a letter and press **OK** in step 2, all registered names will appear. Press **▲** or **▼** to scroll until you find the name you are looking for.
- If the LCD shows `No Contact Found` when you enter the first few letters of the name, it means that a name for the letter is not stored.

Fax redial

If you are sending a fax automatically and the line is busy, the machine will automatically redial up to three times at five minute intervals.

If you are sending a fax manually and the line is busy, press **Redial/Pause**, wait for the other fax machine to answer, and then press **Start** to try again. If you want to make a second call to the last number dialled, you can save time by pressing **Redial/Pause** and **Start**.

Redial/Pause only works if you dialled from the control panel.

Storing numbers

You can set up your machine to do the following types of easy dialling: One Touch, Speed Dial and Groups for Broadcasting faxes. You can also specify the default resolution for each One Touch and Speed Dial number. When you dial a quick dial number, the LCD shows the name, if you stored it, or the number. A scan profile can also be stored along with the fax number.

If you lose electrical power, the quick dial numbers stored in the memory will not be lost.

Storing a pause

Press **Redial/Pause** to insert a 2.8-second pause between numbers. You can press **Redial/Pause** as many times as needed to increase the length of the pause.

Storing One Touch Dial numbers

Your machine has 8 One Touch keys where you can store 16 fax or telephone numbers for automatic dialling. To access numbers 9 to 16, hold down **Shift** as you press the One Touch key.

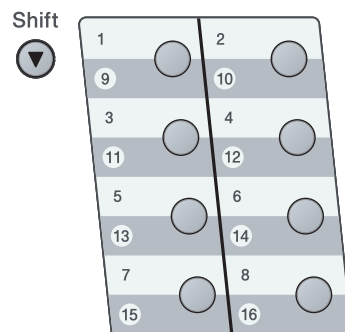

- 1 Press the One Touch key where you want to store the number. If a number is not stored there, the LCD shows `Register Now?`. Press **1** to choose `Yes`.

- 2 Enter the number (up to 20 characters). Press **OK**.
- 3 Choose one of the options below:
 - Enter the name using the dial pad (up to 15 characters). Press **OK**.
 - Press **OK** to store the number without a name.
- 4 If you want to save a fax resolution along with the number, choose one of the options below:
 - To store the fax resolution, press **▲** or **▼** to select *Std*, *Fine*, *S. Fine* or *Photo*. Press **OK**.
 - Press **OK** if you don't want to change the default resolution. The default setting is *Std*.



Note

You can also store the number by pressing **Menu, 2, 3, 1**.

Storing Speed Dial numbers

You can store your frequently used numbers as Speed Dial numbers, so that when you dial you will only have to press a few keys (, the three-digit number and **Start**). The machine can store 300 Speed Dial numbers (001 - 300).

- 1 Press  and enter a threedigit Speed Dial location number (001-300). If a number is not stored there, the LCD shows *Register Now?* Press **1** to choose *Yes*.
- 2 Enter the number (up to 20 characters). Press **OK**.
- 3 Do one of the following:
 - Enter the name using the dial pad (up to 15 characters). Press **OK**.
 - Press **OK** to store the number without a name.
- 4 Do one of the following:
 - If you want to save a fax resolution along with the number, press **▲** or **▼** to choose *Std*, *Fine*, *S. Fine* or *Photo*. Press **OK**.
 - Press **OK** if you do not want to change the default resolution.



Note

- When you do a broadcast and you have saved a scan profile along with the number, the scan profile of the One Touch, Speed Dial or Group number you chose first will be applied to the broadcast.
- You can also store the number by pressing **Menu, 2, 3, 2**.

Changing One Touch and Speed Dial numbers

If you try to store a number in a One Touch or Speed Dial location that already has a number stored in it, the LCD will show that existing name or number. If your machine has a scheduled job or you have set up fax forwarding to a stored number, the LCD will first ask you if you want to edit the number.

- 1 Do one of the following:
 - To change a stored One Touch number, press **Menu, 2, 3, 1**.
Choose the One Touch number you want to change.
 - To change a stored Speed Dial number, press **Menu, 2, 3, 2**.
Choose the Speed Dial number you want to change, then press **OK**.

- 2 Do one of the following:
 - To change the stored number, press **1**.
 - To exit without making a change, press **2**.

```
#005:MIKE
1.Change 2.Exit
```



- 3 Enter a new number or character. Press **OK**.
- 4 Press **◀** or **▶** to position the cursor under the character you want to change, and then press **Clear/Back** to delete it. Repeat for each character you want to delete.
- 5 Follow the directions beginning in step 4 in Storing One-Touch dial numbers and Storing Speed Dial numbers. (See *Storing One Touch Dial numbers* on page 61 and *Storing Speed Dial numbers* on page 62.)

Setting up Groups for Broadcasting

If you often want to send the same fax message to many fax numbers you can set up a group.

Groups are stored on a One Touch key or a Speed Dial number. Each group uses up a One Touch key or a Speed Dial location. You can then send the fax message to all the numbers stored in a group just by pressing a One Touch key or entering a Speed Dial number, and then pressing **Start**.

Before you can add numbers to a group, you need to store them as One Touch or Speed Dial numbers. You can have up to 20 small groups, or you can assign up to 315 numbers to one large group.

- 1 Press **Menu, 2, 3, 3**.
- 2 Choose an empty location where you want to store the group in one of the following ways:
 - Press a One Touch key.
 - Press  and then enter the three-digit Speed Dial location.
Press **OK**.
- 3 Use the dial pad to enter a group number (01 to 20). Press **OK**.
- 4 To add One Touch or Speed Dial numbers follow the instructions below:
 - For One Touch numbers, press the One Touch keys one after the other.
 - For Speed Dial numbers, press , and then enter the three-digit Speed Dial location.



The LCD will display your chosen One Touch numbers with a * and Speed Dial numbers with a # (for example *006, #009).

- 5 Press **OK** when you have finished adding numbers.
- 6 Do one of the following:
 - Enter the name using the dial pad (up to 15 characters). Use the chart on *Entering text* on page 174 to help you enter letters.
Press **OK**.
 - Press **OK** to store the group without a name.
- 7 If you want to save a fax resolution along with the number, choose one of the options below:
 - To store the fax resolution, press ▲ or ▼ to select *Std*, *Fine*, *S. Fine* or *Photo*.
Press **OK**.
 - Press **OK** if you don't want to change the default resolution.
- 8 Do one of the following:
 - To store another group for broadcasting, press **OK**. Go to step 2.
 - To finish storing groups for broadcasting, press **Stop/Exit**.

Combining quick dial numbers

You can combine more than one Quick Dial number when you dial. This feature may be useful if you need to dial an access code for a cheaper rate from another long distance carrier.

For example, you might have stored '555' on Speed Dial #003 and '7000' on Speed Dial #002. You can use them both to dial '555-7000' if you press the following keys:

Press , **003**. Press , **002** and **Start**.

Numbers can be added manually by entering them on the dial pad:

Press , **003**, **7001** (on the dial pad), and **Start**.

This would dial '555-7001'. You can also add a pause by pressing **Redial/Pause**.

Tone or Pulse

If you have a Pulse dialling service, but need to send Tone signals (for example, for telephone banking), follow the instructions below. If you have Touch Tone service, you will not need this feature to send tone signals.

- 1 Lift the handset of the external telephone.
- 2 Press **#** on the machine's control panel. Any digits dialled after this will send tone signals.
When you hang up, the machine will return to the Pulse dialling service.

Remote Fax Options let you receive faxes while you are away from the machine.

You can use *only one* Remote Fax Option at a time.

Fax Forwarding

The Fax Forwarding feature lets you automatically forward your received faxes to another machine. If you choose Backup Print On, the machine will also print the fax.

- 1 Press **Menu**, **2**, **5**, **1**.
- 2 Press **▲** or **▼** to choose **Fax Forward**. Press **OK**.
The LCD will ask you to enter the fax number you want your faxes to be forwarded to.
- 3 Enter the forwarding number (up to 20 digits). Press **OK**.
- 4 Press **▲** or **▼** to choose **On** or **Off**. Press **OK**.

```
Backup Print
On
```

- 5 Press **Stop/Exit**.

! IMPORTANT

If you choose Backup Print On, the machine will also print the fax at your machine so you will have a copy. This is a safety feature in case if there is a power failure before the fax is forwarded or a problem at the receiving machine. The machine can store faxes for up to 60 hours if there is a power failure.

Fax Storage

The Fax Storage feature lets you store your received faxes in the machine's memory. You can retrieve stored fax messages from a fax machine at another location using the remote retrieval commands. (See *Retrieving fax messages* on page 69.) Your machine will automatically print a copy of the stored fax.

- 1 Press **Menu**, **2**, **5**, **1**.
- 2 Press **▲** or **▼** to choose **Fax Storage**. Press **OK**.
- 3 Press **Stop/Exit**.

PC Fax Receive

If you turn on the PC Fax Receive feature your machine will store received faxes in memory and send them to your PC automatically. You can then use your PC to view and store these faxes.

Even if you have turned off your PC (at night or the weekend, for example), your machine will receive and store your faxes in its memory. The LCD will show the number of stored faxes received, for example:

PC Fax Msg:001

When you start your PC and the PC Fax Receiving software runs, your machine transfers your faxes to your PC automatically.

To transfer the received faxes to your PC you must have the PC-FAX Receiving software running on your PC. (For details, see *PC-FAX Receiving* in the *Software User's Guide* on the CD-ROM.)

- 1 Press **Menu**, **2**, **5**, **1**.
- 2 Press **▲** or **▼** to choose PC Fax Receive.
Press **OK**.
- 3 Press **▲** or **▼** to choose <USB>, or your computer name if the machine is connected to a network.
Press **OK**.
- 4 Press **▲** or **▼** to choose On or Off.

Backup Print
On

 Press **OK**.
- 5 Press **Stop/Exit**.

! IMPORTANT

If you choose Backup Print On, the machine will also print the fax at your machine so you will have a copy. This is a safety feature in case if there is a power failure before the fax is forwarded or a problem at the receiving machine. The machine can store faxes for up to 60 hours if there is a power failure.



Note

- Before you can set up PC Fax Receive you must install the MFL-Pro Suite software on your PC. Make sure your PC is connected and turned on. (For details see *PC-FAX Receiving* in the *Software User's Guide* on the CD-ROM.)
- If your machine has a problem and is unable to print faxes in memory, you can use this setting to transfer your faxes to a PC. (For details, see *Error and maintenance messages* on page 128.)
- PC Fax Receive is not supported in Mac OS. (See *PC Fax receiving* in the *Software User's Guide* on the CD-ROM.)

Changing Remote Fax Options

If received faxes are left in your machine's memory when you change to another Remote Fax Option, the LCD will ask you the following message:

```
Erase All Doc?
1.Yes 2.No
```

or

```
Print All Fax?
1.Yes 2.No
```

- If you press **1**, faxes in the memory will be erased or printed before the setting changes. If a backup copy has already been printed it will not be printed again.
- If you press **2**, faxes in the memory will not be erased or printed and the setting will be unchanged.

If received faxes are left in the machine's memory when you change to PC Fax Receive from another remote fax option (Fax Forward or Fax Storage), the LCD will ask you the following message:

```
Send Fax to PC?
1.Yes 2.No
```

- If you press **1**, faxes in the memory will be sent to your PC before the setting changes.
- If you press **2**, faxes in the memory will not be erased or transferred to your PC and the setting will be unchanged.

! IMPORTANT

If you choose Backup Print On, the machine will also print the fax at your machine so you will have a copy. This is a safety feature in case if there is a power failure before the fax is forwarded or a problem at the receiving machine. The machine can store faxes for up to 60 hours if there is a power failure.

Turning off Remote Fax Options

- 1 Press **Menu, 2, 5, 1**.
- 2 Press **▲** or **▼** to choose **Off**. Press **OK**.



Note

The LCD will give you options if there are received faxes still in your machine's memory. (See *Changing Remote Fax Options* on page 67.)

- 3 Press **Stop/Exit**.

Remote retrieval

The remote retrieval feature lets you retrieve your stored fax messages when you are not at the machine. You can call your machine from any touch tone phone or fax machine, then use the Remote Access Code to retrieve your messages.

Setting a Remote Access Code

The Remote Access Code feature lets you access the remote retrieval features when you are away from your machine. Before you use the remote access and retrieval features, you have to set up your own code. The default code is an inactive code: -- -*.

- 1 Press **Menu, 2, 5, 2**.
- 2 Enter a three-digit code using the numbers 0–9, * or #.
Press **OK**.
- 3 Press **Stop/Exit**.



Note

Do not use the same code used for your Remote Activation code (*51) or Remote Deactivation code (#51). (See *Changing the Remote Codes* on page 59.)

You can change your code at any time. If you want to make your code inactive, press **Clear/Back** and **OK** in 2 to restore the default setting -- -*.

Using your Remote Access Code

- 1 Dial your fax number from a telephone or another fax machine using touch tone.
- 2 When your machine answers, immediately enter your Remote Access Code
- 3 The machine signals if it has received messages:
 - *No beeps*
No messages received.
 - *1 long beep*
Fax message received.
- 4 The machine gives two short beeps to tell you to enter a command. The machine will hang up if you wait longer than 30 seconds before entering a command. If you enter an invalid command the machine will beep three times.
- 5 Press **9 0** to reset the machine when you have finished.
- 6 Hang up.



Note

If your machine is set to **Manual** mode, you can still access the remote retrieval features. Dial the fax number as normal and let the machine ring. After approximately 100 seconds you will hear a long beep to tell you to enter the remote access code. You will then have 30 seconds to enter the code.

Retrieving fax messages

- 1 Dial your fax number from a telephone or another fax machine using touch tone.
- 2 When your machine answers, immediately enter your Remote Access Code (3 digits followed by *). If you hear one long beep, you have messages.
- 3 When you hear two short beeps, use the dial pad to press **9 6 2**.
- 4 Wait for a long beep, and then use the dial pad to enter the number of the remote fax machine where you want your fax messages sent, followed by **##** (up to 20 digits).
- 5 Hang up after you hear your machine beep. Your machine will call the other machine, which will then print your fax messages.



Note

You can insert a pause in a fax number by using the # key.

Changing the Fax Forwarding number

You can change the default setting of your fax forwarding number from another telephone or fax machine using touch tone.

- 1 Dial your fax number from a telephone or another fax machine using touch tone.
- 2 When your machine answers, enter your Remote Access Code (3 digits followed by *). If you hear one long beep, you have messages.
- 3 When you hear two short beeps, use the dial pad to press **9 5 4**.
- 4 Wait for a long beep, and then use the dial pad to enter the new number of the remote fax machine where you want your fax messages forwarded followed by **##** (up to 20 digits).
- 5 Press **9 0** to reset the machine when you have finished.
- 6 Hang up after you hear your machine beep.



Note

You can insert a pause in a fax number by using the # key.

Remote fax commands

Follow the commands below to access features when you are away from the machine. When you call the machine and enter your Remote Access Code (3 digits followed by *), the system will give two short beeps and you must enter a remote command.

Remote commands		Operation details
95	Change the fax forwarding or fax storage settings	
	1 OFF	You can choose OFF after you have retrieved or erased all your messages.
	2 Fax Forwarding	One long beep means the change is accepted. If you hear three short beeps, you cannot change because the conditions have not been met (for example, registering a fax forwarding number). You can register the maximum number of rings. (See <i>Changing the Fax Forwarding number</i> on page 69.) Once you have registered the number, fax forwarding will work.
	4 Fax Forwarding number	
	6 Fax Storage	
96	Retrieve a fax	
	2 Retrieve all faxes	Enter the number of a remote fax machine to receive stored fax messages. (See <i>Retrieving fax messages</i> on page 69.)
	3 Erase faxes from the memory	If you hear one long beep, fax messages have been erased from the memory. (The machine will print any unprinted faxes in memory before erasing them.)
97	Check the receiving status	
	1 Fax	You can check whether your machine has received any faxes. If yes, you will hear one long beep. If no, you will hear three short beeps.
98	Change the Receive Mode	
	1 External TAD	If you hear one long beep, your change has been accepted.
	2 Fax/Tel	
	3 Fax Only	
90	Exit	Press 9 0 to exit remote retrieval. Wait for the long beep, then replace the handset.

10 Polling

Polling lets you set up your machine so other people can receive faxes from you, but they pay for the call. It also lets you call somebody else's fax machine and receive a fax from it, so you pay for the call. The polling feature needs to be set up on both machines for this to work. Not all fax machines support polling.

Polling receive

Polling receive lets you call another fax machine to receive a fax.

- 1 Make sure you are in Fax mode .
- 2 Press **Menu, 2, 1, 8**.
- 3 Press **▲** or **▼** to choose **Standard**. Press **OK**.
- 4 Enter the fax number you are polling. Press **Start**.

Secure polling

Secure polling lets you restrict who can get the documents you set up to be polled. Secure polling only works with Brother fax machines. If you want to get a fax from a secured Brother machine you have to enter the secure code.

- 1 Make sure you are in Fax mode .
- 2 Press **Menu, 2, 1, 8**.
- 3 Press **▲** or **▼** to choose **Secure**. Press **OK**.
- 4 Enter a four-digit secure code. Press **OK**.
This is the security code of the fax machine you are polling.
- 5 Enter the fax number you are polling.
- 6 Press **Start**.

Delayed polling

Delayed polling lets you set the machine to begin polling receive at a later time. You can only set up *one* delayed polling operation.

- 1 Make sure you are in Fax mode .
- 2 Press **Menu, 2, 1, 8**.
- 3 Press **▲** or **▼** to choose **Timer**. Press **OK**.
- 4 Enter the time (in 24-hour format) you want to begin polling. Press **OK**.
For example, enter 21:45 for 9:45 PM.
- 5 Enter the fax number you are polling. Press **Start**.
The machine makes the polling call at the time you entered.

Sequential polling

Sequential polling lets you request documents from several fax machines in one operation.

- 1 Make sure you are in Fax mode .
- 2 Press **Menu**, **2**, **1**, **8**.
- 3 Press **▲** or **▼** to choose *Standard*, *Secure* Or *Timer*. Press **OK**.
- 4 Choose one of the options below.
 - If you choose *Standard* go to step 5.
 - If you choose *Secure*, enter a four-digit number, press **OK**, go to step 5.
 - If you chose *Timer*, enter the time (in 24-hours format) you want to begin polling and press **OK**, go to step 5.
- 5 Specify the destination fax machines you want to poll by using *One Touch*, *Speed Dial*, *Search*, a *Group* or the dial pad. You must press **OK** between each location.

Press **Stop/Exit** while the machine is dialling to cancel the polling process.

To cancel all sequential polling receive jobs, press **Menu**, **2**, **7**. (See *Checking and cancelling waiting jobs* on page 45.)

Polled transmit

Polled transmit lets you set up your machine to wait with a document so another fax machine can call and retrieve it.

Setup for polled transmit

- 1 Make sure you are in Fax mode .
- 2 Load your document.
- 3 Press **Menu**, **2**, **2**, **6**.
- 4 Press **▲** or **▼** to choose *Standard*. Press **OK**.
- 5 Press **2** to choose *2.No* if you do not want to enter more settings when the LCD asks you the following message:

Next
 1.Yes 2.No
- 6 Press **Start**.
- 7 If you are using the scanner glass, the LCD will prompt you to choose one of the options below:

Next Page?
 1.Yes 2.No(Send)

 - Press **1** to send another page. Go to step 8.
 - Press **2** or **Start** to send the document.
- 8 Place the next page on the scanner glass, press **OK**. Repeat steps 7 and 8 for each additional page. Your machine will automatically send the fax.

**Note**

The document will be stored and can be retrieved from any other fax machine until you delete the fax from memory.

To delete the fax from memory, press **Menu, 2, 7**. (See *Checking and cancelling waiting jobs* on page 45.)

Setup for polled transmit with a secure code

Secure polling lets you restrict who can get the documents you set up to be polled. Secure polling only works with Brother fax machines. If another person wants to retrieve a fax from your machine they will have to enter the secure code.

- 1 Make sure you are in Fax mode .
- 2 Load your document.
- 3 Press **Menu, 2, 2, 6**.
- 4 Press **▲** or **▼** to choose *Secure*. Press **OK**.
- 5 Enter a four-digit number. Press **OK**.
- 6 Press **2** to choose *2.No* if you do not want to enter more settings when the LCD asks you the following message:

Next
 1.Yes 2.No
- 7 Press **Start**.
- 8 If you use the scanner glass, the LCD will prompt you to choose one of the options below:

Next Page?
 1.Yes 2.No(Send)

 - Press **1** to send another page.
Go to step 9.
 - Press **2** or **Start** to send the document.
- 9 Place the next page on the scanner glass, press **OK**. Repeat steps 8 and 9 for each additional page.

Set Next Page
 Then Press OK

Your machine will automatically send the fax.

11

Printing reports

Fax reports

Some fax reports (transmission verification and fax journal) can be printed automatically and manually.

Transmission verification report

You can use the Transmission Verification Report as proof that you sent a fax. This report lists the receiving party's name or fax number, the time and date of transmission, duration of transmission, number of pages sent, and whether or not the transmission was successful.

There are several settings available for the Transmission Verification Report:

- **On:** Prints a report after every fax you send.
- **On+Image:** Prints a report after every fax you send. A portion of the fax's first page appears on the report.
- **Off:** Prints a report *only* if your fax is unsuccessful due to a transmission error. **Off** is the default setting.
- **Off+Image:** Prints a report *only* if your fax is unsuccessful due to a transmission error. A portion of the fax's first page appears on the report.



Note

- If your transmission is successful, **OK** will appear next to **RESULT** on the Transmission Verification Report. If transmission is not successful, **ERROR** will appear next to **RESULT**.
- If you choose **On+Image** or **Off+Image**, the image will only appear on the Transmission Verification Report if Real Time Transmission is set to **Off**. (See *Real Time Transmission* on page 44.)

- 1 Press **Menu**, **2**, **4**, **1**.
- 2 Press **▲** or **▼** to choose **On**, **On+Image**, **Off** or **Off+Image**. Press **OK**.
- 3 Press **Stop/Exit**.

Fax Journal

You can set the machine to print a fax journal (activity report) at specific intervals (every 50 faxes, 6, 12 or 24 hours, 2 or 7 days). The default setting is **Every 50 Faxes**, this means that your machine will print the journal when the machine has stored 50 jobs.

If you set the interval to **Off**, you can still print the report by following the steps on the next page.

- 1 Press **Menu**, **2**, **4**, **2**.
- 2 Press **▲** or **▼** to choose an interval. Press **OK**.
If you choose 7 days, you will be asked to choose a day when you want the 7 day countdown to begin.
- 3 Enter the time to begin printing, in 24 hour format. Press **OK**.
For example: enter 19:45 for 7:45 PM.
- 4 Press **Stop/Exit**.

If you choose 6, 12, 24 hours, 2 or 7 days, the machine will print the report at the selected time and then erase all jobs from its memory. If the machine's memory becomes full with 200 jobs before the time you chose has passed, the machine will print the journal early and then erase all jobs from memory.

If you want an extra report before it is due to print, you can print it manually without erasing the jobs from memory.

Reports

The following reports are available:

- 1 **XMIT Verify**
Displays the Transmission Verification Report for your last outgoing 200 faxes and prints the last report.
- 2 **Help List**
Prints a list of commonly used functions to help you program your machine.
- 3 **Tel Index List**
Prints a list of names and numbers stored in the One Touch and Speed Dial memory in numerical or alphabetical order.
- 4 **Fax Journal**
Prints a list of information about your last 200 incoming and outgoing faxes. (TX: transmit.) (RX: receive.)
- 5 **User Settings**
Print a list of your current settings.
- 6 **Network Config**
Lists your network settings.
- 7 **Order Form**
You can print an accessories order form to fill out and send to your Brother dealer.

How to print a report

- 1 Press **Menu, 6**.
- 2 Do one of the following:
 - Press **▲** or **▼** to choose the report you want.
Press **OK**.
 - Enter the number of the report you want to print. For example, press **2** to print the Help List.
- 3 Press **Start**.
- 4 Press **Stop/Exit**.



Copy

Making copies

78

12

Making copies

How to copy

Entering copy mode

Press  (**Copy**) to enter Copy mode.

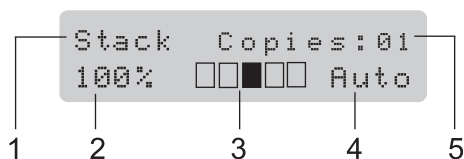

- 1 **Stack/Sort/Duplex**
- 2 **Copy ratio and copy layout**
- 3 **Contrast**
- 4 **Quality**
- 5 **Number of copies**

Making a single copy

- 1 Make sure you are in Copy mode .
- 2 Load your document.
- 3 Press **Start**.

Making multiple copies

- 1 Make sure you are in Copy mode .
- 2 Load your document.
- 3 Use the dial pad to enter the number of copies (up to 99).
- 4 Press **Start**.



Note

To sort your copies, see *Sorting copies using the ADF* on page 81.

Stop copying

To stop copying, press **Stop/Exit**.

Copy options (temporary settings)

When you want to quickly change the copy settings temporarily for the next copy, use the temporary **Copy** keys. You can use different combinations.

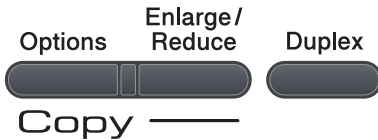

The machine returns to its default settings one minute after copying, unless you have set the Mode Timer to 30 seconds or less. (See *Mode Timer* on page 22.)

Enlarging or reducing the image copied

You can choose the following enlargement or reduction ratios:

Press 	100%*
	97% LTR→A4
	94% A4→LTR
	91% Full Page
	85% LTR→EXE
	83%
	78%
	70% A4→A5
	50%
	Custom (25-400%)
	Auto
	200%
	141% A5→A4
	104% EXE→LTR

* The factory setting is shown in Bold with an asterisk.

When set to **Auto**, the machine calculates the reduction ratio that best fits the paper size the paper tray is set to. (See *Paper Size* on page 23.)

Auto is only available when using the ADF.

Custom (25-400%) allows you to enter a ratio from 25% to 400%.



To enlarge or reduce the next copy follow the instructions below:

- 1 Make sure you are in Copy mode .
- 2 Load your document.
- 3 Use the dial pad to enter the number of copies (up to 99).
- 4 Press **Enlarge/Reduce**.
- 5 Do one of the following:
 - Press **▲** or **▼** to choose the enlargement or reduction ratio you want.
Press **OK**.
 - Press **▲** or **▼** to choose **Custom (25-400%)**.
Press **OK**.
Use the dial pad to enter an enlargement or reduction ratio from 25% to 400%. (For example, press **5 3** to enter 53%.)
Press **OK**.
- 6 Press **Start**.

 **Note**
Page Layout Options 2 in 1(P), 2 in 1(L), 4 in 1(P) or 4 in 1(L) are *not* available with Enlarge/Reduce.

Using the Options key

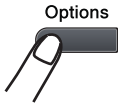
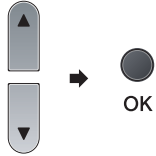
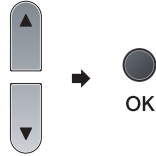
Use the **Options** key to quickly set the following copy settings temporarily for the next copy.

Press	Menu selections	Options	Page
Press 	Press ▲ or ▼, then press OK 	Press ▲ or ▼, then press OK 	
	Stack/Sort (appears when the document is in the ADF)	Stack* Sort	81
	Quality	Auto* Photo Text	81
	Brightness	▼-□□□■+▲ ▼-□□□■+▲ ▼-□□■□+▲* ▼-□■□□+▲ ▼-■□□□+▲	81
	Contrast	▼-□□□■+▲ ▼-□□□■+▲ ▼-□□■□+▲* ▼-□■□□+▲ ▼-■□□□+▲	82
	Page Layout	Off (1 in 1) * 2 in 1 (P) 2 in 1 (L) 4 in 1 (P) 4 in 1 (L)	82
	Tray Select	MP>T1* Or MP>T1>T2* T1>MP or T1>T2>MP #1 (XXX) ¹ #2 (XXX) ¹ MP (XXX) ¹ ¹ "XXX" is the paper size. (T2 or #2 appears only if you installed the optional paper tray.)	83
 The factory settings are shown in Bold with an asterisk.			

Sorting copies using the ADF

You can sort multiple copies. Pages will be stacked in the order 1 2 3, 1 2 3, 1 2 3, and so on.

- 1 Make sure you are in Copy mode .
- 2 Unfold the ADF output tray and place your document *face down* in the ADF input tray.
- 3 Use the dial pad to enter the number of copies (up to 99).
- 4 Press **Options** and **▲** or **▼** to choose *Stack/Sort*. Press **OK**.
- 5 Press **▲** or **▼** to choose *Sort*. Press **OK**.
- 6 Press **Start**.

Improving copy quality

You can choose from a range of quality settings. The default setting is *Auto*.

■ Auto

Auto is the recommended mode for ordinary printouts. Suitable for documents that contain both text and photographs.

■ Text

Suitable for documents containing only text.

■ Photo

Suitable for copying photographs.

To *temporarily* change the quality setting, follow the steps below:

- 1 Make sure you are in Copy mode .
- 2 Load your document.
- 3 Use the dial pad to enter the number of copies (up to 99).

- 4 Press **Options**. Press **▲** or **▼** to choose *Quality*. Press **OK**.
- 5 Press **▲** or **▼** to choose *Auto, Photo* or *Text*. Press **OK**.
- 6 Press **Start**.

To change the *default* setting, follow the steps below:

- 1 Press **Menu, 3, 1**.
- 2 Press **▲** or **▼** to choose the copy quality. Press **OK**.
- 3 Press **Stop/Exit**.

Adjusting Contrast and Brightness

Brightness

Adjust the copy brightness to make copies darker or lighter.

To *temporarily* change the copy brightness setting, follow the steps below:

- 1 Make sure you are in Copy mode .
- 2 Load your document.
- 3 Use the dial pad to enter the number of copies (up to 99).
- 4 Press **Options**. Press **▲** or **▼** to choose *Brightness*. Press **OK**.
- 5 Press **▲** to make a lighter copy or press **▼** to make a darker copy. Press **OK**.
- 6 Press **Start**.

To change the *default* setting follow the steps below:

- 1 Press **Menu**, **3**, **2**.
- 2 Press **▲** to make a lighter copy or press **▼** to make a darker copy. Press **OK**.
- 3 Press **Stop/Exit**.

Contrast

Adjust the contrast to help an image look sharper and more vivid.

To *temporarily* change the contrast setting, follow the steps below:

- 1 Make sure you are in Copy mode .
- 2 Load your document.
- 3 Use the dial pad to enter the number of copies (up to 99).
- 4 Press **Options**. Press **▲** or **▼** to choose *Contrast*. Press **OK**.
- 5 Press **▲** or **▼** to increase or decrease the contrast. Press **OK**.
- 6 Press **Start**.

To change the *default* setting follow the steps below:

- 1 Press **Menu**, **3**, **3**.
- 2 Press **▲** or **▼** to increase or decrease the contrast. Press **OK**.
- 3 Press **Stop/Exit**.

Making N in 1 copies (page layout)

You can reduce the amount of paper used when copying by using the N in 1 copy feature. This allows you to copy two or four pages onto one page, which lets you save paper.

! IMPORTANT

- Please make sure the paper size is set to Letter, A4, Legal ¹ or Folio ¹.
- (P) means Portrait and (L) means Landscape.
- You cannot use the Enlarge/Reduce setting with the N in 1 feature.

¹ You can choose Legal and Folio for MP Tray only.

- 1 Make sure you are in Copy mode .
- 2 Load your document.
- 3 Use the dial pad to enter the number of copies (up to 99).
- 4 Press **Options**. Press **▲** or **▼** to choose *Page Layout*. Press **OK**.
- 5 Press **▲** or **▼** to choose 2 in 1 (P), 2 in 1 (L), 4 in 1 (P), 4 in 1 (L) or Off (1 in 1). Press **OK**.
- 6 Press **Start** to scan the page. If you placed the document in the ADF, the machine scans the pages and starts printing. **If you are using the scanner glass, go to step 7.**
- 7 After the machine scans the page, press **1** to scan the next page.

Next Page?
1.Yes 2.No

- 8 Put the next page on the scanner glass. Press **OK**. Repeat steps 7 and 8 for each page of the layout.
- 9 After all the pages have been scanned, press 2 in step 7 to finish.

Place the document face down in the direction shown below:

■ 2 in 1 (P)



■ 2 in 1 (L)

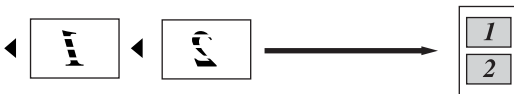

■ 4 in 1 (P)



■ 4 in 1 (L)



Tray selection

You can change the Tray Use only for the next copy.

- 1 Make sure you are in Copy mode .
- 2 Load your document.
- 3 Use the dial pad to enter the number of copies (up to 99).
- 4 Press **Options**. Press **▲** or **▼** to choose Tray Select. Press **OK**.
- 5 Press **▲** or **▼** to choose the MP>T1>T2, T1>T2>MP, #1 (XXX), #2 (XXX) or MP (XXX). Press **OK**.
- 6 Press **Start**.



Note

- T2 or #2 appears only if the optional paper tray is installed.
- T2 or #2 is available for MFC-8380DN.
- To change the default setting for Tray Select, see *Tray Use in copy mode* on page 23.

Duplex (2-sided) copying

If you want to use the duplex copy feature, load your document in the ADF.

If you get an *Out of Memory* message while you are making duplex copies, try installing extra memory. (See *Out of memory message* on page 86.)

Duplex Copy (long edge flip)

MFC-8370DN

■ 1sided-2 sided L

Portrait

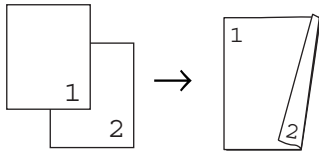

Landscape

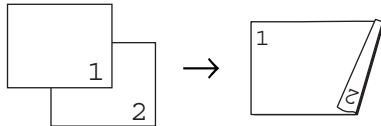

- 1 Make sure you are in Copy mode .
- 2 Unfold the ADF output tray and place your document *face down* in the ADF input tray.
- 3 Enter the number of copies (up to 99) using the dial pad.
- 4 Press **Duplex** and **▲** or **▼** to select 1sided-2sided L. Press **OK**.
- 5 Press **Start** to copy the document.

MFC-8380DN

■ 1sided-2sided L

Portrait

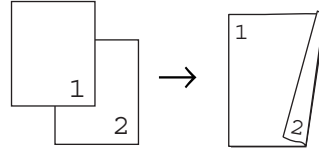

Landscape

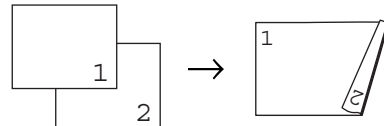

■ 2sided-2sided

Portrait

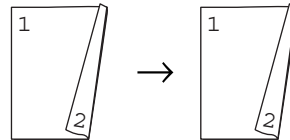

Landscape

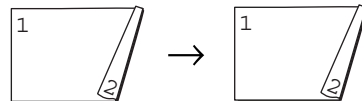

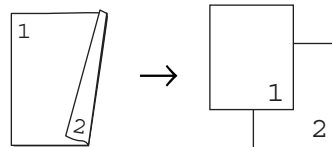

■ 2sided L-1sided

Portrait

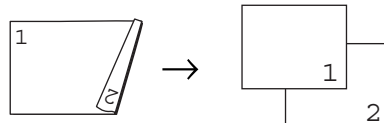

Landscape



- 1 Make sure you are in Copy mode .
- 2 Unfold the ADF output tray and place your document *face down* in the ADF input tray.

- 3 Enter the number of copies (up to 99) using the dial pad.
- 4 Press **Duplex** and ▲ or ▼ to select 1sided→2sided L, 2sided → 2sided or 2Sided L-1Sided.

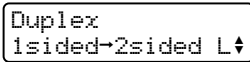

Press **OK**.

- 5 Press **Start** to copy the document.



Note

- Duplex copy using a 2-sided legal size document is not available.
- (L) means Long edge and (S) means Short edge.

Advanced Duplex Copy (short edge flip)

MFC-8370DN

■ 1sided→2sided S

Portrait

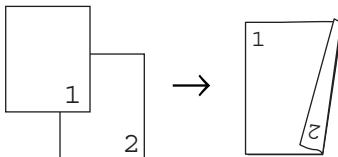

Landscape

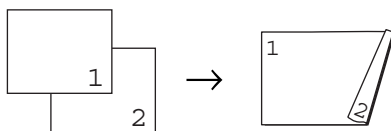

- 1 Make sure you are in Copy mode .
- 2 Unfold the ADF output tray and place your document *face down* in the ADF input tray.
- 3 Enter the number of copies (up to 99) using the dial pad.

- 4 Press **Duplex** and ▲ or ▼ to select 1sided→2sided S. Press **OK**.

- 5 Press **Start** to copy the document.

MFC-8380DN

■ Advanced 2sided S→1sided

Portrait

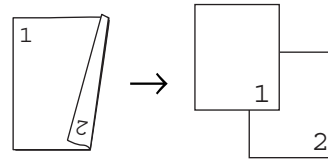

Landscape

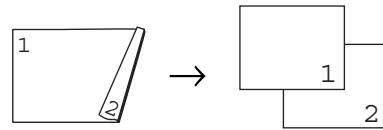

■ Advanced 1sided→2sided S

Portrait

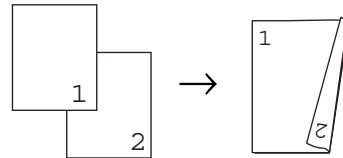

Landscape

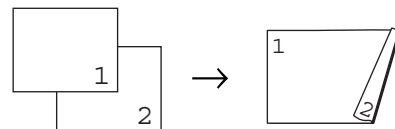

- 1 Make sure you are in Copy mode .
- 2 Unfold the ADF output tray and place your document *face down* in the ADF input tray.
- 3 Enter the number of copies (up to 99) using the dial pad.
- 4 Press **Duplex** and ▲ or ▼ to select Advanced. Press **OK**.

5 Press ▲ or ▼ to select
2Sided S-1Sided or
1sided→2sided S. Press **OK**.

6 Press **Start** to copy the document.



Note

- Duplex copy using a 2-sided legal size document is not available.
 - (L) means Long edge and (S) means Short edge.
-

Out of memory message

If the memory becomes full while you are making copies, the LCD message will guide you through the next step.

If you get an *Out of Memory* message while scanning a subsequent page, you will have the option to press **Start** to copy the pages scanned so far, or to press **Stop/Exit** to cancel the operation.

To gain extra memory, you can do the following:

- Print the faxes that are in the memory. (See *Out of Paper Reception* on page 52.)
- You can turn off Fax Storage. (See *Turning off Remote Fax Options* on page 67.)



Note

When you get an *Out of Memory* message, you may be able to make copies if you first print incoming faxes in the memory to restore the memory to 100%.



Direct printing

Printing data from a USB Flash memory drive or a digital camera supporting mass storage

88

13

Printing data from a USB Flash memory drive or a digital camera supporting mass storage

With the Direct Print feature, you do not need a computer to print data. You can print by just plugging your USB Flash memory drive into the machine's USB direct interface. You can also connect and print directly from a camera set to USB mass storage mode.



Note

- Some USB Flash memory drives may not work with the machine.
- If your camera is in PictBridge mode, you cannot print data. Please refer to the documentation supplied with your camera to switch from PictBridge mode to mass storage mode.

Supported file formats

Direct Print supports the following file formats:

- PDF version 1.7 ¹
- JPEG
- Exif + JPEG
- PRN (created by Brother driver)
- TIFF (scanned by all MFC or DCP Brother models)
- PostScript® 3™ (created by the Brother BRScrip3 printer driver)
- XPS version 1.0

¹ PDF data including a JBIG2 image file, a JPEG2000 image file or transparency files are not supported.

Creating a PRN or PostScript® 3™ file for direct printing



Note

The screens in this section may vary depending on your application and operating system.

- 1 From the menu bar of an application, click **File**, then **Print**.
- 2 Choose **Brother MFCXXXX Printer (1)** and check the **Print to file** box (2). Click **Print**.

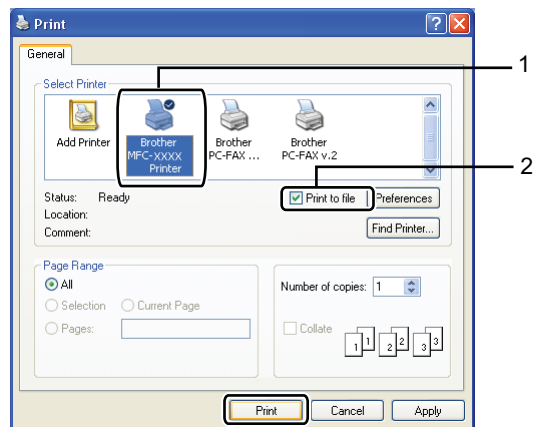

- 3 Choose the folder you want to save the file to and enter the file name if you are prompted to. If you are prompted for a file name only, you can also specify the folder you want to save the file in by entering the directory name. For example:
C:\Temp\FileName.prn
If you have a USB Flash memory drive or digital camera connected to your computer, you can save the file directly to the USB Flash memory drive.

Printing data directly from the USB Flash memory drive or digital camera supporting mass storage

- 1 Connect your USB Flash memory drive or digital camera to the USB direct interface (1) on the front of the machine.

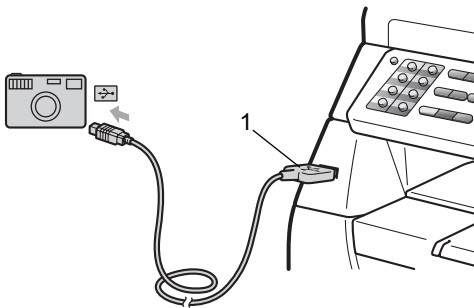
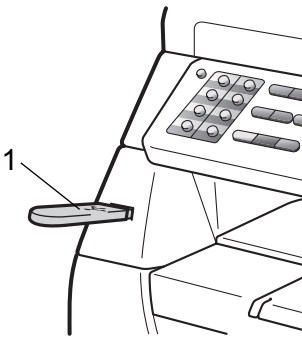

Note

For MFC-8380DN

- If the Direct Print setting of Secure Function Lock 2.0 is set to *Off* for all users (including Public mode settings), *Not Available* will appear on the LCD and then the machine will go back to the Ready mode. You cannot access to the Direct Print function.

- If the current restricted user ID you are using is restricted for the Direct Print function from Secure Function Lock 2.0, but other restricted users (including Public mode settings) are allowed access, *Access Denied* will appear on the LCD and then the machine will ask your name. If you are a restricted user with access to Direct Print, press **▲** or **▼** to choose your name, press **OK** and enter your four-digit password.
- If your administrator has set a page limit for Direct Print and the machine has already reached the maximum number of pages, the LCD will show *Limit Exceeded* when you insert a USB flash memory drive or digital camera.

- 2 When the machine has recognized the USB flash memory drive or digital camera, the **Direct** key turns blue. Press the **Direct** key.
- 3 Press **▲** or **▼** to choose the folder name or file name you want to print. Press **OK**.
If you have chosen the folder name, press **▲** or **▼** to choose the file name you want to print. Press **OK**.

Note

- Your digital camera must be switched from PictBridge mode to mass storage mode.
- If you want to print an index of the files, choose *Index Print*, and then press **OK**. Press **Start** to print the data.
- File names that are stored in your USB Flash memory drive can be displayed using the following characters on the LCD:
A B C D E F G H I J K L M N O P Q R S T
U V W X Y Z 0 1 2 3 4 5 6 7 8 9 \$ % ' ' - @
{ } ~ ! # () & _ ^

- 4 Do one of the following:
- Press ▲ or ▼ to choose a setting you need to change and press **OK**, and then press ▲ or ▼ to choose an option for the setting and press **OK**.
 - If you do not need to change the current default settings, go to step 5.

```
Print File Set
Paper Size  ▾
```



Note

- You can choose the following settings:

```
Paper Size
Media Type
Multiple Page
Orientation
Duplex
Collate
Tray Use
Print Quality
PDF Option
```

- Depending on the file type, some of these settings may not appear.

- 5 Press **Start** if you have finished.
- 6 Press the dial pad key to enter the number of copies you want. Press **OK**.
- 7 Press **Start** to print the data.

! IMPORTANT

- To prevent damage to your machine, **DO NOT** connect any device other than a digital camera or USB Flash memory drive to the USB direct interface.
- **DO NOT** remove the USB Flash memory drive or digital camera from the USB direct interface until the machine has finished printing.



Note

- If you want to change the default setting for the paper tray to feed paper from, press **Menu, 1, 6, 3** to change the paper tray setting.
- You can change the default settings for Direct Print by using the control panel when the machine is not in the Direct Print mode. Press **Menu, 5** to enter the USB Direct I/F menu. (See *Menu table* on page 161.)

Understanding the error messages

Once you are familiar with the types of errors that can occur while you print data from the USB Flash memory drive or digital camera with Direct Print, you can easily identify and troubleshoot any problems.

■ Out of Memory

This message will appear if you are working with images that are too large for the machine's memory.

■ Unusable Device

This message will appear if you connect an incompatible or broken device to the USB direct interface. To clear the error, unplug the device from the USB direct interface.

(See *Error and maintenance messages* on page 128 for the detailed solution.)



Software

Software and Network features

94

The HTML User's Guide on the CD-ROM includes the **Software User's Guide** and **Network User's Guide** for features available when connected to a computer (for example, printing and scanning). These guides have easy to use links that, when clicked, will take you directly to a particular section.

You can find information on these features:

- Printing
- Scanning
- ControlCenter3 (Windows®)
- ControlCenter2 (Macintosh)
- Remote Setup
- Faxing from your computer
- Network Faxing
- Network Printing
- Network Scanning



Note

See *Accessing the Software User's Guide and Network User's Guide* on page 3.

How to read the HTML User's Guide

This is a quick reference for using the HTML User's Guide.

Windows®



Note

If you have not installed the software, see *Viewing documentation (Windows®)* on page 3.

- 1 From the **Start** menu, point to **Brother**, **MFC-XXXX** from the programs group, then click **User's Guides in HTML format**.
- 2 Click on the manual you want (**SOFTWARE USER'S GUIDE** or **NETWORK USER'S GUIDE**) from the Top Menu.

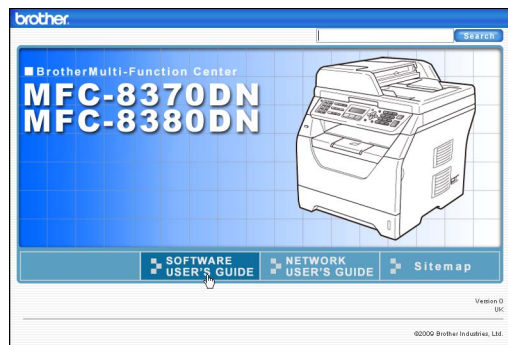

- 3 Click the heading you would like to view from the list at the left of the window.

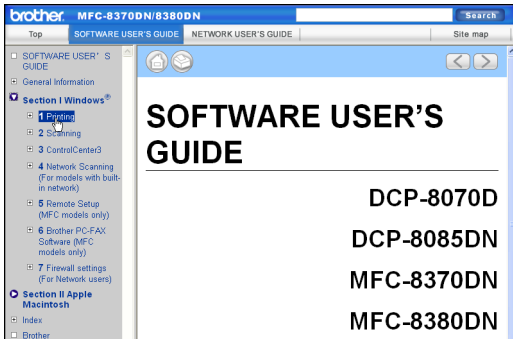

Macintosh

- 1 Make sure your Macintosh is turned on. Insert the Brother CD-ROM into your CD-ROM drive.
- 2 Double-click the **Documentation** icon.
- 3 Double-click your language folder, and then double-click the top.html file.
- 4 Click on the manual you want (**SOFTWARE USER'S GUIDE** or **NETWORK USER'S GUIDE**) in the top menu, and then click the heading you would like to read from the list at the left of the window.

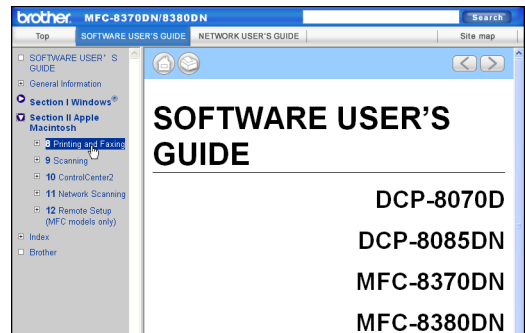



Appendixes

Safety and legal	98
Options	109
Troubleshooting and routine maintenance	111
Menu and features	159
Specifications	176
Glossary	190

A

Safety and legal

Choosing a location

Put your machine on a flat, stable surface that is free of vibration and shocks, such as a desk. Put the machine near a telephone socket and a standard grounded electrical socket. Choose a location where the temperature remains between 10°C and 32.5°C and the humidity is between 20% to 80% (without condensation.)

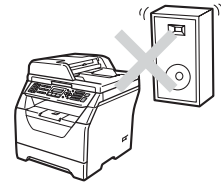

⚠ WARNING

DO NOT expose the machine to direct sunlight, excessive heat, open flames, salty or corrosive gasses, moisture or dust.

DO NOT place the machine near heaters, air conditioners, refrigerators, water or chemicals.

⚠ CAUTION

Avoid placing your machine in a high-traffic area.

Avoid placing your machine on a carpet.

DO NOT connect your machine to electrical sockets controlled by wall switches or automatic timers, or to the same circuit as large appliances that might disrupt the power supply.

Disruption of power can wipe out information in the machine's memory.

Avoid interference sources, such as other cordless telephone systems or speakers.

Make sure cables leading to the machine do not constitute a trip hazard.

To use the machine safely

Please keep these instructions for later reference and read them before attempting any maintenance.

WARNING



There are high voltage electrodes inside the machine. Before you clean the inside of the machine, make sure you have unplugged the telephone line cord first and then the power cord from the electrical socket. Doing this will prevent an electrical shock.

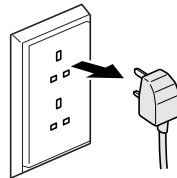

DO NOT handle the plug with wet hands. Doing this might cause an electrical shock. Always make sure the plug is fully inserted.

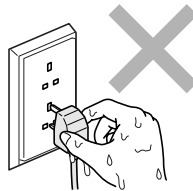

This product must be installed near an electrical socket that is easily accessible. In case of an emergency, you must unplug the power cord from the electrical socket to shut off the power completely.

Plastic bags are used in the packing of your machine and drum unit. To avoid the danger of suffocation, keep these bags away from babies and children.

DO NOT use flammable substances, any types of spray or any organic solvent/liquids contains alcohol or ammonia to clean the inside or outside of the machine. Doing this may cause a fire or electrical shock. See *Routine maintenance* on page 142 for how to clean the machine.



DO NOT use a vacuum cleaner to clean up scattered toner. Doing this might cause the toner dust to ignite inside the vacuum cleaner, potentially starting a fire. Please carefully clean the toner dust with a dry, lint-free soft cloth and dispose of it according to local regulations.

Use caution when installing or modifying telephone lines. Never touch telephone wires or terminals that are not insulated unless the telephone line has been unplugged at the wall socket. Never install telephone wiring during a lightning storm. Never install a telephone wall socket in a wet location.

When using your telephone equipment, basic safety precautions should always be followed to reduce the risk of fire, electrical shock and injury to people, including the following:

- 1 DO NOT use this product near water, for example, near a bath tub, wash bowl, kitchen sink or washing machine, in a wet basement or near a swimming pool.
- 2 Avoid using this product during an electrical storm. There may be a remote risk of electric shock from lightning.
- 3 DO NOT use this product to report a gas leak in the vicinity of the leak.
- 4 DO NOT dispose of batteries in a fire. They may explode. Check with local codes for possible special disposal instructions.
- 5 We DO NOT advise using an extension lead.
- 6 Never install telephone wiring during a lightning storm. Never install a telephone wall socket in a wet location.
- 7 If any cables become damaged, disconnect your machine, and contact your Brother dealer.
- 8 DO NOT place any objects on the machine, or obstruct the air vents.
- 9 This product should be connected to an adjacent grounded AC power source within the range indicated on the rating label. DO NOT connect it to a DC power source or inverter. If you are not sure, contact a qualified electrician.

⚠ CAUTION

After you have just used the machine, some internal parts of the machine will be extremely hot. When you open the front or back cover of the machine, **DO NOT** touch the shaded parts shown in the illustrations.

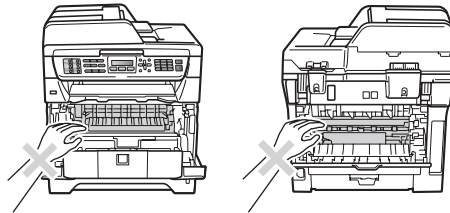

To prevent injuries, be careful not to put your hands on the edge of the machine under the scanner or document cover as shown in the illustrations.

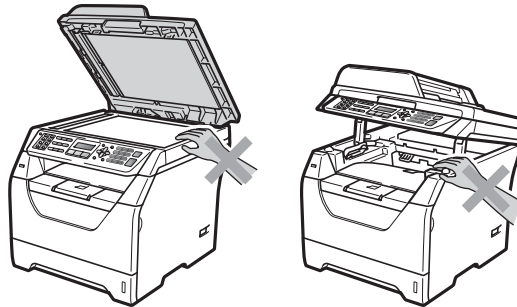

To prevent injuries, be careful not to put your fingers in the areas shown in the illustration.

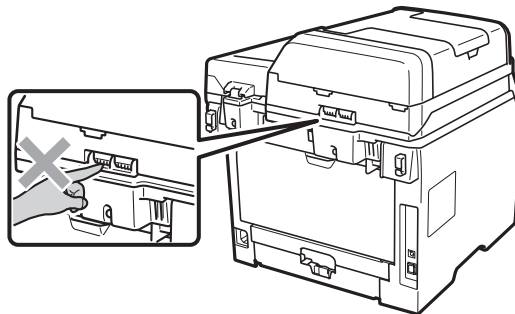

When you move the machine, grasp the side hand holds that are located at the bottom of the machine.

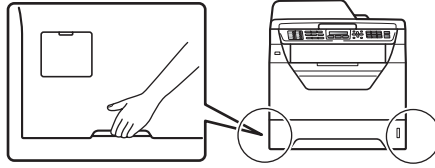

! IMPORTANT

The fuser unit is marked with a Caution label. Please DO NOT remove or damage the label.

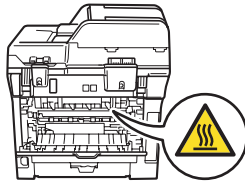

Important safety instructions

- 1 Read all of these instructions.
- 2 Save them for later reference.
- 3 Follow all warnings and instructions marked on the product.
- 4 Unplug this product from the wall socket before cleaning inside of the machine. **DO NOT** use liquid or aerosol cleaners. Use a dry lint-free soft cloth for cleaning.
- 5 **DO NOT** place this product on an unstable cart, stand, or table. The product may fall, causing serious damage to the product.
- 6 Slots and openings in the casing at the back or bottom are provided for ventilation. To ensure reliable operation of the product and to protect it from overheating, these openings must not be blocked or covered. The openings should never be blocked by placing the product on a bed, sofa, rug, or other similar surface. This product should never be placed near or over a radiator or heater. This product should never be placed in a built-in installation unless adequate ventilation is provided.
- 7 This product should be connected to an AC power source within the range indicated on the rating label. **DO NOT** connect it to a DC power source or inverter. If you are not sure, contact a qualified electrician.
- 8 This product is equipped with a 3-wire grounded plug. This plug will only fit into a grounded power outlet. This is a safety feature. If you are unable to insert the plug into the outlet, call your electrician to replace your obsolete outlet. **DO NOT** defeat the purpose of the grounded plug.
- 9 Use only the power cord supplied with this machine.
- 10 **DO NOT** allow anything to rest on the power cord. **DO NOT** place this product where people can walk on the cord.
- 11 Use the product in a well-ventilated area.
- 12 The power cord, including extensions, should be no longer than 16.5 feet (5 metres).
DO NOT share the same power circuit with other high powered appliances, such as an air conditioner, copier, shredder, and so on. If you cannot avoid using the printer with these appliances, we recommend that you use a voltage transformer or a high-frequency noise filter.
Use a voltage regulator if the power source is not stable.
- 13 **DO NOT** place anything in front of the machine that will block received faxes. **DO NOT** place anything in the path of received faxes.
- 14 Wait until pages have exited the machine before picking them up.
- 15 Unplug this product from the power socket and refer all servicing to Brother Authorized Service Personnel under the following conditions:
 - When the power cord is damaged or frayed.
 - If liquid has been spilled into the product.
 - If the product has been exposed to rain or water.

- If the product does not operate normally when the operating instructions are followed. Adjust only those controls that are covered by the operating instructions. Incorrect adjustment of other controls may result in damage and will often require extensive work by a qualified technician to restore the product to normal operation.
 - If the product has been dropped or the casing has been damaged.
 - If the product exhibits a distinct change in performance, indicating a need for service.
- 16 To protect your product against power surges, we recommend the use of a power protection device (Surge Protector).
- 17 To reduce the risk of fire, electric shock and injury to people, note the following:
- DO NOT use this product near appliances that use water, a swimming pool or in a wet basement.
 - DO NOT use the machine during an electrical storm (there is the remote possibility of an electrical shock) or to report a gas leak in the vicinity of the leak.
 - DO NOT use this product in the vicinity of a gas leak.

IEC60825-1+A2:2001 Specification

This machine is a Class 1 laser product as defined in IEC60825-1+A2:2001 specifications. The label shown below is attached in countries where required.

This machine has a Class 3B Laser Diode which emits invisible laser radiation in the Scanner Unit. The Scanner Unit should not be opened under any circumstances.



Internal Laser radiation

Wave length: 770 - 810 nm

Output: 5 mW max.

Laser Class: Class 3B

WARNING

Use of controls, adjustments or performance of procedures other than those specified in this manual may result in hazardous radiation exposure.

Disconnect device

This product must be installed near an electrical socket that is easily accessible. In case of emergencies, you must disconnect the power cord from the electrical socket to shut off power completely.

Wiring information (U.K. only)

If you need to replace the plug fuse, fit a fuse that is approved by ASTA to BS1362 with the same rating as the original fuse.

Always replace the fuse cover. Never use a plug that does not have a cover. If in any doubt, call a qualified electrician.

Warning - This printer must be earthed.

The wires in the mains lead are coloured in line with the following code:

- Green and Yellow: Earth
- Blue: Neutral
- Brown: Live

LAN connection

⚠ CAUTION

DO NOT connect this product to a LAN connection that is subject to over-voltages.

Radio interference

This product complies with EN55022 (CISPR Publication 22)/Class B.

EU Directive 2002/96/EC and EN50419



European
Union only

This equipment is marked with the above recycling symbol. It means that at the end of the life of the equipment you must dispose of it separately at an appropriate collection point and not place it in the normal domestic unsorted waste stream. This will benefit the environment for all.
(European Union only)

EU Directive 2006/66/EC - Removing or Replacing the Battery

This product incorporates a battery that is designed to last for the lifetime of the product. It is not to be replaced by the user. It should be removed as part of the machine recycling process at the end of life and appropriate precautions taken by the recycler.

International ENERGY STAR® Compliance Statement

The purpose of the International ENERGY STAR® Program is to promote the development and popularization of energy-efficient office equipment.

As an ENERGY STAR® Partner, Brother Industries, Ltd. has determined that this product meets the ENERGY STAR® guidelines for energy efficiency.



Libtiff Copyright and License

Use and Copyright

Copyright© 1988-1997 Sam Leffler

Copyright© 1991-1997 Silicon Graphics, Inc.

Permission to use, copy, modify, distribute, and sell this software and its documentation for any purpose is hereby granted without fee, provided that (i) the above copyright notices and this permission notice appear in all copies of the software and related documentation, and (ii) the names of Sam Leffler and Silicon Graphics may not be used in any advertising or publicity relating to the software without the specific, prior written permission of Sam Leffler and Silicon Graphics.

THE SOFTWARE IS PROVIDED "AS-IS" AND WITHOUT WARRANTY OF ANY KIND, EXPRESS, IMPLIED OR OTHERWISE, INCLUDING WITHOUT LIMITATION, ANY WARRANTY OF MERCHANTABILITY OR FITNESS FOR A PARTICULAR PURPOSE.

IN NO EVENT SHALL SAM LEFFLER OR SILICON GRAPHICS BE LIABLE FOR ANY SPECIAL, INCIDENTAL, INDIRECT OR CONSEQUENTIAL DAMAGES OF ANY KIND, OR ANY DAMAGES WHATSOEVER RESULTING FROM LOSS OF USE, DATA OR PROFITS, WHETHER OR NOT ADVISED OF THE POSSIBILITY OF DAMAGE, AND ON ANY THEORY OF LIABILITY, ARISING OUT OF OR IN CONNECTION WITH THE USE OR PERFORMANCE OF THIS SOFTWARE.

Trademarks

The Brother logo is a registered trademark of Brother Industries, Ltd.

Brother is a registered trademark of Brother Industries, Ltd.

Multi-Function Link is a registered trademark of Brother International Corporation.

Microsoft, Windows, Windows Server and Internet Explorer are registered trademarks of Microsoft Corporation in the United States and/or other countries.

Windows Vista is either a registered trademark or a trademark of Microsoft Corporation in the United States and other countries.

Apple, Macintosh, Safari and TrueType are trademarks of Apple Inc., registered in the United States and other countries.

Intel, Intel Core and Pentium are trademarks of Intel Corporation in the U.S. and other countries.

AMD is a trademark of Advanced Micro Devices, Inc.

Adobe, Flash, Illustrator, PageMaker, Photoshop, PostScript and PostScript 3 are either registered trademarks or trademarks of Adobe Systems Incorporated in the United States and/or other countries.

Epson is a registered trademark and FX-80 and FX-850 are trademarks of Seiko Epson Corporation.

IBM® is either a registered trademark or a trademark of International Business Machines Corporation in the United States and/or other countries.

Nuance, the Nuance logo, PaperPort and ScanSoft are trademarks or registered trademarks of Nuance Communications, Inc. or its affiliates in the United States and/or other countries.

All other trademarks are the property of their respective owners.

Optional paper tray (LT-5300) (MFC-8380DN)

An optional lower tray can be installed, and it can hold up to 250 sheets of 80 g/m² paper.

When an optional tray is installed, the machine can hold up to 550 sheets of plain paper. If you want to buy an optional lower tray unit, contact your Brother dealer

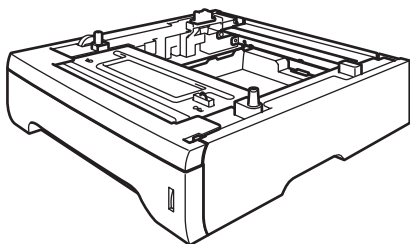

For setup, see the instructions that we have supplied with the lower tray unit.

Memory board

This machine has 64 MB of standard memory and one slot for optional memory expansion. You can expand the memory up to 576 MB by installing small outline dual in-line memory modules (SO-DIMMs). When you add the optional memory, it increases the performance for both copier and printer operations.

In general, the machine uses industry-standard SO-DIMMs with the following specifications:

Type: 144 pin and 64 bit output

CAS latency: 2

Clock frequency: 100 MHz or more

Capacity: 64, 128, 256 or 512 MB

Height: 31.75 mm

Dram Type: SDRAM 2 Bank

For purchasing information and part numbers visit the Buffalo Technology website:

<http://www.buffalo-technology.com/>



Note

- There may be some SO-DIMMs that will not work with the machine.
- For more information, contact your Brother dealer.

Installing extra memory

- 1 Turn off the machine's power switch. Unplug the telephone line cord.
- 2 Disconnect the interface cable from the machine, and then unplug the power cord from the electrical socket.



Note

Be sure to turn off the machine's power switch before you install or remove the SO-DIMM.

- 3 Remove the SO-DIMM cover and interface access cover.

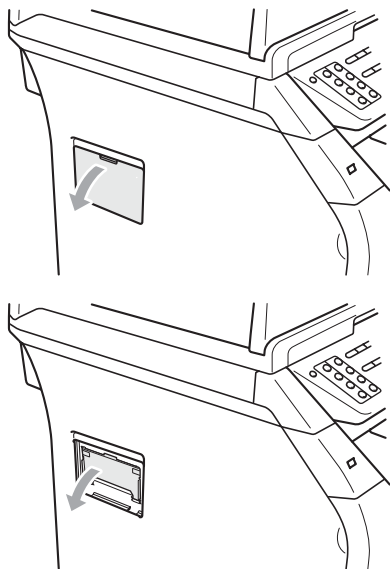

- 4 Unpack the SO-DIMM and hold it by its edges.

! IMPORTANT

To prevent damage to the machine from static electricity, DO NOT touch the memory chips or the board surface.

- 5 Hold the SO-DIMM by the edges and align the notches in the SO-DIMM with the protrusions in the slot. Insert the SO-DIMM diagonally (1), then tilt it toward the interface board until it clicks into place (2).

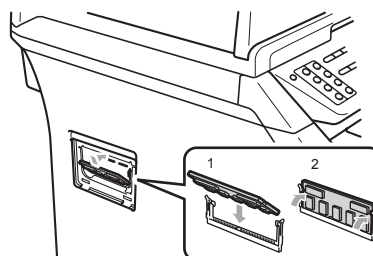

- 6 Put the interface access cover and the SO-DIMM cover back on.
- 7 Plug the machine's power cord back into the electrical socket first, and then connect the interface cable.
- 8 Plug in the telephone line cord. Turn on the machine's power switch.



Note

To make sure that you have installed the SO-DIMM properly, you can print the user settings page that shows the current memory size. (See *How to print a report* on page 75)

Troubleshooting

If you think there is a problem with your machine, check the chart below and follow the troubleshooting tips.

Most problems can be easily resolved by yourself. If you need additional help, the Brother Solutions Center offers the latest FAQs and troubleshooting tips. Visit us at <http://solutions.brother.com/>.

If you are having difficulty with your machine

If you think there is a problem with the way your faxes look, make a copy first. If the copy looks good, the problem may not be your machine. Check the chart below and follow the troubleshooting tips.

Printing or receiving faxes

Difficulties	Suggestions
<ul style="list-style-type: none"> ■ Condensed print ■ Horizontal streaks ■ Top and bottom sentences are cut off ■ Missing lines 	Usually this is caused by a poor telephone connection. If your copy looks good, you probably had a bad connection, with static or interference on the telephone line. Ask the other party to send the fax again.
Poor print quality	See <i>Improving the print quality</i> on page 120.
Vertical black lines when receiving	The corona wire for printing may be dirty. Clean the corona wire. (See <i>Cleaning the corona wire</i> on page 145.)
	The sender's scanner may be dirty. Ask the sender to make a copy to see if the problem is with the sending machine. Try receiving from another fax machine.
	If the problem continues, call your dealer for service.
Received faxes appear as split or blank pages.	If the received faxes are divided and printed on two pages or if you get an extra blank page, your paper size setting may not be correct for the paper you are using. (See <i>Paper Size</i> on page 23.)
	Turn on Auto Reduction. (See <i>Printing a reduced incoming fax</i> on page 51.)

Telephone line or connections

Difficulties	Suggestions
Dialling does not work.	Check for a dial tone.
	Change <i>Tone/Pulse</i> setting. (See the <i>Quick Setup Guide</i> .)
	Check all line cord connections.
	Check that the machine is plugged in and switched on.
	If an external phone is connected to the machine, send a manual fax by lifting the handset of the external telephone and dialling the number. Wait to hear the fax receiving tones before pressing Start .
Key operations do not work.	Check the control panel is fitted correctly on the machine. Reinstall the control panel.

Telephone line or connections (continued)

Difficulties	Suggestions
The machine does not answer when called.	Make sure the machine is in the correct receive mode for your setup. (See <i>Receiving a fax</i> on page 47.) Check for a dial tone. If possible, call your machine to hear it answer. If there is still no answer, check the telephone line cord connection. If you do not hear ringing when you call your machine, ask your telephone company to check the line.

Receiving Faxes

Difficulties	Suggestions
Cannot receive a fax.	<p>Check all line cord connections. Make sure the telephone line cord is plugged into the telephone wall jack and the LINE jack of the machine. If you subscribe to DSL or VoIP services, please contact your service provider for connection instructions.</p> <p>Make sure the machine is in the correct Receive Mode. This is determined by the external devices and telephone subscriber services you have on the same line as the Brother machine. (See <i>Receive Mode settings</i> on page 49.)</p> <p>If you have a dedicated fax line and want your Brother machine to automatically answer all incoming faxes, you should select Fax Only mode.</p> <p>If your Brother machine shares a line with an external answering machine, you should select the External TAD mode. In External TAD mode, your Brother machine will automatically receive incoming faxes and voice callers will be able to leave a message on your answering machine.</p> <p>If your Brother machine shares a line with other telephones and you want it to automatically answer all incoming faxes, you should select the Fax/Te1 mode. In Fax/Te1 mode, your Brother machine will automatically receive faxes and produce a pseudo/double-ring to alert you to answer voice calls.</p> <p>If you do not want your Brother machine to automatically answer any incoming faxes, you should select the Manual mode. In Manual mode, you must answer every incoming call and activate the machine to receive faxes.</p> <p>Another device or service at your location may be answering the call before your Brother machine answers. To test this, lower the ring delay setting:</p> <ul style="list-style-type: none"> ■ If the answer mode is set to Fax Only or Fax/Te1, reduce the ring delay to 1 ring. (See <i>Ring Delay</i> on page 49.) ■ If the answer mode is set to External TAD, reduce the number of rings programmed on your answering machine to 2. ■ If the answer mode is set to Manual, <i>do not</i> adjust the ring delay setting. <p>Have someone send you a test fax:</p> <ul style="list-style-type: none"> ■ If you received the test fax successfully, your machine is operating properly. Remember to reset your ring delay or answering machine setting back to your original setting. If receiving problems recur after resetting the ring delay, then a person, device, or subscriber service is answering the fax call before the machine has a chance to answer. ■ If you were not able to receive the fax, then another device or subscriber service may be interfering with your fax reception or there may be a problem with your fax line.

Receiving Faxes (continued)

Difficulties	Suggestions
Cannot receive a fax. (continued)	<p>If you are using a telephone answering machine (External TAD mode) on the same line as the Brother machine, make sure your answering machine is set up correctly. (See <i>Connecting an external TAD</i> on page 54.)</p> <ol style="list-style-type: none"> 1 Connect the external TAD as shown in the illustration on page 55. 2 Set your answering machine to answer in one or two rings. 3 Record the outgoing message on your answering machine. <ul style="list-style-type: none"> ■ Record five seconds of silence at the beginning of your outgoing message. ■ Limit your speaking to 20 seconds. ■ End your outgoing message with your Fax Receive Code for people sending manual faxes. For example: "After the beep, leave a message or press *51 and Start to send a fax." 4 Set your answering machine to answer calls. 5 Set your Brother machine's Receive Mode to External TAD. (See <i>Receive Mode settings</i> on page 49.) <p>Make sure your Brother machine's Fax Detect feature is turned On. Fax Detect is a feature that allows you to receive a fax even if you have answered the call on an external or extension telephone. (See <i>Fax Detect</i> on page 50.)</p> <p>If you often get transmission errors due to possible interference on the telephone line, try changing the Compatibility setting to Basic (for VoIP). (See <i>Telephone line interference</i> on page 127.)</p> <p>(MFC-8380DN) Contact your administrator to check your Secure Function Lock Settings.</p>

Sending faxes

Difficulties	Suggestions
Poor sending quality.	Try changing your resolution to Fine or S. Fine. Make a copy to check your machine's scanner operation. If the copy quality is not good, clean the scanner. (See <i>Cleaning the scanner</i> on page 143.)
Transmission Verification Report says RESULT:ERROR.	<p>There is probably temporary noise or static on the line. Try sending the fax again. If you are sending a PC Fax message and get RESULT:ERROR on the Transmission Verification Report, your machine may be out of memory. To free up extra memory, you can turn off fax storage (See <i>Turning off Remote Fax Options</i> on page 67), print fax messages in memory (See <i>Out of Paper Reception</i> on page 52) or cancel a delayed fax or polling job (See <i>Checking and cancelling waiting jobs</i> on page 45). If the problem continues, ask the telephone company to check your telephone line.</p> <p>If you often get transmission errors due to possible interference on the telephone line, try changing the Compatibility setting to Basic (for VoIP). (See <i>Telephone line interference</i> on page 127.)</p>
Vertical black lines when sending.	Black vertical lines on faxes you send are typically caused by dirt or correction fluid on the glass strip. (See <i>Cleaning the scanner</i> on page 143.)
The machine does not scan all the pages of your document.	Make sure that the ADF output tray does not contain more than 20 sheets.
Cannot send a fax.	(MFC-8380DN) Contact your administrator to check your Secure Function Lock Settings.

Handling incoming calls

Difficulties	Suggestions
The machine 'Hears' a voice as a CNG Tone.	If Fax Detect is set to On, your machine is more sensitive to sounds. It may mistakenly interpret certain voices or music on the line as a fax machine calling and respond with fax receiving tones. Deactivate the machine by pressing Stop/Exit . Try avoiding this problem by turning Fax Detect to Off. (See <i>Fax Detect</i> on page 50.)
Sending a Fax Call to the machine.	If you answered on an external or extension telephone, press your Remote Activation Code (default setting is *51). When your machine answers, hang up.
Custom features on a single line.	If you have Call Waiting, Call Waiting/Caller ID, Caller ID, Voice Mail, an answering machine, an alarm system or other custom feature on a single telephone line with your machine, it may create a problem sending or receiving faxes. For Example: If you subscribe to Call Waiting or some other custom service and its signal comes through the line while your machine is sending or receiving a fax, the signal can temporarily interrupt or disrupt the faxes. Brother's ECM feature should help overcome this problem. This condition is related to the telephone system industry and is common to all devices that send and receive information on a single, shared line with custom features. If avoiding a slight interruption is crucial to your business, a separate line with no custom features is recommended.

Menu access difficulties

Difficulties	Suggestions
The machine beeps when you try to access the Setup Receive and Setup Send menus.	If Fax  is not illuminated, press it to turn on Fax mode. The Setup Receive setting (Menu, 2, 1) and Setup Send setting (Menu, 2, 2) are available only when the machine is in Fax mode.

Copy difficulties

Difficulties	Suggestions
Cannot make a copy	<ul style="list-style-type: none"> ■ Make sure that Copy  is illuminated. (See <i>Entering copy mode</i> on page 78) ■ Contact your administrator to check your Secure Function Lock settings.
Vertical black line appears in copies.	Black vertical lines on copies are typically caused by dirt or correction fluid on the glass strip, or the corona wire for printing is dirty. (See <i>Cleaning the scanner</i> on page 143 and <i>Cleaning the corona wire</i> on page 145.)
The machine does not scan all the pages of your document.	Make sure that the ADF output tray does not contain more than 20 sheets.

Printing difficulties

Difficulties	Suggestions
No printout.	<ul style="list-style-type: none"> ■ Check that the machine is plugged in and the power switch is turned on. ■ Check that the toner cartridge and drum unit are installed correctly. (See <i>Replacing the drum unit</i> on page 153.) ■ Check the interface cable connection on both the machine and your computer. (See the <i>Quick Setup Guide</i>.) ■ Check that the correct printer driver has been installed and chosen. ■ Check to see if the LCD is showing an error message. (See <i>Error and maintenance messages</i> on page 128.) ■ Check the machine is online: (Windows® Vista®) Click the Start button, Control Panel, Hardware and Sound, and then Printers. Right-click Brother MFC-XXXX Printer. Make sure that Use Printer Offline is unchecked. (Windows® XP and Windows Server® 2003) Click the Start button and choose Printers and Faxes. Right-click Brother MFC-XXXX Printer. Make sure that Use Printer Offline is unchecked. (Windows® 2000) Click the Start button and choose Settings and then Printers. Right-click Brother MFC-XXXX Printer. Make sure that Use Printer Offline is unchecked. ■ Contact your administrator to check your Secure Function Lock settings.
The machine prints unexpectedly or it prints garbage.	<ul style="list-style-type: none"> ■ Pull out the paper tray and wait until the machine stops printing. Then turn off the machine and disconnect from the power for several minutes. (The machine can be turned off for up to 60 hours without losing faxes stored in the memory.) ■ Check the settings in your application to make sure it is set up to work with your machine.
The machine prints the first couple of pages correctly, then some pages have text missing.	<ul style="list-style-type: none"> ■ Check the settings in your application to make sure that it is set up to work with your machine. ■ Your computer is not recognising the machine's input buffer's full signal. Make sure that you connected the interface cable correctly. (See the <i>Quick Setup Guide</i>.)
The headers or footers appear when the document displays on the screen but they do not show up when it is printed.	There is an unprintable area on the top and bottom of the page. Adjust the top and bottom margins in your document to allow for this.
The machine does not print on both sides of the paper even though the printer driver setting is Duplex.	Check the paper size setting in the printer driver. You need to choose A4 size of paper (60 to 105 g/m ²).
The machine is not printing or has stopped printing and the machine's Data LED is on.	<p>Press Job Cancel.</p> <p>As the machine cancels the job and clears it from the memory it may produce an incomplete printout.</p>

Scanning difficulties

Difficulties	Suggestions
TWAIN errors appear while scanning.	Make sure that the Brother TWAIN driver is chosen as the primary source. In PaperPort™ 11SE, click File, Scan or Get Photo and choose the Brother TWAIN driver .
OCR does not work	Try increasing the scanning resolution.
Network scanning does not work.	See <i>Network difficulties</i> on page 117.
The machine does not scan all the pages of your document.	Make sure that the ADF output tray does not contain more than 20 sheets.

Software difficulties

Difficulties	Suggestions
Cannot install software or print.	Run the Repair MFL-Pro Suite program on the CD-ROM. This program will repair and reinstall the software.
Cannot perform '2 in 1' or '4 in 1' printing.	Check that the paper size setting in the application and in the printer driver are the same.
The machine does not print from Adobe® Illustrator®.	Try to reduce the print resolution. (See <i>Advanced tab</i> in the <i>Software User's Guide</i> on the CD-ROM.)

Paper handling difficulties

Difficulties	Suggestions
The machine does not load paper. The LCD shows No Paper or a Paper Jam message.	<ul style="list-style-type: none"> ■ If there is no paper, load a new stack of paper into the paper tray. ■ If there is paper in the paper tray, make sure it is straight. If the paper is curled, you should straighten it. Sometimes it is helpful to remove the paper, turn the stack over and put it back into the paper tray. ■ Reduce the amount of paper in the paper tray, and then try again. ■ Check that the MP tray mode is not chosen in the printer driver. ■ If the LCD shows Paper Jam message and you still have a problem, see <i>Paper jams</i> on page 135.
The machine does not feed paper from the MP tray.	<ul style="list-style-type: none"> ■ Fan the paper well and put it back in the tray firmly. ■ Make sure that MP tray mode is chosen in the printer driver.
How do I print on envelopes?	You can load envelopes from the MP tray. Your application must be set up to print the envelope size you are using. This is usually done in the Page Setup or Document Setup menu of your application. (See your application's manual for more information.)
What paper can I use?	You can use thin paper, plain paper, thick paper, bond paper, recycled paper, envelopes, labels and transparencies that are made for laser machines. (For details, see <i>Acceptable paper and other print media</i> on page 14.)
There is a paper jam.	(See <i>Paper jams</i> on page 135.)
The scanned documents jam on the ADF output tray.	<ul style="list-style-type: none"> ■ Make sure your documents are not too thin or too thick and are correctly loaded in the ADF. (See <i>Loading documents</i> on page 20.) ■ Use the scanner glass to scan the document.

Print quality difficulties

Difficulties	Suggestions
Printed pages are curled.	<ul style="list-style-type: none"> ■ Low quality thin or thick paper or not printing on the recommended side of the paper could cause this problem. Try turning over the stack of paper in the paper tray. ■ Make sure that you choose the Paper Type that suits the print media type you are using. (See <i>Acceptable paper and other print media</i> on page 14.)
Printed pages are smeared.	The Paper Type setting may be incorrect for the type of print media you are using, or the print media may be too thick or have a rough surface. (See <i>Acceptable paper and other print media</i> on page 14 and <i>Basic tab</i> in the <i>Software User's Guide</i> on the CD-ROM.)
Printouts are too light.	<ul style="list-style-type: none"> ■ If this problem occurs when making copies or printing received faxes, set Toner Save mode to Off in the machine menu settings. (See <i>Toner Save</i> on page 26.) ■ Set Toner Save mode to Off in the Advanced tab in the printer driver. (See <i>Advanced tab</i> in the <i>Software User's Guide</i> on the CD-ROM.)

Network difficulties

Difficulties	Suggestions
Cannot print over a wired Network.	<p>If you are having Network problems see the <i>Network User's Guide</i> on the CD-ROM for more information.</p> <p>Make sure your machine is powered on and is on-line and in the Ready mode. Print the Network Configuration list to see your current Network settings. (See <i>How to print a report</i> on page 75.) Reconnect the LAN cable to the hub to verify that the cable and network connections are good. If possible, try connecting the machine to a different port on your hub using a different cable. If the connections are good, the lower LED of the back panel of the machine will be green.</p>





Network difficulties (continued)

Difficulties	Suggestions
<p>The network scanning feature does not work.</p> <p>The network PC Fax Receive feature does not work.</p> <p>The network printing feature does not work.</p>	<p>(Windows®) The firewall setting on your PC may be rejecting the necessary network connection. Follow the instructions below to configure Windows® Firewall. If you are using other personal firewall software, see the User's Guide for your software or contact the software manufacturer.</p> <p>(Windows® XP SP2)</p> <ol style="list-style-type: none"> 1 Click the Start button, Control Panel, Network and Internet Connections and then Windows Firewall. Make sure that Windows Firewall on the General tab is set to On. 2 Click the Advanced tab and Settings... button of the Network Connection Settings. 3 Click the Add button. 4 To add port 54925 for network scanning, enter the information below: <ol style="list-style-type: none"> 1. In Description of service: Enter any description, for example "Brother Scanner". 2. In Name or IP address (for example 192.168.0.12) of the computer hosting this service on your network: Enter "Localhost". 3. In External Port number for this service: Enter "54925". 4. In Internal Port number for this service: Enter "54925". 5. Make sure UDP is chosen. 6. Click OK. 5 Click the Add button. 6 To add port 54926 for network PC Fax, enter the information below: <ol style="list-style-type: none"> 1. In Description of service: Enter any description, for example "Brother PC Fax". 2. In Name or IP address (for example 192.168.0.12) of the computer hosting this service on your network: Enter "Localhost". 3. In External Port number for this service: Enter "54926". 4. In Internal Port number for this service: Enter "54926". 5. Make sure UDP is chosen. 6. Click OK. 7 If you still have trouble with your network connection, click the Add button. 8 To add port 137 for network scanning, network printing and network PC Fax receiving, enter the information below: <ol style="list-style-type: none"> 1. In Description of service: - Enter any description, for example "Brother PC Fax receiving" 2. In Name or IP address (for example 192.168.0.12) of the computer hosting this service on your network: Enter "Localhost". 3. In External Port number for this service: Enter "137". 4. In Internal Port number for this service: Enter "137". 5. Make sure UDP is chosen. 6. Click OK. 9 Make sure if the new setting is added and is checked, and then click OK.

Network difficulties (continued)

Difficulties	Suggestions
<p>The network scanning feature does not work.</p> <p>The network PC Fax Receive feature does not work.</p> <p>The network printing feature does not work.</p> <p>(continued)</p>	<p>(Windows Vista®):</p> <ol style="list-style-type: none"> 1 Click the Start button, Control Panel, Network and Internet, Windows Firewall and click Change settings. 2 When the User Account Control screen appears, do the following. <ul style="list-style-type: none"> ■ Users who have administrator rights: Click Continue. ■ For users who do not have administrator rights: Enter the administrator password and click OK. 3 Make sure that Windows Firewall on the General tab is set to On. 4 Click the Exceptions tab. 5 Click the Add port... button. 6 To add port 54925 for network scanning, enter the information below: <ol style="list-style-type: none"> 1. In Name: Enter any description. (for example "Brother Scanner") 2. In Port number: Enter "54925". 3. Make sure UDP is chosen. Then click OK. 7 Click the Add port... button. 8 To add port 54926 for Network PC Fax, enter the information below: <ol style="list-style-type: none"> 1. In Name: Enter any description. (for example "Brother PC Fax") 2. In Port number: Enter "54926". 3. Make sure UDP is chosen. Then click OK. 9 Make sure that the new setting is added and is checked, and then click Apply. 10 If you still have trouble with your network connection such as network scanning or printing, check File and Printer Sharing box in the Exceptions tab and then click Apply.
<p>Your computer cannot find your machine.</p>	<p>(Windows®) The firewall setting on your PC may be rejecting the necessary network connection. (For details, see the instructions above.)</p> <p>(Macintosh) Re-select your machine in the Device Selector application located in Macintosh HD/Library/Printers/Brother/Utilities/DeviceSelector or from the Model pop-up menu of ControlCenter2.</p>

Improving the print quality

Examples of poor print quality	Recommendation
 <p>White lines across the page</p>	<ul style="list-style-type: none"> ■ Make sure that you use paper that meets our specifications. A rough surfaced paper or thick print media can cause the problem. (See <i>Acceptable paper and other print media</i> on page 14.) ■ Make sure that you choose the appropriate media type in the printer driver or in the machine's Paper Type menu setting. (See <i>Acceptable paper and other print media</i> on page 14 and <i>Basic tab</i> in the <i>Software User's Guide</i> on the CD-ROM.) ■ The problem may disappear by itself. Print multiple pages to clear this problem, especially if the machine has not been used for a long time. ■ The drum unit may be damaged. Put in a new drum unit. (See <i>Replacing the drum unit</i> on page 153.)
 <p>White lines down the page</p>	<ul style="list-style-type: none"> ■ Wipe the laser scanner windows with a dry, lint-free soft cloth. (See <i>Cleaning the laser scanner window</i> on page 144.) ■ Make sure that a torn sheet of paper is not inside the machine covering the scanner window. ■ The toner cartridge may be damaged. Put in a new toner cartridge. (See <i>Replacing a toner cartridge</i> on page 150.) ■ The drum unit may be damaged. Put in a new drum unit. (See <i>Replacing the drum unit</i> on page 153.)
 <p>Hollow print</p>	<ul style="list-style-type: none"> ■ Make sure that you use paper that meets our specifications. (See <i>Acceptable paper and other print media</i> on page 14.) ■ Choose Thick paper mode in the printer driver, choose Thick in the machine's Paper Type menu setting or use thinner paper than you are currently using. (See <i>Paper Type</i> on page 22 and <i>Basic tab</i> in the <i>Software User's Guide</i> on the CD-ROM.) ■ Check the machine's environment. Conditions such as high humidity can cause hollow print. (See <i>Choosing a location</i> on page 98.) ■ The drum unit may be damaged. Put in a new drum unit. (See <i>Replacing the drum unit</i> on page 153.)
 <p>Grey background</p>	<ul style="list-style-type: none"> ■ Make sure that you use paper that meets our specifications. (See <i>Acceptable paper and other print media</i> on page 14.) ■ Check the machine's environment. Conditions such as high temperatures and high humidity can increase the amount of background shading. (See <i>Choosing a location</i> on page 98.) ■ The toner cartridge may be damaged. Put in a new toner cartridge. (See <i>Replacing a toner cartridge</i> on page 150.) ■ The drum unit may be damaged. Put in a new drum unit. (See <i>Replacing the drum unit</i> on page 153.)

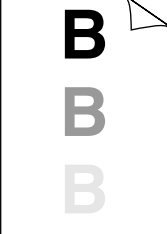
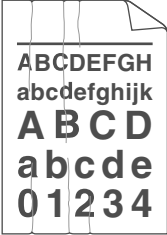
Examples of poor print quality	Recommendation
 <p data-bbox="234 552 385 581">Page skewed</p>	<ul style="list-style-type: none"> <li data-bbox="506 295 1252 382">■ Make sure that the paper or other print media is loaded correctly in the paper tray and that the guides are not too tight or too loose against the paper stack. <li data-bbox="506 397 1252 455">■ Set the paper guides correctly. (See <i>Loading paper in the standard paper tray</i> on page 10.) <li data-bbox="506 471 1252 529">■ If you are using the MP tray, see <i>Loading paper in the multi-purpose tray (MP tray)</i> on page 11. <li data-bbox="506 544 858 573">■ The paper tray may be too full. <li data-bbox="506 589 1252 637">■ Check the paper type and quality. (See <i>Acceptable paper and other print media</i> on page 14.)
 <p data-bbox="275 913 344 942">Ghost</p>	<ul style="list-style-type: none"> <li data-bbox="506 653 1252 739">■ Make sure that you use paper that meets our specifications. Rough-surfaced paper or thick paper may cause the problem. (See <i>Acceptable paper and other print media</i> on page 14.) <li data-bbox="506 755 1252 861">■ Make sure that you choose the correct media type in the printer driver or in the machine's Paper Type menu setting. (See <i>Acceptable paper and other print media</i> on page 14 and <i>Basic tab</i> in the <i>Software User's Guide</i> on the CD-ROM.) <li data-bbox="506 877 1188 935">■ The drum unit may be damaged. Put in a new drum unit. (See <i>Replacing the drum unit</i> on page 153.) <li data-bbox="506 950 1215 1008">■ The fuser unit may be contaminated. Call your Brother dealer for service.
 <p data-bbox="196 1282 423 1311">Wrinkles or creases</p>	<ul style="list-style-type: none"> <li data-bbox="506 1022 1252 1079">■ Check the paper type and quality. (See <i>Acceptable paper and other print media</i> on page 14.) <li data-bbox="506 1095 1252 1153">■ Make sure that paper is loaded correctly. (See <i>Loading paper in the standard paper tray</i> on page 10.) <li data-bbox="506 1168 1252 1226">■ Turn over the stack of paper in the paper tray or rotate the paper 180° in the paper tray.

Examples of poor print quality

Recommendation



Envelope creases

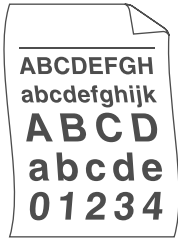
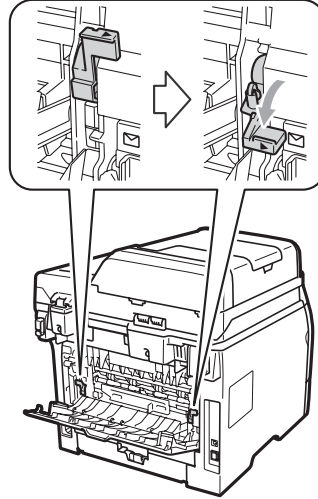

- Make sure that the envelope levers inside the back cover are pulled down when you print the envelopes.



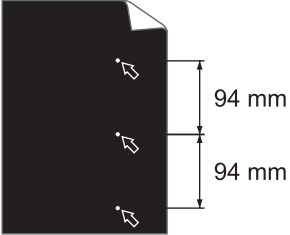
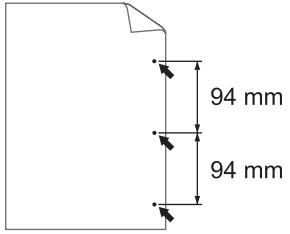

Curled or wavy

- Check the paper type and quality. High temperatures and high humidity will cause paper to curl.
- If you do not use the machine often, the paper may have been in the paper tray too long. Turn over the stack of paper in the paper tray. Also, fan the paper stack and then rotate the paper 180° in the paper tray.

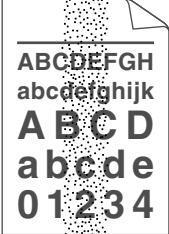
Examples of poor print quality	Recommendation
<div data-bbox="234 305 385 542" style="border: 1px solid black; padding: 10px; text-align: center;"> <p>ABCDEF GH abcdefghijk ABCD abcde 01234</p> </div> <p data-bbox="271 566 348 591" style="text-align: center;">Curled</p>	<ul style="list-style-type: none"> ■ Turn the paper over in the paper tray, and print again. (excluding Letterhead paper) If the problem remains, slide the Anti-Curl Switch as follows: <ol style="list-style-type: none"> 1 Open the back cover. <div data-bbox="738 446 1012 710" style="text-align: center;"> </div> <ol style="list-style-type: none"> 2 With one hand, use the tab (1) to lift the roller assembly, then use your other hand to slide the Anti-Curl Switch (2) in the direction of the arrow. <div data-bbox="642 842 1103 1280" style="text-align: center;"> </div> <ol style="list-style-type: none"> 3 Close the back cover. <ul style="list-style-type: none"> ■ Lift up the Output Tray Support Flap (1). <div data-bbox="666 1387 1089 1686" style="text-align: center;"> </div> <ul style="list-style-type: none"> ■ Choose Reduce Paper Curl mode in the printer driver. (See <i>Other Print Options</i> (For Windows®) or <i>Print Settings</i> (For Macintosh) in the <i>Software User's Guide</i> on the CD-ROM.)

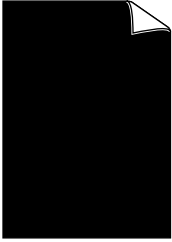
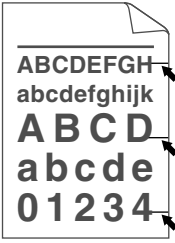
Examples of poor print quality	Recommendation
 <p>White Spots on black text and graphics at 94 mm intervals</p>  <p>Black Spots at 94 mm intervals</p>	<ul style="list-style-type: none"> ■ Make ten copies of a blank, white sheet of paper. (See <i>Making multiple copies</i> on page 78.) If the problem is not solved, the drum unit may have glue from a label stuck on the OPC drum surface. Clean the drum unit. (See <i>Cleaning the drum unit</i> on page 146.) ■ The drum unit may be damaged. Put in a new drum. (See <i>Replacing the drum unit</i> on page 153.)
 <p>Faint</p>	<ul style="list-style-type: none"> ■ Check the machine's environment. Conditions such as humidity, high temperatures, and so on, may cause this print fault. (See <i>Choosing a location</i> on page 98.) ■ If the whole page is too light, Toner Save mode may be on. Turn off Toner Save mode in the machine menu settings or Toner Save mode in the printer Properties of the driver. (See <i>Toner Save</i> on page 26 or <i>Advanced tab</i> in the <i>Software User's Guide</i> on the CD-ROM.) ■ Clean the scanner window and the corona wire of the drum unit. (See <i>Cleaning the laser scanner window</i> on page 144 and <i>Cleaning the corona wire</i> on page 145.) ■ The toner cartridge may be damaged. Put in a new toner cartridge. (See <i>Replacing a toner cartridge</i> on page 150.) ■ The drum unit may be damaged. Put in a new drum unit. (See <i>Replacing the drum unit</i> on page 153.)
 <p>Toner specks</p>	<ul style="list-style-type: none"> ■ Make sure that you use paper that meets our specifications. Rough-surfaced paper may cause the problem. (See <i>Acceptable paper and other print media</i> on page 14.) ■ Clean the corona wire and the drum unit. (See <i>Cleaning the corona wire</i> on page 145 and <i>Cleaning the drum unit</i> on page 146.) ■ The drum unit may be damaged. Put in a new drum unit. (See <i>Replacing the drum unit</i> on page 153.) ■ The fuser unit may be contaminated. Call your Brother dealer for service.

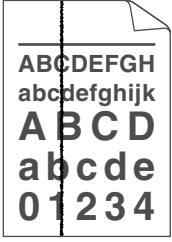
Examples of poor print quality	Recommendation
 <p data-bbox="257 556 362 583">All black</p>	<ul style="list-style-type: none"> <li data-bbox="504 293 1251 382">■ Clean the corona wire inside the drum unit by sliding the blue tab. Be sure to return the blue tab to the home position (▲). (See <i>Cleaning the corona wire</i> on page 145.) <li data-bbox="504 394 1190 452">■ The drum unit may be damaged. Put in a new drum unit. (See <i>Replacing the drum unit</i> on page 153.) <li data-bbox="504 463 1218 521">■ The fuser unit may be contaminated. Call your Brother dealer for service.
 <p data-bbox="142 857 471 915">Black toner marks across the page</p>	<ul style="list-style-type: none"> <li data-bbox="504 598 1226 656">■ Make sure that you use paper that meets our specifications. (See <i>Acceptable paper and other print media</i> on page 14.) <li data-bbox="504 668 1251 757">■ If you use label sheets for laser machines, the glue from the sheets may sometimes stick to the OPC drum surface. Clean the drum unit. (See <i>Cleaning the drum unit</i> on page 146.) <li data-bbox="504 768 1251 826">■ Do not use paper that has clips or staples because they will scratch the surface of the drum. <li data-bbox="504 838 1245 896">■ If the unpacked drum unit is in direct sunlight or room light, the unit may be damaged. <li data-bbox="504 908 1240 966">■ The toner cartridge may be damaged. Put in a new toner cartridge. (See <i>Replacing a toner cartridge</i> on page 150.) <li data-bbox="504 977 1190 1035">■ The drum unit may be damaged. Put in a new drum unit. (See <i>Replacing the drum unit</i> on page 153.)
 <p data-bbox="189 1313 430 1340">Line across the page</p>	<ul style="list-style-type: none"> <li data-bbox="504 1054 1251 1143">■ Clean the laser scanner window and the corona wire inside the drum unit. (See <i>Cleaning the laser scanner window</i> on page 144 and <i>Cleaning the corona wire</i> on page 145.) <li data-bbox="504 1155 1190 1213">■ The drum unit may be damaged. Put in a new drum unit. (See <i>Replacing the drum unit</i> on page 153.)
 <p data-bbox="156 1615 463 1711">Black lines down the page Printed pages have toner stains down the page</p>	<ul style="list-style-type: none"> <li data-bbox="504 1356 1251 1445">■ Clean the corona wire inside the drum unit by sliding the blue tab. Be sure to return the blue tab to the home position (▲). (See <i>Cleaning the corona wire</i> on page 145.) <li data-bbox="504 1456 1240 1514">■ The toner cartridge may be damaged. Put in a new toner cartridge. (See <i>Replacing a toner cartridge</i> on page 150.) <li data-bbox="504 1526 1190 1584">■ The drum unit may be damaged. Put in a new drum unit. (See <i>Replacing the drum unit</i> on page 153.) <li data-bbox="504 1595 1256 1622">■ The fuser unit may be smudged. Call your Brother dealer for service.

Examples of poor print quality

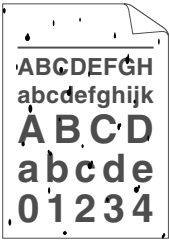

Poor fixing

Recommendation

- Open the back cover and make sure that the two blue levers on the left and right hand sides are in the up position.



- Choose **Improve Toner Fixing** mode in the printer driver. (See *Other Print Options* (For Windows®) or *Print Settings* (For Macintosh) in the *Software User's Guide* on the CD-ROM.)

If this selection does not provide enough improvement, choose **Thicker Paper** in **Media Type** settings.

Setting Dial Tone detection

When you send a fax automatically, by default your machine will wait for a fixed amount of time before it starts to dial the number. By changing the Dial Tone setting to `Detection` you can make your machine dial as soon as it detects a dial tone. This setting can save a small amount of time when sending a fax to many different numbers. If you change the setting and start having problems with dialling you should change back to the default `No Detection` setting.

- 1 Press **Menu**, **0**, **5**.
- 2 Press **▲** or **▼** to choose `Detection` or `No Detection`. Press **OK**.
- 3 Press **Stop/Exit**.

Telephone line interference

If you are having difficulty sending or receiving a fax due to possible interference on the telephone line, we recommend that you adjust the Equalization for compatibility to reduce the modem speed for fax operations.

- 1 Press **Menu**, **2**, **0**, **1**.
- 2 Press **▲** or **▼** to choose `Basic (for VoIP)`, `Normal` or `High`.

- `Basic (for VoIP)` cuts the modem speed to 9600 bps. and turns the error correction mode (ECM) off.

For a standard telephone line: If you regularly experience interference on your standard telephone line try this setting.

If you are using VoIP: VoIP service providers offer fax support using various standards. If you regularly experience fax transmission errors try this setting.

- `Normal` sets the modem speed at 14400 bps.
- `High` sets the modem speed at 33600 bps.

Press **OK**.

- 3 Press **Stop/Exit**.



Note

When you change the Compatibility to `Basic (for VoIP)`, the ECM feature is not available.

Error and maintenance messages

As with any sophisticated office product, errors may occur and consumable items may need to be replaced. If this happens, your machine identifies the error or required routine maintenance and shows the appropriate message. The most common error and maintenance messages are shown below.

You can clear most errors and perform routine maintenance messages by yourself. If you need more help, the Brother Solutions Center offers the latest FAQs and troubleshooting tips.

Visit us at <http://solutions.brother.com/>.

Error Message	Cause	Action
20 Sheet Limit	The ADF output tray has reached its maximum capacity.	Do one of the following: <ul style="list-style-type: none"> ■ To send the pages scanned so far, press 1.Send. ■ To delete the scanned pages, press 2.Delete. If you send the pages already scanned and want to send the remaining pages, remove the scanned sheets from the ADF output tray, then dial the fax number (if you are sending a fax) and press Start .
Access Error	The device is removed from the USB direct interface while the data is processing.	Press Stop/Exit . Reinsert the device and try to print with Direct Print.
BT Call Sign On (U.K. only)	BT Call Sign is set to On. You cannot change the Receive Mode from Manual to another mode.	Set BT Call Sign to Off. (See <i>BT Call Sign (U.K. only)</i> on page 54.)
Cartridge Error	The toner cartridge is not installed correctly.	Pull out the drum unit, take out the toner cartridge and put it back into the drum unit again.
Comm. Error	Poor telephone line quality caused a communication error.	Try sending the fax again or try connecting the machine to another telephone line. If the problem continues, call the telephone company and ask them to check your telephone line.
Connection Fail	You tried to poll a fax machine that is not in Polled Waiting mode.	Check the other fax machine's polling setup.

Error Message	Cause	Action
Cooling Down Wait for a while	The temperature of the drum unit or toner cartridge is too hot. The machine will pause its current print job and go into cooling down mode. During the cooling down mode, you will hear the cooling fan running while the LCD shows <i>Cooling Down</i> , and <i>Wait for a while</i> .	Make sure that you can hear the fan in the machine spinning and that the exhaust outlet is not blocked by something. If the fan is spinning, remove any obstacles that surround the exhaust outlet, and then leave the machine turned on but do not use it for several minutes. If the fan is not spinning disconnect the machine from the power for several minutes, then reconnect it. (The machine can be turned off for up to 60 hours without losing faxes stored in the memory. See <i>Transferring your faxes or Fax Journal report</i> on page 133.)
Cover is Open	The front cover is not closed completely.	Close the front cover of the machine.
Cover is Open	The fuser cover is not closed completely or paper was jammed in the back of the machine when you turned on the power.	<ul style="list-style-type: none"> ■ Close the fuser cover of the machine. ■ Make sure paper is not jammed inside the back of the machine, and then close the fuser cover and press Start.
Cover is Open	The ADF cover is not closed completely.	Close the ADF cover.
	The ADF is open while loading a document.	Close the ADF cover of the machine and press Stop/Exit .
Disconnected	The other person or other person's fax machine stopped the call.	Try to send or receive again.
Document Jam	The document was not inserted or fed correctly, or the document scanned from the ADF was too long.	See <i>Document jams</i> on page 134 or <i>Using the automatic document feeder (ADF)</i> on page 20.
Drum Error	The corona wire on the drum unit needs to be cleaned.	Clean the corona wire on the drum unit. (See <i>Cleaning the corona wire</i> on page 145.)
	The drum unit has reached the end of its life.	Replace the drum unit. (See <i>Replacing the drum unit</i> on page 153.)
Duplex Disabled	The duplex tray is not installed properly.	Remove the duplex tray and install it again.
Fuser Error	The temperature of fuser unit does not rise at a specified temperature within specified time.	Turn the power switch off, wait a few seconds, and then turn it on again. Leave the machine for 15 minutes with the power on.
	The fuser unit is too hot.	The machine can be turned off for up to 60 hours without losing faxes stored in the memory. (See <i>Transferring your faxes or Fax Journal report</i> on page 133.)
Jam Duplex	The paper is jammed in the duplex tray.	(See <i>Paper jams</i> on page 135.)



Error Message	Cause	Action
Jam Inside	The paper is jammed inside the machine.	(See <i>Paper jams</i> on page 135.)
Jam MP Tray	The paper is jammed in the MP tray of the machine.	(See <i>Paper jams</i> on page 135.)
Jam Rear	The paper is jammed in the back of the machine.	(See <i>Paper jams</i> on page 135.)
Jam Tray 1 Jam Tray 2 (MFC-8380DN)	The paper is jammed in the paper tray of the machine.	(See <i>Paper jams</i> on page 135.)
No Paper	The machine is out of paper or paper is not correctly loaded in the paper tray.	Do one of the following: <ul style="list-style-type: none"> ■ Refill the paper in the paper tray or MP tray. ■ Remove the paper and load it again.
No Response/Busy	The number you dialed does not answer or is busy.	Verify the number and try again.
No Toner	The toner cartridge or the drum unit and toner cartridge assembly is not installed properly.	Re-install the toner cartridge or the drum unit and toner cartridge assembly.
No Tray	The paper tray is not completely closed.	Close the paper tray properly.
Out of Memory	The machine's memory is full.	<p>Fax sending or copy operation in progress</p> <p>Do one of the following:</p> <ul style="list-style-type: none"> ■ Press Start to send or copy the scanned pages. ■ Press Stop/Exit and wait until the other operations in progress finish, and then try again. ■ Clear the data from the memory. (See <i>Out of memory message</i> on page 46 or page 86.) <p>Print operation in process</p> <p>Do one of the following:</p> <ul style="list-style-type: none"> ■ Reduce print resolution. (See <i>Advanced tab</i> in the <i>Software User's Guide</i> on the CD-ROM.) ■ Clear the faxes from the memory. (See <i>Out of memory message</i> on page 86.)
Output Tray Full	The ADF output tray has reached its maximum capacity.	Remove the scanned pages from the ADF output tray. If you want to scan the remaining pages of your documents, dial the fax number (if you are sending a fax) and press Start .

Error Message	Cause	Action
Print Unable XX	The machine has a mechanical problem.	Disconnect the machine from the power for several minutes, then reconnect it. (The machine can be turned off for up to 60 hours without losing faxes stored in the memory. See <i>Transferring your faxes or Fax Journal report</i> on page 133.)
Protected Device	The protect switch of the USB Flash memory drive is on.	Turn off the protect switch of the USB Flash memory drive.
Rename the File	There is already a file on the USB Flash memory drive with the same name as the file you are trying to save.	Change the file name of the file on the USB Flash memory drive or the file you are trying to save.
Replace Drum	The drum unit is at the end of its life.	Replace the drum unit with a new one. (See <i>Replacing the drum unit</i> on page 153.)
	The drum unit counter was not reset when a new drum was installed.	<ol style="list-style-type: none"> 1 Open the front cover, and then press Clear/Back. 2 Press 1 to reset.
Replace Fuser	It is time to replace the fuser unit.	Call your Brother dealer to replace the fuser unit.
Replace Laser	It is time to replace the laser unit.	Call your Brother dealer to replace the laser unit.
Replace PF Kit1	It is time to replace the paper feeding kit for Tray 1.	Call your Brother dealer to replace the PF Kit 1.
Replace PF Kit2 (MFC-8380DN)	It is time to replace the paper feeding kit for Tray2.	Call your Brother dealer to replace the PF Kit 2.
Replace PF KitMP	It is time to replace the paper feeding kit for the MP tray.	Call your Brother dealer to replace the PF Kit MP.
Replace Toner	The toner cartridge is at the end of its life and printing is not possible.	Replace the toner cartridge with a new one. (See <i>Replacing a toner cartridge</i> on page 150)
Scan Unable XX	The machine has a mechanical problem.	Disconnect the machine from the power for several minutes, then reconnect it. (The machine can be turned off for up to 60 hours without losing faxes stored in the memory. See <i>Transferring your faxes or Fax Journal report</i> on page 133.)
Size mismatch	The paper in the tray is not the correct size.	Load the correct size of paper in the tray and set the "Paper Size" (Menu, 1, 2, 2 (See <i>Paper Size</i> on page 23)).
Toner Low	If the LCD shows Toner Low , you can still print; however, the machine is telling you that the toner cartridge is near the end of its life and the toner will soon need replacing.	Order a new toner cartridge now.

Error Message	Cause	Action
Too Many Files	There are too many files stored on the USB Flash memory drive.	Reduce the number of files stored on the USB Flash memory drive.
Too Many Trays (MFC-8380DN)	More than one optional tray is installed.	The maximum number of optional trays is one. Remove any additional trays.
Unable to Scan.	There is a document in the ADF input and output tray.	Remove the document from the ADF output tray.
Unusable Device	An incompatible or broken device has been connected to the USB direct interface.	Remove the USB Flash memory drive from the USB direct interface.

Transferring your faxes or Fax Journal report

If the LCD shows:

- Print Unable XX
- Scan Unable XX

We recommend transferring your faxes to another fax machine or to your PC. (See *Transferring faxes to another fax machine* on page 133 or *Transferring faxes to your PC* on page 133.)

You can also transfer the Fax Journal report to see if there are any faxes you need to transfer. (See *Transferring Fax Journal report to another fax machine* on page 133.)



Note

If there is an error message on the machine's LCD, after the faxes have been transferred, disconnect the machine from the power source for several minutes, and then reconnect it.

Transferring faxes to another fax machine

If you have not set up your Station ID, you cannot enter fax transfer mode. (See *Setting your station ID* in the *Quick Setup Guide*.)

- 1 Press **Menu, 9, 0, 1**.
- 2 Do one of the following:
 - If the LCD shows **No Data**, there are no faxes left in the machine's memory. Press **Stop/Exit**.
 - Enter the fax number to which faxes will be forwarded.
- 3 Press **Start**.

Transferring faxes to your PC

You can transfer the faxes from your machine's memory to your PC.

- 1 Make sure that you have installed **MFL-Pro Suite** on your PC, and then turn on **PC-Fax Receiving** on the PC. (For details about PC Fax Receive, see *PC-FAX receiving* in the *Software User's Guide* on the CD-ROM.)
- 2 Make sure that you have set **PC Fax Receive** on the machine. (See *PC Fax Receive* on page 66.) If faxes are in the machine's memory when you set up PC Fax Receive, the LCD will ask if you want to transfer the faxes to your PC.
- 3 Do one of the following:
 - To transfer all faxes to your PC, press **1**. You will be asked if you want a backup print.
 - To exit and leave the faxes in the memory, press **2**.
- 4 Press **Stop/Exit**.

Transferring Fax Journal report to another fax machine

If you have not set up your Station ID, you cannot enter fax transfer mode. (See *Setting your station ID* in the *Quick Setup Guide*.)

- 1 Press **Menu, 9, 0, 2**.
- 2 Enter the fax number to which the Fax Journal report will be forwarded.
- 3 Press **Start**.

Document jams

If the document is jammed, follow the steps below.

! IMPORTANT

After removing a jammed document, check that no paper scraps are left in the machine that could cause another jam.

Document is jammed in the top of the ADF unit

- 1 Take out any paper from the ADF that is not jammed.
- 2 Open the ADF cover.
- 3 Pull the jammed document out to the right.



- 4 Close the ADF cover.
- 5 Press **Stop/Exit**.

Document is jammed under the document cover

- 1 Take out any paper from the ADF that is not jammed.
- 2 Lift the document cover.
- 3 Pull the jammed document out to the left.



- 4 Close the document cover.
- 5 Press **Stop/Exit**.

Document is jammed at the ADF output tray

- 1 Take out any paper from the ADF that is not jammed.
- 2 Pull the jammed document out to the right.



- 3 Press **Stop/Exit**.

Document is jammed in the duplex slot (MFC-8380DN)

- 1 Take out any paper from the ADF that is not jammed.
- 2 Do one of the following:
 - If you can see the jammed document, pull the jammed document out to the right.



- If you cannot see the jammed document, open the ADF cover (1) and (2) and pull the jammed document out to the top.



Close the ADF cover (1) and (2).

- 3 Press **Stop/Exit**.

Paper jams

To clear paper jams, please follow the steps in this section.

! IMPORTANT

Please confirm that you have installed both a toner cartridge and a drum unit in the machine. If you have not installed a drum unit or have installed the drum unit incorrectly, then this may cause a paper jam in your Brother machine.



Note

If the error message remains, open and close the front cover and fuser cover firmly to reset the machine.

! IMPORTANT

To prevent damage to the machine caused by static electricity, DO NOT touch the electrodes shown in the illustration.

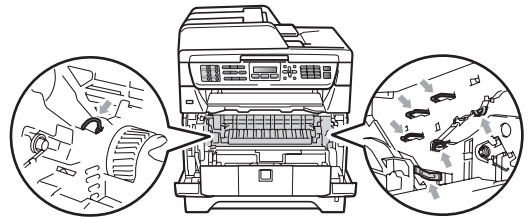

Note

The LCD names for the paper trays are as follows:

- Standard paper tray: Tray 1
- Optional lower tray: Tray 2 (MFC-8380DN)
- Multi-purpose tray: MP Tray

Paper is jammed in the MP tray

If the LCD shows **Jam MP Tray**, follow these steps:

- 1 Remove the paper from the MP tray.
- 2 Remove any jammed paper from in and around the MP tray.

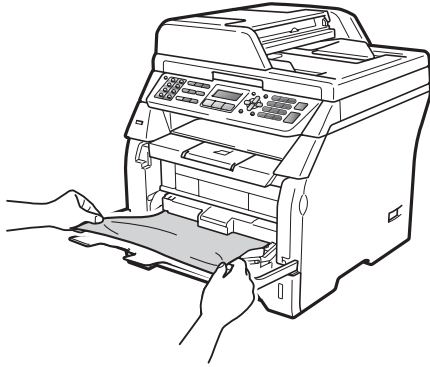

- 3 Press **Start**.
- 4 Fan the paper stack, and then put it back in the MP tray.

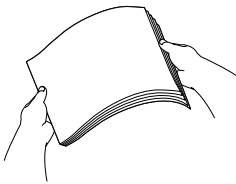

- 5 When loading paper in the MP tray, make sure that the paper stays under the maximum paper height guides on both sides of the tray.

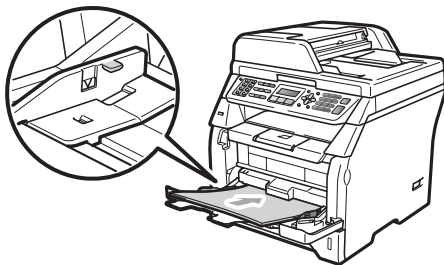

Paper is jammed in Paper Tray 1 or Tray 2 (MFC-8380DN)

If the LCD shows **Jam Tray 1** or **Jam Tray 2**, follow these steps:

- 1 Pull the paper tray completely out of the machine.
For Jam Tray 1:

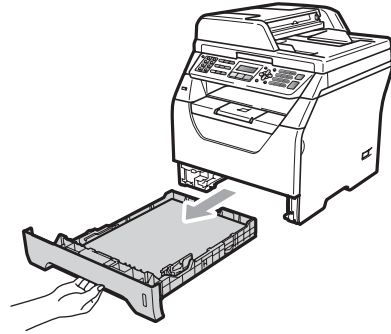

For Jam Tray 2:

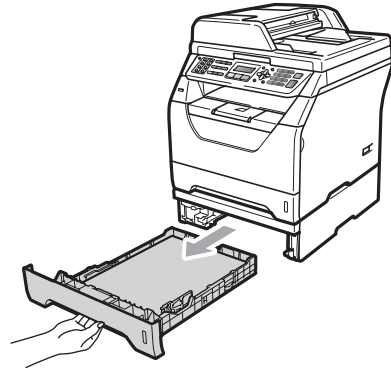

- 2 Use both hands to slowly pull out the jammed paper.

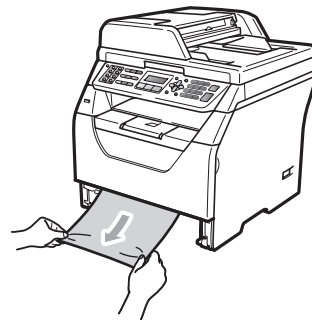

- 3 Make sure the paper is below the maximum paper mark (▼) of the paper tray. While pressing the blue paper-guide release lever, slide the paper guides to fit the paper size. Make sure that the guides are firmly in the slots.
- 4 Put the paper tray firmly back in the machine.

! IMPORTANT

DO NOT take out the standard paper tray while paper is feeding from a lower paper tray as this will cause a paper jam.

Paper is jammed inside the machine

- 1 Unplug the telephone line cord first, disconnect all cables, and then unplug the power cord from the electrical socket.
- 2 Pull the paper tray completely out of the machine.
- 3 Use both hands to slowly pull out the jammed paper.

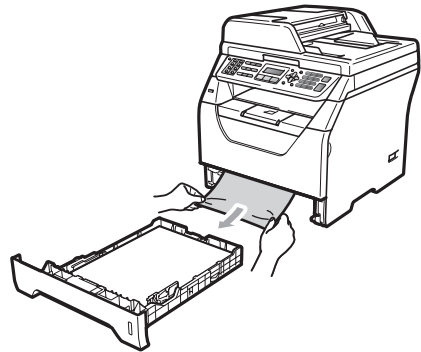

- 4 Press the front cover release button and open the front cover.

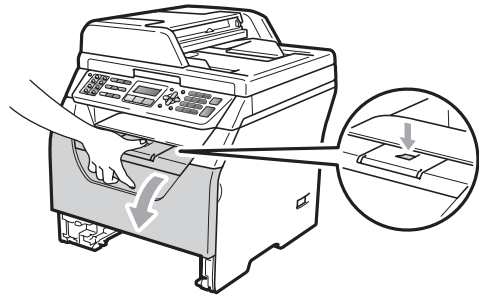

! CAUTION

! HOT SURFACE

After you have just used the machine, some internal parts of the machine will be extremely hot. Wait at least 10 minutes for the machine to cool down before attempting to clear the paper jam.

- 5 Slowly take out the drum unit and toner cartridge assembly. The jammed paper may be pulled out with the drum unit and toner cartridge assembly, or this may release the paper so you can pull it out of the paper tray opening.

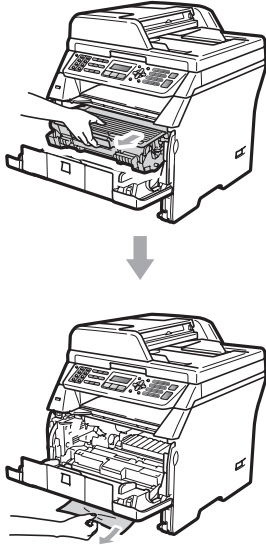

- 6 Put the drum unit and toner cartridge assembly back in the machine.

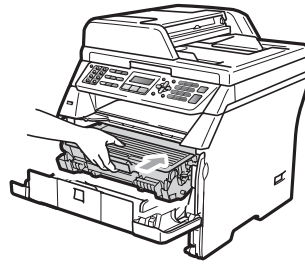

- 7 Close the front cover.
- 8 Put the paper tray firmly back in the machine.
- 9 Plug the machine's power cord back into the electrical socket first, and reconnect all cables and telephone line cord. Turn on the machine's power switch.

Paper is jammed inside the drum unit and toner cartridge assembly

- 1 Unplug the telephone line cord first, disconnect all cables, and then unplug the power cord from the electrical socket.
- 2 Press the front cover release button and open the front cover.

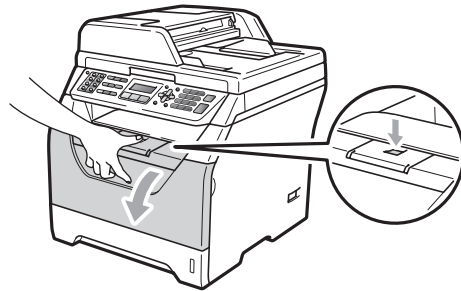

! IMPORTANT

We recommend that you place the drum unit and toner cartridge assembly on a clean, flat surface with a sheet of disposable paper or cloth underneath it in case you accidentally spill or scatter toner.

To prevent damage to the machine from static electricity, DO NOT touch the electrodes shown in the illustration.

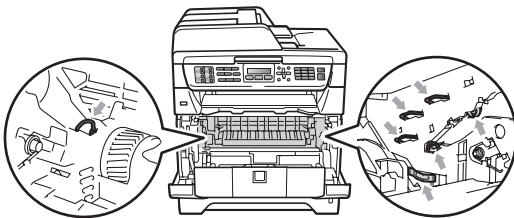

⚠ CAUTION

🔥 HOT SURFACE

After you have just used the machine, some internal parts of the machine will be extremely hot. Wait at least 10 minutes for the machine to cool down before attempting to clear the paper jam.

- 3 Slowly take out the drum unit and toner cartridge assembly.

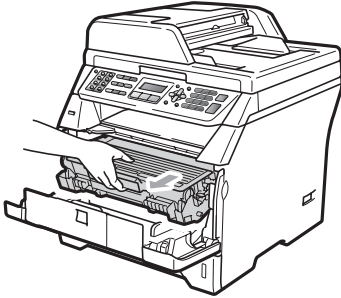

⚠ IMPORTANT

We recommend that you place the drum unit and toner cartridge assembly on a clean, flat surface with a sheet of disposable paper or cloth underneath it in case you accidentally spill or scatter toner.

- 4 Push down the blue lock lever and take the toner cartridge out of the drum unit. Take out the jammed paper if there is any inside the drum unit.

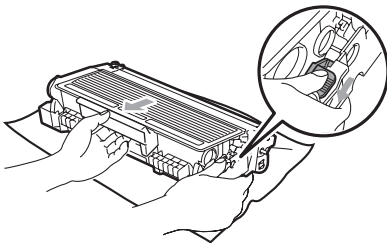

⚠ IMPORTANT

- Handle the toner cartridge carefully. If toner scatters on your hands or clothes, wipe or wash it off with cold water at once.
- To avoid print quality problems, DO NOT touch the shaded parts shown in the illustrations below.

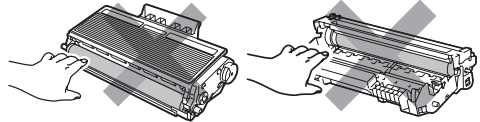

- 5 Clear the jammed paper if there is any inside the drum unit.
- 6 Put the toner cartridge back into the drum unit until you hear it lock into place. If you put it in correctly, the blue lock lever will lift automatically.

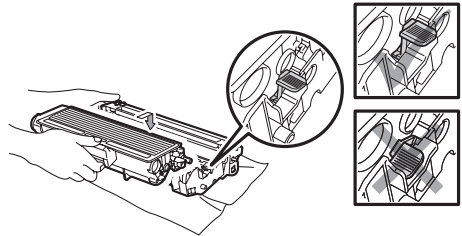

- 7 Put the drum unit and toner cartridge assembly back in the machine.

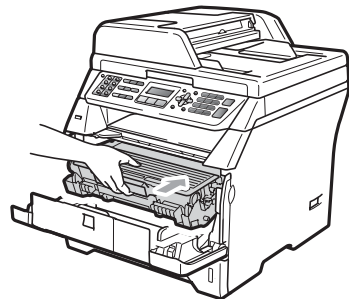

- 8 Close the front cover.
- 9 Plug the machine's power cord back into the electrical socket first, and reconnect all cables and telephone line cord. Turn on the machine's power switch.

Paper is jammed at the back of the machine

- 1 Unplug the telephone line cord first, disconnect all cables, and then unplug the power cord from the electrical socket.
- 2 Press the front cover release button and open the front cover.

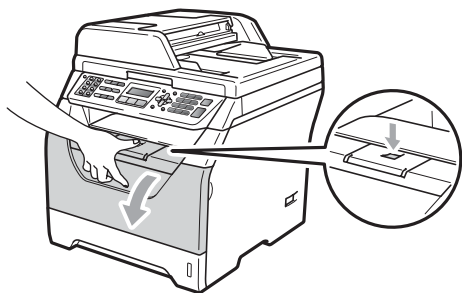

⚠ CAUTION

🔥 HOT SURFACE

After you have just used the machine, some internal parts of the machine will be extremely hot. Wait at least 10 minutes for the machine to cool down before attempting to clear the paper jam.

- 3 Slowly take out the drum unit and toner cartridge assembly.

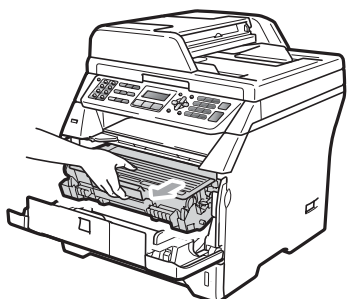

! IMPORTANT

We recommend that you place the drum unit and toner cartridge assembly on a clean, flat surface with a sheet of disposable paper or cloth underneath it in case you accidentally spill or scatter toner.

- 4 Open the back cover (back output tray).

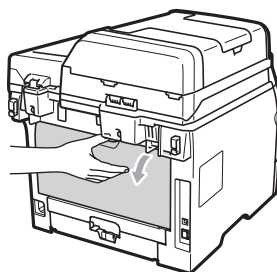

- 5 Pull the tabs at the left and right hand sides toward you to open the fuser cover (1).

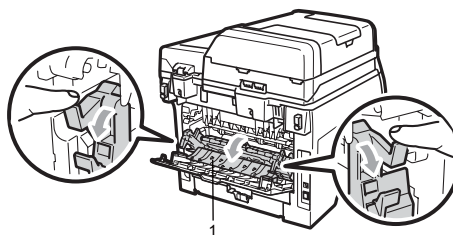

- 6 Pull the jammed paper out of the fuser unit.

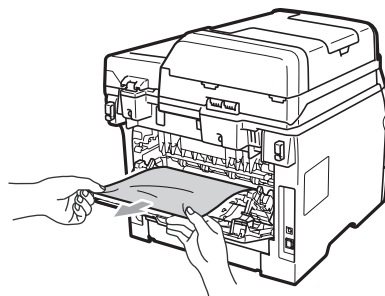

- 7 Close the fuser cover and back cover (back output tray).

- 8 Put the drum unit and toner cartridge assembly back in the machine.

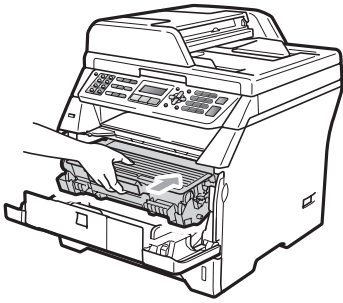

- 9 Close the front cover.
- 10 Plug the machine's power cord back into the electrical socket first, and reconnect all cables and telephone line cord. Turn on the machine's power switch.

Paper is jammed in the duplex tray

- 1 Pull the duplex tray completely out of the machine.

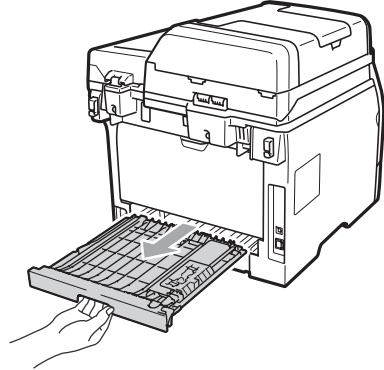

- 2 Pull the jammed paper out of the machine or the duplex tray.

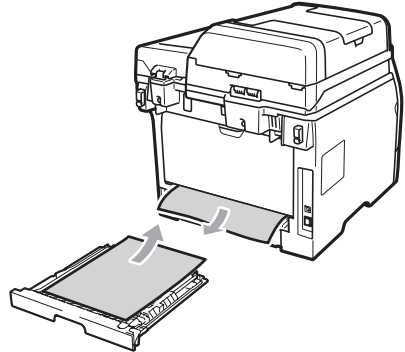

- 3 Put the duplex tray back in the machine.

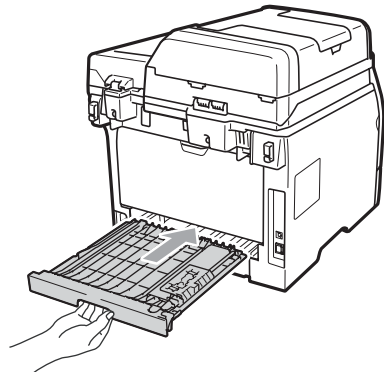

Routine maintenance

⚠ WARNING

Use neutral detergents.

DO NOT use any flammable substances, spray or organic solvent/liquids containing alcohol/ammonia to clean the inside or outside of the machine. Doing this may cause a fire or electrical shock. (For more information see *Important safety instructions* on page 103.)

! IMPORTANT

The drum unit contains toner, so handle it carefully. If toner scatters on your hands or clothes, wipe or wash it off with cold water at once.

Cleaning the outside of the machine

- 1 Turn off the machine. Unplug the telephone line cord first, disconnect all cables, and then unplug the power cord from the electrical socket.
- 2 Pull the paper tray completely out of the machine.

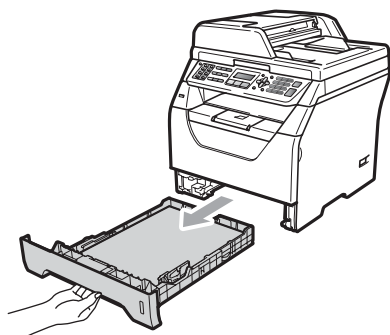

- 3 Wipe the outside of the machine with a dry, lint-free soft cloth to remove dust.

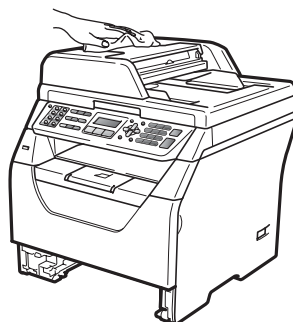

- 4 Remove any paper that is in the paper tray.
- 5 Wipe the inside and the outside of the paper tray with a dry, lint-free soft cloth to remove dust.

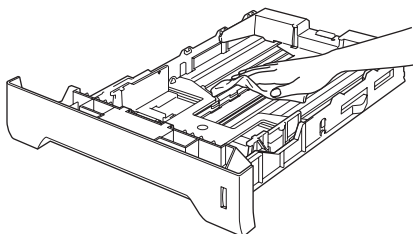

- 6 Re-load the paper and put the paper tray firmly back in the machine.
- 7 Plug the machine's power cord back into the electrical socket first, and reconnect all cables and telephone line cord. Turn on the machine.

Cleaning the scanner

- 1 Turn off the machine. Unplug the telephone line cord first, disconnect all cables and then unplug the power cord from the electrical socket.
- 2 Lift the document cover (1). Clean the white plastic surface (2) and scanner glass (3) underneath it with a soft lint-free cloth moistened with water.



- 3 In the ADF unit, clean the white bar (1) and the scanner glass strip (2) underneath it with a soft lint-free cloth moistened with water.

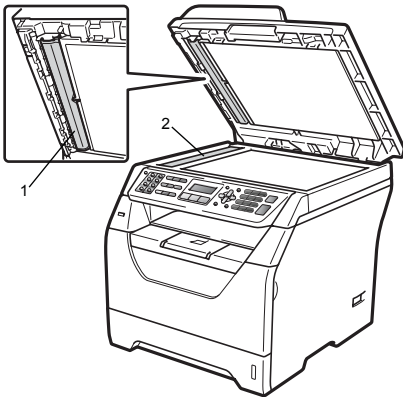

- 4 Plug the machine's power cord back into the electrical socket first, and reconnect all cables and telephone line cord. Turn on the machine.



Note

In addition to cleaning the scanner glass and glass strip with a soft lint-free cloth moistened with water, run your finger tip over the glass to see if you can feel anything on it. If you feel dirt or debris, clean the glass again concentrating on that area. You may need to repeat the cleaning process three or four times. To test, make a copy after each cleaning.

Cleaning the laser scanner window

⚠ WARNING

Use neutral detergents.

DO NOT use any flammable substances, spray or organic solvent/liquids containing alcohol/ammonia to clean the inside or outside of the machine. Doing this may cause a fire or electrical shock. For more information see *Important safety instructions* on page 103.

! IMPORTANT

DO NOT touch the laser scanner window with your fingers.

- 1 Before you clean the inside of the machine, turn off the machine. Unplug the telephone line cord first, and then disconnect all cables and the power cord from the electrical socket.
- 2 Open the front cover and slowly take out the drum unit and toner cartridge assembly.

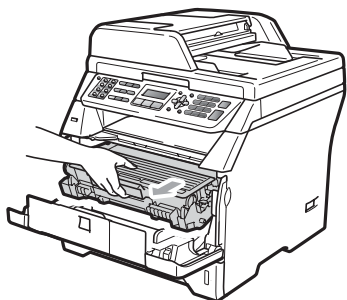

⚠ CAUTION

🔥 HOT SURFACE

After you have just used the machine, some internal parts of the machine will be extremely hot. Wait at least 10 minutes for the machine to cool down before attempting to clear the paper jam.

! IMPORTANT

- To prevent damage to the machine caused by static electricity, DO NOT touch the electrodes shown in the illustration.

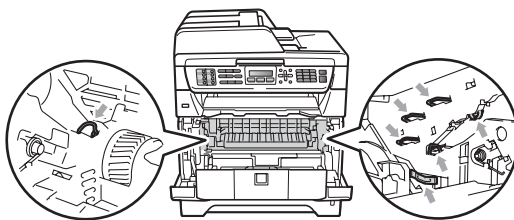

- We recommend that you place the drum unit on a clean, flat surface with a sheet of disposable paper or cloth underneath it in case you accidentally spill or scatter toner.

- 3 Wipe the laser scanner window (1) by wiping it with a dry, lint-free soft cloth.

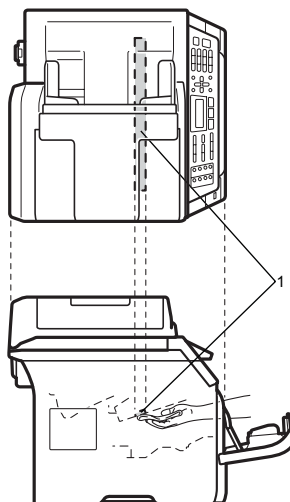

- 4 Put the drum unit and toner cartridge assembly back in the machine.

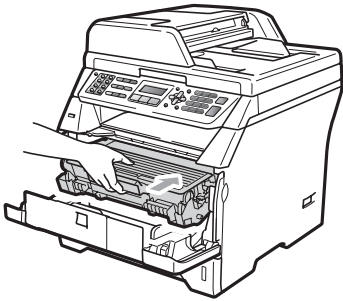

- 5 Close the front cover.
- 6 Plug the machine's power cord back into the electrical socket first, and then plug in the telephone line cord. Turn on the machine.

Cleaning the corona wire

If you have print quality problems, clean the corona wire as follows:

- 1 Turn off the machine. Unplug the telephone line cord first, disconnect all cables, and then unplug the power cord from the electrical socket.
- 2 Open the front cover and slowly take out the drum unit and toner cartridge assembly.

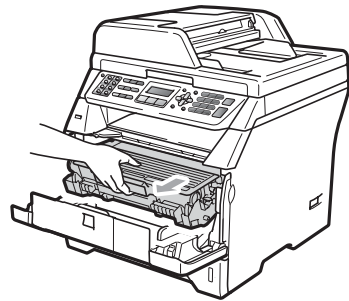

! IMPORTANT

- We recommend that you place the drum unit and toner cartridge assembly on a clean, flat surface with a sheet of disposable paper or cloth underneath it in case you accidentally spill or scatter toner.
- Handle the toner cartridge carefully. If toner scatters on your hands or clothes, wipe or wash it off with cold water at once.
- To prevent damage to the machine caused by static electricity, DO NOT touch the electrodes shown in the illustration.

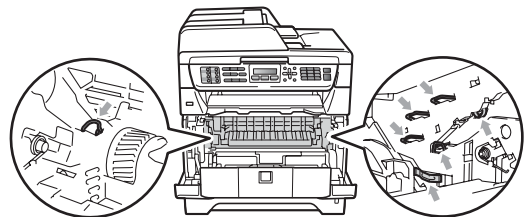

- 3 Clean the corona wire inside the drum unit by gently sliding the blue tab from right to left and left to right several times.

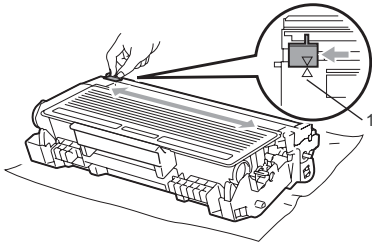

 **Note**

Be sure to return the blue tab to the home position (▲) (1). If you do not, printed pages may have a vertical stripe.

- 4 Put the drum unit and toner cartridge assembly back in the machine.

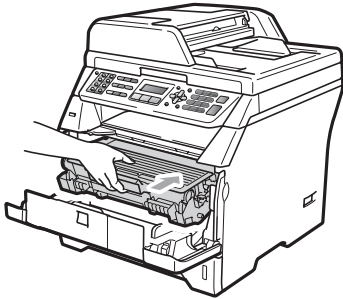

- 5 Close the front cover.
6 Plug the machine's power cord back into the electrical socket first, and then reconnect all cables and telephone line cord. Turn on the machine.

 **IMPORTANT**

To avoid print quality problems, DO NOT touch the shaded parts shown in the illustrations below.

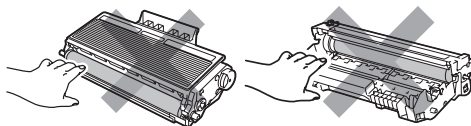

Cleaning the drum unit

If you have print quality problems, clean the drum unit as follows.

- 1 Turn off the machine. Unplug the telephone line cord first, and then unplug the power cord from the electrical socket.
2 Open the front cover and slowly take out the drum unit and toner cartridge assembly.

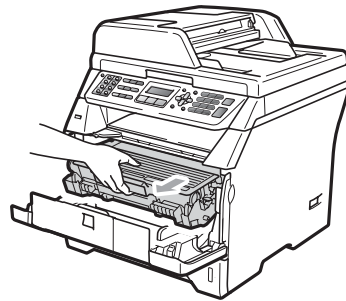

 **IMPORTANT**

- We recommend that you put the drum unit and toner cartridge assembly on a clean, flat surface with a sheet of disposable paper or cloth underneath it in case you accidentally spill or scatter toner.
- To prevent damage to the machine caused by static electricity, DO NOT touch the electrodes shown in the illustration.

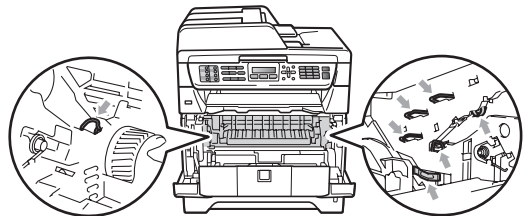

- 3 Push down the blue lock lever and take the toner cartridge out of the drum unit.

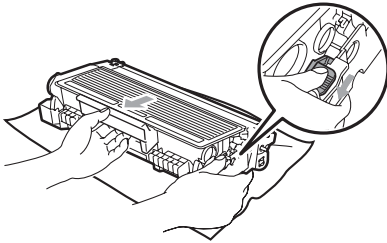

! IMPORTANT

- Handle the toner cartridge carefully. If toner scatters on your hands or clothes, wipe or wash it off with cold water at once.
- To avoid print quality problems, DO NOT touch the shaded parts shown in the illustrations below.

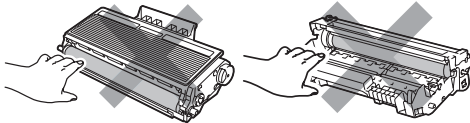

- 4 Put the print sample in front of the drum unit, and find the exact position of the poor print.

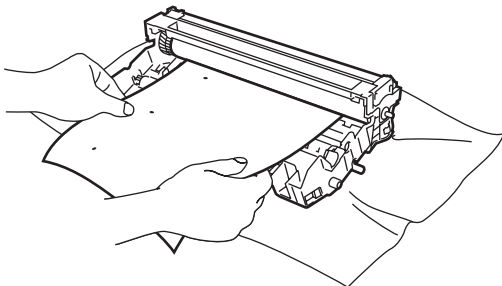

- 5 Turn the drum unit gear by hand while looking at the surface of the OPC drum (1).

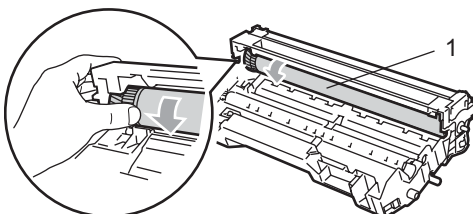

- 6 When you have found the mark on the drum that matches the print sample, wipe the surface of the OPC drum with a dry cotton swab until the dust or glue on the surface comes off.

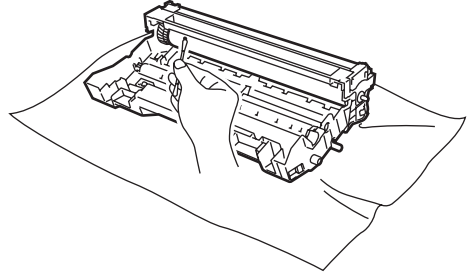

! IMPORTANT

- The drum is photosensitive so DO NOT touch it with your fingers.
- DO NOT clean the surface of the photosensitive drum with a sharp object.
- DO NOT use excessive force when cleaning the drum unit.

- 7 Put the toner cartridge back into the drum unit until you hear it lock into place. If you put the cartridge in correctly, the blue lock lever will lift automatically.

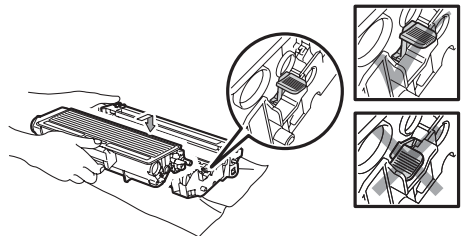

- 8 Put the drum unit and toner cartridge assembly back in the machine.

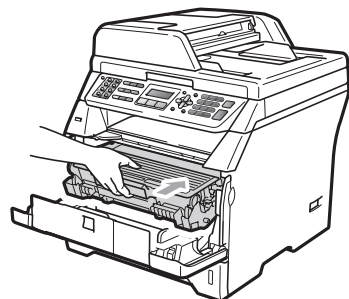

- 9 Close the front cover.
- 10 Plug the machine's power cord back into the electrical socket first, and then reconnect all cables and telephone line cord. Turn on the machine.

Replacing the consumable items

You will need to replace the consumable items when the machine indicates that the life of the consumable is over.

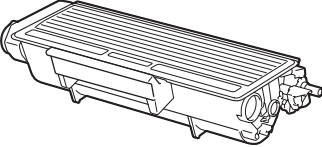
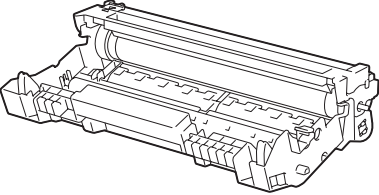
Toner cartridge	Drum unit
	
Order No. TN-3230, TN-3280	Order No. DR-3200

! IMPORTANT

- We recommend placing used consumable items on a sheet of paper to prevent accidentally spilling or scattering the material inside.
- Be sure to reseal the consumable items tightly so that the material inside does not spill.

Note

- Discard used consumable items according to local regulations. (See *EU Directive 2002/96/EC and EN50419* on page 106.) If you choose not to return your used consumable, please discard the used consumable according to local regulations, keeping it separate from domestic waste. If you have questions, call your local waste disposal office.
- If you use paper that is not a direct equivalent for the recommended paper, the life of consumable items and machine parts may be reduced.

Replacing a toner cartridge

The High Yield toner cartridges can print approximately 8,000 pages¹ and the Standard toner cartridges can print approximately 3,000 pages¹. Actual page count will vary depending on your average type of document (i.e., standard letter, detailed graphics). The machine is supplied with the Starter toner cartridge that will need to be replaced after approximately 2,000 pages. When a toner cartridge is running low, the LCD shows **Toner Low**.

¹ Approx. cartridge yield is declared in accordance with ISO/IEC 19752.



Note

It is a good idea to keep a new toner cartridge ready for use when you see the **Toner Low** warning.

CAUTION



HOT SURFACE

After you have just used the machine, some internal parts of the machine will be extremely hot. To prevent injury, when you open the front or back cover (back output tray) of the machine **DO NOT** touch the shaded parts shown in the illustration. If you do this you may get burned.

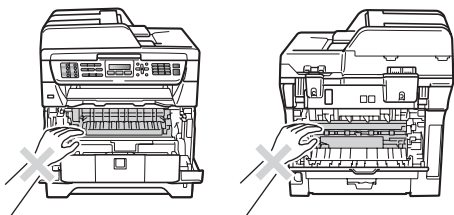

- 1 Press the front cover release button and open the front cover.

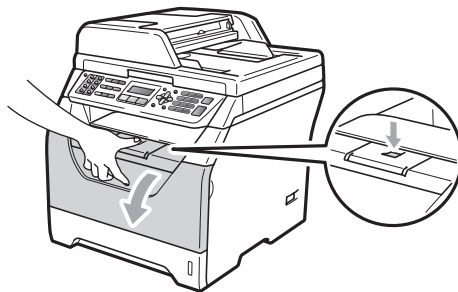

- 2 Slowly take out the drum unit and toner cartridge assembly.

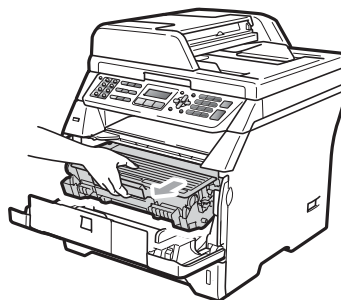

IMPORTANT

- We recommend that you put the drum unit and toner cartridge assembly on a clean, flat surface with a sheet of disposable paper or cloth underneath it in case you accidentally spill or scatter toner.
- To prevent damage to the machine caused by static electricity, **DO NOT** touch the electrodes shown in the illustration.

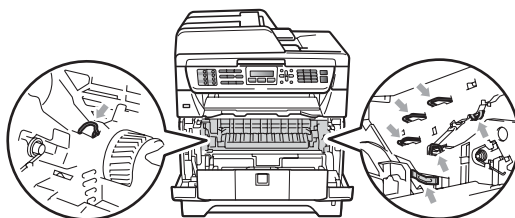

- 3 Push down the blue lock lever and take the used toner cartridge out of the drum unit.

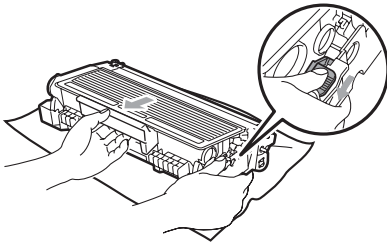

⚠ WARNING

DO NOT put a toner cartridge into a fire. It could explode, resulting in injuries.

! IMPORTANT

- Handle the toner cartridge carefully. If toner scatters on your hands or clothes, wipe or wash it off with cold water at once.
- To avoid print quality problems, DO NOT touch the shaded parts shown in the illustrations.

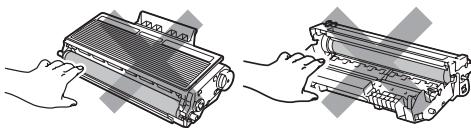

- Brother machines are designed to work with toner of a particular specification and will work to a level of optimum performance when used with genuine Brother toner cartridges (TN-3230/TN-3280). Brother cannot guarantee this optimum performance if toner or toner cartridge of other specifications are used. Brother does not therefore recommend the use of cartridge other than genuine

Brother cartridges with this machine, or the refilling of used cartridge with toner from other sources. If damage is caused to the drum unit or other part of this machine as a result of the use of toner or toner cartridge other than genuine Brother products due to the incompatibility or lack of suitability of those products with this machine, any repairs required as a result may not be covered by the warranty.

- Unpack the toner cartridge just before you put it in the machine. If a toner cartridge is left unpacked for a long time, the toner life will be shortened.
- Be sure to seal up the used toner cartridge tightly in a suitable bag so that toner powder does not spill out of the cartridge.

- 4 Unpack the new toner cartridge. Gently shake from side to side several times to distribute the toner evenly inside the cartridge.

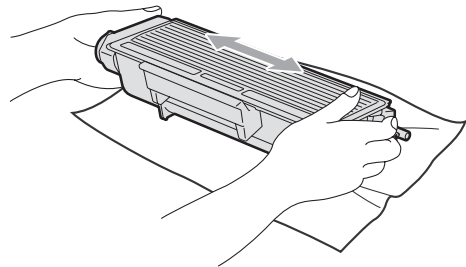

- 5 Pull off the protective cover.

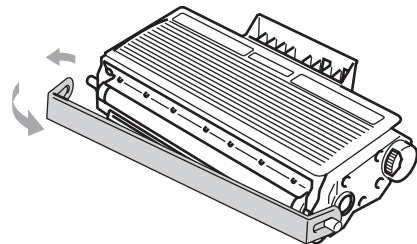

- 6 Put the new toner cartridge firmly into the drum unit until you hear it lock into place. If you put it in correctly, the lock lever will lift automatically.

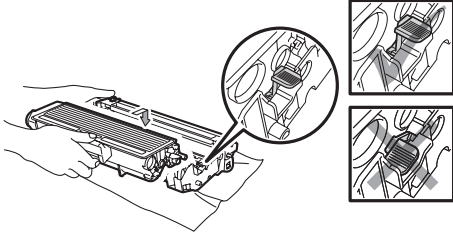

 **Note**

Make sure that you put in the toner cartridge correctly or it may separate from the drum unit.

- 7 Clean the corona wire of the drum unit by gently sliding the blue tab from right to left and left to right several times.

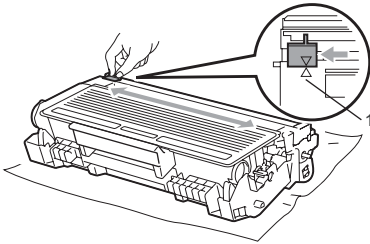

 **Note**

Be sure to return the blue tab to the home position (▲) (1). If you do not, printed pages may have a vertical stripe.

- 8 Put the drum unit and toner cartridge assembly back in the machine.

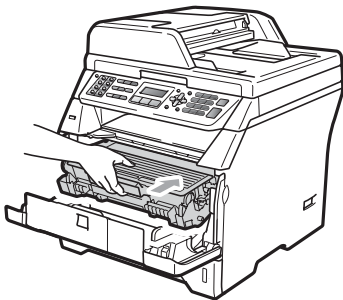

- 9 Close the front cover.

 **Note**

DO NOT turn off the machine or open the front cover until the LCD returns to the standby state.

Replacing the drum unit

The machine uses a drum unit to create print images on paper. If the LCD shows **Replace Drum**, the drum unit is near the end of its life and it is time to buy a new one. Even if the LCD shows **Replace Drum**, you may be able to continue printing without having to replace the drum unit for a while. However, if there is a noticeable deterioration in the output print quality (even before **Replace Drum** appears), then the drum unit should be replaced. You should clean the machine when you replace the drum unit. (See *Cleaning the laser scanner window* on page 144.)

! IMPORTANT

While removing the drum unit, handle it carefully because it may contain toner. If toner scatters on your hands or clothes, wipe or wash it off with cold water at once.

Note

The drum unit is a consumable item, and it is necessary to replace it periodically. There are many factors that determine the actual drum life, such as temperature, humidity, type of paper and how much toner you use for the number of pages per print job. The estimated drum life is approximately 25,000 pages¹. The actual number of pages your drum will print may be significantly less than this estimate. Because we have no control over the many factors that determine the actual drum life, we cannot guarantee a minimum number of pages that will be printed by your drum.

¹ Drum yield is approximate, and may vary by type of use.

! CAUTION

🔥 HOT SURFACE

After you have just used the machine, some internal parts of the machine will be extremely hot. To prevent injury, when you open the front or back cover (back output tray) of the machine **DO NOT** touch the shaded parts shown in the illustration. If you do this you may get burned.

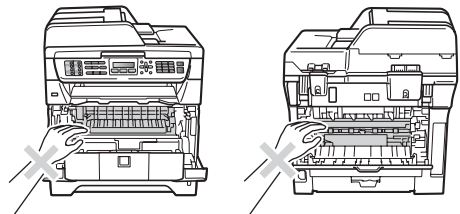

- 1 Press the front cover release button and open the front cover.

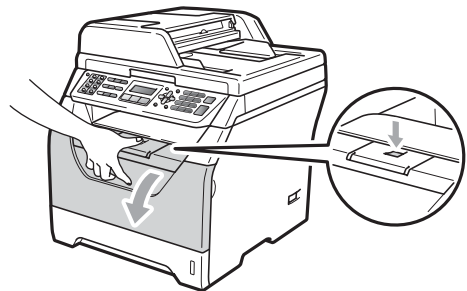

- 2 Slowly take out the drum unit and toner cartridge assembly.

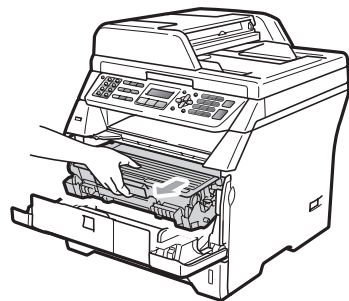

! IMPORTANT

- We recommend that you put the drum unit and toner cartridge assembly on a clean, flat surface with a sheet of disposable paper or cloth underneath it in case you accidentally spill or scatter toner.
- To prevent damage to the machine caused by static electricity, DO NOT touch the electrodes shown in the illustration.

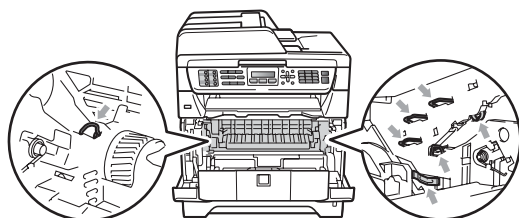

- 3 Push down the blue lock lever and take the toner cartridge out of the drum unit.

! IMPORTANT

- To avoid print quality problems, DO NOT touch the shaded parts shown in the illustrations.

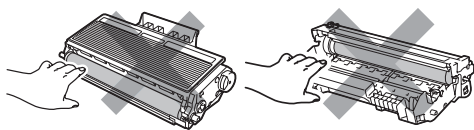

- Wait to unpack a new drum unit until immediately before you put it in the machine. Exposure to direct sunlight or room light may damage the drum unit.
- Be sure to seal up the used drum unit tightly in a bag so that toner powder does not spill out of the unit.

- 4 Unpack the new drum unit.

- 5 Put the toner cartridge firmly into the new drum unit until you hear it lock into place. If you put the cartridge in correctly, the blue lock lever will lift automatically.

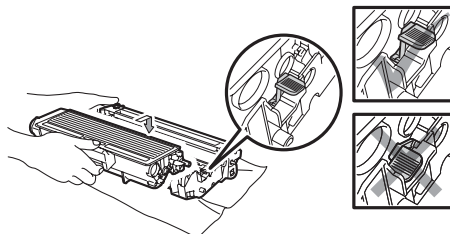

Note

Make sure that you put in the toner cartridge correctly or it may separate from the drum unit.

- 6 Put the new drum unit and toner cartridge assembly in the machine. Do not close the front cover.

- 7 Press **Clear/Back**.

Replace Drum?
1.Yes 2.No

To confirm you are installing a new drum, press 1.

- 8 When the LCD shows *Accepted*, close the front cover.

Replacing periodic maintenance parts

The periodic maintenance parts will need to be replaced regularly to maintain the print quality. The parts listed below will have to be replaced after printing approximately 50,000 pages for PF Kit MP and 100,000 pages for PF Kit 1, PF Kit 2, Fuser and Laser. Please call your Brother dealer when the following messages appear on the LCD.

LCD message	Description
Replace PF KitMP	Replace paper feeding kit for MP tray.
Replace PF Kit1	Replace paper feeding kit for Tray 1.
Replace PF Kit2 (MFC-8380DN)	Replace paper feeding kit for Tray 2.
Replace Fuser	Replace fuser unit.
Replace Laser	Replace laser unit.

Machine Information

Checking the Serial Number

You can see the machine's Serial Number on the LCD.

- 1 Press **Menu**, **8**, **1**.
- 2 Press **Stop/Exit**.

Checking the Page Counters

You can see the machine's Page Counters for copies, printed pages, reports and lists, faxes or a summary total.

- 1 Press **Menu**, **8**, **2**.
- 2 Press **▲** or **▼** to see **Total**, **Fax/List**, **Copy** or **Print**.
- 3 Press **Stop/Exit**.

Checking the remaining life of parts

You can see the remaining life of the machine's drum unit and periodic maintenance parts.

- 1 Press **Menu**, **8**, **3**.
- 2 Press **▲** or **▼** to choose 1.Drum, 2.Fuser, 3.Laser, 4.PF kit MP, 5.PF kit 1 or 6.PF Kit 2¹. Press **OK**.

¹ PF Kit 2 appears only when the optional LT-5300 tray is installed. (MFC-8380DN)

- 3 Press **Stop/Exit**.

Reset

The following reset functions are available:

1 Network

You can reset the print server back to its default factory settings such as the password and IP address information.

2 Address & Fax

Address & Fax resets the following settings:

- Address Book
(One-Touch Dial, Speed-Dial and Setup Groups)
- Programmed fax jobs in the memory
(Polled Transmit, Delayed Polling, Secure Polling, Delayed Fax and Delayed Batch)
- Station ID (Name and Number)
- Coverage Msg (Comments)
- Remote Fax Options
(Remote Access Code, Fax Storage, Fax Forwarding and PC-Fax)
- Report settings
(Transmission Verification Report, Tel Index List and Fax Journal)
- Setting Lock password

3 All Settings

You can reset all the machine settings back to the settings that were set at the factory.

Brother strongly recommends you perform this operation when you dispose of the machine.



Note

Unplug the interface cable before you choose **Network** or **All Settings**.

How to reset

- 1 Press **Menu, 0, 7**.
- 2 Press **▲** or **▼** to choose the reset you want.
Press **OK**.
- 3 Choose **1.Reset** or **2.Exit**.
- 4 If you choose **1.Reset** in step 3, you will be asked to reboot the machine.
Choose **1.Yes** or **2.No**. If you choose **1.Yes**, the machine will begin the Reset.



Note

You can also reset the Network settings by pressing **Menu, 7, 0**.

Packing and shipping the machine

⚠ CAUTION

Make sure that the machine has fully cooled down by leaving it disconnected from the power for at least 30 minutes before packing.

When you transport the machine, use the packing materials that came with your machine. If you do not pack the machine correctly, you could void your warranty.

- 1 Turn off the machine.
- 2 Unplug the machine from the telephone wall socket.
- 3 Unplug all the cables and AC power cord from the machine.
- 4 Press the front cover release button and open the front cover.
- 5 Take out the drum unit and toner cartridge assembly. Leave the toner cartridge installed in the drum unit.
- 6 Put the drum unit and toner cartridge assembly into a plastic bag and seal the bag.
- 7 Close the front cover.

- 8 Put the styrofoam piece marked "FRONT" into the original carton (1). Wrap the machine in the plastic bag and put it in the original carton (2). Put the drum unit and toner cartridge assembly in as shown below (3). Put the User's Guide (If available) and CD-ROM in the space at the back of the machine (4).

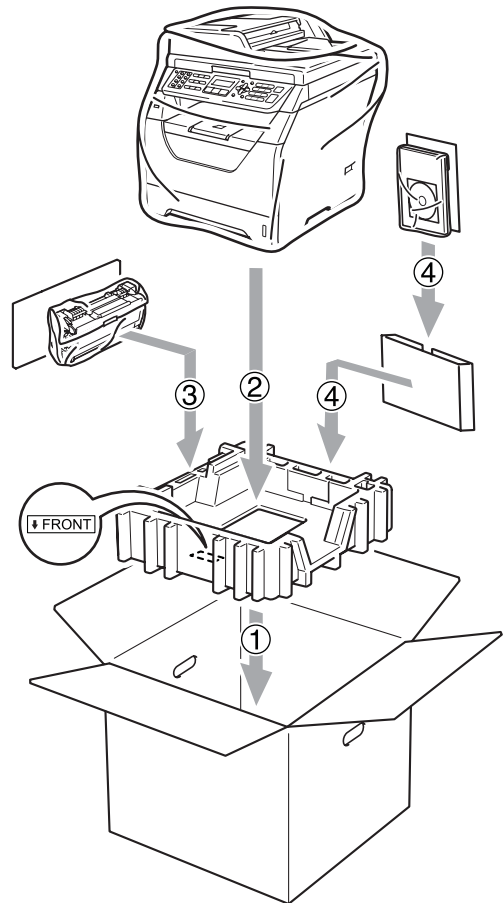

- 9 Take the two styrofoam pieces and match the front of the machine to the “FRONT” mark on one of the styrofoam pieces, and the back of the machine to the “REAR” mark on the other styrofoam piece (5). Coil the cables and place them and the Quick Setup Guide in the spaces provided as shown below (6).

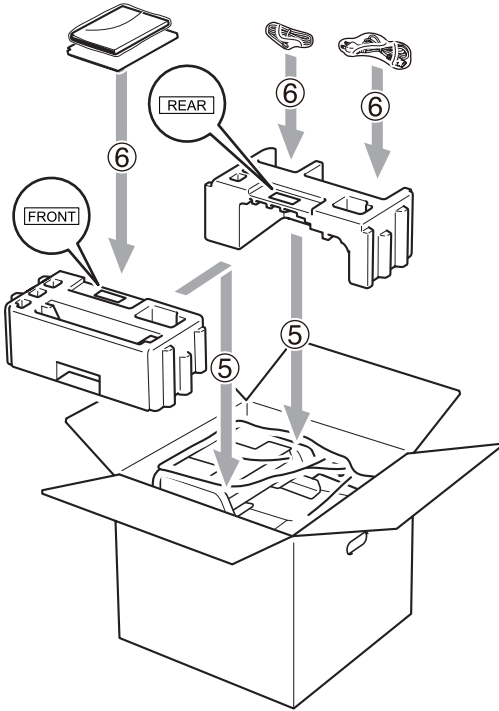

- 10 Close the carton and tape it shut.

On-screen programming

Your machine has been designed to be easy to use. The LCD provides on-screen programming using the menu keys.

We have created step by step on-screen instructions to help you program your machine. Simply follow the steps as they guide you through the menu selections and programming options.

Menu table

You can program your machine by using the *Menu table* on page 161. These pages list the menu selections and options.

Press **Menu** followed by the menu numbers to program your machine.







For example, to set **Beeper** volume to **Low**:

- 1 Press **Menu**, **1**, **3**, **2**.
- 2 Press **▲** or **▼** to choose **Low**.
- 3 Press **OK**.
- 4 Press **Stop/Exit**.

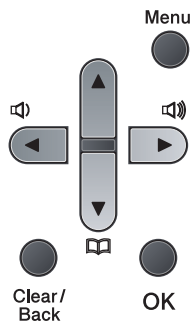
Memory storage

Your menu settings are stored permanently, and in the event of a power failure will *not* be lost. Temporary settings (for example, Contrast, Overseas Mode) *will* be lost. Also, during a power failure the machine will retain the date and time and any fax messages that are in the memory for approximately 60 hours.

Menu keys

	
 Menu	Access the menu.
 OK	Go to the next menu level. Accept an option.
 Clear / Back	Exit the menu by pressing repeatedly. Go back to the previous menu level.
	Scroll through the current menu level.
	Go back to the previous menu level or forward to the next menu level.
 Stop / Exit	Exit the menu.

How to access the menu mode

- 1 Press **Menu**.
- 2 Choose an option.
 - Press **1** for General Setup menu.
 - Press **2** for Fax menu.
 - Press **3** for Copy menu.
 - Press **4** for Printer menu.
 - Press **5** for USB Direct I/F menu.
 - Press **6** for Print Reports menu.
 - Press **7** for Network menu.
 - Press **8** for Machine Info. menu.
 - Press **9** for Service menu. ¹
 - Press **0** for Initial Setup.

¹ This will appear only when the LCD shows an error message.

You can also scroll through each menu level by pressing **▲** or **▼** for the direction you want.

- 3 Press **OK** when the option you want appears on the LCD.
The LCD will then show the next menu level.
- 4 Press **▲** or **▼** to scroll to your next menu selection.
- 5 Press **OK**.
When you have finished setting an option, the LCD will show *Accepted*.
- 6 Press **Stop/Exit** to exit Menu mode.

Menu table

The factory settings are shown in Bold with an asterisk.

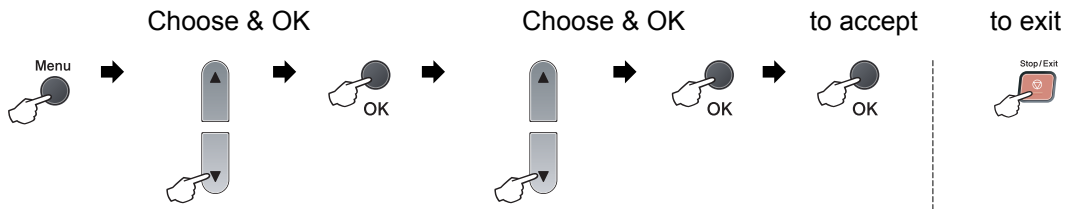

Main Menu	Submenu	Menu Selections		Options	Descriptions	Page
1.General Setup	1.Mode Timer	—	—	0 Sec 30 Secs 1 Min 2 Mins* 5 Mins Off	Sets the time to return to Fax mode. (MFC-8380DN) The time the machine will change from individual user to Public user when using Secure Function Lock.	22 31
	2.Paper	1.Paper Type	1.MP Tray	Thin Plain* Thick Thicker Transparency Recycled Paper	Sets the type of paper in the MP tray.	22
			2.Tray#1	Thin Plain* Thick Thicker Transparency Recycled Paper	Sets the type of paper in the paper tray.	22
3.Tray#2 (MFC-8380DN) (This menu only appears if you have the optional tray #2.)			Thin Plain* Thick Thicker Recycled Paper	Sets the type of paper in the optional paper tray #2.	22	

Main Menu	Submenu	Menu Selections		Options	Descriptions	Page
1.General Setup (continued)	2.Paper (continued)	2.Paper Size	1.MP Tray	A4* Letter Legal Executive A5 A5 L A6 B5 B6 Folio Any	Sets the size of the paper in the MP tray.	23
			2.Tray#1	A4* Letter Executive A5 A5 L A6 B5 B6	Sets the size of the paper in the paper tray.	23
			3.Tray#2 (MFC-8380DN) (This menu only appears if you have the optional tray #2.)	A4* Letter Executive A5 B5 B6	Sets the size of the paper in the optional paper tray #2.	23
	3.Volume	1.Ring		Off Low Med* High	Adjusts the ring volume.	25
		2.Beeper		Off Low Med* High	Adjusts the volume level of the beeper.	25
		3.Speaker		Off Low Med* High	Adjusts the speaker volume.	25

Main Menu	Submenu	Menu Selections	Options	Descriptions	Page
1.General Setup (continued)	4.Auto Daylight	—	On* Off	Changes for Daylight Savings Time automatically.	26
	5.Ecology	1.Toner Save	On Off*	Increases the page yield of the toner cartridge.	26
		2.Sleep Time	Range varies depending on model. 005Min*	Conserves power.	26
	6.Tray Use	1.Copy	Tray#1 Only Tray#2 Only MP Only MP>T1>T2* T1>T2>MP (For MFC-8380DN, tray#2 or T2 appears only if you installed the optional paper tray.)	Selects the tray that will be used for Copy mode.	23
		2.Fax	Tray#1 Only Tray#2 Only MP Only MP>T1>T2 T1>T2>MP* (For MFC-8380DN, tray#2 or T2 appears only if you installed the optional paper tray.)	Selects the tray that will be used for Fax mode.	24
		3.Print	Tray#1 Only Tray#2 Only MP Only MP>T1>T2* T1>T2>MP (For MFC-8380DN, tray#2 or T2 appears only if you installed the optional paper tray.)	Selects the tray that will be used for PC print.	24

Main Menu	Submenu	Menu Selections	Options	Descriptions	Page	
1.General Setup (continued)	7.LCD Contrast	—	-□□□■+ -□□□■+ -□□■□+* -■□□□+ -■□□□+	Adjusts the contrast of the LCD.	27	
	8.Security	1.Function Lock (MFC-8380DN)	—		Can restrict selected machine operation for up to 25 individual users and all other non-authorized Public users.	28
		1.Mem Security (MFC-8370DN)	—		Stops unauthorized users from most operations except receiving faxes into the memory.	28
		2.Setting Lock	—		Stops unauthorized users from changing the machine's current settings.	33
	9.Document Scan	1.Glass ScanSize		A4* Letter	Adjusts the scan area of the scanner glass to the size of the document.	40
		2.File Size	1.Color	Small Middle* Large	You can set your own default settings of the data compression rate.	See Software User's Guide on the CD-ROM.
			2.Gray	Small Middle* Large		
		3.Duplex Scan (MFC-8380DN)		Long edge* Short edge	Chooses the duplex scanning format.	38

Main Menu	Submenu	Menu Selections	Options	Descriptions	Page
2.Fax	1.Setup Receive (In Fax mode only)	1.Ring Delay	(00-08) 02* (Example for the UK)	Sets the number of rings before the machine answers in Fax Only or Fax/Tel mode.	49
		2.F/T Ring Time	20 Secs 30 Secs* 40 Secs 70 Secs	Sets the pseudo/double-ring time in Fax/Tel mode.	49
		3.Fax Detect	On* Off	Receives fax messages without pressing Start .	50
		4.Remote Codes	On (*51, #51) Off*	Allows you to answer all calls at an extension or external phone and use codes to turn the machine on or off. You can personalize these codes.	59
		5.Auto Reduction	On* Off	Reduces the size of incoming faxes.	51
		6.Memory Receive	On* Off	Automatically stores any incoming faxes in memory if it runs out of paper.	52
		7.Print Density	-□□□■+ -□□□□+ -□■□□+* -□■□□+ -■□□□+	Makes printouts darker or lighter.	50
		8.Polling RX	Standard* Secure Timer	Sets up your machine to poll another fax machine.	71
		9.Fax Rx Stamp	On Off*	Prints the received time and date on the top of the received faxes.	51
	0.Duplex	On Off*	Prints received faxes on both sides of the paper.	51	
	2.Setup Send (In Fax mode only)	1.Contrast	Auto* Light Dark	Changes the lightness or darkness of faxes you send.	43

Main Menu	Submenu	Menu Selections	Options	Descriptions	Page
2.Fax (continued)	2.Setup Send (In Fax mode only) (continued)	2.Fax Resolution	Standard* Fine S.Fine Photo	Sets the default resolution for outgoing faxes.	43
		3.Delayed Fax	—	Sets the time of day in 24 hour format that the delayed faxes will be sent.	45
		4.Batch TX	On Off*	Combines delayed faxes going to the same fax number at the same time of day into one transmission.	45
		5.Real Time TX	Next Fax:On Next Fax:Off On Off*	Sends a fax without using the memory.	44
		6.Polled TX	Standard* Secure	Sets up your machine with a document to be retrieved by another fax machine.	71
		7.Coverpg Setup	Next Fax:On Next Fax:Off On Off* Print Sample	Automatically sends a cover page you have programmed.	42
		8.Coverpage Note	—	Sets up your own comments for the fax cover page.	42
		9.Overseas Mode	On Off*	If you are having difficulty sending faxes overseas, set this to On.	44
		3.Address Book	1.One Touch Dial	—	Stores up to 16 One Touch Dial numbers, so you can dial by pressing one key (and Start).
	2.Speed Dial		—	Stores up to 300 Speed Dial numbers, so you can dial by pressing only a few keys (and Start).	62
	3.Setup Groups		—	Sets up to 20 Group numbers for Broadcasting.	63

Main Menu	Submenu	Menu Selections	Options	Descriptions	Page
2.Fax (continued)	4.Report Setting	1.XMIT Report	On On+Image Off* Off+Image	Sets initial setup for Transmission Verification Report.	74
		2.Journal Period	Off Every 50 Faxes* Every 6 Hours Every 12 Hours Every 24 Hours Every 2 Days Every 7 Days	Sets the interval for automatic printing of the Fax Journal.	74
	5.Remote Fax Opt	1.Forward/Store (Backup Print)	Off* Fax Forward Fax Storage PC Fax Receive	Sets the machine to forward fax messages, to store incoming faxes in the memory (so you can retrieve them while you are away from your machine), or to send faxes to your PC. If you chose Fax Forward or PC Fax Receive, you can turn on the safety feature Backup Print.	65
		2.Remote Access	---*	Sets your own code for Remote Retrieval.	68
		3.Print Document	—	Prints incoming faxes stored in the memory.	52
	6.Dial Restrict.	1.Dial Pad	Off* Enter # twice On	You can set the machine to restrict dialling when using the dial pad.	34
		2.One Touch Dial	Off* Enter # twice On	You can set the machine to restrict the dialling of One Touch numbers.	34
		3.Speed Dial	Off* Enter # twice On	You can set the machine to restrict the dialling of Speed Dial numbers.	34
	7.Remaining Jobs	—	—	You can check which jobs are in the memory and lets you cancel scheduled jobs.	45

Main Menu	Submenu	Menu Selections	Options	Descriptions	Page
2. Fax (continued)	0. Miscellaneous	1. Compatibility	High* Normal Basic (for VoIP)	Adjusts the equalization for transmission difficulties. VoIP service providers offer fax support using various standards. If you regularly experience fax transmission errors, choose Basic (for VoIP).	127
		2. BT Call Sign (U.K. only)	On Off*	Used with BT Call Sign.	54
3. Copy	1. Quality	—	Text Photo Auto*	You can choose the Copy resolution for your type of document.	81
	2. Brightness	—	-□□□■+ -□□□□+ -□□■□+* -□■□□+ -■□□□+	Adjust the brightness for copies.	81
	3. Contrast	—	-□□□■+ -□□□□+ -□□■□+* -□■□□+ -■□□□+	Adjust the contrast for copies.	81
4. Printer	1. Emulation	—	Auto (EPSON)* Auto (IBM) HP LaserJet BR-Script 3 Epson FX-850 IBM Proprinter	Chooses the emulation mode.	See Software User's Guide on the CD-ROM.
	2. Print Options	1. Internal Font	1. HP LaserJet 2. BR-Script 3	Prints a list of the machine's internal fonts.	
		2. Configuration	—	Prints a list of the machine's printer settings.	
		3. Test Print	—	Prints a test page.	
	3. Duplex	—	Off* On (Long Edge) On (Short Edge)	Enables or disables duplex printing. You can also choose long edge or short edge duplex printing.	
4. Reset Printer	—	1. Reset 2. Exit	Restores the printer settings to the original factory default settings.		

Main Menu	Submenu	Menu Selections	Options	Descriptions	Page
5.USB Direct I/F	1.Direct Print	1.Paper Size	A4* Letter Legal Executive A5 A5 L A6 B5 B6 Folio	Sets the paper size when printing directly from the USB flash memory drive. A5 L and A6 size are not available for the optional Tray#2. You can choose Legal and Folio for MP Tray only.	89
		2.Media Type	Thin Plain* Thick Thicker Recycled Paper	Sets the media type when printing directly from the USB flash memory drive.	89
		3.Multiple Page	1in1* 2in1 4in1 9in1 16in1 25in1 1 in 2x2 pages 1 in 3x3 pages 1 in 4x4 pages 1 in 5x5 pages	Sets the page style when printing multiple pages directly from the USB Flash memory drive.	89
		4.Orientation	Portrait* Landscape	Sets the page orientation when printing directly from the USB Flash memory drive.	89
		5.Collate	On* Off	Enables or disables the page collation when printing directly from the USB Flash memory drive.	89
		6.Print Quality	Normal* Fine	Sets the print quality option when printing directly from the USB Flash memory drive.	89
		7.PDF Option	Document* Document&Markup Document&Stamps	Sets the PDF option whether to print comments (Markup) or stamps in the PDF file along with the text.	89

Main Menu	Submenu	Menu Selections	Options	Descriptions	Page
5.USB Direct I/F (continued)	1.Direct Print (continued)	8.Index Print	Simple* Details	Sets the index print option, simple format or details.	89
		2.Scan to USB	1.Resolution	Color 100 dpi* Color 200 dpi Color 300 dpi Color 600 dpi Gray 100 dpi Gray 200 dpi Gray 300 dpi B&W 200 dpi B&W 200x100 dpi	Sets the resolution to send the scanned data to USB Flash memory drive.
	2.File Name		—	Enter the file name of the scanned data.	
6.Print Reports	1.XMIT Verify	1.View on LCD	—	Prints a Transmission Verification Report for your last transmission.	75
		2.Print Report	—		
	2.Help List	—	—	Prints the Help List so you can see at-a-glance how to quickly program your machine.	75
	3.Tel Index List	1.Numeric	—	Lists name and numbers stored in the One-Touch and Speed-Dial memory, in numerical or alphabetical order.	75
		2.Alphabetic	—		
	4.Fax Journal	—	—	Lists information about your last 200 incoming and outgoing faxes. (TX means Transmit. RX means Receive.)	75
	5.User Settings	—	—	Lists your settings.	75
	6.Network Config	—	—	Lists your Network settings.	75
7.Order Form	—	—	You can print an accessories order form to fill out and send to your Brother dealer.	75	

Main Menu	Submenu	Menu Selections		Options	Descriptions	Page
7.Network	1. TCP/IP	1.Boot Method	—	Auto* Static RARP BOOTP DHCP	Chooses the BOOT method that best suits your needs.	See <i>Network User's Guide</i> on the CD-ROM.
		2.IP Address	—	[000-255]. [000-255]. [000-255]. [000-255]	Enter the IP address.	
		3.Subnet Mask	—	[000-255]. [000-255]. [000-255]. [000-255]	Enter the Subnet mask.	
		4.Gateway	—	[000-255]. [000-255]. [000-255]. [000-255]	Enter the Gateway address.	
		5.Node Name	—	BRNXXXXXXXXXXXX	Enter the Node name.	
		6.WINS Config	—	Auto* Static	Chooses the WINS configuration mode.	
		7.WINS Server	—	(Primary) [000-255]. [000-255]. [000-255]. [000-255] (Secondary) [000-255]. [000-255]. [000-255]. [000-255]	Specifies the IP address of the primary or secondary WINS server.	
		8.DNS Server	—	(Primary) [000-255]. [000-255]. [000-255]. [000-255] (Secondary) [000-255]. [000-255]. [000-255]. [000-255]	Specifies the IP address of the primary or secondary DNS server.	
		9.APIPA	—	On* Off	Automatically allocates the IP address from the link-local address range.	
	0.IPv6	—	On Off*	Enable or Disable the IPv6 protocol. If you want to use the IPv6 protocol, visit http://solutions.brother.com/ for more information.		
	2. Ethernet	—	—	Auto* 100B-FD 100B-HD 10B-FD 10B-HD	Choose the Ethernet link mode.	

Main Menu	Submenu	Menu Selections		Options	Descriptions	Page
7.Network (continued)	3.Scan To FTP	—	—	Color 100 dpi* Color 200 dpi Color 300 dpi Color 600 dpi Gray 100 dpi Gray 200 dpi Gray 300 dpi B&W 200 dpi B&W 200x100 dpi	Chooses the file format to send the scanned data via FTP.	See <i>Network User's Guide</i> on the CD-ROM.
	4.ScanTo Network	—	—	Color 100 dpi* Color 200 dpi Color 300 dpi Color 600 dpi Gray 100 dpi Gray 200 dpi Gray 300 dpi B&W 200 dpi B&W 200x100 dpi	You can scan a black and white or colour document directly to a CIFS server on your local network or on the internet.	
	5.Time Zone	—	—	UTCXXX:XX	Sets the time zone for your country.	
	0.Network Reset	1.Reset 2.Exit	1.Yes 2.No	— —	Restore all network settings to factory default.	

Main Menu	Submenu	Menu Selections	Options	Descriptions	Page
8.Machine Info.	1.Serial No.	—	—	You can check the serial number of your machine.	155
	2.Page Counter	—	Total Fax/List Copy Print	You can check the number of total pages the machine has printed during its life.	155
	3.Parts Life	1.Drum 2.Fuser 3.Laser 4.PF kit MP 5.PF kit 1 6.PF Kit 2	—	You can check the percentage of a machine part's life that remains available. For MFC-8380DN, PF Kit 2 appears only when the optional LT5300 tray is installed.	155
0.Initial Setup	1.Receive Mode	—	Fax Only* Fax/Tel External TAD Manual	Chooses the receive mode that best suits your needs.	47
	2.Date&Time	—	—	Puts the date and time on the LCD and in headings of faxes you send.	See <i>Quick Setup Guide</i> .
	3.Station ID	—	Fax: Tel: Name:	Sets your name and fax number to appear on each page you fax.	
	4.Tone/Pulse	—	Tone* Pulse	Chooses the dialling mode.	
	5.Dial Tone	—	Detection No Detection*	You can shorten the dial tone detect pause.	127
	6.Phone Line Set	—	Normal* ISDN PBX	Select the phone line type.	53
	7.Reset	1.Network	1.Reset 2.Exit	1.Reset 2.Exit	Restores all network settings to factory default.
2.Address & Fax		1.Reset 2.Exit	1.Reset 2.Exit	Restores all stored phone number and fax settings.	156
3.All Settings		1.Reset 2.Exit	1.Reset 2.Exit	Restore all the machine settings to factory default.	156

Entering text

When setting certain menu selections, such as the Station ID, you will need to type text characters. The dial pad keys have letters printed on them. The keys: **0**, **#** and ***** do *not* have printed letters because they are used for special characters.

Press the appropriate dial pad key the number of times shown in this reference table to access the character you want.

Press Key	one time	two times	three times	four times	five times	six times	seven times	eight times	nine times
1	@	.	/	1	@	.	/	1	@
2	a	b	c	A	B	C	2	a	b
3	d	e	f	D	E	F	3	d	e
4	g	h	i	G	H	I	4	g	h
5	j	k	l	J	K	L	5	j	k
6	m	n	o	M	N	O	6	m	n
7	p	q	r	s	P	Q	R	S	7
8	t	u	v	T	U	V	8	t	u
9	w	x	y	z	W	X	Y	Z	9

For menu selections that do not allow lower case character selection, please use this reference table.

Press Key	one time	two times	three times	four times	five times
2	A	B	C	2	A
3	D	E	F	3	D
4	G	H	I	4	G
5	J	K	L	5	J
6	M	N	O	6	M
7	P	Q	R	7	P
8	T	U	V	8	T
9	W	X	Y	9	W

Inserting spaces

To enter a space in a fax number, press ► once between numbers. To enter a space in a name, press ► twice between characters.

Making corrections

If you entered a letter incorrectly and want to change it, press ◀ to move the cursor to the incorrect character, and then press **Clear/Back**.

Repeating letters

To enter a character on the same key as the previous character, press ► to move the cursor right before pressing the key again.

Special characters and symbols

Press *, # or 0, then press ◀ or ▶ to move the cursor to the symbol or character you want. Press **OK** to choose it. The symbols and characters below will appear depending on your menu selection.

Press *	for	(space) ! " # \$ % & ' () * + , - . / €
Press #	for	: ; < = > ? @ [] ^ _ \ ~ ' { }
Press 0	for	Ä Ë Ö Ü À Ç È É 0

General

Printer Type	Laser	
Print Method	Electrophotography by semiconductor laser beam scanning	
Memory Capacity	64 MB	
LCD (liquid crystal display)	16 characters × 2 lines	
Power Source	220 - 240V 50/60Hz	
Power Consumption	Peak:	1080 W
	Copying:	Average 570 W ¹
	Sleep:	Average 11 W
	Standby:	Average 80 W

¹ When making a copy from one sheet

Dimensions

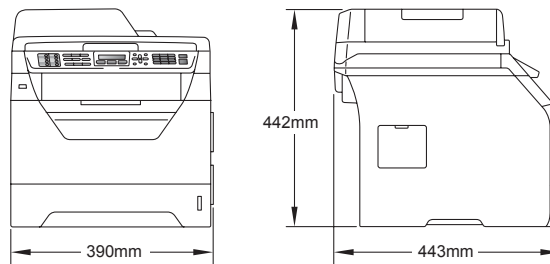

Weight	With Drum/Toner Unit:	15.7 kg (MFC-8380DN)
		15.5 kg (MFC-8370DN)

Noise level

Sound power ¹

Operating (Copying):	LwAd = 6.57 Bell (A) (MFC-8380DN)
	LwAd = 6.58 Bell (A) (MFC-8370DN)

Office equipment with LwAd > 6.30 Bell (A) is not suitable for use in room where people do primarily intellectual work. Such equipment should be placed in separate rooms because of the noise emission.

Standby:	LwAd = 4.09 Bell (A)
----------	----------------------

Sound pressure

Operating (Copying):	LPAm = 56 dB (A)
Standby:	LPAm = 30 dB (A)

¹ Measured in accordance with ISO9296

Temperature	Operating:	10 to 32.5°C
	Storage:	5 to 35°C
Humidity	Operating:	20 to 80% (without condensation)
	Storage:	10 to 90% (without condensation)
ADF (automatic document feeder)	Up to 20 pages (Staggered) [80 g/m ²]	
	Recommended Environment for Best Results:	
	Temperature:	20 to 30°C
	Humidity:	50% - 70%
	Paper:	Xerox Premier TCF 80 g/m ² or Xerox Business 80 g/m ²
Paper Tray	250 Sheets [80 g/m ²]	
Paper Tray 2 (option) (MFC-8380DN)	250 Sheets [80 g/m ²]	

Print media

Paper Input

Paper Tray

- Paper Type: Thin paper, Plain paper, Bond paper and Transparencies ¹ or Recycled paper
- Paper Size: Letter, A4, B5 (ISO), A5, A5(Long Edge), B6 (ISO), A6 and Executive
- Paper Weight: 60 to 105 g/m²
- Maximum Paper Tray Capacity: Up to 250 sheets of 80 g/m² Plain paper

Multi-purpose tray (MP tray)

- Paper Type: Thin paper, Plain paper, Thick paper, Bond paper, Transparencies, Recycled paper, Envelopes or Labels ¹
- Paper Size: Width: 69.8 to 216 mm
Length: 116 to 406.4 mm
- Paper Weight: 60 to 163 g/m² ²
- Maximum Multi-purpose tray Capacity: Up to 50 sheets of 80 g/m² Plain paper
Up to 3 envelopes

¹ For transparencies or labels, we recommend removing printed pages from the output paper tray immediately after they exit the machine to avoid the possibility of smudging.

² 60 to 105 g/m² for duplex print.

Paper Tray 2 (option) (MFC-8380DN)

- Paper Type: Thin paper, Plain paper, Bond paper or Recycled paper
- Paper Size: Letter, A4, B5 (ISO), A5, B6 (ISO) and Executive
- Paper Weight: 60 to 105 g/m²
- Maximum paper tray capacity: Up to 250 sheets of 80 g/m² Plain paper

Paper Output	■ Output Tray:	Up to 150 sheets (face-down print delivery to the output paper tray)
	■ Back Output Tray:	One sheet (face-up print delivery to the back output tray)
Duplex Printing	■ Paper Size:	A4
	■ Paper Weight:	60 to 105 g/m ²
	■ Manual Duplex:	Yes
	■ Automatic Duplex:	Yes

Fax

Compatibility	ITU-T Super Group 3
Duplex Fax (Receive)	Yes
Coding System	MH/MR/MMR/JBIG
Modem Speed	Automatic Fallback: 33,600 bps
Single-Sided Document Size	ADF Width: 148 to 215.9 mm ADF Length: 148 to 355.6 mm Scanner Glass Width: Max. 215.9 mm Scanner Glass Length: Max. 297 mm
2-Sided (Duplex)	ADF Width: 148 to 215.9 mm
Document Size (MFC-8380DN)	ADF Length: 148 to 297.0 mm
Scanning Width	Max. 208 mm
Printing Width	Max. 208 mm
Greyscale	8 bit levels
Polling Types	Standard, Secure, Timer, Sequential
Contrast Control	Automatic/Light/Dark (manual setting)
Resolution	Horizontal: 8 dot/mm Vertical ■ Standard: 3.85 line/mm ■ Fine: 7.7 line/mm ■ Photo: 7.7 line/mm ■ Superfine: 15.4 line/mm
One Touch Dial	16 (8 × 2)
Speed Dial	300 stations
Groups	Up to 20
Broadcasting	366 stations
Automatic Redial	3 times at 5 minute intervals
Ring Delay	0, 1, 2, 3, 4, 5, 6, 7 or 8 rings
Communication Source	Public switched telephone network
Memory Transmission	Up to 600 ¹ /500 ² pages
Out of Paper Reception	Up to 600 ¹ /500 ² pages

¹ 'Pages' refers to the 'Brother No. 1 Chart' (a typical business letter, Standard resolution, JBIG code). Specifications and printed materials are subject to change without prior notice.

² 'Pages' refers to the 'ITU-T Test Chart #1' (a typical business letter, Standard resolution, JBIG code). Specifications and printed materials are subject to change without prior notice.

Copy

Colour/Monochrome	Monochrome	
Single-sided Document Size	ADF Width:	148 to 215.9 mm
	ADF Length:	148 to 355.6 mm ¹
	Scanner Glass Width:	Max. 215.9 mm
	Scanner Glass Length:	Max. 297 mm
2-Sided (Duplex)	ADF Width: 148 to 215.9 mm	
Document Size (MFC-8380DN)	ADF Length: 148 to 297.0 mm	
Copy Width:	Max. 208 mm	
Multiple Copies	Stacks or Sorts up to 99 pages	
Reduce/Enlarge	25% to 400% (in increments of 1%)	
Resolution	Max. 1200 × 600 dpi	
First Copy Out Time	Less than 10.5 seconds ² (from READY mode)	

¹ 5 sheet ADF input limit when using sheets longer than A4.

² The first copy out time may vary depending on scanner lamp warm up time.

Scan

Colour/Monochrome	Yes/Yes
Duplex Scanning (MFC-8380DN)	Yes
TWAIN Compliant	Yes (Windows® 2000 Professional/XP/XP Professional x64 Edition/Windows Vista®) Mac OS X 10.3.9 or greater ¹
WIA Compliant	Yes (Windows® XP/Windows Vista®)
Colour Depth	24 bit colour
Resolution	Up to 19200 × 19200 dpi (interpolated) ² Up to 600 × 2400 dpi (optical) ² (From Scanner Glass) Up to 600 × 600 dpi (optical) ² (From ADF)
Single-Sided Document Size	ADF Width: 148.0 to 215.9 mm ADF Length: 148.0 to 355.6 mm ³ Scanner Glass Width: Max. 215.9 mm Scanner Glass Length: Max. 297 mm
2-Sided (Duplex)	ADF Width: 148.0 to 215.9 mm
Document Size (MFC-8380DN)	ADF Length: 148.0 to 297.0 mm
Scanning Width	Max. 210 mm
Greyscale	8 bit levels

¹ For the latest driver updates, visit us at <http://solutions.brother.com/>

² Maximum 1200 × 1200 dpi scanning with the WIA driver in Windows® XP/Windows Vista® (resolution up to 19200 × 19200 dpi can be chosen by using the Brother scanner utility)

³ 5 sheet ADF input limit when using sheets longer than A4.

Print

Emulations	PCL6, BR-Script3 (PostScript [®] 3™), IBM Pro-Printer XL, Epson FX-850
Printer Driver	Host-Based Driver for Windows [®] 2000 Professional/XP/XP Professional x64 Edition/Windows Vista [®] /Windows Server [®] 2003 ¹ /Windows Server [®] 2003 x64 Edition ¹ /Windows Server [®] 2008 ¹
	BR-Script3 (PPD file) for Windows [®] 2000 Professional/XP/XP Professional x64 Edition/Windows Vista [®] /Windows Server [®] 2003 ¹ /Windows Server [®] 2003 x64 Edition ¹ /Windows Server [®] 2008 ¹
	Macintosh Printer Driver for Mac OS X 10.3.9 or greater ² BR-Script3 (PPD file) for Mac OS X 10.3.9 or greater ²
Resolution	1200 dpi ³ , HQ1200 (2400 × 600 dpi), 600 dpi, 300 dpi
Print Speed for Simplex	Up to 28 pages/minute (A4 size) ⁴ (MFC-8370DN) Up to 30 pages/minute (A4 size) ⁴ (MFC-8380DN)
Print Speed for Duplex Printing	Up to 13 sides/minute
First Print Out Time	Less than 8.5 seconds (from the READY state and standard tray)

¹ Print only via network

² For the latest driver updates, visit us at <http://solutions.brother.com/>

³ Using 1200 dpi setting (1200 x1200 dpi) the print speed will be slower.

⁴ The print speed may change depending on the type of document you print.

Interfaces

USB Use a USB 2.0 interface cable (type A/B) that is no longer than 2 m. ¹ ²

Ethernet Use an Ethernet UTP cable category 5 or greater.

¹ Your machine has a Hi-Speed USB 2.0 interface. The machine can also be connected to a computer that has a USB 1.1 interface.

² Third party USB ports are not supported.

Direct Print feature

Compatibility PDF version 1.7 ¹, JPEG, Exif + JPEG, PRN (created by Brother printer driver), TIFF (scanned by all Brother MFC or DCP models), PostScript®3™ (created by Brother BR-Script 3 printer driver), XPS version 1.0.

¹ PDF data including a JBIG2 image file, a JPEG2000 image file or transparency files are not supported.

Computer requirements

Minimum System Requirements and Supported PC Software Functions								
Computer Platform & Operating System Version		Supported PC Software Functions	PC Interface ³	Processor Minimum Speed	Minimum RAM	Recommended RAM	Hard Disk Space to install	
							For Drivers	For Applications
Windows® Operating System ¹	Windows® 2000 Professional ⁵	Printing, PC Fax ⁴ , Scanning	USB, 10/100 Base Tx (Ethernet)	Intel® Pentium® II or equivalent	64 MB	256 MB	150 MB	310 MB
	Windows® XP Home® ^{2 5} Windows® XP Professional ^{2 5}				128 MB			
	Windows® XP Professional x64 Edition			64-bit (Intel®64 or AMD64) supported CPU	256 MB	512 MB		
	Windows® Vista® ²			Intel® Pentium® 4 or equivalent 64-bit (Intel®64 or AMD64) supported CPU	512 MB	1 GB		

E

Windows® Operating System ¹ (Continued)	Windows Server® 2003 (print only via network)	Printing	10/100 Base Tx (Ethernet)	Intel® Pentium® III or equivalent	256 MB	512 MB	50 MB	N/A
	Windows Server® 2003 x64 Edition (print only via network)			64-bit (Intel® 64 or AMD64) supported CPU				
	Windows Server® 2008 (print only via network)			Intel® Pentium® 4 or equivalent 64- bit (Intel® 64 or AMD64) supported CPU	512 MB	2 GB		
Macintosh Operating System	Mac OS X 10.3.9 - 10.4.3	Printing, PC Fax send ⁴ , Scanning	USB ³ , 10/100 Base Tx (Ethernet)	PowerPC G4/G5, PowerPC G3 350MHz	128 MB	256 MB	80 MB	400 MB
	Mac OS X 10.4.4 or greater			PowerPC G4/G5, Intel® Core™ Processor	512 MB	1 GB		

¹ Internet Explorer 5.5® or greater

² Maximum 1200 x 1200 dpi scanning with the WIA driver in Windows®XP/Windows Vista® (resolution up to 19200 x 19200 dpi can be chosen by using the scanner utility.)

³ Third party USB ports are not supported.

⁴ PC Fax supports black and white only.

⁵ PaperPort™ 11SE supports Microsoft® SP4 or higher for Windows® 2000 and SP2 or higher for XP.

For the latest driver updates, visit us at <http://solutions.brother.com/>

All trademarks, brand and product names are property of their respective companies.

Consumable items

Toner Cartridge Life	Starter Toner Cartridge:	Approx. 2,000 pages (A4) ¹
	Standard Toner Cartridge: TN-3230:	Approx. 3,000 pages (A4) ¹
	High-Yield Toner Cartridge: TN-3280:	Approx. 8,000 pages (A4) ¹
Drum Unit	DR-3200:	Approx. 25,000 pages (A4) ²

¹ Approx. cartridge yield is declared in accordance with ISO/IEC 19752.

² Drum yield is approximate, and may vary by type of use.

Ethernet wired network

Network board model name	NC-6800h Type 2
LAN	You can connect your machine to a network for Network Printing, Network Scanning, PC Fax and Remote Setup. ^{1 2}
Support for	Windows [®] 2000 Professional, Windows [®] XP, Windows [®] XP Professional x64 Edition, Windows Vista [®] , Windows Server [®] 2003 ² , Windows Server [®] 2003 x64 Edition ² and Windows Server [®] 2008 ² Mac OS X 10.3.9 or greater ^{3 4}
Protocols	IPv4: ARP, RARP, BOOTP, DHCP, APIPA (Auto IP), WINS/NetBIOS name resolution, DNS Resolver, mDNS, LLNMR responder, LPR/LPD, Custom Raw Port/Port9100, IPP/IPPS, FTP Client and Server, TELNET Server, HTTP/HTTPS Server, SSL/TLS, TFTP Client and Server, SMTP Client, APOP, POP before SMTP, SMTP-AUTH, SNMPv1/v2c/v3, ICMP, LLTD responder, Web Services Print, CIFS Client, SNTP IPv6: (Turned off as default) NDP, RA, DNS resolver, mDNS, LLNMR responder, LPR/LPD, Custom Raw Port/Port9100, IPP/IPPS, FTP Client and Server, TELNET Server, HTTP/HTTPS server, SSL/TLS, TFTP Client and Server, SMTP Client, APOP, POP before SMTP, SMTP-AUTH, SNMPv1/v2c/v3, ICMPv6, LLTD responder, Web Services Print, CIFS Client, SNTP
Network type	Ethernet 10/100 BASE-TX Auto Negotiation (Wired LAN)

Management utilities⁵

BRAdmin Light for Windows[®] 2000 Professional, Windows[®] XP, Windows[®] XP Professional x64 Edition, Windows Vista[®], Windows Server[®] 2003, Windows Server[®] 2003 x64 Edition, Windows Server[®] 2008 and Mac OS X 10.3.9 or greater⁴

BRAdmin Professional for Windows[®] 2000 Professional, Windows[®] XP, Windows[®] XP Professional x64 Edition, Windows Vista[®], Windows Server[®] 2003, Windows Server[®] 2003 x64 Edition and Windows Server[®] 2008

Web BRAdmin for Windows[®] 2000 Professional, Windows[®] XP, Windows[®] XP Professional x64 Edition, Windows Vista[®], Windows Server[®] 2003, Windows Server[®] 2003 x64 Edition and Windows Server[®] 2008

Client computers with a web browser supporting Java.

¹ PC Fax Send for Mac

² Print only via network

³ Mac OS X 10.3.9 or greater (mDNS)

⁴ For the latest driver updates, visit us at <http://solutions.brother.com/>

⁵ BRAdmin Professional and Web BRAdmin are available as a download from <http://solutions.brother.com/>

F

Glossary

This is a comprehensive list of features and terms that appear in Brother manuals. Availability of these features depends on the model you purchased.

ADF (automatic document feeder)

The document can be placed in the ADF and scanned one page at a time automatically.

Auto Reduction

Reduces the size of incoming faxes.

Automatic fax transmission

Sending a fax without picking up the handset of the external telephone.

Automatic Redial

A feature that enables your machine to redial the last fax number after five minutes if the fax did not go through because the line was busy.

Backup Print

Your machine prints a copy of every fax that is received and stored in memory. This is a safety feature so you will not lose messages during a power failure.

Batch Transmission

As a cost saving feature, all delayed faxes to the same fax number will be sent as one transmission.

Beeper Volume

Volume setting for the beep when you press a key or make an error.

Broadcasting

The ability to send the same fax message to more than one location.

BT Call Sign

A subscriber service purchased from the telephone company in U.K. that gives you another phone number on an existing phone line. The Brother machine uses the new number to simulate a dedicated fax line.

Cancel Job

Cancels a programmed print job and clears the machine's memory.

CNG tones

The special tones (beeps) sent by fax machines during automatic transmission to tell the receiving machine that a fax machine is calling.

Coding method

Method of coding the information contained in the document. All fax machines must use a minimum standard of Modified Huffman (MH). Your machine is capable of greater compression methods, Modified Read (MR), Modified Modified Read (MMR) and JBIG, if the receiving machine has the same capability.

Communication error (or Comm. Error)

An error during fax sending or receiving, usually caused by line noise or static.

Compatibility group

The ability of one fax unit to communicate with another. Compatibility is assured between ITU-T Groups.

Contrast

Setting to compensate for dark or light documents, by making faxes or copies of dark documents lighter and light documents darker.

Delayed Fax

Sends your fax at a specified later time that day.

Dual Access

Your machine can scan outgoing faxes or scheduled jobs into memory at the same time it is sending a fax or receiving or printing an incoming fax.

ECM (Error Correction Mode)

Detects errors during fax transmission and resends the pages of the fax that had an error.

Extension telephone

A telephone on the fax number that is plugged into a separate wall socket.

External phone

A TAD (telephone answering device) or telephone that is connected to your machine.

F/T Ring Time

The length of time that the Brother machine pseudo/double-rings (when the Receive Mode setting is Fax/Tel) to notify you to pick up a voice call that it answered.

Fax Detect

Enables your machine to respond to CNG tones if you interrupt a fax call by answering it.

Fax Forwarding

Sends a fax received into the memory to another pre-programmed fax number.

Fax Journal

Lists information about the last 200 incoming and outgoing faxes. TX means Transmit. RX means Receive.

Fax Storage

You can store faxes in the memory.

Fax tones

The signals sent by sending and receiving fax machines while communicating information.

Fax/Tel

You can receive faxes and telephone calls. Do not use this mode if you are using a telephone answering device (TAD).

Fine resolution

Resolution is 203 × 196 dpi. It is used for small print and graphs.

Greyscale

The shades of grey available for copying and faxing photographs.

Group number

A combination of One Touch and Speed Dial numbers that are stored on a One Touch key or in a Speed Dial location for Broadcasting.

Help List

A printout of the complete Menu table that you can use to program your machine when you do not have the User's Guide with you.

Journal Period

The pre-programmed time period between automatically printed Fax Journal Reports. You can print the Fax Journal on demand without interrupting the cycle.

LCD (liquid crystal display)

The display screen on the machine that shows interactive messages during On-Screen Programming and shows the date and time when the machine is idle.

Manual fax

When you lift the handset of your external telephone so you can hear the receiving fax machine answer before you press **Start** to begin transmission.

Menu mode

Programming mode for changing your machine's settings.

OCR (optical character recognition)

The bundled ScanSoft™ PaperPort™ 11SE with OCR or Presto! PageManager software application converts an image of text to text you can edit.

One Touch

Keys on the machine's control panel where you can store numbers for easy dialling. You can store a second number on each key if you press **Shift** and the One Touch key together.

Out of Paper Reception

Receives faxes into the machine's memory when the machine is out of paper.

Overseas Mode

Makes temporary changes to the fax tones to accommodate noise and static on overseas telephone lines.

Pause

Allows you to place a 2.8 second delay in the dialling sequence while you are dialling using the dial pad or while you are storing One Touch and Speed Dial numbers. Press **Redial/Pause** as many times as needed for longer pauses.

Polling

The process of a fax machine calling another fax machine to retrieve waiting fax messages.

Pulse

A form of rotary dialling on a telephone line.

Real Time Transmission

When memory is full, you can send faxes in real time.

Remaining Jobs

You can check which programmed fax jobs are waiting in the memory and cancel the jobs individually.

Remote Access Code

Your own four-digit code (– – –*) that allows you to call and access your machine from a remote location.

Remote Activation code

Press this code (* 5 1) when you answer a fax call on an extension or external telephone.

Remote Retrieval Access

The ability to access your machine remotely from a touch tone telephone.

Resolution

The number of vertical and horizontal lines per inch.

Ring Delay

The number of rings before the machine answers in Fax Only and Fax/Tel modes.

Ring Volume

Volume setting for the machine's ring.

Scanning

The process of sending an electronic image of a paper document into your computer.

Search

An electronic, alphabetical listing of stored One Touch, Speed Dial and Group numbers.

Speed Dial

A pre-programmed number for easy dialling. You must press , then enter the three-digit Speed Dial location and press **Start** to begin the dialling process.

Station ID

The stored information that appears on the top of faxed pages. It includes the sender's name and fax number.

TAD (telephone answering device)

You can connect an external TAD to your machine.

Tel Index List

A listing of names and numbers stored in One Touch and Speed Dial memory, in numerical order.

Temporary settings

You can choose certain options for each fax transmission and copy without changing the default settings.

Tone

A form of dialling on the telephone line used for Touch Tone telephones.

Transmission

The process of sending faxes over the telephone lines from your machine to the receiving fax machine.

User Settings List

A printed report that shows the current settings of the machine.

Xmit Report (Transmission Verification Report)

A listing for each transmission, that shows its date, time and number.

G

Index

- A**
- ADF (automatic document feeder)
 - faxing38
 - using20
 - Answering machine (TAD)
 - connecting55
 - Apple Macintosh
 - See Software User's Guide on the CD-ROM.
 - Automatic
 - fax receive48
 - easy receive50
 - Fax Detect50
 - fax redial61
- B**
- Broadcasting40
 - cancelling41
 - setting up groups for63
- C**
- Cancelling
 - broadcast in process41
 - fax jobs in memory45
 - jobs awaiting redial45
 - print jobs7
 - remote fax options67
 - Cleaning
 - corona wire145
 - drum unit146
 - laser scanner window144
 - scanner glass143
 - Connecting
 - external TAD (answering machine)54
 - external telephone57
 - Consumable items149
 - Control panel overview6
 - ControlCenter2 (for Macintosh)
 - See Software User's Guide on the CD-ROM.
 - ControlCenter3 (for Windows®)
 - See Software User's Guide on the CD-ROM.
- Copy**
- contrast78, 82
 - duplex84, 85
 - Enlarge/Reduce key79
 - enter copy mode78
 - keys8, 79
 - multiple78
 - N in 1 (page layout)82
 - out of memory86
 - quality81
 - single78
 - sort (ADF only)81
 - temporary settings79
 - tray selection83
 - using ADF81
 - using scanner glass82
- Cordless telephone (non-Brother)59**
- Cover page42**
- custom comments42
 - for all faxes42
 - for next fax only42
 - printed form43
- D**
- Delayed batch transmission45
 - Dialing
 - manual60
 - one touch60
 - speed dial60
 - using the Search key61
 - Dialling
 - a pause61
 - automatic fax redial61
 - groups (broadcasting)40
 - restricting dialling34
 - Direct print88
 - Direct key89
 - specification184
 - Document
 - how to load20, 21
 - jam134
 - Drum unit
 - checking (remaining life)155
 - cleaning145, 146
 - replacing153
 - Dual access44

Duplex (2-sided)	
copying	84, 85
printing	
from USB flash memory drive	90
troubleshooting	135
Duplex key (2-sided)	38, 84, 85

E

Enlarge/Reduce key	79
Envelopes	11, 14, 17, 18
Equalization	127
Error messages on LCD	128
Comm. Error	128
No Paper	130
Out of Memory	130
Print Unable XX	131
Scan Unable XX	131
Extension telephone, using	58, 59
External telephone, connecting	57

F

Fax codes	
changing	59, 68
fax receive code	59
remote access code	68
telephone answer code	59
Fax forwarding	
changing remotely	69, 70
programming a number	65
Fax storage	65
printing from memory	52
turning off	67
turning on	65
Fax, stand-alone	
receiving	
easy receive	50
fax forwarding	70
fax receive stamp	51
from extension telephone	59
into memory (fax storage)	65
polling receive	71
reducing to fit on paper	51
retrieving from a remote site	69, 70
ring delay, setting	49
sequential polling	72
telephone line interference	127

sending	38
broadcasting	40
cancelling from memory	45
contrast	43
delayed batch	45
delayed fax	45
from ADF	38
from memory (dual access)	44
from scanner glass	39
manual	45
overseas	44
polled transmit	72
real time transmission	44
resolution	43
telephone line interference	127

Fax/Tel mode

answering at extension telephones	59
easy receive	50
F/T ring time (double-ring)	49
fax receive code	59
receiving faxes	57
ring delay	49
telephone answer code	59
Folio	15

G

Greyscale	180, 182
Groups for broadcasting	63

H

HELP	75
Help List	75
LCD messages	159
Menu Table	159, 161
using menu keys	159

J

Jams	
document	134
paper	135
Job Cancel key	7

L

Labels	11, 14, 15, 19
LCD (liquid crystal display)	6, 159
contrast	27
Help List	75

M

Machine information	
checking remaining life of drum unit and periodic maintenance parts	155
Data LED	9
page counts	155
Macintosh	
See Software User's Guide on the CD-ROM.	
Maintenance, routine	142
checking the remaining life of drum unit	155
replacing	
drum unit	153
toner cartridge	150
Manual	
dialling	60
receive	48
transmission	45
Memory	
adding DIMM (option)	109
installing	110
storage	159
Menu Table	159, 161
using menu keys	159
Mode, entering	
copy	78
fax	38
scan	7
Multi-line connections (PBX)	56

N

N in 1 (page layout)	82
Network	
faxing	
See Software User's Guide on the CD-ROM.	
printing	
See Network User's Guide on the CD-ROM.	
scanning	
See Software User's Guide on the CD-ROM.	

O

One touch	
changing	63
setting up	61
using	60
Out of Memory message	46, 86, 91, 130

P

Packing and shipping the machine	157
Page layout (N in 1)	82
Paging	
programming your pager number	65
Paper	14, 178, 179
how to load	10
jam	135
recommended	14, 16
size	15, 23
size of document	181, 182
tray capacity	15
type	15, 22
PaperPort™ 11SE with OCR	
See Software User's Guide on the CD-ROM and Help in the PaperPort™ 11SE application to access How-to-Guides.	
PC Fax	
See Software User's Guide on the CD-ROM.	
Polling	
polled transmit	72
polling receive	71
sequential polling	72
Power failure	159

Print	
difficulties	111, 115
drivers	183
fax from memory	52
Job Cancel key	7
keys	7
paper jams	135
quality	117, 120
reports	75
resolution	183
Secure key	7
specifications	183
Printing	
See Software User's Guide on the CD-ROM.	
Programming your machine	159

Q

Quality	
copying	81
printing	117, 120
Quick dial	61
broadcasting	40
using groups	40
group dial	
changing	63
setting up groups for broadcasting	63
one touch dial	
changing	63
custom scan profile	61
setting up	61
using	60
search	61
speed dial	
changing	63
custom scan profile	62
setting up	62
using	60

R

Redial/Pause key	61
Reducing	
copies	79
incoming faxes	51
Remote retrieval	68
access code	68
commands	70
getting your faxes	69
Remote setup	
See Software User's Guide on the CD-ROM.	
Replacing	
drum unit and periodic maintenance	
parts	153
toner cartridge	150
Reports	74, 75
Fax Journal	74, 75
journal period	74
Help List	75
how to print	75
Network Configuration	75
Tel Index List	75
Transmission Verification	74
User Settings	75
Resolution	
copy	181
fax (standard, fine, superfine, photo)	43, 180
print	183
scan	182
setting for next fax	43
Resolution key	6, 43
Restricted users	30
Ring delay, setting	49

S

Safety instructions	103
Scanner glass	
faxing	39
using	21
Scanning	
See Software User's Guide on the CD-ROM.	
Search/Speed Dial key	60, 61, 63
Secure key	7
Security	
restricting dialling	34
Secure function lock	
administrator password	28
Public user	29
restricted users	30
Secure key	7
Setting lock	33
Serial number	
how to find.....	See inside front cover
Shipping the machine	157
Sleep time	26
Socket	
EXT	
TAD (answering machine)	54
Sockets	
EXT	
external telephone	57
Sort	81
Speed dial	
changing	63
setting up	62
using	60
Status LED	9

T

TAD (telephone answering device),	
external	48
connecting	54, 55
recording OGM	55
Tel/R key	6
Telephone line	
connections	55
difficulties	111
interference	127
multi-line (PBX)	56
Temporary copy settings	79

Text, entering	174
Toner cartridge, replacing	150
Toner save	26
Transparencies	10, 11, 14
Tray selection	83
Tray use, setting	
copy	23
fax	24
print	24
Troubleshooting	111
document jam	134
error messages on LCD	128
if you are having difficulty	
copy quality	114
incoming calls	114
network	117
paper handling	116
print quality	117, 120
printing	111, 115
scanning	116
software	116
telephone line	127
maintenance messages on LCD	128
paper jam	135

V

Volume, setting	
beeper	25
ring	25
speaker	25

W

Windows®	
See Software User's Guide on the CD-ROM.	

brother[®]

The machine is approved for use in the country of purchase only, local Brother companies or their dealers will only support machines purchased in their own countries.

Free Manuals Download Website

<http://myh66.com>

<http://usermanuals.us>

<http://www.somanuals.com>

<http://www.4manuals.cc>

<http://www.manual-lib.com>

<http://www.404manual.com>

<http://www.luxmanual.com>

<http://aubethermostatmanual.com>

Golf course search by state

<http://golfingnear.com>

Email search by domain

<http://emailbydomain.com>

Auto manuals search

<http://auto.somanuals.com>

TV manuals search

<http://tv.somanuals.com>