

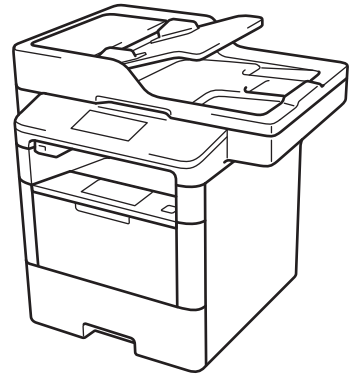

Basic User's Guide

DCP-L5500DN
DCP-L6600DW
MFC-L5700DN
MFC-L5750DW
MFC-L6800DW
MFC-L6900DW



Brother recommends keeping this guide next to your Brother machine for quick reference.



Online User's Guide

This Basic User's Guide contains basic instructions and information for your Brother machine.

For more advanced instructions and information, see the Online User's Guide at solutions.brother.com/manuals



If you need to call Customer Service

Please complete this information for future reference:

Model Number: DCP-L5500DN/DCP-L6600DW/MFC-L5700DN/
(Circle your model MFC-L5750DW/MFC-L6800DW/MFC-L6900DW
number)

Serial Number: ¹ _____

Date of Purchase: _____

Place of Purchase: _____

¹ The serial number is on the back of the machine. Retain this User's Guide with your sales receipt as a permanent record of your purchase, in the event of theft, fire or warranty service.

Register your product online at

<http://www.brother.com/registration>

For the Latest Driver Updates

Go to your model's **Downloads** page on the Brother Solutions Center at support.brother.com to download drivers.

To keep your machine's performance up-to-date, check there for the latest firmware upgrades.

User's Guides and Where to Find Them

Which Guide?	What's in It?	Where Is It?
Product Safety Guide	Read this Guide first. Please read the Safety Instructions before you set up your machine. See this Guide for trademarks and legal limitations.	Printed / In the box
Quick Setup Guide	Follow the instructions for setting up your machine, and installing the drivers and software for the operating system and connection type you are using.	Printed / In the box
Basic User's Guide	Learn the basic Fax, Copy and Scan operations and basic machine maintenance. See troubleshooting tips.	Printed / In the box
Online User's Guide	This guide includes the additional contents of the Basic User's Guide. In addition to information about the Print, Scan, Copy, Fax and Brother ControlCenter operations, useful information is included about using the machine on a network.	HTML and PDF file / Brother Solutions Center ¹
Web Connect Guide	This Guide provides useful information about accessing Internet services from the Brother machine, as well as downloading images, printing data and uploading files directly to Internet services.	PDF file / Brother Solutions Center ¹
AirPrint Guide	This Guide provides information for using AirPrint to print from OS X v10.8.5 or later and your iPhone, iPod touch, iPad, or other iOS device to your Brother machine without installing a printer driver.	PDF file / Brother Solutions Center ¹
Google Cloud Print Guide	This Guide provides details about how to use Google Cloud Print™ services for printing over the Internet.	PDF file / Brother Solutions Center ¹
Mobile Print/Scan Guide for Brother iPrint&Scan	This Guide provides useful information about printing from your mobile device, and scanning from your Brother machine to your mobile device when connected to a Wi-Fi® network.	PDF file / Brother Solutions Center ¹

¹ Visit solutions.brother.com/manuals.

The Online User's Guide Helps You Get the Most Out of Your Machine

We hope that you find this guide helpful. To learn more about your machine's features, please take a look at our Online User's Guide. It offers:

Quicker Navigation!

- ✓ Search box
- ✓ Navigation index in a separate panel

Comprehensive!

- ✓ Every topic in one guide

Simplified Layout!

- ✓ Provides step-by-step instructions
- ✓ Feature summary at the top of the page



1. Search Box
2. Navigation
3. Summary
4. Step-by-Step Instructions

To View Online User's Guides

To view the Online User's Guide and other available guides, visit solutions.brother.com/manuals.

(Windows®)

You can also access your machine's guides using Brother Utilities. The Brother Utilities tool is included in the standard installation and, when installed, you can find it either as a shortcut on your desktop, or from the Windows® **Start** menu.

Questions or Problems? Take a Look at our FAQs, Solutions, and Videos Online.

Go to your model's FAQs & Troubleshooting page on the Brother Solutions Center at support.brother.com.

- Provides several ways to search!
- Displays related questions for more information
- Receives regular updates based on customer feedback

FAQs & Troubleshooting

Categorised Popular Latest

How To / Troubleshooting

- ▶ [Error Messages](#) ▶ [Paper Feed/Paper Jam](#) ▶ [Print](#) ▶ [Scan](#)
- ▶ [Copy](#) ▶ [Telephone](#) ▶ [Fax](#) ▶ [Mobile](#) ▶ [Cloud](#)

Setup / Settings

- ▶ [Product Setup](#) ▶ [Driver/Software](#)

Consumables & Accessories / Routine Maintenance

- ▶ [Consumables/Paper/Accessories](#) ▶ [Cleaning](#)

Others

- ▶ [Specification](#) ▶ [OS Support Information](#) ▶ [Video FAQs](#)

Search by Keyword(s)

Enter the keywords. [▶ Search by FAQ ID number](#)

Categorised Popular Latest

Since the Brother Solutions Center is updated regularly, this screen is subject to change without notice.

Definitions of Notes

We use the following symbols and conventions throughout this User's Guide:

WARNING

WARNING indicates a potentially hazardous situation which, if not avoided, could result in death or serious injuries.

CAUTION

CAUTION indicates a potentially hazardous situation which, if not avoided, may result in minor or moderate injuries.

IMPORTANT

IMPORTANT indicates a potentially hazardous situation which, if not avoided, may result in damage to property or loss of product functionality.

NOTE

NOTE specifies the operating environment, conditions for installation, or special conditions of use.



Tips icons indicate helpful hints and supplementary information.



Electrical Hazard icons alert you to possible electrical shock.



Fire Hazard icons alert you to the possibility of a fire.



Hot Surface icons warn you not to touch hot machine parts.



Prohibition icons indicate actions you must not perform.

Bold

Bold style identifies buttons on the machine's control panel or computer screen.

Italics

Italicised style emphasises an important point or refers you to a related topic.

[Courier New]

Courier New font identifies messages shown on the machine's LCD.

Compilation and Publication Notice

This manual has been compiled and published to provide the latest product safety information at the time of publication. The information contained in this manual may be subject to change.

For the latest manual, visit solutions.brother.com/manuals.

Important Note

- This documentation is for both MFC and DCP models. Read 'XXX-XXXX' as 'MFC/DCP-XXXX' (where XXXX is the name of your model).

Table of Contents

1	General Information	1
	Control Panel Overview	1
	Touchscreen LCD Overview	3
	How to Navigate the Touchscreen LCD	5
	Access Brother Utilities (Windows®)	6
	Uninstall the Brother Software and Drivers (Windows®)	6
	Initial Setup	7
	Set the Date and Time	7
	Adjust the Machine's Volume	7
2	Paper Handling	8
	Load Paper	8
	Load Paper in the Paper Tray	8
	Load Paper in the Multi-purpose Tray (MP Tray)	10
	Change the Check Paper Size Setting	11
	Change the Paper Size and Paper Type	12
	Recommended Print Media	12
	Using Special Paper	13
3	Print	14
	Print from Your Computer	14
	Print a Document (Macintosh)	14
	Print a Document (Windows®)	14
	Print on Both Sides of the Paper Automatically (Windows®)	14
	Print More Than One Page on a Single Sheet of Paper (N in 1) (Windows®)	15
	Print on Envelopes, Thick Paper or Labels	16
4	Copy	18
	Copy a Document	18
	Copy Settings	20
	Copy Options	20
	Copy Multiple Pages on Both Sides of the Paper	22
	Copy a 2-sided Document Using the ADF	23
	Copy a 2-sided Document Using the Scanner Glass	24
	Copy an ID Card	24
5	Scan	26
	Scan from Your Computer (Windows®)	26
	Save Scanned Documents and Photos to a Folder as a PDF File Using ControlCenter4 Advanced Mode (Windows®)	26

Scan Using the Scan Button on Your Brother Machine	27
Scan Using the Scan Button on the Machine	27
6 Fax	29
Before Faxing	29
Set Your Station ID	29
Set Telephone Line Compatibility for Interference and VoIP Systems.....	30
Receive Modes	30
Choose the Correct Receive Mode.....	32
Set the F/T Ring Time (Fast Double-ring).....	33
Set the Number of Rings Before the Machine Answers (Ring Delay)	33
Store Numbers	34
Store Address Book Numbers	34
Change or Delete Address Book Names or Numbers	34
Telephone Services and External Devices	36
Voice Mail	36
Voice Over Internet Protocol (VoIP).....	36
Connection of an External Telephone Answering Device (TAD).....	36
External and Extension Telephones	36
Send and Receive a Fax Using Your Machine	37
Send a Fax	37
Fax Using Your Computer (PC-FAX).....	39
Send Faxes from Your Computer	39
Receive Faxes on Your Computer (Windows® only)	39
A Troubleshooting	41
Identify the Problem.....	41
Error and Maintenance Messages.....	42
Fax and Telephone Problems.....	48
Troubleshooting for Other Fax Problems.....	49
Print or Scan Problems.....	51
Document and Paper Jams	53
Find the Jammed Document or Paper	53
Clear the Document Jam	53
Clear the Paper Jam	54
B Appendix	61
How to Enter Text on Your Brother Machine	61
Information for Compliance with Commission Regulation 801/2013	62
Supplies.....	63
C Index	64

Control Panel Overview

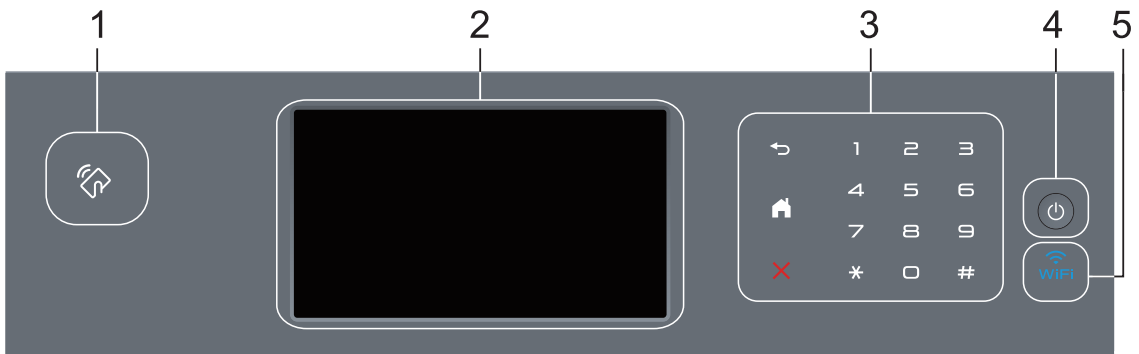

1. Near Field Communication (NFC) Reader (available only for certain models)

You can use card authentication by touching the IC card to the NFC Reader on the control panel.

If your Android™ device supports the NFC feature, you can print from your device or scan documents to your device in the same way.

2. Touchscreen Liquid Crystal Display (LCD)

Access menus and options by pressing them on the Touchscreen.

3. Touchpanel



(Back)

Press to go back to the previous menu.



(Home)

- Press to return to the Home screen.
- While the machine is in Sleep Mode, the Home icon blinks.





(Cancel)

Press to cancel an operation (available when lit).

Dial Pad (Numerical buttons)

Press the numbers on the Touchpanel to dial telephone or fax numbers and to enter the number of copies.

4. Power On/Off

- Turn the machine on by pressing .
- Turn the machine off by pressing and holding down . The LCD displays [Shutting Down] for a few seconds before going off. If you have an external telephone or TAD connected, it is always available.

5. (WiFi)

(For infrastructure mode)

When the **WiFi** light is on, your Brother machine is connected to a wireless access point.

When the **WiFi** light blinks, the wireless connection is down, or your machine is in the process of connecting to a wireless access point.

(For Ad-Hoc mode)

The **WiFi** LED is always off.

Touchscreen LCD Overview

You can select from two types of screens to set the Home screen: Function screens and Shortcuts screen. When a Function screen is displayed, swipe left or right or press ◀ or ▶ to display the other Function screens.

The Home screen displays the machine's status when the machine is idle. This screen is also called the Ready Mode screen. When displayed, this screen indicates that your machine is ready for the next command.

If Active Directory® Authentication or LDAP Authentication is enabled, the machine's control panel will be locked.

The available features vary depending on your model.

Function screens

The Function screens provide access to features, such as Fax, Copy and Scan.

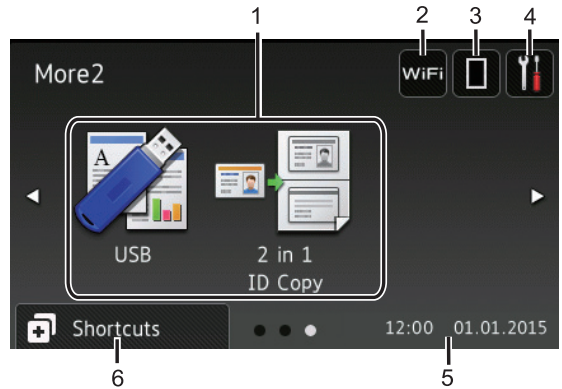
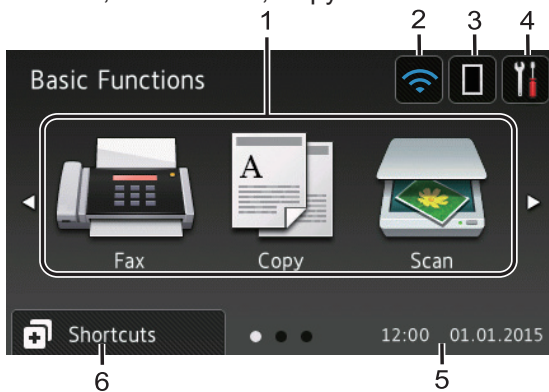

Shortcuts screen





Create Shortcuts for frequently-used operations, such as sending a fax, copying, scanning and using Web Connect.

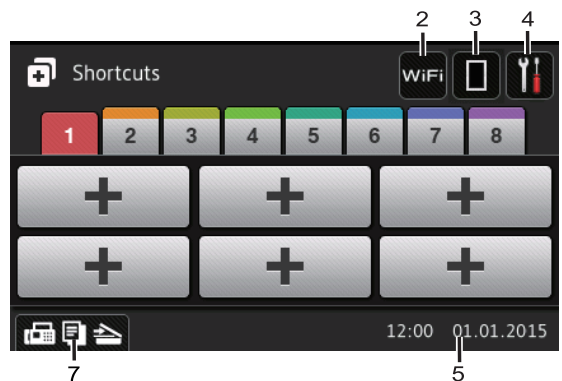

Eight Shortcuts tabs are available with six Shortcuts on each Shortcuts tab. A total of 48 Shortcuts are available.



1. Modes

-  [Fax]
Press to access Fax mode.
-  [Copy]
Press to access Copy mode.
-  [Scan]
Press to access Scan mode.
-  [Secure Print]
Press to access the [Secure Print] option.

•  [Web]

Press to connect the Brother machine to an Internet service. For more information, see the *Web Connect Guide*. Go to your model's **Manuals** page on the Brother Solutions Center at support.brother.com to download the guide.

•  [Apps]

Press to connect the Brother machine to the Brother Apps service. For more information, see the *Web Connect Guide*. Go to your model's **Manuals** page on the Brother Solutions Center at support.brother.com to download the guide.

•  [USB]

Press to access the Direct Print and Scan to USB menus.

•  [2 in 1 ID Copy]

Press to access the 2 in 1 ID Copy option.

2.  or  (Wireless Status)

Press to configure wireless settings.

If you are using a wireless connection, a four-level indicator displays the current wireless signal strength.



3.  (Toner)

Displays the remaining toner life. Press to access the [Toner] menu.

4.  (Settings)

Press to access the [Settings] menu.

If Setting Lock has been turned on, a lock  icon appears on the LCD. You must unlock the machine to change settings.

5. **Date & Time**

Displays the date and time set on the machine.

6.  [Shortcuts]

Press to access the [Shortcuts] screen.

7.  (Function screens)

Press to access the Function screens.

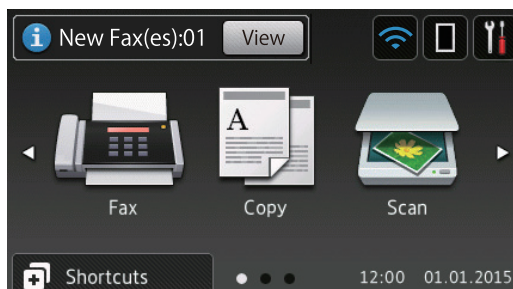

New Fax

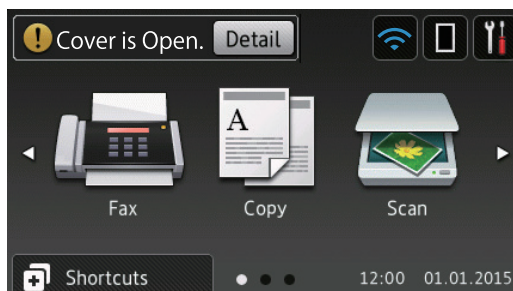

When [Fax Preview] is set to [On], the number of new faxes you received into the memory appears at the top of the screen.

Warning icon



The warning icon  appears when there is an error or maintenance message; press  to view it, and then press  to return to Ready Mode.

NOTE

This product adopts the font of ARPHIC TECHNOLOGY CO., LTD.

How to Navigate the Touchscreen LCD

Press your finger on the LCD to operate it. To display and access all the options, swipe left, right, up, down or press ◀▶ or ▲▼ on the LCD to scroll through them.

The following steps explain how to change a machine setting. In this example, the LCD Backlight setting is changed from [Light] to [Med].

IMPORTANT

DO NOT press the LCD with a sharp object, such as a pen or stylus. It may damage the machine.

NOTE

DO NOT touch the LCD immediately after plugging in the power cord or turning on the machine. Doing this may cause an error.

1 Press  [Settings].

2 Press [All Settings].

3 Swipe up or down or press ▲ or ▼ to display the [General Setup] option, and then press [General Setup].

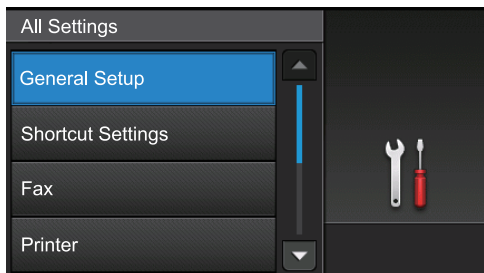

4 Swipe up or down or press ▲ or ▼ to display the [LCD Settings] option, and then press [LCD Settings].

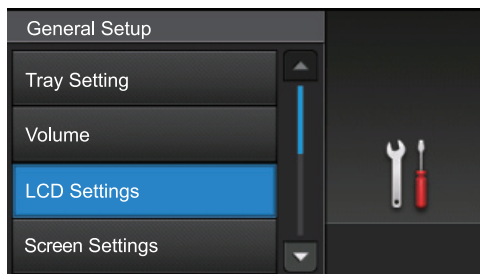

5 Press [Backlight].

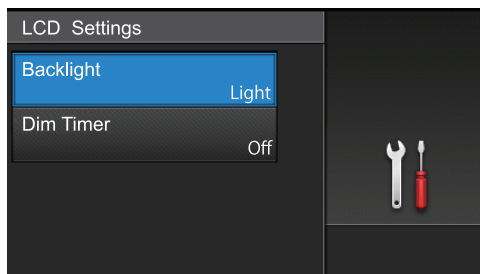

6 Press [Med].

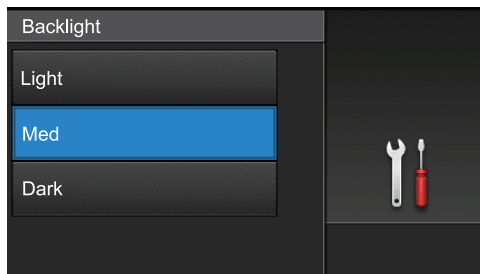

7 Press .

Access Brother Utilities (Windows®)

Brother Utilities is an application launcher that offers convenient access to all Brother applications installed on your computer.

1 Do one of the following:

- (Windows® XP, Windows Vista®, Windows® 7, Windows Server® 2003, Windows Server® 2008 and Windows Server® 2008 R2)

Click  (**Start**) > **All Programs** > **Brother** > **Brother Utilities**.

- (Windows® 8 and Windows Server® 2012)

Tap or click  (**Brother Utilities**) either on the **Start** screen or the desktop.

- (Windows® 8.1 and Windows Server® 2012 R2)

Move your mouse to the lower left corner of the **Start** screen and click  (if you are using a touch-based device, swipe up from the bottom of the **Start** screen to bring up the **Apps** screen).

When the **Apps** screen appears, tap or click  (**Brother Utilities**).

2 Select your machine (where XXXX is the name of your model).

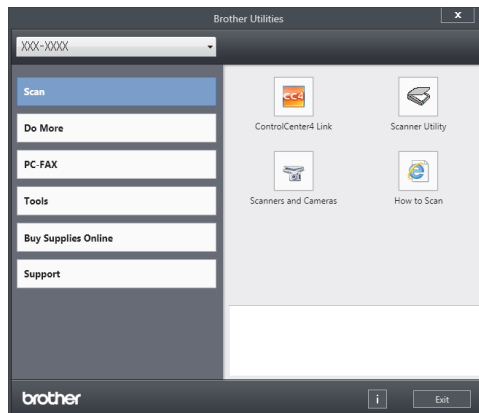

3 Choose the operation you want to use.



Uninstall the Brother Software and Drivers (Windows®)

1 Launch  (**Brother Utilities**).

2 Click the drop-down list, and then select your model name (if not already selected). Click **Tools** in the left navigation bar, and then click **Uninstall**. Follow the instructions in the dialog box to uninstall the software and drivers.

Initial Setup

Set the Date and Time

- 1 Press  [Settings] > [All Settings] > [Initial Setup] > [Date & Time] > [Date].
- 2 Enter the last two digits of the year using the LCD, and then press [OK].
- 3 Enter the two digits for the month using the LCD, and then press [OK].
- 4 Enter the two digits for the day using the LCD, and then press [OK].
- 5 Press [Time].
- 6 Enter the time (in 24-hour format) using the LCD, and then press [OK].
(For example: enter 19:45 for 7:45 PM.)
- 7 Press .

Adjust the Machine's Volume

- 1 Press  [Settings] > [All Settings] > [General Setup] > [Volume].
- 2 Press one of the following options:
(The options will vary depending on your machine.)
 - [Ring]
Adjust the ring volume.
 - [Beep]
Adjust the volume of the beep you hear when you press a button, make

a mistake, or after you send or receive a fax.

- [Speaker]

Adjust the speaker volume.

- 3 Swipe up or down or press ▲ or ▼ to display the [Off], [Low], [Med] or [High] option, and then press the option you want.
- 4 Press .

2

Paper Handling

Load Paper

Load Paper in the Paper Tray

- If the Check Size setting is set to On and you pull the paper tray out of the machine, a message appears on the LCD asking if you want to change the paper size. Change the paper size and paper type settings if needed, following the on-screen instructions.
- When you load a different size and type of paper in the tray, you must change the Paper Size and Paper Type settings in the machine or on your computer, also.
- When you use thick paper, open the back cover (face up output tray) to let the printed paper exit onto the face up output tray.

- 1 Pull the paper tray completely out of the machine.

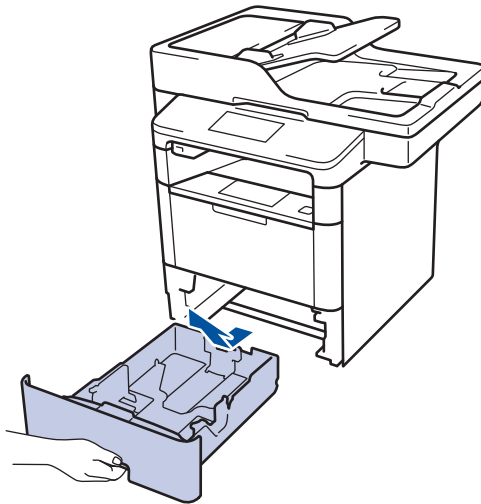

- 2 Press and slide the paper guides to fit the paper.

Press the green release levers to slide the paper guides.

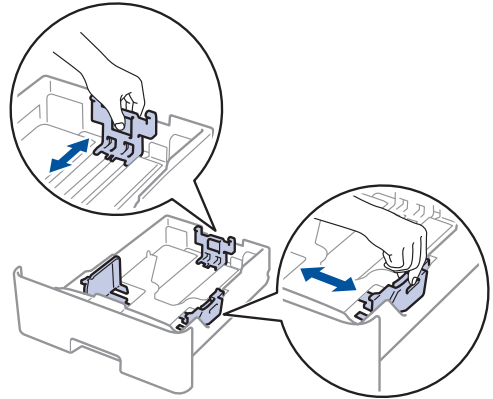

- 3 Fan the stack of paper well.

- 4 Load paper in the paper tray with the printing surface *face down*.

When you use Letterhead or Preprinted paper, load the paper in the correct orientation as shown in the illustrations.

Paper Orientation for Letterhead and Preprinted Paper

For 1-sided printing

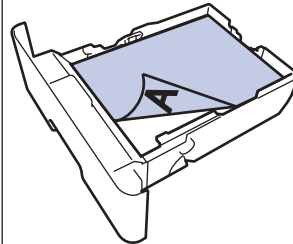

- face down
- top edge toward the front of the paper tray

For automatic 2-sided printing (long edge binding)

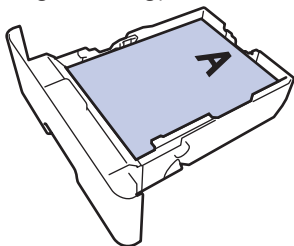

- face up
- bottom edge toward the front of the paper tray

7 Lift the support flap to prevent paper from sliding off the output tray.

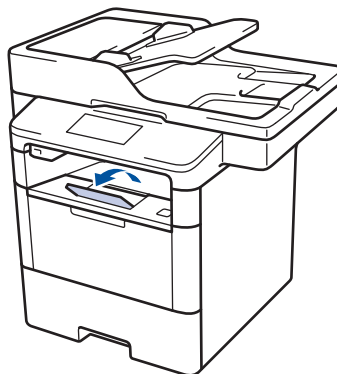

- DO NOT load different sizes and types of paper in the paper tray at the same time. Doing this may cause the paper to jam or misfeed.
- When you use Letterhead or Preprinted paper for 2-sided printing, change the machine's setting by completing the following step:
 - Press  [Settings] > [All Settings] > [Printer] > [2-sided] > [Single Image] > [2-sided Feed].

5 Make sure the paper is below the maximum paper mark (▼▼▼).
Overfilling the paper tray will cause paper jams.

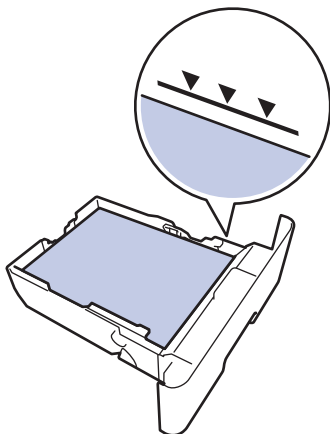

6 Slowly push the paper tray completely into the machine.

Load Paper in the Multi-purpose Tray (MP Tray)

When you load a different size and type of paper in the tray, you must change the Paper Size and Paper Type settings in the machine or on your computer, also.

When you use envelopes, thick paper, or labels, see *Related Information: Print on Envelopes, Thick Paper or Labels*.

- 1 Lift the support flap to prevent paper from sliding off the face down output tray.



- 2 Open the MP tray and lower it gently.

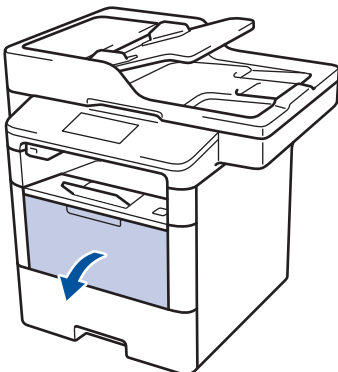

- 3 Pull out the MP tray support (1) and unfold the flap (2).



- 4 Slide the MP tray paper guides to fit the width of the paper you are using. If the paper guide on the right side has a lever, press it and slide the paper guide.

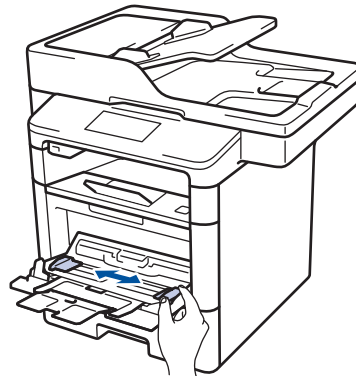

- 5 Load paper with the printing surface *face up* in the MP tray. When you use Letterhead or Preprinted paper, load the paper in the correct orientation as shown in the illustrations.

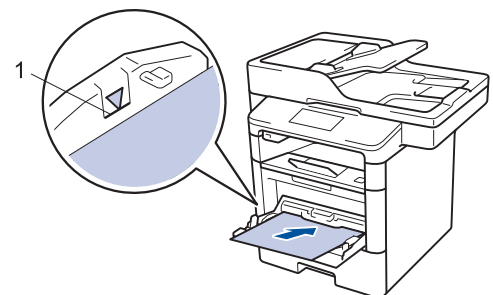



Make sure the paper is below the maximum paper mark (1).

Paper Orientation for Letterhead and Preprinted Paper

For 1-sided printing

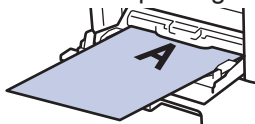

- face up
- top edge first

For automatic 2-sided printing (long edge binding)

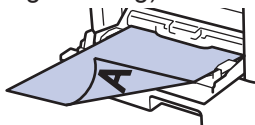

- face down
- bottom edge first



When you use Letterhead or Preprinted paper for 2-sided printing, change the machine's setting by completing the following step:

- Press  [Settings] > [All Settings] > [Printer] > [2-sided] > [Single Image] > [2-sided Feed].



Related Information

- Print on Envelopes, Thick Paper or Labels on page 16

Change the Check Paper Size Setting



When you turn on your machine's Check Size setting, the machine displays a message when you remove a paper tray or load paper using the MP tray, asking if you changed the paper size and paper type.

The default setting is On.

- 1 Press  [Settings] > [All Settings] > [General Setup] > [Tray Setting] > [Check Size].
- 2 Press [On] or [Off].
- 3 Press .

Change the Paper Size and Paper Type

When you change the size and type of the paper you load in the tray, you must change the Paper Size and Paper Type settings on the LCD at the same time.

- 1 Press  [Settings] > [All Settings] > [General Setup] > [Tray Setting] > [Paper Type].
- 2 Swipe up or down or press ▲ or ▼ to display the paper tray options, and then press the option you want.
- 3 Swipe up or down or press ▲ or ▼ to display the paper type options, and then press the option you want.
- 4 Press .
- 5 Swipe up or down or press ▲ or ▼ to display the [Paper Size] option, and then press [Paper Size].
- 6 Swipe up or down or press ▲ or ▼ to display the paper tray options, and then press the option you want.
- 7 Swipe up or down or press ▲ or ▼ to display the paper size options, and then press the option you want.
- 8 Press .

Recommended Print Media

To get the best print quality, we recommend using the paper listed in the table.

Paper Type	Item
Plain Paper	Xerox Premier TCF 80 g/m ²
	Xerox Business 80 g/m ²
Recycled Paper	Steinbeis Evolution White 80 g/m ²
Labels	Avery laser label L7163
Envelopes	Antalis River series (DL)

Using Special Paper

Always test paper samples before purchasing them to ensure desirable performance.

- DO NOT use inkjet paper; it may cause a paper jam or damage your machine.
- If you use bond paper, paper with a rough surface, or paper that is wrinkled or creased, the paper may exhibit degraded performance.

Store paper in its original packaging and keep it sealed. Keep the paper flat and away from moisture, direct sunlight and heat.

IMPORTANT

Some types of paper may not perform well or may cause damage to your machine.

DO NOT use paper:

- that is highly textured
- that is extremely smooth or shiny
- that is curled or warped
- that is coated or has a chemical finish
- that is damaged, creased or folded
- that exceeds the recommended weight specification in this guide
- with tabs and staples
- with letterheads using low temperature dyes or thermography
- that is multipart or carbonless
- that is designed for inkjet printing

If you use any of the types of paper listed above, they may damage your machine. This damage is not covered under any Brother warranty or service agreement.

Print from Your Computer

Print a Document (Macintosh)

For printing instructions, see the *Online User's Guide: Print from Your Computer (Macintosh)*.

Print a Document (Windows®)

- 1 Select the print command in your application.
- 2 Select **Brother XXX-XXXX** (where XXXX is the name of your model).
- 3 Click **Print**.
- 4 Complete your print operation.



For more information, see the *Online User's Guide: Print from Your Computer (Windows®)*.

Print on Both Sides of the Paper Automatically (Windows®)

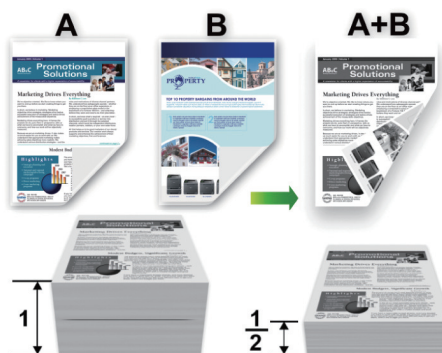

- Select A4 size paper when using the automatic 2-sided printing option.

- 1 Select the print command in your application.
- 2 Select **Brother XXX-XXXX** (where XXXX is the name of your model), and then click the printing properties or preferences button.
The printer driver window appears.
- 3 In the **Orientation** field, select the **Portrait** or **Landscape** option to set the orientation of your printout.



If your application contains a similar setting, we recommend that you set the orientation using the application.

- 4 Click the **2-sided / Booklet** drop-down list and select the **2-sided** option.

- 5 Click the **2-sided Settings** button.
- 6 Select an option from the **2-sided Type** menu.
- 7 If you want to specify the offset for binding in inches or millimeters, select the **Binding Offset** check box.
- 8 Click **OK**.
- 9 Click **OK** again, and then complete your print operation.

Print More Than One Page on a Single Sheet of Paper (N in 1) (Windows®)



- 1 Select the print command in your application.
- 2 Select **Brother XXX-XXXX** (where XXXX is the name of your model), and then click the printing properties or preferences button.
The printer driver window appears.
- 3 In the **Orientation** field, select the **Portrait** or **Landscape** option to set the orientation of your printout.



If your application contains a similar setting, we recommend that you set the orientation using the application.

- 4 Click the **Multiple Page** drop-down list and select the **2 in 1**, **4 in 1**, **9 in 1**, **16 in 1**, or **25 in 1** option.
- 5 Click **OK**.
- 6 Complete your print operation.

Print on Envelopes, Thick Paper or Labels

When the back cover (face up output tray) is pulled down, the machine has a straight paper path from the MP tray on the front of the machine through the back of the machine and onto the face up output tray. Use the MP tray and output method for printing on thick paper or envelopes.

- Load the paper or envelope into the MP tray with the printing surface face up.
- DO NOT load more than 10 envelopes in the MP tray. Doing this may cause a jam.
- DO NOT exceed the maximum paper mark when you load paper in the MP tray. Doing this may cause a jam.

- 1 Open the machine's back cover (the face up output tray).

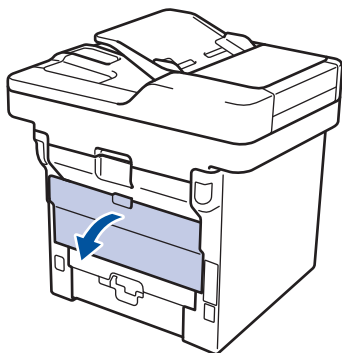

- 2 Open the paper stopper (Available only for certain models).

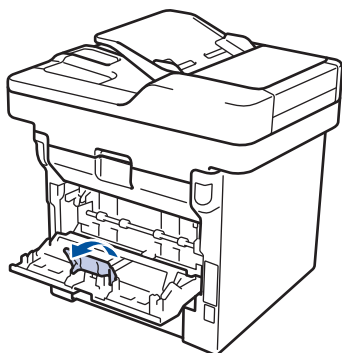

- 3 On the front of the machine, open the MP tray and lower it gently.

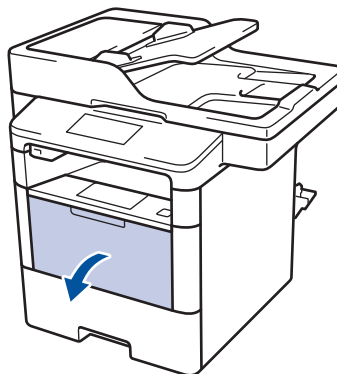

- 4 Pull out the MP tray support (1) and unfold the flap (2).

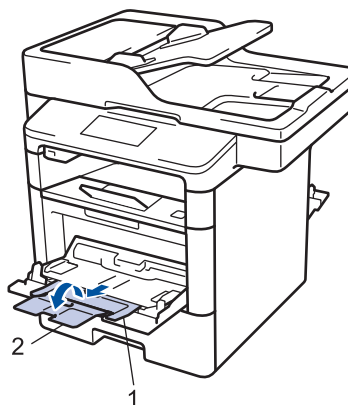

- 5 Slide the MP tray paper guides to fit the width of the paper that you are using. If the paper guide on the right side has a lever, press it and slide the paper guide.

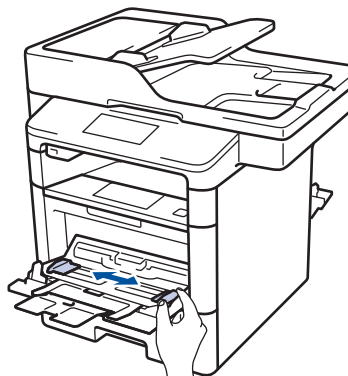

6 Load paper or labels in the MP tray.

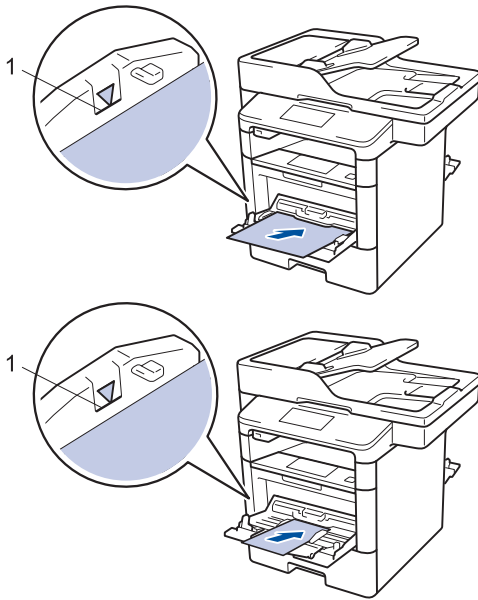

- Make sure the paper is below the maximum paper mark (1).
- Load paper into the MP tray with the printing surface face up.

7 Select the print command in your application.

8 Select **Brother XXX-XXXX** (where XXXX is the name of your model), and then click the printing properties or preferences button.

The printer driver window appears.

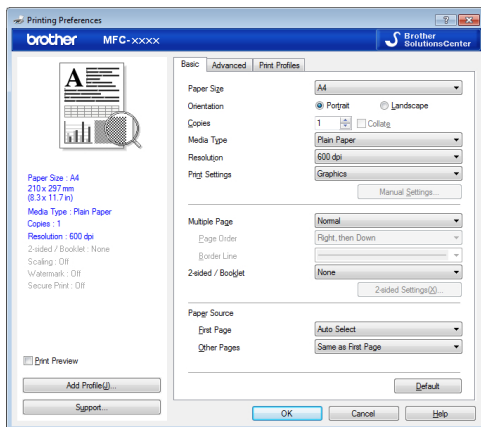

9 Click the **Paper Size** drop-down list and select your paper size.

10 Click the **Media Type** drop-down list and select the type of paper you are using.

11 Click the **First Page** and **Other Pages** drop-down lists and select **MP Tray**.

12 In the **Orientation** field, select the **Portrait** or **Landscape** option to set the orientation of your printout.



If your application contains a similar setting, we recommend that you set the orientation using the application.

13 Change other printer settings if needed.

14 Click **OK**.

15 Click **Print**.

Related Information

- Load Paper in the Multi-purpose Tray (MP Tray) on page 10

Copy a Document

1 Make sure you have loaded the correct size paper in the paper tray.

2 Do one of the following:

- Place the document *face up* in the ADF.

(If you are copying multiple pages, we recommend using the ADF.)

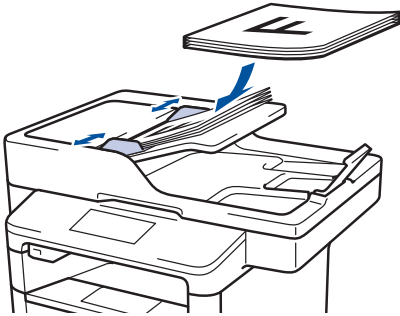

- Place the document *face down* on the scanner glass.



3 Press  [Copy].

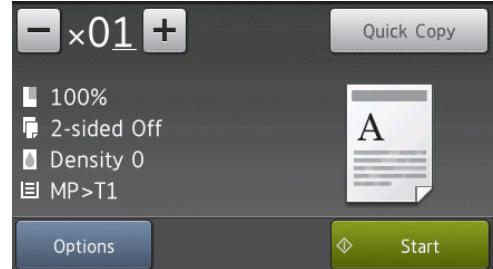

The LCD displays:



4 Change the copy settings, if needed.

- **x01** (Number of copies)

Enter the number of copies in one of the following ways:

- Press  or  on the LCD.
- Press the numbers on the control panel.
- [Options]





Press  to change the copy settings for the next copy only.

- When finished, press [OK].
- After you have finished choosing new options, you can save them by pressing the [Save as Shortcut] button.
- [Quick Copy]

Press  to access the preset copy settings.

- Current setting indications

Press the following icons to change these settings for the next copy only.

-  [Enlarge/Reduce]
-  [2-sided Copy]
-  [Density]
-  [Tray Use]

5 Press [Start].



To stop copying, press .

Copy Settings

Copy Options

To change Copy settings, press [Options].

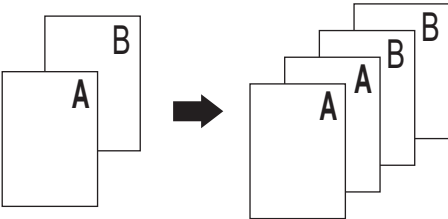
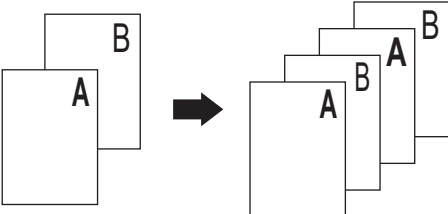
Menu selections	Options	
Quality	Select the copy quality for your type of document.	
Enlarge/Reduce	100%	-
	Enlarge	Select an enlargement ratio for the next copy.
	Reduce	Select a reduction ratio for the next copy.
	Auto	Adjusts the copy size to fit on the paper size you have set.
	Custom (25-400%)	Enter an enlargement or reduction ratio.
Density	Increase the density to make the text darker. Decrease the density to make the text lighter.	
Contrast	Increase the contrast to make an image clearer. Decrease the contrast to make an image more subdued.	
Stack/Sort	Select to stack or sort multiple copies. Stack  Sort 	

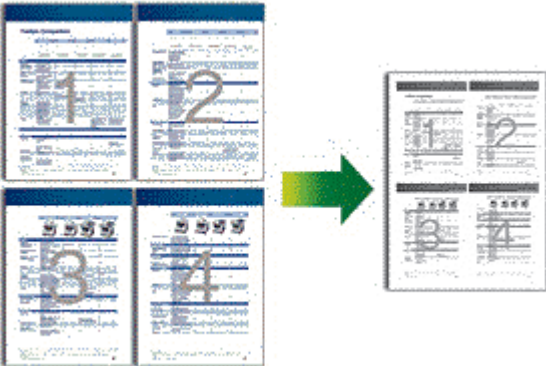
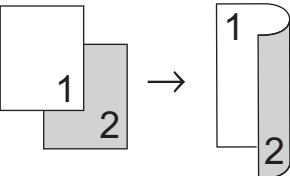
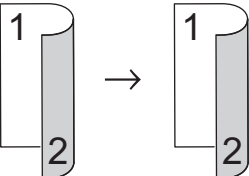
Menu selections	Options
Page Layout	<p>Make N in 1 or 2 in 1 ID copies.</p> <p>4 in1</p> 
2-sided Copy	<p>Select to copy on both sides of the paper.</p> <p>1-sided → 2-sided</p>  <p>2-sided → 2-sided</p>  <p>The available options will vary depending on your model.</p>
2-sided Copy Page Layout (available only for certain settings)	Select long edge binding or short edge binding.
Tray Use	Select a paper tray for the next copy.
Save as Shortcut	Add the current settings as a shortcut.

Copy Multiple Pages on Both Sides of the Paper

- You must choose a layout option before you can start 2-sided copying.
- Select A4 size paper when using the 2-sided copy option.

Portrait

1-sided to 2-sided (Long Edge Flip)

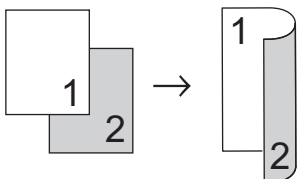

1-sided to 2-sided (Short Edge Flip)

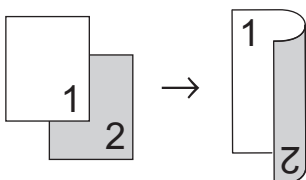

Landscape

1-sided to 2-sided (Long Edge Flip)

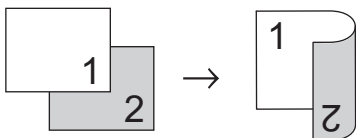

1-sided to 2-sided (Short Edge Flip)

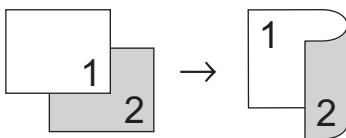

- 1 Make sure you have loaded the correct size paper in the paper tray.

- 2 Do one of the following:

- Place the document *face up* in the ADF.

(If you are copying multiple pages, we recommend using the ADF.)

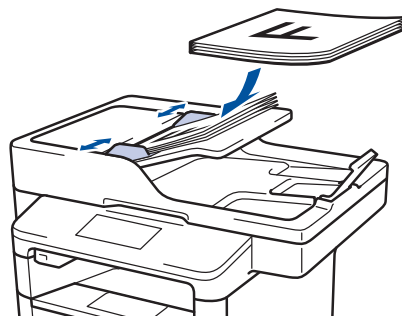

- Place the document *face down* on the scanner glass.

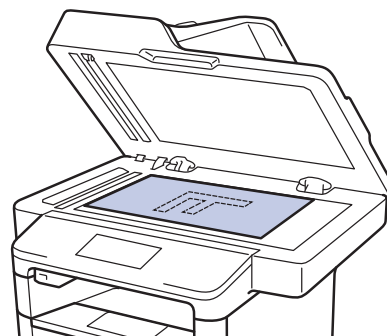

- 3 Press  [Copy].

- 4 Enter the number of copies.

- 5 Press [Options] > [2-sided Copy].

- 6 To change the layout options, press [Layout].

- a. Press the layout option you want.

- [Long Edge Flip]
- [Short Edge Flip]

- 7 Press [1-sided⇒2-sided].

- 8 Press [OK].

9 Press [Start] to scan the page.

If you are using the ADF, the machine feeds and scans the pages and starts printing.

If you are using the scanner glass, go to the next step.

10 After the machine scans the page, press the [Continue] or [Finish] button.

- To scan another page, place the next page on the scanner glass and then press [Continue].
- If you have scanned all the pages, press [Finish].

DO NOT touch the printed page until it is ejected the second time. The machine will print the first side and eject the paper, and then pull the paper back in to print the second side.

Copy a 2-sided Document Using the ADF

Related Models:

DCP-L6600DW/MFC-L5750DW/MFC-L6800DW/
MFC-L6900DW

When you use the ADF to copy a 2-sided document, you can make 2-sided copies automatically.

- Select A4 size paper when using the 2-sided copy option.

- 1** Make sure you have loaded the correct size paper in the paper tray.
- 2** Place the document *face up* in the ADF.
- 3** Press  [Copy].
- 4** Enter the number of copies.
- 5** Press [Quick Copy] > [2sided(2⇒2)].
- 6** Press [Start].
The machine feeds and scans the pages and starts printing.

Copy a 2-sided Document Using the Scanner Glass

Related Models:

DCP-L5500DN/MFC-L5700DN

- To copy a 2-sided document using the scanner glass, you must scan both sides of the document manually.
- Select A4 size paper when using the 2-sided copy option.

- 1 Make sure you have loaded the correct size paper in the paper tray.
- 2 Place your document *face down* on the scanner glass.
- 3 Press  [Copy].
- 4 Enter the number of copies.
- 5 Press [Quick Copy] > [2sided(2⇒2)].
- 6 Press [Start] to scan the page.
- 7 After the machine scans the page, press the [Continue] or [Finish] button.
 - To scan another page, place the next page on the scanner glass, and then press [Continue].
 - If you have scanned all the pages, press [Finish].



- After scanning the first side of your document, you must turn over the page to scan the other side. Turn over the page along the long edge.

Copy an ID Card

Use the [2in1 (ID)] feature to copy both sides of an identification card onto one page, keeping the original card size.

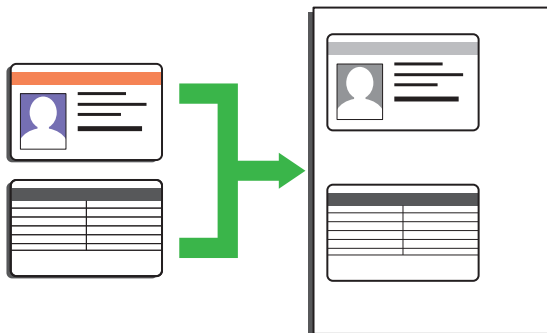

- You may copy an identification card only to the extent permitted under applicable laws. For more information, see the *Product Safety Guide*.

- 1 Place your identification card *face down* near the upper left corner of the scanner glass.

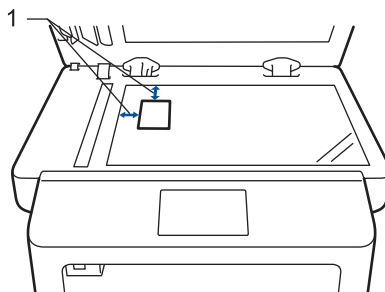

1: Distance 4.0 mm or greater (top, left)

- 2 Swipe left or right or press ◀ or ▶ to display the [2 in 1 ID Copy] option, and then press [2 in 1 ID Copy].
- 3 Enter the number of copies.
- 4 Press [Start].
The machine scans one side of the identification card.

- 5** After the machine has scanned the first side, turn over the identification card.

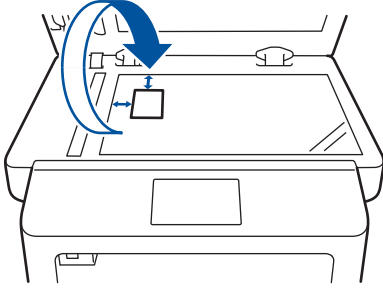

- 6** Press [Continue] to scan the other side.

Scan from Your Computer (Windows®)

There are several ways you can use your computer to scan photos and documents on your Brother machine. Use the software applications provided by Brother, or use your favourite scanning application.

Save Scanned Documents and Photos to a Folder as a PDF File Using ControlCenter4 Advanced Mode (Windows®)

Scan documents and save them to a folder on your computer as PDF files.

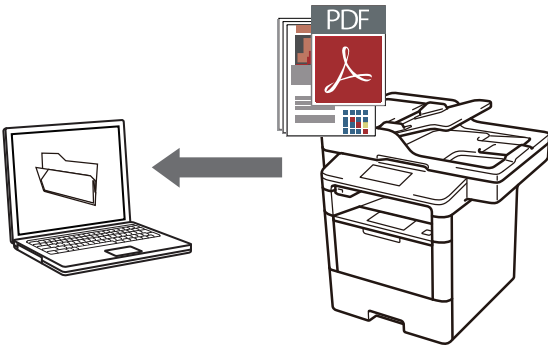

1 Load your document.

2 Click  **Start > All Programs > Brother > Brother Utilities**, and then click the drop-down list and select your model name (if not already selected). Click **Scan** in the left navigation bar, and then click **ControlCenter4 Link**. The ControlCenter4 application opens.

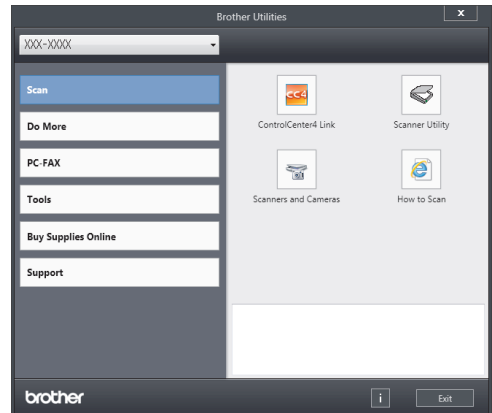

3 When you open the ControlCenter4 application at the first time, select **Advanced Mode** as the mode setting.

4 Click the **Scan** tab.

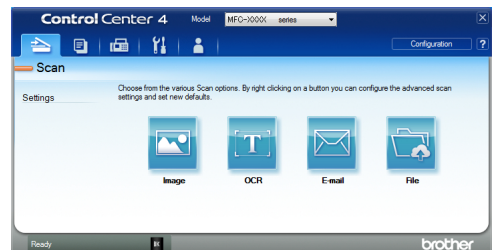

- 5** Click the **File** button.
The scan settings dialog box appears.

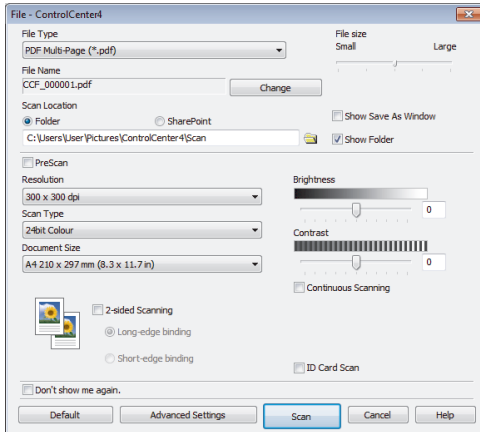

- 6** Change the scan settings if needed, and then click **Scan**.

The machine scans the document and saves the file in the folder you have selected. The folder opens automatically.



For more information, see the *Online User's Guide: Scan from Your Computer*.

Scan Using the Scan Button on Your Brother Machine

Scan Using the Scan Button on the Machine

- 1** Do one of the following:
- Place the document *face up* in the ADF.
- (If you are scanning multiple pages, we recommend using the ADF.)

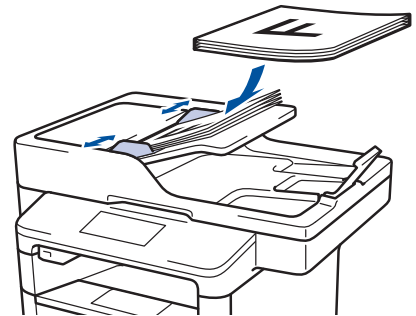

- Place the document *face down* on the scanner glass.



- 2** Press  [Scan].

- 3** Swipe left or right or press ◀ or ▶ to display the Scan mode icon.

The icon is highlighted and moves to the middle of the LCD.

Option	Description
	Press this button to scan documents and save them to a folder on your computer.

For other Scan options, see the *Online User's Guide: Scan Using the Scan Button on Your Brother Machine*.

- 4** Press  [to File].

- 5** If the machine is connected to a network, press ▲ or ▼ to display the computer where you want to send the document, and then press the computer name.

- 6** Do one of the following:
- To change the settings, press [Options], and then go to the next step.
 - To use the default settings, press [Start].
- The machine scans the document.

- 7** Select the scan settings you want to change:

- [2-sided Scan]
- [Scan Settings]
- [Scan Type]
- [Resolution]
- [File Type]
- [Document Size]
- [Brightness]
- [Contrast]
- [ADF Auto Deskew]
- [Skip Blank Page]
- [Remove Background Colour] (available only for the [Colour] and [Grey] options.)

- 8** Make the changes you want, and then press [OK].

- 9** Press [Start].
- The machine scans the document.

NOTE

Use the Scan button on the machine to make temporary changes to the scan settings. To make permanent changes, use Brother's ControlCenter software.

Before Faxing

Set Your Station ID

Related Models:



MFC-L5700DN/MFC-L5750DW/MFC-L6800DW/
MFC-L6900DW

Set the machine to print your Station ID and the fax's date and time at the top of each fax you send.

- 1 Press  [Settings] > [All Settings] > [Initial Setup] > [Station ID] > [Fax].
- 2 Enter your fax number (up to 20 digits) using the LCD, and then press [OK].
- 3 Press [Tel].
- 4 Enter your telephone number (up to 20 digits) using the LCD, and then press [OK].
- 5 Press [Name].

- 6 Enter your name (up to 20 characters) using the LCD, and then press [OK].



- Press  to cycle between letters, numbers and special characters. (The characters available may differ depending on your country.)
- If you enter an incorrect character, press ◀ or ▶ to move the cursor to it and press . Press the correct character.
- To enter a space, press [Space].
- For more information, see *Related Information*.

- 7 Press .

Related Information

- How to Enter Text on Your Brother Machine on page 61

Set Telephone Line Compatibility for Interference and VoIP Systems

Related Models:

MFC-L5700DN/MFC-L5750DW/MFC-L6800DW/
MFC-L6900DW

Problems sending and receiving faxes due to possible interference on the telephone line may be solved by reducing the modem speed to minimise errors in fax transmission. If you are using a Voice over IP (VoIP) service, Brother recommends changing the compatibility to Basic (for VoIP).



- VoIP is a type of phone system that uses an Internet connection, rather than a traditional phone line.
- Telephone providers frequently bundle VoIP together with Internet and cable services.

1 Press  [Settings] > [All Settings] > [Initial Setup] > [Compatibility].

- 2** Press the option you want.
- Select [High] to set the modem speed to 33600 bps.
 - Select [Normal] to set the modem speed to 14400 bps.
 - Select [Basic (for VoIP)] to reduce the modem speed to 9600 bps and turn off Error Correction Mode (ECM). Unless interference is a recurring problem on your telephone line, you may prefer to use this option only when needed.

3 Press .

Related Information

- Fax and Telephone Problems on page 48

Receive Modes

Related Models:

MFC-L5700DN/MFC-L5750DW/MFC-L6800DW/
MFC-L6900DW

Some receive modes answer automatically (Fax Only Mode and Fax/Tel Mode). You may want to change the Ring Delay before using these modes.

Fax Only Mode

([Fax] or [Fax Only] in the machine's menu)

Fax Only Mode automatically answers every call as a fax.

Fax/Tel Mode

([Fax/Tel] in the machine's menu)

Fax/Tel Mode helps you manage incoming calls, by recognising whether they are fax or voice calls and handling them in the following ways:

- Faxes will be received automatically.
- Voice calls will start the F/T ring to tell you to pick up the call. The F/T ring is a fast pseudo/double-ring made by your machine. See *Related Information: External and Extension Telephones*.

Manual Mode

([Manual] in the machine's menu)

Manual Mode turns off all automatic answering operations unless you are using the BT Call Sign feature.

To receive a fax in Manual Mode lift the handset of the external telephone connected to the machine.

When you hear fax tones (short repeating beeps), press [Fax Start] and then [Receive] to receive a fax. Use the Fax Detect feature to receive faxes when you have lifted a handset on the same line as the machine.

External TAD Mode

([External TAD] in the machine's menu)

External TAD Mode lets an external answering device manage your incoming calls.

Incoming calls will be handled in the following ways:

- Faxes will be received automatically.
- Voice callers can record a message on the external TAD.

Related Information

- External and Extension Telephones on page 36
 - Fax and Telephone Problems on page 48
-

Choose the Correct Receive Mode

Related Models:

MFC-L5700DN/MFC-L5750DW/MFC-L6800DW/MFC-L6900DW

You must choose a Receive Mode depending on the external devices and telephone services you have on your line.

By default, your machine will automatically receive any faxes that are sent to it. The diagram below will help you select the correct mode.

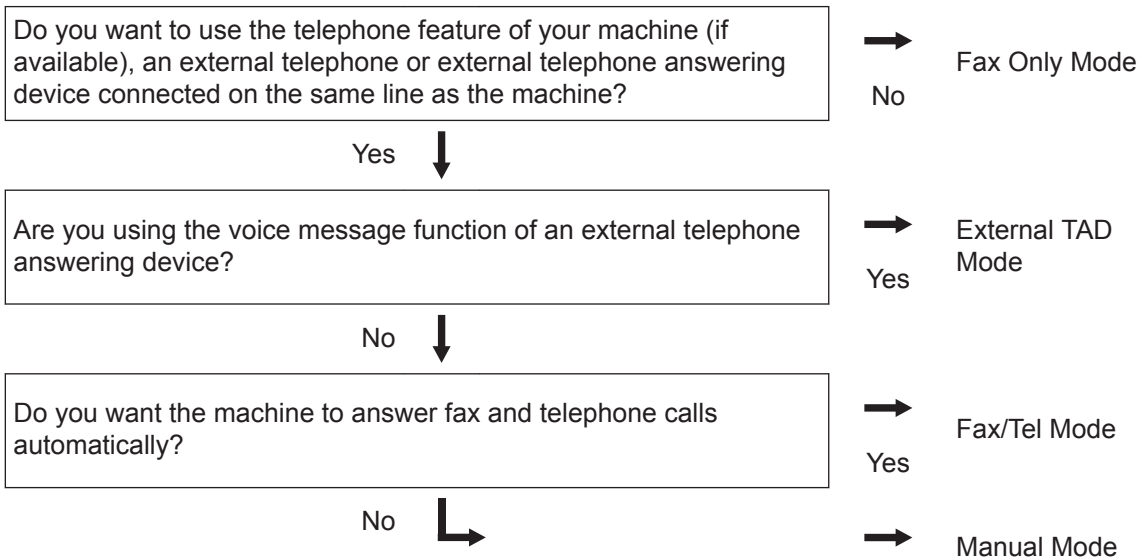

- 1 Press  [Settings] > [All Settings] > [Fax] > [Setup Receive] > [Receive Mode].



(U.K. only) If you cannot change the [Receive Mode], make sure the BT Call Sign feature is set to Off.

- 2 Press [Fax], [Fax/Tel], [External TAD], or [Manual].

- 3 Press .

Related Information

- Fax and Telephone Problems on page 48

Set the F/T Ring Time (Fast Double-ring)



Related Models:

MFC-L5700DN/MFC-L5750DW/MFC-L6800DW/
MFC-L6900DW

When you set the Receive Mode to Fax/Tel Mode, if the call is a fax, your machine will automatically receive it. However, if it is a voice call, the machine will sound the F/T ring (fast double-ring) for the time you set in the F/T Ring Time option. When you hear the F/T ring, it means that a voice caller is on the line.

- The F/T Ring Time feature works when you set Fax/Tel Mode as the Receive Mode.

Because the F/T ring is made by the machine, extension and external telephones will not ring; however, you can still answer the call on any telephone.

- 1 Press  [Settings] > [All Settings] > [Fax] > [Setup Receive] > [F/T Ring Time].
- 2 Press how long you want the machine to ring to alert you that you have a voice call.
- 3 Press .



Even if the caller hangs up during the pseudo/double-ringing, the machine will continue to ring for the set time.

Set the Number of Rings Before the Machine Answers (Ring Delay)

Related Models:

MFC-L5700DN/MFC-L5750DW/MFC-L6800DW/
MFC-L6900DW

When somebody calls your machine, you will hear the normal telephone ring sound. The number of rings is set in the Ring Delay option.

- The Ring Delay setting sets the number of times the machine rings before it answers in the Fax Only and Fax/Tel Modes.
- If you have external or extension telephones on the same line as the machine, choose the maximum number of rings.

- 1 Press  [Settings] > [All Settings] > [Fax] > [Setup Receive] > [Ring Delay].
- 2 Press the number of rings you want the line to ring before the machine answers.

 If you select [0], the machine will answer immediately and the line will not ring at all (available only for some countries).

- 3 Press .

Store Numbers

Related Models:

MFC-L5700DN/MFC-L5750DW/MFC-L6800DW/
MFC-L6900DW

Store fax and telephone numbers in the machine for quick dialling and broadcasting faxes to groups. When you dial a stored number, the LCD displays the number.



If you lose electrical power, the Address Book numbers that are in the machine's memory will not be lost.

Store Address Book Numbers

Related Models:

MFC-L5700DN/MFC-L5750DW/MFC-L6800DW/
MFC-L6900DW

1 Press  [Fax] > [Address Book].

- 2** Do the following steps:
- Press [Edit].
 - Press [Add New Address].
 - Press [Name].
 - Enter the name using the LCD (up to 16 characters), and then press [OK].
 - Press [Address].
 - Enter the fax or telephone number using the LCD (up to 20 digits), and then press [OK].



- To store an email address to use with Internet Fax or Scan to Email server, press  and enter the email address and press [OK].

(On certain models, you must download Internet Fax to use the Internet Fax feature and the Scan to Email server feature.)

g. Press [OK].

To store another Address Book number, repeat these steps.

3 Press .

Change or Delete Address Book Names or Numbers

Related Models:

MFC-L5700DN/MFC-L5750DW/MFC-L6800DW/
MFC-L6900DW

1 Press  [Fax] > [Address Book] > [Edit].

2 Do one of the following:

- Press [Change] to edit the names or fax or telephone numbers.

Swipe up or down or press ▲ or ▼ to display the number you want to change, and then press it.

- To change the name, press [Name]. Enter the new name (up to 16 characters) using the LCD, and then press [OK].
- To change the fax or telephone number, press [Address]. Enter the new fax or telephone number (up to 20 digits) using the LCD, and then press [OK].

Press [OK] to finish.



How to enter text:

To change a character, press ◀ or ▶ to position the cursor to highlight the incorrect character, and then press .

Enter the new character.

- To delete numbers, swipe up or down or press ▲ or ▼ to display [Delete], and then press [Delete].

- Select the fax or telephone numbers you want to delete by pressing them to display a red check mark, and then press [OK].

3 Press .

Telephone Services and External Devices

Related Models:

MFC-L5700DN/MFC-L5750DW/MFC-L6800DW/MFC-L6900DW

You may be able to use the following services and connections with your Brother machine.



These are summaries of ways to connect your machine. For more information about each topic, see the *Online User's Guide*.

Voice Mail

Related Models:

MFC-L5700DN/MFC-L5750DW/MFC-L6800DW/
MFC-L6900DW

If you have a Voice Mail service on the telephone line that your Brother machine is connected to, it may conflict with your Brother machine when receiving incoming faxes. If using this service, we suggest setting the Brother machine's Receive Mode to Manual.

Voice Over Internet Protocol (VoIP)

Related Models:

MFC-L5700DN/MFC-L5750DW/MFC-L6800DW/
MFC-L6900DW

VoIP is a type of phone system that uses an Internet connection instead of a traditional telephone line. Your machine may not work with some VoIP systems. If you have questions about how to connect your machine to a VoIP system, contact your VoIP provider.

Connection of an External Telephone Answering Device (TAD)

Related Models:

MFC-L5700DN/MFC-L5750DW/MFC-L6800DW/
MFC-L6900DW

You may choose to connect an external answering device to your Brother machine. To receive faxes successfully, you must connect it correctly. Connect your external TAD to the T-piece connector on the Brother line cable supplied with your machine. When recording an outgoing message on your external TAD,

we recommend recording 5 seconds of silence at the beginning of your message, and limiting your speaking to 20 seconds. Set your machine's Receive Mode to External TAD.

External and Extension Telephones

Related Models:

MFC-L5700DN/MFC-L5750DW/MFC-L6800DW/
MFC-L6900DW

You can connect a separate phone into the T-piece connector on your Brother line cable supplied with your machine. If you answer a fax call on an extension or external telephone, you can make your machine receive the fax by pressing * 5 1. If the machine answers a voice call and fast double-rings for you to take over, press # 5 1 to take the call on an extension telephone.

Related Information

- Receive Modes on page 30

Send and Receive a Fax Using Your Machine

Send a Fax

Related Models:

MFC-L5700DN/MFC-L5750DW/MFC-L6800DW/
MFC-L6900DW

1 Do one of the following:

- Place the document *face up* in the ADF.

(If you are faxing multiple pages, we recommend using the ADF.)

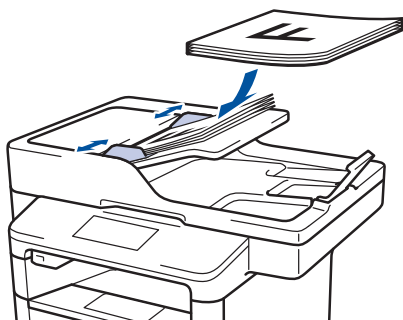

- Place the document *face down* on the scanner glass.

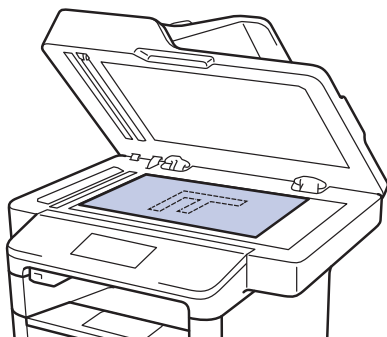

2 Press [Fax].

3 Enter the fax number.

- **Using the dial pad**

Press the digits to enter the fax number.

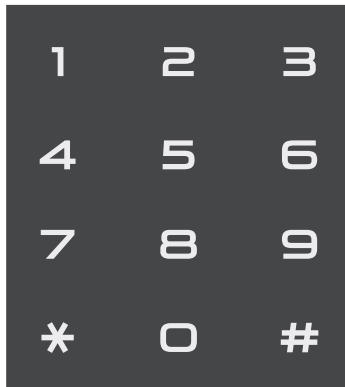

- **Using the Address Book**

Press  [Address Book], and then do one of the following:

- Swipe up or down or press ▲ or ▼ to display the number you want, and then press it.
- Press , and then enter the name and press [OK]. Press the name you want to dial.

When finished, press [Apply].

- **Using the call history**

Press  [Call History], and then press the [Outgoing Call] option.

Swipe up or down or press ▲ or ▼ to display the fax number you want, and then press it.

To send a fax, press [Apply].

4 Press [Fax Start].

The machine scans and sends the document.

If you placed the document on the scanner glass, follow the instructions in the table.

Option	Description
Yes	To scan the next page, press the Yes option, and then place the next page on the scanner glass. Press OK to scan the page.
No	After you have scanned the last page, press the No option. The machine sends the document.

To stop faxing, press .

Fax Using Your Computer (PC-FAX)

Send Faxes from Your Computer

Related Models:

MFC-L5700DN/MFC-L5750DW/MFC-L6800DW/
MFC-L6900DW

The Brother PC-FAX feature lets you send a file, created in any application on your computer, as a standard fax and even attach a cover page.

For Windows®:

For more information, see the *Online User's Guide: PC-FAX for Windows®*.

For Macintosh:

For more information, see the *Online User's Guide: PC-FAX for Macintosh*.

- 1 From your application select **File**, and then **Print**.
(The steps may vary depending on your application.)
The Print dialog box appears.

- 2 Select **Brother PC-FAX**.

- 3 Click **Print**.
The **Brother PC-FAX** user interface appears.

- 4 Enter the recipient's fax number.
 - a. Use your computer keyboard or click the **Brother PC-FAX** user interface's numeric keypad.
 - b. Click **Add Send Address**.



You can also select a stored number from the **Address Book**.

- 5 Click **Start**.
Your document is sent to the Brother machine and then faxed to the recipient.

Contact the application's vendor if you need more support.

Receive Faxes on Your Computer (Windows® only)

Related Models:

MFC-L5700DN/MFC-L5750DW/MFC-L6800DW/
MFC-L6900DW

Use Brother's PC-FAX software to receive faxes on your computer, screen them, and print only those faxes you want.

- Even if you turn off your computer (at night or on the weekend, for example), your machine will receive and store your faxes in its memory. The number of received faxes that are stored in the memory appears on the LCD.
- When you start your computer and the PC-Fax Receive software runs, your MFC transfers your faxes to your computer automatically.
- For PC-Fax Receive to work, the PC-FAX Receive software must be running on your computer.
- Before you can set up PC-Fax Receive, you must install the MFL-Pro Suite software on your computer. Make sure your Brother machine is connected to your computer and turned on.
- If your machine displays an error and is unable to print faxes from memory, use PC-FAX to transfer your faxes to a computer.
- *PC-Fax Receive is not available for Macintosh.*

1 Do one of the following:

- (Windows® XP, Windows Vista® and Windows® 7)

Click  **Start > All Programs > Brother > Brother Utilities > PC-FAX > Receive.**

- (Windows® 8)

Click  (**Brother Utilities**), and then click the drop-down list and select your model name (if not already selected).

Click **PC-FAX** in the left navigation bar, and then click **Receive**.

2 Confirm the message and click **Yes**.

The **PC-FAX Receive** window appears. The **PC-Fax Receive (Ready)** icon also appears in your computer task tray.







Use this section to resolve problems you may encounter when using your Brother machine.

Identify the Problem

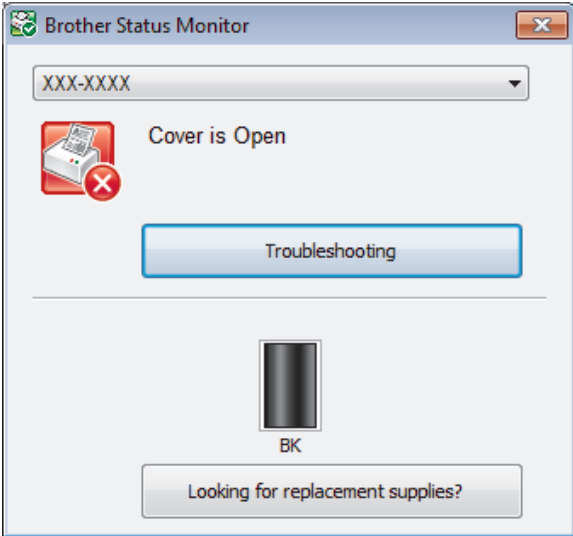
Even if there seems to be a problem with your machine, you can correct most problems yourself.

First, check the following:

- The machine's power cord is connected correctly and the machine's power is on.
- All of the machine's orange protective parts have been removed.
- (For network models) The access point (for wireless network), router, or hub is turned on and its link indicator is blinking.
- Paper is inserted correctly in the paper tray.
- The interface cables are securely connected to the machine and the computer.
- Check the LCD or the machine's status in **Brother Status Monitor** on your computer.

Find the Error	Find the Solution
<p>Using the Status Monitor</p>  <ul style="list-style-type: none"> • Double-click the  icon in the task tray. • (Windows®) If you select the Load Status Monitor on Startup check box, the Status Monitor will launch automatically each time you start your computer. 	<ul style="list-style-type: none"> • A green icon indicates the normal stand-by condition.  • A yellow icon indicates a warning.  • A red icon indicates an error has occurred.  • A grey icon indicates the machine is offline.  • Click the Troubleshooting button to access Brother's troubleshooting website.

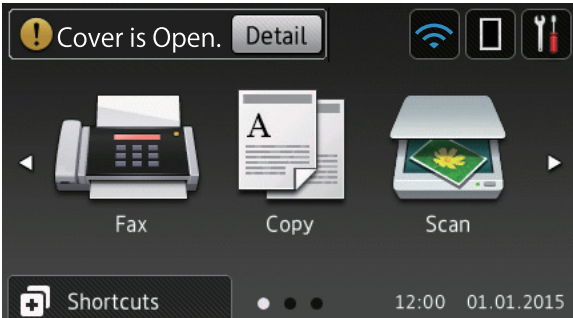
Find the Error	Find the Solution
<p>Using the LCD</p> 	<ol style="list-style-type: none"> 1. Follow the messages on the LCD. 2. See the instructions in the following table. 3. If you cannot resolve the error, see the <i>Online User's Guide: Error and Maintenance Messages</i> or see: FAQs & Troubleshooting on the Brother Solutions Center at support.brother.com.

Error and Maintenance Messages





(DCP-L6600DW/MFC-L6800DW/MFC-L6900DW)

If the LCD displays errors and your Android™ device supports the NFC feature, touch your device to the NFC logo on your Brother machine to access the Brother Solutions Center and browse the latest FAQs from your device. (Your mobile telephone provider's message and data rates may apply.)



Make sure the NFC settings of both your Brother machine and your Android™ device are set to On.



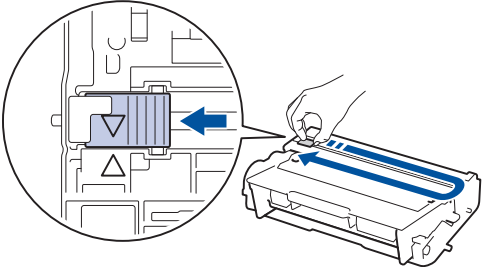

The most common error and maintenance messages are shown in the table.

Error Message	Cause	Action
2-sided Disabled	The back cover of the machine is not closed completely.	Close the back cover of the machine until it locks in the closed position.
	The 2-sided tray is not installed completely.	Install the 2-sided tray firmly in the machine.
Cartridge Error	The toner cartridge is not installed correctly.	Remove the toner cartridge and drum unit assembly. Take out the toner cartridge, and put it back in the drum unit again. Reinstall the toner cartridge and drum unit assembly in the machine. If the problem continues, contact Brother customer service or your local Brother dealer.
Cover is Open	The front cover is not completely closed.	Open and then firmly close the front cover of the machine.

Error Message	Cause	Action
Cover is Open.	The fuser cover is not completely closed or paper was jammed in the back of the machine when you turned on the power.	Close the fuser cover located inside the back cover of the machine. Make sure paper is not jammed inside the back of the machine, and then close the fuser cover.
Cover is Open.	The ADF cover is not completely closed.	Close the ADF cover. If the error message remains, press  .
Document Jam	The document was not inserted or fed correctly, or the document scanned from the ADF was too long.	Remove the jammed paper from the ADF unit. Clear any debris or scraps of paper from the ADF unit paper path. Press  .
Drum !	The corona wire on the drum unit must be cleaned.	Clean the corona wire on the drum unit.  See the <i>Online User's Guide: Clean the Corona Wire</i> . If the problem continues, replace the drum unit with a new one.
	The drum unit or the toner cartridge and drum unit assembly is not installed correctly.	Remove the drum unit, remove the toner cartridge from the drum unit, and put the toner cartridge back into the drum unit. Reinstall the drum unit in the machine.
Jam 2-sided	The paper is jammed in the 2-sided tray or inside the back cover.	Remove the 2-sided tray and open the back cover to pull out all jammed paper.
Jam Inside	The paper is jammed inside the machine.	Open the front cover, remove the toner cartridge and drum unit assembly, and pull out all jammed paper. Close the front cover.
Jam MP Tray	The paper is jammed in the MP tray.	Remove all jammed paper from in and around the MP tray. Press Retry .
Jam Rear	The paper is jammed in the back of the machine.	Open the fuser cover and remove all jammed paper. Close the fuser cover.

Error Message	Cause	Action
Jam Tray 1 Jam Tray 2 Jam Tray 3	The paper is jammed in the indicated paper tray.	Pull out the paper tray and remove all jammed paper as shown in the animation on the LCD.
Media Type Mismatch	The media type specified in the printer driver differs from the paper type specified in the machine's menu.	Load the correct type of paper in the tray indicated on the LCD, and then select the correct media type in the Paper Type setting on the machine.
No Drum Unit	The drum unit is not installed correctly.	Reinstall the toner cartridge and drum unit assembly.
No Paper	The machine is out of paper, or paper is not loaded correctly in the paper tray.	<ul style="list-style-type: none"> • Refill paper in the paper tray. Make sure the paper guides are set to the correct size. • If paper is in the tray, remove it and load it again. Make sure the paper guides are set to the correct size. • Do not overfill the paper tray.
No Paper Fed T1 No Paper Fed T2 No Paper Fed T3	The machine failed to feed paper from the indicated paper tray.	Pull out the paper tray indicated on the LCD and remove all jammed paper.
No Paper MP	The MP tray is out of paper, or paper is not loaded correctly in the MP tray.	<p>Do one of the following:</p> <ul style="list-style-type: none"> • Refill paper in the MP tray. Make sure the paper guides are set to the correct size. • If paper is in the tray, remove it and load it again. Make sure the paper guides are set to the correct size.
No Paper No Paper T1 No Paper T2 No Paper T3	The machine failed to feed paper from the indicated paper tray.	<p>Do one of the following:</p> <ul style="list-style-type: none"> • Refill paper in the paper tray indicated on the LCD. Make sure the paper guides are set to the correct size. • If paper is in the tray, remove it and load it again. Make sure the paper guides are set to the correct size. <p>Do not overfill the paper tray.</p>

Error Message	Cause	Action
No Toner	The toner cartridge or the toner cartridge and drum unit assembly is not installed correctly.	Remove the toner cartridge and drum unit assembly. Remove the toner cartridge from the drum unit, and reinstall the toner cartridge back in the drum unit. Reinstall the toner cartridge and drum unit assembly back in the machine. If the problem continues, replace the toner cartridge with a new one.
No Tray T1 No Tray T2 No Tray T3	The paper tray is not installed or not installed correctly.	Reinstall the paper tray indicated on the LCD.
Out of Memory	The machine's memory is full.	<p>If a fax-sending or copy operation is in process</p> <p>Do one of the following:</p> <ul style="list-style-type: none"> • Press Send Now to send the pages scanned so far. • Press Partial Print to copy the pages scanned so far. • Press Quit or  and wait until the other operations that are in progress finish, and then try again. <p>If a scan operation is in process</p> <ul style="list-style-type: none"> • Split the document into multiple parts. • Reduce the Resolution. • Reduce the File Size. • Select the high compression PDF file type. • Clear faxes from the memory. <p>If a print operation is in process</p> <p>Press  and reduce the print resolution.</p>
Output Tray Full	The output paper tray is full.	Remove printed paper from output tray indicated on the LCD.
Paper Low Paper Low T1 Paper Low T2 Paper Low T3	The paper tray is nearly empty.	Refill the paper in the paper tray indicated on the LCD.
Print Data Full	The machine's memory is full.	Press  and delete the previously stored secure print data.

Error Message	Cause	Action
Print Unable ##	The machine has a mechanical problem.	<ul style="list-style-type: none"> • Press and hold  to turn the machine off, wait a few minutes, and then turn it on again. • If the problem continues, contact Brother customer service.
Received Fax ##	An unprinted received fax is waiting to print on the correct size paper.	To print the received fax, load the correct size of paper in the tray indicated on the LCD. Paper sizes available for fax printing are A4, Letter, Legal and Folio.
Replace Toner	<p>The toner cartridge is at the end of its life. The machine stops all print operations.</p> <p>While memory is available, faxes are stored in the memory.</p>	Replace the toner cartridge with a new one.
Scan Unable	The document is too long for 2-sided scanning.	<p>Press . For 2-sided scanning, use A4 size paper. Other paper must be within the following size:</p> <p>Length: 147.3 to 355.6 mm</p> <p>Width: 105 to 215.9 mm</p>
Scan Unable ##	The machine has a mechanical problem.	<ul style="list-style-type: none"> • Press and hold  to turn the machine off, and then turn it on again. • If the problem continues, contact Brother customer service.
Self-Diagnostic	The temperature of the fuser unit does not rise to a specified temperature within the specified time.	Press and hold  to turn the machine off, wait a few seconds, and then turn it on again. Leave the machine idle for 15 minutes with the power on.
	The fuser unit is too hot.	
Size Error	The paper size defined in the printer driver is not supported by the defined tray.	Choose a paper size supported by the defined tray.

Error Message	Cause	Action
Size Error 2-sided	The paper size specified in the machine's paper size setting is not available for automatic 2-sided printing.	Press  (if required). Load the correct size of paper in the tray and set the tray for that paper size. Choose a paper size supported by 2-sided printing.
	The paper in the tray is not the correct size and is not available for automatic 2-sided printing.	Paper size available for automatic 2-sided printing is A4.
Size Mismatch	The paper in the tray is not the correct size.	Load the correct size of paper in the tray indicated on the LCD and set the size of paper for the tray.
Supplies Drum End Soon	The drum unit is near the end of its life.	Order a new drum unit before the LCD displays <i>Replace Drum</i> .
Supplies Prepare New Toner Cartridge.	If the LCD displays this message, you can still print. The toner cartridge is near the end of its life.	Order a new toner cartridge now so a replacement toner cartridge is available when the LCD displays <i>Replace Toner</i> .
Supplies Replace Drum	It is time to replace the drum unit.	Replace the drum unit with a new one.
	The drum unit counter was not reset when a new drum was installed.	Reset the drum unit counter. See the instructions included with the new drum unit.
Wrong Paper Size MP Wrong Paper Size T1 Wrong Paper Size T2 Wrong Paper Size T3	The specified tray ran out of paper during copying and the machine could not feed the same size paper from the next priority tray.	Refill the paper in the paper tray.

Fax and Telephone Problems

Related Models:

MFC-L5700DN/MFC-L5750DW/MFC-L6800DW/MFC-L6900DW

If you cannot send or receive a fax, check the following:

- 1 Connect one end of the telephone line cord to the area labelled "LINE", and then connect the other end of the telephone line cord directly to a telephone wall socket.

If you can send and receive faxes when the telephone line is directly connected to the fax, the problem may be unrelated to the machine. Please contact your telephone service provider for connection issues.

- 2 Check the Receive Mode.

See *Related Information*:

- *Receive Modes*
- *Choose the Correct Receive Mode*

- 3 Try changing the compatibility settings.

You may be able to send and receive faxes by lowering the connection speed.

For more information, see *Related Information: Set Telephone Line Compatibility for Interference and VoIP Systems*.

If the problem still is not resolved, turn the machine off, and then turn it on.



Related Information

- Set Telephone Line Compatibility for Interference and VoIP Systems on page 30
 - Receive Modes on page 30
 - Choose the Correct Receive Mode on page 32
-

Troubleshooting for Other Fax Problems

Related Models:

MFC-L5700DN/MFC-L5750DW/MFC-L6800DW/MFC-L6900DW

Difficulties	Suggestions
Cannot send a fax.	Check all line cord connections. Make sure the telephone line cord is plugged into the telephone wall socket and the LINE socket of the machine. If you subscribe to DSL or VoIP services, contact your service provider for connection instructions. If you are using a VoIP system, try changing the Compatibility setting to <i>Basic (for VoIP)</i> . This will lower modem speed and turn off Error Correction Mode (ECM).
	Make sure you pressed Fax and the machine is in Fax mode.
	Print the Transmission Verification Report and check for an error.
	Contact your administrator to check your Secure Function Lock Settings.
	Ask the other party to check that the receiving machine has paper.
Cannot receive a fax.	If you are using a telephone answering machine (External TAD Mode) on the same line as the Brother machine, make sure your answering machine is set up correctly. <ol style="list-style-type: none"> Set your answering machine to answer in one or two rings. Record the outgoing message on your answering machine. <ul style="list-style-type: none"> Record five seconds of silence at the beginning of your outgoing message. Limit your speaking to 20 seconds. End your outgoing message with your Act. Code for people sending manual faxes. For example: "After the beep, leave a message or press *51 and Start to send a fax." Set your answering machine to answer calls. Set your Brother machine's Receive Mode to External TAD.
	Make sure your Brother machine's Fax Detect feature is turned On. Fax Detect is a feature that allows you to receive a fax even if you have answered the call on an external or extension telephone.
Received faxes appear as split pages.	Turn on Auto Reduction.
Dialling does not work. (No dial tone)	Check all line cord connections. Change Tone/Pulse setting. (Available only for some countries)
Poor sending quality.	Try changing your resolution to Fine or S.Fine .
	Make a copy to check your machine's scanner operation. If the copy quality is not good, clean the scanner.
	For more information, see the <i>Online User's Guide: Clean the Scanner</i> .

Difficulties	Suggestions
Vertical black lines when sending.	Black vertical lines on faxes you send are typically caused by dirt or correction fluid on the glass strip. For more information, see the <i>Online User's Guide: Clean the Scanner</i> .

Print or Scan Problems

If you cannot print or scan a document, check the following:

- 1 All of the machine's protective parts have been removed.
- 2 The interface cables are securely connected to the machine and the computer.
- 3 The printer or scanner driver has been installed correctly.
To make sure the printer or scanner driver is installed on your computer, see the *Online User's Guide: Other Problems*

- 4 (Scan problem only)
Confirm the machine is assigned with an available IP address. (Windows®)

- a. Do one of the following:

(Windows® XP)

Click **Start > Control Panel > Printers and Other Hardware > Scanners and Cameras.**

(Windows Vista®)

Click  (**Start**) > **Control Panel > Hardware and Sound > Scanners and Cameras.**

(Windows® 7)

Click  (**Start**) > **All Programs > Brother > Brother Utilities.**

Click the drop-down list and select your model name (if not already selected). Click **Scan** in the left navigation bar, and then click **Scanners and Cameras.**

(Windows® 8)

Click  (**Brother Utilities**), and then click the drop-down list and

select your model name (if not already selected). Click **Scan** in the left navigation bar, and then click **Scanners and Cameras.**

- b. Do one of the following:

(Windows® XP)

Right-click a scanner device, and then select **Properties**. The Network Scanner Properties dialog box appears.

(Windows Vista®, Windows® 7 and Windows® 8)

Click the **Properties** button.

- c. Click the **Network Setting** tab to confirm the machine's IP address.

Try printing with your machine. If the problem still remains, uninstall and reinstall the printer driver.

- 5 If the problem still remains after trying all the above, try the following:

For a USB interface connection

- Change the USB cable for a new one.
- Use a different USB port.

For a Wired Network connection

- Change the LAN cable for a new one.
- Use a different LAN port on your hub.

For a Wireless Network connection

- Confirm your machine's Wi-Fi light status.

If the Wi-Fi light on your machine's control panel is blinking, your machine has not been connected to the WLAN access point. Set up the wireless network connection again.

If the Wi-Fi light on your machine's control panel is off, the WLAN connection setting is disabled. Enable the WLAN connection and set up the wireless network connection.

For more information, see the *Online User's Guide: Introduction to Your Brother Machine*

If you cannot print on both sides of paper, check the following:

- 6** Change the paper size setting in the printer driver to A4.

Document and Paper Jams

Find the Jammed Document or Paper

If your document or paper jams inside the machine, the LCD message or Status Monitor will help you to find it.

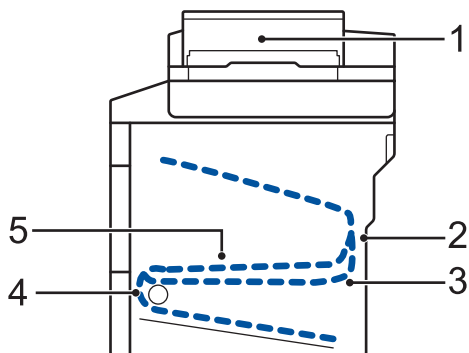

1. Document Jam
2. Jam Rear
3. Jam 2-sided
4. Jam Tray
5. Jam Inside

Clear the Document Jam

The Document is Jammed in the Top of the ADF

- 1 Open the ADF cover.
- 2 Pull the jammed document out to the left.



- 3 Close the ADF cover.

The Document is Jammed under the Document Cover

- 4 Pull the jammed document out to the right.

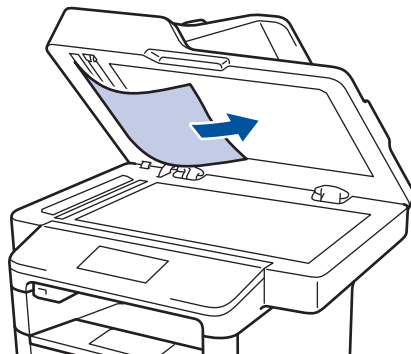

If the document rips or tears, remove all small paper scraps to prevent future jams.

Remove Small Paper Scraps Jammed in the ADF

- 5 Insert a strip of stiff paper, such as cardstock, into the ADF to push any small paper scraps through.

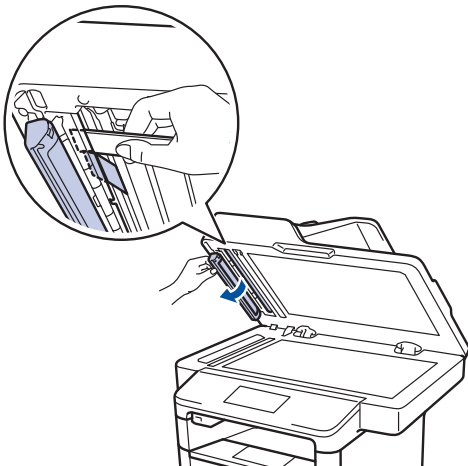
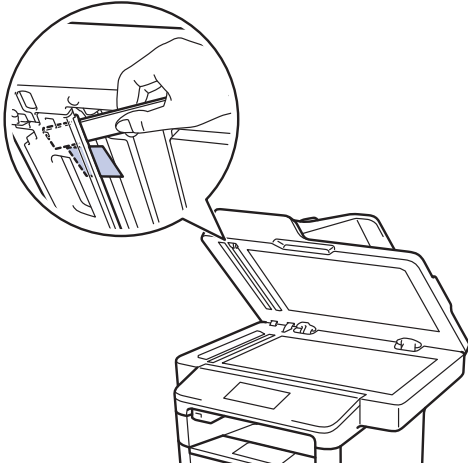

If the document rips or tears, remove all small paper scraps to prevent future jams.

- 6 Press .

Clear the Paper Jam

Always remove the remaining paper from the paper tray and straighten the stack when you are adding new paper. This helps prevent multiple sheets of paper from feeding through the machine at one time and prevents paper jams.

Paper is Jammed in the MP tray

If the machine's control panel or the Status Monitor indicates that there is a jam in the machine's MP tray, follow these steps:

- 1 Remove the paper from the MP tray.
- 2 Remove any jammed paper from in and around the MP tray.

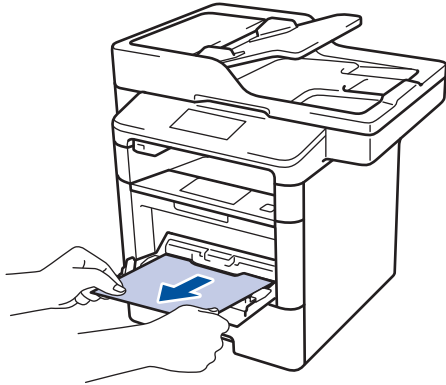

- 3 Fan the paper stack, and then put it back in the MP tray.
- 4 Reload paper in the MP tray and make sure the paper stays under the maximum paper height guides (1) on both sides of the tray.

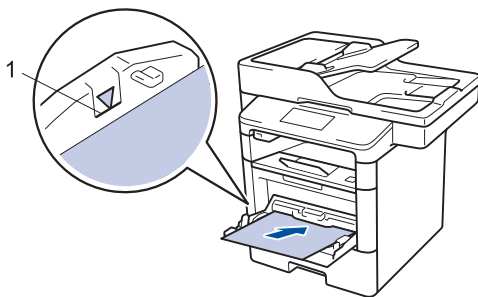

- 5 Press [Retry] to resume printing.

Paper is Jammed in the Paper Tray

If the machine's control panel or the Status Monitor indicates that there is a jam in the paper tray, follow these steps:

- 1 Pull the paper tray completely out of the machine.

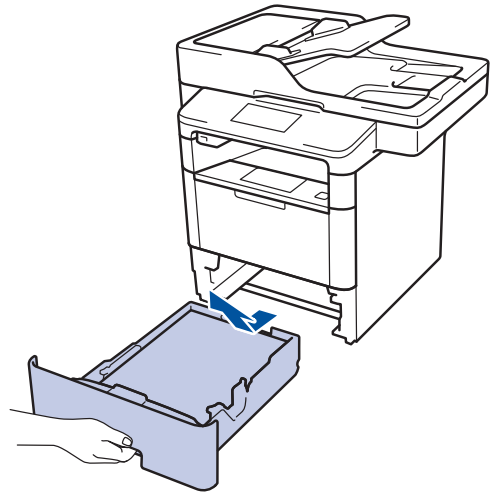

- 2 Slowly pull out the jammed paper.

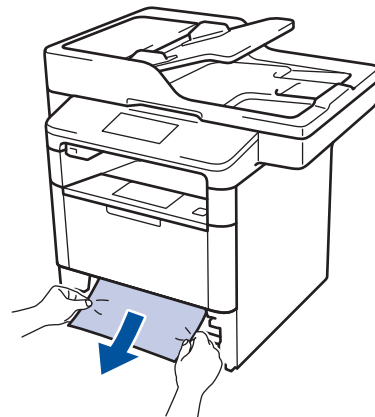

 Pulling the jammed paper downward using both hands allows you to remove the paper more easily.

- 3** Fan the stack of paper to prevent further jams, and slide the paper guides to fit the paper size.

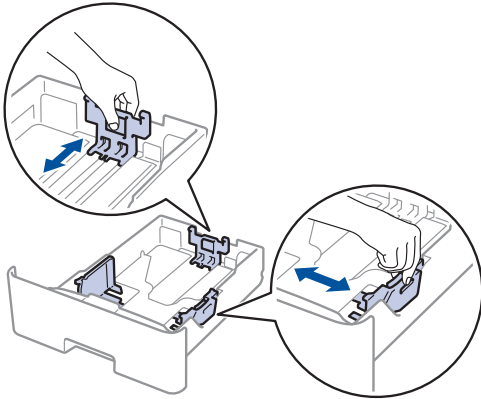

- 4** Make sure the paper is below the maximum paper mark (▼▼▼).

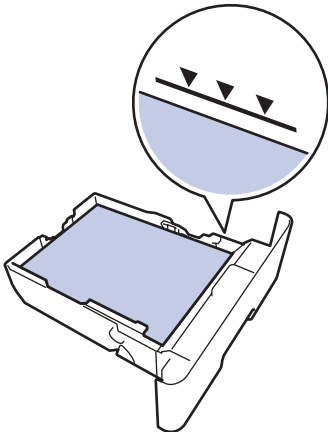

- 5** Put the paper tray firmly back in the machine.

Paper is Jammed in the Back of the Machine

If the machine's control panel or the Status Monitor indicates that there is a jam in the back (Rear) of the machine, follow these steps:

- 1** Leave the machine turned on for 10 minutes for the internal fan to cool the extremely hot parts inside the machine.

- 2** Open the back cover.

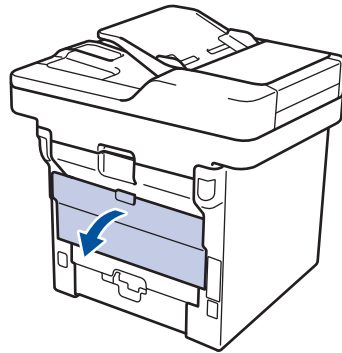

- 3** Pull the green levers at the left and right sides toward you to release the fuser cover.

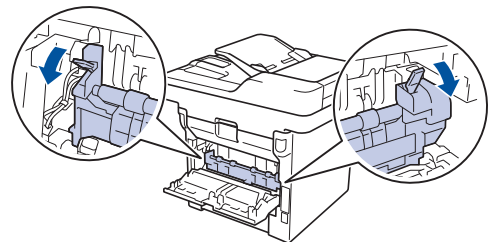

⚠ WARNING

HOT SURFACE

The machine's internal parts will be extremely hot. Wait for the machine to cool down before touching them.

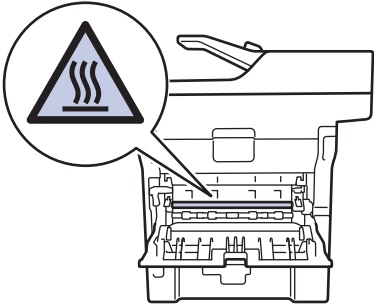

- 4 Use both hands to gently pull the jammed paper out of the fuser unit.

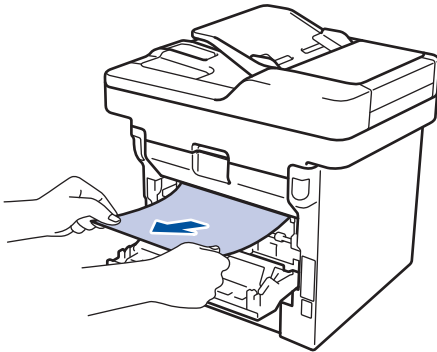

- 5 Close the fuser cover.

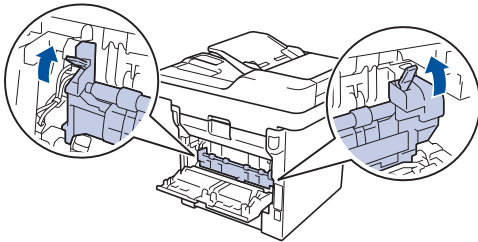

- 6 Close the back cover until it locks in the closed position.

Paper is Jammed inside the Machine

If the machine's control panel or the Status Monitor indicates that there is a jam inside the machine, follow these steps:

- 1 Leave the machine turned on for 10 minutes for the internal fan to cool the extremely hot parts inside the machine.

- 2 Open the front cover.

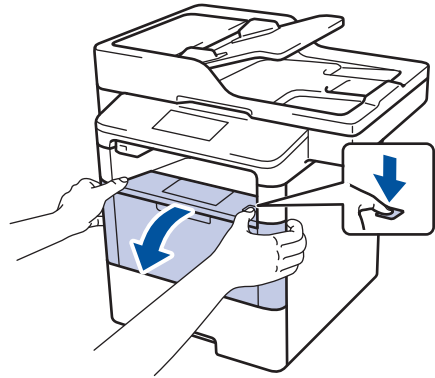

- 3 Remove the toner cartridge and drum unit assembly.

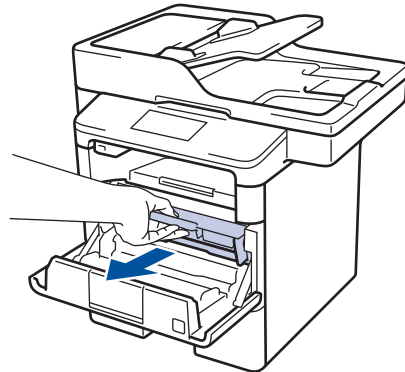

WARNING

HOT SURFACE

The machine's internal parts will be extremely hot. Wait for the machine to cool down before touching them.

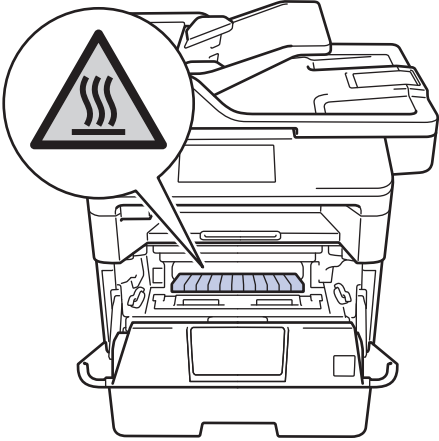

6 Close the front cover.

4 Pull out the jammed paper slowly.

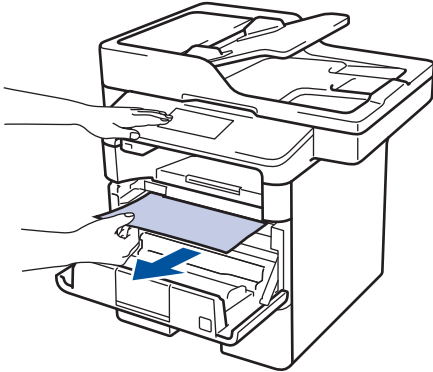

5 Install the toner cartridge and drum unit assembly into the machine.

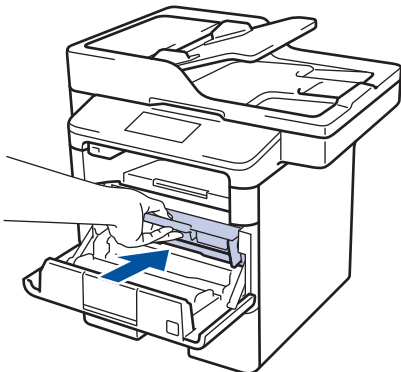

Paper is Jammed in the 2-sided Tray

If the machine's control panel or the Status Monitor indicates that there is a jam in the 2-sided paper tray, follow these steps:

- 1 Leave the machine turned on for 10 minutes for the internal fan to cool the extremely hot parts inside the machine.
- 2 Pull the paper tray completely out of the machine.

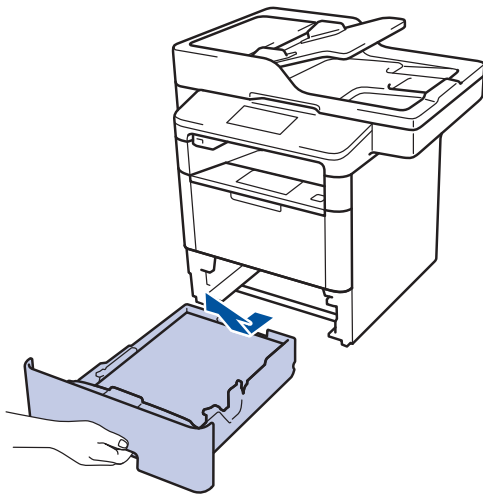

- 3 At the back of the machine, pull the 2-sided tray completely out of the machine.

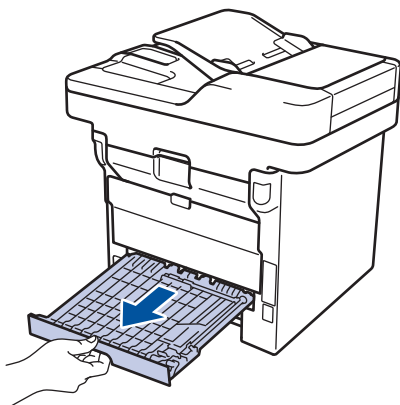

- 4 Pull the jammed paper out of the machine or out of the 2-sided tray.

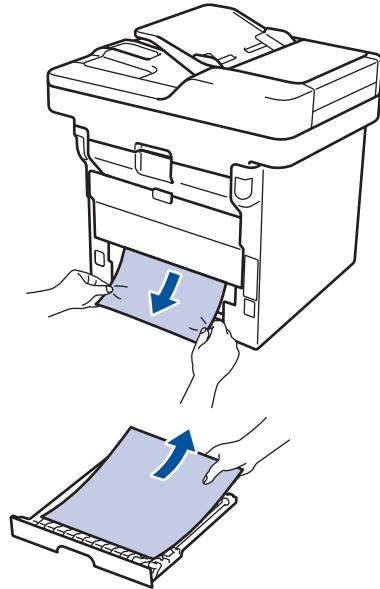

- 5 Remove paper that may have jammed under the machine due to static electricity.

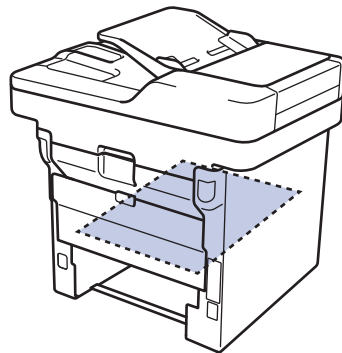

- 6** If paper is not caught inside the 2-sided tray, open the back cover.

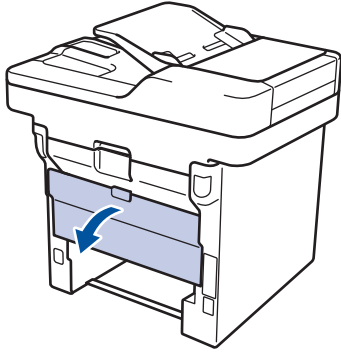

⚠ WARNING

HOT SURFACE

The machine's internal parts will be extremely hot. Wait for the machine to cool down before touching them.

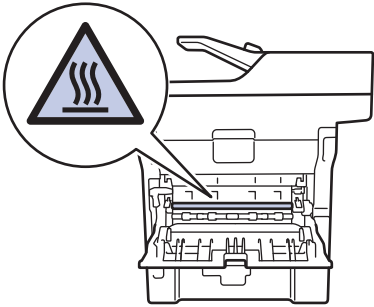

- 7** Use both hands to gently pull the jammed paper out of the back of the machine.

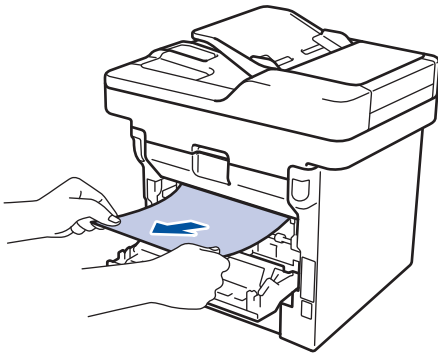

- 8** Close the back cover until it locks in the closed position.



- 9** Put the 2-sided tray firmly back in the rear of the machine.

- 10** Put the paper tray firmly back in the front of the machine.

How to Enter Text on Your Brother Machine

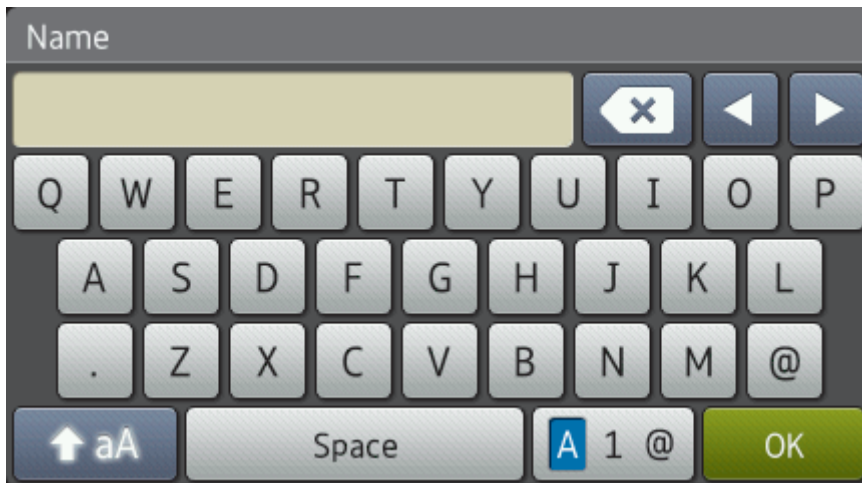
- When you must enter text on your Brother machine, a keyboard appears on the LCD.
- The characters that are available may differ depending on your country.
- The keyboard layout may differ depending on the operation you perform.





- Press  to cycle between letters, numbers and special characters.
- Press  to cycle between lowercase and uppercase letters.
- To move the cursor to the left or right, press ◀ or ▶.

Inserting spaces

- To enter a space, press [Space] or ▶.

Making corrections

- If you entered a character incorrectly and want to change it, press ◀ or ▶ to move the cursor to the incorrect character, and then press . Enter the correct character.
- To insert a character, press ◀ or ▶ to move the cursor to the correct place, and then enter the character.
- Press  for each character you want to erase, or press and hold  to erase all the characters.

Related Information

- Set Your Station ID on page 29
-

Information for Compliance with Commission Regulation 801/2013

Power consumption Networked Standby ¹	DCP-L5500DN	MFC-L5700DN	MFC-L5750DW	DCP-L6600DW/ MFC-L6800DW/ MFC-L6900DW
	Approximately 1.9 W	Approximately 2.0 W	Approximately 3.5 W	Approximately 3.7 W

¹ All network ports activated and connected

How to enable/disable Wireless LAN

To turn the wireless network connection on or off, press  [Settings] > [Network] > [WLAN] > [WLAN Enable] > [On] or [Off].

Supplies

When the time comes to replace supplies, such as the toner or drum, an error message will appear on your machine's control panel or in the Status Monitor. For more information about the supplies for your machine, visit <http://www.brother.com/original/index.html> or contact your local Brother dealer.

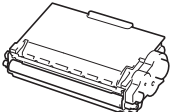
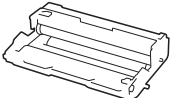

The toner cartridge and drum unit are two separate parts.

Supply Items	Supply Model Name	Approximate Life (Page Yield)	Applicable Models
Toner Cartridge 	Standard Toner: TN-3430 TN-3400 (For Israel)	Approximately 3,000 pages ^{1 2}	DCP-L5500DN/DCP-L6600DW/ MFC-L5700DN/MFC-L5750DW/ MFC-L6800DW/MFC-L6900DW
	High Yield Toner: TN-3480 TN-3410 (For Israel)	Approximately 8,000 pages ^{1 2}	DCP-L5500DN/DCP-L6600DW/ MFC-L5700DN/MFC-L5750DW/ MFC-L6800DW/MFC-L6900DW
	Super High Yield Toner: TN-3512 TN-3500 (For Israel)	Approximately 12,000 pages ^{1 2}	DCP-L6600DW/MFC-L6800DW/ MFC-L6900DW
	Ultra High Yield Toner: TN-3520 TN-3510 (For Israel)	Approximately 20,000 pages ^{1 2}	MFC-L6900DW
Drum Unit 	DR-3400 DR-3420 (For Israel)	Approximately 30,000 pages/ 50,000 pages ³	DCP-L5500DN/DCP-L6600DW/ MFC-L5700DN/MFC-L5750DW/ MFC-L6800DW/MFC-L6900DW

¹ Approximate cartridge yield is declared in accordance with ISO/IEC 19752.

² A4 or Letter size 1-sided pages

³ Approximately 30,000 pages based on 1 page per job and 50,000 pages based on 3 pages per job [A4/letter simplex pages]. The number of pages may be affected due to a variety of factors including but not limited to media type and media size.



If you are using Windows[®], double-click the Brother CreativeCenter icon  on your desktop to access our **FREE** website designed as a resource to help you easily create and print customised materials for business and home use with photos, text and creativity.

Macintosh users can access Brother CreativeCenter at this web address:

<http://www.brother.com/creativecenter>

A

<hr/>	
Address Book	
changing	34
storing	34
using.....	37
ADF (Automatic Document Feeder).....	
.....	18, 22, 23, 27, 37
Automatic	
fax receive.....	30, 32

C

<hr/>	
Control Panel Overview.....	1
NFC (Near Field Communication).....	1
Copy.....	18
settings.....	20

D

<hr/>	
Date and time.....	7
Document	
how to load.....	18, 27, 37

E

<hr/>	
Entering text.....	61
Envelopes.....	12, 16
Error messages.....	42
External and extension telephones.....	36

F

<hr/>	
Fax.....	29
F/T ring time.....	33
receive mode.....	30, 32
ring delay.....	33
station ID.....	29
telephone line compatibility.....	30
Fax receive.....	32
Fax, from computer.....	39

J

<hr/>	
Jams.....	53

document	53
paper	54

L

<hr/>	
Labels.....	12, 16
LCD (Liquid Crystal Display).....	1, 3, 5

M

<hr/>	
Maintenance messages.....	42
Multi-purpose Tray.....	10, 16

N

<hr/>	
NFC (Near Field Communication).....	42

P

<hr/>	
Paper	
how to load	8
type	12
Print.....	14

R

<hr/>	
Receive	30, 32
Receive Mode.....	30, 32

S

<hr/>	
Scan.....	26
Supplies.....	63

T

<hr/>	
TAD (Telephone Answering Device), external.....	30, 36
Troubleshooting.....	41
document and paper jams	53
error and maintenance messages ..	42
fax and telephone problems	48
print or scan problems	51

V

Voice Mail.....	36
VoIP systems.....	30, 36
Volume.....	7

brother

Visit us on the World Wide Web
www.brother.com



D0056J001-00
UK
Version A

Free Manuals Download Website

<http://myh66.com>

<http://usermanuals.us>

<http://www.somanuals.com>

<http://www.4manuals.cc>

<http://www.manual-lib.com>

<http://www.404manual.com>

<http://www.luxmanual.com>

<http://aubethermostatmanual.com>

Golf course search by state

<http://golfingnear.com>

Email search by domain

<http://emailbydomain.com>

Auto manuals search

<http://auto.somanuals.com>

TV manuals search

<http://tv.somanuals.com>