

INTRODUCTION

With your PT-1880, you can create labels for any application. Select from the many frames, character sizes and styles to design beautiful custom labels. In addition, the variety of tape cartridges available allows you to print labels with different widths and exciting colors.

FCC NOTICE

This device complies with Part 15 of the FCC Rules. Operation is subject to the following two conditions: (1) This device may not cause harmful interference, and (2) this device must accept any interference received, including interference that may cause undesired operation.

GENERAL PRECAUTIONS

- Use only Brother TZ tapes with this machine. Do not use tapes that do not have the TM mark. Do not disassemble or modify the machine/AC adapter.

1 PREPARATION

Unpacking Your P-touch Labeler

Check that the package contains the following before using your P-touch labeler.

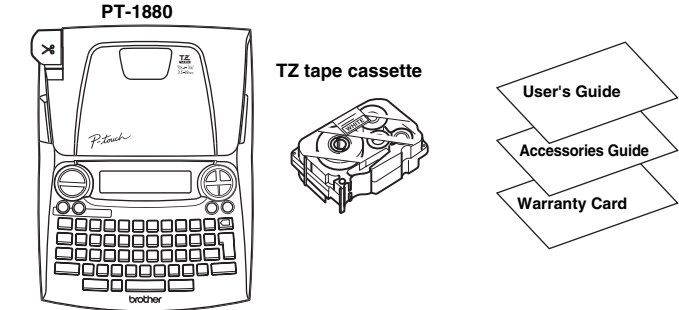

Included items may differ by distribution.

Tape Cassettes

Make sure that the power is turned off when replacing a tape cassette.

- 1 Open the tape compartment cover by lifting up both sides at the same time. If a tape cassette is already installed, remove it by pulling it straight up.

Power Supply

Make sure that the power is turned off when replacing batteries.

- 1 Turn the machine over and remove the battery compartment cover. If batteries are already installed, remove them.

- When using optional AC adapter (model AD-24) 1 Insert the plug on the adapter cord into the adapter jack on the right side of the machine.

2 OPERATION

Keyboard & LCD

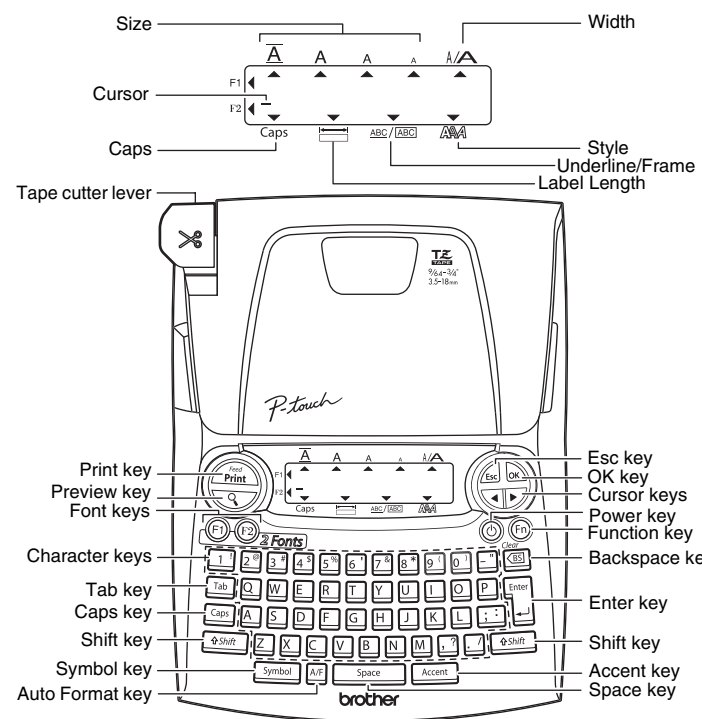

- The LCD shows one row of 15 characters; however, the text that you enter can be up to 80 characters in length, which will scroll across the display.

Turning the Power On

Setting Language (English/Spanish/French/Portuguese)

Setting unit (inch/mm)

- The machine automatically turns off if no key is pressed within 5 minutes. To cancel operations, press the Stop key.

3 REFERENCE

Troubleshooting

Table with 2 columns: Error message and Cause/Remedy. Includes entries like Battery Weak!, Check Battery!, Invalid!, No Text!, Line Limit!, No Cassette!, Cutter Error!, Full!, Text Too Long!, No Frame OK?.

What to do when...

Table with 2 columns: Problem and Solution. Includes entries like The machine does not print, The setting has cleared on its own, A blank horizontal line appears throughout the printed label, The machine has "locked up", The power turns off when you try to print, The tape does not feed properly, All text and format settings need to be cleared to create a new label.

Specifications

Table with 2 columns: Item and Specification. Includes Dimensions, Weight, Power supply, and Tape cassette specifications.

Accessories (Supplies may differ by distribution.)

Table with 2 columns: Accessories and Stock No. Lists items like Tape Cassettes, AC Adapter, and Carrying Case.

1 MAKING TEXT

Setting Font

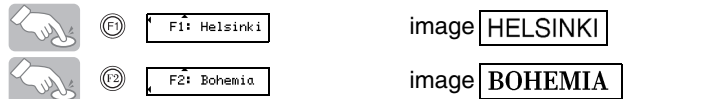

Switching Upper Case/Lower Case

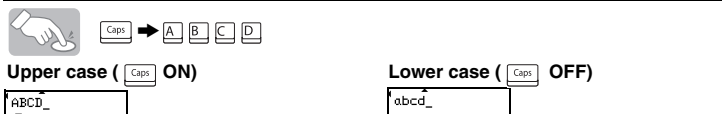

Making Two Line Text

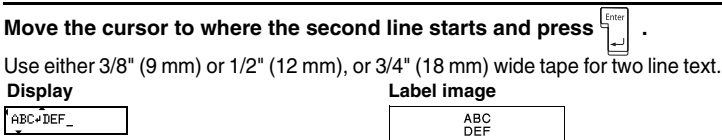

Entering Symbols

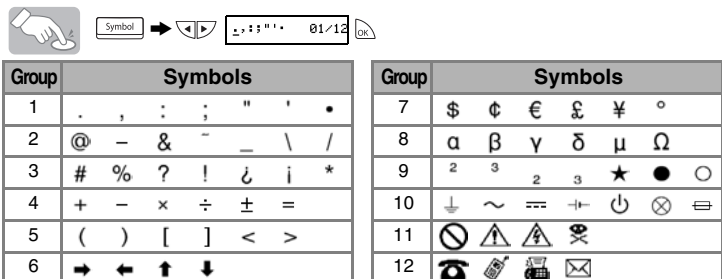

Entering Accented Characters

Table with 2 columns: Accented Characters. Lists characters like Á, Ä, Å, Æ, Æ, Å, Ä, Á, etc.

To Clear

- To delete a character one by one. To delete all text. To delete all text & format. You can also go into [Text & Format] / [Text Only] by pressing [F2] + [F3].

2 DESIGNING LABELS

Setting [Size]

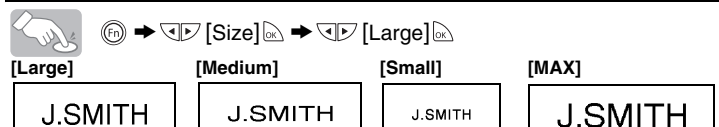

Automatically adjusts the text size according to the tape width. Select MAX to print with maximum text size when using 3/4" (18 mm) tape, all texts are in upper case, the Style setting is [Normal], and the Underline/Frame setting is [Off].

Setting [Width]

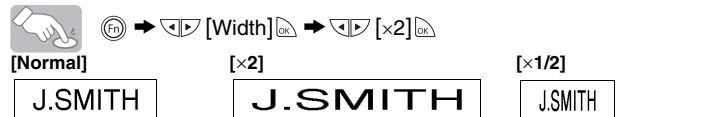

Setting [Style] (Vertical)

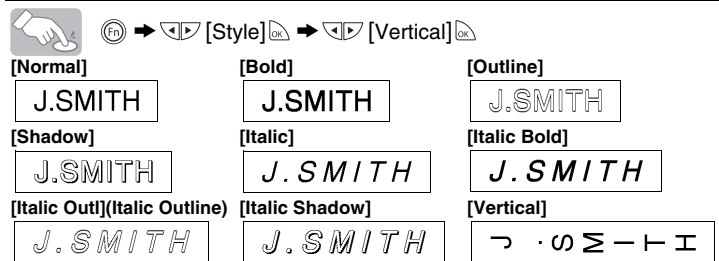

Setting [Underline/Frame]

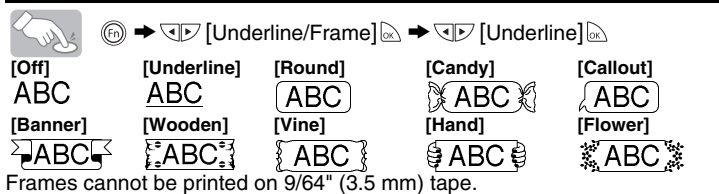

Setting [Label Length] (Auto / 1.2" - 12.0")

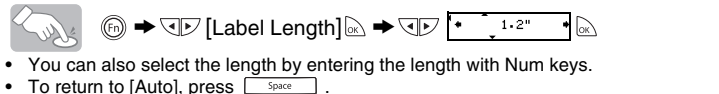

Setting [Tab]

You can make aligned texts by setting tabs. Example: To set a tab between 'ABC' and 'D'. The cursor should be positioned where you set a tab.



Setting [Tab Length] (Auto / 0.0" - 4.0")

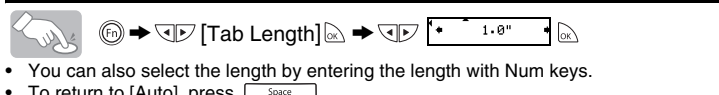

Setting [Auto Format]

You can choose label length from six formats to create labels for various applications.

Table with 4 columns: Application, Length, Application, Length. Lists formats like VHS Spine, MiniDV Spine, Audio Tape, CD Case Spine, File Tab, Divider Tab.

3 PRINTING LABELS

Text Preview

You can preview the text before printing. The LCD shows the whole text and the label length (inch/mm), then returns to the original text. Only the text can be previewed, not the font, style, size, underline/frame or any additional features.

Feeding (Tape Feed)

The machine will feed 1.0" of tape, which may be needed when installing a new tape cassette or when using the [Chain Print] feature.

Printing

To cut off the label, push in the tape cutter lever on the upper-left corner of the machine. To prevent damage to the tape, do not try to cut while the message "Print" or "Feed" is displayed.

Setting [Margin] (Tape Margin)

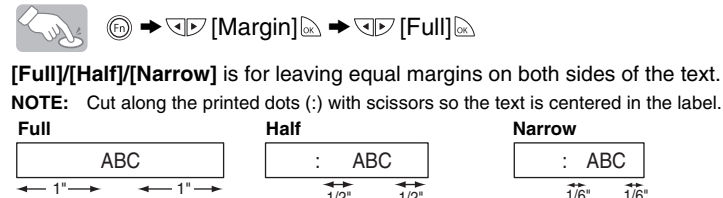

[Chain Print] is for printing more than 1 copy of a label with minimum margin (e.g. 1). You can also create a label containing text in various styles; print a text in one style, and before feeding, enter the second text in another style (e.g. 2). FEED THE TAPE BEFORE USING THE CUTTER (see Feeding/Printing). Otherwise A PART OF THE TEXT MAY BE CUT OFF. Do not try to pull the tape since this may damage the tape cassette.

Using [Print Option]

[Copies] You can print up to 9 copies of each label. [Numbering] You can print many copies of the same text while increasing a selected number by 1 after each label is printed.

Select the highest number you wish to be printed when setting the number. [Mirror] Use clear tape in [Mirror], so the labels can be read correctly from the opposite side when attached on glass, windows or other transparent surfaces.

4 COMPLETED LABELS

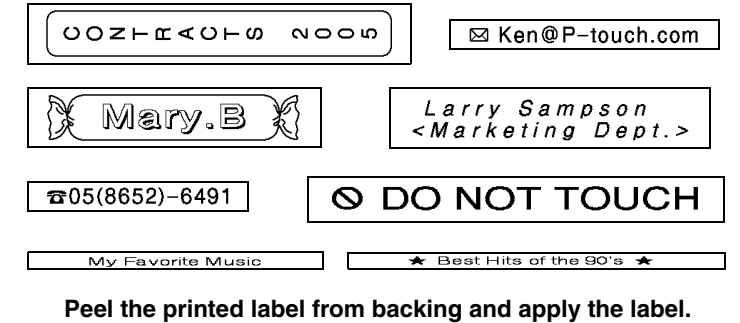

USEFUL FUNCTIONS

Memory (File)

You can save your original labels on to your machine. Up to five labels can be saved and recalled for printing whenever you desire. You can also edit and overwrite the stored label.

To Save:

To Print:

To Open:

Function Shortcuts

In addition to the basic steps to search for a function, the PT-1880 provides you with function shortcuts so you can easily jump to a frequently used function just by pressing the function key and the shortcut key shown in the table below. To confirm, press [Enter].

Table with 4 columns: Key, Function, Key, Function. Lists shortcuts for Size, Width, Style, Underline/Frame, File, Label Length, Margin, Tab Length, Print Option, Language, Unit, Clear.

Should you encounter any problems with your product, please do not return your product to the store!

After referring to the User's guide, if you still need assistance, call Brother Customer Service at:

Voice : 1-877-4-PTOUCH Web : www.brother.com Fax : 1-901-379-1210

If you need to locate a service center, please call 1-800-284-HELP or visit us at www.brother.com

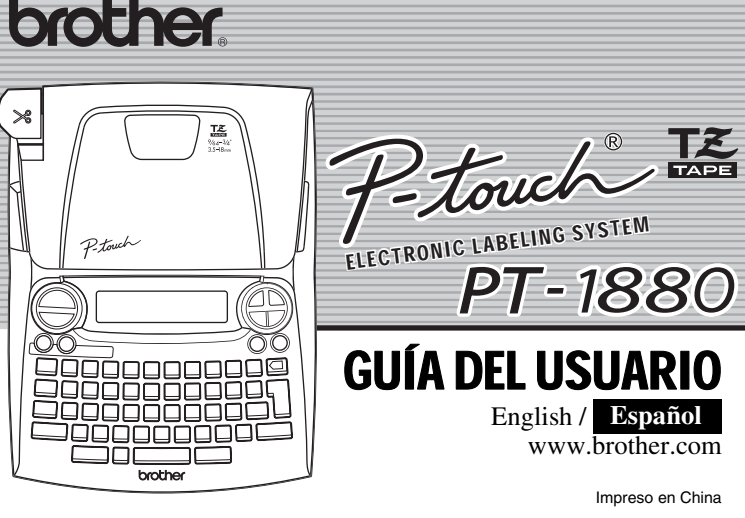

INTRODUCCIÓN

La PT-1880 le permite crear etiquetas para cualquier aplicación. Seleccione entre los diversos marcos, tamaños y estilos de caracteres...

AVISO DE LA FCC

Este dispositivo cumple la parte 15 de las normas de la FCC. Su funcionamiento está sujeto a las siguientes condiciones: (1) este dispositivo no puede causar interferencias nocivas...

PRECAUCIONES GENERALES

- Utilice solamente cintas TZ de Brother con esta máquina. No utilice cintas que no tengan la marca... No desarme ni modifique la máquina ni el adaptador de CA...

1 PREPARACIÓN

Desembalaje de la P-touch

Antes de utilizar la P-touch, compruebe que la caja incluya lo siguiente. PT-1880

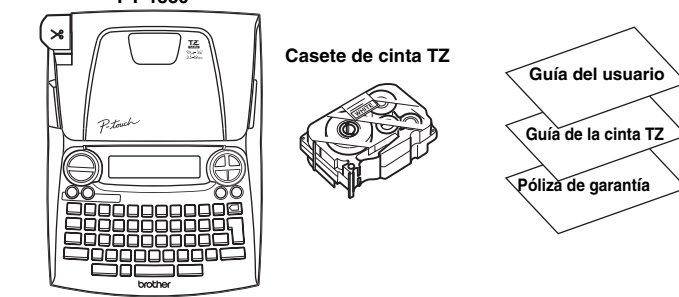

Los artículos incluidos pueden ser diferentes en cada país.

Casetes de cinta

Asegúrese de que la máquina esté desconectada al reemplazar un casete de cinta.

- 1 Abra la tapa del compartimento de cinta levantando ambos lados al mismo tiempo.

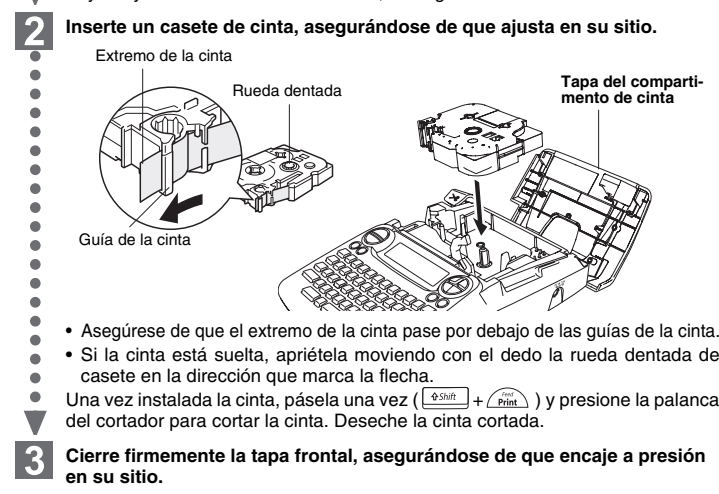

Asegúrese de que la máquina esté desconectada al reemplazar las pilas.

- 1 Déle vuelta a la máquina y retire la tapa del compartimento de pilas.

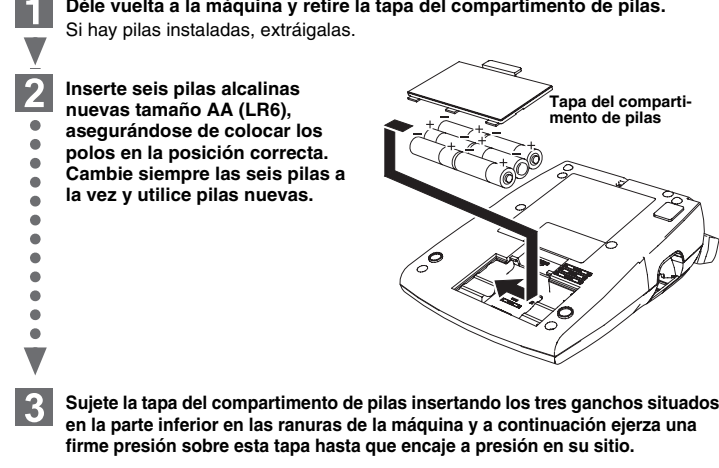

Asegúrese de que la máquina esté desconectada al reemplazar las pilas.

- 1 Inserte seis pilas alcalinas nuevas tamaño AA (LR6), asegurándose de colocar los polos en la posición correcta.

2 FUNCIONAMIENTO

Teclado y pantalla LCD

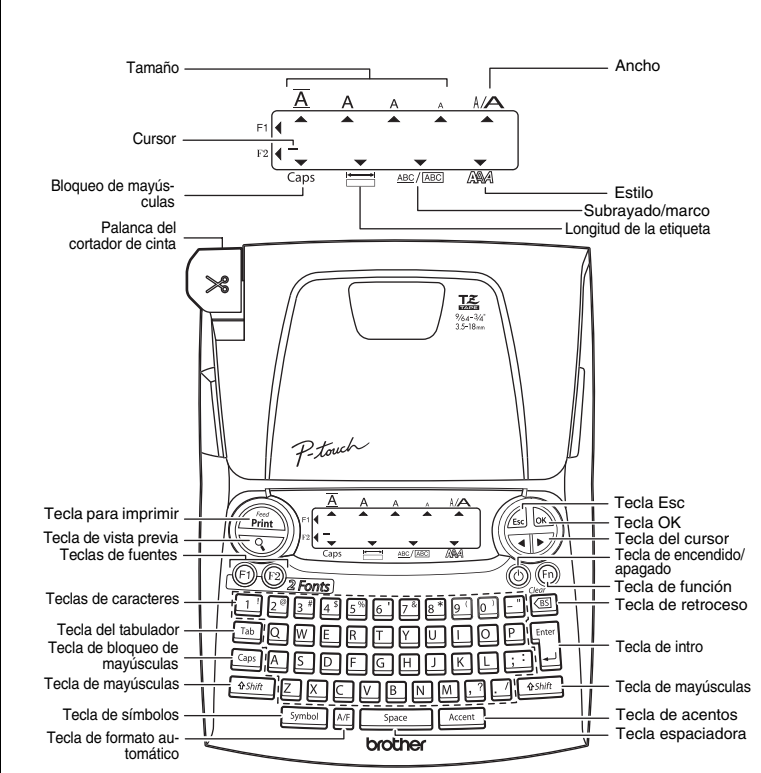

- La pantalla LCD muestra una fila de 15 caracteres; sin embargo, puede escribir texto con una longitud de hasta 80 caracteres, que se desplazará por el visualizador.

Encendido

Para encender la máquina, presione la tecla de encendido/apagado.

Ajuste del idioma (Inglés/español/francés/portugués)



Ajuste de unidades (pulgadas/milímetros)



- La máquina se apagará automáticamente si no se presiona ninguna tecla durante 5 minutos. Para cancelar las operaciones, presione la tecla de cancelación.

3 REFERENCIA

Solución de problemas

Table with 2 columns: Mensaje and Causa/Solución. Contains troubleshooting information for various issues like low battery, no text, or incorrect margins.

Qué puede hacer cuando...

Table with 2 columns: Problema and Solución. Provides solutions for common problems like blank printing, incorrect margins, or battery issues.

Especificaciones

Table with 2 columns: Elemento and Especificación. Lists technical specifications such as dimensions, weight, and power source.

Accesorios (Las piezas suministradas pueden ser diferentes en cada país.)

Table with 2 columns: Accesorios and Nº cat. Lists optional accessories like the CA adapter and transport adapter.

Información de contacto

Esta información varía para cada país. Consulte el sitio Web. (http://www.brother.com/)

1 CREACIÓN DEL TEXTO

Ajuste de la fuente



Cambio entre mayúsculas y minúsculas

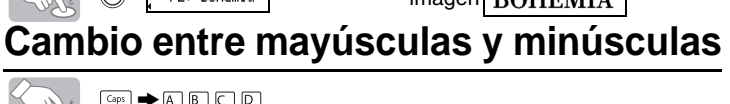

Creación de dos líneas de texto



Uso de símbolos

Table with 2 columns: Grupo and Símbolos. Lists various symbols and their corresponding control sequences.

Caracteres con acentos

Table with 2 columns: Caracteres con acento. Lists characters with accents and their control sequences.

Para borrar



2 DISEÑO DE ETIQUETAS

Ajuste del [Tamaño]



Ajuste del [Ancho]

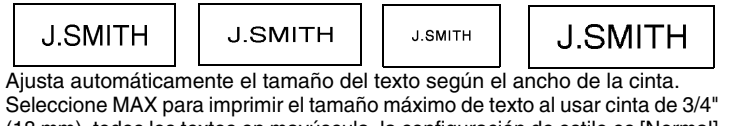

Ajuste del [Estilo] (Vertical)

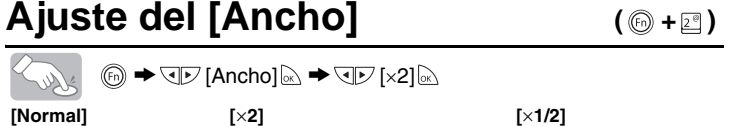

Ajuste de [Subrayar/Marco]

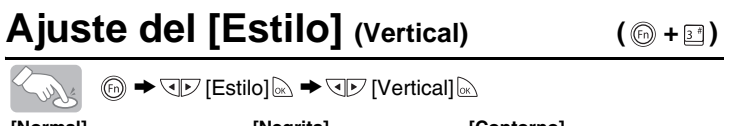

Ajuste de la [Longitud Etq.] (Auto/1,2" - 12,0")



Ajuste de la [Longitud Tab] (Auto/0,0" - 4,0")

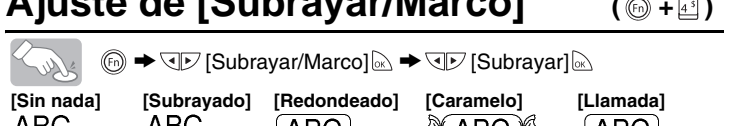

Ajuste de [Tabulado]

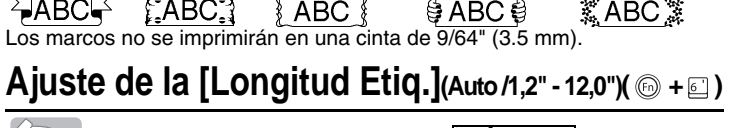

Ajuste de la [Longitud Tab] (Auto/0,0" - 4,0")

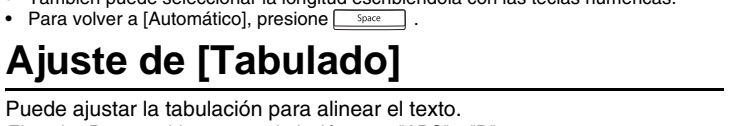

Ajuste de la [Longitud Tab] (Auto/0,0" - 4,0")



Ajuste de la [Longitud Tab] (Auto/0,0" - 4,0")

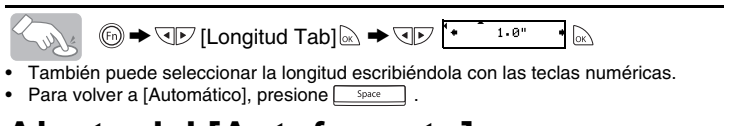

Ajuste del [Autoformato]

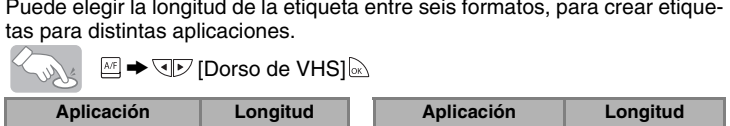

Table with 4 columns: Aplicación, Longitud, Aplicación, Longitud. Lists supported applications and their label lengths.

3 IMPRESIÓN DE ETIQUETAS

Vista previa del texto



Alimentación (Alimentación de la cinta)

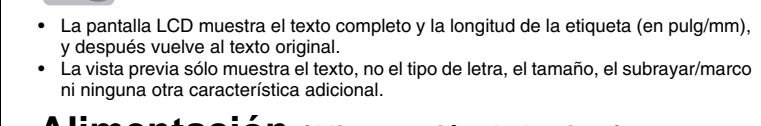

Impresión

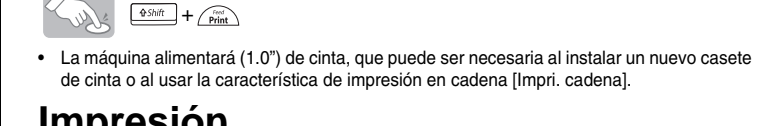

Ajuste del [Margen] (margen de la cinta)

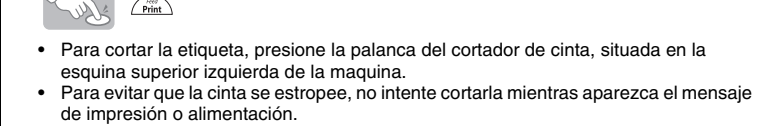

[Lleno]/[Mitad]/[Estrecha]

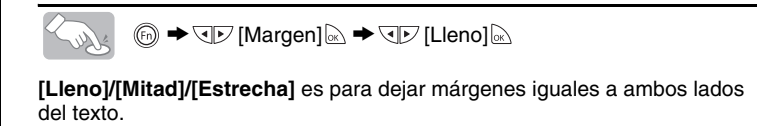

[Impri. cadena]

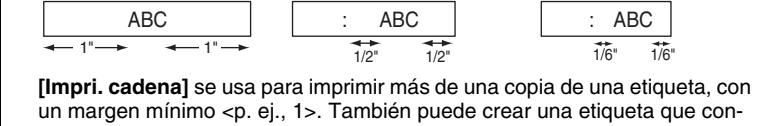

[Impresión en cadena]

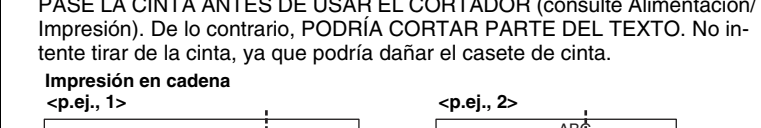

[Uso de [Opción Impr.]

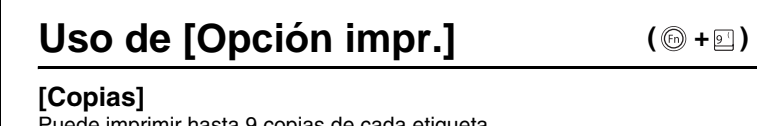

[Copias]

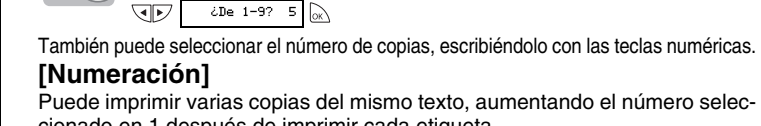

[Numeración]

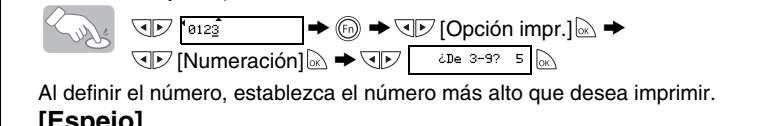

[Espejo]

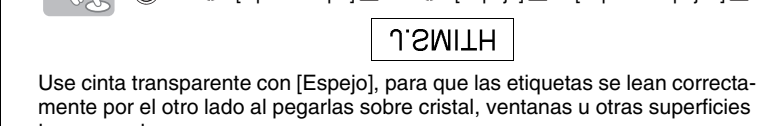

Use cinta transparente con [Espejo], para que las etiquetas se lean correctamente por el otro lado al pegarlas sobre cristal, ventanas u otras superficies transparentes.

4 ETIQUETAS TERMINADAS

Despegue la parte posterior de la etiqueta impresa y pegue la etiqueta.

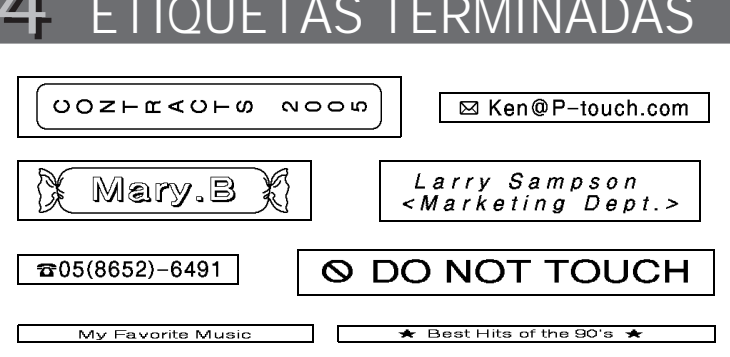

FUNCIONES ÚTILES

Memoria (Archivo)



Para guardar:



Para imprimir:

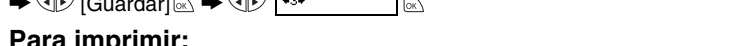

Para abrir:



Teclas de acceso directo

Table with 2 columns: Tecla and Función. Lists direct access keys and their functions.

Además de los pasos básicos para buscar una función, PT-1880 ofrece teclas de acceso directo para que pueda ir a una función que usa con frecuencia...

Table with 2 columns: Tecla and Función. Lists direct access keys and their functions.

Además de los pasos básicos para buscar una función, PT-1880 ofrece teclas de acceso directo para que pueda ir a una función que usa con frecuencia...

Table with 2 columns: Tecla and Función. Lists direct access keys and their functions.

Además de los pasos básicos para buscar una función, PT-1880 ofrece teclas de acceso directo para que pueda ir a una función que usa con frecuencia...

Table with 2 columns: Tecla and Función. Lists direct access keys and their functions.

Además de los pasos básicos para buscar una función, PT-1880 ofrece teclas de acceso directo para que pueda ir a una función que usa con frecuencia...

Table with 2 columns: Tecla and Función. Lists direct access keys and their functions.

Además de los pasos básicos para buscar una función, PT-1880 ofrece teclas de acceso directo para que pueda ir a una función que usa con frecuencia...

Table with 2 columns: Tecla and Función. Lists direct access keys and their functions.

Además de los pasos básicos para buscar una función, PT-1880 ofrece teclas de acceso directo para que pueda ir a una función que usa con frecuencia...

Table with 2 columns: Tecla and Función. Lists direct access keys and their functions.

Además de los pasos básicos para buscar una función, PT-1880 ofrece teclas de acceso directo para que pueda ir a una función que usa con frecuencia...

Table with 2 columns: Tecla and Función. Lists direct access keys and their functions.

Además de los pasos básicos para buscar una función, PT-1880 ofrece teclas de acceso directo para que pueda ir a una función que usa con frecuencia...

Table with 2 columns: Tecla and Función. Lists direct access keys and their functions.

Además de los pasos básicos para buscar una función, PT-1880 ofrece teclas de acceso directo para que pueda ir a una función que usa con frecuencia...

Table with 2 columns: Tecla and Función. Lists direct access keys and their functions.

Free Manuals Download Website

<http://myh66.com>

<http://usermanuals.us>

<http://www.somanuals.com>

<http://www.4manuals.cc>

<http://www.manual-lib.com>

<http://www.404manual.com>

<http://www.luxmanual.com>

<http://aubethermostatmanual.com>

Golf course search by state

<http://golfingnear.com>

Email search by domain

<http://emailbydomain.com>

Auto manuals search

<http://auto.somanuals.com>

TV manuals search

<http://tv.somanuals.com>