

This symbol is intended to alert the user to the presence of uninsulated "dangerous voltage" within the product's enclosure that may be of sufficient magnitude to constitute a risk of electric shock to persons.

CAUTION
RISK OF ELECTRIC SHOCK
DO NOT OPEN

This symbol is intended to alert the user to the presence of important operating and maintenance (servicing) instructions in the literature accompanying the appliance.

IMPORTANT! FOR YOUR PROTECTION, PLEASE READ THE FOLLOWING:
WATER AND MOISTURE: Appliance should not be used near water (near a bathtub, washbowl, kitchen sink, laundry tub, in a wet basement, or near a swimming pool, etc.). Care should be taken so that objects do not fall and liquids are not spilled into the enclosure through openings.

POWER SOURCES: The appliance should be connected to a power supply only of the type described in the operating instructions or as marked on the appliance.

GROUNDING OR POLARIZATION: Precautions should be taken so that the grounding or polarization means of an appliance is not defeated.

POWER CORD PROTECTION: Power supply cords should be routed so that they are not likely to be walked on or pinched by items placed upon or against them, paying particular attention to cords at plugs, convenience receptacles, and the point where they exit from the appliance.

SERVICING: The user should not attempt to service the appliance beyond that described in the operating instructions. All other servicing should be referred to qualified service personnel.

FUSING: If your unit is equipped with a fuse receptacle, replace only with the same type fuse. Refer to replacement text on the unit for correct fuse type.

SAFETY INSTRUCTIONS (EUROPEAN)

The conductors in the AC power cord are colored in accordance with the following code.

GREEN & YELLOW—Earth BLUE—Neutral BROWN—Live

U.K. MAIN PLUG WARNING: A molded main plug that has been cut off from the cord is unsafe. NEVER UNDER ANY CIRCUMSTANCES SHOULD YOU INSERT A DAMAGED OR CUT MAIN PLUG INTO A POWER SOCKET.



LIMITED WARRANTY

Your Carvin mixer is guaranteed against failure for 1 YEAR unless otherwise stated. Carvin will service and supply all parts at no charge to the customer providing the unit is under warranty. Shipping costs are the responsibility of the customer. CARVIN DOES NOT PAY FOR PARTS OR SERVICING OTHER THAN OUR OWN. A COPY OF THE ORIGINAL INVOICE IS REQUIRED TO VERIFY YOUR WARRANTY. Carvin assumes no responsibility for horn drivers or speakers damaged by this unit. This warranty does not cover, and no liability is assumed, for damage due to: natural disasters, accidents, abuse, loss of parts, lack of reasonable care, incorrect use, or failure to follow instructions. This warranty is in lieu of all other warranties, expressed or implied. No representative or person is authorized to represent or assume for Carvin any liability in connection with the sale or servicing of Carvin products. CARVIN SHALL NOT BE LIABLE FOR INCIDENTAL OR CONSEQUENTIAL DAMAGES.

When RETURNING merchandise to the factory, you may call for a return authorization number. Describe in writing each problem. If your unit is out of warranty, you will be charged the current FLAT RATE for parts and labor to bring your unit up to factory specifications.

MAINTAINING YOUR EQUIPMENT

Avoid spilling liquids or allowing any other foreign matter inside the unit. The panel of your unit can be wiped from time to time with a dry or slightly damp cloth in order to remove dust and bring back the new look. As with all pro gear, avoid prolonged use in caustic environments such as dust or salt air. When used in such an environment, be sure the mixer is adequately protected by a cover.

REFER SERVICING TO QUALIFIED SERVICE PERSONNEL!

REPLACEMENT PARTS LIST

Table with 4 columns: REF, Carvin P/N Description, Part Number, and Part Description. The table lists various electronic components such as resistors, capacitors, diodes, and transistors, along with their specifications and quantities.



C1644

CONCERT 44 SERIES Never before have so many features been packed into such a rugged, compact, American made mixer. The best feature of the Concert 44 Series is the sound. Sound that is pure and quiet enough for your digital recording studio! Everything is logically laid out making the powerful features simple to use and the compact size makes it a breeze to carry. The knobs are not micro size, making adjustments quick and easy - and the visible pointers show you the status of your mix at a glance. The C844, C1644, C2444 and C3244 feature 8 to 32 channels with true 4-bus performance.

TRUE 4-BUS DESIGN The Concert 44 Series offers increased mixing flexibility over standard stereo consoles by letting you assign channels to one of the 4 sub groups or L/R. This allows you to mix the entire drum, horn, choir section, etc. into one sub group fader, which feeds the L/R faders. This is an easy way to control the volume of grouped mics or inputs. If you don't need subgrouping, you can depress the L/R channel button and the channel goes directly into the L/R output like a standard stereo console. All 4 sub group outputs have balanced outputs for long cable runs.

TWO EFFECT SENDS / TWO 24-BIT EFFECT PROCESSORS Two built-in 24-Bit effects, each offering 256 stereo effects, is a first in a 4-bus mixing console. Since there are two, you no longer have to choose between that great vocal reverb with delay and that awesome guitar chorus - you can have both! Each processor offers lush REVERBS, rich CHORUSES, thick textured FLANGING and pristine ECHOES with fully adjustable parameters for damping, decay, depth, speed, time and regeneration. Both processors can be sent back into the monitor mix so the performers can hear exactly what the audience is hearing.

FOUR MONITOR SENDS Every channel can access any of the 4 MONITOR mixes while still having access to 2 EFFECTS. The MONITOR 4-ALT EFF2 control not only sends to the MONITOR 4 output but also sends to the EFFECTS 2 processor for two simultaneous effects per channel. All 4 monitor sends are balanced.

3 BAND EQ/MID SWEEP The superb EQ system gives extended 15 dB boost and cut tone shaping. The LOW frequency control builds bass response starting with 20 Hz through 80 Hz for a solid non-flabby bass. The exclusive offset of the MID FREQ. control ends the confusion of selecting your mid frequency from 100 Hz to 5kHz. The MID cut and boost control adjusts the gain to the perfect mid-dip or boost curve to enhance all instruments and vocals. The 11.5k Hz HI treble control adds sparkle to your top-end without adding harshness. Both the LOW and HI are "shelving", which means they are effective from 20 Hz and up to 20k Hz. The LO CUT switch eliminates stage rumble or other unwanted low frequencies that would normally rob power from your woofers.

TWO 9 BAND EQUALIZERS Precision equalizers provide precise 1 octave adjustments to tune in your overall sound and control feedback. Unlike one stereo equalizer, two independent 9 bands offers total flexibility. With two convenient buttons, you can assign either EQ to the R/L outputs or to the 1/2 monitor outputs. Center frequencies are 63, 125, 250, 500, 1k, 2k, 4k, 8k & 16k Hz.

C1644 BLOCK DIAGRAM

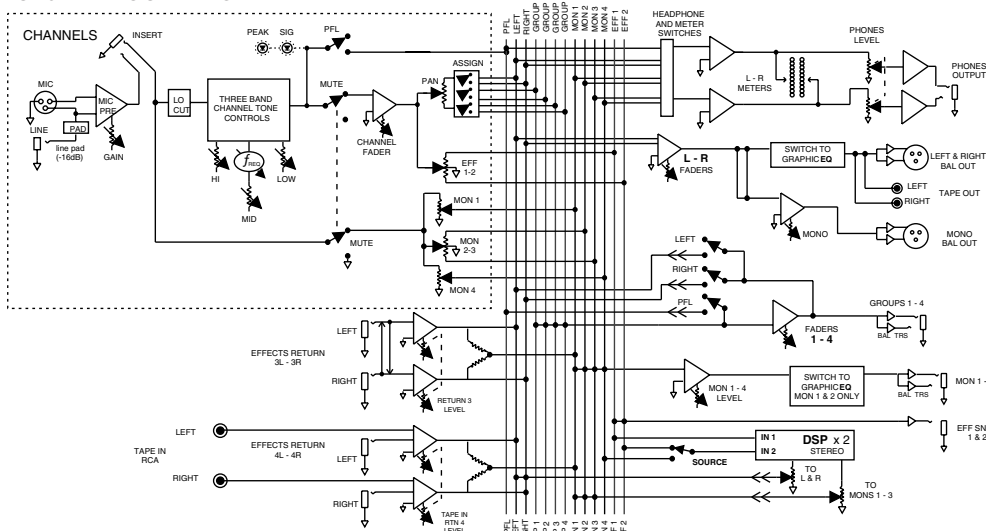

RECEIVING INSPECTION—read before getting started

INSPECT YOUR MIXER FOR ANY DAMAGE which may have occurred during shipping. If any damage is found, please notify the shipping company and CARVIN immediately.
 SAVE THE CARTON & ALL PACKING MATERIALS. In the event you have to re-ship your unit, always use the original carton and packing material. This will provide the best possible protection during shipment. CARVIN and the shipping company are not liable for any damage caused by improper packing.
 SAVE YOUR INVOICE. It will be required for warranty service if needed in the future.
 SHIPMENT SHORTAGE. If you find items missing, they may have been shipped separately. Please allow several days for the rest of your order to arrive before inquiring.
 RECORD THE SERIAL NUMBER on the enclosed warranty card or below on this manual for your records. Keep your portion of the card and return the portion with your name and comments to us.

CHANNEL FEATURES Every channel has a full balanced XLR and LINE (1/4") preamp with an INSERT jack for a compressor or EQ that also serves as a DIRECT OUT when plugged half way. The PAN control directs the channel into the L/R output or any of the 4 sub groups after depressing the appropriate ASSIGN switches. A PFL (pre fader listen) switch allows you to hear the channel before the fader is turned up in the headphones. A solid "on" condition of the PEAK led indicates that the MUTE switch has been activated which turns the channel off including all monitor and effect sends. When flashing during use, the PEAK led also lets you know when to adjust the channel's GAIN control to prevent channel overloading. The SIGNAL led lets you know that a signal is coming through the channel starting at -20 dBu. A silky smooth 60mm audio taper FADER delivers professional fade-outs. The PHANTOM power switches provide power through the XLR connectors for use with condenser mics like the Carvin CM90E in groups of 8 channels.

MASTER FEATURES Each of the 4 SUB GROUP faders can be switched to the R/L outputs or used independently through their own balanced output jacks. Each of the sub group's PFL switches allow you to listen to the sub groups in your headphones before it is turned up. The R/L MAIN output faders are independent for added flexibility over a single stereo fader. A MONO control sums both the R/L outputs together for a center, side fill or subwoofer output. The stereo HEADPHONE control tracks the METER switches which allow you to look and listen from the L/R, MONO, MONITOR 1/2 and 3/4 outputs and channel PFL switches. The master section also features 2 EFFECT SENDS, 4 RETURNS and RCA TAPE IN/OUT jacks. All 4 SUB GROUPS, 4 MONITORS, XLR L/R and MONO outputs are balanced. A FOOT SWITCH jack turns both effects processors on or off remotely with the optional FS22 foot switch.

SWITCHING POWER SUPPLY Our exclusive 125k Hz switching power supply eliminates transformer noise. Like a laptop computer, go anywhere in the world and not worry about power because you can run on any voltage from 90 to 250VAC.

SUPERB SOUND State-of-the-art low impedance, low noise preamps are featured on every channel. The balanced common mode rejection is better than 70 dB to eliminate cable noise. All main outputs are balanced to guard against system noise. The near theoretical limit on distortion has been achieved with THD below .01% to guarantee the purity of your sound, ensuring it will be dynamically open and transparent.

ENGINEERED TO LAST Hidden deep in the heart of these USA made mixers is the SMT construction that utilizes surface mounted components to prevent malfunctions caused by vibrations. Sealed controls and switches guard against the outside elements while heavy-duty jacks provide a positive connection to your cables. Fire retardant FR-4 military spec circuit cards feature double-sided copper to eliminate radio frequency interference. Precision 1% tolerance components guarantee your settings will be accurate every time. The Concert 44 Series is built to strict standards.

CONCERT SERIES SPECIFICATIONS:

Mic Input:	Balanced XLR, Mic Imp. 150Ω
Line Input:	Balanced 1/4" Jack Imp. 10k/20k bal.
Frequency Response:	Mic or Line Inputs: 20Hz-20KHz ±1dB
Total Harmonic Distortion:	Less than .01%
Equivalent Input Noise:	150 ohm source: -117dBu
Output Noise:	less than -90dBu Master Line Out
Output Headroom:	+28dB XLR bal, +20dB 1/4" unbal.
Maximum Gain:	Mic in to Master Line Out: 74dB
Crosstalk:	Adjacent channels: -60db at 1KHz
Common Mode Rejection:	-75db at 1KHz
Phantom Power:	All XLR Mic in (channel groups of 8)
Channel EQ.:	3 band active, LOW: 80Hz ±15dB MID: 100Hz to 5kHz ±15dB HI: 11.5kHz ±15dB
9 Band Graphic EQ.:	±12dB 63, 125, 250, 500, 1k, 2k, 4k, 16k
Power:	90 to 250VAC 50-60Hz, 20 to 50VA
Size:	C844: 14.25"D x 14.5"W x 3.25"H C1644: 14.25"D x 22.25"W x 3.25"H C2444: 14.25"D x 30"W x 3.25"H C3244: 14.25"D x 38.1"W x 3.25"H
Optional Accessories:	
C844:	CB800 Heavy padded bag FS22 foot switch for all models
C1644:	CB1600 Heavy padded bag AN1600 Anvil™ hard case
C2444:	CB2400 Heavy padded bag AN2400 Anvil™ hard case
C3244:	AN3200 Anvil™ hard case



12340 World Trade Drive, San Diego, CA 92128
 (800) 854-2235 www.carvin.com

C844, C1644, C2444 & C3244 4-BUS MIXERS

QUICK START UP

If you're like most new owners, you're probably in a hurry to plug your mixer in and use it. Here are some brief instructions to get you going quickly. With the mixer unplugged and the unit turned off, complete the following procedures:

1. CONNECTING AC POWER TO YOUR MIXER

- The mixer can be used with 120 or 240VAC (it automatically switches internally)
- Use only a grounded (3 prong) power outlet to prevent a shock hazard. This gives the quietest grounding for your mixer.

2. CONNECTING INPUTS TO YOUR MIXER

- For low level balanced devices such as microphones, plug into the balanced **MIC** inputs using a shielded microphone cable with XLR connectors.

- For high level balanced or unbalanced devices such as instruments & keyboards, plug into the **LINE** input jacks using a shielded cable with 1/4" phone plugs. Adjust the **GAIN** knob for the mic or line input being used.

3. TURNING YOUR MIXER ON

- Adjust all channel **FADERS** and master **LEVEL** controls to their **OFF** positions
- Adjust all channel's **HI**, **MID**, and **BASS** controls and the two master 9 Band **GRAPHICS** to their **center** position.
- Adjust the Channel "**PAN**" controls to their **center** position.
- Turn the mixer on by the rear panel **POWER SWITCH** and watch for the **POWER LED**. Your mixer is now ready to operate.

11. EFF 1/EFF 2 CONTROL

The **EFF 1/2** control will send a signal to **EFFECTS 1** or **EFFECTS 2** and to the **EFF 1-2** jacks (#36). The center position is **OFF**. If **BOTH** effects are desired simultaneously for all channels, press the **MASTER EFFECTS 2 SOURCE EFF2/MON4** switch (#21) and use the **MON 4** channel send, which will also send to the **MON 4** output (#39).

12. PAN CONTROL

Each channel's **PAN** control allows stereo imaging by panning Left or Right during recordings or live performances. The **PAN** control also works for the sub-mix groups. A center position will send a channel's signal to a pair of sub-group faders (1-2, 3-4 when assigned). By panning hard left, the signal is routed to only sub-group fader 1 or 3 when assigned. Panning hard right routes the signal to sub-mix fader 2 or 4. Dual element pan controls provide 15dB greater separation than standard pan controls.

C44 SERIES CONTROLS

CHANNEL FEATURES

1. 1/4" LINE INPUTS

The line connectors are for connecting balanced and unbalanced instruments and line level sources such as drum machines, keyboards, ETC.

2. XLR MIC INPUTS

The balanced Mic inputs are for connecting microphones that use XLR connections. Both the **LINE** and **XLR MIC** inputs can be used simultaneously.

3. CHANNEL INSERT/CHANNEL DIRECT OUT

To insert channel effects, compressor, etc. use a 1/4" TRS (Tip Ring Sleeve) cable (see **INSERTS AND DIRECT OUT** illustration on page 5 for TRS details). To achieve a direct out from the channel, insert a standard 1/4" cable to the first "click" (1/2 insert).

4. GAIN

The **GAIN** controls the input level for the channel. If the **GAIN** is set too high, the **PEAK** LED will flash and distortion may occur. Decrease the amount of **GAIN** until the **PEAK** LED does not flash. It is important that the gain control should be kept right under the **PEAK** LED flash point to maintain the lowest noise performance of the channel. You can use the channel **PFL** switch to monitor the channel input level and use the meters to adjust the **GAIN** control to **0dB**. This will give you a good reference point where the **GAIN** control should be set.

5. LOW CUT SWITCH

A 75 Hz **LOW CUT** filter helps eliminate unwanted low frequencies. Great for reducing "boom" noise from mic stands or from acoustic/electric guitars. Turning up the **LOW EQ** when using this filter can help create a punchier bass response.

6. ACTIVE 3 BAND EQ

The **C44 SERIES** mixers provide studio EQ. The ± 15 dB boost or cut gives an overall 30 dB range for powerful EQ control. The active circuits deliver deep bass from the 20-80 Hz **LOW** control. The **MID** control works at 100Hz to 5kHz, depending on the **MID FREQ** control. The **HI** control functions at 11-20k for crisp highs.

Start out with all tone controls at their center "zero" position. Determine which position your **MID FREQ** sounds best, then cut or boost your **HI**, **MID**, and **LOW** frequencies as needed. If you are trying to mic instruments such as acoustic guitar or drums, try various mics and mic placement before adjusting your tone controls. A typical setting may be: **HI +6**, **MID -4** (**MID FREQ** set at **700Hz**), and **LOW +4**. *Don't be afraid to push the HI and LOW controls to get good presence and depth while reducing the MID's to clean up your sound. This is the key to great sound.*

7. MID SWEEP

This control allows you to select which frequency (from 100Hz to 5kHz) that the **MID** control will boost or cut. Instruments and singers have various tonal qualities. By adjusting the **MID FREQ**, you can select the exact frequency that will best complement these various inputs. 700Hz is a recommended setting for the **MID FREQ** control for guitar and vocals.

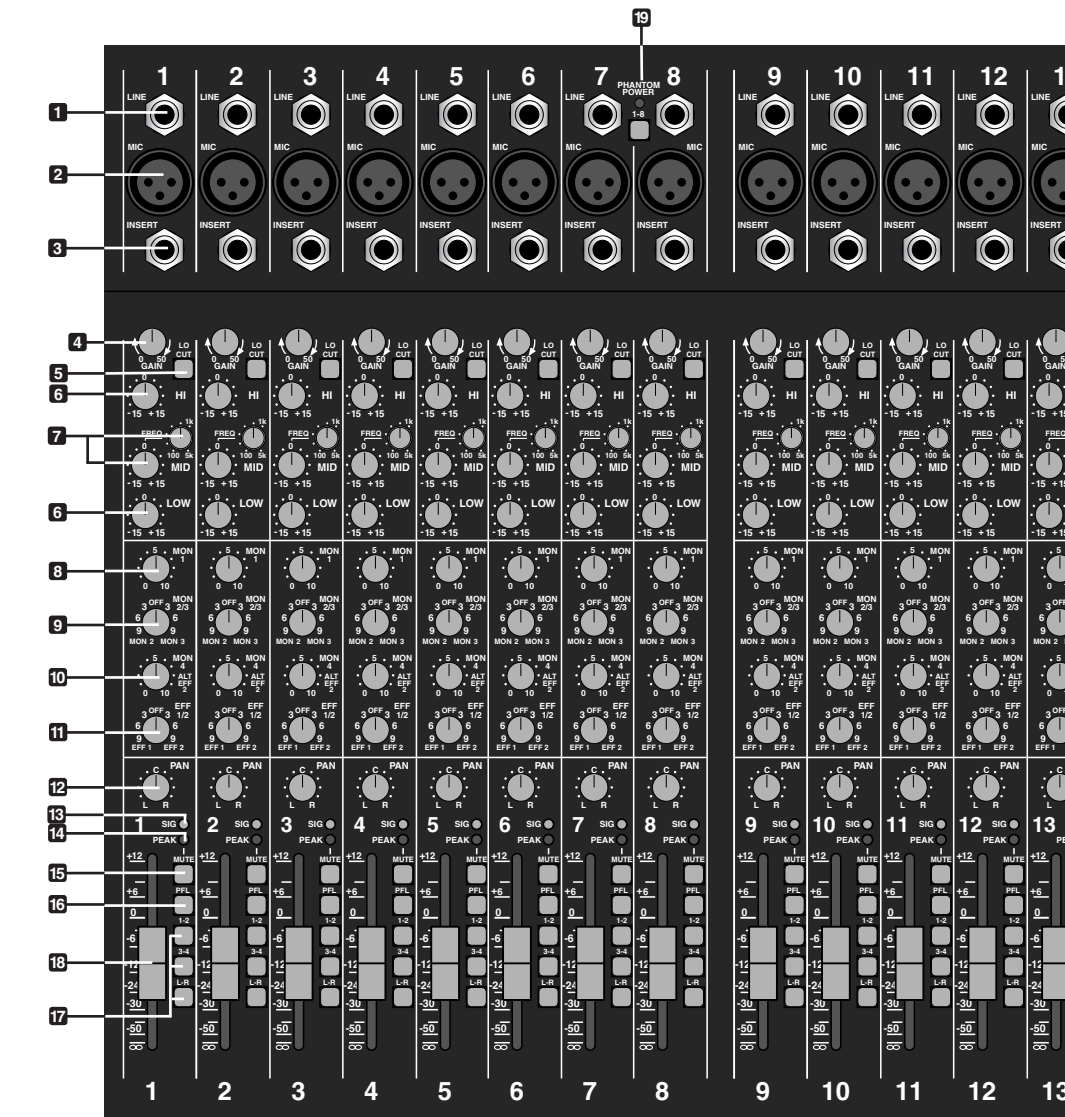

8. 9. 10. MONITOR 1 THRU 4 CONTROLS

The channel **MONITOR** controls allow you to create four independent monitor mixes. The **MONITOR** signals (pre-EQ, pre fader) are routed to the master **MON 1**, **2**, **3** and **4** controls (#24) respectively before going to the output connectors (#39). To start, use **MON 1**. The **MON 2/MON 3** control will send either to **MON 2** or **MON 3**. The center position is **OFF**. The **MON 4-ALT EFF 2** not only sends to the **MON 4** out but also to the **EFF2** if the **EFF2/MON 4** switch (#21) is selected in the master **EFFECTS 2** processor. This provides two simultaneous effects per channel and the use of **MON 4**.

13. CHANNEL SIGNAL GREEN LED

The **SIGNAL LED** is pre-fader and post EQ. This LED helps the operator verify that the channel is receiving a signal from the mic or instrument inputs even when the channel fader is off.

14. CHANNEL PEAK RED LED

This peak indicator is pre-fader and post EQ. If the **PEAK** LED flashes, the channel needs a reduction with the **GAIN** control (#4) to prevent distortion. A "solid" lit **PEAK** LED indicates that the channel has been **MUTED**.

15. CHANNEL MUTE SWITCH

Use the **MUTE** switch to kill the channel. This feature saves having to reset your faders and monitor sends.

16. CHANNEL PFL SWITCH

This switch allows the operator to listen to a channel (pre fader listen) in the headphone mix to set tone and gain levels as well as see the channel at the LED meter output (#32).

17. CHANNEL ASSIGNMENT SWITCHES

These switches assign the channels' signal to the Master L/R faders, or to the **SUB-GROUP** faders 1 & 2, 3 & 4 for sub-mixing in stereo pairs. For mono, **PAN** fully to the left and assign a channel to Sub-Group fader 1 or 3 only. **PAN** fully to the right and assign a channel to Sub-Group fader 2 or 4. Likewise assigning the L/R switches sends the channel directly to the main L or R faders.

18. CHANNEL FADER

The **CHANNEL FADER** adjusts the output level of the channel. The signal will go to one or more of the Master Faders, depending on both the Channel Assignment switches and the **PAN** control. Calibrated **60mm FADERS** with audio taper are featured for smooth fade-outs. Slide all faders down when connecting your inputs. Note: for best board performance, channel faders should be set slightly higher than the Sub-Groups and Master L/R faders.

19. MIC PHANTOM POWER SWITCH / RED LED

This switch provides phantom power for condenser mics such as Carvin's **CM90E** in groups of 8 channels. This leaves the remaining MIC inputs for sources that don't require phantom power. The LINE inputs are unaffected by phantom power.

MASTER SECTION

20. TWO STEREO 24-BIT EFFECTS

The internal 24-BIT stereo processors receive signals from the **EFF 1 / EFF 2** channel controls. If the adjacent **PK** (peak) LED flashes, reduce the level from the channel **EFF 1 / EFF 2** control. A "solid" **PK** LED will show **EFFECTS 1** or **2** have been muted, either by the **MUTE** switches or by the optional **FS22** footswitch (#41). The **RETURN** control will adjust the volume level of the selected effects. Remember each channel has its own **EFFECT** send that will send the signal to the effects processors. The red **PK** LED will indicate when the effects signal from the channel is distorting. Reduce the level of the channel **EFFECT** control until the **PK** LED stops flashing.

EFFECT AND PARAMETERS

ECHO: When the **SELECT** control is at the "7 O'clock" position, it is selected to the first **ECHO** setting where you get a single repeat echo (minimal regeneration). Turning the **PARAMETER**

control to 1 will provide the shortest delay time between the original signal and the echo. Increasing the **PARAMETER** control to the right will increase the time delay between the original signal and the echo. To increase the number of echo repeats, turn the **SELECT** control clockwise to "9 O'clock" (maximum regeneration).

REVERB: When the **SELECT** control is at the "10 O'clock" position, it is selected to the first **REVERB** setting. Turning the **SELECT** control clockwise will increase the amount of high frequencies in the reverb. Turning the **PARAMETER** control to 1 will provide minimal decay time of the reverb. Increasing to the right will increase the reverb decay time.

CHORUS: When the **SELECT** control is at the "11 O'clock" position it is selected to the first **CHORUS** setting. Turning the **SELECT** control clockwise will increase the amount reverb in the chorus. Turning the **PARAMETER** control to 1 will provide a minimal chorus depth setting. Increasing to the right will increase the chorus depth.

FLANGE: When the **SELECT** control is at the "4 O'clock" position it is selected to the first **FLANGE** setting. Turning the **SELECT** control clockwise will increase the flanger's speed. Turning the **PARAMETER** control to 1 will provide minimal flanging depth. Increasing to the right will increase the flanger's depth.

To send effects to the monitors, use the "TO MONITORS" controls, **MON 1/MON 2 & MON 1/MON 3**. The center position on both controls is OFF.

21. SOURCE EFF2/MON4 SWITCH

In the "OUT" position, the **EFFECTS2** processor gets its signal from the **EFF2** channel send control. Clicking this switch "IN" will route the **MON 4** mix (#10) to the internal **EFFECTS 2** processor. This allows both effects to be used on each channel simultaneously.

22. RETURN 3 L/R

Receives stereo or 2 mono effect signals from the **RETURN 3 L/R** jacks. These signals will also be present at **MON 1** (#39).

23. RCA TAPE IN/RTN EFF4 JACKS

Receives a signal from the **RTN4/LR** 1/4" jacks (#38) & from the **TAPE IN** jacks (#44). These signals will also be present at **MON 1**.

24. MONITOR 1-4 CONTROLS These are the master outputs for the four monitor sends. These correspond to the balanced 1/4" **MON 1-4** output jacks (#39).

25. GROUP/SUB-MIX FADERS 1-4

Once a channel has been assigned to one of these faders, the mixing process is simplified to using these four faders. If these faders are not assigned to the Master L-R faders (#27), then each fader is bused to the corresponding **4 GROUP 1/4"** outputs (#40). By assigning the 4 faders to the Master L-R faders, the operator can use the faders to sub-mix groups.

26. GROUP PFL SWITCHES

These **PFL** switches allow the operator to monitor the entire **GROUP** mix. If distortion is heard or if the **PFL** level is near **PEAK** on the Master L/R METERS, lower the channel faders assigned to that group. Also check the channel **PEAK** LEDs.

27. GROUP ASSIGNMENT SWITCHES

These switches send the sub-group mix to the main L/R faders. For mono mixing, assign to both L/R.

28. MASTER L/R FADERS

These faders adjust the level of the main stereo output created by all channels and groups assigned to L/R faders. Output appears at the L/R balanced XLR connectors (#45).

29. MONO OUTPUT

The **C44 SERIES** creates an extra mono output from the L/R master faders (post) for center, side fill speakers or subwoofers. The output is at the **MONO** XLR connector (#46).

30. HEADPHONE AND METER SOURCE

The stereo **PHONES** control sets the level of the **PHONES** jack (#42). The **PFL, L/R, MONO, MON 1-2** and **MON 3-4** switches allow for isolation of these sources through the headphones and the L/R LED METERS (#32).

31. PFL RED LED

Indicates that the headphone & meters are monitoring *only* the channels or groups where the **PFL** is switched on.

32. L/R LED VU METERS

This group of 10 LEDs offer 6 dB increment resolution that give the operator a visual indication of the mixer's output levels, selectable by the **METER SOURCE** or **PFL** switches (#30).

33. DUAL PRECISION 9 BAND GRAPHIC EQS are one octave filters at 60, 125, 250, 500, 1k, 2k, 4k, 8k & 16k Hz centers that offer ± 12 dB adjustment to help eliminate feedback & enhance tone for the main or monitor mix.

34. EQ SWITCH 1 & 2

These switches swap the 9 band EQ's from the standard L/R main outputs "OUT" to the **MON 1 & MON 2** outputs "IN" respectively.

35. POWER LED

Verifies the mixer is on.

36. EFFECTS 1 & 2 OUTPUT JACKS

1/4" outputs drive external effects. Connect your effects processor's inputs to these jacks.

37. RETURN 3 L/R INPUT JACKS

Returns a stereo signal from an external effect. Connect your effects processors' stereo outputs to these jacks. If only one **RTN 3** jack is used, the mono signal will go to both L/R.

38. RTN 4 L/R INPUT JACKS

Returns a stereo signal from other sources.

39. MONITOR 1-4 OUTPUT JACKS

The **C44 SERIES** provides balanced 1/4" outputs for long cable runs. Connect your monitor power amps to these jacks.

40. GROUP 1-4 OUTPUT JACKS

The **C44 SERIES** provides balanced 1/4" outputs. Connect your 4-track recorder or side fill power amps to these jacks.

41. EFF SW 1-2 FOOTSWITCH JACK

The optional **FS22** will remotely shut off **EFFECTS 1** or **2**.

42. HEADPHONE JACK

1/4" stereo jack for headphone or control room output.

43. RCA L & R TAPE OUT

RCA jacks for connecting to a tape recorder input.

44. RCA L & R TAPE IN

For stereo playback of a tape/CD (parallel with **RTN 4** jacks).

45. L/R XLR OUTPUT CONNECTORS

This set of balanced XLR connectors are for connecting the main L/R output to power amps or recording gear.

46. MONO XLR OUTPUT CONNECTOR

A balanced XLR output is featured for side fills or subwoofers.



STEREO LIVE SOUND SYSTEM

In a live sound reinforcement system, the input signals to the mixer will come from the microphones and instruments. Each microphone or instrument to be amplified by the system must be connected to one of the mixing console inputs. It is preferred to have as many of the stage instruments as possible plugged into the mixer. This allows for the best overall control of the instruments as they are mixed together and then amplified by the system. The mixer can be operated on the stage or from a remote location in the audience using a "snake cable" to bring the signals from the stage to the mixer. The advantage of the remote operation allows the performance to be mixed from the audience's perspective. NOTE: Most snake cables are not designed for speaker connections.

THE SOUND CHECK

The sound check takes some skill, but mostly patience from the performers and especially "you" the system operator. If you get frustrated during the sound check, the sound may suffer due to things missed in the sound check. The basic sound check follows this format: First test all micro-

phones and other input devices (direct boxes, etc.) before the performers are included in the sound check. A good thing to also check here is feedback in the monitors from the microphones. Good positioning of the monitors and the use of a graphic equalizer solves most major monitor feedback problems. Now for a sound check with the performers. First set the level of each performer individually and in cases where a performer has multiple microphones such as with drummers, set each drum mic individually then the drum set as a whole. This is also a good time to make some channel EQ control adjustments to tailor the sound of the individual performers and instruments. After setting each individual, have the performers run through a song. Don't hesitate to stop the performers if something needs to be adjusted or a performer or microphone needs to be heard solo again. Remember the sound check is not a rehearsal, but a system check. It is always a good idea for the operator to have a microphone to inform the performers of what is needed during the sound check. If a monitor system is being used, the operator's microphone should only be directed through the monitors when addressing the on stage performers, especially if something needs to be checked during the show.

CHANNEL CONNECTIONS AND SUB-MIXING

CONNECTING UP

The XLR Mic inputs are balanced low impedance inputs. Phantom power for condenser mics is available in channel groups of eight. This enables the user to group all mics that require phantom power together, leaving the rest of the channels available for dynamic microphones or line inputs. The XLR Mic inputs and balanced 1/4" Line inputs on each channel can be used simultaneously, however the two signals will be controlled by the single GAIN control. Adjust the level of the instruments to balance the mix. For stereo instruments, such as keyboards or drum machines, use two consecutive channels to connect the Left and Right outputs from the instrument. Then use the PAN controls on the two channels to pan hard left and right for a stereo mix. If a pair of individual channels are not available, one of the stereo returns in the master section can be used.

Whenever possible, try to group all related instruments or mics near each other on the mixer. For example: put all drum mics on channels 1 through 8, guitars, bass and keyboards on 9 through 16, and vocals on 17 through 24. This will make mixing, channel assigning and sub-mixing easier to manage.

SUB-MIXING

The 4 bus section on the C44 mixers can be used for main outputs, surround outputs, side fills, outputs to a multi-track recorder, etc. but the most common use is for sub mixing. Sub grouping is the process of assigning multiple channels to a pair of sub group faders in the master section. This is usually done to decrease the number of faders needed to adjust a group of channels. For example: a drum kit with 6 or more microphones mixed in stereo can be assigned to a pair sub-mix faders. If the drums need to be adjusted in the main mix, only group 2 faders need be adjusted instead of 6 channel faders. The individual microphones all use different fader settings, so it is important to get a balanced mix of the entire drum kit during the sound check. The drum sub-group faders are then assigned to the L-R main faders. If the drums are to be mixed mono, use the channel pan controls to pan the audio "hard left" and the audio will only be assigned to sub-group fader 1 or 3. Panning "hard right" will bus the audio to sub-mix faders 2 or 4. Always keep channel and sub group faders higher than the master L-R faders. Using the L-R fader or sub group fader to boost the level of a week channel signal can result in excess noise.

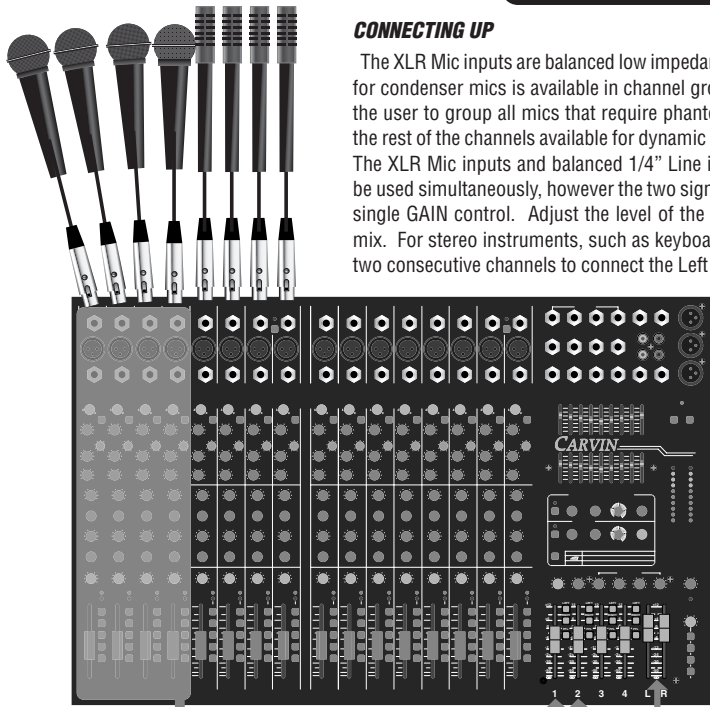

The illustration shows channels 1-4 assigned to sub-mix faders 1 & 2. The final L-R mix is created by assigning the sub-mix faders to the L-R faders.

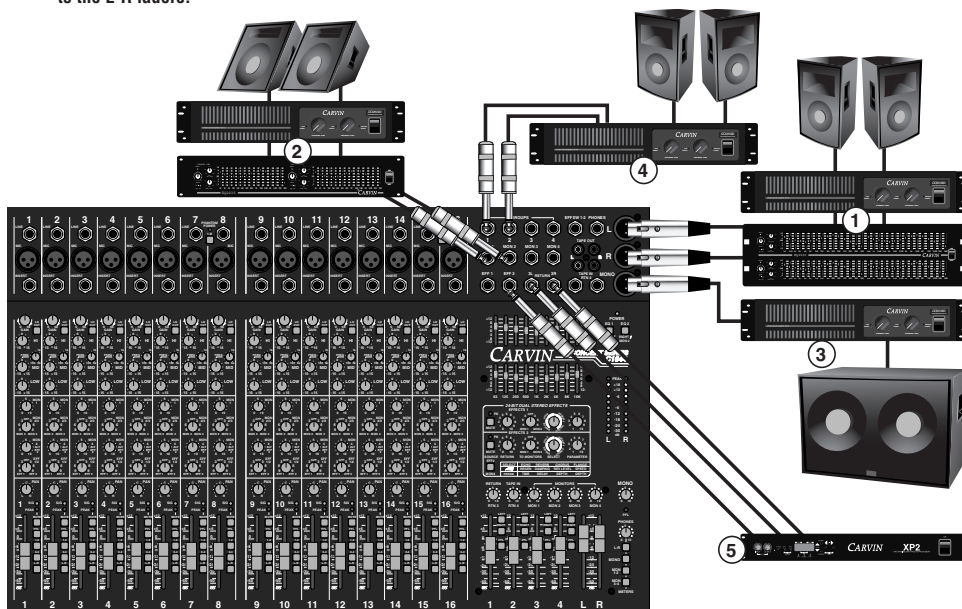

The diagram depicts a standard live sound system

1. Stereo EQ and power amp for the main speakers on the Left/Right outputs.
2. Stereo power amp for two monitor mixes on the MON 1 and MON 2 outputs.
3. Bridged power amp for a subwoofer on the MONO output.
4. Power amp for the use as side fill or back of room fill on the Group outputs.
5. Effects processor in the EFF2 send, EFF3 stereo return loop.

MASTER OUTPUTS

The main stereo loudspeakers should contain an overall mix of all channels. The sub-group faders 1-4 can have certain channels assigned to them before the mix arrives at the master L-R faders. This is known as sub-mixing and can improve the efficiency of mixing a large number of channels (see above).

The four independent monitor mixes should use the MON 1 through MON 4 sends. On the channel these sends are pre-EQ, pre-fader. The MONO output can be used for a main mono mix, a center mix or as a subwoofer output.

The sub group outputs can also be used as side or back fill speakers. Long rooms can have poor sound at the back of the room. Set up a set of back fill loudspeakers to fill in and add a digital delay to the main speakers to correct the time delay from front to back. This can improve the sound of the room considerably.

INSERTS AND DIRECT OUTS

FULL INSERT

The insert jack is a Tip Ring Sleeve (TRS) 1/4" phone jack, where the tip is the send, the ring is the return and the sleeve is ground. When used as an insert point or in full insert mode, the channel is opened up to allow an external piece of equipment to be inserted into the channel's signal path. The channel signal coming from the microphone preamplifier will be forced to go through the external equipment before it can continue back through the channel re-entering before the channel EQ controls. Most external equipment is not set up for the TRS plug directly so an adapter cable is required. The adapter cable will have on one end the TRS plug and two mono plugs either male or female on the other end. The two plugs each have the ground connected to the sleeve, one has the return on its tip and the other has the send on its tip. This allows the send to be connected to the input of the external equipment and the return to its output completing the insert loop back to the channel.

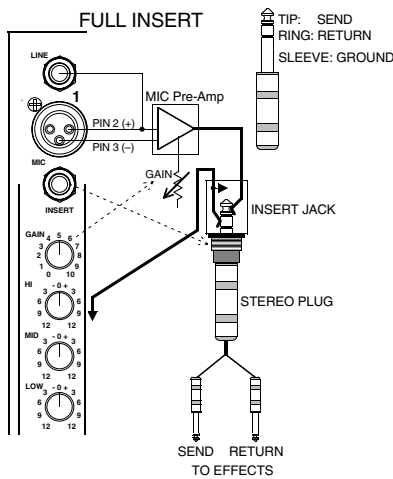

HALF INSERT DIRECT OUT

The "half" insert connection creates a send signal without breaking the channel's signal path. The insert in this mode is no longer used as an insert but it becomes what is called an "insert direct out". An insert direct out functions as a normal direct out but the plug has to be half inserted. If an insert is needed on the same channel, special cabling is required to perform both functions. The half insertion connects the tip of the plug to the ring of the jack. If the jack is fully inserted to where the tip of the plug connects to the tip of the jack, the internal jack switch will open and the channel's signal path will be broken. The connection will still function as a direct out but the channel's signal will stop at the insert and not continue on to the rest of the channel. The result of the half insert is multiple outputs for use in multi-track recording.

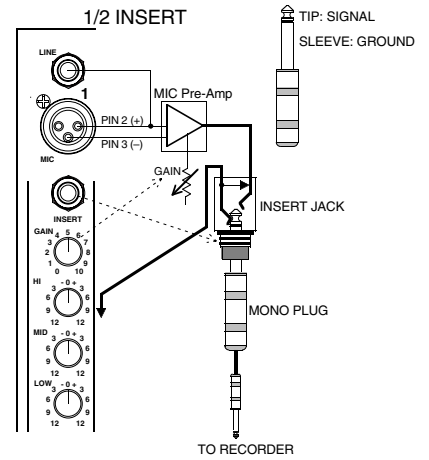

ADJUSTING THE 9-BAND EQ

When the 9 band graphic EQ sliders are in their "center" position, they do not affect the audio signal. When the EQ sliders are raised or lowered from this position, they boost or cut respectively a narrow band of frequencies. To reduce feedback in the low frequency range try lowering one of the 63, 125 or 250 Hz sliders. High frequency feedback is reduced by lowering one of the 2k or 4k Hz sliders. To help with feedback reduction, the main speaker should always be placed in front of the microphones.

For tone enhancement, you may want to raise the 63, 125 (for deeper bass) and the 4, 8 and 16k (for crisper highs). At the same time you may want to reduce the mid frequency at 1k forming a "smile" curve as shown.

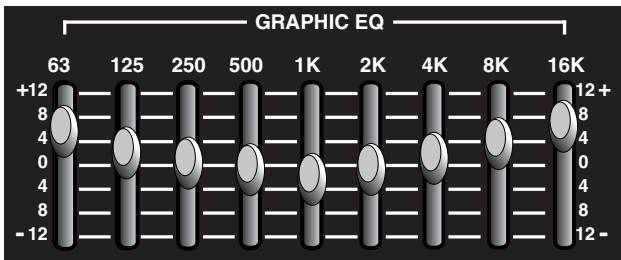

MULTI-TRACK RECORDING

A multi-track recorder can be connected to the Channel Insert jacks (1/2 plugged). This set up could be used with a live set up to record a live show.

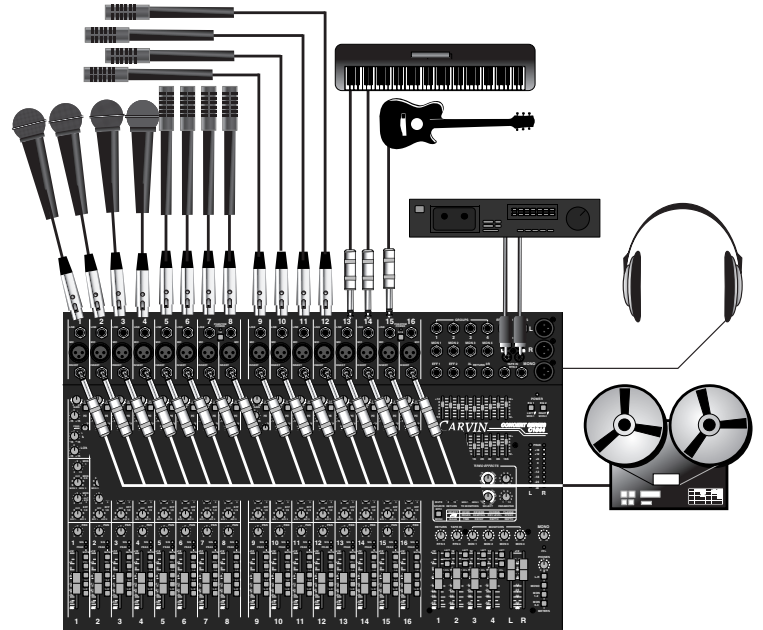

MULTI-TRACK MIXDOWN

Follow this set up for mixing down to a two track recorder. Connect the Multi-track recorders' outputs to the line inputs of the channels. Use the headphones or connect a professional power amplifier (Carvin's DCM power amps) and high quality studio monitors (Carvin's SRS6.5) to your main L/R outputs to monitor your mixdown sessions. Mixing is a practiced skill. A trained ear will know when to add EQ, effects, compression, gate. Listen to your favorite CD through the same headphones or monitoring system you plan to mix through. Note each instrument's level and position in the stereo mix. Use this as a guide to help mix your project.

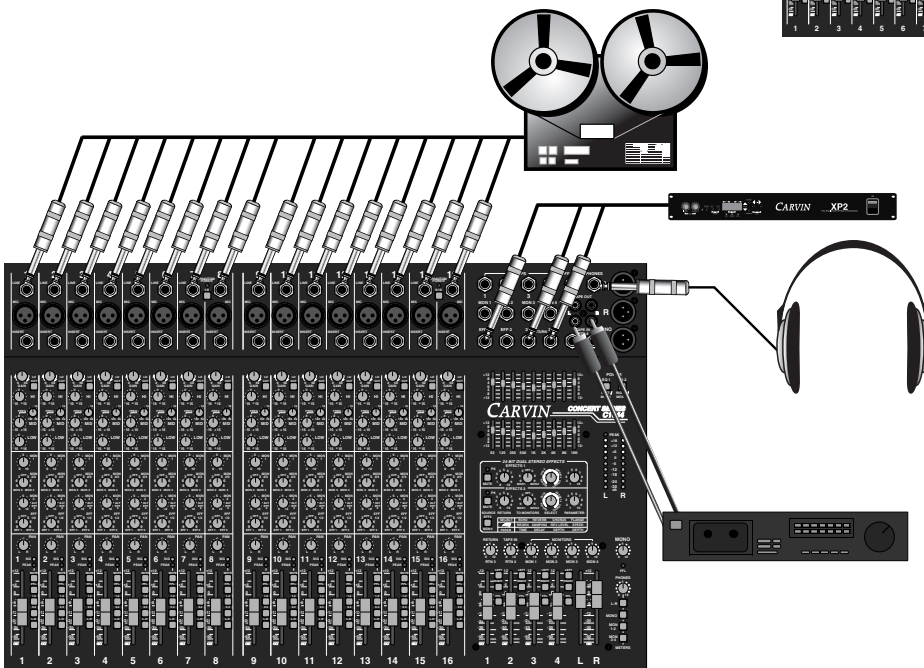

Free Manuals Download Website

<http://myh66.com>

<http://usermanuals.us>

<http://www.somanuals.com>

<http://www.4manuals.cc>

<http://www.manual-lib.com>

<http://www.404manual.com>

<http://www.luxmanual.com>

<http://aubethermostatmanual.com>

Golf course search by state

<http://golfingnear.com>

Email search by domain

<http://emailbydomain.com>

Auto manuals search

<http://auto.somanuals.com>

TV manuals search

<http://tv.somanuals.com>