

# CASIO®

EN

Digital Camera

# EX-TR50

## User's Guide

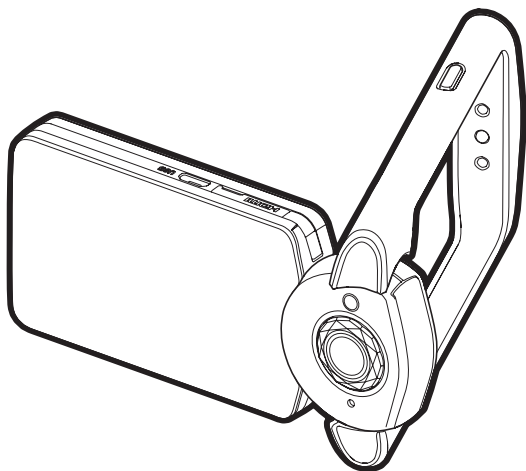

Thank you for purchasing this CASIO product.

- Before using it, be sure to read the precautions contained in this User's Guide.
- Keep the User's Guide in a safe place for future reference.
- For the most up-to-date information about this product, visit the official EXILIM Website at <http://www.exilim.com/>

# EXILIM

## Accessories

As you unpack your camera, check to make sure that all accessories shown below are included. If anything is missing, contact your original retailer.



Rechargeable lithium ion  
battery (NP-150)

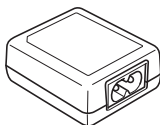

USB-AC adaptor  
(AD-C53U)

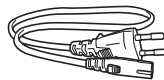

Power cord\*

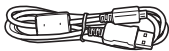

Micro USB cable

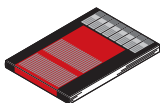

Basic Reference

\* The shape of the power cord plug varies according to the country or geographic area where the camera is sold.

## Read this first!

- The contents of this manual are subject to change without notice.
- The contents of this manual have been checked at each step of the production process. Feel free to contact us if you notice anything that is questionable, erroneous, etc.
- Any copying of the contents of this User's Guide, either in part or its entirety, is forbidden. Except for your own personal use, any other use of the contents of this manual without the permission of CASIO COMPUTER CO., LTD. is forbidden under copyright laws.
- CASIO COMPUTER CO., LTD. shall not be held liable for any damages or lost profits suffered by you or any third party due to the use or malfunction of this product.
- CASIO COMPUTER CO., LTD. shall not be held liable for any damages, lost profits, or claims by third parties arising out of the use of EXILIM Remote.
- CASIO COMPUTER CO., LTD. shall not be held liable for any damages or lost profits caused by loss of memory contents due to malfunction, repair, or any other reason.
- Note that the example screens and product illustrations shown in this User's Guide may differ somewhat from the screens and configuration of the actual camera.

### LCD Panel

The liquid crystal panel of the monitor screen uses high-precision technology that provides a pixel yield in excess of 99.99%. This means that some very small number of pixels may not light or may remain lit at all times. This is due to the characteristics of the liquid crystal panel, and does not indicate malfunction.

#### **Take test shots**

Before shooting your final image, shoot a test shot to ensure that the camera is recording correctly.

# Contents

Accessories . . . . .	2
Read this first! . . . . .	3
General Guide . . . . .	8
Monitor Screen Contents and How to Change Them . . . . .	9

## Quick Start Basics 11

---

What you can do with your CASIO camera . . . . .	11
Changing the Camera Style to Suit Shooting Conditions . . . . .	13
■ Opening and Closing the Frame . . . . .	13
■ Rotating the Monitor Screen . . . . .	14
■ Camera Configurations . . . . .	15
Using the Touch Panel . . . . .	16
First, charge the battery prior to use . . . . .	18
■ Loading the Battery . . . . .	18
■ Charge the Battery . . . . .	19
Configuring Basic Settings the First Time You Turn On the Camera . . . . .	24
Preparing a Memory Card . . . . .	26
■ Supported Memory Cards . . . . .	26
■ To load a memory card . . . . .	27
■ To format (initialize) a new memory card . . . . .	28
Turning Power On and Off . . . . .	29
To Shoot a Snapshot . . . . .	30
■ Selecting an Auto Recording Mode . . . . .	30
■ To shoot a snapshot . . . . .	31
Viewing Snapshots . . . . .	33
Deleting Snapshots and Movies . . . . .	34
Snapshot Shooting Precautions . . . . .	36

## Recording Images 37

---

Selecting a Recording Mode . . . . .	38
■ Shooting with Posing Shot . . . . . (Posing Shot) . . . . .	39
■ Shooting with Artistic Effects . . . . . (ART SHOT) . . . . .	40
■ Shooting Three Versions of an Image with Different Skin Tone Settings . . . . . (Make-up BKT) . . . . .	42
■ Recording Beautiful Portraits . . . . . (Make-up) . . . . .	43
Using the Camera as a Mirror . . . . .	44
Shooting with Zoom . . . . .	45
Shooting a Self-portrait . . . . .	46
To record a movie . . . . .	47

## Using BEST SHOT 50

---

Shooting with Triple Shot . . . . .	51
Using Motion Shutter to Trigger a Self-timer Operation . . (Motion Shutter) . .	52
Digitally Correcting for Overexposure and Underexposure . . . . . (HDR) . .	53
Shooting with High Speed Night Scene . . . . . (HS Night Scene) . .	53
Shooting with High Speed Night Scene and Portraits . . . . . (HS Night Scene Portrait) . .	54

## Advanced Recording Settings 55

---

Using the REC Menu . . . . .	55
■ Using Touch Shutter . . . . . (Touch Shutter) . .	56
■ Using the Self-timer . . . . . (Self-timer) . .	56
■ Using the LED Light . . . . . (LED) . .	57
■ Changing the Image Size . . . . . (Image Size) . .	58
■ Movie Image Quality Settings . . . . . (Movie Quality) . .	59
■ Correcting Image Brightness . . . . . (Brightness) . .	59
■ Adjusting White Balance . . . . . (White Balance) . .	60
■ Specifying ISO Sensitivity . . . . . (ISO) . .	61
■ Selecting a Focus Mode . . . . . (Focus) . .	62
■ Turning on Image Review . . . . . (Review) . .	63

## Viewing Snapshots and Movies 64

---

Viewing Snapshots . . . . .	64
Viewing a Movie . . . . .	64
■ Editing a Movie on the Camera . . . . . (Movie Editing) . .	66
Viewing the Image Menu . . . . .	67
Zooming an On-screen Image . . . . .	67
Viewing Snapshots and Movies on a TV Screen . . . . .	68

## Other Playback Functions (PLAY) 70

---

Using the PLAY Menu . . . . .	70
■ Creating a Promotion Movie . . . . . (Promotion Movie) . .	70
■ Performing Paint Operations on an Image . . . . . (Paint) . .	72
■ Playing a Slideshow on the Camera . . . . . (Slideshow) . .	73
■ Extracting an Image from a Snapshot . . . . . (Cut out subject) . .	73
■ Inserting a Subject into another Snapshot or Adding a Built-in Frame to a Snapshot . . . . . (Paste subject) . .	75
■ Protecting a File Against Deletion . . . . . (Protect) . .	76
■ Rotating an Image . . . . . (Rotation) . .	77
■ Resizing a Snapshot . . . . . (Resize) . .	77
■ Cropping a Snapshot . . . . . (Trimming) . .	78

---

## **Establishing a Wireless LAN Connection** **79**

---

Wireless LAN Functions .....	79
Establishing a Connection between a Smartphone and Your Camera .....	81
■ Installing the EXILIM Remote App on Your Smartphone .....	81
■ Configuring Wireless LAN Settings .....	82
Using a Smartphone as a Camera Remote Controller . (Remote Capture) ..	83
Sending a Just-recorded Snapshot to a Smartphone . . . (Send Last Shot) ..	85
Sending a Snapshot or Movie File from Camera Memory to a Smartphone .....	(Send to phone) .. 86
Resizing Snapshots before Sending Them to a Smartphone .....	(Resize before send) .. 87
Viewing Snapshots and Movies in Camera Memory on a Smartphone .....	(View on phone) .. 88

---

## **Printing** **89**

---

Printing with a Computer .....	89
--------------------------------	----

---

## **Using the Camera with a Computer** **91**

---

Things you can do using a computer... ..	91
Using the Camera with a Windows Computer .....	91
■ Viewing and Storing Images on a Computer .....	92
■ Playing Movies .....	94
Using the Camera with a Macintosh .....	95
■ Connecting the Camera to Your Computer and Saving Files .....	95
■ Playing a Movie .....	97
Files and Folders .....	98
Memory Card Data .....	99

---

## **Other Settings** **(Set Up) 100**

---

Adjusting Monitor Screen Brightness .....	(Screen) . 100
Selecting Display Information .....	(Info) . 100
Locking the Screen .....	(Screen Lock) . 101
Resizing Snapshots before Sending Them to a Smartphone .....	(Resize before send) . 101
Configuring Camera Sound Settings .....	(Sounds) . 101
Time Stamping Snapshots .....	(Timestamp) . 102
Configuring World Time Settings .....	(World Time) . 103
■ Setting a Travel Destination .....	103
■ Selecting the Time Display .....	103
Setting the Camera's Clock .....	(Adjust) . 104
Specifying the Date Style .....	(Date Style) . 104
Specifying the Display Language .....	(Language) . 105
Selecting the HDMI Terminal Output Method .....	(HDMI) . 105

Changing the Camera Password for	
Wireless LAN Connection . . . . . (WLAN password) .	106
Displaying a Startup Screen at Power On . . . . . (Startup) .	106
Formatting Built-in Memory or a Memory Card . . . . . (Format) .	107
Resetting the Camera to Factory Defaults . . . . . (Reset) .	107

---

## **Appendix** **108**

Safety Precautions . . . . .	108
Precautions During Use . . . . .	115
Power Supply . . . . .	120
■ Charging . . . . .	120
■ Battery Precautions . . . . .	121
■ Using the Camera in another Country . . . . .	121
Using a Memory Card . . . . .	122
Reset Initial Default Settings . . . . .	123
When things don't go right... . . . . .	125
■ Troubleshooting . . . . .	125
■ Display Messages . . . . .	129
Number of Snapshots/Movie Recording Time . . . . .	130
Specifications . . . . .	132

## General Guide

The numbers in parentheses indicate the pages where each item is explained.

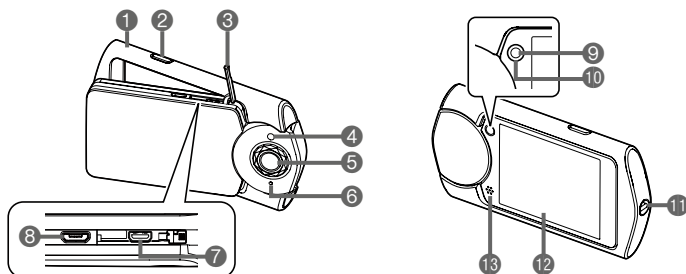

- ① Frame (page 13)
- ② Shutter button (page 31)
- ③ [HDMI] HDMI output (page 68)
- ④ LED light (page 57)
- ⑤ Lens
- ⑥ Microphone (pages 16, 49)
- ⑦ [HDMI] HDMI output (micro) (page 68)
- ⑧ [USB] port (pages 19, 22, 92, 96)
- ⑨ [⏻] (Power) (page 29)
- ⑩ Back lamp (pages 20, 23, 29, 31)
- ⑪ Strap hole (page 8)
- ⑫ Monitor screen (pages 9, 9, 16, 100)
- ⑬ Speaker

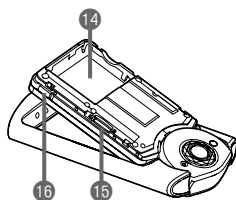

- ⑭ Battery compartment (page 18)
- ⑮ Memory card slot (pages 27, 122)
- ⑯ [OPEN] button (pages 18, 27)

- Above illustration shows the camera's cover removed (page 18).

To attach the strap (commercially available or separately available) to the camera

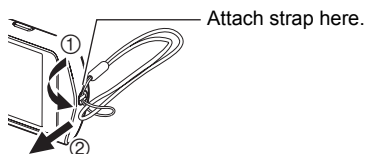



## Monitor Screen Contents and How to Change Them

The monitor screen uses various indicators, icons, and values to keep you informed of the camera's status.

- The sample screens in this section are intended to show you the locations of all the indicators and figures that can appear on the monitor screen in various modes. They do not represent screens that actually appear on the camera.

### ■ Snapshot Recording

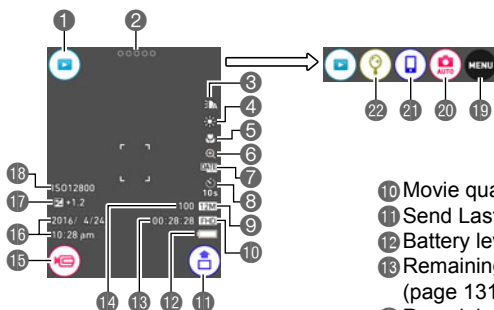

- 1 PLAY mode icon (page 29)
- 2 “○○○○○” (Show Icons) icon
- 3 LED light (page 57)
- 4 White Balance (page 60)
- 5 Focus mode (page 62)
- 6 Digital zoom (page 45)
- 7 Timestamp (page 102)
- 8 Self-timer mode (page 56)
- 9 Snapshot image size (page 58)

- 10 Movie quality (pages 47, 59)
- 11 Send Last Shot icon (page 85)
- 12 Battery level indicator (page 24)
- 13 Remaining movie memory capacity (page 131)
- 14 Remaining snapshot memory capacity (page 130)
- 15 “Ⓜ” Movie icon (pages 32, 47)
- 16 Date/Time (pages 24, 104)
- 17 Brightness (page 59)
- 18 ISO sensitivity (page 61)
- 19 Menu icon (page 55)
- 20 Recording mode icon (page 38)
- 21 Remote capture icon (page 83)
- 22 Mirror mode icon (page 44)

### ■ Movie Recording

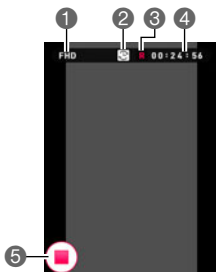

- 1 Movie quality (pages 47, 59)
- 2 Recording time switch icon (page 48)
- 3 Movie remaining time icon (page 48)
- 4 Remaining movie memory capacity/  
Movie recording time (pages 48, 131)
- 5 “Ⓜ” Movie stop icon (pages 32, 48)

## ■ Snapshot Viewing

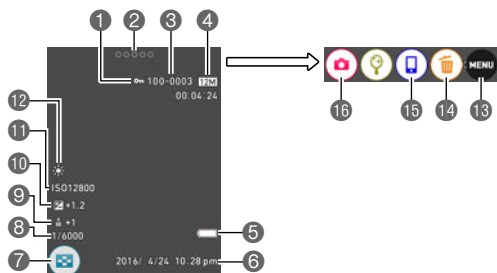

- ① Protect indicator (page 76)
- ② “○○○○○” (Show Icons) icon
- ③ Folder name/file name (page 98)
- ④ Snapshot image size (page 58)
- ⑤ Battery level indicator (page 24)
- ⑥ Date/time (pages 24, 104)
- ⑦ Image menu icon (page 67)
- ⑧ Shutter speed
- ⑨ Make-up (page 43)
- ⑩ Brightness (page 59)
- ⑪ ISO sensitivity (page 61)
- ⑫ White Balance (page 60)
- ⑬ Menu icon (page 70)
- ⑭ Delete icon (page 34)
- ⑮ Image send icon (pages 86, 88)
- ⑯ REC mode icon (page 29)

## ■ Movie Playback

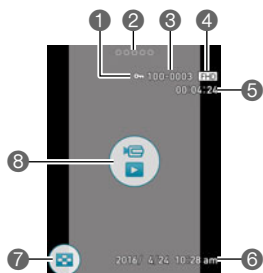

- ① Protect indicator (page 76)
- ② “○○○○○” (Show Icons) icon
- ③ Folder name/file name (page 98)
- ④ Movie quality (pages 47, 59)
- ⑤ Movie recording time (page 64)
- ⑥ Date/time (pages 24, 104)
- ⑦ Image menu icon (page 67)
- ⑧ “🎬” Movie play icon (page 64)

## What you can do with your CASIO camera

Your CASIO camera is packed with a powerful selection of features and functions to make recording of digital images easier, including the following main functions.

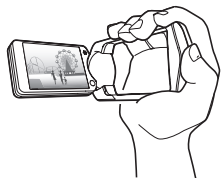

### A variety of shooting styles

The frame can be opened and the LCD monitor screen rotated into positions that make long-term shooting more comfortable and simplify self-shooting.

→ See page **13** for more information.

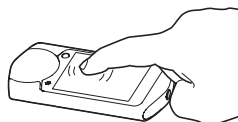

### Simple touch panel operation

The monitor screen is a touch panel that can be used to perform operations.

→ See page **16** for more information.



### Simple self-portrait shooting

The monitor screen can be rotated so it faces in the same direction as the camera's lens, making self-shooting much easier.

→ See page **46** for more information.

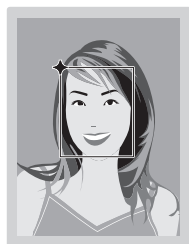

### Shooting better looking portraits

Make-up enables adjustment of human skin tone hues and texture, and softening of facial shadows caused by harsh sunlight for better looking portraits.

→ See page **43** for more information.

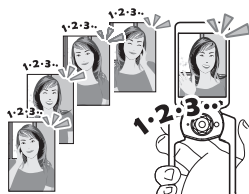

### Posing Shot

Posing Shot lets you shoot five successive snapshots, as the camera provides voice guidance.

→ See page **39** for more information.



## ART SHOT

A variety of artistic effects help to make even common, ordinary subjects become more novel and exciting. "ART SHOT" provides the following effects: HDR Art, Crystal Ball, Sparkling Shot, Toy Camera, Soft Focus, Light Tone, Pop, Sepia, Monochrome, Miniature, Fisheye.

→ See page **40** for more information.



## Paint

Draw figures, write text, or stamp information into a recorded snapshot.

→ See page **72** for more information.

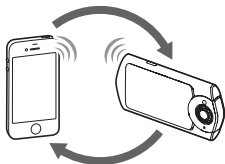

## Wireless LAN Connection

Turns your smartphone into a camera remote controller and allows you to send images recorded with your camera to your smartphone.

→ See page **79** for more information.

## Changing the Camera Style to Suit Shooting Conditions

You can change the configuration of the camera by opening or closing the frame and rotating the monitor screen panel to suit shooting conditions.

### **IMPORTANT!**

- Do not apply strong pressure to the surface of the monitor screen. Doing so can damage it.
- Never touch the lens with your fingers. Finger smudges, dirt, and other foreign matter on the lens can interfere with proper operation of the camera. Use a blower or other means to keep the lens and flash window free of dirt and dust, and wipe gently with a soft, dry cloth.

## Opening and Closing the Frame

The camera's frame can be rotated 90 degrees towards the lens side and 225 degrees towards the opposite side.

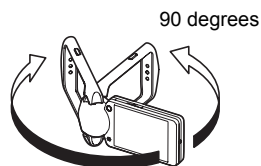

**1. With the lens facing towards you, hold onto the frame.**

**2. Push the monitor screen panel.**

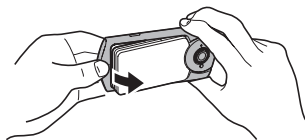

**3. Holding the edges of the monitor screen panel, swing the frame open.**

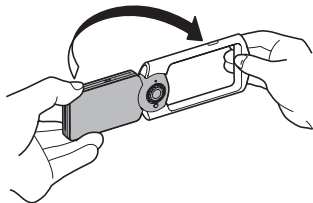

### **IMPORTANT!**

- Do not try to open or close the frame while the monitor screen panel is rotated. Doing so can cause the frame to come into contact with the monitor screen panel and cause malfunction.

## Rotating the Monitor Screen

---

Use the steps below to rotate the monitor screen.

### NOTE

---

- While holding the monitor screen panel as shown in the illustration, you can rotate it 180 degrees clockwise and 90 degrees counterclockwise.
- The monitor screen panel can also be rotated when the frame is closed.

### 1. Hold the camera as shown in the illustration.

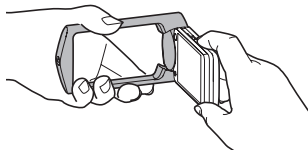

### 2. Firmly holding the frame, carefully rotate the monitor screen panel.

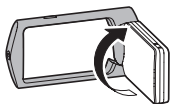



180 degrees clockwise



90 degrees counterclockwise

## Camera Configurations

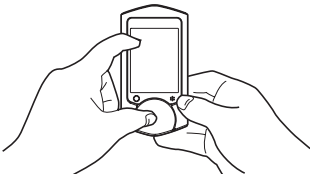
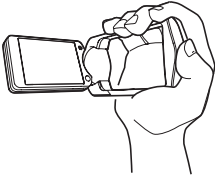
You can open the frame and rotate the monitor screen for a variety of different styles.

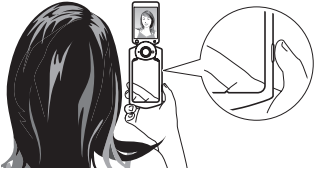
Normal Shooting	Movie Recording
<p data-bbox="94 193 505 244">Shoot with the monitor screen facing the opposite direction of the lens.</p> 	<p data-bbox="525 193 936 270">Open the frame 90 degrees and hold the frame. You can also shoot with the camera upside down, if you like.</p> 
Tabletop Shooting	Self-portrait Shooting
<p data-bbox="94 569 505 671">Point the monitor screen and lens in the same direction and open the frame about 30 degrees so the camera can stand up.</p> 	<p data-bbox="525 569 912 620">Open the frame, point the monitor screen and lens in the same direction.</p> 

## NOTE

- When shooting hold the camera still. Carefully press the shutter button and take care to avoid all movement as the shutter releases and for a few moments after it releases.
- Take care that your fingers and the strap do not cover any of the areas indicated in the illustration.
- To protect against accidentally dropping the camera, attach the wrist strap (commercially available or separately available) and make sure it is around your fingers or wrist while you are operating the camera.
- Never swing the camera around by its strap.

## IMPORTANT!

- Take care to ensure that your finger is not blocking or is not too close to the LED light. Fingers can cause unwanted shadows when shooting.

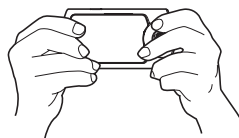
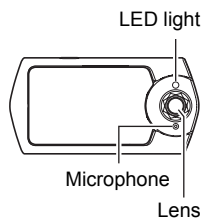

## Using the Touch Panel

The monitor screen of the camera is a touch panel. This means you can perform the following operations by touching the screen with your fingers.

### Touch

Momentarily touching the screen with your finger. Touch the screen to select an icon or menu item, and to configure settings.

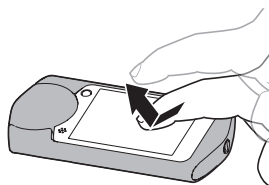

### Touch-and-hold

Holding your finger against the screen. Touch and hold the screen to perform continual frame-by-frame playback of a movie.

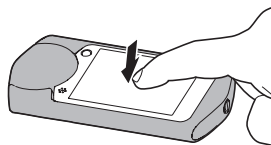



## Drag

Holding your finger against the screen as you drag it up, down, left, or right.

Use drag to move a screen image to a different location, and to scroll between images.

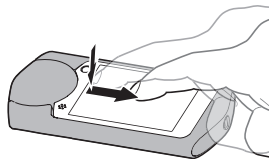

## Spread

Holding your thumb and forefinger against the screen as you spread them out.

Use spread to enlarge the screen image.

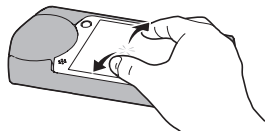

## Squeeze

Holding your thumb and forefinger against the screen as you bring them together.

Use squeeze to reduce the size of the screen image.

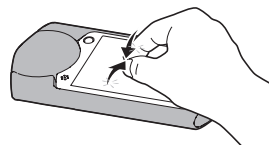

## **IMPORTANT!**

- Never use a pointed or hard object to perform screen operations. Doing so can damage the screen.
- The camera will have a hard time interpreting a screen operation made using your fingernails. Use the fleshy pad of your finger.

## **NOTE**

- Applying a commercially available LCD protective sheet will reduce the operation sensitivity of the monitor screen.

## First, charge the battery prior to use.

Note that the battery of a newly purchased camera is not charged. Perform the steps below to load the battery into the camera and charge it.

- Your camera requires a special CASIO rechargeable lithium ion battery (NP-150) for power. Never try to use any other type of battery.

### Loading the Battery

#### 1. Open the frame (page 13).

#### 2. Open the cover.

While depressing the [OPEN] button, slide the cover in the direction of arrow ② in the nearby illustration.

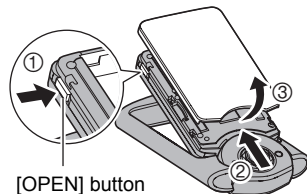

#### 3. Load the battery.

With the CASIO logo on the battery upwards, load the battery into the camera as shown in the illustration.

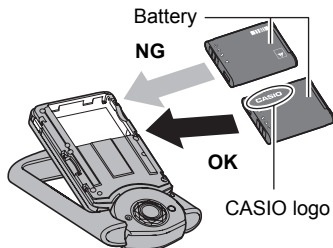

#### 4. Close the cover.

- Positioning the cover about two millimeters from the lens unit, keep it parallel with the camera as you slide it in the direction of arrow ① and then arrow ② to secure it in place.

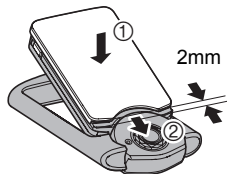

## To replace the battery

### 1. Open the cover and remove the current battery.

As shown in the illustration, pull up the edge of the battery to remove it.



### 2. Load a new battery.

## Charge the Battery

You can use either of the two following methods to charge the battery. Before charging the battery, use the procedure under “Opening and Closing the Frame” (page 13) to open the frame.

- USB-AC adaptor
- USB connection to a computer

### ■ To charge with the USB-AC adaptor

The adaptor lets you charge the battery while it is loaded in the camera.

While the camera is turned off, connect in the sequence shown below.

Charging time: Approximately 140 minutes

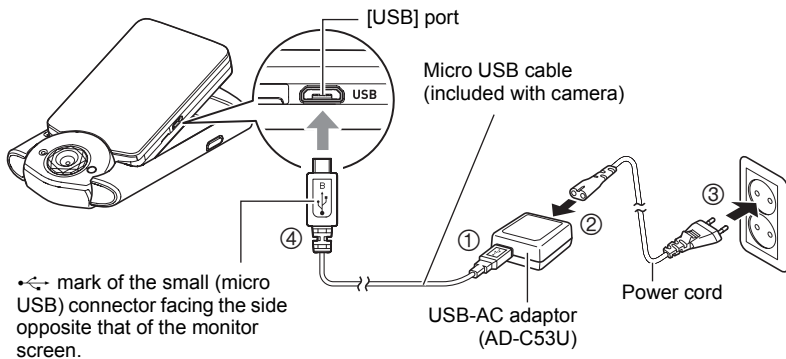

- When disconnecting the USB-AC adaptor from the camera, be sure to disconnect from the camera first.

## **IMPORTANT!**

- A battery that has not been used for a long time, or ambient temperature extremes can cause charging to take longer than normal. If charging takes longer than about five hours, a timer will terminate it automatically, even if the battery is not fully charged. This is indicated by the back lamp flashing red. If the battery has not been used for a very long time, charging may be terminated automatically and the back lamp may start flashing red after only about 60 minutes. In either case, disconnect the USB cable from the camera and then reconnect it to resume charging.
- Pressing [⏻] (Power) while the USB-AC adaptor is connected to the camera will turn on the camera with power being supplied by the battery. Because of this, charging will stop.
- The USB-AC adaptor will become warm during charging. This is normal and does not indicate malfunction.
- The shape of the power plug depends on each country or geographic area.

### **Back Lamp Operation**

<b>Lamp Status</b>	<b>Description</b>
Lit Red	Charging
Flashing Red	Abnormal ambient temperature, USB-AC adaptor problem, or battery problem (page 120), or charging terminated by the timer
Off	Charging complete

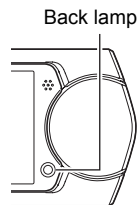

## USB Cable Connection Precautions

- When connecting the USB cable to the camera, make sure that the cable connector and monitor screen panel are oriented correctly as shown in the illustration below.

Make sure that the  mark side of the USB cable connector and the front of the monitor screen panel (the side opposite that of the monitor screen) are facing in the same direction.

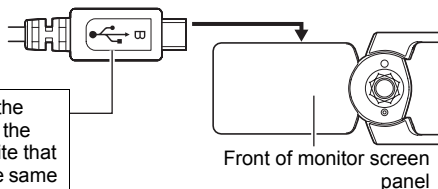

The back lamp always initially light after charging starts. Even if the battery is already fully charged, the lamp will light momentarily.

If the lamp does not light, check the orientation of the USB cable connector.

- Make sure that you insert the cable connector into the USB port until you feel it click securely into place. Failure to insert the connector fully can result in poor communication or malfunction.
- Note that even while the connector is fully inserted, you still will be able to see the metal part of the connector as shown in the illustration.

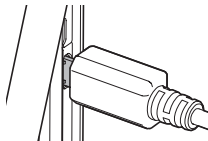

## ■ To charge using a USB connection to a computer

USB connection lets you charge the battery while it is loaded in the camera. While the camera is turned off, connect in the sequence shown below (①, ②).

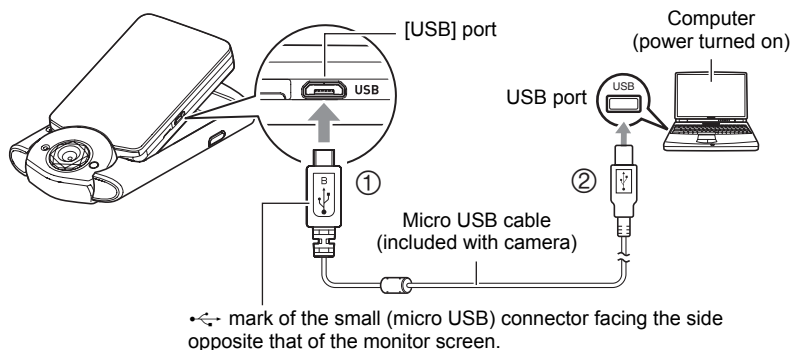

- If the camera is on, press [⏻] (Power) to turn it off before connecting it to your computer.  
Charging time: Approximately 170 minutes

### ★ **IMPORTANT!**

- The first time you connect the camera to your computer with the USB cable, an error message may appear on your computer. If this happens, disconnect and then reconnect the USB cable.
- A battery that has not been used for a long time, certain types of computers, and connection conditions can cause charging to take more than approximately five hours, which will trigger a timer that terminates charging automatically, even if the battery is not fully charged. If this happens, disconnect and then reconnect the USB cable to restart charging. To complete charging faster, use of the included USB-AC adaptor is recommended.
- If the battery has not been used for a very long time, charging may terminate automatically and the back lamp may start flashing red or go out after only about 60 minutes. In either case, use of the USB-AC adaptor that comes with the camera is recommended.
- If you turn on the camera while charging over a USB connection to a computer is in progress, the camera will establish a USB connection with the computer. Though charging normally should continue at this time, certain types of computers or connection environments may stop charging if supply power is low. This will be indicated by the camera's back lamp lighting green.
- Charging is not performed while the connected computer is in the hibernate mode.

## Back Lamp Operation

Lamp Status	Description
Lit Red, (Lit/Flashing Amber)	Charging
Flashing Red	Abnormal ambient temperature, charging taking abnormally long, or battery problem (page 120)
Off, (Lit Green)	Charging complete

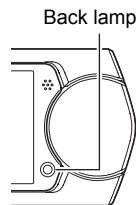





- The information in parentheses in the above table shows the lamp status while the camera is turned on during charging.

### Other Charging Precautions

- With the two charging methods described above, you can charge the camera's battery (NP-150) without removing it from the camera. Never use any other type of charger device. Attempting to use a different charger can result in unexpected accident.
- This model can be charged only via from USB 2.0 specification USB port only.
- USB charging devices and power supply devices are subject to fixed standards. Use of an inferior device or a device that is not up to standard can cause malfunction and/or failure of your camera.
- Operation is not guaranteed in the case of a computer built or modified by you. Even in the case of a commercially available computer, certain USB port specifications may make it impossible to charge via the USB cable.
- A battery that is still warm immediately after normal use may not charge fully. Give the battery time to cool before charging it.
- A battery discharges slightly even when it is not loaded in the camera. Because of this, it is recommended that you charge the battery immediately before you need to use it.
- Charging the camera's battery may cause interference with TV and radio reception. If this happens, plug the USB-AC adaptor into an outlet that is further away from the TV or radio.
- Actual charging time depends on current battery capacity and charging conditions.
- Do not use the USB-AC adaptor with any other device.
- Never use the power cord with another device.
- Use only the USB-AC adaptor and USB cable specified in this manual for charging. Use of any other type of devices may result in improper charging.

## Checking the Current Battery Level

As battery power is consumed, a battery indicator on the monitor screen indicates its current level as shown below.

<b>Remaining Power</b>	High ←————→ Low
<b>Battery Indicator</b>	 →  →  → 
<b>Indicator Color</b>	White → White → Red → Red

 indicates battery power is low. Charge the battery as soon as possible.

Recording is not possible when  is indicated. Charge the battery immediately.

The level shown by the battery indicator may change when you switch between the REC mode and PLAY mode.

- Leaving the camera for about 20 days with no power supplied while the battery is dead will cause its date and time settings to be cleared. A message telling you to configure time and date settings will appear the next time you turn on the camera after restoring power. When this happens, configure date and time settings (page 104).
- See page 134 for information about battery life and number of shots.

## Configuring Basic Settings the First Time You Turn On the Camera

The first time you turn on the camera, a screen appears for configuring the display language, date, and time settings. Failure to set the date and time correctly will cause the wrong date and time data to be recorded with images.

### **IMPORTANT!**

- A screen for language selection will not appear in step 2 of the procedure below if you purchased a camera intended for the Japanese market. To change the display language from Japanese in this case, use the procedure under “Specifying the Display Language (Language)” (page 105). Note that a version of this manual in the language you select may not be included with a camera intended for the Japanese market.
- Camera models sold in certain geographic areas may not support display language selection.



**1. Press [⏻] (Power) to turn on the camera.**

**2. Drag (page 17) upwards and downwards until you find the language you want, and then touch to select it.**

**3. Touch the date display format you want.**

Example: July 10, 2015  
YY/MM/DD → 15/7/10  
DD/MM/YY → 10/7/15  
MM/DD/YY → 7/10/15

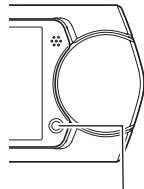

[⏻] (Power)

**4. Touch the value you want to change (year, month, day, hour, minute).**

**5. Touch “⏮”, “⏭” to change the currently selected value.**

- Touching and holding “⏮”, “⏭” will change the setting at high speed.
- To switch between 12-hour and 24-hour format, touch the 12/24 hour switch icon.

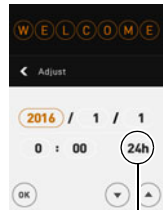

12/24 hour switch icon

**6. When the date and time settings are the way you want, touch “OK”.**

**7. Touch “Auto” or “Premium Auto Pro” to select the default auto recording mode you want.**

**8. Touch “Apply”.**

- You will be able to change this setting later, if you want. See page 30 for details.

If you make a mistake configuring display language, date, or time settings with the above procedure, refer to the following pages for information about how to correct the settings.

- Display language: Page 105
- Date and time: Page 104

## NOTE

- Each country controls its local time offset and the use of summer time, and so they are subject to change.

## Preparing a Memory Card

Though the camera has built-in memory that can be used to store images and movies, you probably will want to purchase a commercially available memory card for greater capacity. The camera does not come with a memory card. Images recorded while a memory card is loaded are saved to the memory card. When no memory card is loaded, images are saved to built-in memory.

- For information about memory card capacities, see page 130.

## Supported Memory Cards

- microSD Memory Card
- microSDHC Memory Card
- microSDXC Memory Card



- The above are supported memory card types as of June 2014.
- This camera supports use of microSD memory cards of the following types and capacities: microSD memory cards up to 2GB, microSDHC memory cards from 2GB up to 32GB, microSDXC memory cards from 32GB up to 2TB. Note that the ability to use any particular card with this camera, even if it satisfies the above capacity and type requirements, is not guaranteed.

### Warning!

- Memory cards are small and present a risk of accidentally being swallowed by infants and young children. Keep memory cards out of the reach of infants and young children. If a memory card is ever swallowed accidentally, contact a physician immediately.



## To load a memory card

1. Press [⏻] (Power) to turn off the camera and then open the frame (page 13).

2. While holding down [OPEN], slide the cover in the direction of arrow ② in the nearby illustration to remove it.

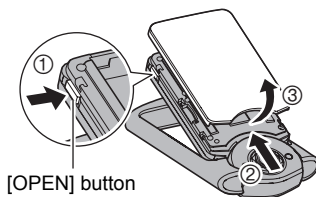

3. Load a memory card.

Positioning the memory card as shown in the nearby illustration insert it into the camera's memory card slot and press until you hear it click into place.

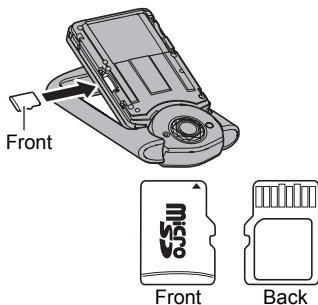

4. Close the cover.

- Positioning the cover about two millimeters from the lens unit, keep it parallel with the camera as you slide it in the direction of arrow ① and then arrow ② to secure it in place.

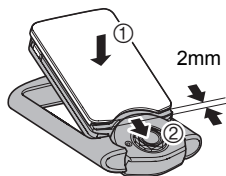

### **IMPORTANT!**

- Never insert anything besides a supported memory card (page 26) into the memory card slot.
- Should water or any foreign object ever get into the card slot, immediately turn off the camera, and contact your retailer or nearest CASIO authorized service center.

## ■ To replace the memory card

Press the memory card and then release it. This will cause it to pop out of the memory card slot slightly. Pull the card out the rest of the way and then insert another one.

- Never remove a card from the camera while the back lamp is flashing green. Doing so can cause the image save operation to fail and even damage the memory card.

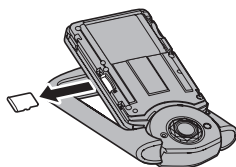

## ■ To format (initialize) a new memory card

Format a memory card on the camera before using it for the first time.

### ★ IMPORTANT!

- Formatting a memory card that already has snapshots or other files on it, will delete its contents. Normally you do not need to format a memory card again. However, if storing to a card has slowed down or if you notice any other abnormality, re-format the card.
- Be sure to use the camera to format a memory card. Formatting a card on a computer will result in a non-SD standard format, which can greatly slow down processing time and cause compatibility, performance, and other problems.

**1. Load a memory card (page 27).**

---

**2. Turn on the camera and then touch “○○○○” (Show Icons).**

---

**3. Touch “MENU”.**

---

**4. Drag upwards and downwards until you find “Setup”, and then touch it.**

---

**5. Touch “Format”.**

---

**6. Touch “Format” and then touch “Yes”.**

This starts the memory card format operation.

## Turning Power On and Off

### ■ To turn on the camera

Press [⏻] (Power).

This will turn on the camera, which is indicated when the back lamp lights green, and enter the REC mode.

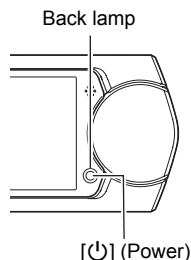

### Entering the REC Mode and PLAY Mode

<b>To enter the PLAY mode</b>	In the REC mode, touch "⏮" (PLAY). <ul style="list-style-type: none"><li>• If "⏮" (PLAY) is not displayed on the screen, you can touching the Review image (page 63), or switch to the PLAY mode by touching "○○○○○" (Show Icons) and then touching "⏮" (PLAY).</li></ul>
<b>To enter the REC mode</b>	In the PLAY mode, touch "○○○○○" (Show Icons). On the screen image that appears, touch "⏻" (REC).

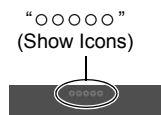

### ■ To turn off the camera

Press [⏻] (Power).

Screen after "○○○○○" (Show Icons) is touched

"⏮" (PLAY) / "⏻" (REC)



### NOTE





- To conserve battery power, an Auto Power Off function will turn off power automatically if you do not perform any operation for about five minutes.

## To Shoot a Snapshot

Your camera has a variety of different recording modes to suit various shooting conditions and objectives (page 38). This section explains general shooting procedures using the auto recording mode.

### Selecting an Auto Recording Mode

You can select one of two auto recording modes (Auto or Premium Auto Pro) according to your digital imaging needs.

Setting	REC Screen Icon Display	Description
 <b>Auto</b>		This is the standard Auto recording mode.
 <b>Premium Auto Pro</b>		With Premium Auto Pro recording, the camera automatically determines whether you are shooting a subject or scenery, and other conditions. Premium Auto Pro recording delivers higher image quality than standard Auto recording. <ul style="list-style-type: none"><li>• Some of the settings configured automatically by Premium Auto Pro cannot be changed by you.</li><li>• It also requires more power (and runs down the battery quicker) than Auto.</li></ul>

1. Press [⏻] (Power) to turn on the camera.
2. Touch “○○○○” (Show Icons).
3. Touch the second icon from the right (second icon from the top in the case of portrait display orientation) (Recording mode).

Recording mode icon



4. Touch “Auto” or “Premium Auto Pro” to select the auto recording mode you want.

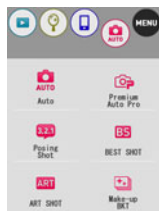

## To shoot a snapshot

### 1. Point the camera at the subject.

If you are using Premium Auto Pro, text will appear on the monitor screen describing the type of shot the camera has detected.

- Spread your fingers apart on the screen to change the zoom factor (page 45).



+ (Telephoto)



– (Wide Angle)



Type of shot

### 2. Half-press the shutter button to focus the image.

When focus is complete, the camera will beep, the back lamp will light green, and the focus frame will turn green.

#### Half-press

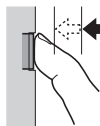

Press lightly until the button stops.

Beep, beep (Image is in focus.)

When you half-press the shutter button, the camera automatically adjusts exposure and focuses on the subject it is currently pointed at. Mastering how much pressure is required for a half-press and a full-press of the shutter button is an important technique for good-looking images.

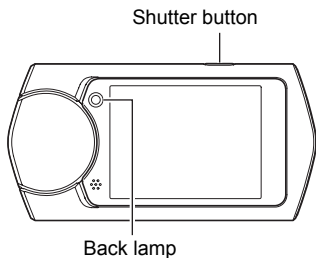

Focus frame

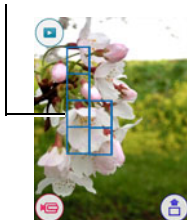

### 3. Continuing to keep the camera still, press the shutter button the rest of the way down.

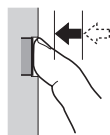

This records the snapshot.

#### Full-press



Snap (Image is recorded.)

#### Recording a Movie

Touch “” (Movie) to start movie recording. Touch “” (Movie Stop) to stop recording. See page 47 for details.



“” (Movie)/  
“” (Movie Stop)

#### NOTE

- You also can shoot a snapshot by touching a point on the monitor screen (page 56).
- You can specify the image size for snapshots. See page 58 for more information.

#### ■ If the image does not focus...

If the focus frame stays red and the back lamp is flashing green, it means that the image is not in focus (because the subject is too close, etc.). Re-point the camera at the subject and try to focus again.

#### ■ Shooting with Auto

“Focus lock” (page 63) is the name of a technique you can use when you want to shoot an image in which the subject to be focused on is not within the focus frame in the center of the screen.



## ■ Shooting with Premium Auto Pro

- Some menu items are not available while Premium Auto Pro is in use (page 55). Only the menu items whose settings can be configured will be displayed on the menus while Premium Auto Pro is in use.
- In addition to shutter speed and ISO sensitivity, the camera automatically executes the following operation as required when shooting with Premium Auto Pro.
  - Auto Focus is normally performed until you half-press the shutter button.
  - The camera automatically determines the focus point on the screen and focuses there.
  - When shooting people, the face detection feature detects the faces of up to ten individuals and adjusts focus and brightness accordingly.
- When shooting with Premium Auto Pro, the message “Processing Premium Auto.” may appear on the monitor screen. If you feel the camera is taking too long to process data, try shooting with standard Auto instead.
- In some cases, Premium Auto Pro may not be able to interpret the shooting environment correctly. If this happens, shoot with standard Auto.
- If “[HS]” is displayed, the camera will shoot a series of CS images and merge them into a final image. Take care to avoid any camera and subject movement until shooting of all of the CS images is complete.

## Viewing Snapshots

Use the following procedure to view snapshots on the camera's monitor screen.

- For information about how to play back movies, see page 64.

### 1. Touch “⏮” (PLAY) to enter the PLAY mode.

This will display one of the snapshots currently stored in memory.

- If “Premium Auto Pro” is selected as the recording mode, touch the Review image (page 63) on the monitor screen.
- Information about the displayed snapshot also is included (page 10).
- You also can clear the information to view only the snapshot (page 100).
- You can zoom the screen image by touching the monitor screen (page 67).

If you are recording a snapshot that is very important to you, it is recommended that you zoom the image and check its details after recording it.



---

**2. Drag left or right across the screen image to scroll through the snapshots.**

**NOTE**

- Pressing the shutter button while in the PLAY mode or while a menu screen is displayed will switch directly to the REC mode.
- A question mark (?) will be displayed for images that cannot be displayed for some reason.

## Deleting Snapshots and Movies

If memory becomes full, you can delete snapshots and movies you no longer need in order to free up storage and record more images.



**IMPORTANT!**

- Remember that a file (image) delete operation cannot be undone.

**■ To delete a single file**

**1. In the PLAY mode, drag left or right to display the file you want to delete.**

---

**2. Touch “○○○○○” (Show Icons).**

---

**3. Touch “🗑️”.**

---

**4. Touch “Delete 1 File”.**

This will delete the selected image.

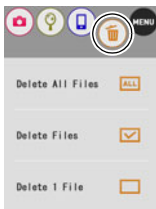

## ■ To delete specific files

**1. Enter the PLAY mode.**

---

**2. Touch “○○○○○” (Show Icons).**

---

**3. Touch “”.**

---

**4. Touch “Delete Files”.**

This displays a file selection screen.

---

**5. Touch a file you want to delete.**

This will select the check box of the selected file's image.

---

**6. After you are finished selecting files, touch “Delete”.**

---

**7. Touch “Delete”.**

This deletes the files you selected.

- To cancel the delete operation, touch “Cancel” in step 6.

### NOTE

---

- You can also delete images using the image menu (page 67).

## ■ To delete all files

**1. Enter the PLAY mode.**

---

**2. Touch “○○○○○” (Show Icons).**

---

**3. Touch “”.**

---

**4. Touch “Delete All Files”.**

---

**5. Touch “Delete”.**

This will cause the message “There are no files.” to appear.

## Snapshot Shooting Precautions

### Operation

- If unwanted light is shining onto the lens, shade the lens with your hand when shooting an image.

### Monitor Screen when Shooting Snapshots

- Subject brightness conditions can cause monitor screen response to slow and can cause digital noise in the monitor screen image.
- The image that appears on the monitor screen is for image composition. The actual image will be recorded in accordance with the currently selected recording mode (page 38).

### Shooting Indoors under Fluorescent Lighting

- Minute flickering of fluorescent lighting can affect the brightness or color of an image.

### Other Precautions

- A noise reduction process is performed when ISO sensitivity is set to a high value. This can cause the camera to take relatively longer to be ready to shoot again after you press the shutter button. Do not perform any operation while the image recording operation is in progress.
- Due to the characteristics of the imaging element used by the camera, very fast moving objects in an image may appear distorted.

### ■ Auto Focus Restrictions

- Any of the following can make proper focus impossible.
  - Solid color wall or other very low contrast subject
  - Strongly back lit subject
  - Very shiny subject
  - Blinds or other subject with a repeating horizontal pattern
  - Multiple subjects at varying distances from the camera
  - Subject in a dark location
  - Camera movement while shooting
  - Fast-moving subject
  - Subjects outside the focus range of the camera
- If you cannot focus properly, try using focus lock (page 63).

# Recording Images

Touching the monitor screen in the REC mode will display a screen for configuring REC mode settings.

## ■ To configure REC mode settings

### 1. Press [⏻] (Power) to turn on the camera and enter the REC mode.

- If the camera is in the PLAY mode, touch “📷” (REC) to enter the REC mode.

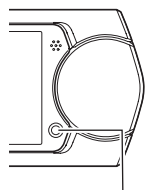

[⏻] (Power)

---

### 2. Touch “○○○○○” (Show Icons).

---

### 3. Touch the item whose setting you want to change.

- ① Menu (page 55)\*
- ② Recording mode (page 38)
- ③ Remote capture (page 83)
- ④ Mirror mode (page 44)
- ⑤ PLAY mode (page 29)/  
Make-up (page 43)
- ⑥ Movie (page 47)
- ⑦ Send Last Shot icon (page 85)



\* Depending on the recording mode, some of the items on the menu that appears may not be usable.

## Selecting a Recording Mode

The camera has a variety of different recording modes.

**1. In the REC mode, touch the “○○○○○” (Show Icons).**



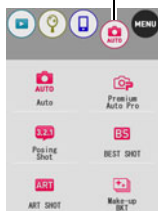



Recording mode icon



**2. Touch the recording mode icon.**

**3. Touch the icon of the recording mode you want to use.**

This enters the selected recording mode.

 <b>Auto</b>	Standard Auto recording mode. This is the mode normally used for shooting (page 30).
 <b>Premium Auto Pro</b>	With Premium Auto Pro recording, the camera automatically determines whether you are shooting a subject or scenery, and other conditions. Premium Auto Pro recording delivers higher image quality than standard Auto recording mode (page 30).
 <b>Posing Shot</b>	Posing Shot lets you shoot five successive snapshots, as the camera provides voice guidance (page 39).
 <b>BEST SHOT</b>	With BEST SHOT, simply select the sample scene that resembles the type of shot you want, and the camera automatically configures ideal settings for the subject and shooting conditions (page 50).
 <b>ART SHOT</b>	A variety of artistic effects help to make even common, ordinary subjects become more novel and exciting (page 40).
 <b>Make-up BKT</b>	Make-up BKT lets you shoot three versions of the same image with the press of the shutter button, each with a different Skin Tone setting (page 42).

## Shooting with Posing Shot (Posing Shot)

---

Posing Shot lets you shoot five successive snapshots, as the camera provides voice guidance. The result is a series of shots with different poses and expressions.

**1. In the REC mode, touch the “○○○○○” (Show Icons).**

---

**2. Touch the recording mode icon.**

---

**3. Touch “3.2.1” (Posing Shot).**

---

**4. Press the shutter button to start recording.**

Shoot in accordance with the voice guidance from the camera.

### NOTE

---

- To adjust the volume of the voice guidance, use the “Posing Vol” setting under “Sounds” (page 101).
- To interrupt an ongoing Posing Shot operation, press the shutter button or touch the monitor screen.
- Note that preview images are not displayed when shooting with this function.

### ■ Changing the Voice Guidance Type

You can use the procedure below to select one of five types for the voice guidance that sounds while you are shooting.

**1. Touch “3.2.1” (Voice).**

---

**2. Touch the number of the voice guidance you want to use.**

This will cause the corresponding voice to sound.

---

**3. After selecting the voice guidance type you want to use, touch “OK”.**

## Shooting with Artistic Effects (ART SHOT)

A variety of artistic effects help to make even common, ordinary subjects become more novel and exciting.

Scene	Description
<b>HDR Art</b>	Uses HDR (High Dynamic Range, page 53) to turn normal images into works of art.
<b>Crystal Ball</b>	Creates a mysterious effect by placing the image in a bubble floating in midair.
<b>Sparkling Shot</b>	Softens the overall image and adds points of light for a sparkle effect.
<b>Toy Camera</b>	Dark edges and altered hues make images look like they were shot by a toy camera.
<b>Soft Focus</b>	Overall blurring for a soft and romantic effect.
<b>Light Tone</b>	Weakened contrast for a feeling of airy refinement.
<b>Pop</b>	Enhanced saturation makes colors stand out in with rich clarity.
<b>Sepia</b>	Sepia tones create a decidedly retro look.
<b>Monochrome</b>	All of the strong contrast and graininess of a black and white print.
<b>Miniature</b>	Partial blurring makes scenes look like they are from of a miniature world.
<b>Fisheye</b>	A fisheye lens effect can be used to create a variety of humorous images.

1. In the REC mode, touch the “○○○○○” (Show Icons).
2. Touch the recording mode icon.
3. Touch “**ART**” (ART SHOT).
4. Touch the ART SHOT scene you want to use.
  - Touch “⬇️”, “⬆️” to display another scene.
  - Touching “**i**” on the monitor screen and then touching a ART SHOT scene will display detailed information about the scene.



---

## 5. Touch the “ART” icon.

The intensity of the selected effect can be adjusted as described below. Note, however, that the “Miniature” effect cannot be adjusted.

Scene	Adjustment
HDR Art	Effect level
Crystal Ball	Effect type
Sparkling Shot	Effect type
Toy Camera	Hue
Soft Focus	Effect level
Light Tone	Hue
Pop	Effect level
Sepia	Effect level
Monochrome	Effect level
Fisheye	Effect level

---

## 6. Touch the level you want to select.

---

## 7. Touch “OK”.

---



## 8. Press the shutter button to shoot.

### NOTE

- This function works best when the camera is made stationary by placing it on a level surface, etc.
- With the HDR Art scene, the settings below are configured automatically.
  - LED: Off
- Shooting with this REC mode makes the shooting range narrower than normal.
- The desired effect may not be attained if the camera or subject moves during shooting.
- Depending on shooting conditions and image composition, this REC mode may not be able to produce the desired result.
- Movie recording is disabled while shooting with ART SHOT.
- Sample images shown on ART SHOT scene screens were not shot with this camera.

## Shooting Three Versions of an Image with Different Skin Tone Settings (Make-up BKT)

Make-up Bracketing (Make-up BKT) lets you shoot three versions of the same image with the press of the shutter button, each with a different Skin Tone setting. This helps you get the skin tone effect you want, even if you do not know exactly what settings to use.

1. In the REC mode, touch “○○○○○” (Show Icons).
2. Touch the Recording mode icon.
3. Touch “” (Make-up BKT).
4. Touch “○○○○○” (Show Icons) and then touch “” (Make-up).
5. Touch the “Skin Tone”, “Smooth Skin” values and change the levels as desired.

Skin Tone	“Tan +6” to “0” to “Light +6”
Smooth Skin	“0 (Off)” to “+12 (Max.)”

6. Touch “OK”.
7. Press the shutter button to shoot.

This will shoot and store three versions of the same image with various “Skin Tone” settings, based on the setting you selected in step 5, above.

### NOTE

- After shooting an image with “Make-up BKT”, you will not be able to shoot another image until save of the previous image is complete.
- Only two versions of the image will be shot and stored if you shoot with Make-up BKT while “+6” is selected for “Skin Tone”.
- Movie recording is disabled while shooting with “Make-up BKT”.

## Recording Beautiful Portraits (Make-up)

Make-up enables adjustment of human skin tone hues and texture, and softening of facial shadows caused by harsh sunlight for better looking portraits.

- Make-up can be used with the recording modes listed below.
  - Premium Auto Pro
  - Posing Shot
  - Motion Shutter (BEST SHOT)
  - Make-up BKT
  - Following BEST SHOT scene
    - Motion Shutter, Triple Shot, HS Night Scene Portrait

**1. Select “Premium Auto Pro”, “Posing Shot” or “Motion Shutter” for the recording mode (pages 38, 50).**

**2. Touch “○○○○○” (Show Icons).**

**3. Touch “” (Make-up).**

**4. Touch the screen and adjust “Skin Tone” and “Smooth Skin”.**

<b>Skin Tone</b>	“Tan +6” to “0” to “Light +6”
<b>Smooth Skin</b>	“0 (Off)” to “+12 (Max.)”

**5. Touch “OK”.**

**6. Press the shutter button to shoot.**



## Using the Camera as a Mirror

You can use the procedure below to configure the camera so its monitor screen acts as a mirror.

- Images cannot be recorded while in the Mirror Mode. Mirror Mode image data is not saved in camera memory.
- The Mirror Mode can be entered only while the camera is positioned in portrait (vertical) orientation. It cannot be entered while the camera is in landscape (horizontal) orientation.



1. Rotate the monitor screen panel so the screen is facing in the same direction as the lens (page 13).
2. On your camera, enter the REC mode and then touch “○○○○○” (Show Icons).
3. Touch the “🔄” icon.  
This enters the Mirror Mode.

### ■ Mirror Mode Functions

Brightness adjustment	Touch the “+” side or “-” side of “🔍”.
Horizontal screen image flip	Touch “🔄”. <ul style="list-style-type: none"><li>• Image flips to show how your face appears to others.</li></ul>
Screen image freeze	Touch “PAUSE”. <ul style="list-style-type: none"><li>• Freezes the image to make it easier to view in detail.</li></ul>
Zoom	Spread two fingers apart or squeeze them together on the screen to zoom the image. <ul style="list-style-type: none"><li>• Lets you move in on an image for greater detail.</li></ul>
Exit the Mirror Mode	Touch “⏪”.

- Brightness adjustment and horizontal screen image flip cannot be used while the screen image is frozen.

## Shooting with Zoom

Your camera is equipped with various types of zoom: HD Zoom, SR Zoom, and digital zoom. The maximum zoom factor depends on the image size setting.

<b>HD Zoom</b>	Allows greater zoom capabilities by cutting out a portion of the original image and enlarging it, without deterioration of image quality.
<b>SR Zoom</b>	Applies super resolution technology to suppress image deterioration.
<b>Digital zoom</b>	A digital process is used to enlarge the center of the image, so there is deterioration of image quality.

### 1. Perform the required screen operation to change the zoom factor as desired.

Zoom in: Spread

Zoom out: Squeeze



Telephoto





Wide Angle

Telephoto : Enlarges the subject and narrows the range.

Wide Angle : Reduces the size of the subject and broadens the range.

### 2. Press the shutter button to shoot the image.

#### NOTE

- Telephoto images are prone to blurring caused by camera movement when you press the shutter button. Because of this, stabilizing the camera by placing it on a level surface, etc. is recommended.
- Zoom operations are disabled during high speed movie recording. Perform the zoom operation before you touch “” (Movie) to start recording.
- “” is displayed on the monitor screen while digital zoom is being used.

## ■ Zoom Factor

- The image deterioration point depends on the image size (page 58). The smaller the image size, the higher the zoom factor you can use before reaching the image deterioration point.

Image Size	Undeteriorated Zoom Limit	Maximum Zoom Factor
12M	1.5X	4.0X
3M	2.9X	7.8X

## Shooting a Self-portrait

You can configure the camera so the monitor screen and lens are facing in the same direction. This means you can shoot with the self-timer as you compose the self-portrait on the monitor screen.

- When using the self-timer to shoot a self-portrait, select one of the following recording modes.
  - Auto
  - Premium Auto Pro
  - Make-up BKT

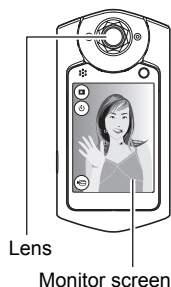

**1. Rotate the monitor screen panel so the screen is facing in the same direction as the lens (page 13).**

**2. Select “Auto” or “Premium Auto Pro” for the recording mode (page 30).**

**3. Drag “⌚” (Self-timer) downwards to specify the self-timer countdown duration.**

The camera will shoot an image when the countdown reaches zero.

- You can set a self-timer countdown duration within the range of two to ten seconds. The further you drag, the longer the duration.
- To cancel an ongoing countdown, touch anywhere on the screen except where the self-timer icon is displayed.
- To cancel an ongoing countdown, touch anywhere on the screen except where the self-timer icon is displayed or press the shutter button.



## To record a movie

The following procedure explains how to record a movie.



- You can record a movie while one of the following recording modes is selected.
  - Auto
  - Premium Auto Pro
  - Following BEST SHOT scene
    - HS Night Scene, HS Night Scene Portrait, Food, Nails

**1. In the REC mode, touch “○○○○” (Show Icons).**

**2. Touch “MENU”.**

**3. Drag upwards and downwards until you find “Movie Quality”, and then touch to select it.**

**4. Touch the item whose setting you want to change.**



Movie Quality	REC Screen Icon Display	Frame Rate	Image Size (Pixels)	Description
Full HD		30fps	1920×1080	Select this setting to record full high-definition (Full HD) movies. The aspect ratio of movies recorded with this setting is 16:9.
HD		30fps	1280×720	Select this setting to record high-definition (HD) movies. The aspect ratio of movies recorded with this setting is 16:9.
HS240		240fps	512×384	Select this setting to record high speed movies at a speed of 240 fps. <ul style="list-style-type: none"><li>• Audio is not recorded.</li></ul>

**5. To close the menu screen, touch “MENU” or press the shutter button.**

---



## 6. Touch “” (Movie).

This will start recording.

- Monaural audio is also recorded during movie recording while “Full HD” or “HD” is selected for the movie quality setting.
- Touching “” while recording is in progress will cause the remaining recording time and “R” to appear. Touch “” again to switch back to the elapsed recording time.
- Zoom is supported during movie recording when “Full HD” or “HD” is selected for the movie quality setting (page 45).
- When “Macro” is selected as the movie focus mode (page 62), you can half-press the shutter button before starting recording to focus.

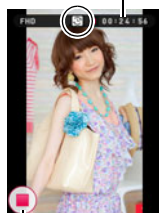
Recording time/  
Remaining recording time



“” (Movie)/  
“” (Movie Stop)

---

## 7. Touch “” (Movie Stop) to stop recording.

- Each movie can be up to 29 minutes long. Movie recording stops automatically after 29 minutes of recording. Movie recording also will stop automatically if memory becomes full before you stop movie recording.

### Minimizing the Effects of Camera Movement during Movie Recording

You can configure the camera to minimize the effects of camera movement during Full HD and HD movie recording. Note, however, that this does not prevent image blur due to subject movement.

### High Speed Movie Recording Precautions

- When shooting a high speed movie, shoot in a well-lit environment.
- When recording a high speed movie, light source flicker can cause horizontal bands to appear in the image. This does not indicate malfunction of the camera.



## **IMPORTANT!**

- Spending a long time using movie recording will cause the camera to become slightly warm to the touch. This is normal and does not indicate malfunction. The camera may automatically adjust its monitor screen brightness in order to reduce heat generation.
- The camera also records audio along with Full HD and HD movies. Note the following points when shooting a movie.
  - Take care that the microphone is not blocked by your fingers, etc.
  - Good audio recording results are not possible when the camera is too far away from what you are trying to record.
- Shooting movies for long periods in areas where temperature is relatively high can cause digital noise (dots of light) to appear in the movie image. A rise in the camera's internal temperature also may force movie recording to stop automatically. If this happens, stop recording and allow the camera to cool down, which should cause normal operation to resume.
- Using the camera's built-in memory or certain types of memory cards can slow down processing speed. Whenever possible use an Ultra High-Speed Type memory card. Note, however, that not all operations can be guaranteed even if an Ultra High-Speed Type memory card is used. Certain movie quality settings can result in too much time being required to record data, which can result in breaks in the image and/or audio during playback. If this happens, the movie icon will turn yellow on the monitor screen.

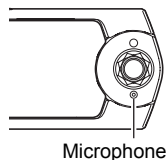

## **NOTE**

- Except for High Speed Movie, zoom operations are supported during movie recording (page 45). Zoom is disabled during high speed movie recording. If you want to use zoom, perform the zoom operation before you touch "Ⓜ" (Movie) to start recording.
- SR Zoom (page 45) is disabled during movie recording.
- The effects of camera movement in an image become more pronounced when you shoot close up or with a large zoom factor. Because of this, stabilizing the camera by placing it on a level surface, etc. is recommended.
- During High Speed Movie recording, focus is fixed at the position where it was when recording started. To focus an image, half-press the shutter button for Auto Focus before you touch "Ⓜ" (Movie) to start recording.

# Using BEST SHOT

BEST SHOT provides you with a collection of sample “scenes” that show a variety of different types of shooting conditions. When you need to change the setup of the camera, simply find the scene that matches what you are trying to achieve, and the camera sets up for it automatically. This helps to minimize the chance of ruined images due to poor exposure and shutter speed settings.

## ■ To shoot an image with BEST SHOT

**1. In the REC mode, touch “○○○○○” (Show Icons) (page 38).**

---

**2. Touch the recording mode icon.**

---

**3. Touch “BS” (BEST SHOT).**

This will display a menu of BEST SHOT scenes.

---

**4. Touch the scene you want to select.**

- Touching “i” on the monitor screen and then touching a BEST SHOT scene will display detailed information about the scene.
- 

**5. Press the shutter button (if you are shooting a snapshot) or touch “Ⓜ” (Movie) (if you are shooting a movie).**

- With some BEST SHOT scenes, the message “Busy... Please wait...” will appear on the monitor screen after you press the shutter button. The camera is in the process of recording an image until the message appears. Keep the camera still. The image processing operation takes some time to complete after the message appears. You will not be able to record another image while the message is displayed.

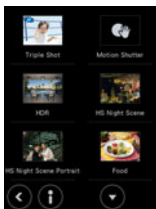

## ■ BEST SHOT Precautions

- BEST SHOT scene images were not shot using this camera.
  - Images shot using a BEST SHOT scene may not produce the results you expected due to shooting conditions and other factors.
  - You can modify the camera settings that are configured after you select a BEST SHOT scene. Note, however, that the BEST SHOT settings revert to their defaults when you select another BEST SHOT scene or turn off the camera.
  - Movie recording can be performed while one of the BEST SHOT scenes below is selected. Note that if “HS240” is selected for the movie quality setting, movies will be recorded using the auto recording “Auto” setting.
- HS Night Scene, HS Night Scene Portrait, Food, Nails

## Shooting with Triple Shot

Triple Shot shoots a burst of three images and stores them in memory. This feature is great for making sure you don't miss those special moments when kids are around.

### 1. Select "Triple Shot" scene (page 50).

---

### 2. Point the camera at the subject and then half-press the shutter button.

The camera will start pre-recording images at this time.

- If you release the half-pressed shutter button before pressing it the rest of the way down, all of the images currently in the pre-record buffer will be deleted.
- 

### 3. Press the shutter button all the way down to record.

This will record three images: one of the action before the shutter button is fully pressed plus two real-time images.

- Pressing the shutter button all the way without first half-pressing it will result in only two images being recorded.

#### NOTE

---



- The following functions cannot be used with this function.  
Touch Shutter, Self-timer, Self-portrait check
- "Type 1" cannot be selected for the "Review" setting while shooting with this function. If "Type 1" is selected in another mode, selecting the "Triple Shot" scene will cause the "Review" setting to change to "Type 2".

## Using Motion Shutter to Trigger a Self-timer Operation (Motion Shutter)

With Motion Shutter the camera automatically triggers a self-timer countdown whenever it detects subject movement within an icon you specify on the monitor screen. This means you can control operation of the self-timer from a distance by waving your hand, so you can include yourself in the image being shot.



**1. Select “” (Motion Shutter) scene (page 50).**

**2. Drag the start self-timer icon “” and preview icon “” to the location in the image where you want movement to be detected.**

- Keep the two icons separate from each other. Whenever you move an icon to a location where it overlaps the other icon, the other icon will move out of the way automatically.

**3. When everything is ready, press the shutter button all the way down.**

The start self-timer icon will change to “” to indicate that the camera is in standby for shooting.

**4. Facing the camera, move your hand or perform some other movement in the area of the start self-timer icon you positioned in step 3.**

When the camera detects subject movement within the icon, it will automatically start a self-timer countdown. The camera will shoot an image when the countdown reaches zero, and then go back into Motion Shutter standby to wait for the next trigger movement.

### NOTE

- The trigger time of the Motion Shutter self-timer is fixed at two seconds.
- The preview icon “” will appear on the monitor screen when a snapshot is shot. When the camera detects movement within the preview icon, it will display the image that was shot for three seconds.
- Motion Shutter exits standby automatically after it shoots six images.
- To cancel Motion Shutter standby at any time, press the shutter button or touch the monitor screen.
- The Motion Shutter may not operate properly when there is little difference between the subject and the background of the icon, or when the subject is located far away from the camera.

## Digitally Correcting for Overexposure and Underexposure (HDR)

With HDR (High Dynamic Range), the camera shoots a series of CS images using different exposure settings and combines them into a final image to correct for overexposure or underexposure of subjects of different brightness levels.

**1. Select “HDR” scene (page 50).**

---

**2. Press the shutter button to shoot.**

### NOTE

---

- This function works best when the camera is made stationary by placing it on a level surface, etc.
- With this BEST SHOT scene, the LED light setting automatically becomes off.
- The desired HDR effect may not be attained if the camera or subject moves during shooting.

## Shooting with High Speed Night Scene (HS Night Scene)

With High Speed Night Scene, the camera automatically detects shooting conditions. When you press the shutter button, the camera will record a burst of images and merge them in a way that minimizes image blur due to low light conditions.

**1. Select “HS Night Scene” scene (page 50).**

---

**2. When you are ready to shoot, press the shutter button.**

### NOTE

---

- With this BEST SHOT scene, the LED light setting automatically becomes off.
- When holding the camera by hand while shooting with this BEST SHOT scene, make sure that the subjects remain as still as possible as the camera shoots the series of images.
- Movement of the camera while it is placed on a surface may cause erroneous judgment that it is hand held.
- If surroundings are extremely dark when shooting with “HS Night Scene”, the camera may not be able to shoot at proper brightness due to insufficient exposure.
- When shooting with this BEST SHOT scene, the ISO sensitivity setting is fixed at “Auto”.

## Shooting with High Speed Night Scene and Portraits (HS Night Scene Portrait)

**1. Select “HS Night Scene Portrait” scene (page 50).**

---

**2. When you are ready to shoot, press the shutter button.**

### NOTE

---

- With this BEST SHOT scene, the LED light setting automatically becomes “Auto”.
- When holding the camera by hand while shooting with this BEST SHOT scene, make sure that the subjects remain as still as possible as the camera shoots the series of images.
- Movement of the camera while it is placed on a surface may cause erroneous judgment that it is hand held.
- If surroundings are extremely dark when shooting with this BEST SHOT scene, the camera may not be able to shoot at proper brightness due to insufficient exposure.
- When shooting with this BEST SHOT scene, the ISO sensitivity setting is fixed at “Auto”.

# Advanced Recording Settings

The following are menu operations you can use to configure various camera settings.

## Using the REC Menu

### ■ Example Menu Screen Operation

1. In the REC mode, touch “○○○○○” (Show Icons).

2. Touch “MENU”.

This will display the menu screen.

- Menu contents are different in the REC mode and PLAY mode.

3. Drag upwards and downwards until you find the item whose setting you want to change.

4. Touch the item.

5. Configure the setting of the item in accordance with the screen contents.

- To cancel and exit the menu, touch “MENU” or press the shutter button.

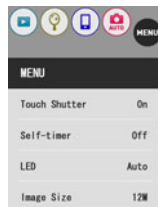

### NOTE

- Depending on the recording mode, some of the items on the menu that appears may not be usable. While Premium Auto Pro is in use, only the menu items whose settings can be configured will be displayed on the menus.

### ■ Menu Operations in This Manual

Menu operations are represented in this manual as shown below. Touch the indicated icons and items, and perform operations as they are indicated, from left to right.

#### Procedure

Enter the “REC Mode” → MENU → Touch Shutter

## Using Touch Shutter (Touch Shutter)

### Procedure

Enter the “REC Mode” → MENU → Touch Shutter

You can use the procedure below to shoot a snapshot.

**1. Touch “On”.**

**2. Point the camera at the subject.**

**3. When you want to shoot, touch the monitor screen.**

The camera automatically comes into focus and then shoots.

- You can still use the shutter button to shoot even when “On” is selected for Touch Shutter.

### NOTE



- When “Auto” is selected as the recording mode, the camera will automatically focus on the point you touch.
- When “Premium Auto Pro” is selected as the recording mode, the camera will automatically determine the optimum focus point(s) and focus automatically.

## Using the Self-timer (Self-timer)

### Procedure

Enter the “REC Mode” → MENU → Self-timer

With the Self-timer, pressing the shutter button starts a timer. The shutter is released and the image is shot after a fixed amount of time.

Setting	REC Screen Icon Display	Description
10 sec		10-second Self-timer
2 sec		2-second Self-timer <ul style="list-style-type: none"><li>• When shooting under conditions that slow down the shutter speed, you can use this setting to prevent image blur due to camera movement.</li></ul>
Off	None	Self-timer is disabled.

- You can interrupt an ongoing Self-timer countdown by pressing the shutter button.



## NOTE



- The Self-timer configured with the above menu cannot be used under the following conditions.
  - Posing Shot (page 39)
  - Triple Shot (page 51)
  - Motion Shutter (page 52)
  - When the monitor screen and lens are facing in the same direction

## Using the LED Light (LED)

### Procedure

Enter the “REC Mode” → MENU → LED

Use the LED light when shooting where lighting is dim. The effectiveness of the LED light is reduced the further you are from the subject.

Setting	REC Screen Icon Display	Description
Auto		The LED light fires automatically under dark shooting conditions when the shutter button is half-pressed to focus and/or full-pressed to shoot.
On		LED always lights when shooting.
Off	None	LED never turns on or fires.



### IMPORTANT!



- Do not turn on the LED light near a person's eyes and do not allow anyone to look directly into the light.
- You should compose the image so the main subject is in the center of the image when using the LED light.
- Since the camera is equipped with a wide-angle lens, the center tends to be brighter while the periphery tends to be darker.
- LED light is disabled while shooting with the following feature.
  - Following BEST SHOT scenes  
Triple Shot, HDR, HS Night Scene
  - Following ART SHOT scene  
HDR Art

## Changing the Image Size (Image Size)

### Procedure

Enter the “REC Mode” → MENU → Image Size

This setting can be used to configure snapshot image size.

Image Size (Pixels)	REC Screen Icon Display	Suggested Print Size and Application	Description
12M (4000×3000)		Poster Print	Good detail for better clarity even for images cropped from the original on a computer, etc.
3M (2048×1536)		3.5"×5" Print	Best when preserving memory capacity is relatively more important than image quality.

- The initial factory default image size setting is 12M (12 million pixels).
- Selecting “3:2” records images with an aspect ratio of 3:2, which matches the standard aspect ratio of print paper.

### ■ Pixels and image size

A digital camera image is a collection of small dots called “pixels”. The more pixels there are in an image, the more detail there will be. However, you generally can do with fewer pixels when printing an image (L size) through a print service, attaching an image to e-mail, when viewing the image on a computer, etc.

The size of an image indicates how many pixels it contains, and is expressed as horizontal pixels×vertical pixels.

- Note that larger images have more pixels, so they take up more memory space.
- For information about image size and number of images that can be stored, see page 130.
- For information about movie image size, see page 131.
- For information about resizing existing snapshots, see page 77.

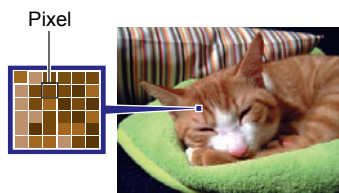

## Movie Image Quality Settings (Movie Quality)

### Procedure

Enter the “REC Mode” → MENU → Movie Quality

This setting can be used to configure movie image quality settings and to select either normal movie recording or High Speed Movie recording. For information about movie image quality settings, see page 47.

## Correcting Image Brightness (Brightness)

### Procedure

Enter the “REC Mode” → MENU → Brightness

You can manually adjust an image’s exposure value (EV value) before shooting it.

- Exposure Compensation Range: -2.0 EV to +2.0 EV
- Unit: 1/3 EV

### 1. Touch a level you want to set.

- To cancel exposure compensation, change the EV value to 0.0.

Decreases the EV value. A lower EV value is best for dark-color subjects and for shooting outdoors on a clear day.



Increases the EV value. A higher EV value is best for light-colored subjects and backlit subjects.

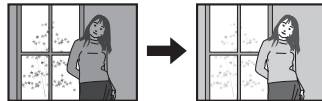

### 2. Touch “OK”.

This applies the exposure compensation value. The exposure compensation value you set remains in effect until you change it or turn off the camera (which causes it to revert to “0.0”).

### NOTE

- When shooting under very dark or very bright conditions, you may not be able to obtain satisfactory results even after performing exposure compensation.

## Adjusting White Balance (White Balance)









### Procedure

Enter the “REC Mode” → MENU → White Balance

You can adjust white balance to match the source of light available where you are shooting and avoid the blue cast that results when shooting outdoors when it is cloudy, and the green cast that results when shooting under fluorescent lighting.

### 1. Touch the type of white balance you want to select.

You can see the affect of the white balance setting you select on the monitor screen.

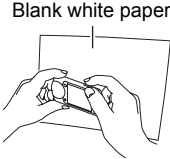
Setting	Description
 <b>Auto WB</b>	Configures the camera to adjust white balance automatically
 <b>Daylight</b>	For shooting outdoors on a clear day
 <b>Overcast</b>	For shooting outdoors on an overcast rainy day, in the shade, etc.
 <b>Shade</b>	For shooting on a clear day in the shade of trees or buildings
 <b>Day White Fl.</b>	For shooting under white or day white fluorescent lighting
 <b>Daylight Fluor</b>	For shooting under daylight fluorescent lighting
 <b>Tungsten</b>	For shooting under light bulb lighting
 <b>Manual WB</b>	<p>For configuring the camera manually to suit a particular light source.</p> <ol style="list-style-type: none"><li>① Touch “ Manual WB”.</li><li>② In the location where you plan to shoot, point the camera at a blank white piece of paper so it fills the entire monitor screen.</li><li>③ Touch an area of the screen where no icon is located.</li></ol> <p>The white balance setting is retained even if you turn off the camera.</p> 

- When “ Auto WB” is selected for the white balance setting, the camera automatically determines the white point of the subject. Certain subject colors and light source conditions can cause problems when the camera tries to determine the white point, which makes proper white balance adjustment impossible. If this happens, select the white balance setting that matches your shooting conditions (Daylight, Overcast, etc.).

### 2. Touch “OK”.

## Specifying ISO Sensitivity (ISO)

### Procedure

Enter the “REC Mode” → MENU → ISO

ISO sensitivity is a measure of sensitivity to light.

Setting	Description		
<b>Auto</b>	Adjusts sensitivity automatically according to conditions		
<b>ISO 80</b>	Lower sensitivity  ↑  ↓  Higher sensitivity	Slow shutter speed	Less noise
<b>ISO 100</b>			
<b>ISO 200</b>			
<b>ISO 400</b>			
<b>ISO 800</b>			
<b>ISO 1600</b>			
<b>ISO 3200</b>			
		Fast shutter speed (Set for shooting in dimly lit areas.)	Some coarseness (increased digital noise)



- Since higher ISO sensitivity values tend to result in digital noise in images, the camera performs a noise filtering process. Because of this, it may take relatively longer for the camera to finish recording an image after it is shot. You will not be able to perform any operation while image recording is in progress.

## Selecting a Focus Mode (Focus)

### Procedure

Enter the “REC Mode” → MENU → Focus

Changing to a different focus mode can help to achieve better focus.

Settings	REC Screen Icon Display	Type of Shot	Focus Mode		Approximate Focus Range*1	
			Snapshot	Movies	Snapshot	Movies
AF (Auto Focus)	None	General recording	Automatic	Fixed focal point	8 cm to ∞ (infinity) (3.1" to ∞)	52 cm to ∞ (infinity) (20.5" to ∞)
Macro		Close ups			8 cm to 50 cm (3.1" to 19.7")	8 cm to 50 cm (3.1" to 19.7")*2
PF (Pan Focus)		Shooting with a relatively wide focus range	Fixed focal point		1 m to ∞ (infinity) (3.3' to ∞)	52 cm to ∞ (infinity) (20.5" to ∞)
Infinity		Scenery and other distant subjects	Fixed		Infinity (Wide Angle)	

\*1 The focus range is the distance from the lens surface.

\*2 Focus remains fixed at the position where it was when recording started. To focus an image, half-press the shutter button to focus before fully pressing the shutter button to start recording.

## Using Focus Lock

“Focus lock” is a technique you can use when you want to compose an image in which the subject you want to focus on is not within the focus frame in the center of the screen.

**1. Align the monitor screen’s focus frame with the subject you want to focus on and then half-press the shutter button.**

Subject to be focused on

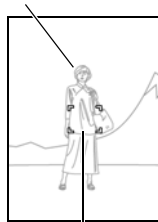

Focus frame

**2. Keeping the shutter button half-pressed (which maintains the focus setting), move the camera to compose the image.**

**3. When you are ready to shoot the image, press the shutter button the rest of the way down.**



### NOTE

- Focus lock also locks exposure (AE).
- The focus frame does not appear on the display when the Touch Shutter is enabled (On).

## Turning on Image Review (Review)

### Procedure

Enter the “REC Mode” → MENU → Review

While Review is turned on, the camera will display an image immediately after it is recorded.

<b>Type 1</b>	Displays a full-screen view of the image for about one second.
<b>Type 2</b>	Displays a Review image in the upper left corner (in the case of a portrait orientation image) or the lower left corner (in the case of a landscape orientation image) of the monitor screen. Touching the Review image will enter the PLAY mode and display a full-screen view of the image.
<b>Off</b>	Turns off review image display

- When “Type 1” is selected, the aperture, shutter speed, and ISO sensitivity, will be red if the Auto Exposure is not correct.

# Viewing Snapshots and Movies

## Viewing Snapshots

See page 33 for the procedure for viewing snapshots.

## Viewing a Movie

1. Touch “▶” (PLAY) to enter the PLAY mode.
2. Drag left or right across the screen image to scroll through the movies until the one you want is displayed.

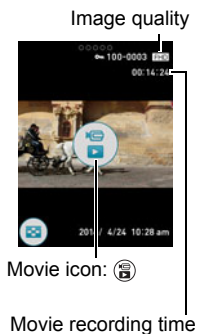

3. Touch “⏸” (Movie) to start playback.

Playback in progress

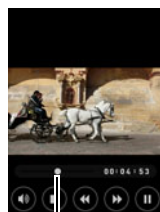

Touch “⏸”.

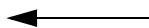
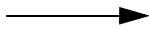

Touch “▶”.

Playback paused



Progress bar



## Movie Playback Controls



<b>Pause/Play</b>	Touch “  ” (pause) or “▶” (play).
<b>Fast forward/ Fast reverse</b>	During playback, touch “◀◀” (fast reverse) or “▶▶” (fast forward). <ul style="list-style-type: none"><li>• Each touch of either button increases the speed of the fast forward or fast reverse operation.</li><li>• To return to normal playback speed, touch “▶”.</li></ul>
<b>Stop playback</b>	During playback, touch “■”.
<b>Volume adjustment</b>	During playback, touch “🔊” and then drag the volume bar to the desired level. <ul style="list-style-type: none"><li>• Volume can be adjusted only while movie playback is in progress.</li></ul>
<b>1 frame forward/ back</b>	While playback is paused, touch “▶ ” or “◀ ”. <ul style="list-style-type: none"><li>• Touching and holding this icon advances frames continuously.</li></ul>
<b>Information display on/off</b>	Touch the screen.
<b>Movie editing</b>	Pause movie play at the location where you want to cut, and then touch “✂” (page 66).

- Playback may not be possible for movies not recorded with this camera.

## Editing a Movie on the Camera (Movie Editing)

The Movie Editing feature lets you cut out a specific part of a movie.

1. Enter the **PLAY** mode and then start playback of the movie you want to edit.
2. When playback reaches the location where you want to cut, touch “||” to pause.
3. Touch “✂”.
4. Touch the option that specifies what you want to cut.

 <b>Previous Cut</b>	Cuts everything from the beginning of the movie up to the current location.
 <b>Next Cut</b>	Cuts everything from the current location to the end of the movie.

### 5. Touch “Cut”.

The selected cut operation will take considerable time to complete. Don't try to perform any camera operation until the “Busy... Please wait...” message disappears from the monitor screen. Note that a cut operation can take a long time if the movie being edited is long.

### **IMPORTANT!**

- When you edit a movie, only the result is saved. The original movie is not retained. An editing operation cannot be undone.

### **NOTE**

- A movie that is shorter than five seconds cannot be edited.
- Editing of movies recorded with a different type of camera is not supported.
- You will not be able to edit a movie if the amount of remaining memory capacity is less than the size of the movie file you want to edit. If there is not enough memory available, delete files you no longer need to free up more.
- Splitting of a movie into two movies and splicing of two different movies into a single movie are not supported.

## Viewing the Image Menu

The image menu shows multiple images on a single screen.

### 1. In the PLAY mode, touch “” or squeeze your fingers on the screen.

This displays the image menu.

- Drag upwards or downwards to scroll to the next page of images.
- To view the normal (single image) display mode, touch the image you want to view.
- In the case of a movie, the first image in the movie is displayed.
- A question mark (?) will be displayed for images that cannot be displayed for some reason.
- You can also perform the operations below using the image menu. Touch the icon of the function you want to use, touch an image, and then touch “OK”.
  - Send an image to a smartphone
  - Delete an image
  - Protect an image



## Zooming an On-screen Image

Snapshots can be zoomed on the monitor screen up to 8X.

- The actual available zoom factors depend on the size of the original image.

### 1. In the PLAY mode, drag left or right to display the image you want to view.

### 2. Spread your thumb and forefinger (page 17) on the displayed image to enlarge it.

- Dragging an enlarged screen image will change the part of the image that is displayed.
- Squeezing your thumb and forefinger (page 17) on the displayed image will reduce it in size.
  - When monitor screen contents are turned on, a graphic on the monitor screen shows what part of the zoomed image is currently displayed.

## Viewing Snapshots and Movies on a TV Screen

Use a commercially available HDMI cable to connect the camera to the TV.

- Use a commercially available HDMI cable that is marked with the logo shown to the right.



### 1. Open the frame (page 13).

- ### 2. Hook your nail into the groove of the [HDMI] cover and pull the cover in the direction indicated by the arrow to open it.

[HDMI] cover

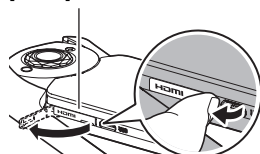

- ### 3. Turn off the camera and use a commercially available HDMI cable to connect the camera to a TV.

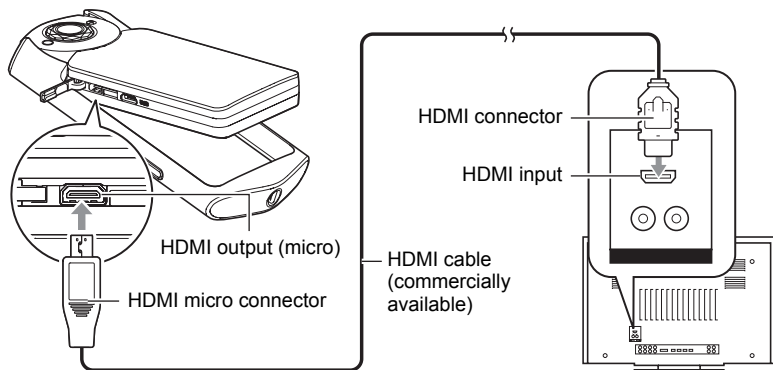

- Make sure that the camera is turned off before plugging in or unplugging the cable. Check the user documentation that comes with the TV for information about requirements before plugging into or unplugging from the TV.

### 4. Turn on the TV and select its HDMI input mode.

If the TV has more than one HDMI input, select the one where the camera is connected.

---

## 5. Turn on the camera.

The camera monitor screen will show a remote controller image. The TV screen will show a recorded image.

- The contents of the remote controller image will depend on the type of image that is displayed on the TV screen.

---

## 6. Touch the camera monitor screen to perform operations.

### NOTE

- Use a HDMI cable with a plug that is compatible with the camera's HDMI micro connector on one end, and a plug that is compatible with your TV's HDMI connector on the other end.
- Proper image and/or audio output and other operations may not be possible with some devices.
- Connecting the camera to the HDMI connector of another device can damage both the camera and the other device. Never connect two HDMI output connectors to each other.
- Disconnect the HDMI cable when you are not using HDMI output. The camera's monitor screen may not operate normally while the HDMI cable is connected.
- Audio is monaural.
- Audio is initially output by the camera at maximum volume. When you first start displaying images, set the TV volume control at a relatively low level and then adjust it as required.
- To select the digital signal format, see page 105.

# Other Playback Functions (PLAY)

The following are menu operations you can use to configure various camera settings.

## Using the PLAY Menu

### ■ Example Menu Screen Operation

1. In the PLAY mode, touch “○○○○○” (Show Icons).

2. Touch “MENU”.

This will display the menu screen.

- Menu contents are different in the REC mode and PLAY mode.

3. Touch the item whose setting you want to change.

4. Configure the setting of the item in accordance with the screen contents.

- To cancel and exit the menu, touch “MENU” or press the shutter button.

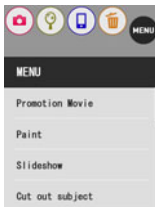

### ■ Menu Operations in This Manual

Menu operations are represented in this manual as shown below. Touch the indicated icons and items, and perform operations as they are indicated, from left to right.

#### Procedure

Enter the PLAY Mode → MENU → Protect

## Creating a Promotion Movie (Promotion Movie)

#### Procedure

Enter the PLAY Mode → Display snapshot → MENU → Promotion Movie

With this function, you can select five snapshots and combine them into a 6-second or 15-second movie that includes effects and music.

1. Drag upwards or downwards to display the snapshot you want to use in your Promotion Movie.

2. Touch the snapshot you want to use as the first image.

---

### 3. Repeat steps 1 and 2 to select a total of five snapshots.

- The snapshots will appear in the Promotion Movie in the same sequence that you select them.
- Touch a selected snapshot will de-select it.

---

### 4. Touch “OK”.

---

### 5. Touch “Length”, “Transition”, and “Music”, and configure settings for each item as required.

<b>Length</b>	Select 15 seconds or 6 seconds.
<b>Transition</b>	Enable or disable the transition effect. Selecting “On” (enabled) applies a transition effect when changing from one image to the next.
<b>Music</b>	Select the background music you want to use. Selecting “Off” creates a movie without music.

---

### 6. Touch “Create”.

This creates a Promotion Movie in accordance with the settings you configured.

#### NOTE



- Movies cannot be converted to a promotion movie.
- You may experience conversion problems if you try to include snapshots recorded with a camera other than this one.
- Promotion movies are HD movie quality, with an aspect ratio of 16:9. This means that the upper and lower parts of a snapshot will be trimmed off when it is converted to a promotion movie.
- Selecting a portrait orientation snapshot with the “Transition” setting enabled (On) will trim the top and bottom of the image, with the bottom portion somewhat larger than the top. When “Transition” is disabled (Off), black bands will appear on the sides of the image.
- This function cannot be used for fewer than five images.

## Performing Paint Operations on an Image (Paint)

### Procedure





#### Enter the PLAY Mode → Display snapshot → MENU → Paint

You can use this function to draw on, write on, or stamp information into a recorded snapshot. If the original image size is 3M or larger, the post-paint image is saved as a 3M size image.



1. On the monitor screen, touch “” or “”.
2. Touch the pen type or the stamp you want to use.
3. Use the pen to write text or draw figures, or use the stamp to stamp information.
  - The stamp will be located at the final position your finger is in when you remove it from the screen. Before removing your finger, you can drag the stamp to the location you want.
4. Touch “OK”.
5. Touch “Yes”.

This will save the image as a new image.

### Paint Functions

	Exits paint without saving an image.
	For selecting the pen color and thickness for drawing or writing. Also can be used to select the eraser and its thickness.
	For selecting the stamp type.
	Goes back to the previous screen.
	Saves the image.

### NOTE

- After selecting “”, you can change either the color (or eraser) or thickness setting only. To change the other setting, select “” again.



## Playing a Slideshow on the Camera (Slideshow)

### Procedure

Enter the **PLAY Mode** → **MENU** → **Slideshow**

You can use the slideshow mode to automatically scroll through all of the images in camera memory.

### NOTE

- All operations are disabled while the slideshow is transitioning from one image to another.
- The time required for transition from one image to another may be longer in the case of an image that was not recorded with this camera.
- To return to normal (single image) display, touch the screen.

## Extracting an Image from a Snapshot (Cut out subject)

### Procedure

Enter the **PLAY Mode** → **Display snapshot** → **MENU** → **Cut out subject**

You can draw an outline around a subject (person or object) and extract it from the snapshot. You can then insert the extracted subject into another snapshot.

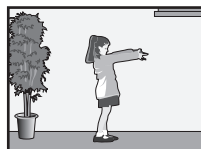

Extracted Subject

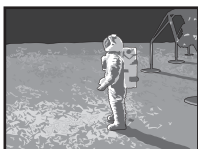

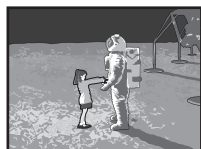

Another Snapshot



Final Combined Image

1. Touch the drawing tool you want and then draw a boundary around the subject that you want to extract.

Drawing Tool	Line Type	Description
	Thin	Draws a line for cutting out a subject.
	Thick	
	—	Erases a drawn line.

- The boundary line should be continuous, which means it starts and ends at the same point.

---

## 2. Touch “OK”.

This will cause the background of the subject you outlined to become gray.

---

## 3. Touch “ This will display the cut out subject.

- To scroll back one screen, touch the “

Extracted subject screen

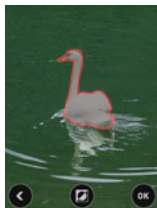

Original image with subject extracted

---

## 4. After confirming that the part of the image to be extracted is the way you want, touch “OK”.

This saves the extracted image.

### NOTE

- You cannot extract from an extracted subject. Attempting to do so will cause an error.

## Inserting a Subject into another Snapshot or Adding a Built-in Frame to a Snapshot (Paste subject)

### Procedure

#### Enter the PLAY Mode → MENU → Paste subject

You can add the camera's built-in characters or frames to snapshots, or you can insert characters you create with "Cut out subject" (page 73) into snapshots.

- Only an image that satisfies the following conditions can be used as a background image.
  - It must be a snapshot recorded with this camera or a snapshot transferred to this camera's memory.
  - It must be an image with an aspect ratio of 4:3.

1. Drag left or right to scroll through images. Select image you want to use as the background and then touch "OK".
2. Drag left or right to scroll though subjects. Select the subject you want to insert and then touch "OK".
3. Touch "-" (zoom out), "+" (zoom in) to adjust the size of the subject. You also can drag the subject around the screen to reposition it.
4. After the subject's size and position are the way you want, touch "OK".  
This inserts the subject into the background image.

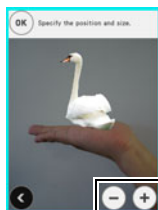

### NOTE

- Performing a delete or format operation will not delete the built-in subjects.

## Protecting a File Against Deletion (Protect)

### Procedure

Enter the **PLAY Mode** → **MENU** → **Protect**

You can protect images to prevent them from being deleted.

- A protected image will be indicated by “**On**”.

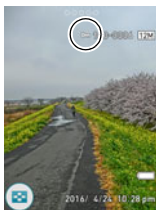

<b>All Files On</b>	Protects all files.
<b>All Files Off</b>	Unprotects all files.
<b>Select</b>	<p>Protects and unprotects specific files.</p> <ol style="list-style-type: none"><li>① Drag upwards or downwards to display the image you want to protect.</li><li>② Touch an image to be protected, and “<b>On</b>” will appear on the image. You can repeat steps ① and ② as many times as necessary to select multiple images.</li><li>③ Touch “OK”.</li></ol> <p>To unprotect an image, touch it in step ② of the above procedure to remove “<b>On</b>”.</p>



### IMPORTANT!

- Note that even if a file is protected, it will be deleted if you perform the format operation (page 107).

### NOTE



- You can also protect images using the image menu (page 67).

## Rotating an Image (Rotation)

---

### Procedure

Enter the **PLAY Mode** → **MENU** → **Rotation**

- 1. Drag upwards or downwards to display the image you want to rotate.**
- 2. Touch “”.**  
This will rotate the image 90 degrees to the left.
- 3. When the image is in the orientation you want, touch “”.**

### NOTE

- Note that this procedure does not actually change the image data. It simply alters how the image is displayed on the camera's monitor screen.
- An image that has been protected or zoomed cannot be rotated.

## Resizing a Snapshot (Resize)

---

### Procedure

Enter the **PLAY Mode** → **MENU** → **Resize**

You can reduce the size of a snapshot and save the result as a separate snapshot. The original snapshot is also retained. You can select resize an image to one of two image sizes: 3M, VGA.

- 1. Drag left or right to display the image you want to resize.**
- 2. Touch a size.**  
This resizes the image to the selected size and saves the result as a new photograph.

### NOTE

- The recording date of the resized version of the snapshot will be the same as the recording date of the original snapshot.

## Cropping a Snapshot (Trimming)

---

### Procedure

#### Enter the **PLAY Mode** → **MENU** → **Trimming**

You can crop a snapshot to trim parts you do not need, and save the result in a separate file. The original snapshot is also retained.

- 1. Drag left or right to display the image you want to crop.**

---
- 2. Touch “OK”.**

---
- 3. Drag the image until the part you want to keep is displayed.**
  - To enlarge the image, touch the screen with your thumb and forefinger and then spread them apart. To reduce the size of the image, touch the screen with your thumb and forefinger and then squeeze them together.

---
- 4. Touch “OK”.**

This will crop the image, leaving only the displayed part.

### NOTE

---

- The recording date of the cropped image will be the same as the recording date of the original snapshot.

# Establishing a Wireless LAN Connection

## Wireless LAN Functions

Establishing a wireless LAN connection between the camera and a smartphone enables the functions described below.

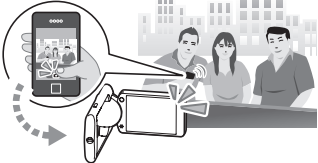
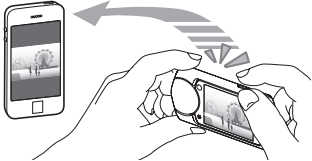
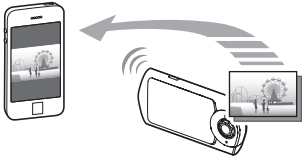
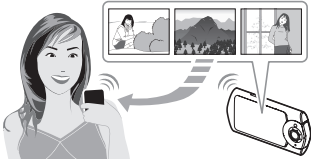
With this function:	You can do this:	See page:
<b>Remote Capture*</b> 	Remotely control and shoot with the camera using a smartphone.	83
<b>Send Last Shot*</b> 	Send a snapshot that was just recorded with the camera to a smartphone. After sending an image to a smartphone, you can then upload it to a social networking service.	85
<b>Send to phone*</b> 	Send snapshots and movies recorded with your camera to your smartphone. After sending an image to a smartphone, you can then upload it to a social networking service.	86
<b>View on phone</b> 	Use a smartphone or computer to view and download snapshots and movies stored in camera memory.	88

\* Requires installation of the EXILIM Remote app on your smartphone.



## **IMPORTANT!**

- Never use wireless LAN functions inside an aircraft or anywhere else where such operation is restricted.
- Some smartphone models may not be able to play back movie files that are sent to the smartphone.
- Depending on your smartphone model, its operating system version, and/or its remaining storage capacity can cause failure of a movie or snapshot save operation. After send operation, perform the required operation on your smartphone to ensure that the movie or snapshot was saved properly.
- Viewing a movie received on an Android terminal:  
Note that movies are not displayed by Gallery. Movies are stored in a folder named "EXILIM Remote". A separate movie player is required to playback movies (whose files have the file name extension MOV). Depending on your movie player, you may not be able to playback movies and/or audio.
- Attempting to use a memory card that includes a wireless function with this camera can cause abnormal operation.

## **NOTE**

---

- Note that using wireless LAN functions requires more battery power usage than normal. Make sure that the camera battery is sufficiently charged before starting a wireless LAN operation.
- The operating range depends on the local communication environment and on the type of smartphone you are connected to.



## Establishing a Connection between a Smartphone and Your Camera

Installing the EXILIM Remote Smartphone app on your smartphone makes it possible to remotely control the camera from your smartphone and to send images recorded with the camera to your smartphone. Search the EXILIM Remote app on Google Play or App Store and install it on your smartphone.

### ■ App operation guarantees

No guarantees are made concerning the ability to operate the EXILIM Remote app on any particular smartphone or tablet.

### IMPORTANT!

- For information about operating system version supported by the app, check the information on Google Play or the App Store.
- App functions and the required operating environment are subject to change without notice.

## Installing the EXILIM Remote App on Your Smartphone

### ■ Android terminal

1. Open “Google Play”.

---

2. In the search field, type “EXILIM Remote”.

---

3. Install EXILIM Remote.

### ■ iPhone

1. Open “App Store”.

---

2. In the search field, type “EXILIM Remote”.

---

3. Install EXILIM Remote.

## Configuring Wireless LAN Settings

Use the procedure below to establish a wireless LAN connection between the camera and a smartphone for the first time. This operation is required for the first connection only.

**1. On your camera, enter the REC mode and then touch “○○○○” (Show Icons).**

**2. On your camera, touch the “” (Remote Capture) icon.**

This will enable connection with a smartphone and the camera will display a screen for input of an SSID and password.

**3. For the smartphone Wi-Fi setting, input the camera SSID and password.**

When the message “Start up the phone app.” appears on the camera’s monitor screen, it means that the smartphone has established a wireless connection with the camera.

- To break the wireless connection, touch “Cancel”.
- What you need to do to establish a wireless LAN connection depends on the type of smartphone you are using. For details about how to establish a wireless LAN connection see the user documentation that comes with your smartphone.



## Using a Smartphone as a Camera Remote Controller (Remote Capture)

This function lets you remotely shoot a snapshot or movie with the camera using a smartphone. You also can perform remote zoom, self-timer, and other operations as well.

**1. On your camera, enter the REC mode and then touch “○○○○○” (Show Icons).**

---

**2. On your camera, touch the “” (Remote Capture) icon.**

---

**3. On your smartphone, start up the EXILIM Remote app.**

This will establish a connection between the smartphone and your camera.

- About 60 seconds after your camera establishes a connection with the smartphone, the camera's monitor screen will go blank and its back lamp will light green.
  - If the message “Connect your phone to the access point below.” remains on the camera's monitor screen, change the smartphone's Wi-Fi settings so your camera is selected for connection (page 82).
- 

**4. Compose the image on your smartphone's screen as you shoot.**

- After you are finished using Remote Capture, touch “Exit” on the camera or exit the app on your smartphone.

### **IMPORTANT!**

- For snapshots, Premium Auto Pro is automatically selected as the recording mode while shooting with Remote Capture. You cannot shoot with BEST SHOT or other recording modes.
- The Movie Quality is always STD (640×480) when shooting with Remote Capture.

## ■ Controlling Your Camera with a Smartphone

EXILIM Remote supports the Remote Capture operations listed below. This manual explains EXILIM Remote operations based on screens that appear using the iPhone version. Some operations may differ depending on your smartphone type.

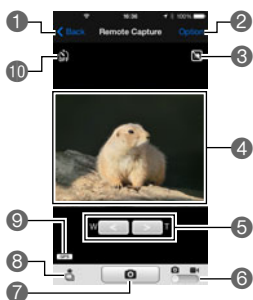

- 1 Exits Remote Capture.
- 2 Select to configure self-timer and LED light settings for snapshot shooting.  
The Remote Capture self-timer countdown time is 10 seconds (fixed).
- 3 Displays current LED light settings.
- 4 Displays what is being picked up by the camera's lens.
- 5 Performs a zoom operation.
- 6 Toggles between snapshot and movie shooting.
- 7 Shoot a snapshot or start movie recording.
- 8 Sends the snapshot that was just recorded to the smartphone.
- 9 Displays location information settings.
- 10 Displays current self-timer settings.

### Location Information

You can use **8** to add location information to snapshots shot with Remote Capture when they are sent to a smartphone. On an Android terminal, select **2** "Options" on the Remote Capture screen. On an iPhone, perform the following operation: "Settings" → "Privacy" → "Location Services".



### IMPORTANT!

- Enabling location-based services causes the recording date, location information, and other personally identifiable information to be included in the snapshot data. Take care when sharing or publishing such images on web services, etc.

## Sending a Just-recorded Snapshot to a Smartphone (Send Last Shot)

You can use Send Last Shot to send a snapshot you just recorded with the camera to a smartphone. After sending an image to a smartphone, you can then upload it to a social networking service.

- Note that you will not be able to use Send Last Shot to send a snapshot to a smartphone if you performed any one of the operations below after recording the snapshot.
  - Exiting the REC mode to the PLAY mode or turning off the camera
  - Resetting the camera (page 107) or formatting camera memory (page 107)
  - Selecting Remote Capture
  - Performing a movie recording operation

**1. On the camera, enter the REC mode and shoot the snapshot.**

---

**2. Touch the “” (Send Last Shot) icon.**

---

**3. Touch “Send”.**

---

**4. On your smartphone, start up the EXILIM Remote app.**

This will establish a connection between your camera and the smartphone, and send the snapshot you just recorded to the smartphone.

- If the message “Connect your phone to the access point below.” remains on the camera’s monitor screen, change the smartphone’s Wi-Fi settings so your camera is selected for connection (page 82).

**5. After image send is complete, perform one of the operations described below.**

“Preview photo in Scene app”: You can use the Scene app\* on the smartphone to view the sent images.

“Send to SNS”: Display the social networking service upload screen.

“To TOP Panel”: Return to the TOP screen.

- \* The Scene app is an image management app by ripplex inc. It makes it possible to display images at high speed and to share albums with friends. If you don’t want to use the Scene app, tap “Settings” in the upper right corner of the EXILIM Remote TOP screen, and then select “Off” for “Launch Scene Application”.

### NOTE

- You can specify the size of the image sent to the smartphone using “Resize before send” (page 87).
- You can use the smartphone apps below to view snapshots after sending them.
  - iPhone: Camera Roll
  - Android terminal: Gallery or another photo browser app

## Sending a Snapshot or Movie File from Camera Memory to a Smartphone (Send to phone)

You can select one more snapshot and/or movie file in camera memory and send it to a smartphone. You can select up to 100 files, totaling no more than 500MB for a single send. After sending an image to a smartphone, you can then upload it to a social networking service.

**1. On the camera, touch “▶” (PLAY) to enter the PLAY mode.**

---

**2. Touch “○○○○○” (Show Icons).**

---

**3. Touch the “📷” (Image Send) icon.**

---

**4. Touch “📱” (Send to phone).**

---

**5. Touch the images of the files you want to send to the smartphone.**  
Touching the image of a file causes its check box to become selected.

---

**6. After selecting the images of all of the files you want to send to the smartphone, touch “OK”.**

---

**7. On your smartphone, start up the EXILIM Remote app.**

This will establish a connection between your camera and the smartphone, and send the files to the smartphone.

- If the message “Connect your phone to the access point below.” remains on the camera’s monitor screen, change the smartphone’s Wi-Fi settings so your camera is selected for connection (page 82).
- 

**8. After image send is complete, perform one of the operations described below.**

“Preview photo in Scene app”: You can use the Scene app\* on the smartphone to view the sent images.

“Send to SNS”: Display the social networking service upload screen.

“To TOP Panel”: Return to the TOP screen.

- \* The Scene app is an image management app by ripplex inc. It makes it possible to display images at high speed and to share albums with friends. If you don’t want to use the Scene app, tap “Settings” in the upper right corner of the EXILIM Remote TOP screen, and then select “Off” for “Launch Scene Application”.

## NOTE

- You can specify the size of the snapshots sent to the smartphone using “Resize before send” (page 87).
- You can use the smartphone apps below to view snapshots after sending them.
  - iPhone: Camera Roll
  - Android terminal: Gallery or another photo browser app

## Resizing Snapshots before Sending Them to a Smartphone (Resize before send)

### Procedure

#### MENU → Setup → Resize before send

This feature can be used to resize snapshots before they are sent to a smartphone using “Send Last Shot”, “Remote Capture”, or “Send to phone”.

<b>3M</b>	Images are converted to 3M size before being sent. <ul style="list-style-type: none"><li>• If an original image is 3M size or smaller, it is sent without resizing.</li></ul>
<b>Off</b>	Images are sent in the size they were originally recorded.

## Viewing Snapshots and Movies in Camera Memory on a Smartphone (View on phone)

You can use this function to enable up to eight smartphones and/or computers to access snapshots and movies in camera memory for viewing and download. A smartphone does not need to have the EXILIM Remote app installed in order to access camera images using this function.

**1. On the camera, touch “” (PLAY) to enter the PLAY mode.**

---

**2. Touch “” (Show Icons).**

---

**3. Touch the “” (Image Send) icon.**

---

**4. Touch “” (View on phone).**

This establishes a connection between the smartphone and camera, and displays a URL.

- If the message “Connect your phone to the access point below.” remains on the camera’s monitor screen, change the smartphone’s Wi-Fi settings so your camera is selected for connection (page 82).
  - After about 60 seconds, the camera’s monitor screen will go blank. Touching the monitor screen will cause its image to reappear.
- 

**5. On the smartphone, start up its browser app.**

- The browser will automatically access the URL displayed by the camera in step 3 of this procedure, and then display an image stored in camera memory.
- If no camera image appears automatically, manually input the URL into the browser.  
URL: <http://exilim.remote/>
- To exit the wireless LAN function, touch “Exit” on the camera’s monitor screen.

### **IMPORTANT!**

- Some smartphone models may not be able to play back movie files.

### **NOTE**

---

- You can also view image in camera memory on a computer’s browser by establishing a wireless LAN connection with the computer.



# Printing

## Professional Print Service

You can take a memory card that contains the images you want to print to a professional print service and have them printed.



## Printing on a Home Printer

You can use a printer equipped with a memory card slot to print images directly from a memory card. For details, see the user documentation that comes with your printer.



## Printing with a Computer

After transferring the images to your computer, use commercially available software to print.

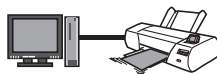

## Printing with a Computer

There are a variety of different ways to print images stored on a computer. This section shows one standard printing example.

### ■ Printing on a Windows Computer

- 1. Use the procedure under “Viewing and Storing Images on a Computer” (page 92) to store the image you want to print, and then display the image on your computer screen.**

---

- 2. Click “Print” and then “Print”.**

---

- 3. Configure the desired print settings and then click “Print”.**

## ■ Printing on a Macintosh

**1. Use the procedure under “Connecting the Camera to Your Computer and Saving Files” (page 95) to store the image you want to print, and then display the image on your Macintosh screen.**

---

**2. Click “File” and then “Print”.**

---



**3. Configure print settings and then click “Print”.**

This will print the selected image.

# Using the Camera with a Computer

## Things you can do using a computer...

You can perform the operations described below while the camera is connected to a computer.

<b>Save images to a computer and view them there</b> 	<ul style="list-style-type: none"><li>• Save images and view them manually (USB connection) (pages 92, 95).</li></ul>
<b>Play back and edit movies</b> 	<ul style="list-style-type: none"><li>• You can play back movies (pages 94, 97).</li><li>• To edit movies, use commercially available software as required.</li></ul>

The procedures you need to perform are different for Windows and the Macintosh.

<ul style="list-style-type: none"><li>• Windows users should refer to “Using the Camera with a Windows Computer” on page 91.</li><li>• Macintosh users should refer to “Using the Camera with a Macintosh” on page 95.</li></ul>
--

## Using the Camera with a Windows Computer

<b>When you want to do this:</b>	<b>Operating System Version</b>	<b>Required Software:</b>	<b>See page:</b>
Save images to a computer and view them there manually	Windows 8.1, Windows 8, Windows 7, Windows Vista	Installation not required.	92
Play movies	Windows 8.1, Windows 8, Windows 7, Windows Vista	QuickTime 7 <ul style="list-style-type: none"><li>• You need to download QuickTime 7 on the Web if you want to use it.</li></ul>	94

## Viewing and Storing Images on a Computer

You can connect the camera to your computer in order to view and store images (snapshot and movie files).

**Never use your computer to modify, delete, move, or rename any image files that are in the camera's built-in memory or on its memory card.**

Doing so can cause problems with the camera's image management data, which will make it impossible to play back images on the camera and can drastically alter remaining memory capacity. Whenever you want to modify, delete, move, or rename an image, do so only on images that are stored on your computer.

### **IMPORTANT!**

- Never unplug the USB cable, or operate the camera while viewing or storing images. Doing so can cause data to become corrupted.

### **NOTE**

- You also can use your computer's card slot (if it has one) or a commercially available card reader to access image files directly from the camera's memory card. For details, see the user documentation that comes with your computer.

## ■ To connect the camera to your computer and save files

### **1. Turn off the camera and then use the micro USB cable that comes with the camera to connect it to your computer.**

- For details about connecting to the camera and precautions when connecting, see page 22.

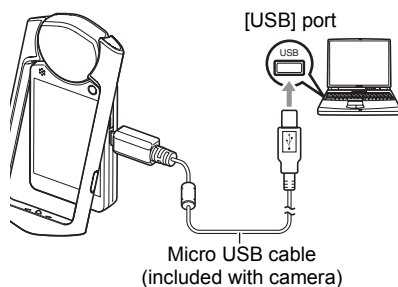

### **2. Press [⏻] (Power) to turn on the camera.**

When you turn on the camera, check to make sure that the color of its back lamp changes from red to green or amber (page 23). Note that in this case the monitor screen will remain blank.

- The first time you connect the camera to your computer with the USB cable, an error message may appear on your computer. If this happens, disconnect and then reconnect the USB cable.

### **3. Windows 8.1, Windows 8 users: Click “Desktop” and then “Explorer”. Windows 7, Windows Vista users: Click “Start” and then “Computer”.**

---

**4. Double-click “Removable Disk”.**

- Your computer recognizes the memory card loaded in the camera (or built-in memory if there is no card) as a removable disk.

---

**5. Right-click the “DCIM” folder.**

---

**6. On the shortcut menu that appears, click “Copy”.**

---

**7. Windows 8.1, Windows 8 users: Click “Documents”.****Windows 7, Windows Vista users: Click “Start” and then “Documents”.**

- If you already have a “DCIM” folder in “Documents”, the next step will overwrite it. If you want to keep the existing “DCIM” folder, you need to change its name or move it to a different location before performing the next step.

---

**8. Windows 8.1, Windows 8 users: On the “Documents” menus, click “Home” and then “Paste”.****Windows 7, Windows Vista users: On the “Documents” menu, click “Organize” or “Edit”, and then “Paste”.**

This will paste the “DCIM” folder (and all the image files it contains) into your “Documents” folder. You now have a copy of the files that are in camera memory on your computer.

---

**9. After you finish copying images, disconnect the camera from the computer.**

On the camera, press [⏻] (Power) to turn off the camera. After checking to make sure that the back lamp is unlit or lit red, disconnect the USB cable.

**■ To view images you copied to your computer**

---

**1. Double-click the copied “DCIM” folder to open it.**

---

**2. Double-click the folder that contains the images you want to view.**

---

**3. Double-click the image file you want to view.**

- For information about file names, see “Memory Folder Structure” on page 99.

## Playing Movies

---

To play back a movie, first copy it to your computer and then double-click the movie file. Some operating systems may not be able to play back movies. If this happens, you need to install separately available software.

- If you are unable to play back movies, go to the URL below to download QuickTime 7 and install it on your computer.  
<http://www.apple.com/quicktime/>

### ■ Minimum Computer System Requirements for Movie Playback

The minimum system requirements described below are necessary to play back movies recorded with this camera on a computer.

Operating System : Windows 8.1, Windows 8, Windows 7, Windows Vista

CPU : Image Quality "Full HD", "HD":  
Core 2 Duo 3.0GHz or higher  
Image Quality "HS240":  
Pentium 4 2.0GHz or higher

Required Software: QuickTime 7

- The above are recommended system environments. Configuring one of these environments does not guarantee proper operation.
- Certain settings and other installed software may interfere with proper playback of movies.

### ■ Movie Playback Precautions

- Be sure to move the movie data to the hard disk of your computer before trying to play it. Proper movie playback may not be possible for data accessed over a network, from a memory card, etc.
- Proper movie playback may not be possible on some computers. If you experience problems, try the following.
  - Quit any other applications you have running, and stop resident applications.

## Using the Camera with a Macintosh

When you want to do this:	Operating System Version	Required Software:	See page:
Save images to your Macintosh and view them there manually	OS X	Installation not required.	95
Save images to your Macintosh automatically/Manage images	OS X	iPhoto, which comes bundled with some Macintosh products.	–
Play movies	OS X	QuickTime 7.7 or higher	97

### Connecting the Camera to Your Computer and Saving Files

**Never use your computer to modify, delete, move, or rename any image files that are in the camera's built-in memory or on its memory card.**

Doing so can cause problems with the camera's image management data, which will make it impossible to play back images on the camera and can drastically alter remaining memory capacity. Whenever you want to modify, delete, move, or rename an image, do so only on images that are stored on your computer.



#### **IMPORTANT!**

- Never unplug the USB cable, or operate the camera while viewing or storing images. Doing so can cause data to become corrupted.
- The camera does not support operation with Mac OS X 10.0 to 10.4. Operation is supported with Mac OS 10.5 to 10.9 (using the OS standard USB driver) only.

#### **NOTE**

- You also can use your computer's card slot (if it has one) or a commercially available card reader to access image files directly from the camera's memory card. For details, see the user documentation that comes with your computer.

## ■ To connect the camera to your computer and save files

### 1. Turn off the camera and then use the micro USB cable that comes with the camera to connect it to your Macintosh.

- For details about connecting to the camera and precautions when connecting, see page 22.

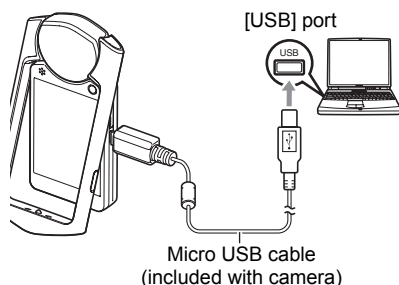

---

### 2. Press [⏻] (Power) to turn on the camera.

- When you turn on the camera, check to make sure that the color of its back lamp changes from red to green or amber (page 23). In this mode, your Macintosh recognizes the memory card loaded in the camera (or the camera's built-in memory if it does not have a memory card loaded) as a drive. The appearance of the drive icon depends on the Mac OS version you are using.
- The first time you connect the camera to your Macintosh with the USB cable, an error message may appear on your computer. If this happens, disconnect and then reconnect the USB cable.

---

### 3. Double-click the camera's drive icon.

The camera's back lamp will light green at this time. In this mode, your Macintosh recognizes the memory card loaded in the camera (or the camera's built-in memory if it does not have a memory card loaded) as a drive. The appearance of the drive icon depends on the Mac OS version you are using.

---

### 4. Drag the "DCIM" folder to the folder to which you want to copy it.

---

### 5. After the copy operation is complete, drag the drive icon to Trash.

---

### 6. Disconnect the camera from the computer.

On the camera, press [⏻] (Power) to turn off the camera. After checking to make sure that the back lamp is unlit or lit red, disconnect the USB cable.



## ■ To view copied images

1. Double-click the camera's drive icon.

---

2. Double-click the "DCIM" folder to open it.

---

3. Double-click the folder that contains the images you want to view.

---

4. Double-click the image file you want to view.

- For information about file names, see "Memory Folder Structure" on page 99.
- An image that was rotated on the camera will be displayed on your Macintosh screen in its original (unrotated) orientation.

## ■ Playing a Movie

---

You can use QuickTime, which comes bundled with your operating system, to play back movies on a Macintosh. To play back a movie, first copy it to your Macintosh and then double-click the movie file.

### ■ Minimum Computer System Requirements for Movie Playback

The minimum system requirements described below are necessary to play back movies recorded with this camera on a computer.

Operating System : Mac OS X 10.5 or higher

Required Software: QuickTime 7.7 or higher

- The above are recommended system environments. Configuring one of these environments does not guarantee proper operation.
- Certain settings and other installed software may interfere with proper playback of movies.

### ■ Movie Playback Precautions

Proper movie playback may not be possible on some Macintosh models. If you experience problems, try the following.

- Upgrade to the latest version of QuickTime.
- Shut down other applications that are running.



#### **IMPORTANT!**

- Be sure to move the movie data to the hard disk of your Macintosh before trying to play it. Proper movie playback may not be possible for data accessed over a network, from a memory card, etc.

## Files and Folders

The camera creates a file each time you shoot a snapshot, record a movie, or perform any other operation that stores data. Files are grouped by storing them in folders. Each file and folder has its own unique name.

- For details about how folders are organized in memory, see “Memory Folder Structure” (page 99).

Name and Maximum Number Allowed	Example
<b>File</b>	
Each folder can contain up to 9999 files named CIMG0001 through CIMG9999. The extension on the file name depends on the file type.	26th file name:  CIMG0026.JPG                         Extension Serial number (4 digits)
<b>Folders</b>	
Folders are named from 100CASIO to 999CASIO. There can be up to 900 folders in memory.	100th folder name:  100CASIO   Serial number (3 digits)

- You can view folder and file names on your computer. For details about how file names are displayed on the camera’s monitor screen, see page 10.
- The total number of folders and files allowed depends on the image size and quality, and capacity of the memory card being used for storage.

## Memory Card Data

The camera stores images you shoot in accordance with the Design Rule for Camera File System (DCF).

### ■ About DCF

The following operations are supported for DCF-compliant images. Note, however, that CASIO makes no performance guarantees concerning these operations.

- Transferring this camera's DCF-compliant images to another manufacturer's camera and view them.
- Printing this camera's DCF-compliant images on another manufacturer's printer.
- Transferring another camera's DCF-compliant images to this camera and view them.

### ■ Memory Folder Structure

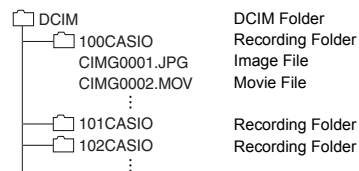

### ■ Supported Image Files

- Image files shot with this camera
- DCF-compliant image files

This camera may not be able to display an image, even if it is DCF-compliant. When displaying an image recorded on another camera, it may take a long time for the image to appear on this camera's monitor screen.

### ■ Built-in Memory and Memory Card Data Handling Precautions

- Whenever copying memory contents to your computer, you should copy the DCIM folder and all of its contents. A good way to keep track of multiple DCIM folders is to change their names to dates or something similar after you copy them to your computer. If you later decided to return a DCIM folder to the camera, however, be sure to change its name back to DCIM. The camera is designed to recognize only a root file with the name DCIM. Note the camera also will not be able to recognize the folders inside the DCIM folder unless they have the names they originally had when you copied them from the camera to your computer.
- Folders and files must be stored in accordance with the "Memory Folder Structure" shown on page 99 in order for the camera to be able to recognize them correctly.

## Other Settings (Set Up)

This section explains menu items that you can use to configure settings and perform other operations in both the REC mode and PLAY mode.

For information about menu operations, see page 55.

### Adjusting Monitor Screen Brightness (Screen)

#### Procedure

**MENU** → **Setup** → **Screen**

You can use the following procedure to change the brightness of the monitor screen.

<b>Auto</b>	With this setting, the camera detects available light levels and automatically adjusts the brightness of the monitor screen accordingly.
<b>+2</b>	Brightness that is greater than +1, which makes the screen easier to view. This setting consumes more power.
<b>+1</b>	Bright setting for outdoor use, etc. Brightness that is greater than 0.
<b>0</b>	Normal monitor screen brightness for indoor use, etc.
<b>-1</b>	Screen brightness for viewing in a dark environment without disturbing others around you.

### Selecting Display Information (Info)

#### Procedure

**MENU** → **Setup** → **Info**

Selecting "ON" displays setup status and other information.

#### NOTE

- When "Info" is enabled (On) in the PLAY mode, the exposure, shutter speed, and ISO sensitivity setting values of the currently displayed image are displayed in red when the current image's Auto Exposure (AE) is not correct.

## Locking the Screen (Screen Lock)

### Procedure

**MENU** → **Setup** → **Screen Lock**

Normally, the arrangement of icons and the images displayed on the camera monitor screen change automatically in accordance with the camera's orientation. Selecting "On" for the "Screen Lock" setting will lock the screen so its contents do not readjust to match the camera orientation.

## Resizing Snapshots before Sending Them to a Smartphone (Resize before send)

### Procedure

**MENU** → **Setup** → **Resize before send**

See page 87 for details.

## Configuring Camera Sound Settings (Sounds)

### Procedure

**MENU** → **Setup** → **Sounds**

<b>Startup</b>		Toggles the operation tone between on and off.
<b>Half Shutter</b>		
<b>Shutter</b>		
<b>Operation</b>		
<b>Volume</b>	<b>Operation Vol</b>	Specifies the sound volume. This volume setting is also used during video output (from the HDMI port) (page 68).
	<b>Playback Vol</b>	Specifies the volume of movie audio output. This volume setting is also used during video output (from the HDMI port) (page 68).
	<b>Posing Vol</b>	Specifies the volume of Posing Shot voice guidance. Voice guidance is output in accordance with this setting even if "Off" is selected for the "Shutter" operation tone setting.

- Setting a volume level of 0 mutes output.

## Time Stamping Snapshots (Timestamp)

### Procedure

#### **MENU** → **Setup** → **Timestamp**

You can configure the camera to stamp the recording date only, or date and time in the lower right corner of each snapshot.

- Once date and time information is stamped into a snapshot, it cannot be edited or deleted.

Example: July 10, 2016, 1:25 p.m.

<b>Date</b>	2016/7/10
<b>Date &amp; Time</b>	2016/7/10 1:25pm
<b>Off</b>	No stamping of date and/or time

- Even if you do not stamp the date and/or time with Timestamp, you can do so later using some printing application.
- Stamping is performed in accordance with the date and time settings (page 104) and the display style settings (page 104).

## Configuring World Time Settings (World Time)

### Procedure

**MENU** → **Setup** → **World Time**

### Setting a Travel Destination

You can use the World Time screen to view the current time in a zone that is different from your Home City when you go on a trip, etc. World Time displays the current time in 162 cities in 32 time zones around the globe.

#### 1. Touch “Destination”.

- To change the geographic area and city for the time where you normally use the camera, select “Home”.

#### 2. Touch “City”.

- To specify summer time for the destination city, select “DST” and then select the “On” setting (Summer time is used in some geographical areas to advance the current time setting by one hour during the summer months).

#### 3. Drag upwards and downwards to display the area of the destination city and then touch the area.

#### 4. Drag upwards and downwards until you find the city you want, and then touch to select it.

#### **IMPORTANT!**

- Before configuring World Time settings, make sure that the Home City setting is the place where you live or normally use the camera. If it isn't, select “Home” on the screen in step 1 and configure the Home City, date, and time settings as required (page 104).

### Selecting the Time Display

Use this procedure to specify the time displayed by the camera for your home city and destination.

#### 1. Touch “Time”.

#### 2. Touch “Home” or “Destination”.



This will configure the time setting of the location you touched in the previous step.



## Setting the Camera's Clock (Adjust)

### Procedure

MENU → Setup → Adjust

1. Touch the value you want to change (year, month, day, hour, minute).

2. Touch “” or “” to change the currently selected value.

- You can specify a date from 2001 to 2049.
- Be sure to select your Home City (page 103) before setting the time and date. If you set the time and date while the wrong city is selected for your Home City, the times and dates of all of the World Time cities (page 103) will be wrong.
- To switch between 12-hour and 24-hour format, touch the 12/24 hour switch icon.
- Touching and holding “” or “” scrolls at high speed.

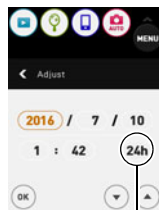

12/24 hour switch icon

3. Touch “OK”.

## Specifying the Date Style (Date Style)

### Procedure

MENU → Setup → Date Style

You can select from among three different styles for the date.

Example: July 10, 2016

YY/MM/DD	16/7/10
DD/MM/YY	10/7/16
MM/DD/YY	7/10/16



## Specifying the Display Language (Language)

### Procedure

**MENU** → **Setup** → **Language**

■ Specify the display language you want.

1. On the menu screen, touch “Setup”.
2. Touch “Language”.
3. Drag upwards and downwards until you find the language you want, and then touch to select it.



- Camera models sold in certain geographic areas may not support display language selection.

## Selecting the HDMI Terminal Output Method (HDMI)

### Procedure

**MENU** → **Setup** → **HDMI**

Use this setting to select the digital signal format when connecting to a TV with an HDMI cable.

<b>Auto</b>	This setting will cause the format to change automatically in accordance with the connected TV. Normally, you should use this mode.
<b>1080i</b>	1080i format output*
<b>480p</b>	480p format output
<b>576p</b>	576p format output

- \* 1080i corresponds to 1080 60i, but not 1080 50i. Because of this, the required output method may be 576p when outputting to a digital TV in a PAL reception area that does not support 1080i 60i. If you are in a PAL reception area and nothing is displayed automatically, change the setting to 576p.
- If an image does not appear when “Auto” is selected as the output method, try changing this setting to something else.

## Changing the Camera Password for Wireless LAN Connection (WLAN password)



### Procedure

**MENU** → **Setup** → **WLAN password**

Use procedure to change the password you used when establishing a wireless LAN connection between the camera and a smartphone.

- 1. Touch the password digit you want to change.**

---

- 2. Touch “” and “” to change the currently selected digit.**

---

- 3. When the password is the way you want, touch “OK”.**

### NOTE

- Note that after changing the wireless LAN password on the camera, you will also need to change the Wi-Fi settings of the smartphone.
  - iPhone:  
Tap the right arrow of the field where the SSID of the camera is displayed in the Wi-Fi settings to delete network settings. After deleting, select the camera SSID again and input the new password.
  - Android terminal:  
Touch the field where the SSID of the camera is displayed in the Wi-Fi settings and select Forget. Select the camera SSID again and input the new password.

## Displaying a Startup Screen at Power On (Startup)

### Procedure

**MENU** → **Setup** → **Startup**

Selecting “On” for Startup causes a built-in startup screen to appear on the monitor screen whenever the camera is turned on.

## Formatting Built-in Memory or a Memory Card (Format)

### Procedure

#### **MENU** → **Setup** → **Format**

If a memory card is loaded in the camera, this operation will format the memory card. It will format built-in memory if no memory card is loaded.

- The format operation will delete all contents on the memory card or in built-in memory. It cannot be undone. Make sure you do not need any data currently on the card or in built-in memory before you format it.
- Formatting built-in memory or a memory card will delete all protected images stored there.
- Check the battery level before starting a format operation and make sure it is not too low. Formatting may not be performed correctly and the camera may stop operating normally if the camera powers down while formatting is in progress.

## Resetting the Camera to Factory Defaults (Reset)

### Procedure

#### **MENU** → **Setup** → **Reset**

See page 123 for details about the camera's factory default settings.

The settings below are not reset.

World Time settings, clock settings, date style, screen language, WLAN password

## Safety Precautions

### **DANGER**

This symbol indicates information that, if ignored or applied incorrectly, creates the danger of death or serious personal injury.

### **WARNING**

This indication stipulates matters that have the risk of causing death or serious injury if the product is operated incorrectly while ignoring this indication.

### **CAUTION**

This indication stipulates matters that have the risk of causing injury as well as matters for which there is the likelihood of occurrence of physical damage only if the product is operated incorrectly while ignoring this indication.

### Symbol Examples





This circle with a line through it (⊘) means that the indicated action must not be performed. Indications within or nearby this symbol are specifically prohibited. (The example at left indicates that disassembly is prohibited.)







The black dot (●) means that the indicated action must be performed. Indications within this symbol are actions that are specifically instructed to be performed. (The example at left indicates that the power plug must be unplugged from the electrical socket.)

### **DANGER**

#### ■ Rechargeable Battery

- To charge the battery, use only the method specifically described in this manual. Attempting to charge the battery by an unauthorized means creates the risk of battery overheating, fire, and explosion. 
- Do not expose or immerse the battery in fresh water or salt water. Doing so can damage the battery, and cause deterioration of its performance and loss of service life. 
- The battery is intended for use with a CASIO Digital Camera only. Use with any other device creates the risk of the battery damage, or deterioration of battery performance and service life. 

 **DANGER**

- Failure to observe any of the following precautions creates the risk of battery overheating, fire, and explosion.
  - Never use or leave the battery near open flame. 
  - Do not expose the battery to heat or fire.
  - Make sure the battery is oriented correctly when charging it.
  - Never carry or store the battery together with items that can conduct electricity (necklaces, pencil lead, etc.).
  - Never disassemble the battery, pierce it with a needle, or expose it to strong impact (hit it with a hammer, step on it, etc.), and never apply solder to it. Never place the battery into a microwave oven, dehumidifier, high-pressure generating device, etc.
  - Never remove the outer sticker from the battery.
- Should you ever notice leakage, strange odor, heat generation, discoloration, deformation, or any other abnormal condition while using, charging, or storing a battery, immediately remove it from the camera and keep it away from open flame. Also, do not use the affected battery after the abnormal symptoms disappear. 
- Do not use or leave the battery under direct sunlight, in an automobile parked in the sun, or in any other area subject to high temperatures. Doing so can damage the battery, and cause deterioration of its performance and loss of service life. Also, these conditions can cause the battery to swell to the point that you may not be able to remove it. 
- Battery fluid can damage your eyes. Should battery fluid get into your eyes accidentally, immediately rinse them with clean tap water and then consult a physician. 

 **WARNING**

■ **Smoke, abnormal odor, overheating, and other abnormalities**

- Continued use of the camera while it is emitting smoke or strange odor, or while it is overheating creates the risk of fire and electric shock. Immediately perform the following steps whenever any of the above symptoms are present.



1. Turn off the camera.
2. If you are using the USB-AC adapter to power the camera, unplug the power plug from the power outlet. Also, remove the battery from the camera, taking care to protect yourself against burn injury.
3. Contact your retailer or nearest CASIO authorized service center.

■ **Keep Away From Fire**

- Never expose the camera to fire, which can cause it to explode and creates the risk of fire and personal injury.



■ **Avoid Use While In Motion**

- Never use the camera to record or play back images while operating an automobile or other vehicle, or while walking. Looking at the monitor while in motion creates the risk of serious accident.



■ **LED Light**

- Never use the LED light while it is pointed in the direction of a person operating a motor vehicle. Doing so can interfere with the driver's vision and create the risk of accident.



■ **USB-AC Adapter**

- Misuse of USB-AC adapter creates the risk of fire and electric shock. Be sure to observe the following precautions.

- Use only the specified USB-AC adapter.
- Never use the USB-AC adapter with another device.
- Use a power outlet that matches the power supply specified for the USB-AC adapter.
- Never plug the USB-AC adapter or power cord into a wall outlet that is shared by other devices, or into a shared extension cord.
- Never locate the USB-AC adapter near a stove or other heating device.







- Misuse of the USB-AC adapter can cause them to become damaged, creating the risk of fire and electric shock. Be sure to observe the following precautions.



- Never place heavy objects on the USB-AC adapter or subject it to direct heat.
- Do not modify the USB-AC adapter, allow it to become damaged, or forcibly bend it.
- Do not twist or pull on the power cord.
- When in use, locate the cord where it will not be tripped over.



## **WARNING**

- Never touch the power plug while your hands are wet. Doing so creates the risk of electric shock. 
- Should the power cord or power plug become damaged, contact your retailer or nearest CASIO authorized service center. 
- Do not use the USB-AC adapter in areas where liquids\* might spill on them. Liquids create the risk of fire and electric shock. 
  - \* Liquids: Water, sports drinks, seawater, animal or pet urine, etc.
- Do not place a flower vase or any other liquid container on top of the USB-AC adapter. Water creates the risk of fire and electric shock. 
- Do not touch the camera or USB-AC adapter during lightning storms. 

### **If a power cord was included with your camera**

- The power cord that comes with the camera is designed for use in the country where the camera was purchased. If you use the camera in another country, be sure to use a power cord that conforms to that country's ratings and power supply voltage. Use of an improper power cord creates the risk of fire and electric shock. 
- Before going out, be sure to unplug the USB-AC adapter from the power outlet and put in a place away from objects used by animals and pets. An animal or pet chewing on the power cord can cause it short, leading to the risk of fire. 

### **■ Water and Foreign Matter**

- Water, other liquids, or foreign matter (especially metal) getting inside the camera creates the risk of fire and electric shock. Immediately perform the following steps whenever any of the above symptoms are present. Particular care is required when using the camera where it is raining or snowing, near the ocean or other body of water, or in a bathroom. 
  1. Turn off the camera.
  2. If you are using the USB-AC adapter to power the camera, unplug the power plug from the power outlet. Also, remove the battery from the camera, taking care to protect yourself against burn injury.
  3. Contact your retailer or nearest CASIO authorized service center.

### **■ Disassembly and Modification**

- Never try to take it apart or modify it in any way. Doing so creates the risk of electric shock, burn injury, and other personal injury. Be sure to leave all internal inspection, maintenance, and repair up to your retailer or nearest CASIO authorized service center. 

 **WARNING**

■ **Dropping and Rough Treatment**

- Continued use of the camera after it is damaged by dropping or other rough treatment creates the risk of fire and electric shock. Immediately perform the following steps whenever any of the above symptoms are present. 
  1. Turn off the camera.
  2. If you are using the USB-AC adapter to power the camera, unplug the power plug from the power outlet. Also, remove the battery from the camera, taking care to protect yourself against burn injury.
  3. Contact your retailer or nearest CASIO authorized service center.





■ **Memory Cards**

- Memory cards are small and present a risk of accidentally being swallowed by infants and young children. Keep memory cards out of the reach of infants and young children. If a memory card is ever swallowed accidentally, contact a physician immediately. 

■ **Precaution when Camera is On**

- Do not touch the camera for long periods while it is on. The camera becomes warm when on, and long term contact creates the risk of low-temperature burns. 



■ **Interference with other digital devices**

- Should you notice radio interference or other problems on other devices is being caused while using this camera, stop using the wireless functions (Remote Capture, image transfer, wireless image viewing, etc.) of this camera, or turn off the camera. Use of wireless functions creates the risk of radio interference and abnormal operation of other devices. 
- When in a medical facility or aircraft, comply with instructions of personnel in charge. Electromagnetic waves and other signals emitted by the camera's wireless function create the risk of accident. 
- Do not use the camera's wireless function while in the vicinity of high precision digital devices or digital devices that use weak signals. Doing so can interfere with proper operation of such digital devices and create the risk of accident. 
- When using the camera's wireless function, keep it away from any person wearing a pacemaker. Magnetism emitted by the camera may affect cardiac pacemakers and other medical devices. Should you ever notice any abnormality, immediately move away from the product and contact a physician. 
- On a crowded train or any other crowded location where there is the possibility of being in the vicinity of a person wearing a cardiac pacemaker, stop using the wireless functions (Remote Capture, image transfer, wireless image viewing, etc.) of this camera, or turn off the camera. Radio waves emitted by the camera's wireless function may affect pacemaker operation. 







 **CAUTION**

■ **USB-AC Adapter**

- Misuse of the USB-AC adapter creates the risk of fire and electric shock. Make sure you observe the following precautions.
  - Never cover the USB-AC adapter or power cord with a quilt, blanket, or other cover while it is in use, and do not use it near a heater. Doing so can interfere with heat radiation and cause the area around them to become hot. 
  - Do not use detergent when cleaning the power cord, the USB-AC adapter, or the USB cable (especially the plugs and jacks).
  - Insert the power plug into the wall outlet as far as it will go.
  - Unplug the power plug from the wall outlet before leaving the camera unattended for long periods, such as when leaving on a trip, etc. 
  - At least once a year, use a cloth or vacuum cleaner to clean any dust build up on the prongs of the power plug and in the area around them.
  - (Power cord included with your camera) When unplugging from the wall outlet, never pull on the power cord. Grasp the power plug and pull.

■ **Rechargeable Battery**

- If battery charging does not end normally within the specified charging time, stop charging anyway and contact your local CASIO authorized service center. Continued charging creates the risk of battery overheating, fire, and explosion. 
- Be sure to read the user documentation that comes with the camera before using or charging the battery. 
- Store batteries in a location that cannot be reached by infants and young children. When using a battery where infants and young children are present, be on guard to ensure that they do not have the chance to remove the battery from the camera. 
- Do not leave batteries near areas used by pets. A pet chewing on a battery can lead to accidents caused by the battery leaking, overheating, or exploding. 
- Should fluid from a battery accidentally get onto clothing or your skin, immediately rinse it off with clean tap water. Prolonged contact with battery fluid can cause skin irritation. 

■ **Connections**

- Never plug any devices that are not specified for use with this camera into connectors. Connecting a non-specified device creates the risk of fire and electric shock. 

■ **Unstable Locations**

- Never place the camera on an unstable surface, on a high shelf, etc. Doing so can cause the camera to fall, creating the risk of personal injury. 

 **CAUTION**

■ **Locations To Be Avoided**

- Never leave the camera in any of the following types of locations. Doing so creates the risk of fire and electric shock.
  - Areas subject to large amounts of humidity or dust
  - Food preparation areas or other locations where oil smoke is present
  - Near heaters, on a heated carpet, in areas exposed to direct sunlight, in a closed vehicle parked in the sun, or other areas subject to very high temperatures



■ **Monitor Screen**

- Do not apply strong pressure to the LCD panel surface or subject it to strong impact. Doing so can cause the display panel glass to crack and lead to personal injury.
- Should the monitor screen ever become cracked, never touch any of the liquid inside the monitor screen. Doing so creates the risk of skin inflammation.
- Should monitor screen liquid ever get into your mouth, immediately rinse your mouth out and contact your physician.
- Should monitor screen liquid ever get into your eyes or onto your skin, immediately rinse with clean water for at least 15 minutes and contact your physician.



■ **Backing Up Important Data**

- Always keep backup copies of important data in camera memory by transferring it to a computer or other storage device. Note that data can be deleted in the case of camera malfunction, repair, etc.



■ **Memory Protection**

- Whenever replacing the battery, be sure to follow the correct procedure as described in the documentation that comes with the camera. Incorrectly replacing the battery can result in corruption or loss of data in camera memory.



■ **LED Light**

- Do not fire the LED light or use other light emitting functions while the light is pointed in the direction of and too close to a person's face. Doing so creates the risk of momentary loss of eyesight.



## Precautions During Use

### ■ Data Error Precautions

Your digital camera is manufactured using precision digital components. Any of the following creates the risk of corruption of data in camera memory.

- Removing the battery or memory card while the camera is performing some operation
- Removing the battery or memory card while the back lamp is flashing green after turning off the camera
- Disconnecting the USB cable while communication is in progress
- Shooting with a battery that quickly goes low right after it is charged
  - Shooting with a battery that quickly goes low right after it is charged can also cause camera malfunction. Replace the battery with a new one immediately.
- Other abnormal operations

Any of the above conditions can cause an error message to appear on the monitor screen (page 129). Perform the action indicated by the message that appears.

### ■ Operating Environment

- Operating Temperature Requirements: 0 to 40°C (32 to 104°F)
- Operating Humidity: 10 to 85% (non condensation)
- Do not place the camera in any of the following locations.
  - In an area exposed to direct sunlight, or large amounts of moisture, dust, or sand
  - Near heating or cooling devices, or in other areas subjected to extreme changes in temperature or humidity
  - Inside of a motor vehicle on a hot day, or in an area subjected to strong vibration

### ■ Condensation

Sudden and extreme temperature changes, such as when the camera is moved from the outdoors on a cold winter day into a warm room, can cause water droplets called “condensation” to form on the interior and the exterior of the camera, which creates the risk of malfunction. To prevent condensation from forming seal the camera in a plastic bag before changing locations. Then leave the bag sealed to allow the air inside to naturally change to the same temperature as the air in the new location. After that, remove the camera from the bag and open the battery cover for a few hours.

## ■ Lens

- Never apply too much force when cleaning the surface of the lens. Doing so can scratch the lens surface and cause malfunction.
- You may sometimes notice some distortion in certain types of images, such as a slight bend in lines that should be straight. This is due to the characteristics of lenses, and does not indicate malfunction of the camera.

## ■ Caring for your camera

- Never touch the lens with your fingers. Finger smudges, dirt, and other foreign matter on the lens can interfere with proper operation of the camera. Use a blower or other means to keep the lens and flash window free of dirt and dust, and wipe gently with a soft, dry cloth.
- To clean the camera, wipe it with a soft, dry cloth.

## ■ Old Rechargeable Battery Handling Precautions

- Insulate the positive and negative terminals with tape, etc.
- Do not peel the covering off of the battery.
- Do not try to take the battery apart.

## ■ Discarding or Transferring Ownership of a Memory Card or the Camera

The format and delete functions of the camera do not actually delete files from the memory card. The original data remains on the card. Note that responsibility for the data on a memory card lies with you. The following procedures are recommended whenever you discard a memory card or the camera, or if you transfer ownership to another party.

- When discarding a memory card, either physically destroy the memory card or use commercially available data delete software to completely delete the data on the memory card.
- When transferring ownership of a memory card to another party, use commercially available data deletion software to completely delete the data on it.
- Use the format function (page 107) to completely delete the data in built-in memory before discarding or transferring ownership of the camera.

## ■ Precautions when using the wireless LAN function

This product uses wireless data communication which can cause interference with or be subject to interference by other nearby devices.

### Radio transmission interception

Note that the radio waves that are used to send and receive data can be intercepted by third parties.

### Unauthorized access

CASIO COMPUTER CO., LTD. shall be held in no way liable for any unauthorized access and/or use of the access point equipped on this product if the product is ever lost or stolen.

### Use as a wireless LAN device

Use the wireless LAN function of this product only as specifically described in this manual. Any other use is unintended use, and CASIO COMPUTER CO., LTD. shall be held in no way liable for any damages arising out of unintended use.

### Magnetism, electrostatic charge, and radio interference

Do not use this product near a microwave oven or any other area where magnetism, electrostatic charge, or radio interference is generated. Radio wave reception may be poor in certain environments.

Also note that other devices using the same 2.4GHz band used by this product may cause reduced processing speeds in both devices.

### Connecting to a public LAN

This product does not support wireless LAN connection over a public wireless LAN environment.

### Intended Areas of Use

- 1)The wireless LAN functions of this camera are provided for use in the countries and geographic areas below.  
Hong Kong, Singapore, Thailand, The United Arab Emirates (UAE), Paraguay, Venezuela, Panama, Germany, Austria, France, The Netherlands, Spain, Italy, Sweden, Denmark, Slovakia, Poland, and Norway
- 2)Approval for use under radio regulations in the countries and geographic areas below is granted only when the camera is purchased within that particular country or geographic area.  
Taiwan, Indonesia, Malaysia, and South Korea

## ■ Other Precautions

The camera becomes slightly warm during use. This is normal and does not indicate malfunction.

## ■ Copyrights

Except for your own personal enjoyment, unauthorized use of snapshots or movies of images whose rights belong to others, without the permission of the right holder, is forbidden by copyright laws. In some cases, shooting of public performances, shows, exhibitions, etc. may be restricted entirely, even if it is for your own personal enjoyment. Regardless of whether such files are purchased by you or obtained for free, posting them on a website, a file sharing site, or any other Internet site, or otherwise distributing them to third parties without the permission of the copyright holder is strictly prohibited by copyright laws and international treaties. For example, uploading or distributing on the Internet images of TV programs, live concerts, music videos, etc. that were photographed or recorded by you may infringe upon the rights of others. Note that CASIO COMPUTER CO., LTD. shall not be held liable for use of this product in any way that infringes on the copyrights of others or that violates copyright laws.

The following terms, which are used in this manual, are registered trademarks or trademarks of their respective owners.

Note that trademark <sup>™</sup> and registered trademark <sup>®</sup> are not used within the text of this manual.

- microSDXC Logo is a trademark of SD-3C, LLC.
- Microsoft, Windows, Windows Vista, Windows 7, Windows 8, and Windows 8.1 are registered trademarks or trademarks of Microsoft Corporation in the United States and other countries.
- Macintosh, Mac OS, QuickTime, iPhoto, and iPhone are trademarks of Apple Inc.
- HDMI, the HDMI logo, and High-Definition Multimedia Interface are trademarks or registered trademarks of HDMI Licensing, LLC.
- Android and Google Play are trademarks or registered trademarks of Google Inc.
- App Store is a service mark of Apple Inc.
- iOS is a trademark or registered trademark of Cisco Systems, Inc. of the United States.
- Wi-Fi is a registered trademark of the Wi-Fi Alliance.
- EXILIM and EXILIM Remote are registered trademarks or trademarks of CASIO COMPUTER CO., LTD.
- All other company or product names mentioned herein are registered trademarks or trademarks of their respective companies.

Any and all unauthorized copying, distribution, and transfer for commercial purposes of the software provided by CASIO for this product are prohibited.

## OpenVG 1.1 Reference Implementation

Copyright (c) 2007 The Khronos Group Inc.

Permission is hereby granted, free of charge, to any person obtaining a copy of this software and /or associated documentation files (the "Materials "), to deal in the Materials without restriction, including without limitation the rights to use, copy, modify, merge, publish, distribute, sublicense, and/or sell copies of the Materials, and to permit persons to whom the Materials are furnished to do so, subject to the following conditions:

The above copyright notice and this permission notice shall be included in all copies or substantial portions of the Materials.

THE MATERIALS ARE PROVIDED "AS IS", WITHOUT WARRANTY OF ANY KIND, EXPRESS OR IMPLIED, INCLUDING BUT NOT LIMITED TO THE WARRANTIES OF MERCHANTABILITY, FITNESS FOR A PARTICULAR PURPOSE AND NONINFRINGEMENT. IN NO EVENT SHALL THE AUTHORS OR COPYRIGHT HOLDERS BE LIABLE FOR ANY CLAIM, DAMAGES OR OTHER LIABILITY, WHETHER IN AN ACTION OF CONTRACT, TORT OR OTHERWISE, ARISING FROM, OUT OF OR IN CONNECTION WITH THE MATERIALS OR THE USE OR OTHER DEALINGS IN THE MATERIALS.

### Charging

#### ■ If the camera's back lamp starts flashing red...

If the back lamp starts flashing red during charging, it means that further charging is not possible for one of the reasons below. Perform the actions described below to correct the problem and then try charging again.

#### **Ambient temperature or the temperature of the battery is abnormally high or low**

Unplug the USB cable from the camera and wait for a while until the camera is within the temperature range of 15°C to 35°C (59°F to 95°F), and then try charging again.

#### **Safety timer activated**

A battery that has not been used for a long time, certain types of computers, and connection conditions can cause charging to take longer than normal. If charging takes longer than about five hours, a safety timer will terminate it automatically, even if the battery is not fully charged. If the battery has not been used for a very long time, charging may terminate automatically after only about 60 minutes.

- 1) Using a battery that has not been used for a long time.  
Disconnect and then reconnect the USB cable to resume charging.
- 2) Insufficient power supply when connected to computer  
The camera can be charged only via a USB 2.0 standard USB port. Connect directly to a USB port what supplies a current of 500mA.

For details about the power supply capacity of a computer's USB port, contact the manufacturer of the computer. Though disconnecting and then reconnecting the USB cable will resume charging, you may need to do so repeatedly if the power supply capacity of the computer is low.

If problems persist after you perform the above steps or if the battery fails to charge after 5 hours, it could mean that the battery is faulty. Contact your nearest CASIO authorized service center.



## Battery Precautions

---

### ■ Precautions during Use

- Operation provided by a battery under cold conditions is always less than operation under normal temperatures. This is due to the characteristics of the battery, not the camera.
- Charge the battery in an area where the temperature is within the range of 15°C to 35°C (59°F to 95°F). Outside this temperature range charging can take longer than normal or even fail.
- Do not tear or remove the battery outer label.
- If a battery provides only very limited operation following a full charge, it probably means the battery has reached the end of its service life. Replace the battery with a new one.

### ■ Storage Precautions

- Storing the battery for a long time while it is charged can cause deterioration of battery characteristics. If you do not plan to use a battery for some time, fully use up its charge before storing it.
- Always remove the battery from the camera when you are not using it. A battery left in the camera can discharge and go dead, which will require some time to charge when you need to use the camera.
- Store batteries in a cool, dry place (20°C (68°F) or lower).
- To prevent over discharging of an unused battery, fully charge it, and then load it in the camera and fully use up the charge about once every six months.

## Using the Camera in another Country

---

### ■ Precautions during Use

- The bundled USB-AC adaptor is designed for operation with any power supply in the range of 100V to 240V AC, 50/60Hz. Note, however, that the shape of the power plug depends on each country or geographic area. Before taking the camera and USB-AC adaptor along on a trip, check with travel agent about the power supply requirements in your destination(s).
- Do not connect the USB-AC adaptor to a power supply through a voltage converter or similar device. Doing so can lead to malfunction.

### ■ Extra Batteries

- Taking along extra fully charged batteries (NP-150) is recommended while on a trip in order to avoid not being able to shoot images due to the battery going dead.

## Using a Memory Card

See page 26 for information about supported memory cards and how to load a memory card.

### ■ Using a Memory Card

- If a memory card starts to behave abnormally during image playback, you can restore normal operation by reformatting it (page 107). However, it is recommended that you always take along multiple memory cards whenever using the camera far away from the home or office.
- As you record data to and delete data from a memory card a number of times, it loses its ability to retain data. Because of this, periodic re-formatting of a memory card is recommended.
- Electrostatic charge, electrical noise, and other phenomena can cause data to become corrupted or even lost. Make sure that you always back up important data on other media (CD-R, CD-RW, hard disk, etc.).

### ■ Memory Card Handling Precautions

Certain types of memory cards can slow down processing speed. Whenever possible use an Ultra High-Speed Type memory card. Note, however, that not all operations can be guaranteed even if an Ultra High-Speed Type memory card is used. Certain movie quality settings can result in too much time being required to record data, which can result in breaks in the image and/or audio during playback. If this happens, the movie icon will turn yellow on the monitor screen.

## Reset Initial Default Settings

The tables in this section show the initial default settings on menus that appear in the REC mode and PLAY mode when you reset the camera (page 107).

- A dash (–) indicates an item whose setting is not reset or an item for which there is no reset setting.



### IMPORTANT!

- Some menu items may not be available, depending on the recording mode being use.

### ■ REC Menu

<b>Touch Shutter</b>	Off
<b>Self-timer</b>	Off
<b>LED</b>	Off
<b>Image Size</b>	12M
<b>Movie Quality</b>	Full HD
<b>Brightness</b>	0.0

<b>White Balance</b>	Auto WB
<b>ISO</b>	Auto
<b>Focus</b>	AF
<b>Review</b>	Type 2
<b>Setup</b>	→ See below.

\* Default setting depends on country or geographic region.

### ■ PLAY Menu

<b>Promotion Movie</b>	–
<b>Paint</b>	–
<b>Slideshow</b>	–
<b>Cut out subject</b>	–
<b>Paste subject</b>	–

<b>Protect</b>	–
<b>Rotation</b>	–
<b>Resize</b>	–
<b>Trimming</b>	–
<b>Setup</b>	→ See below.

## ■ Setup Menu

<b>Screen</b>	Auto
<b>Info</b>	Off
<b>Screen Lock</b>	Off
<b>Resize before send</b>	3M
<b>Sounds</b>	Startup: On / Half Shutter: On / Shutter: On / Operation: On / Operation Vol: 3 / Playback Vol: 3 / Posing Vol: 3
<b>Timestamp</b>	Off

<b>World Time</b>	–
<b>Adjust</b>	–
<b>Date Style</b>	–
<b>Language</b>	–
<b>HDMI</b>	Auto
<b>WLAN password</b>	–
<b>Startup</b>	Off
<b>Format</b>	–
<b>Reset</b>	–
<b>Version</b>	–

## When things don't go right...

### Troubleshooting

Problem	Possible Cause and Recommended Action
<b>Power Supply</b>	
Power does not turn on.	<ol style="list-style-type: none"><li>1)The battery of new camera is not charged. Charge the battery before using the camera.</li><li>2)The camera battery may be dead. Charge the battery (page 18). If the battery goes dead soon after being charged, it means the battery has reached the end of its life and needs to be replaced. Purchase a separately available CASIO NP-150 rechargeable lithium ion battery.</li></ol>
The camera suddenly powers down.	<ol style="list-style-type: none"><li>1)The camera is designed to turn off automatically after no operation is performed for about five minutes. Turn power back on.</li><li>2)The battery may be dead. Charge the battery (page 18).</li><li>3)The camera's protection function may have activated because camera temperature is too high. Turn off the camera and wait until it cools down before trying to use it again.</li></ol>
Power will not turn off. Nothing happens when a button is pressed.	Remove the battery from the camera and then reload them.
<b>Charging</b>	
The back lamp does not light red and the battery won't charge.	<ol style="list-style-type: none"><li>1)Unplug the USB cable from the camera and then plug it back in again.</li><li>2)Remove the battery from the camera and then reload it (page 19).</li></ol>
<b>Image Recording</b>	
Image is not recorded when the shutter button is pressed.	<ol style="list-style-type: none"><li>1)If the camera is in the PLAY mode, touch "Ⓜ" (REC) to enter the REC mode.</li><li>2)If the message "Memory Full" appears, transfer images to your computer, delete images you no longer need, or use a different memory card.</li></ol>
Auto Focus does not focus properly.	<ol style="list-style-type: none"><li>1)If the lens is dirty, clean it off.</li><li>2)The subject may not be in the center of the focus frame when you compose the image.</li><li>3)You may be moving the camera when shooting. Place the camera on a tabletop or some other stable surface, or find some way to fix the camera in place.</li><li>4)You may be pressing the shutter button all the way without waiting for Auto Focus. Half-press the shutter button and allow enough time for Auto Focus to focus.</li></ol>

Problem	Possible Cause and Recommended Action
The subject is out of focus in the recorded image.	The image may not be focused properly. When composing the image, make sure the subject is located inside the focus frame.
The LED light does not light.	1) If the battery is dead, charge it (page 18). 2) LED light operation is disabled automatically whenever you are shooting with a BEST SHOT scene and HDR Art. Select a different recording mode (page 38).
Camera powers down during Self-timer countdown.	The battery may be dead. Charge the battery (page 18).
The monitor screen image is out of focus.	1) You may be using "Macro" for scenery or portraits. Use Auto Focus for scenery and portrait shots (page 62). 2) You may be trying to use Auto Focus or "Infinity" when shooting a close-up shot. Use the "Macro" for close ups (page 62).
There is digital noise in images.	1) Sensitivity may have been increased automatically for a dark subject, which increases the chance of digital noise. Use a light or some other means to illuminate the subject. 2) Shooting with a snapshot with a high ISO sensitivity setting can increase digital noise in the image. If digital noise becomes a problem, try changing the ISO sensitivity setting to a lower value.
A recorded image was not saved.	1) Camera power may have been turned off before the save operation was complete, which will result in the image not being saved. If the battery indicator shows  , charge the battery as soon as possible (page 18). 2) You may have removed the memory card from the camera before the save operation was complete, which will result in the image not being saved. Do not remove the memory card before the save operation is complete.
Though available lighting is bright, the faces of people in the image are dark.	Not enough light is reaching the subjects. Adjust "Brightness" to the + side (page 59).
Night shots come out bad.	Use the "HS Night Scene" BEST SHOT scene (page 50) when shooting at night.
Subjects are too dark when shooting images in a seashore or ski area.	Sunlight reflected by water, sand, or snow, can cause underexposure of images. Adjust "Brightness" to the + side (page 59).

Problem	Possible Cause and Recommended Action
The image is out of focus during movie recording.	1) Focusing may not be possible because the subject is outside the focus range. Shoot within the allowable range. 2) The lens may be dirty. Clean the lens (page 116). 3) During High Speed Movie recording, focus is fixed at the position where it was when recording started. To focus an image, half-press the shutter button for Auto Focus before you touch "Ⓜ" (Movie) to start recording.
I can't change the settings of menu items. Menu items for some settings are not displayed on the menu.	Some menu items may not be available, depending on the recording mode in use. While Premium Auto Pro is in use, only the menu items whose settings can be configured will be displayed on the menus.
<b>Playback</b>	
The color of the playback image is different from what appears on the monitor screen when shooting.	Sunlight or light from another source may be shining directly into the lens when you are shooting. Position the camera so sunlight does not shine directly into the lens.
Images are not displayed.	This camera cannot display non-DCF images recorded onto a memory card using another digital camera.
Images cannot be rotated.	Note that you cannot edit the following types of snapshots. <ul style="list-style-type: none"> <li>• Snapshots recorded with another camera</li> <li>• Extracted subjects</li> </ul>
<b>File Deletion</b>	
A file cannot be deleted.	The file may be protected. Unprotect the file (page 76).

Problem	Possible Cause and Recommended Action
<b>Wireless LAN</b>	
<p>I can't establish a wireless LAN connection. The wireless LAN connection is broken.</p>	<ol style="list-style-type: none"> <li>1)The camera cannot connect with a smartphone if they are too far apart from each other.</li> <li>2)The smartphone may be connected with another wireless LAN. Check the smartphone's Wi-Fi settings and confirm that the camera is selected for wireless LAN connection (page 82).</li> <li>3)Connection may have been lost due to interference caused by a nearby microwave oven, cordless phone, or other wireless LAN device. Move the camera away from the device causing the problem.</li> </ol>
<b>Other</b>	
<p>The wrong date and time are displayed, or the wrong date and time are being stored along with image data.</p>	<p>The date and time setting is off. Set the correct date and time (page 104).</p>
<p>The messages on the display are in the wrong language.</p>	<p>The wrong display language is selected. Change the display language setting (page 105).</p>
<p>Images cannot be transferred over a USB connection.</p>	<ol style="list-style-type: none"> <li>1)The USB cable may not be connected securely. Check all connections.</li> <li>2)If the camera is not turned on, turn it on.</li> <li>3)Your computer may not be able to recognize the camera if you connect via a USB hub. Always connect directly to the computer's USB port.</li> </ol>
<p>Language selection screen appears when the camera is turned on.</p>	<ol style="list-style-type: none"> <li>1)You did not configure initial settings after purchasing the camera or the camera may have been left with a dead battery. Check the camera setup (pages 24, 104).</li> <li>2)There may be a problem with the camera's memory data. If this is the case, perform the reset operation to initialize the camera's setup (page 107). After that, configure each setting. If the language selection screen does not re-appear when you turn the camera on, it means that the camera's memory management data has been restored. If the same message appears after you turn power back on, contact your retailer or a CASIO authorized service center.</li> </ol>
<p>There are various indicators and values on the monitor screen.</p>	<p>The monitor screen shows indicators and other information about shooting conditions and the image you are recording. You can disable display of indicators and values by selecting "Off" for "Info" on the Setup menu.</p>



Problem	Possible Cause and Recommended Action
The time and date settings configured the first time after purchasing the camera are reset to their factory defaults when I remove the camera's battery.	Load the camera's battery and reconfigure the time and date settings (page 24). Do not remove the battery from the camera for at least 24 hours after configuring time and date settings. After that, the settings will not be reset if you remove the battery. <ul style="list-style-type: none"> <li>If the time and date are reset to their factory default settings when you remove the battery after it has been loaded for more than 24 hours, it could mean that the camera's setting memory is defective. Contact your retailer or a CASIO authorized service center.</li> </ul>
Buttons are not responsive right after the power has been turned on.	With large capacity memory cards there is a delay after the power has been turned on before the buttons become responsive.

## Display Messages

<b>ALERT</b>	The camera's protection function may have activated because camera temperature is too high. Turn off the camera and wait until it cools down before trying to use it again.
<b>Battery is low.</b>	Battery power is low.
<b>Card ERROR</b>	There is something wrong with the memory card. Turn off the camera, remove the memory card and then reload it into the camera. If this message re-appears when you turn the camera back on, format the memory card (page 107). <p> <b>IMPORTANT!</b></p> <ul style="list-style-type: none"> <li>Formatting a memory card deletes all its files. Before formatting, try transferring recoverable files to a computer or some other storage device.</li> </ul>
<b>Communication stopped.</b>	This message appears when the wireless LAN connection is broken for some reason during data communication between the camera and smartphone.
<b>File could not be saved because battery is low.</b>	Battery power is low, so an image file could not be saved.
<b>Folder cannot be created.</b>	You are trying to record a file while there are already 9999 files stored in the 999th folder. If you want to record more, delete files you no longer need (page 34).
<b>LENS ERROR</b>	This message appears and the camera turns off whenever lens performs some unexpected operation. If the same message appears after you turn power back on, contact a CASIO authorized service center or your original retailer.

<b>Memory Full</b>	Memory is full with images you recorded and/or files saved by editing operations. Delete files you no longer need (page 34).
<b>Record Error</b>	Image compression could not be performed for some reason during image data storage. Shoot the image again.
<b>SYSTEM ERROR</b>	Your camera system is corrupted. Contact your retailer or a CASIO authorized service center.
<b>There are no files.</b>	There are no files in built-in memory or on the memory card.
<b>This card is not formatted.</b>	The memory card loaded in the camera is not formatted. Format the memory card (page 107).
<b>This function cannot be used.</b>	This message will appear part way through an operation when you attempt to use a function that is not allowed in combination with another function.

## Number of Snapshots/Movie Recording Time

### Snapshot

Image Size (Pixels)	Approximate File Size	Built-in Memory* <sup>1</sup> Recording Capacity	microSD Memory Card* <sup>2</sup> Recording Capacity
12M (4000×3000)	4.13 MB	7	2286
3M (2048×1536)	1.25 MB	21	6533

## Movies

Image Size / Pixels (Audio)	Approximate Data Rate (Frame Rate)	Maximum File Size	Built-in Memory <sup>*1</sup> Recording Capacity	Maximum Recording Time with microSD Memory Card <sup>*2</sup>	File Size of 1-minute Movie	Continuous Recording Time per Movie <sup>*3</sup>
Full HD 1920×1080 (Monaural)	14.2 Megabits/second (30 frames/second)	4 GB or 29 minutes	26 seconds <sup>*4</sup>	2 hours 14 minutes 55 seconds	106.5 MB	29 minutes
HD 1280×720 (Monaural)	10.9 Megabits/second (30 frames/second)		34 seconds	2 hours 56 minutes 25 seconds	81.8 MB	29 minutes
HS240 512×384 (No audio)	40.0 Megabits/second (240 frames/second)		9 seconds	48 minutes 5 seconds	300.0 MB	12 minutes 58 seconds

\*1 Built-in memory capacity after formatting (Approx. 49.9MB)

\*2 When using a 16GB microSDHC memory card (SanDisk Corporation). Number of image and recording time values depend on the memory card you are using.

\*3 The allowable recording time will be shorter if the capacity of the microSD memory card you are using is smaller than the maximum size of one file.

\*4 The data transfer rate of built-in memory is not sufficient for Full HD movies. Whenever possible use an Ultra High-Speed Type memory card.

- Snapshot and movie recording capacity values are approximate and intended for reference only. Actual capacity depends on image contents.
- File size and data rate values are approximate and intended for reference only. Actual values depend on the type of image being shot.
- When using a memory card with a different capacity, calculate the number of images as a percentage of 16GB.
- The time it takes to play back a high speed movie will be different from the time it takes to record it. If you record a high speed movie for 10 seconds, for example, it will take 80 seconds to play it back.
- Each movie can be up to 29 minutes long. Movie recording stops automatically after 29 minutes of recording.

## Specifications

<b>File Format</b>	Snapshots: JPEG (Exif Version 2.3; DCF 2.0 standard) Movies: MOV format, H.264/AVC standard, IMA-ADPCM (monaural)
<b>Recording Media</b>	Built-in Memory (Image Storage Area: 49.9MB*) microSD/microSDHC/microSDXC * Built-in memory capacity after formatting
<b>Recorded Image Sizes</b>	Snapshots: 12M (4000×3000), 3M (2048×1536) Movies: Full HD (1920×1080 30 fps), HD (1280×720 30 fps), HS240 (512×384 240 fps)
<b>Effective Pixels</b>	11.1 Megapixels
<b>Imaging Element</b>	Size: 1/1.7-inch square pixel high-speed CMOS Total Pixels: 12.76 Megapixels
<b>Lens/Focal Distance</b>	F2.8 f = 4.58 mm (equivalent to 21 mm in 35 mm format)
<b>Zoom</b>	Up to 4.0X when SR zoom and Digital zoom are used in combination Up to 7.8X when SR Zoom, HD Zoom and Digital zoom are used in combination (3M size)
<b>Focusing</b>	Contrast Detection Auto Focus • Focus Modes: Auto Focus, Macro Focus, Pan Focus, Infinity • AF Area: Spot * Intelligent AF area used when Premium Auto Pro is selected.
<b>Approximate Focus Range (Snapshot) (From Lens Surface)</b>	Auto Focus: 8 cm to ∞ (3.1" to ∞) Macro Focus: 8 cm to 50 cm (3.1" to 19.7") Infinity: ∞ Pan Focus : 1 m to ∞ (3.3' to ∞)
<b>Metering</b>	Multi-pattern by imaging element
<b>Exposure Control</b>	Program AE
<b>Exposure Compensation</b>	-2.0 EV to +2.0 EV (in 1/3EV steps)
<b>Shutter</b>	CMOS electronic shutter
<b>Shutter Speed</b>	Snapshot (Auto): 1/20 to 1/16000 second Snapshot (Premium Auto Pro): 1 to 1/16000 second
<b>Aperture Value</b>	F2.8

<b>White Balance</b>	Auto, Daylight, Overcast, Shade, Daywhite Fluorescent, Daylight Fluorescent, Tungsten, Manual WB
<b>Sensitivity (Standard Output Sensitivity)</b>	Snapshots: Auto, ISO 80, ISO 100, ISO 200, ISO 400, ISO 800, ISO 1600, ISO 3200 equivalent Movies: Auto
<b>LED Light</b>	Auto, On, Off
<b>Wireless data transfer</b>	Standard: IEEE 802.11b/g/n Operation frequency range: 1 to 11ch Encryption: WPA2
<b>Monitor Screen</b>	3.0-inch TFT color LCD (Super Clear LCD) 921,600 dots Capacitive type touch panel
<b>External connection terminal</b>	Micro USB port (Hi-Speed USB compliance, USB charging), HDMI output (Micro/TypeD)
<b>Microphones</b>	Monaural
<b>Speaker</b>	Monaural
<b>Power Requirements</b>	Rechargeable lithium ion battery (NP-150) ×1

## Approximate Battery Life

All of the values provided below represent the approximate amount of time under normal temperature (23°C (73°F)) before the camera turns off. These values are not guaranteed. Low temperatures shorten battery life.

<b>Number of snapshots (Operating Time)*<sup>1</sup></b>	240 shots
<b>Actual movie recording time (Full HD movie)*<sup>1</sup></b>	55 minutes
<b>Approximate continuous movie recording time (Full HD Movie)*<sup>2</sup></b>	1 hour 25 minutes
<b>Approximate continuous movie recording time (High speed movie)*<sup>2</sup></b>	1 hour 35 minutes
<b>Continuous Playback (Snapshots)*<sup>3</sup></b>	3 hours 40 minutes

- Temperature: 23°C (73°F)
- Battery: NP-150 (Rated Capacity: 950 mAh)
- Recording Medium: 16GB microSDHC memory card (SanDisk Corporation UHS-I series)

\*1 In accordance with CIPA (Camera and Imaging Products Association) standards

\*2 In accordance with CASIO standards

\*3 One-image scroll approximately every 10 seconds

- The above values are based on a new battery, starting from a full charge. Repeated charging shortens battery life.
- The above values are for reference only. They do not guarantee that the specified battery life will be attained under actual operating conditions.
- Frequency of Auto Focus and High Speed CS usage, configured settings, the amount of time the camera is left turned on, and ambient temperature in the area where the camera is used all greatly affect recording time and number of shots values.

<b>Power Consumption</b>	3.7 V DC, Approximately 3.2 W
<b>Dimensions</b>	126 (W) × 64 (H) × 14.6 (D) mm (4.96" (W) × 2.52" (H) × 0.57" (D)) (14.6 mm (0.57") thick excluding projections)
<b>Weight</b>	Approximately 167 g (5.9 oz) (including battery and memory card*) Approximately 146 g (5.1 oz) (excluding battery and memory card) * 16GB microSDHC memory card (SanDisk Corporation)

## ■ Rechargeable lithium ion battery (NP-150)

<b>Rated Voltage</b>	3.7 V
<b>Rated Capacitance</b>	950 mAh
<b>Operating Temperature Requirements</b>	0 to 40°C (32 to 104°F)
<b>Dimensions</b>	34.2 (W) × 39.8 (H) × 6.9 (D) mm (1.35" (W) × 1.57" (H) × 0.27" (D)) (excluding projections)
<b>Weight</b>	Approximately 20 g (0.7 oz)

## ■ USB-AC adaptor (AD-C53U)

<b>Input</b>	100 to 240 V AC, 50/60 Hz, 100 mA
<b>Output</b>	5.0 V DC, 650 mA
<b>Operating Temperature Requirements</b>	5 to 35°C (41 to 95°F)
<b>Dimensions</b>	53 (W) × 21 (H) × 45 (D) mm (2.1" (W) × 0.83" (H) × 1.8" (D)) (excluding projections)
<b>Weight</b>	Approximately 37 g (1.3 oz)

- Power cord precautions for use in Singapore  
The power cord set is not supplied. The power cord used must comply with relevant national and/or international standards.

FCC marking is a standard conformity mark in the United States.

**GUIDELINES LAID DOWN BY FCC RULES FOR USE OF THIS UNIT IN THE U.S.A. (not applicable to other areas).**

**NOTICE**

This equipment has been tested and found to comply with the limits for a Class B digital device, pursuant to Part 15 of the FCC Rules. These limits are designed to provide reasonable protection against harmful interference in a residential installation. This equipment generates, uses and can radiate radio frequency energy and, if not installed and used in accordance with the instructions, may cause harmful interference to radio communications. However, there is no guarantee that interference will not occur in a particular installation. If this equipment does cause harmful interference to radio or television reception, which can be determined by turning the equipment off and on, the user is encouraged to try to correct the interference by one or more of the following measures:

- Reorient or relocate the receiving antenna.
- Increase the separation between the equipment and receiver.
- Connect the equipment into an outlet on a circuit different from that to which the receiver is connected.
- Consult the dealer or an experienced radio/TV technician for help.

**CAUTION**

Changes or modifications not expressly approved by the party responsible for compliance could void the user's authority to operate the equipment. Proper connectors must be used for connection to host computer and/or peripherals in order to meet FCC emission limits.

**Caution Exposure to radio frequency radiation**

To comply with FCC RF exposure compliance requirements, this device must not be co-located or operating in conjunction with any other antenna or transmitter.

**Declaration of Conformity**

Model Number: EX-TR50  
Trade Name: CASIO  
Responsible party: Industrial Handheld Division  
Casio America, Inc.  
Address: 570 Mt. Pleasant Avenue, Dover, New Jersey 07801, USA  
Telephone number: 973-361-5400



This device complies with Part 15 of the FCC Rules. Operation is subject to the following two conditions: (1) This device may not cause harmful interference, and (2) this device must accept any interference received, including interference that may cause undesired operation.



**CASIO®**

**CASIO COMPUTER CO., LTD.**  
6-2, Hon-machi 1-chome  
Shibuya-ku, Tokyo 151-8543, Japan

## Free Manuals Download Website

<http://myh66.com>

<http://usermanuals.us>

<http://www.somanuals.com>

<http://www.4manuals.cc>

<http://www.manual-lib.com>

<http://www.404manual.com>

<http://www.luxmanual.com>

<http://aubethermostatmanual.com>

Golf course search by state

<http://golfingnear.com>

Email search by domain

<http://emailbydomain.com>

Auto manuals search

<http://auto.somanuals.com>

TV manuals search

<http://tv.somanuals.com>