

ELECTRONIC CASH REGISTER

TE-2400

User's Manual

Introduction

Setting Up

Getting Started

Paper Installation

Set Date/time

Introducing the Terminal

Display/Keyboard

Sheet Holder

Basic Operations & Setups

Registrations

Programs

Advanced Operations

Useful Features

Reports

Troubleshooting

Error Code Table

User Maintenance

Paper Replacement



CI

Canada

CASIO[®]

Introduction & Contents

Important!

Your new cash register has been carefully tested before shipment to ensure proper operation. Safety devices eliminate worries about breakdowns resulting from operator errors or improper handling. In order to ensure years of trouble-free operation, however, the following points should be noted when handling the cash register.

Do not locate the cash register where it will be subjected to direct sunlight, high humidity, splashing with water or other liquids, or high temperature (such as near a heater).

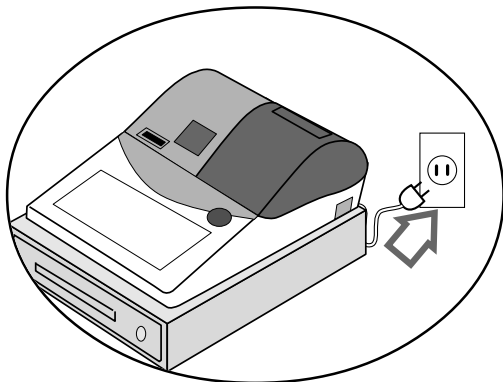
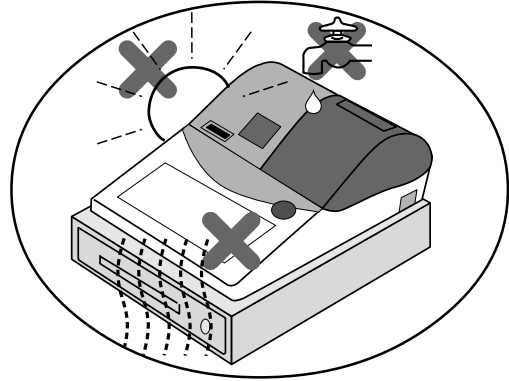

Be sure to check the sticker on the side of the cash register to make sure that its voltage matches that of the power supply in the area.

Never operate the cash register while your hands are wet.

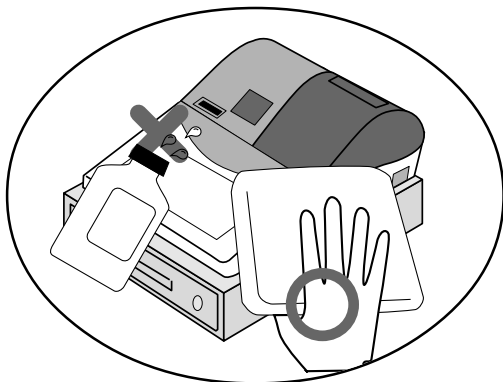
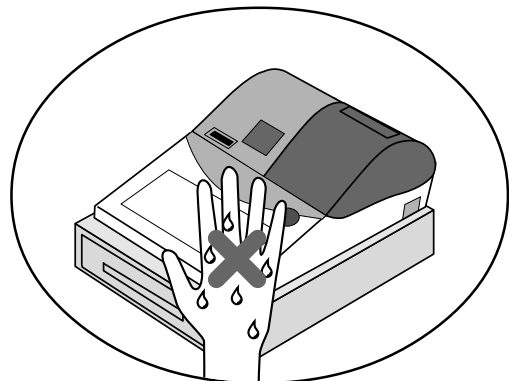

Use a soft, dry cloth to clean the exterior of the cash register. Never use benzene, thinner, or any other volatile agent.

Never try to open the cash register or attempt your own repairs. Take the cash register to your authorized CASIO dealer for repairs.

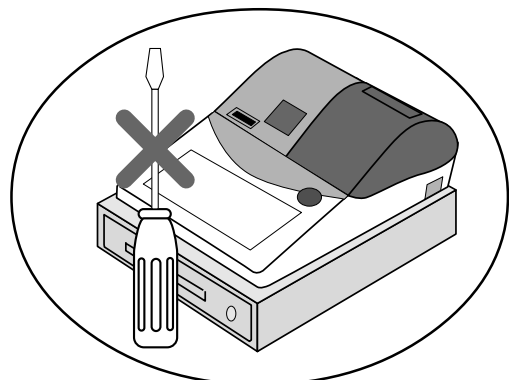

Introduction

Congratulations on your selection of a CASIO TE-2400 electronic cash register. This ECR is the product of the world's most advanced electronic technology, for outstanding versatility and reliability.

Simplified operation is made possible by a specially designed keyboard layout and a wide selection of automated, programmable functions.

A specially designed keyboard layout and a bright, easy-to-read display help to take the fatigue out of long hours operation.

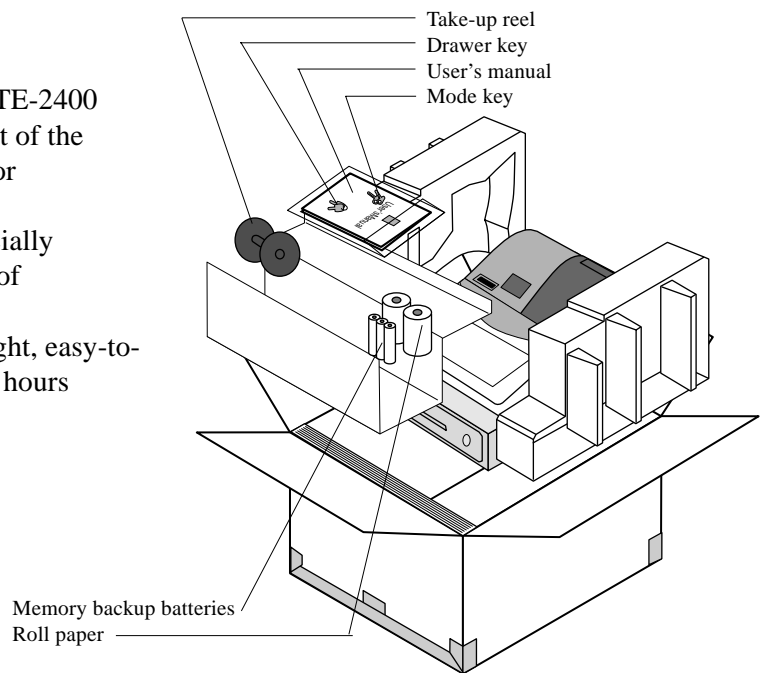

GUIDELINES LAID DOWN BY FCC RULES FOR USE OF THE UNIT IN THE U.S.A. (Not applicable to other areas)

WARNING: This equipment has been tested and found to comply with the limits for a Class A digital device, pursuant to Part 15 of the FCC Rules. These limits are designed to provide reasonable protection against harmful interference when the equipment is operated in a commercial environment. This equipment generates, uses, and can radiate radio frequency energy and, if not installed and used in accordance with the instruction manual, may cause harmful interference to radio communications. Operation of this equipment in a residential area is likely to cause harmful interference in which case the user will be required to correct the interference at his own expense.

FCC WARNING: Changes or modifications not expressly approved by the party responsible for compliance could void the user's authority to operate the equipment.

Please keep all information for future reference.

The main plug on this equipment must be used to disconnect mains power.
Please ensure that the socket outlet is installed near the equipment and shall be easily accessible.

CAUTION
RISK OF EXPLOSION IF BATTERY IS REPLACED BY AN INCORRECT TYPE.
DISPOSE OF USED BATTERIES ACCORDING TO THE INSTRUCTIONS.

Safety Precautions

- To use this product safely and correctly, read this manual thoroughly and operate as instructed.
After reading this guide, keep it close at hand for easy reference.
Please keep all informations for future reference.
- Always observe the warnings and cautions indicated on the product.

About the icons

In this guide various icons are used to highlight safe operation of this product and to prevent injury to the operator and other personnel and also to prevent damage to property and this product. The icons and definitions are given below.



Indicates that there is a risk of severe injury or death if used incorrectly.



Indicates that injury or damage may result if used incorrectly.

Icon examples

To bring attention to risks and possible damage, the following types of icons are used.



The \triangle symbol indicates that it includes some symbol for attracting attention (including warning). In this triangle the actual type of precautions to be taken (electric shock, in this case) is indicated.



The \otimes symbol indicates a prohibited action. In this symbol the actual type of prohibited actions (disassembly, in this case) will be indicated.



The \bullet symbol indicates a restriction. In this symbol the type of actual restriction (removal of the power plug from an outlet, in this case) is indicated.

Warning!

Handling the register



Should the register malfunction, start to emit smoke or a strange odor, or otherwise behave abnormally, immediately shut down the power and unplug the AC plug from the power outlet. Continued use creates the danger of fire and electric shock.

- Contact CASIO service representative.



Do not place containers of liquids near the register and do not allow any foreign matter to get into it. Should water or other foreign matter get into the register, immediately shut down the power and unplug the AC plug from the power outlet. Continued use creates the danger of shorting, fire and electric shock.

- Contact CASIO service representative.



Should you drop the register and damage it, immediately shut down the power and unplug the AC plug from the power outlet. Continued use creates the danger of shorting, fire and electric shock.

- Attempting to repair the register yourself is extremely dangerous. Contact CASIO service representative.
-

⚠ Warning!



Never try to take the register apart or modify it in any way. High-voltage components inside the register create the danger of fire and electric shock.

- Contact CASIO service representative for all repair and maintenance.

Power plug and AC outlet



Use only a proper AC electric outlet (100V~240V) . Use of an outlet with a different voltage from the rating creates the danger of malfunction, fire, and electric shock. Overloading an electric outlet creates the danger of overheating and fire.



Make sure the power plug is inserted as far as it will go. Loose plugs create the danger of electric shock, overheating, and fire.

- Do not use the register if the plug is damaged. Never connect to a power outlet that is loose.



Use a dry cloth to periodically wipe off any dust built up on the prongs of the plug. Humidity can cause poor insulation and create the danger of electric shock and fire if dust stays on the prongs.



Do not allow the power cord or plug to become damaged, and never try to modify them in any way. Continued use of a damaged power cord can cause deterioration of the insulation, exposure of internal wiring, and shorting, which creates the danger of electric shock and fire.

- Contact CASIO service representative whenever the power cord or plug requires repair or maintenance.

⚠ Caution!



Do not place the register on an unstable or uneven surface. Doing so can cause the register — especially when the drawer is open — to fall, creating the danger of malfunction, fire, and electric shock.



Do not place the register in the following areas.

- Areas where the register will be subject to large amounts of humidity or dust, or directly exposed to hot or cold air.
- Areas exposed to direct sunlight, in a close motor vehicle, or any other area subject to very high temperatures.

The above conditions can cause malfunction, which creates the danger of fire.



Do not overlay bend the power cord, do not allow it to be caught between desks or other furniture, and never place heavy objects on top of the power cord. Doing so can cause shorting or breaking of the power cord, creating the danger of fire and electric shock.



Be sure to grasp the plug when unplugging the power cord from the wall outlet. Pulling on the cord can damage it, break the wiring, or cause short, creating the danger of fire and electric shock.



Never touch the plug while your hands are wet. Doing so creates the danger of electric shock. Pulling on the cord can damage it, break the wiring, or cause short, creating the danger of fire and electric shock.

Never touch the printer head and the platen.

Introduction & Contents

Introduction & Contents	2
Getting Started	10
Remove the cash register from its box.	10
Remove the tape holding parts of the cash register in place.	10
Install the three memory backup batteries.	10
Install receipt/journal paper.	12
Plug the cash register into a wall outlet.	14
Insert the mode key marked "PGM" into the mode switch.	14
Turn the mode key to the "REG" position.	14
Set the date.	15
Set the time.	15
Tax table programming	16
Introducing TE-2400	20
General guide	20
Display	22
Keyboard	24
Allocatable functions	26
Basic Operations and Setups	28
How to read the printouts	28
How to use your cash register	29
Assigning a clerk	30
Clerk secret number key	30
Displaying the time and date	31
To display and clear the date/time	31
Preparing coins for change	31
Preparing and using department/flat-PLU keys	32
Registering department/flat-PLU keys	32
Programming department/flat-PLU keys	33
To program a unit price for each department/flat-PLU	33
To program the tax calculation status for each department/flat-PLU	33
To program high amount limit for each department/flat-PLU	34
Registering department/flat-PLU keys by programming data	35
Preset price	35
Preset tax status	35
Locking out high amount limitation	35
Preparing and using PLUs	36
Programming PLUs	36
To program a unit price for each PLU	36
To program tax calculation status for each PLU	36
Registering PLUs	37
Shifting the taxable status of an item	39
Calculation merchandise subtotal	39
Preparing and using discounts	40
Programming discounts	40
Registering discounts	40
Discount for items and subtotals	40
Preparing and using reductions	41
Programming for reductions	41
To program preset reduction amount	41
Registering reductions	41
Reduction for items	41
Reduction for subtotal	42
Registering credit and check payments	43
Check	43
Charge	43
Mixed tender (cash, charge and check)	43

Registering returned goods in the REG mode	44
Registering returned goods in the RF mode	44
Normal refund transaction	44
Reduction of amounts paid on refund	45
Registering money received on account	45
Registering money paid out	45
Making corrections in a registration	46
To correct an item you input but not yet registered	46
To correct an item you input and registered	47
To cancel all items in a transaction	48
No sale registration	48
Printing the daily sales reset report	49
Advanced Operations	50
Stock check	50
Clerk interrupt function	50
Single item cash sales	51
Addition	52
Addition (plus)	52
Premium (%+)	53
Tray total	54
Tray total premium/discount	54
Multiple item totalling function	54
Coupon transactions	55
Coupon registration using <COUPON> (coupon key)	55
Coupon registration using <COUPON2> (coupon 2 key)	55
Preset tender amount	56
Registering loan amounts	56
Registering pick up amounts	57
Changing media in drawer	57
Bottle link operation	58
Bottle returns	58
Bottle return key	58
Arrangement key registrations	59
Set menu	59
Currency exchange function	60
Registering foreign currency	60
Full amount tender in foreign currency	60
Partial tender in a foreign currency	61
Food stamp function	62
Food stamp registration	62
No change due	62
Mixed food stamp/cash change	63
Food stamp registration (Illinois rule)	65
No change due	65
Mixed food stamp/cash change	67
Electronic benefits transfer	69
About mixed EBT card tenders	69
No change due	69
Tips	70
Inputting the number of customers	71
Temporarily releasing compulsion	72
Text recall	72
Printing slip	73
Printing slips	73

Introduction & Contents

To perform auto batch printing 1	74
To perform auto batch printing 2	74
About the maximum number of slip lines	74
Check tracking systems	74
Check tracking system	74
Opening a check	75
Adding to a check	75
Issuing a guest receipt	76
Closing a check memory	76
New/old check key operation	77
Add check	78
Separate check	79
Price reductions (red price)	80
Condiment/preparation PLUs	81
VAT breakdown printing	82
Actual stock quantity inquiry	82
Unit price inquiry	82
Bill copy	83
Deposit registrations	83
Deposit from customer	83
Deposit from customer during sales transaction	83
Previous item void using <review>	84
Scanning PLU	85
Item registration	85
By scanner/code input/one touch NLU key	85
Not found PLU	85
Programming to clerk	86
Programming clerk number	86
Programming trainee status	86
Programming commission rate	86
Programming descriptors and messages	87
Programming receipt message, machine No. and clerk name	87
Programming department/transaction key descriptor	89
Programming flat-PLU descriptor	90
Entering characters	91
Using character keyboard	91
Entering characters by code	92
Character code list	92
Editing characters	93
Correcting a character just entered	93
Correcting and adding a PLU descriptor already set	93
Correcting a key descriptor already set	93
Correcting a message descriptor already set	93
Printing read/reset reports	94
To print the individual department, PLU/flat-PLU read report	94
To print the financial read report	95
To print the individual clerk read/reset report	95
To print the daily sales read/reset report	96
To print the PLU/flat-PLU read/reset report	98
To print the hourly sales read/reset report	98
To print the monthly sales read/reset report	99
To print the group read/reset report	99
To print the periodic 1/2 sales read/reset reports	100
To print other sales read/reset reports	102
Reading the cash register's program	103
To print unit price/rate program (except PLU/scanning PLU)	103

To print key descriptor, name, message program (except PLU)	104
To print the PLU/flat-PLU program	105
Troubleshooting	106
When an error occurs	106
Clearing a machine lock up	108
When the register does not operate at all	108
In case of power failure	109
User Maintenance and Options	110
To replace journal paper	110
To replace receipt paper	111
Options	111
Specifications	112
Index	113

Getting Started

This section outlines how to unpack the cash register and get it ready to operate. You should read this part of the manual even if you have used a cash register before. The following is the basic set up procedure, along with page references where you should look for more details.

1. Remove the cash register from its box.

Make sure that all of the parts and accessories are included.

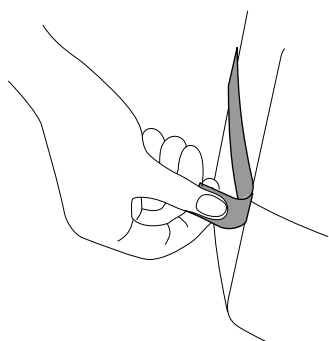
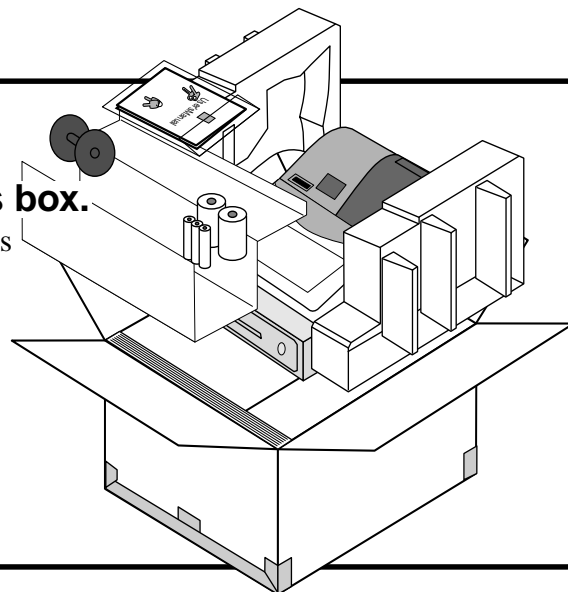

2. Remove the tape holding parts of the cash register in place.

Also remove the small plastic bag taped to the printer cover. Inside you will find the mode keys.

3. Install the three memory backup batteries.

1. Remove the printer cover and open the platen arm.



printer cover

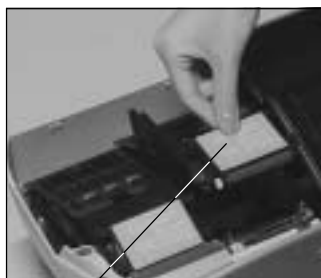

platen arm

2. Remove the battery compartment cover. Slide the cover and pull it up.



battery compartment cover



3. Note the (+) and (-) markings in the battery compartment. Load a set of three new SUM-3 (UM-3) batteries so that their positive (+) and negative (-) ends are facing as indicated by the markings.



4. Replace the battery compartment cover.

5. Close the platen arm and replace the printer cover.

Important!

These batteries protect information stored in your cash register's memory when there is a power failure or when you unplug the cash register. Be sure to install these batteries.

Precaution!

Incorrectly using batteries can cause them to burst or leak, possibly damaging the interior of the cash register. Note the following.

- Be sure that the positive (+) and negative (-) ends of the batteries are facing as marked in the battery compartment when you load them into the unit.
- Never mix batteries of different types.
- Never mix old batteries with new ones.
- Never leave dead batteries in the battery compartment.
- Remove the batteries if you do not plan to use the cash register for long periods.
- Replace the batteries at least once a year, no matter how much the cash register is used during the period.

WARNING!

- Never try to recharge the batteries supplied with the unit.
- Do not expose batteries to direct heat, let them become shorted or try to take them apart.
Keep batteries out of the reach of small children. If your child should swallow a battery, consult a physician immediately.

4. Install receipt/journal paper.

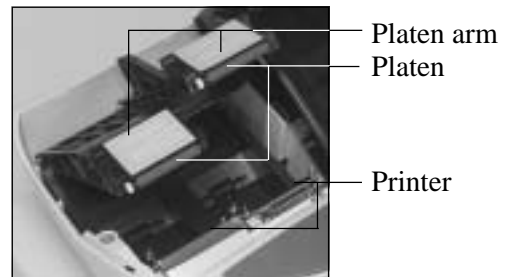

Important!

Take away the head protection sheet from the printer and close the platen arm.

Caution! (in handling the thermal paper)

- Never touch the printer head and the platen.
- Unpack the thermal paper just before your use.
- Avoid heat/direct sunlight.
- Avoid dusty and humid places for storage.
- Do not scratch the paper.
- Do not keep the printed paper under the following circumstances:
High humidity and temperature/direct sunlight/contact with glue, thinner or a rubber eraser.

To install receipt paper



Step 1

Remove the printer cover.



Step 4

Put the leading end of the paper over the printer.



Step 2

Open the platen arm.



Step 5

Close the platen arm slowly until it locks steadily.



Step 3

Ensuring the paper is being fed from the bottom of the roll, lower the roll into the space behind the printer.



Complete

Replace the printer cover, passing the leading end of the paper through the cutter slot. Tear off the excess paper.

To install journal paper



Step 1
Remove the printer cover.



Step 2
Open the platen arm.



Step 7
Slide the leading end of the paper into the groove on the spindle of the take-up reel and wind it onto the reel two or three turns.

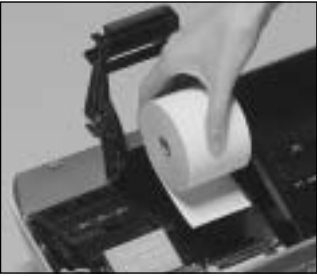

Step 3
Ensuring the paper is being fed from the bottom of the roll, lower the roll into the space behind the printer.



Step 8
Replace the paper guide of the take-up reel.



Step 4
Put the leading end of the paper over the printer.



Step 9
Place the take-up reel into place behind the printer, above the roll paper.



Step 5
Close the platen arm slowly until it locks steadily.



Step 10
Press the **JOURNAL FEED** key to take up any slack in the paper.

During machine installation, press the **JOURNAL FEED** key after power on.



Step 6
Remove the paper guide of the take-up reel.



Complete
Replace the printer cover.

5. Plug the cash register into a wall outlet.

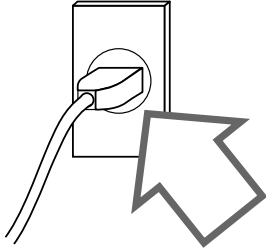

Be sure to check the sticker (rating plate) on the side of the cash register to make sure that its voltage matches that of the power supply in your area.

6. Insert the mode key marked "PGM" into the mode switch.

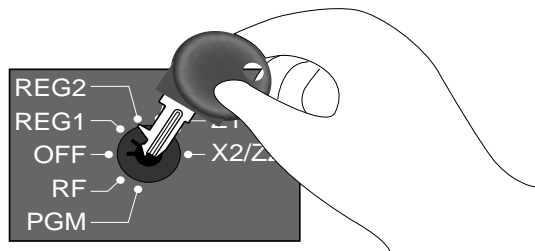

7. Turn the mode key to the "REG" position.

The display should change to the following.

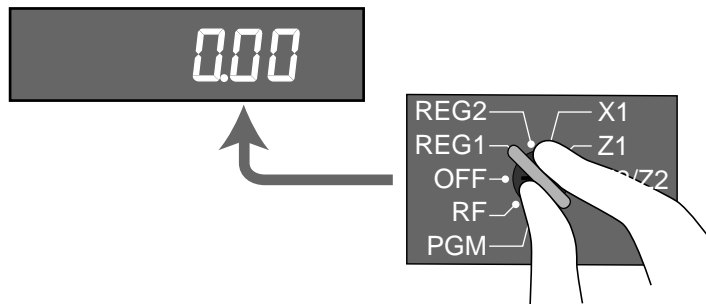

8. Set the date.

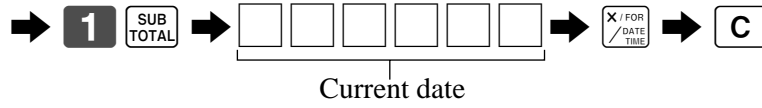
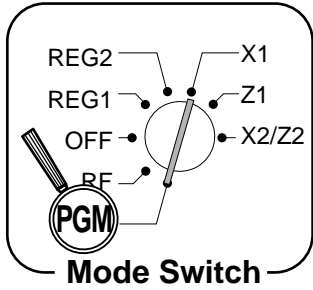

Example:

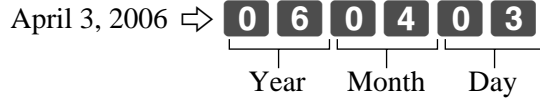

9. Set the time.

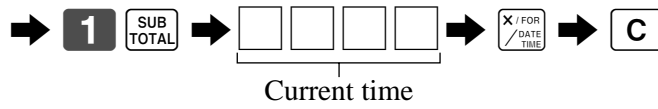
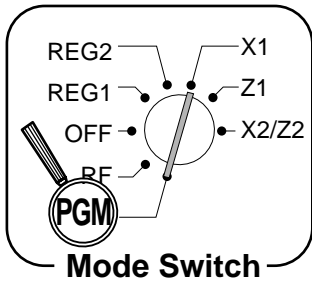

Example:

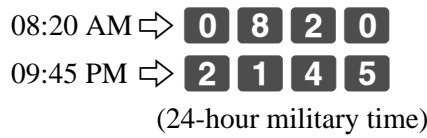

10. Tax table programming

Important!

After you program the tax tables, you also have to individually specify which departments (page 36) and PLUs (page 39) are to be taxed.

For this cash register to be able to automatically register state sales tax, you must program its tax tables with tax calculation data from the tax table for your state. There are three (U.S.)/ four (Canada) tax tables that you can program for automatic calculation of separate sales taxes.

Programming procedure

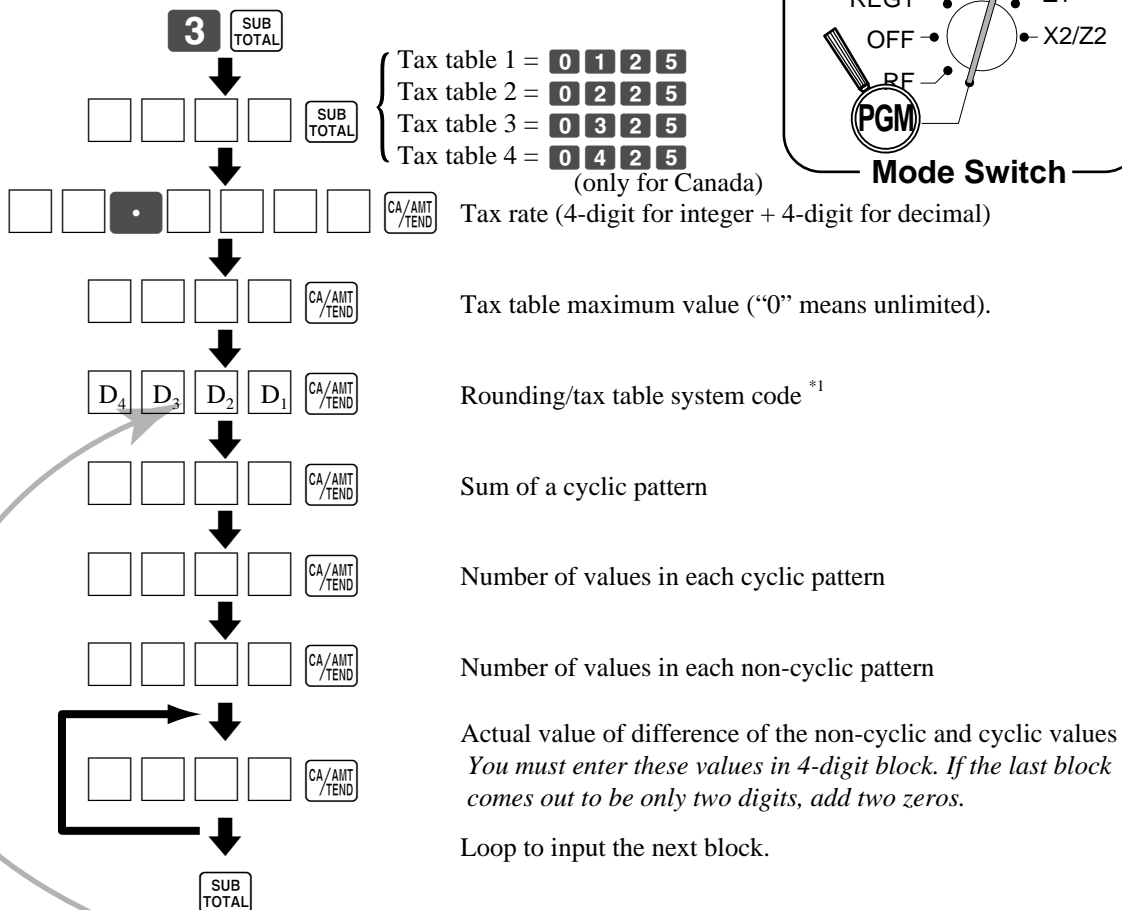

^{*1} Rounding/tax table system code

Rounding code specification

D ₄	D ₃	Rounding
5	0	Rounding off two decimal places
9	0	Rounding up to two decimal places
0	0	Cut off to two decimal places

Tax system code specification

D ₂	D ₁	Rounding
0	1	Tax table only
0	2	U.S. tax table with tax rate or add-on tax rate only
0	3	Add-in tax rate
0	4	Canadian tax system (Tax-on-tax)

Canadian tax system

For both add-on and add-in tax systems.

To program Tax-on-tax system, you must use the tax address "0225", "0325" or "0425."

Tax table programming (continued...)

Programming U.S. tax tables

Before you can program a U.S. tax table, you must first calculate the program data.

The partial tax table shown below is for a tax rate of 6%. A tax amount is applied for each price range, which is defined by a low end minimum break point. If you subtract each maximum break point from the next lower maximum break point, you should soon be able to see certain patterns. In a cyclic pattern, the differences in maximum breakpoints form a regularly repeating cycle. A pattern which does not fit the cyclic pattern is called non-cyclic pattern.

Though rate, it is conceivable that you can find that subtracting maximum breakpoints results in an one big non-cyclic pattern. In this case, you won't be able to use automatic tax calculation, and must enter the tax for each transaction manually or use a tax rate.

Example 1, Add-on rate tax:

Programming procedure:

Tax rate (2-digit for integer + 4- digit for decimal)	8.25%	
Tax table maximum value ("0" means unlimited).	0 (no limitation)	
Rounding/tax table system code	5002 (Round off)	
Sum of a cyclic pattern	0	} No need to enter.
Number of values in each cyclic pattern	0	
Number of values in each non-cyclic pattern	0	
Actual value of difference of the non-cyclic and cyclic values	0	

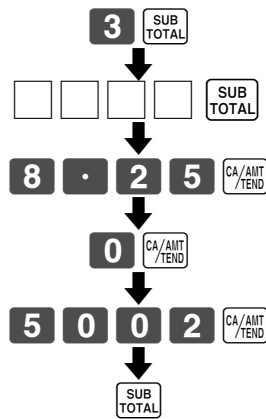
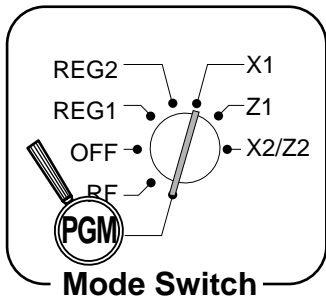

- Tax table 1 = 0 1 2 5
- Tax table 2 = 0 2 2 5
- Tax table 3 = 0 3 2 5

Tax rate (2-digit for integer + 4-digit for decimal)

Tax table maximum value ("0" means unlimited).

Rounding/tax table system code

Getting Started

Tax table programming (continued...)

Example 2, Without rate tax:

Preparation

TAX (6%)	Price range		Max. break point		Difference	Pattern
	Min. break point	Max. break point	Upper	Lower		
\$.00	\$.01	\$.10	10	0	10	Non-cyclic
.01	.11	.24	24	10	14	
.02	.25	.41	41	24	17	Cyclic
.03	.42	.58	58	41	17	
.04	.59	.74	74	58	16	
.05	.75	.91	91	74	17	Cyclic
.06	.92	1.08	108	91	17	
.07	1.09	1.24	124	108	16	
			124		17	

Tax rate (2-digit for integer + 4-digit for decimal) 0% (Table only)
 Tax table maximum value ("0" means unlimited). 0 (Table only)
 Rounding/tax table system code 01 (Table only)
 Sum of a cyclic pattern 50 (17 + 17 + 16)
 Number of values in each cyclic pattern 3
 Number of values in each non-cyclic pattern 24 (10 + 14)
 Actual value of difference of the non-cyclic and cyclic values 10, 14, 17, 17, 16

Programming procedure:

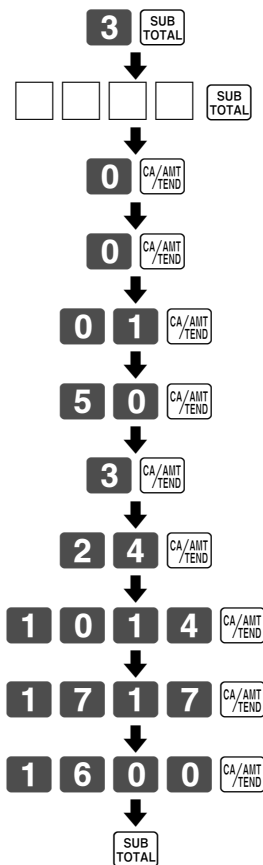
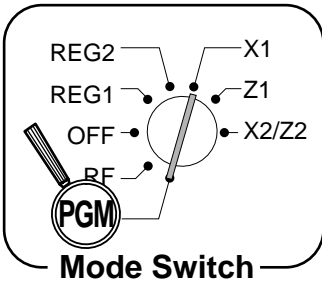

Tax table 1 = 0 1 2 5
 Tax table 2 = 0 2 2 5
 Tax table 3 = 0 3 2 5

Tax rate (2-digit for integer + 4-digit for decimal)
 Tax table maximum value ("0" means unlimited).
 Rounding/tax table system code
 Sum of a cyclic pattern
 Number of values in each cyclic pattern
 Number of values in each non-cyclic pattern
 Actual value of difference of the non-cyclic and cyclic values

You must enter these values in 4-digit block. If the last block comes out to be only two digits, add two zeros.

Tax table programming (continued...)

Example 3, With rate tax:

Preparation:

TAX (7%)	Price range		Max. break point		Difference	Pattern
	Min. break point	Max. break point	Upper	Lower		
\$.00	\$.01	\$.07	7	0	7	Non-cyclic
.01	.08	.21	21	7	14	Cyclic
.02	.22	.35	35	21	14	
.03	.36	.49	49	35	14	
.04	.50	.64	64	49	15	
.05	.65	.78	78	64	14	
.06	.79	.92	92	78	14	
.07	.93	1.07	107	92	15	
.08	1.08	1.21	121	107	14	Cyclic
.09	1.22	1.35	135	121	14	
.10	1.36	1.49	149	135	14	
.11	1.50	1.64	164	149	15	
.12	1.65	1.78	178	164	14	
.13	1.79	1.92	192	178	14	
.14	1.93	2.07	207	192	15	
1.40	19.93	20.07				

On all sales above \$20.07, compute the tax at the rate of 7%.

Tax rate (2-digit for integer + 4- digit for decimal) ----- 7%

Tax table maximum value ("0" means unlimited). ----- 2007

Rounding/tax table system code ----- 0002 (Cut off & table + rate)

Sum of a cyclic pattern ----- 100 (14+14+14+15+14+14+15)

Number of values in each cyclic pattern ----- 7

Number of values in each non-cyclic pattern ----- 7

Actual value of difference of the non-cyclic and cyclic values ----- 14, 14, 14, 15, 14, 14, 15

Programming procedure:

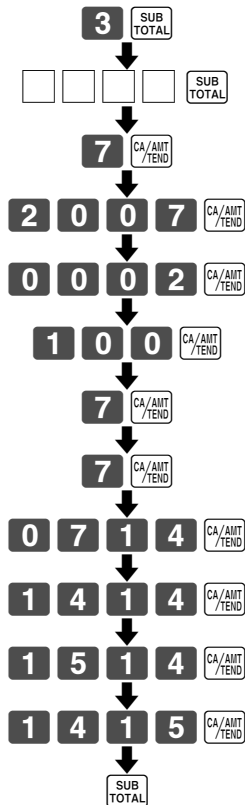
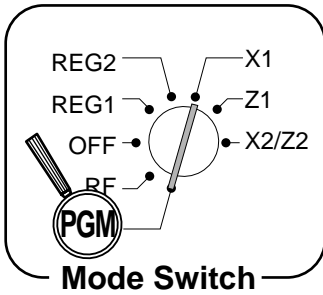

Tax table 1 = 0 1 2 5
 Tax table 2 = 0 2 2 5
 Tax table 3 = 0 3 2 5

Tax rate (2-digit for integer + 4-digit for decimal)

Tax table maximum value ("0" means unlimited).

Rounding/tax table system code

Sum of a cyclic pattern

Number of values in each cyclic pattern

Number of values in each non-cyclic pattern

Actual value of difference of the non-cyclic and cyclic values

You must enter these values in 4-digit block. If the last block comes out to be only two digits, add two zeros.

Introducing TE-2400

General guide

This part of the manual introduces you to the cash register and provides a general explanation of its various parts.

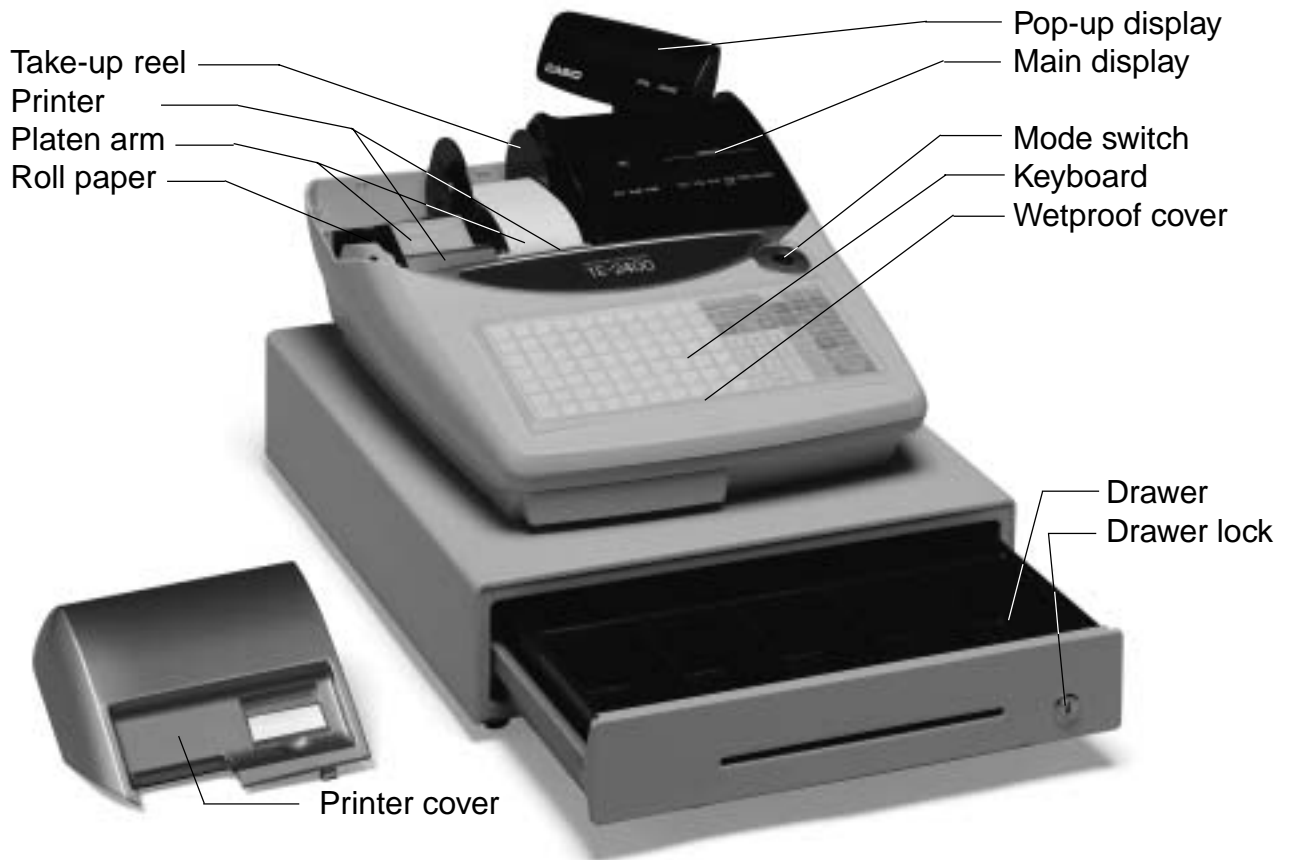

Roll paper

You can use the roll paper to print receipts and a journal (pages 12 ~ 13).

Receipt on/off key

Use the receipt on/off key in REG1, REG2 and RF modes to control issuance of receipts. In other modes, receipts or reports are printed regardless the receipt key setting.

A post-finalization receipt can still be issued after finalization when the key is set to off. The cash register can also be programmed to issue a post-finalization receipt even when the key is set to on.

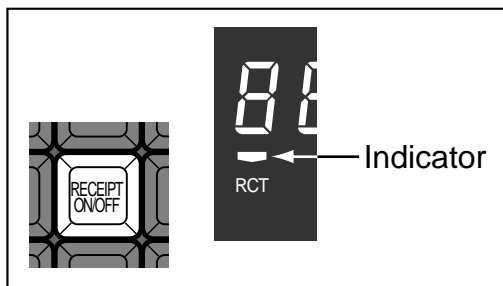

When the register issues receipts, this indicator is lit.

Mode key

The following four types of mode keys are provided with the unit.

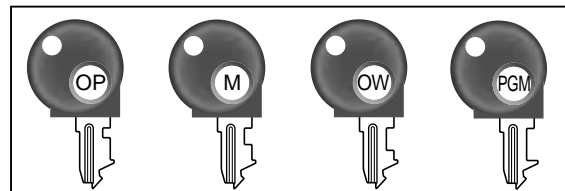

- OP (Operator) key
Switches between OFF and REG1.
- M (Master) key
Switches between OFF, REG1, REG2, X1 and RF.
- OW (Owner) key
Switches between OFF, REG1, REG2, X1, Z1, X2/Z2 and RF.
- PGM (Program) key
Switches to any position.

Mode switch

Use the mode keys to change the position of the mode switch and select the mode you want to use.

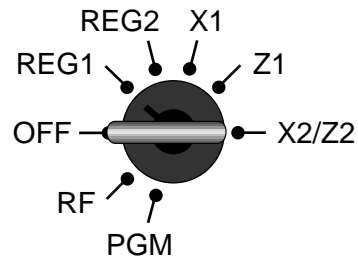

Mode switch	Mode name	Description
OFF	Stand-by	Any of the mode control keys can be inserted and removed from the mode switch in this position.
REG1	Register 1	Used for normal sales transactions. Any of the mode control keys can be inserted and removed from the mode switch in this position.
REG2	Register 2	Used for special operations. Since switching to REG2 requires a special key, such functions as discounts, credit sales, charge sales, check payments, and paid outs can be controlled by programming them as prohibited in REG1 and allowed in REG2.
RF	Refund Reg minus	Used for processing refunds. When the mode switch of the register is in RF position, you can access either the refund mode or the register minus mode.
X1	Daily sales read	Used to obtain daily reports without resetting (clearing) all total data.
Z1	Daily sales reset	Used to obtain daily reports while resetting (clearing) all total data.
X2/Z2	Periodic sale read/ reset	Used to obtain periodic sales reports without resetting total data or while resetting all total data.
PGM	Program	Used when programming functions and preset data such as unit prices and tax rates. Also used when reading program data.

Clerk key

Clerk or cashier assignment can be performed using clerk secret numbers only (clerk buttons are not equipped).

Clerk secret number key

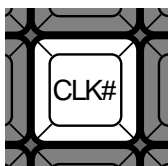

Drawer

The drawer opens automatically whenever you finalize a registration and whenever you issue a read or reset report.

Drawer lock

Use the drawer key to lock and unlock the drawer.

Introducing TE-2400

Display

Display panel

Main display



Customer display



When the cash drawer does not open!

In case of power failure or the machine is in malfunction, the cash drawer does not open automatically. Even in these cases, you can open the cash drawer by pulling drawer release lever (see below).

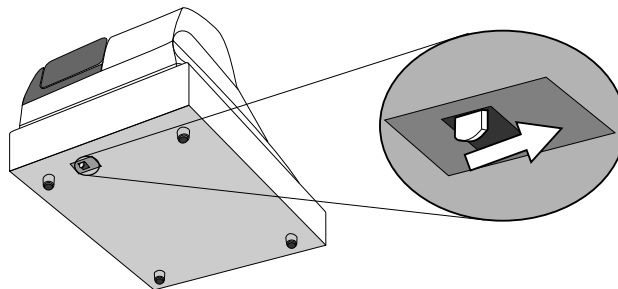

Important!

The drawer will not open, if it is locked with a drawer lock key.

Display example

Item registration

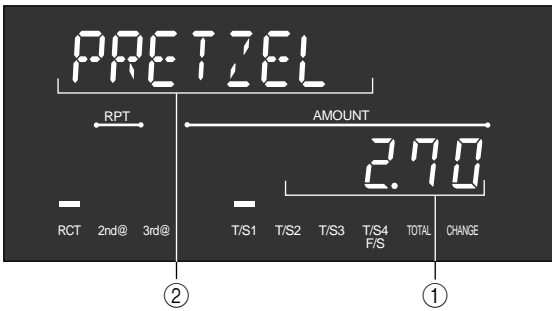

① **Amount/Quantity**

This part of the display shows monetary amounts. It also can be used to show the current time.

② **Item descriptor**

When you register a department/PLU/scanning PLU, the item descriptor appears here.

③ **Number of repeats**

Anytime you perform a repeat registration (pages 32, 37), the number of repeats appears here. Note that only one digit is displayed for the number of repeats. This means that a “5” could mean 5, 15 or even 25 repeats.

Repeat registration

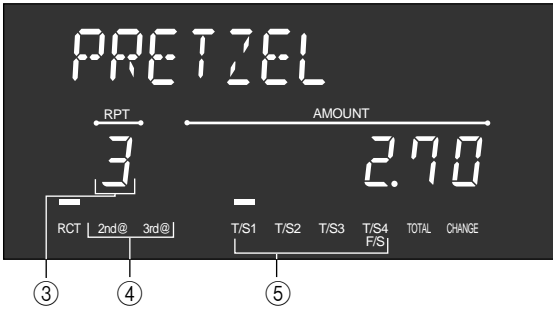

④ **2nd, 3rd menu indicator**

When you press  to designate the 2nd/3rd unit price, the corresponding number is displayed.

⑤ **Taxable / Food stampable sales status indicators**

When you register a taxable / food stampable item, the corresponding indicator is lit.

⑥ **Change descriptor/amount**

⑦ **Total/Change indicators**

When the TOTAL indicator is lit, the displayed value is monetary total or subtotal amount. When the CHANGE indicator is lit, the displayed value is the change due.

⑧ **RCT indicator**

When the register issues receipts, this indicator is lit.

Totalize operation

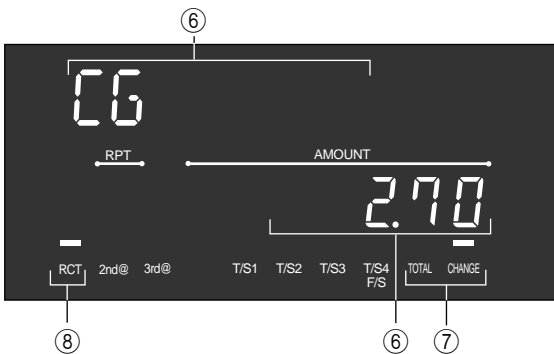



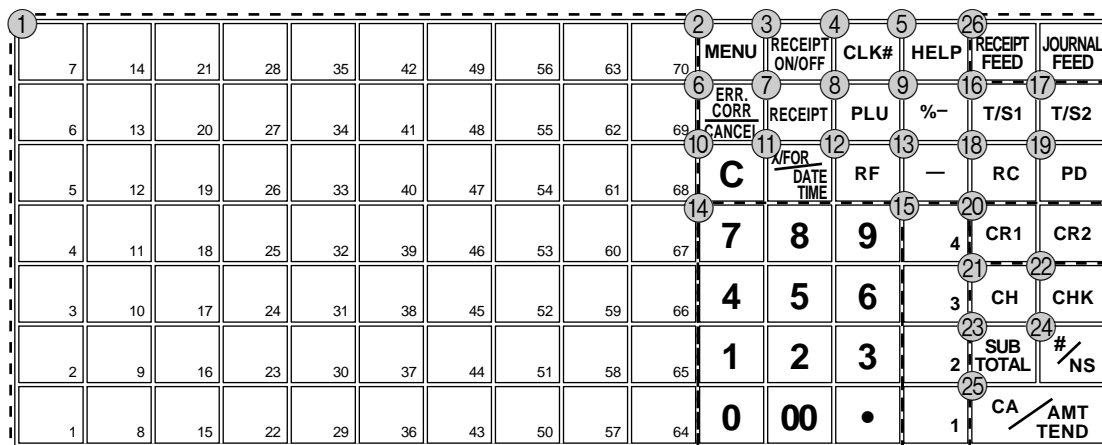

Introducing TE-2400

Keyboard



• Register Mode

- ① **Flat PLU key** 001, 002, ~
Use these keys to register items to flat PLUs.
- ② **Menu shift key** MENU SHIFT
Use this key to shift key to the 1st ~ 6th menu.
- ③ **Receipt on/off key** RECEIPT ON/OFF
Use this key twice to change the status “receipt issue” or “no receipt.” In case of “receipt issue”, the indicator is lit.
- ④ **Clerk number key** CLK#
Use this key to sign clerk on and off the register.
- ⑤ **Help key** HELP
Use this key to look up the procedures to set date/time, tax table etc.
- ⑥ **Error correction/Cancellation key** ERR CORR CANCEL
Use this key to correct registration errors and to cancel registration of entire transactions.
- ⑦ **Post receipt key** RECEIPT
Press this key to produce a post-finalization receipt.
- ⑧ **PLU key** PLU
Use this key to input PLU numbers.
- ⑨ **Discount key** %-
Use this key to register discounts.
- ⑩ **Clear key** C
Use this key to clear an entry that has not yet been registered.
- ⑪ **Multiplication/For/Date/Time key** X / FOR DATE TIME
Use this key to input a quantity for a multiplication operation and registration of split sales of packaged items. Between transactions, this key displays the current time and date.
- ⑫ **Refund key** RF
Use this key to input refund amounts and void certain entries.
- ⑬ **Minus key** -
Use this key to input values for subtraction.
- ⑭ **Ten key pad** 0, 1 ~ 9, 00, .
Use these keys to input numbers.
- ⑮ **Department keys** 1, 2, 3 ~ 4
Use these keys to register items to departments.
- ⑯ **Tax status shift 1 key** T/S1
Use this key to change the Taxable 1 status of the next item.
- ⑰ **Tax status shift 2 key** T/S2
Use this key to change the Taxable 2 status of the next item.
- ⑱ **Received on account key** RC
Use this key following a numeric entry to register money received for non-sale transactions.
- ⑲ **Paid out key** PD
Use this key following a numeric entry to register money paid out from the drawer.
- ⑳ **Credit key** CR1, CR2
Use this key to register a credit sale.
- ㉑ **Check key** CHK
Use this key to register a check tender.
- ㉒ **Charge key** CH
Use this key to register a charge sale.

-
- ⑳ **Subtotal key**  Use this key to display and print the current subtotal (includes add-on tax) amount.
- ㉑ **Non-add/No sale key**  Non-add key: To print reference number (to identify a personal check, credit card, etc.) during a transaction, use this key after some numerical entries.
No sale key: Use this key to open the drawer without registering anything.
- ㉒ **Cash/Amount tendered key**  Use this key to register a cash tender.
- ㉓ **Paper feed key** ,  Hold this key down to feed paper from the printer.

Allocatable functions

You can tailor a keyboard to suit your particular type of business.

Add check

Use this key in a check tracking system to combine the details of more than one check into a single check.

Arrangement

Use this key to activate an arrangement program programmed in the arrangement file. Any operation that can be performed from the keyboard, as well as mode, can be programmed in an arrangement program, and can be performed merely by pressing this key. In addition, one numeric entry can be included in an arrangement program. In this case, input the number and press this key.

The mode control function of this key can be programmed for all modes except for the OFF and PGM mode.

Bill copy

Use this key to issue bill copy.

Bottle return

Use this key to specify next item as bottle return.

Cancel

Invalidates all preceding data registered for departments, PLUs and set menus within a transaction. This key must be pressed before the transaction involving the data to be invalidated is finalized. It is also effective even after calculation of subtotal amount.

Check endorsement

Use this key to print a preset check endorsement message using the slip printer.

Check print

Use this key to print the check on the slip printer.

Clock-in/-out

Use this key to register the time when the employees start/finish their job.

Coupon

Use this key for registering coupons.

Coupon 2

Use this key to declare the next item registration as coupon.

Cube

This key provides the same functions as the Square key. In addition, this key also has a cube multiplication function.

Currency exchange

Use this key to convert foreign currency to local currency or vice versa using the exchange rate preset for the key and displays the result.

Use this key for conversions of a home currency subtotal or merchandise subtotal to equivalent of another country's currency.

Use this key for conversions of another country's currency to the equivalent of the home currency.

Customer number

Use this key to register the number of customers.

Declaration

Use this key to declare in drawer amount for money declaration.

Deposit

Use this key to register deposits.

Eat-in

Use this key to specify if the customer eats in the restaurant. Before closing a transaction press this key.

EBT (electronic benefit transfer)

Use this key to register an EBT amount with a tender amount input.

Food stamp shift

Use this key to change food stamp status.

Food stamp subtotal

Use this key to obtain the food stamp applicable amount.

Food stamp tender

Use this key to register a food stamp payment amount with a tender amount input.

Loan

This key is used to input the amount of money provided for making change. This operation affects media totals, rather than sales totals. Loans are made for all types of money which can be specified by the finalize key.

Manual tax

Use this key to register a tax amount.

Media change

Use this key to change media in drawer amount. Pressing this key enters media change operation.

Merchandise subtotal

Use this key to obtain subtotal excluding the add-on tax amount and the previous balance.

New balance

Use this key for adding the latest registered total amount to the previous balance to obtain a new balance.

New check

Use this key in a check tracking system to input a new check number in order to open a new check under that number.

New/Old check

Use this key in a check tracking system to input check numbers in order to open new checks and to reopen existing checks. When the clerk inputs a check number, the register checks to see if that number already exists in the check tracking memory. If there is no matching number in the memory, a new check is opened under the input number. If the check number input matches a number already stored in the memory, that check is reopened for further registration or finalization.

No sale

Use this key to open the drawer between transaction.

Non add

Use this key to print reference numbers (personal check number, card number, etc.)

OBR (Optical barcode reader)

Use this key to input optical barcodes manually.

Old check

Use this key in a check tracking system to input the number of an existing check (previously created by the New check key) whose details are stored in the check tracking memory. Existing checks are reopened to perform further registration or to finalize them.

One touch NLU

Use this key to register scanning PLU directly from the keyboard. There is one One touch NLU key for one scanning PLU, and multiple one touch NLU keys can be set on the keyboard.

Open

Use this key to temporarily release a limitation on the number of digits that can be input for a unit price.

Open 2

Use this key to suspend the compulsory specifications.

Open check

Use this key to issue an open check report of an assigned clerk.

Operator number

Use this key to enter a clerk number during clerk transfer.

Operator X/Z

Use this key to issue a clerk's individual X/Z report.

Pick up

When the amount in drawer exceeds the limit value (sentinel function), the manager performs a pick up operation. This key is used for this function. This operation affects media totals, rather than sales totals. Pick ups are made for all types of money which can be specified by the finalize key. Plus Use this key for registering surcharge.

Premium

Use this key to apply a preset % or manual input % to obtain the premium amount for the last registered item or subtotal.

Previous balance

Use this key to register the previous negative/positive balance at the beginning of or during a transaction.

Previous balance subtotal

Use this key to obtain subtotal excluding the add-on tax amount and current balance.

Price

Use this key to register an open PLU.

Price change

Use this key to change scanning PLU unit price temporarily.

Price inquiry

Use this key to confirm the price and descriptors of PLU without registering.

Price shift

Use this key to shift a scanning PLU to the 1st ~ 3rd unit price.

Rate tax

Use this key to activate the preset tax rate or manually input rate to obtain the tax for the preceding taxable status 1 amount.

Recall

Use this key for recalling the transferred check number by the store key. When this key is pressed, the check number will appear in order of the oldest record.

Red price

Use this key to register a new (discounted) price of an item.

Review

Use this key to examine the current transaction by displaying item descriptor and registered amount. This key is also used for void operation or separate check operation.

Separate check

Use this key in a check tracking system to separate selected items from one check to another check.

Slip feed/release

Use this key to feed slips inserted into the slip printer. This is done by specifying the number of feed lines. This key is also used to release the slip paper holder if numbers are not entered.

Slip back feed/release

Use this key to back feed slips inserted into the slip printer. This is done by specifying the number of feed lines. This key is also used to release the slip paper holder if numbers are not entered.

Slip print

Use this key to execute a slip batch printing on the slip printer. Pressing this key prints the sales details. Actual printing is performed following receipt issuance.

Square

This key provides the same functions as the Multiplication key. In addition, this key also has a square multiplication function.

Stock inquiry

Use this key to check the current stock quantity for a PLU without registering.

Store

Use this key for storing the check number of the registered items. When this key is pressed, registered item data will be stored, and then these data will transfer to the youngest check number.

Table number

Use this key to input table numbers.

Takeout

Use this key to specify if the customer takes out items. Before total a transaction. Press this key for the tax exemption.

Tax exempt

Use this key to change taxable amounts to nontaxable amounts.

Taxable amount subtotal

Use this key to obtain taxable amount subtotal.

Text print

Use this key to enter characters to print.

Text recall

Use this key to print preset characters.

Tip

Use this key to register tips.

Tray total

Use this key to display the total amount for all registrations from the last registration until this key is pressed or registrations between presses of this key.

Validation

Use this key to validate transaction amounts on slip.

VAT

Use this key to print a VAT breakdown.

Void

Use this key to invalidate preceding item data registered.

Basic Operations and Setups

How to read the printouts

- The journal and receipts are records of all transactions and operations.
- The contents printed on receipts and journal are almost identical.
- You can choose the journal skip function.

If the journal skip function is selected, the cash register will print the total amount of each transaction, and the details of premium, discount and reduction operations only, without printing department and PLU item registrations on the journal.

- The following items can be skipped on receipts and journal.
 - Consecutive number
 - Taxable status
 - Taxable amount
 - Item counter

Receipt Sample

```

*****
* THANK YOU *
** CALL AGAIN **
*****

* COMMERCIAL MESSAGE *
* COMMERCIAL MESSAGE *
* COMMERCIAL MESSAGE *
* COMMERCIAL MESSAGE *

REG 03-06-2006 11:58
CO1 MC#01 000123

1 DEPT01 T1 $1.00
1 DEPT02 T1 $2.00
5 DEPT03 $5.00
7 No

TA1 $3.00
TX1 $0.15
TL $8.15
CASH $10.00
CG $1.85

*** BOTTOM MESSAGE ***
*** BOTTOM MESSAGE ***
*** BOTTOM MESSAGE ***
*** BOTTOM MESSAGE ***
    
```

Logo message

Commercial message

Mode/Date/Time
Clerk/Machine No.
Consecutive No.

Q'ty/Item

Item counter

Bottom message

**Journal Sample
(Item lines Included)**

```

REG 03-06-2006 11:58
CO1 MC#01 000123
1 DEPT01 T1 $1.00
1 DEPT02 T1 $2.00
5 DEPT03 $5.00
7 No
TA1 $3.00
TX1 $0.15
TL $8.15
CASH $10.00
CG $1.85

REG 03-06-2006 11:59
CO1 MC#01 000124
1 DEPT01 T1 $1.00
1 DEPT12 T1 $1.00
5 DEPT03 $6.00
7 No
TA1 $2.00
TX1 -0.10
TL $8.10
CASH $10.00
CG $1.90

REG 03-06-2006 11:59
CO1 MC#01 000124
    
```

**Journal Sample
(by half height character)**

```

REG 03-06-2006 11:58
CO1 MC#01 000123
1 DEPT01 T1 $1.00
1 DEPT02 T1 $2.00
5 DEPT03 $5.00
7 No
TA1 $3.00
TX1 $0.15
TL $8.15
CASH $10.00
CG $1.85

REG 03-06-2006 11:59
CO1 MC#01 000124
1 DEPT01 T1 $1.00
1 DEPT12 T1 $1.00
5 DEPT03 $6.00
7 No
TA1 $2.00
TX1 $0.10
TL $8.10
CASH $10.00
CG $1.90

REG 03-06-2006 11:59
CO1 MC#01 000124
    
```

In the operation examples contained in this manual, the print samples are what would be produced if the roll paper is being used for receipts. They are not actual size. Actual receipts are 58 mm wide. Also, all sample receipts and journals are printout images.

How to use your cash register

The following describes the general procedure you should use in order to get the most out of your cash register.

BEFORE business hours...

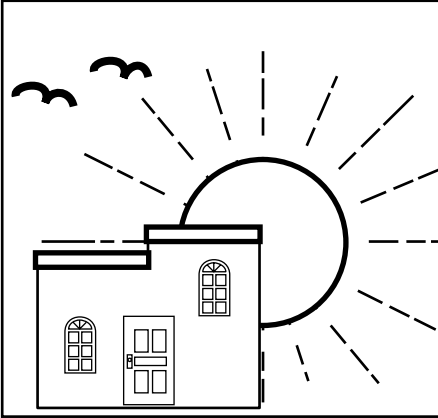

- Check to make sure that the cash register is plugged in securely. Page 14
- Check to make sure there is enough paper left on the roll. Pages 12, 13
- Read the financial totals to confirm that they are all zero. Page 95
- Check the date and time. Page 31

DURING business hours...

- Register transactions. Page 32
- Periodically read totals. Page 94

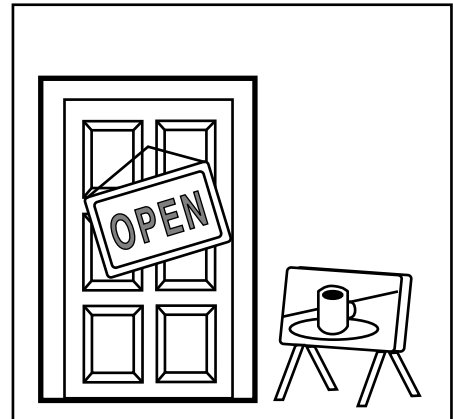

AFTER business hours...

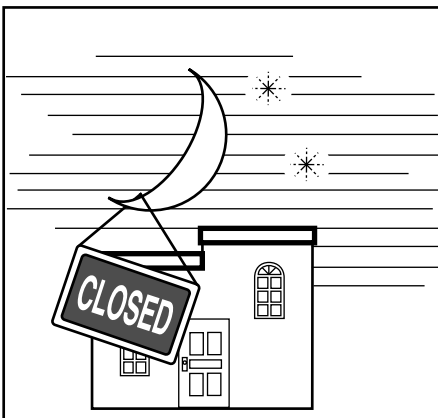

- Reset the daily totals. Page 49
- Remove the journal. Page 110
- Empty the cash drawer and leave it open. Page 22
- Take the cash and journal to the office.

Basic Operations and Setups

Assigning a clerk



Clerk or cashier assignment can be performed using clerk secret numbers only (clerk buttons are not equipped).

Clerk secret number key

When the cash register is programmed to use clerk secret numbers for clerk or cashier assignment, the clerk buttons are not functional.

Clerk sign on

	OPERATION	RECEIPT
Signing clerk 1 on:	1 → <input type="text" value="CLK#"/>	<div style="border: 1px solid black; padding: 5px; width: fit-content;"> <p style="text-align: center;">* COMMERCIAL MESSAGE *</p> <p>REG 03-06-2006 11:58</p> <p>C01 MC#01 000123</p> <hr/> <p>1 DEPT01 T1 \$1.00</p> </div> <p style="text-align: right; margin-top: 0;">Clerk name/machine No./consecutive No.</p>
Signing clerk 2 on:	2 → <input type="text" value="CLK#"/>	
⋮	⋮	
Signing clerk 15 on:	1 5 → <input type="text" value="CLK#"/>	

Clerk secret number
(1 ~ 15 is set as default.)

- If you do not want the clerk secret number to be shown on the display, press before entering the number.

Clerk sign off

	OPERATION
Signing clerk off: (except PGM mode)	0 → <input type="text" value="CLK#"/>

- The current clerk is also signed off whenever you set the mode switch to OFF position.

Important!

- The error code "E008" appears on the display whenever you try to perform a registration, a read/reset operation without signing on.
- A clerk cannot sign on unless other clerk is signed off.
- The signed on clerk is also identified on the receipt/journal.

Displaying the time and date



You can show the time or date on the display of the cash register whenever there is no registration being made.

To display and clear the date/time

OPERATION	DISPLAY
<p>Date/time appears on the display.</p>	
<p>Clears the date/time display.</p>	

Preparing coins for change



You can use the following procedure to open the drawer without registering an item. This operation must be performed out of a sale. (You can use the **RC** key instead of the **#/NS** key. See page 45.)

Opening the drawer without a sale

OPERATION	RECEIPT

Preparing and using department/flat-PLU keys

Registering department/flat-PLU keys



The following examples show how you can use the department/flat-PLU keys in various types of registrations.

Single item sale

Example 1

OPERATION

RECEIPT

Item	Unit price	\$1.00
	Quantity	1
	Dept.	1
Payment	Cash	\$1.00

1 00

Unit price

1

Department

CA/AMT
/TEND

1 DEPT01	\$1.00	Department No./ unit price
TL	\$ 1 . 00	Total amount
CASH	\$1.00	

Example 2 (Subtotal registration and change computation)

OPERATION

RECEIPT

Item	Unit price	\$12.34
	Quantity	1
	Flat-PLU	1
Payment	Cash	\$20.00

1 2 3 4

Unit price

001

Flat-PLU

SUB
TOTAL

2 0 00 CA/AMT
/TEND

Amount tendered

1 PLU001	\$12.34	Total amount
TL	\$ 12 . 34	Amount tendered
CASH	\$20.00	Change
CG	\$7.66	

Repeat

OPERATION

RECEIPT

Item	Unit price	\$1.50
	Quantity	3
	Dept.	1
Payment	Cash	\$10.00

1 5 0 1

1

1

SUB
TOTAL

1 0 00 CA/AMT
/TEND

1 DEPT01	\$1.50	Repeat
1 DEPT01	\$1.50	Repeat
1 DEPT01	\$1.50	
TL	\$ 4 . 50	
CASH	\$10.00	
CG	\$5.50	

Multiplication

OPERATION

RECEIPT

Item	Unit price	\$1.00
	Quantity	12
	Flat-PLU	1
Payment	Cash	\$20.00

1 **2** / FOR DATE TIME
 Quantity
 (4-digit integer/3-digit decimal)

1 **00** 001
 SUB TOTAL

2 **0** **00** CA / AMT TEND

12	PLU0001	\$12.00	Quantity/result or
12	@1/	1.00	Quantity/unit q'ty/@
	PLU0001	\$12.00	Result
TL		\$12.00	
CASH		\$20.00	
CG		\$8.00	

Split sales of packaged items

OPERATION

RECEIPT

Item	Unit price	4 for \$10.00
	Quantity	3
	Dept.	1
	Taxable	No
Payment	Cash	\$10.00

3 / FOR DATE TIME
 Quantity being purchased
 (4-digit integer/3-digit decimal)

4 / FOR DATE TIME
 Package quantity
 (4-digit integer/3-digit decimal)

1 **0** **00** 1
 Package price SUB TOTAL

1 **0** **00** CA / AMT TEND

3	DEPT01	\$7.50	Quantity/result or
3	@4/	10.00	Quantity/unit q'ty/@
	DEPT01	\$7.50	Result
TL		\$7.50	
CASH		\$10.00	
CG		\$2.50	

Programming department/flat-PLU keys

To program a unit price for each department/flat-PLU

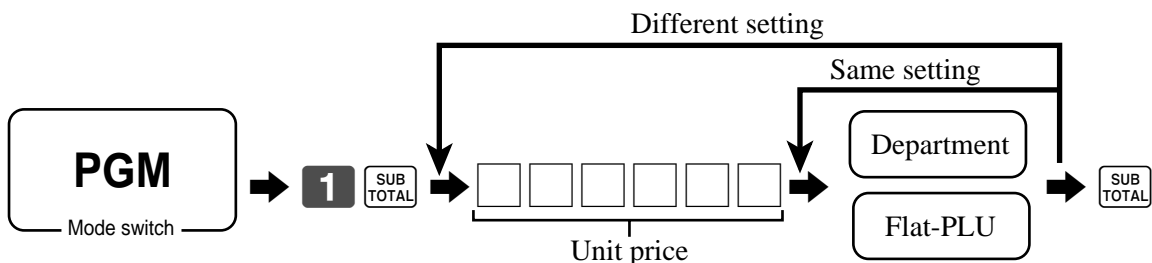

To program the tax calculation status for each department/flat-PLU

Tax calculation status

This specification defines which tax table should be used for automatic tax calculation.

Basic Operations and Setups

Programming procedure

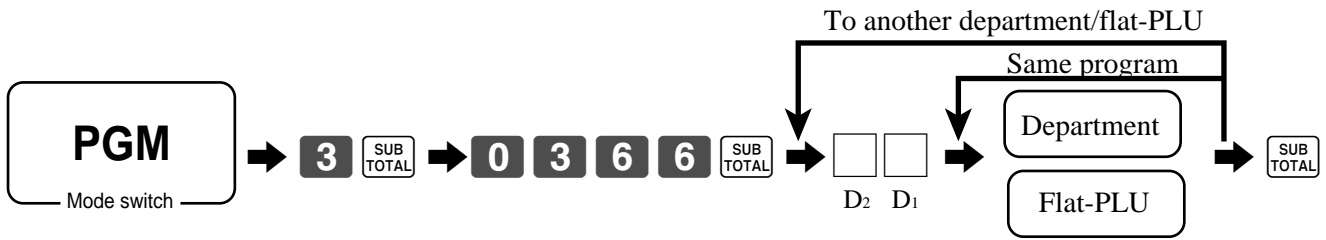

Description	Choice	Program code
-------------	--------	--------------

for the U.S.

Food stamp	Yes = 1 No = 0	<input type="checkbox"/> D ₂
Taxable 1 status	a Yes = 1 No = 0	a+b+c <input type="checkbox"/> D ₁
Taxable 2 status	b Yes = 2 No = 0	
Taxable 3 status	c Yes = 4 No = 0	

for Canada

Donuts status	Yes = 1 No = 0	<input type="checkbox"/> D ₂
Non tax = 0 Taxable 1 = 1 Taxable 2 = 2	Taxable 3 = 3 Taxable 4 = 4 Taxable 1 & 2 = 5	Significant number <input type="checkbox"/> D ₁
	Taxable 1 & 3 = 6 Taxable 1 & 4 = 7	

To program high amount limit for each department/flat-PLU

Programming procedure

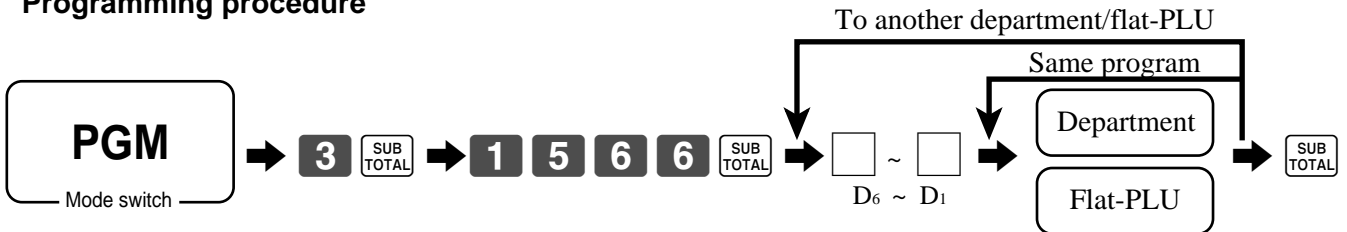

Description	Choice	Program code
High amount limit for entering unit price manually.	Significant numbers	<input type="checkbox"/> ~ <input type="checkbox"/> D ₆ ~ D ₁

Registering department/flat-PLU keys by programming data

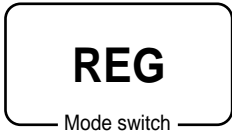

Preset price

Item	Unit price	(\$1.00) _{preset}
	Quantity	1
	Dept.	2
Payment	Cash	\$1.00

OPERATION

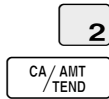

RECEIPT

1 DEPT02		\$1.00
TL	\$1.00	
CASH		\$1.00

Department No./
unit price

Preset tax status

Item 1	Unit price	(\$2.00) _{preset}
	Quantity	5
	Dept.	3
	Taxable	(1) _{preset}
Item 2	Unit price	(\$2.00) _{preset}
	Quantity	1
	Dept.	4
	Taxable	(2) _{preset}
Payment	Cash	\$20.00

OPERATION

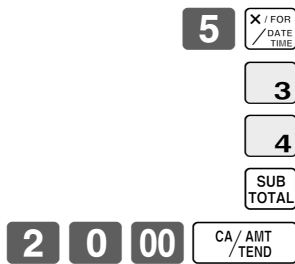

RECEIPT

5 DEPT03	T1	\$10.00
1 DEPT04	T2	\$2.00
TA1		\$10.00
TX1		\$0.40
TA2		\$2.00
TX2		\$0.20
TL		\$12.60
CASH		\$20.00
CG		\$7.40

Tax status

Taxable Amount 1
Tax 1
Taxable Amount 2
Tax 2

Locking out high amount limitation

Item	Unit price	\$1.05
	Quantity	1
	Dept.	3
	Max.amount	(\$10.00) _{preset}
Payment	Cash	\$2.00

OPERATION

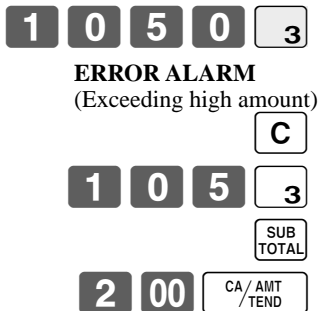

RECEIPT

1 DEPT03		\$1.05
TL	\$1.05	
CASH		\$2.00
CG		\$0.95

Preparing and using PLUs

This section describes how to prepare and use PLUs.

CAUTION:

Before you use PLUs, you must first program the unit price and tax status.

Programming PLUs

To program a unit price for each PLU

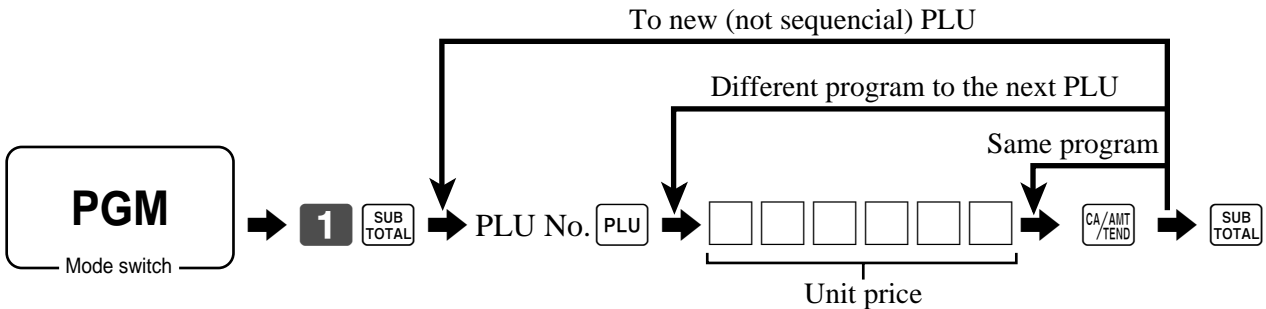

To program tax calculation status for each PLU

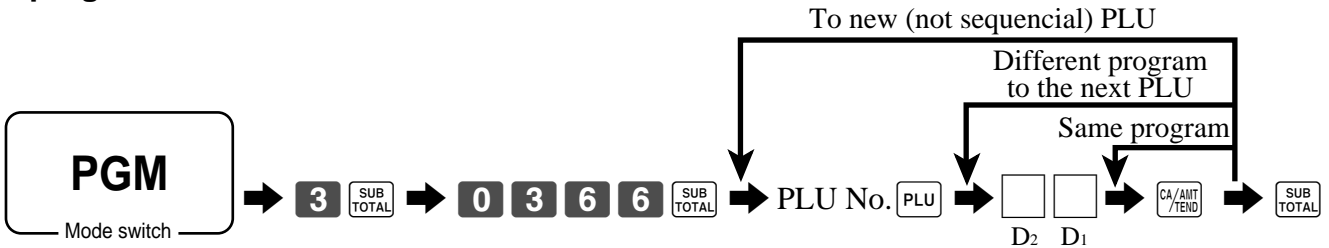

Description	Choice	Program code
-------------	--------	--------------

for the U.S.

Food stamp	Yes = 1 No = 0	<input type="checkbox"/> D ₂
Taxable 1 status	a Yes = 1 No = 0	a+b+c <input type="checkbox"/> D ₁
Taxable 2 status	b Yes = 2 No = 0	
Taxable 3 status	c Yes = 4 No = 0	

for Canada

Donuts status	Yes = 1 No = 0	<input type="checkbox"/> D ₂
Non tax = 0 Taxable 1 = 1 Taxable 2 = 2	Taxable 3 = 3 Taxable 4 = 4 Taxable 1 & 2 = 5	Taxable 1 & 3 = 6 Taxable 1 & 4 = 7
	Significant number	<input type="checkbox"/> D ₁

Registering PLUs

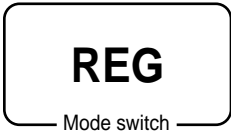

The following examples show how you can use PLUs in various types of registrations.

PLU single item sale

Item	Unit price	(\$2.50) _{preset}
	Quantity	1
	PLU	14
Payment	Cash	\$3.00

OPERATION

1 4
PLU code

PLU

SUB
TOTAL

3 00 CA/AMT
TEND

RECEIPT

1 PLU0014	\$2.50	PLU No./unit price
TL	\$2.50	
CASH	\$3.00	
CG	\$0.50	

PLU repeat

Item	Unit price	(\$2.50) _{preset}
	Quantity	3
	PLU	14
Payment	Cash	\$10.00

OPERATION

1 4 PLU

PLU

PLU

SUB
TOTAL

1 0 00 CA/AMT
TEND

RECEIPT

1 PLU0014	\$2.50
1 PLU0014	\$2.50
1 PLU0014	\$2.50
TL	\$7.50
CASH	\$10.00
CG	\$2.50

PLU multiplication

Item	Unit price	(\$2.00) _{preset}
	Quantity	10
	PLU	7
Payment	Cash	\$20.00

OPERATION

1 0 FOR
DATE
TIME
Quantity
(4-digit integer/3-digit decimal)

7 PLU

SUB
TOTAL

2 0 00 CA/AMT
TEND

RECEIPT

10 PLU0007	\$20.00	Quantity/result
10 PLU0007	@1/ 2.00	or
PLU0007	\$20.00	Quantity/unit q'ty/@
		Result
TL	\$20.00	
CASH	\$20.00	
CG	\$0.00	

Basic Operations and Setups

Split sales of packaged item

Item	Unit price	(5for\$20.00) <small>preset</small>
	Quantity	3
	PLU	28
Payment	Cash	\$15.00

OPERATION

3 X / FOR DATE TIME
 Quantity being purchased
 (4-digit integer/3-digit decimal)

5 X / FOR DATE TIME
 Package quantity
 (4-digit integer/3-digit decimal)

2 8 PLU

SUB TOTAL

1 5 00 CA / AMT / TEND

RECEIPT

3 PLU0028	\$12.00	Quantity/result or Quantity/unit q'ty/@ Result
3	@5/ 20.00	
PLU0028	\$12.00	
\$12.00		
TL	\$15.00	
CASH	\$3.00	
CG		

Open PLU

Item 1	Unit price	\$32.80
	Quantity	1
	PLU	30
Item 2	Unit price	\$13.00
	Quantity	2
	PLU	31
Payment	Cash	\$60.00

OPERATION

3 0 PLU

3 2 8 0 PRICE
 Unit price

3 1 PLU

1 3 00 PRICE
 Repeat PRICE

SUB TOTAL

6 0 00 CA / AMT / TEND

RECEIPT

1 PLU0030	\$32.80	
1 PLU0031	\$13.00	
1 PLU0031	\$13.00	
TL	\$58.80	
CASH	\$60.00	
CG	\$1.20	

- Before registering an open PLU, it is necessary to preset it as an open PLU.

Shifting the taxable status of an item

By pressing "Tax Shift" key, you can shift the taxable status of an item.

REG

Mode switch

Calculation merchandise subtotal

OPERATION

RECEIPT

Item 1	Dept. 1	\$4.00
	Quantity	1
	Taxable	(2) _{preset}
Item 2	Dept. 2	\$2.00
	Quantity	1
	Taxable	(No)→1
Item 3	Dept. 3	\$6.00
	Quantity	1
	Taxable	(1)→1, 2
Item 4	Dept. 4	\$7.00
	Quantity	1
	Taxable	(2)→No
Payment	Cash	\$20.00

4 00 1

T/S1

2 00 2

Pressing changes the tax status from Nontaxable to Taxable 1

T/S2

6 00 3

Pressing changes the tax status from Taxable 1 to Taxable 1, 2

T/S2

7 00 4

Pressing changes the tax status from Taxable 2 to Nontaxable

SUB
TOTAL

2 0 00 CA/AMT
TEND

1	DEPT01	T2	\$4.00
1	DEPT02	T1	\$2.00
1	DEPT03	T12	\$6.00
1	DEPT04		\$7.00
	TA1		\$8.00
	TX1		\$0.32
	TA2		\$10.00
	TX2		\$0.50
	TL		\$19.82
	CASH		\$20.00
	CG		\$0.18

Important!

- To change the tax status of the next item to be registered, be sure to press , . If the last item registered is programmed as nontaxable, a discount () key) operation on this item is always nontaxable. In this case, you cannot manually change the tax status to Taxable 1 or 2 by pressing the , keys.

Preparing and using discounts

This section describes how to prepare and register discounts.

Programming discounts

To program a rate to the **%-** key

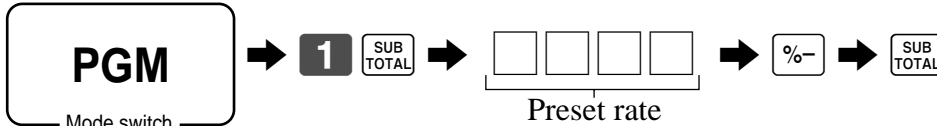

Example:

10% ⇒ **1 0**
 5.5% ⇒ **5 . 5**
 12.34% ⇒ **1 2 . 3 4**

Registering discounts



The following example shows how you can use the **%-** key in various types of registration.

Discount for items and subtotals

	Dept. 1	\$5.00
Item 1	Quantity	1
	Taxable	(1) _{preset}
Item 2	PLU 16	(\$10.00) _{preset}
	Quantity	1
	Taxable	(2) _{preset}
Discount	Rate	(5%) _{preset}
Subtotal discount	Rate	3.5%
	Taxable	Nontaxable
Payment	Cash	\$15.00

OPERATION

5 00 **1**
1 6 **PLU**
%-

Applies the preset discount rate to the last item registered.

SUB TOTAL
3 . 5 **%-**

The input value takes priority of the preset value.

SUB TOTAL
1 5 00 **CA/AMT TEND**

RECEIPT

1	DEPT01	T1	\$5.00
1	PLU0016	T2	\$10.00
	5%		
	%-	T2	-0.50
	ST		\$14.50
	3.5%		
	%-		-0.51
	TA1		\$5.00
	TX1		\$0.20
	TA2		\$9.50
	TX2		\$0.48
	TL		\$14.67
	CASH		\$15.00
	CG		\$0.33

- You can manually input rates up to 4 digits long (0.01% to 99.99%).

Taxable status of the **%-** key

- Whenever you perform a discount operation on the last item registered, the tax calculation for discount amount is performed in accordance with the tax status programmed for that item.
- Whenever you perform a discount operation on a subtotal amount, the tax calculation for the subtotal amount is performed in accordance with the tax status programmed for the **%-** key.

Preparing and using reductions

This section describes how to prepare and register reductions.

Programming for reductions

You can use the **[-]** key to reduce single item or subtotal amounts.

To program preset reduction amount

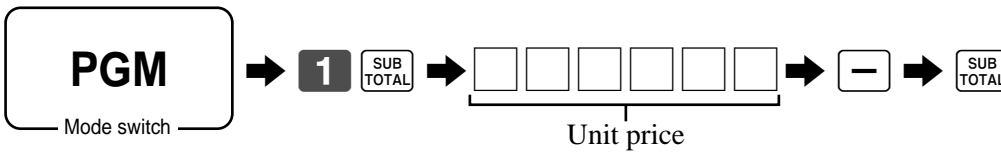

Registering reductions



The following examples show how you can use the **[-]** key in various types of registration.

Reduction for items

	OPERATION	RECEIPT																																																						
<table border="1" style="width: 100%; border-collapse: collapse;"> <tr> <td style="width: 15%;">Item 1</td> <td style="width: 15%;">Dept. 1</td> <td style="width: 15%;">\$5.00</td> </tr> <tr> <td></td> <td>Quantity</td> <td>1</td> </tr> <tr> <td></td> <td>Taxable</td> <td>(1)_{preset}</td> </tr> <tr> <td>Reduction</td> <td>Amount</td> <td>\$0.25</td> </tr> <tr> <td style="vertical-align: top;">Item 2</td> <td>PLU 45</td> <td>(\$6.00)_{preset}</td> </tr> <tr> <td></td> <td>Quantity</td> <td>1</td> </tr> <tr> <td></td> <td>Taxable</td> <td>(1)_{preset}</td> </tr> <tr> <td>Reduction</td> <td>Amount</td> <td>(\$0.50)_{preset}</td> </tr> <tr> <td>Payment</td> <td>Cash</td> <td>\$11.00</td> </tr> </table>	Item 1	Dept. 1	\$5.00		Quantity	1		Taxable	(1) _{preset}	Reduction	Amount	\$0.25	Item 2	PLU 45	(\$6.00) _{preset}		Quantity	1		Taxable	(1) _{preset}	Reduction	Amount	(\$0.50) _{preset}	Payment	Cash	\$11.00	<p>5 00 1</p> <p>2 5 [-]</p> <p>Reduces the last amount registered by the value input.</p> <p>4 5 PLU</p> <p>[-]</p> <p>SUB TOTAL</p> <p>1 1 00 CA/AMT TEND</p>	<table border="1" style="width: 100%; border-collapse: collapse;"> <tr> <td style="width: 15%;">1 DEPT01</td> <td style="width: 15%;">T1</td> <td style="width: 15%;">\$5.00</td> </tr> <tr> <td>-</td> <td>T1</td> <td>-0.25</td> </tr> <tr> <td>1 PLU0045</td> <td>T1</td> <td>\$6.00</td> </tr> <tr> <td>-</td> <td>T1</td> <td>-0.50</td> </tr> <tr> <td>TA1</td> <td></td> <td>\$10.25</td> </tr> <tr> <td>TX1</td> <td></td> <td>\$0.41</td> </tr> <tr> <td>TL</td> <td></td> <td>\$ 10.66</td> </tr> <tr> <td>CASH</td> <td></td> <td>\$11.00</td> </tr> <tr> <td>CG</td> <td></td> <td>\$0.34</td> </tr> </table>	1 DEPT01	T1	\$5.00	-	T1	-0.25	1 PLU0045	T1	\$6.00	-	T1	-0.50	TA1		\$10.25	TX1		\$0.41	TL		\$ 10.66	CASH		\$11.00	CG		\$0.34
Item 1	Dept. 1	\$5.00																																																						
	Quantity	1																																																						
	Taxable	(1) _{preset}																																																						
Reduction	Amount	\$0.25																																																						
Item 2	PLU 45	(\$6.00) _{preset}																																																						
	Quantity	1																																																						
	Taxable	(1) _{preset}																																																						
Reduction	Amount	(\$0.50) _{preset}																																																						
Payment	Cash	\$11.00																																																						
1 DEPT01	T1	\$5.00																																																						
-	T1	-0.25																																																						
1 PLU0045	T1	\$6.00																																																						
-	T1	-0.50																																																						
TA1		\$10.25																																																						
TX1		\$0.41																																																						
TL		\$ 10.66																																																						
CASH		\$11.00																																																						
CG		\$0.34																																																						

- You can manually input reduction values up to 7 digits long.
- If you want to subtract the reduction amount from the department or PLU totalizer, program “Net totaling.”

Basic Operations and Setups

Reduction for subtotal

OPERATION

RECEIPT

Item 1	Dept. 1	\$3.00
	Quantity	1
	Taxable	(1) _{preset}
Item 2	Dept. 2	\$4.00
	Quantity	1
	Taxable	(2) _{preset}
Subtotal Reduction	Amount	\$0.75
	Taxable	(No) _{preset}
Payment	Cash	\$7.00

3 00

4 00

7 5

Reduces the subtotal by the value input here.

7 00

1	DEPT01	T1	\$3.00
1	DEPT02	T2	\$4.00
-			-0.75
	TA1		\$3.00
	TX1		\$0.12
	TA2		\$4.00
	TX2		\$0.20
	TL		\$6.57
	CASH		\$7.00
	CG		\$0.43

Registering credit and check payments

The following examples show how to register credits and payments by check.

REG

Mode switch

Check

OPERATION

RECEIPT

Item	Dept. 1	\$11.00
	Quantity	1
Payment	Check	\$20.00

1 1 00 1
SUB TOTAL
2 0 00 CHK

1 DEPT01	\$11.00
TL	\$ 11.00
CHECK	\$20.00
CG	\$9.00

Charge

OPERATION

RECEIPT

Item	Dept. 4	\$15.00
	Quantity	1
Reference	Number	1234
Payment	Charge	\$15.00

1 5 00 4
SUB TOTAL
1 2 3 4 #/NS
CH

1 DEPT04	\$15.00	Reference No.
#/NS	1234	
TL	\$ 15.00	
CHARGE	\$15.00	

Mixed tender (cash, charge and check)

OPERATION

RECEIPT

Item	Dept. 4	\$55.00
	Quantity	1
Payment	Check	\$30.00
	Cash	\$5.00
	Charge	\$20.00

5 5 00 4
SUB TOTAL
3 0 00 CHK
5 00 CA/AMT TEND
CH

1 DEPT04	\$55.00
TL	\$55.00
CHECK	\$30.00
CASH	\$5.00
CHARGE	\$20.00

Registering returned goods in the REG mode

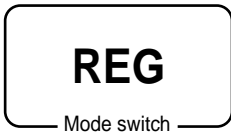

The following example shows how to use the **RF** key in the REG mode to register goods returned by customers.

OPERATION			RECEIPT
Item 1	Dept. 1	\$2.35	<pre> 1 DEPT01 \$2.35 1 DEPT02 \$2.00 1 PLU0001 \$1.20 RF 1 DEPT01 -2.35 RF 1 PLU0001 -1.20 TL \$2.00 CASH \$2.00 </pre>
	Quantity	1	
Item 2	Dept. 2	\$2.00	
	Quantity	1	
Item 3	PLU 1	(\$1.20) _{preset}	
	Quantity	1	
Returned Item 1	Dept. 1	\$2.35	
	Quantity	1	
Returned Item 3	PLU 1	(\$1.20) _{preset}	
	Quantity	1	
Payment	Cash	\$2.00	

2 3 5 1
2 00 2
1 PLU
RF
2 3 5 1
 Press RF before the item you want to return.
RF
1 PLU
SUB TOTAL
CA/AMT TEND

Registering returned goods in the RF mode

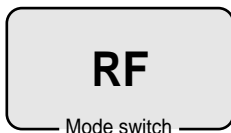

The following examples show how to use the RF mode to register goods returned by customers.

Normal refund transaction

OPERATION			RECEIPT
Returned Item 1	Dept. 1	\$1.50	<pre> RF 03-06-2006 11:50 C01 MC#01 000023 1 DEPT01 \$1.50 1 DEPT01 \$1.50 6 PLU0002 \$7.20 TL \$10.20 CASH \$10.20 </pre>
	Quantity	2	
Returned Item 2	PLU 2	(\$1.20) _{preset}	
	Quantity	6	
Payment	Cash	\$10.20	

1 5 0 1
1
6 X/FOR DATE TIME
2 PLU
CA/AMT TEND

RF mode symbol

Reduction of amounts paid on refund

OPERATION			RECEIPT		
Returned Item 1	Dept. 3	\$4.00	<div style="display: flex; flex-direction: column; align-items: center;"> <div style="display: flex; gap: 5px;"> 4 00 3 </div> <div style="display: flex; gap: 5px;"> 1 5 - </div> <div style="display: flex; gap: 5px;"> 2 PLU </div> <div style="display: flex; gap: 5px;"> %- </div> <div style="display: flex; gap: 5px;"> SUB TOTAL </div> <div style="display: flex; gap: 5px;"> CA/AMT TEND </div> </div>	1 DEPT03	\$4.00
Quantity	1			-	-0.15
Reduction	Amount	\$0.15		1 PLU0002	\$1.20
Returned Item 2	PLU 2	(\$1.20) _{preset}		5%	
Quantity	1			%-	-0.06
Discount	Rate	(5%) _{preset}		TL	\$4.99
Payment	Cash	\$4.99		CASH	\$4.99

Important!

- To avoid miss registrations in the RF mode, return the mode switch to the former position immediately.

Registering money received on account



Mode switch

The following example shows how to register money received on account. This registration must be performed out of a sale.

OPERATION		RECEIPT		
Received amount	\$700.00	<div style="display: flex; gap: 5px;"> 7 00 00 RC </div>	RC	\$700.00

Amount can be up to 8 digits.

Registering money paid out



Mode switch

The following example shows how to register money paid out from the register. This registration must be performed out of a sale.

OPERATION		RECEIPT		
Paid out amount	\$1.50	<div style="display: flex; gap: 5px;"> 1 5 0 PD </div>	PD	\$1.50

Amount can be up to 8 digits.

Making corrections in a registration

REG

Mode switch

There are three techniques you can use to make corrections in a registration.

- To correct an item that you input but not yet registered.
- To correct the last item you input and registered.
- To cancel all items in a transaction.

To correct an item you input but not yet registered

OPERATION

RECEIPT

<p>2 00</p> <p>1 00 C</p> <p>1 2 X / FOR DATE TIME</p> <p>1 1 X / FOR DATE TIME</p> <p>2 00 2</p> <p>2 C</p> <p>3 PLU</p> <p>1 5 PLU</p> <p>6 00 C</p> <p>1 5 PLU</p> <p>Enter PLU No. again.</p> <p>1 0 00 PRICE</p> <p>SUB TOTAL</p> <p>1 0 00 C</p> <p>1 5 00 CA / AMT / TEND</p> <p>CH</p>	<p>— Correction of unit price</p> <p>— Correction of quantity</p> <p>— Correction of PLU No.</p> <p>— Correction of open PLU unit price</p> <p>— Correction of partial tender amount</p>	<table border="0"> <tr> <td>1 DEPT01</td> <td style="text-align: right;">\$1.00</td> </tr> <tr> <td>11 DEPT02</td> <td style="text-align: right;">\$22.00</td> </tr> <tr> <td>1 PLU0003</td> <td style="text-align: right;">\$1.30</td> </tr> <tr> <td>1 PLU0015</td> <td style="text-align: right;">\$10.00</td> </tr> <tr> <td>TL</td> <td style="text-align: right;">\$34.30</td> </tr> <tr> <td>CASH</td> <td style="text-align: right;">\$15.00</td> </tr> <tr> <td>CHARGE</td> <td style="text-align: right;">\$19.30</td> </tr> </table>	1 DEPT01	\$1.00	11 DEPT02	\$22.00	1 PLU0003	\$1.30	1 PLU0015	\$10.00	TL	\$34.30	CASH	\$15.00	CHARGE	\$19.30
1 DEPT01	\$1.00															
11 DEPT02	\$22.00															
1 PLU0003	\$1.30															
1 PLU0015	\$10.00															
TL	\$34.30															
CASH	\$15.00															
CHARGE	\$19.30															

To correct an item you input and registered

OPERATION

RECEIPT

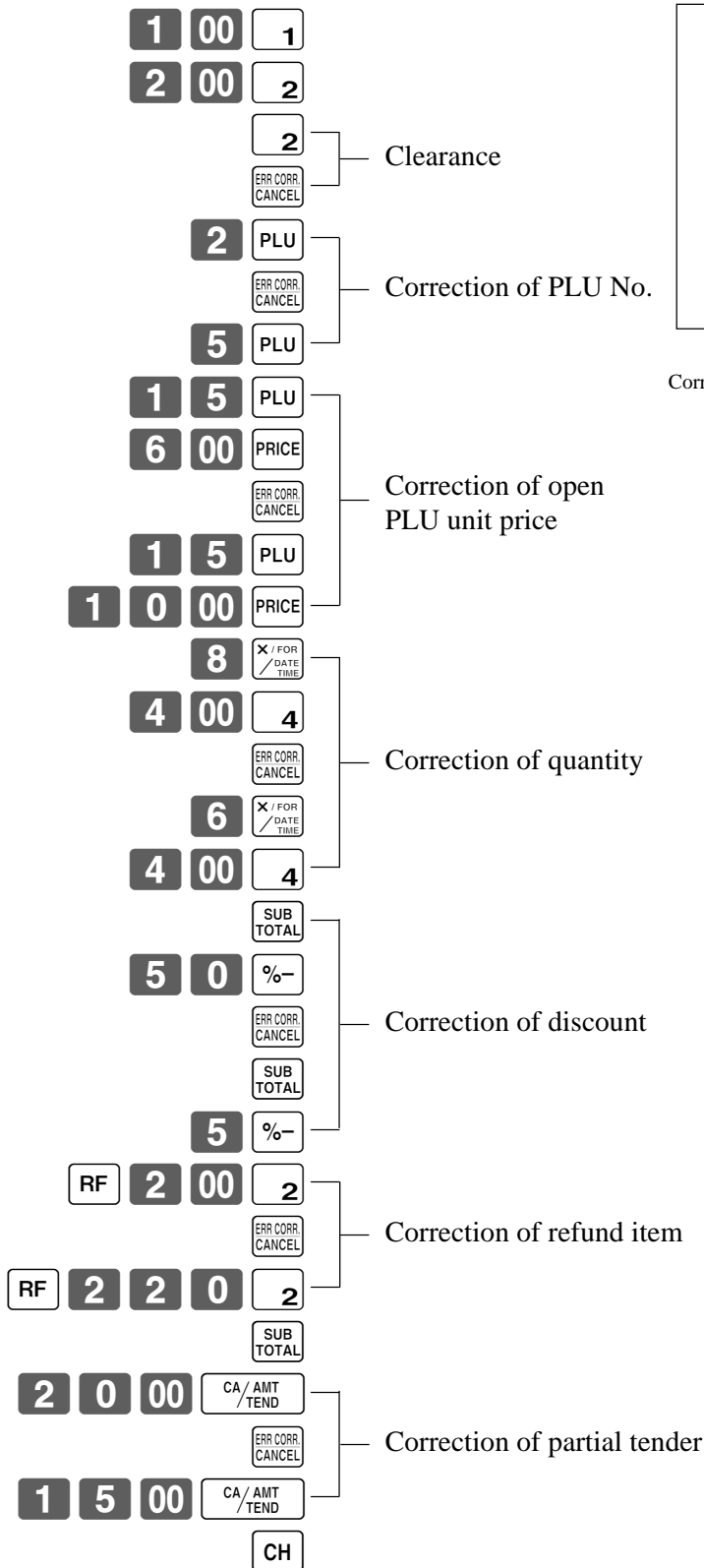

1	DEPT01	\$1.00
1	DEPT02	\$2.00
1	PLU0005	\$1.50
1	PLU0015	\$10.00
6	DEPT04	\$24.00
	ST	\$38.50
	5%	
	%-	-1.93
	RF
1	DEPT02	-2.20
	TL	\$34.37
	CASH	\$15.00
	CHARGE	\$19.37

Corrected items are not printed on receipt.

Basic Operations and Setups

To cancel all items in a transaction

OPERATION	RECEIPT
<div style="display: flex; justify-content: space-around;"> <div style="border: 1px solid black; padding: 2px;">1</div> <div style="border: 1px solid black; padding: 2px;">00</div> <div style="border: 1px solid black; padding: 2px;">1</div> </div> <div style="display: flex; justify-content: space-around; margin-top: 5px;"> <div style="border: 1px solid black; padding: 2px;">2</div> <div style="border: 1px solid black; padding: 2px;">00</div> <div style="border: 1px solid black; padding: 2px;">2</div> </div> <div style="display: flex; justify-content: space-around; margin-top: 5px;"> <div style="border: 1px solid black; padding: 2px;">3</div> <div style="border: 1px solid black; padding: 2px;">00</div> <div style="border: 1px solid black; padding: 2px;">3</div> </div> <div style="display: flex; justify-content: space-around; margin-top: 5px;"> <div style="border: 1px solid black; padding: 2px;">4</div> <div style="border: 1px solid black; padding: 2px;">00</div> <div style="border: 1px solid black; padding: 2px;">4</div> </div> <div style="border: 1px solid black; padding: 2px; margin-top: 5px; width: fit-content; margin-left: auto;">SUB TOTAL</div>	<div style="border: 1px solid black; padding: 5px;"> 1 DEPT01 \$1.00 1 DEPT02 \$2.00 1 DEPT03 \$3.00 1 DEPT04 \$4.00 CANCEL </div>
<p>Pressing SUB TOTAL key is necessary to cancel the transaction.</p> <div style="border: 1px solid black; padding: 2px; margin-top: 10px; width: fit-content; margin-left: auto;">ERR CORR. CANCEL</div>	

No sale registration



You can use the following procedure to open the drawer without registering a sale. This operation must be performed out of a sale.

OPERATION	RECEIPT
<div style="border: 1px solid black; padding: 2px; display: inline-block; margin-left: auto;"># NS</div>	<div style="border: 1px solid black; padding: 5px; margin-left: auto;"> #/NS </div>

Printing the daily sales reset report

This report shows daily sales totals.

OPERATION

REPORT

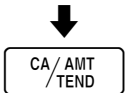
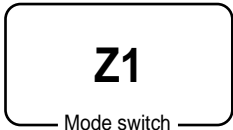

Z 03-06-2006 17:00	Date/time	RC No 4	
C01 MC#01 000231	Clerk name/mc No./consecutive No.	PD No 5	\$810.00

Z BATCH 01	Report title		\$520.00

Z FIX 0001	Fixed total report title/reset counter		\$5.00
0001011	Report code	CORR No 14	\$39.55

GRASS 981.25	Gross total *2	VLD No 19	
\$6,574.40		RCT No 3	
NET No 111	Net total *2	NS No 5	
\$7,057.14		-----	
CAID \$1,919.04	Cash in drawer *2	Z DEPT 0001	Department report title/reset counter
CHID \$139.04	Charge in drawer *2	0001015	Report code
CKID \$859.85	Check in drawer *2	DEPT01 203.25	Department count/amount *1
CRID(1) \$709.85	Credit in drawer *2	DEPT02 183	

RF No 3	Refund mode *2	\$1,362.26	
\$10.22		5	
CUST CT 111	Number of customer *2		
AVRG \$63.57	Average sales per customer *2	TL 421.25	Department total count/total amount
DC \$1.22	Discount total *2	\$2,872.28	
REF \$2.42	Refund key *2	-----	
CLEAR No 85	Clear key count *2	Z CASHIER 0001	Clerk report title/reset counter
ROUND \$0.00	Rounding total *2	0001017	Report code
CANCEL No 2	Cancellation *2	C01	Clerk name/drawer No. *1
\$12.97		GRASS 421.25	Gross total *1

TA1 \$2,369.69	Taxable 1 amount *2	NET No 111	Net total *1
TX1 \$128.86	Tax 1 amount *2	CAID \$1,845.35	Cash in drawer *1
TA2 \$2,172.96	Taxable 2 amount *2	CHID \$139.04	
TX2 \$217.33	Tax 2 amount *2	C02	Clerk name/drawer No.

GT1 \$00000000125478.96	Grand total 1 *2		
GT2 \$00000000346284.23	Grand total 2 *2		
GT3 \$00000000123212.75	Grand total 3 *2		

Z TRANS 0001	Function key report title/reset counter		
0001012	Report code		
CASH No 362	Function key count/amount *1		
\$1,638.04			
CHARGE No 56			
\$1,174.85			

*1 Zero totalled departments/functions/clerks are not printed by programming.

*2 These items can be skipped by programming.

This chapter describes more sophisticated operations that you can use to suit the needs of your retail environment.

Stock check

Each PLU has an actual stock totalizer that you can program with a minimum stock quantity. Then the register checks actual stock quantities against the programmed minimum stock quantities. Stock operations are performed only for PLUs programmed with minimum stock quantities.

Stock warnings

The cash register checks for negative values in actual stock quantities during the registration itself. After registration is complete, it checks actual stock quantities against minimum stock quantities. The following warning indicators are used to inform the operator of any problem.

- **Negative stock:**

This indicates that the actual stock quantity is negative. You can also program the cash register to treat this condition as an error. This warning does not appear when the actual stock quantity is zero.

- **Under minimum stock:**

This indicates that the actual stock quantity is less than or equal to the minimum stock quantity. The cash register can be programmed so that a buzzer sounds when the actual stock quantity is less than the minimum stock quantity.

Notes

- The stock check operation is also performed for PLUs programmed with minimum stock quantities that make up set menus.
- None of the warning indicators appear unless the cash register is specifically programmed for the stock check operation.
- Stock operations can be performed for registrations in the RF mode or those performed with <REFUND> (the refund key).
- An error correct, void, or cancel operation restores the original of items in stock value.

Clerk interrupt function

There are two types of clerk interrupt function, illustrated by PROCEDURE 1 and PROCEDURE 2 below.

- In PROCEDURE 1, each clerk possesses a unique clerk interrupt buffer, and so the clerk interrupt function gives each individual clerk the ability to perform an independent registration operation. In this case, each clerk is individually linked to a unique clerk interrupt buffer.
- In PROCEDURE 2, multiple clerks use the same clerk interrupt buffer, and so a single clerk interrupt operation (clerk change during registration) can be performed any registration is in progress. In this case, multiple clerks are linked to a single clerk interrupt buffer.

Note the following important points concerning the clerk interrupt function.

- The register must be programmed to allow use of the clerk interrupt function.
- To use the clerk interrupt function, a clerk interrupt buffer must first be allocated with the memory allocation operation. Next the manager control operation (X1 mode) should be used to perform clerk assignment for the clerk interrupt function. The clerk interrupt operation cannot be performed by clerks who are not linked to a clerk interrupt buffer.
- You cannot use the clerk interrupt function on a register set up to function as part of a check tracking system. In the REG1, REG2, and RF modes, clerks can change while a transaction is in progress, making it possible for multiple clerks to simultaneously perform registrations using a single register. For example, if clerk 1 is interrupted while registering a transaction, clerk 2 can use the same machine to register a different transaction. Then clerk 1 can continue the original registration from the point where it was interrupted.

PROCEDURE 1

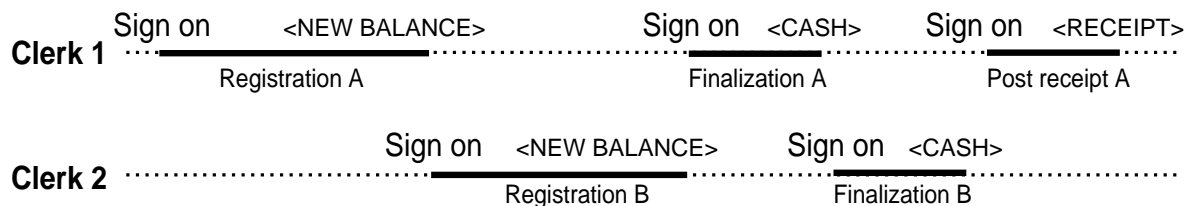

PROCEDURE 2



NOTES

- A guest receipt can be issued following clerk change, and receipts can be issued separately for each clerk.
- A cancel operation can be performed during registration by either of the clerks. When clerk 1 signs back on (after being interrupt by clerk 2), the cancel operation cancels only the items registered after signing back on (only this receipt) or from the top of the transaction. This is selectable by the key program.

Single item cash sales

A department key or PLU programmed with single item sale status finalizes the transaction as soon as it is registered.

The single item sales function cannot work properly if the keyboard does not include <CASH> (the cash key). The single item sales function can only be used for cash sales.

Example 1

OPERATION			RECEIPT						
Item	Dept. 1	\$1.00	<div style="border: 1px solid black; padding: 5px; display: inline-block;"> <table style="border-collapse: collapse;"> <tr> <td style="padding: 2px 5px;">1</td> <td style="padding: 2px 5px;">00</td> <td style="padding: 2px 5px;">1</td> </tr> </table> </div> <p>The transaction is immediately finalized.</p>	1	00	1	1 DEPT01	\$1.00	Department No./ unit price
1	00	1							
	Quantity	1		TL	\$ 1.00				
	Status	S.I.S	CASH	\$1.00	Cash total amount				
Payment	Cash	\$1.00							

Advanced Operations

Example 2

OPERATION

Item	Dept. 1	(\$1.00)
	Quantity	3
	Status	S.I.S
Payment	Cash	\$3.00

3 / FOR
DATE
TIME

1

The transaction is immediately finalized.

RECEIPT

3 DEPT01	\$3.00
TL	\$3.00
CASH	\$3.00

Example 3

OPERATION

Item 1	Dept. 3	\$2.00
	Quantity	1
	Status	Normal
Item 2	Dept. 1	(\$1.00)
	Quantity	1
	Status	S.I.S
Payment	Cash	\$3.00

2 00 **3**

1

The transaction is not finalized. Because another item is registered before the single item sales department.

CA / AMT
/ TEND

RECEIPT

1 DEPT03	\$2.00
1 DEPT01	\$1.00
TL	\$3.00
CASH	\$3.00

Addition

Addition (plus)

Example

OPERATION

Item 1	Dept. 1	\$1.00
	Quantity	1
	Addition	\$0.10
Item 2	Dept. 1	\$2.00
	Quantity	3
	Addition	3 × (\$0.20)
Payment	Cash	\$7.70

1 00 **1**

1 0 **+**

3 / FOR
DATE
TIME

2 00 **1**

3 / FOR
DATE
TIME

+

CA / AMT
/ TEND

RECEIPT

1 DEPT01	\$1.00
+	\$0.10
3 DEPT01	\$6.00
+	\$0.60
TL	\$7.70
CASH	\$7.70

Premium (%+)

Example

OPERATION

RECEIPT

Item 1	Dept. 1	\$1.00
	Quantity	1
	Premium	10%
Item 2	Dept. 1	\$2.00
	Quantity	3
Subtotal	Premium	(15%)
Payment	Cash	\$8.17

1	DEPT01	\$1.00
	10%	
	%+	\$0.10
3	DEPT01	\$6.00
	ST	\$7.10
	15%	
	%+	\$1.07
	TL	\$8.17
	CASH	\$8.17

Tray total

Tray total premium/discount

The buffer memory stores all items that fall into the prescribed range, starting from the first item registered for a transaction up to the point that <TRAY TOTAL> (the tray total key) is pressed to perform a tray total premium/discount operation. Following a premium/discount operation, the buffer is cleared and storage of new data starts from registration of the next item following the first premium/discount operation. The following operations clear the buffer memory.

- Press <TRAY TOTAL> twice.
- Press <TRAY TOTAL> and then perform a premium/discount operation. The contents of the buffer memory are restored if an error correction operation is performed to delete the premium/discount operation.

Example

OPERATION			RECEIPT	
Group 1	Dept. 1	\$1.00	1 00 1	1 DEPT01 \$1.00 1 DEPT03 \$2.00 TRAY TL \$3.00 5% %- -0.15 1 DEPT03 \$3.00 1 DEPT04 \$4.00 TRAY TL \$7.00 10% %- -0.70 TL \$9.15 CASH \$9.15
	Dept. 3	\$2.00	2 00 3	
	Discount	(5%) _{preset}	TRAY TOTAL	
Group 2	Dept. 3	\$3.00	%-	
	Dept. 4	\$4.00	3 00 3	
	Discount	10%	4 00 4	
Payment	Cash	\$9.15	TRAY TOTAL	
			1 0 %-	
			CA/AMT /TEND	

Multiple item totalling function

This function accumulates all items registered from the first item registered up to point that <TRAY TOTAL> is pressed, or all items between two presses of <TRAY TOTAL>. Pressing <TRAY TOTAL> displays the total amount with the tax included and prints it on the receipt and journal (printing on receipt and journal is programmable.)

Example

OPERATION			RECEIPT	
CustomerA	Dept. 1	\$1.00	1 00 1	1 DEPT01 \$1.00 1 DEPT03 \$2.00 TRAY TL \$3.00 1 DEPT03 \$3.00 1 DEPT04 \$4.00 TRAY TL \$7.00 TL \$10.00 CASH \$10.00
	Dept. 3	\$2.00	2 00 3	
CustomerB	Dept. 3	\$3.00	TRAY TOTAL TRAY TOTAL	
	Dept. 4	\$4.00	3 00 3	
Payment	Cash	\$10.00	4 00 4	
			TRAY TOTAL TRAY TOTAL	
			CA/AMT /TEND	

Coupon transactions

Note that errors result when the result of a calculation is negative if the cash register is programmed to prohibit credit balances.

Coupon registration using <COUPON> (coupon key)

Example

			OPERATION	RECEIPT
Item 1	Dept. 1	\$3.00	2 <input checked="" type="checkbox"/> FOR DATE TIME	2 DEPT01 \$6.00 COUPON -1.00 1 DEPT03 \$4.00 COUPON -1.00 TL \$8.00 CASH \$8.00
	Quantity	2	3 00 1	
	Coupon	\$0.50 × 2	2 <input checked="" type="checkbox"/> FOR DATE TIME	
Item 2	Dept. 3	\$4.00	5 0 CPN	
	Quantity	1	4 00 3	
	Coupon	(\$1.00)	CPN	
Payment	Cash	\$8.00	CA / AMT TEND	

Coupon registration using <COUPON2> (coupon 2 key)

Example

			OPERATION	RECEIPT
Item 1	Dept. 1	\$15.00	1 5 00 1	1 DEPT01 \$15.00 CPN2 1 DEPT01 -1.50 1 PLU0010 \$5.00 CPN2 1 PLU0050 -0.50 TL \$18.00 CASH \$18.00
	Quantity	1	CPN2 1 5 0 1	
	Coupon 2 Dept. 1	\$1.50	1 0 PLU	
Item 2	PLU 10	\$5.00	CPN2 5 0 PLU	
	Quantity	1		
	Coupon 2 PLU 50	(\$0.50)		
Payment	Cash	\$18.00	CA / AMT TEND	

Advanced Operations

Preset tender amount

An amount up to six digits long can be programmed to <CASH> (cash/amount tendered key). Then, when <CASH> is pressed without inputting a value, the programmed value is automatically registered and the transaction is finalized. When an amount is programmed to <CASH>, attempting to manually input an amount results in an error.

Example 1

	OPERATION	RECEIPT																				
<table border="1" style="width: 100%; border-collapse: collapse;"> <tr> <td rowspan="2" style="width: 15%;">Item</td> <td style="width: 15%;">Dept. 1</td> <td style="width: 15%;">\$8.00</td> </tr> <tr> <td>Quantity</td> <td>1</td> </tr> <tr> <td>Payment</td> <td>Cash</td> <td>(\$10.00)</td> </tr> </table>	Item	Dept. 1	\$8.00	Quantity	1	Payment	Cash	(\$10.00)	<div style="display: flex; justify-content: space-around; align-items: center;"> <div style="border: 1px solid black; padding: 2px;">8 00</div> <div style="border: 1px solid black; padding: 2px;">1</div> </div> <div style="border: 1px solid black; padding: 2px; margin: 5px auto; width: 60px; text-align: center;">CA/AMT /TEND</div> <p>The preset amount is tendered.</p>	<table border="1" style="width: 100%; border-collapse: collapse;"> <tr> <td style="width: 15%;">1 DEPT01</td> <td style="width: 15%;"></td> <td style="width: 15%; text-align: right;">\$8.00</td> </tr> <tr> <td>TL</td> <td style="text-align: right;">\$8.00</td> <td></td> </tr> <tr> <td>CASH</td> <td style="text-align: right;">\$10.00</td> <td></td> </tr> <tr> <td>CG</td> <td style="text-align: right;">\$2.00</td> <td></td> </tr> </table>	1 DEPT01		\$8.00	TL	\$8.00		CASH	\$10.00		CG	\$2.00	
Item		Dept. 1	\$8.00																			
	Quantity	1																				
Payment	Cash	(\$10.00)																				
1 DEPT01		\$8.00																				
TL	\$8.00																					
CASH	\$10.00																					
CG	\$2.00																					

Example 2

	OPERATION	RECEIPT																									
<table border="1" style="width: 100%; border-collapse: collapse;"> <tr> <td rowspan="2" style="width: 15%;">Item</td> <td style="width: 15%;">Dept. 1</td> <td style="width: 15%;">\$15.00</td> </tr> <tr> <td>Quantity</td> <td>1</td> </tr> <tr> <td rowspan="2">Payment</td> <td>Cash</td> <td>(\$10.00)</td> </tr> <tr> <td>Check</td> <td>\$5.00</td> </tr> </table>	Item	Dept. 1	\$15.00	Quantity	1	Payment	Cash	(\$10.00)	Check	\$5.00	<div style="display: flex; justify-content: space-around; align-items: center;"> <div style="border: 1px solid black; padding: 2px;">1 5 00</div> <div style="border: 1px solid black; padding: 2px;">1</div> </div> <div style="border: 1px solid black; padding: 2px; margin: 5px auto; width: 60px; text-align: center;">CA/AMT /TEND</div> <p>An error occurs by manual input</p> <div style="display: flex; justify-content: center; align-items: center; margin: 10px 0;"> <div style="border: 1px solid black; padding: 2px; margin-right: 5px;">C</div> </div> <div style="display: flex; justify-content: center; align-items: center; margin: 10px 0;"> <div style="border: 1px solid black; padding: 2px; margin-right: 5px;">5 00</div> <div style="border: 1px solid black; padding: 2px; margin-right: 5px;">CHK</div> </div> <div style="border: 1px solid black; padding: 2px; margin: 5px auto; width: 60px; text-align: center;">CA/AMT /TEND</div>	<table border="1" style="width: 100%; border-collapse: collapse;"> <tr> <td style="width: 15%;">1 DEPT01</td> <td style="width: 15%;"></td> <td style="width: 15%; text-align: right;">\$15.00</td> </tr> <tr> <td>TL</td> <td style="text-align: right;">\$15.00</td> <td></td> </tr> <tr> <td>CHECK</td> <td style="text-align: right;">\$5.00</td> <td></td> </tr> <tr> <td>CASH</td> <td style="text-align: right;">\$10.00</td> <td></td> </tr> <tr> <td>CG</td> <td style="text-align: right;">\$0.00</td> <td></td> </tr> </table>	1 DEPT01		\$15.00	TL	\$15.00		CHECK	\$5.00		CASH	\$10.00		CG	\$0.00	
Item		Dept. 1	\$15.00																								
	Quantity	1																									
Payment	Cash	(\$10.00)																									
	Check	\$5.00																									
1 DEPT01		\$15.00																									
TL	\$15.00																										
CHECK	\$5.00																										
CASH	\$10.00																										
CG	\$0.00																										

Registering loan amounts



Use this procedure to register loan or bank received from the office.

	OPERATION	RECEIPT																					
<table border="1" style="width: 100%; border-collapse: collapse;"> <tr> <td rowspan="4" style="width: 15%;">Item</td> <td style="width: 15%;">Note</td> <td style="width: 15%;">\$1.00</td> </tr> <tr> <td>Quantity</td> <td>10</td> </tr> <tr> <td>Note</td> <td>\$5.00</td> </tr> <tr> <td>Quantity</td> <td>5</td> </tr> <tr> <td>Media</td> <td>Cash</td> <td>\$35.00</td> </tr> </table>	Item	Note	\$1.00	Quantity	10	Note	\$5.00	Quantity	5	Media	Cash	\$35.00	<div style="display: flex; justify-content: space-around; align-items: center;"> <div style="border: 1px solid black; padding: 2px;">1 0</div> <div style="border: 1px solid black; padding: 2px; font-size: x-small;">X / FOR / DATE TIME</div> </div> <div style="display: flex; justify-content: space-around; align-items: center;"> <div style="border: 1px solid black; padding: 2px;">1 00</div> <div style="border: 1px solid black; padding: 2px;">LOAN</div> </div> <div style="display: flex; justify-content: center; align-items: center; margin: 10px 0;"> <div style="border: 1px solid black; padding: 2px; margin-right: 5px;">5</div> <div style="border: 1px solid black; padding: 2px; font-size: x-small;">X / FOR / DATE TIME</div> </div> <div style="display: flex; justify-content: space-around; align-items: center;"> <div style="border: 1px solid black; padding: 2px;">5 00</div> <div style="border: 1px solid black; padding: 2px;">LOAN</div> </div> <div style="border: 1px solid black; padding: 2px; margin: 5px auto; width: 60px; text-align: center;">CA/AMT /TEND</div>	<table border="1" style="width: 100%; border-collapse: collapse;"> <tr> <td style="width: 15%;">LOAN</td> <td style="width: 15%;"></td> <td style="width: 15%; text-align: right;">\$10.00</td> </tr> <tr> <td>LOAN</td> <td style="text-align: right;">\$25.00</td> <td></td> </tr> <tr> <td>CASH</td> <td style="text-align: right;">\$35.00</td> <td></td> </tr> </table>	LOAN		\$10.00	LOAN	\$25.00		CASH	\$35.00	
Item		Note	\$1.00																				
		Quantity	10																				
		Note	\$5.00																				
	Quantity	5																					
Media	Cash	\$35.00																					
LOAN		\$10.00																					
LOAN	\$25.00																						
CASH	\$35.00																						

Registering pick up amounts

Use this procedure to register pick up money from cash drawer.

REG

Mode switch

OPERATION

RECEIPT

Item	Coin	\$0.50
	Quantity	10
	Coin	\$0.10
	Quantity	5
Media	Cash	\$5.50

FOR DATE TIME
1 0
 PICK UP
5 0
 FOR DATE TIME
5
 PICK UP
1 0
 CA/AMT/TEND

P. UP	\$5.00
P. UP	\$0.50
CASH	\$5.50

Changing media in drawer

Use this procedure to change media in drawer.

REG

Mode switch

OPERATION

RECEIPT

Media	Check	-10.00
	Cash	\$8.00
	Charge	\$2.00

MEDIA CHANGE
1 0 00 CHK
 Enter the amount to be changed.
8 00 CA/AMT/TEND
2 00 CH

MEDIA CHG
CHECK	\$10.00
CASH	\$8.00
CHARGE	\$2.00

Bottle link operation

You can link PLU to a PLU.

Example

OPERATION			RECEIPT																							
Item 1	PLU 1	(\$8.00)	1	PLU	<table border="1"> <tr><td>1</td><td>PLU0001</td><td>\$8.00</td></tr> <tr><td>1</td><td>PLU0011</td><td>\$0.80</td></tr> <tr><td>3</td><td>PLU0002</td><td>\$15.00</td></tr> <tr><td>3</td><td>PLU0012</td><td>\$1.50</td></tr> <tr><td>TL</td><td></td><td>\$25.30</td></tr> <tr><td>CASH</td><td></td><td>\$30.00</td></tr> <tr><td>CG</td><td></td><td>\$4.70</td></tr> </table>	1	PLU0001	\$8.00	1	PLU0011	\$0.80	3	PLU0002	\$15.00	3	PLU0012	\$1.50	TL		\$25.30	CASH		\$30.00	CG		\$4.70
	1	PLU0001	\$8.00																							
	1	PLU0011	\$0.80																							
3	PLU0002	\$15.00																								
3	PLU0012	\$1.50																								
TL		\$25.30																								
CASH		\$30.00																								
CG		\$4.70																								
PLU 11 _{linked}	(\$0.80)	3	X / FOR DATE TIME																							
Quantity	1	2	PLU																							
Item 2	PLU 2	(\$5.00)	3	0																						
	PLU 12 _{linked}	(\$0.50)	00	CA / AMT TEND																						
	Quantity	3																								
Payment	Cash	\$30.00																								

Bottle returns

Bottle return key

You can use the linked bottle return key to register a bottle return. A PLU whose programmed unit price represents the contents of the bottle, can be linked with PLU whose programmed unit price represents the deposit on the bottle. In the following example, the bottle return key has been programmed to operate as a linked bottle return key.

The bottle return key must be pressed before input of each new linked bottle return.

Example

OPERATION			RECEIPT																				
Return Item 1	PLU 1	(\$8.00)	BR	1	<table border="1"> <tr><td>BR</td><td>.....</td><td></td></tr> <tr><td>1</td><td>PLU0011</td><td>-0.80</td></tr> <tr><td>BR</td><td>.....</td><td></td></tr> <tr><td>3</td><td>PLU0012</td><td>-1.50</td></tr> <tr><td>TL</td><td></td><td>-2.30</td></tr> <tr><td>CASH</td><td></td><td>-2.30</td></tr> </table>	BR		1	PLU0011	-0.80	BR		3	PLU0012	-1.50	TL		-2.30	CASH		-2.30
	BR																					
	1	PLU0011	-0.80																				
BR																						
3	PLU0012	-1.50																					
TL		-2.30																					
CASH		-2.30																					
PLU 11 _{linked}	(\$0.80)	3	X / FOR DATE TIME																				
Quantity	1	BR	2																				
Return Item 2	PLU 2	(\$5.00)		CA / AMT TEND																			
	PLU 12 _{linked}	(\$0.50)																					
	Quantity	3																					
Payment	Cash	\$2.30																					

Arrangement key registrations

Key operations can be assigned to an <ARRANGE> (arrangement key). Then, simply pressing <ARRANGE> performs all of the key functions assigned to it.

Key operations can also be assigned to an address code. Then, when you input the address code using <ARRANGE>, all of the key functions assigned to the address code are performed.

Example 1

OPERATION			RECEIPT
Arrangement 1			<div style="border: 1px solid black; padding: 5px; display: inline-block;"> ARR 1 PLU0001 \$8.00 1 PLU0002 \$5.00 TL \$13.00 CASH \$13.00 </div>
Item 1	PLU 1	(\$8.00)	
	Quantity	1	
Item 2	PLU 2	(\$5.00)	
	Quantity	1	
Payment	Cash	\$13.00	

Example 2

OPERATION			RECEIPT
Arrangement 5			<div style="border: 1px solid black; padding: 5px; display: inline-block;"> 5 ARR 1 DEPT01 \$1.00 1 DEPT02 \$2.00 TL \$3.00 CASH \$3.00 </div>
Item 1	Dept 1	\$1.00	
	Quantity	1	
Item 2	Dept 2	\$2.00	
	Quantity	1	
Payment	Cash	\$3.00	

Set menu

When you register a set menu, its total amount is added to the PLU totalizer and counter. The price of each set menu item is also added to each respective PLU totalizer and counter.

Example

OPERATION			RECEIPT
Set menu	PLU 35	\$5.00	<div style="border: 1px solid black; padding: 5px; display: inline-block;"> 3 5 PLU CA/AMT TEND 1 PLU0035 \$5.00 PLU0001 PLU0002 PLU0003 PLU0004 TL \$5.00 CASH \$5.00 </div>
Item 1	PLU 1	--	
Item 2	PLU 2	--	
Item 3	PLU 3	--	
Item 4	PLU 4	--	
Payment	Cash	\$5.00	

Currency exchange function

When <CE> (currency exchange key) is pressed, a current subtotal including tax is converted directly into foreign currency and the result is displayed, and the subsequent finalization is handled using the foreign currency. The currency exchange function is released by finalizing a transaction, partial tender operation, receipt issuance, or by pressing <SUBTOTAL>.



Before using the currency exchange function, it is necessary to program the conversion rate.























Registering foreign currency

Full amount tender in foreign currency

* Pre-programmed exchange rate: ¥ 100 = \$0.9524

Important!

Tenders in a foreign currency can be registered using the  and  only. Other finalize keys cannot be used.

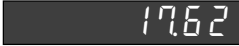
OPERATION	DISPLAY	RECEIPT														
<p>    ← Enter the unit price and press the applicable department key.</p>	<p> (Displays in \$)</p>	<table border="1"> <tr> <td>1 DEPT01</td> <td>\$10.00</td> </tr> <tr> <td>1 DEPT02</td> <td>\$20.00</td> </tr> <tr> <td>TL</td> <td>\$30.00</td> </tr> <tr> <td>CE</td> <td></td> </tr> <tr> <td>CASH</td> <td>¥5,000</td> </tr> <tr> <td>CASH</td> <td>\$47.62</td> </tr> <tr> <td>CG</td> <td>\$17.62</td> </tr> </table>	1 DEPT01	\$10.00	1 DEPT02	\$20.00	TL	\$30.00	CE		CASH	¥5,000	CASH	\$47.62	CG	\$17.62
1 DEPT01	\$10.00															
1 DEPT02	\$20.00															
TL	\$30.00															
CE																
CASH	¥5,000															
CASH	\$47.62															
CG	\$17.62															
<p>    ← Enter the next unit price and press the applicable department key.</p>	<p> (Displays in \$)</p>															
<p>  ← Press  and  without entering a numeric value. This operation converts the subtotal (including tax) dollar value into yen by applying a pre-programmed exchange rate. The result is shown on the display and printed on the receipt/journal by programming.</p>	<p> (Displays in ¥: 3,150)</p>															
<p>    ← Enter the amount tendered in yen and press . This operation converts the entered yen amount into dollars by applying a pre-programmed exchange rate. The result is shown on the display.</p> <p>(5,000)</p>	<p></p>															
<p> ← Press to finalize the transaction. Note that you do not need to reenter the dollar amount. The register automatically calculates the change amount due in dollars and shows it on the display, receipts and journal.</p>	<p> (Displays in \$)</p>															

Partial tender in a foreign currency

* Pre-programmed exchange rate: ¥ 100 = \$0.9524

Important!

Partial tender in a foreign currency can be registered using **CA/AMT/TEND** and **CHK** only. Other finalization keys cannot be used, but the remaining tender can be finalized using any finalize key.

OPERATION

1 0 00 **1**

← Enter the unit price and press the applicable department key.

2 0 00 **2**

← Enter the next unit price and press the applicable department key.

CE **SUB TOTAL**

← Press **CE** and **SUB TOTAL** without entering a numeric value. This operation converts the subtotal (including tax) dollar value into yen by applying a pre-programmed exchange rate. The result is shown on the display and printed on the receipt/journal by programming.

2 0 00 **CE**
(2,000)

← Enter the partial amount tendered in yen and press **CE**. This operation converts the entered yen amount into dollars by applying a pre-programmed exchange rate. The result is shown on the display.

CA/AMT/TEND

← Press **CA/AMT/TEND** to specify cash tender for the yen partial tender. Note that you do not need to reenter the dollar amount. The register automatically deducts the dollar equivalent of the yen amount tendered from the total amount due and shows the amount on the display.

CHK

← Press to finalize the transaction.

DISPLAY

10.00
(Displays in \$)

20.00
(Displays in \$)

3.150
(Displays in ¥: 3,150)

2.000

10.95
(Displays in \$)

10.95
(Displays in \$)

RECEIPT

1	DEPT01	\$10.00
1	DEPT02	\$20.00
	TL	\$30.00
	CE	
	CASH	¥2,000
	CASH	\$19.05
	CHECK	\$10.95

Food stamp function

Food stamp registration

No change due



OPERATION

RECEIPT

Item 1	Dept. 1	\$1.00
	Taxable	1, F/S
Item 2	Dept. 2	\$2.00
	Taxable	2
Item 3	Dept. 3	\$3.00
	Taxable	No → F/S
Payment	Food stamp	\$2.00
	Cash	\$4.14



Shifting food stamp status, press **F/S** key.

FS/ST

Press **FS/ST**, at the top of the food stamp tender.



CA/AMT/TEND

1	DEPT01	T1 F	\$1.00	
1	DEPT02	T2	\$2.00	
1	DEPT03	F	\$3.00	
	TA1		\$1.00	
	TX1		\$0.04	
	TA2		\$2.00	
	TX2		\$0.10	
	TL		\$6.14	Subtotal
	FSST		\$4.04	Food stamp subtotal
	FSTD		\$2.00	Food stamp tendered
	CASH		\$4.14	

Mixed food stamp/cash change

Example 1

OPERATION			RECEIPT																																														
Item 1	Dept. 1	\$1.00	1 00	1	<table border="0"> <tr><td>1 DEPT01</td><td>T1 F</td><td>\$1.00</td><td></td></tr> <tr><td>1 DEPT02</td><td>T2 F</td><td>\$2.00</td><td></td></tr> <tr><td>1 DEPT03</td><td>F</td><td>\$3.00</td><td></td></tr> <tr><td>TA1</td><td></td><td>\$1.00</td><td></td></tr> <tr><td>TX1</td><td></td><td>\$0.04</td><td></td></tr> <tr><td>TA2</td><td></td><td>\$2.00</td><td></td></tr> <tr><td>TX2</td><td></td><td>\$0.10</td><td></td></tr> <tr><td>TL</td><td></td><td>\$6.14</td><td>Subtotal</td></tr> <tr><td>FSST</td><td></td><td>\$6.14</td><td>Food stamp subtotal</td></tr> <tr><td>FSTD</td><td></td><td>\$7.00</td><td>Food stamp tendered</td></tr> <tr><td>CG</td><td></td><td>\$0.86</td><td>Cash change</td></tr> </table>	1 DEPT01	T1 F	\$1.00		1 DEPT02	T2 F	\$2.00		1 DEPT03	F	\$3.00		TA1		\$1.00		TX1		\$0.04		TA2		\$2.00		TX2		\$0.10		TL		\$6.14	Subtotal	FSST		\$6.14	Food stamp subtotal	FSTD		\$7.00	Food stamp tendered	CG		\$0.86	Cash change
	1 DEPT01	T1 F	\$1.00																																														
1 DEPT02	T2 F	\$2.00																																															
1 DEPT03	F	\$3.00																																															
TA1		\$1.00																																															
TX1		\$0.04																																															
TA2		\$2.00																																															
TX2		\$0.10																																															
TL		\$6.14	Subtotal																																														
FSST		\$6.14	Food stamp subtotal																																														
FSTD		\$7.00	Food stamp tendered																																														
CG		\$0.86	Cash change																																														
Taxable	1, F/S		F/S 2 00	2																																													
Item 2	Dept. 2	\$2.00	F/S 3 00	3																																													
	Taxable	2, F/S		FS/ST																																													
Item 3	Dept. 3	\$3.00	7 00	FS/TD																																													
	Taxable	F/S																																															
Payment	Food stamp	\$7.00																																															

The change in food stamp transactions is automatically calculated as cash for amounts of \$1.00 or less, and as food stamps for amounts greater than \$1.00.

Example 2

OPERATION			RECEIPT																																		
Item	Dept. 1	\$2.00	2 00	1	<table border="0"> <tr><td>1 DEPT01</td><td>T1 F</td><td>\$2.00</td><td></td></tr> <tr><td>TA1</td><td></td><td>\$2.00</td><td></td></tr> <tr><td>TX1</td><td></td><td>\$0.08</td><td></td></tr> <tr><td>TL</td><td></td><td>\$2.08</td><td></td></tr> <tr><td>FSST</td><td></td><td>\$2.08</td><td></td></tr> <tr><td>FSTD</td><td></td><td>\$5.00</td><td></td></tr> <tr><td>FSCG</td><td></td><td>\$2.00</td><td></td></tr> <tr><td>CG</td><td></td><td>\$0.92</td><td></td></tr> </table>	1 DEPT01	T1 F	\$2.00		TA1		\$2.00		TX1		\$0.08		TL		\$2.08		FSST		\$2.08		FSTD		\$5.00		FSCG		\$2.00		CG		\$0.92	
	1 DEPT01	T1 F	\$2.00																																		
TA1		\$2.00																																			
TX1		\$0.08																																			
TL		\$2.08																																			
FSST		\$2.08																																			
FSTD		\$5.00																																			
FSCG		\$2.00																																			
CG		\$0.92																																			
Taxable	1, F/S			FS/ST																																	
Payment	Food stamp	\$5.00	5 00	FS/TD																																	

In the above example, the total amount of change due is \$2.92; \$2.00 in food stamps and \$0.92 in cash.

Advanced Operations

Mixed food stamp/cash change (continued...)

Example 3

OPERATION			RECEIPT																													
Item 1	Dept. 1	\$2.00	2 00	1	<table border="1"> <tr><td>1 DEPT01</td><td>T1 F</td><td>\$1.00</td></tr> <tr><td>1 DEPT04</td><td></td><td>\$0.50</td></tr> <tr><td>TA1</td><td></td><td>\$2.00</td></tr> <tr><td>TX1</td><td></td><td>\$0.08</td></tr> <tr><td>TL</td><td></td><td>\$2.58</td></tr> <tr><td>FSST</td><td></td><td>\$2.08</td></tr> <tr><td>FSTD</td><td></td><td>\$5.00</td></tr> <tr><td>FSCG</td><td></td><td>\$2.00</td></tr> <tr><td>CG</td><td></td><td>\$0.42</td></tr> </table>	1 DEPT01	T1 F	\$1.00	1 DEPT04		\$0.50	TA1		\$2.00	TX1		\$0.08	TL		\$2.58	FSST		\$2.08	FSTD		\$5.00	FSCG		\$2.00	CG		\$0.42
	1 DEPT01	T1 F	\$1.00																													
1 DEPT04		\$0.50																														
TA1		\$2.00																														
TX1		\$0.08																														
TL		\$2.58																														
FSST		\$2.08																														
FSTD		\$5.00																														
FSCG		\$2.00																														
CG		\$0.42																														
Taxable	1, F/S		5 0	4																												
Item 2	Dept. 4	\$0.50		FS/ST																												
	Taxable	No	5 00	FS/TD																												
Payment	Food stamp	\$5.00																														

When food stamp items are included in a transaction, the amount of change due in cash is applied as a cash amount tendered for cash (nonfood stamp) items. In this example, the \$0.50 purchased (department 4) is automatically deducted from the \$0.92 cash due in change from the food stamp purchase (department 4).

Example 4

OPERATION			RECEIPT																																						
Item 1	Dept. 1	\$1.00	1 00	1	<table border="1"> <tr><td>1 DEPT01</td><td>T1 F</td><td>\$1.00</td></tr> <tr><td>1 DEPT02</td><td>T2</td><td>\$2.00</td></tr> <tr><td>1 DEPT03</td><td></td><td>\$3.00</td></tr> <tr><td>TA1</td><td></td><td>\$1.00</td></tr> <tr><td>TX1</td><td></td><td>\$0.04</td></tr> <tr><td>TA2</td><td></td><td>\$2.00</td></tr> <tr><td>TX2</td><td></td><td>\$0.10</td></tr> <tr><td>TL</td><td></td><td>\$6.14</td></tr> <tr><td>FSST</td><td></td><td>\$1.04</td></tr> <tr><td>FSTD</td><td></td><td>\$5.00</td></tr> <tr><td>FSCG</td><td></td><td>\$3.00</td></tr> <tr><td>CASH</td><td></td><td>\$4.14</td></tr> </table>	1 DEPT01	T1 F	\$1.00	1 DEPT02	T2	\$2.00	1 DEPT03		\$3.00	TA1		\$1.00	TX1		\$0.04	TA2		\$2.00	TX2		\$0.10	TL		\$6.14	FSST		\$1.04	FSTD		\$5.00	FSCG		\$3.00	CASH		\$4.14
	1 DEPT01	T1 F	\$1.00																																						
1 DEPT02	T2	\$2.00																																							
1 DEPT03		\$3.00																																							
TA1		\$1.00																																							
TX1		\$0.04																																							
TA2		\$2.00																																							
TX2		\$0.10																																							
TL		\$6.14																																							
FSST		\$1.04																																							
FSTD		\$5.00																																							
FSCG		\$3.00																																							
CASH		\$4.14																																							
Taxable	1, F/S		2 00	2																																					
Item 2	Dept. 2	\$2.00	3 00	3																																					
	Taxable	2		FS/ST																																					
Item 3	Dept. 3	\$3.00	5 00	FS/TD																																					
	Taxable	No		CA/AMT/TEND																																					
Payment	Food stamp	\$5.00																																							
	Cash	\$4.14																																							

The following calculation is performed internally to apply the cash change due on the food stamp transaction to the balance due of the cash transaction.

	Food stamp transaction	Cash transaction
Price items:	\$1.00	\$5.00
Tax:	\$0.04	\$0.10
Total due:	\$1.04	\$5.10
Amount tendered:	\$5.00 (food stamp)	\$4.14 (cash), \$0.96 (change from food stamp)
Amount due:	\$1.04	
Change amount due:	\$3.00 (food stamp), \$0.96 (cash)	
Total:		\$5.10

Food stamp registration (Illinois rule)

No change due

Example 1

			OPERATION	RECEIPT															
Item 1	Dept. 1	\$1.00	1 00 1	<table border="1"> <tr><td>1 DEPT01</td><td>T1 F</td><td>\$1.00</td></tr> <tr><td>1 DEPT01</td><td>T1 F</td><td>\$2.00</td></tr> <tr><td>1 DEPT04</td><td>F</td><td>\$3.00</td></tr> <tr><td>FSST</td><td></td><td>\$6.00</td></tr> <tr><td>FSTD</td><td></td><td>\$6.00</td></tr> </table>	1 DEPT01	T1 F	\$1.00	1 DEPT01	T1 F	\$2.00	1 DEPT04	F	\$3.00	FSST		\$6.00	FSTD		\$6.00
	1 DEPT01	T1 F	\$1.00																
1 DEPT01	T1 F	\$2.00																	
1 DEPT04	F	\$3.00																	
FSST		\$6.00																	
FSTD		\$6.00																	
Taxable	1, F/S		2 00 1																
Item 2	Dept. 1	\$2.00	3 00 4																
	Taxable	1, F/S	FS/ST																
Item 3	Dept. 4	\$3.00	6 00 FS/TD																
	Taxable	F/S																	
Payment	Food stamp	\$6.00																	

Example 2

			OPERATION	RECEIPT																								
Item 1	Dept. 1	\$2.00	2 00 1	<table border="1"> <tr><td>1 DEPT01</td><td>T1 F</td><td>\$2.00</td></tr> <tr><td>1 DEPT01</td><td>T1 F</td><td>\$3.00</td></tr> <tr><td>1 DEPT04</td><td>T1 F</td><td>\$4.00</td></tr> <tr><td>FSST</td><td></td><td>\$9.00</td></tr> <tr><td>FSTD</td><td></td><td>\$5.00</td></tr> <tr><td>TA1</td><td></td><td>\$4.00</td></tr> <tr><td>TX1</td><td></td><td>\$0.16</td></tr> <tr><td>CASH</td><td></td><td>\$4.16</td></tr> </table>	1 DEPT01	T1 F	\$2.00	1 DEPT01	T1 F	\$3.00	1 DEPT04	T1 F	\$4.00	FSST		\$9.00	FSTD		\$5.00	TA1		\$4.00	TX1		\$0.16	CASH		\$4.16
	1 DEPT01	T1 F	\$2.00																									
1 DEPT01	T1 F	\$3.00																										
1 DEPT04	T1 F	\$4.00																										
FSST		\$9.00																										
FSTD		\$5.00																										
TA1		\$4.00																										
TX1		\$0.16																										
CASH		\$4.16																										
Taxable	1, F/S		3 00 1																									
Item 2	Dept. 1	\$3.00	4 00 4																									
	Taxable	1, F/S	FS/ST																									
Item 3	Dept. 4	\$4.00	5 00 FS/TD																									
	Taxable	1, F/S																										
Payment	Food stamp	\$5.00	CA/AMT /TEND																									
	Cash	\$4.16																										

Advanced Operations

No change due (continued...)

Example 3

			OPERATION	RECEIPT																											
Item 1	Dept. 1	\$2.00	2 00 <input type="text" value="1"/>	<table border="1"> <tr><td>1 DEPT01</td><td>T1 F</td><td>\$2.00</td></tr> <tr><td>1 DEPT02</td><td>T2 F</td><td>\$3.00</td></tr> <tr><td>FSST</td><td></td><td>\$5.00</td></tr> <tr><td>FSTD</td><td></td><td>\$1.00</td></tr> <tr><td>TA1</td><td></td><td>\$1.00</td></tr> <tr><td>TX1</td><td></td><td>\$0.04</td></tr> <tr><td>TA2</td><td></td><td>\$3.00</td></tr> <tr><td>TX2</td><td></td><td>\$0.15</td></tr> <tr><td>CASH</td><td></td><td>\$4.19</td></tr> </table>	1 DEPT01	T1 F	\$2.00	1 DEPT02	T2 F	\$3.00	FSST		\$5.00	FSTD		\$1.00	TA1		\$1.00	TX1		\$0.04	TA2		\$3.00	TX2		\$0.15	CASH		\$4.19
	1 DEPT01	T1 F	\$2.00																												
1 DEPT02	T2 F	\$3.00																													
FSST		\$5.00																													
FSTD		\$1.00																													
TA1		\$1.00																													
TX1		\$0.04																													
TA2		\$3.00																													
TX2		\$0.15																													
CASH		\$4.19																													
	Taxable	1, F/S	3 00 <input type="text" value="2"/>																												
Item 2	Dept. 2	\$3.00	<input type="text" value="FS/ST"/>																												
	Taxable	2, F/S	1 00 <input type="text" value="FS/TD"/>																												
Payment	Food stamp	\$1.00	<input type="text" value="CA/AMT/TEND"/>																												
	Cash	\$4.19																													

In this case, the result of the taxable 1 amount is \$1.00 (2.00 - 1.00), the taxable 2 amount is \$3.00.

Example 4

			OPERATION	RECEIPT																					
Item 1	Dept. 1	\$1.00	1 00 <input type="text" value="1"/>	<table border="1"> <tr><td>1 DEPT01</td><td>T1 F</td><td>\$1.00</td></tr> <tr><td>1 DEPT02</td><td>T2 F</td><td>\$5.00</td></tr> <tr><td>FSST</td><td></td><td>\$6.00</td></tr> <tr><td>FSTD</td><td></td><td>\$4.00</td></tr> <tr><td>TA2</td><td></td><td>\$2.00</td></tr> <tr><td>TX2</td><td></td><td>\$0.10</td></tr> <tr><td>CASH</td><td></td><td>\$2.10</td></tr> </table>	1 DEPT01	T1 F	\$1.00	1 DEPT02	T2 F	\$5.00	FSST		\$6.00	FSTD		\$4.00	TA2		\$2.00	TX2		\$0.10	CASH		\$2.10
	1 DEPT01	T1 F	\$1.00																						
1 DEPT02	T2 F	\$5.00																							
FSST		\$6.00																							
FSTD		\$4.00																							
TA2		\$2.00																							
TX2		\$0.10																							
CASH		\$2.10																							
	Taxable	1, F/S	5 00 <input type="text" value="2"/>																						
Item 2	Dept. 2	\$5.00	<input type="text" value="FS/ST"/>																						
	Taxable	2, F/S	4 00 <input type="text" value="FS/TD"/>																						
Payment	Food stamp	\$4.00	<input type="text" value="CA/AMT/TEND"/>																						
	Cash	\$2.10																							

In this case, the result of the taxable 1 amount is \$0.00 (1.00 - 1.00), the taxable 2 amount is \$2.00 (5.00 - (3.00 - 1.00)).

Mixed food stamp/cash change

Example 1

			OPERATION	RECEIPT																					
Item 1	Dept. 1	\$1.50	1 5 0 <input type="text" value="1"/>	<table border="1"> <tr><td>1 DEPT01</td><td>T1 F</td><td>\$1.50</td></tr> <tr><td>1 DEPT01</td><td>T1 F</td><td>\$2.00</td></tr> <tr><td>1 DEPT04</td><td>F</td><td>\$3.00</td></tr> <tr><td>FSST</td><td></td><td>\$6.50</td></tr> <tr><td>FSTD</td><td></td><td>\$10.00</td></tr> <tr><td>FSCG</td><td></td><td>\$3.00</td></tr> <tr><td>CG</td><td></td><td>\$0.50</td></tr> </table>	1 DEPT01	T1 F	\$1.50	1 DEPT01	T1 F	\$2.00	1 DEPT04	F	\$3.00	FSST		\$6.50	FSTD		\$10.00	FSCG		\$3.00	CG		\$0.50
	1 DEPT01	T1 F	\$1.50																						
1 DEPT01	T1 F	\$2.00																							
1 DEPT04	F	\$3.00																							
FSST		\$6.50																							
FSTD		\$10.00																							
FSCG		\$3.00																							
CG		\$0.50																							
Taxable	1, F/S		2 00 <input type="text" value="1"/>																						
Item 2	Dept. 1	\$2.00	3 00 <input type="text" value="4"/>																						
	Taxable	1, F/S	<input type="text" value="FS/ST"/>																						
Item 3	Dept. 4	\$3.00	1 0 00 <input type="text" value="FS/TD"/>																						
	Taxable	F/S																							
Payment	Food stamp	\$10.00																							

The change in food stamp transactions is automatically calculated as cash for amount of \$1.00 or less, and as food stamps for amounts greater than \$1.00. In the above example, the total amount of change due is \$3.50 (\$3.00 in food stamps and \$0.50 in cash).

Example 2

			OPERATION	RECEIPT												
Item	Dept. 1	\$2.00	2 00 <input type="text" value="1"/>	<table border="1"> <tr><td>1 DEPT01</td><td>T1 F</td><td>\$2.00</td></tr> <tr><td>FSST</td><td></td><td>\$2.00</td></tr> <tr><td>FSTD</td><td></td><td>\$5.00</td></tr> <tr><td>FSCG</td><td></td><td>\$3.00</td></tr> </table>	1 DEPT01	T1 F	\$2.00	FSST		\$2.00	FSTD		\$5.00	FSCG		\$3.00
	1 DEPT01	T1 F	\$2.00													
FSST		\$2.00														
FSTD		\$5.00														
FSCG		\$3.00														
Taxable	1, F/S		<input type="text" value="FS/ST"/>													
Payment	Food stamp	\$5.00	5 00 <input type="text" value="FS/TD"/>													

Advanced Operations

Mixed food stamp/cash change (continued...)

Example 3

			OPERATION	RECEIPT																											
Item 1	Dept. 1	\$2.00	2 00 1	<table border="1"> <tr><td>1 DEPT01</td><td>T1 F</td><td>\$2.00</td></tr> <tr><td>1 DEPT01</td><td>T1 F</td><td>\$1.20</td></tr> <tr><td>1 DEPT03</td><td>T1</td><td>\$0.30</td></tr> <tr><td>TA1</td><td></td><td>\$0.30</td></tr> <tr><td>TX1</td><td></td><td>\$0.01</td></tr> <tr><td>FSST</td><td></td><td>\$3.20</td></tr> <tr><td>FSTD</td><td></td><td>\$5.00</td></tr> <tr><td>FSCG</td><td></td><td>\$1.00</td></tr> <tr><td>CG</td><td></td><td>\$0.49</td></tr> </table>	1 DEPT01	T1 F	\$2.00	1 DEPT01	T1 F	\$1.20	1 DEPT03	T1	\$0.30	TA1		\$0.30	TX1		\$0.01	FSST		\$3.20	FSTD		\$5.00	FSCG		\$1.00	CG		\$0.49
	1 DEPT01	T1 F	\$2.00																												
1 DEPT01	T1 F	\$1.20																													
1 DEPT03	T1	\$0.30																													
TA1		\$0.30																													
TX1		\$0.01																													
FSST		\$3.20																													
FSTD		\$5.00																													
FSCG		\$1.00																													
CG		\$0.49																													
	Taxable	1, F/S	1 2 0 1																												
Item 2	Dept. 1	\$1.20	3 0 3																												
	Taxable	1, F/S	FS/ST																												
Item 3	Dept. 3	\$0.30	5 00 FS/TD																												
	Taxable	1																													
Payment	Food stamp	\$5.00																													

When food stamp items are included in a transaction, the amount of change due in cash is applied as a cash amount tendered for cash (nonfood stamp) items. In this example, the \$0.30 purchase is automatically deducted from the \$0.80 cash due in change from the food stamp purchase.

Example 4

			OPERATION	RECEIPT																					
Item 1	Dept. 1	\$1.00	1 00 1	<table border="1"> <tr><td>1 DEPT01</td><td>T1 F</td><td>\$1.00</td></tr> <tr><td>1 DEPT01</td><td>T1 F</td><td>\$2.50</td></tr> <tr><td>1 DEPT03</td><td></td><td>\$5.00</td></tr> <tr><td>FSST</td><td></td><td>\$3.50</td></tr> <tr><td>FSTD</td><td></td><td>\$5.00</td></tr> <tr><td>FSCG</td><td></td><td>\$1.00</td></tr> <tr><td>CASH</td><td></td><td>\$4.50</td></tr> </table>	1 DEPT01	T1 F	\$1.00	1 DEPT01	T1 F	\$2.50	1 DEPT03		\$5.00	FSST		\$3.50	FSTD		\$5.00	FSCG		\$1.00	CASH		\$4.50
	1 DEPT01	T1 F	\$1.00																						
1 DEPT01	T1 F	\$2.50																							
1 DEPT03		\$5.00																							
FSST		\$3.50																							
FSTD		\$5.00																							
FSCG		\$1.00																							
CASH		\$4.50																							
	Taxable	1, F/S	2 5 0 1																						
Item 2	Dept. 1	\$2.50	5 00 3																						
	Taxable	1, F/S	FS/ST																						
Item 3	Dept. 3	\$5.00	5 00 FS/TD																						
	Taxable	No																							
Payment	Food stamp	\$5.00	CA/AMT/TEND																						
	Cash	\$4.50																							

The following calculation is performed internally to apply the cash change due on the food stamp transaction to the balance due of the cash transaction.

	Food stamp transaction	Cash transaction
Price items:	\$3.50	\$5.00
Tax:	\$0.00	\$0.00
Total due:	\$3.50	\$5.00
Amount tendered:	\$5.00 (food stamp)	\$4.50 (cash), \$0.50 (change from food stamp)
Amount due:	\$3.50	
Change amount due:	\$1.00 (food stamp), \$0.50 (cash)	
Total:		\$5.00

Electronic benefits transfer

In addition to standard food stamp tender finalizations, this model also allows finalization for tenders electronic benefits transfer (EBT) card.

EBT tenders can be accepted for New Jersey rule or Illinois rule food stamp tenders, as well as for food stamp tenders that do not follow these rules.

About mixed EBT card tenders

When the register is programmed to prohibit an EBT amount tendered that exceeds the food stamp subtotal, nonfood stamp items cannot be paid for using an EBT card. In this case, the following applies:

- $ST - (EBT/TEND - FS/ST) = \text{Balance due}$ (the remaining balance due must be finalized using another finalize key.)

When the register is programmed to allow an EBT amount tendered that exceeds the food stamp subtotal, nonfood stamp items can be paid for using an EBT card. In this case, there are two possible situations:

- $ST > EBT/TEND$
 $ST - (EBT/TEND - FS/ST) = \text{Balance due}$ (the remaining balance due must be finalized using another finalize key.)
- $EBT/TEND > \text{or} = ST$
 $EBT/TEND - ST = \text{cash change}$

No change due

Example 1

			OPERATION	RECEIPT																		
Item 1	Dept. 1	\$1.00	1 00 1	<table border="1"> <tr><td>1 DEPT01</td><td>T1 F</td><td>\$1.00</td></tr> <tr><td>1 DEPT02</td><td>T2 F</td><td>\$2.00</td></tr> <tr><td>1 DEPT03</td><td>F</td><td>\$2.00</td></tr> <tr><td>TL</td><td></td><td>\$6.00</td></tr> <tr><td>FSST</td><td></td><td>\$6.00</td></tr> <tr><td>EBT TD</td><td></td><td>\$6.00</td></tr> </table>	1 DEPT01	T1 F	\$1.00	1 DEPT02	T2 F	\$2.00	1 DEPT03	F	\$2.00	TL		\$6.00	FSST		\$6.00	EBT TD		\$6.00
	1 DEPT01	T1 F	\$1.00																			
1 DEPT02	T2 F	\$2.00																				
1 DEPT03	F	\$2.00																				
TL		\$6.00																				
FSST		\$6.00																				
EBT TD		\$6.00																				
Taxable	1, F/S		2 00 2																			
Item 2	Dept. 2	\$2.00	3 00 3																			
	Taxable	2, F/S	FS/ST																			
Item 3	Dept. 3	\$3.00																				
	Taxable	F/S	6 00 EBT																			
Payment	EBT	\$6.00																				

Advanced Operations

Example 2

OPERATION			RECEIPT		
Item 1	Dept. 1	\$1.00	1 00 1	1 DEPT01 T1 F \$1.00 1 DEPT02 T1 F \$2.00 1 DEPT03 T1 \$3.00 FSST \$3.00 EBTTD \$5.00 TA1 \$3.00 TX1 \$0.12 CASH \$1.12	
	Taxable	1, F/S	2 00 2		
Item 2	Dept. 2	\$2.00	3 00 3		
	Taxable	1, F/S	FS/ST		
Item 3	Dept. 3	\$3.00	5 00 EBT		
	Taxable	1	CA/AMT/TEND		
Payment	EBT	\$5.00			
	Cash	\$1.12			

Change due

OPERATION			RECEIPT		
Item 1	Dept. 1	\$1.00	1 00 1	1 DEPT01 T1 F \$1.00 1 DEPT02 T1 F \$1.20 1 DEPT03 T1 \$0.30 TA1 \$0.30 TX1 \$0.01 TL \$2.51 FSST \$2.20 EBTTD \$5.00 CG \$2.49	
	Taxable	1, F/S	1 2 0 2		
Item 2	Dept. 2	\$1.20	3 0 3		
	Taxable	1, F/S	FS/ST		
Item 3	Dept. 3	\$0.30	5 00 EBT		
	Taxable	1			
Payment	EBT	\$5.00			

Tips

Example

OPERATION			RECEIPT		
Item 1	Unit price	\$3.00	3 00 1	1 DEPT01 \$3.00 1 DEPT02 \$5.00 TIP \$0.80 TL \$8.80 CASH \$10.00 CG \$1.20	
	Dept.	1	5 00 2		
Item 2	Unit price	\$5.00	SUB TOTAL		
	Dept.	2	8 0 TIP		
Tip	Amount	\$0.80	1 0 00 CA/AMT/TEND		
Payment	Cash	\$10.00			

Inputting the number of customers

Example 1

OPERATION			RECEIPT		
Item 1	Unit price	\$15.00	2	CST	
	Dept.	1	1	5	00
				1	
Item 2	Unit price	\$5.00	5	00	2
	Dept.	2			
Customer	Number	2			
Payment	Cash	\$20.00			

CT		2
1 DEPT01	\$15.00	
1 DEPT02	\$5.00	
TL	\$20.00	
CASH	\$20.00	

Example 2

You can only use the following operation to re-input the number of customers when <CUSTOMER> (customer number key) is preset to allow re-input. When programming prohibits re-input of the number of customers, this operation causes an error.

OPERATION			RECEIPT		
		3	CST		
1	5	00	1		
		5	00	2	
		2	CST		
			SUB		
			TOTAL		
			CA/AMT		
			TEND		

CT		3
1 DEPT01	\$15.00	
1 DEPT02	\$5.00	
CT		2
TL	\$20.00	
CASH	\$20.00	

You can re-input the number of customers either immediately after the initial input or during later registration.

Example 3

You can use the following operation to add customers to an original number of customers input (when addition to the number of the customer is allowed).

OPERATION			RECEIPT		
		3	CST		
1	5	00	1		
		5	00	2	
		2	CST		
			SUB		
			TOTAL		
			CA/AMT		
			TEND		

CT		3
1 DEPT01	\$15.00	
1 DEPT02	\$5.00	
CT		5
TL	\$20.00	
CASH	\$20.00	

Advanced Operations

Text recall

This procedure is used to recall text by inputting the address where the text is stored. The recalled text is printed on the receipt and journal.

Example

OPERATION			RECEIPT																									
Item 1	Unit price	\$46.00	4	6	00	1	<table border="1"> <tr><td>CT</td><td></td><td>3</td></tr> <tr><td>1 DEPT01</td><td>\$46.00</td><td></td></tr> <tr><td>MEDIUM SIZE</td><td></td><td></td></tr> <tr><td>1 DEPT02</td><td>\$10.00</td><td></td></tr> <tr><td>SMALL SIZE</td><td></td><td></td></tr> <tr><td>TL</td><td>\$56.00</td><td></td></tr> <tr><td>CASH</td><td>\$56.00</td><td></td></tr> </table>	CT		3	1 DEPT01	\$46.00		MEDIUM SIZE			1 DEPT02	\$10.00		SMALL SIZE			TL	\$56.00		CASH	\$56.00	
CT		3																										
1 DEPT01	\$46.00																											
MEDIUM SIZE																												
1 DEPT02	\$10.00																											
SMALL SIZE																												
TL	\$56.00																											
CASH	\$56.00																											
	Dept.	1																										
Item 2	Unit price	\$10.00	1	0	00	2																						
	Dept.	2																										
Payment	Cash	\$56.00																										
Text 1	MEDIUM SIZE																											
Text 2	SMALL SIZE																											

Temporarily releasing compulsion

<OPEN 2> (open 2 key) can be programmed to release specific compulsion.

Example 1

OPERATION			RECEIPT													
Item	Unit price	\$10.00	1	0	00	1	<table border="1"> <tr><td>1 DEPT01</td><td>\$10.00</td><td></td></tr> <tr><td>TL</td><td>\$10.00</td><td></td></tr> <tr><td>CHECK</td><td>\$10.00</td><td></td></tr> </table>	1 DEPT01	\$10.00		TL	\$10.00		CHECK	\$10.00	
1 DEPT01	\$10.00															
TL	\$10.00															
CHECK	\$10.00															
	Dept.	1	1	0	00	CHK										
Payment	Check	\$10.00														
Slip validation compulsory			2	00	2											
			Validation compulsory													
			Validation compulsory is temporarily released.													

Example 2

OPERATION			RECEIPT													
Input customer No. compulsory			1	0	00	1	<table border="1"> <tr><td>1 DEPT01</td><td>\$10.00</td><td></td></tr> <tr><td>TL</td><td>\$10.00</td><td></td></tr> <tr><td>CHECK</td><td>\$10.00</td><td></td></tr> </table>	1 DEPT01	\$10.00		TL	\$10.00		CHECK	\$10.00	
1 DEPT01	\$10.00															
TL	\$10.00															
CHECK	\$10.00															
Item	Unit price	\$10.00	Input customer No. compulsory													
	Dept.	1	Compulsory is temporarily released.													
Payment	Check	\$10.00														
			1	0	00	1										
			1	0	00	CHK										

Printing slip

To perform batch printing on the slip printer, you must first use the memory allocation operation (see program 5 mode in the dealer's manual) to reserve slip buffer memory. The capacity of the slip buffer memory is determined by the number of units of slip buffer memory reserved by the memory allocation operation.

The register can be programmed to check the status of the registration buffer memory whenever slip batch printing is performed, and sound an alarm when the buffer memory is almost full. The alarm sounds when there are 12 lines or less remaining, and once it starts to sound, the only operation you can perform is the cancel operation or operations using one of the following keys.

- <CA/AMT TEND> (cash/amount tendered key) operation
- <CH> (charge key) operation
- <CHK/TEND> (check tendered key) operation
- <DEPOSIT> (deposit key) operation
- <NEW BALANCE> (new balance key) operation
- <SUBTOTAL> (subtotal key) operation

You must perform one of above operations when the registration buffer alarm sounds. Any other operations results in an error.

Printing slips

The cash register can be connected to the optional SP-1300 slip printer, which features an automatic feed function and automatic back feed function.

• Automatic feed function

This function makes it possible to program the number of line feeds that should be inserted from the normal print start position before starting slip printing of a new slip. Even if line feeds are programmed for this function, they are not inserted for validation printing, check endorsement printing, and check printing performed using the slip printer. Note also that line feeds are not inserted automatically at the beginning of a second slip when the transaction requires printing that extends from one slip to another.

• Automatic back feed function

This function performs automatic back feed following slip printing, validation printing, and endorsement printing on the slip printer. The slip paper is released once the back feed operation is complete.

• Manual feed function

<SLIP FEED/RELEASE> (slip feed/release key: assigned to the register's keyboard using the program 4 mode) can be used for manual feed of the slip paper. You perform manual feed by inputting a value for the number of lines (up to two digits in the range of 1 to 99) and then press <SLIP FEED/RELEASE>.

• Manual back feed function

<SLIP BACK FEED/RELEASE> (slip back feed/release key: assigned to the register's keyboard using the program 4 mode) can be used for manual back feed of the slip paper. Manual back feed can be performed by inputting a value for the number of lines (up to two digits in the range of 1 to 99) and then press <SLIP BACK FEED/RELEASE>.

You can print slips using automatic or manual batch printing. The slip print operation can be performed in REG1, REG2, and RF modes only.

Finalizing a registration without inserting a slip paper into the slip printer when the register is programmed as "slip paper insertion into slip printer compulsory before finalizing registration" produces an error.

Advanced Operations

To perform auto batch printing 1

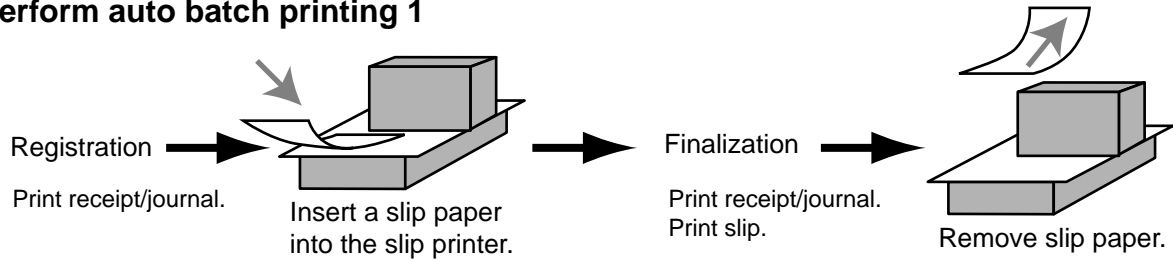

To perform auto batch printing 2

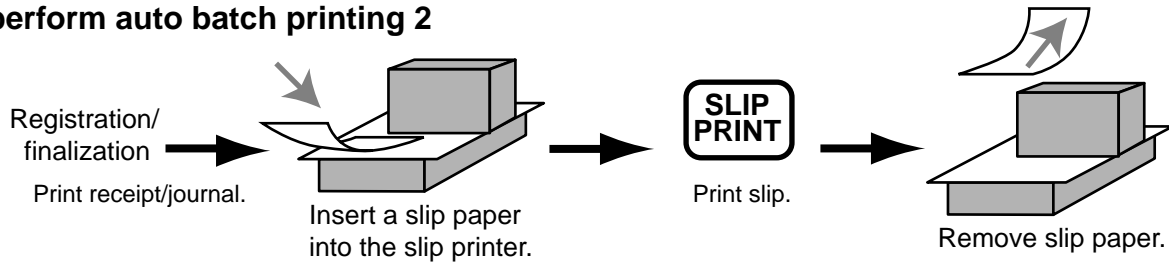

About the maximum number of slip lines

You can program the maximum number of lines that can be printed on a slip. Once you do, any attempt to exceed the preset maximum results in an error. When such an error occurs, press <C>, change slip paper and press <SLIP PRINT> to restart printing.

Check tracking systems

Check tracking system

With the check tracking system, the amount, check number, number of slip print lines, store number, date/time and registration detail data are stored in two files (check tracking index file and check tracking detail file).

- Check tracking detail file and index file are cleared by the following timing:
 1. The check is cleared after printing finalized data on slip or guest check receipts, or the check is also cleared when the new or old check operation is made.
 2. The check is cleared after printing finalized data on slip or guest check receipt, or check is also cleared when the same finalized check number is assigned in new check operation.You can select one of these options by programming.
- Auto new balance function
The register can be programmed so that whenever a clerk (by clerk key) signs off while a check is open, a <NEW BALANCE> operation is automatically performed to temporarily finalize the open check.
- You can specify a range of checks that can be opened by each clerk. Once you do, any attempt by a clerk to open a check using a number that is not within his specified range results in an error.
- Either of the following two operations can be used to correct input of a wrong check number.
 - <NEW CHECK>
Re-input the correct check number, or cancel the original check number, issue a receipt, and then re-input the correct check number.
 - <OLD CHECK>, <NEW/OLD>
Temporary finalize the original check number, issue a receipt, and then re-input the correct check number.

Opening a check

Example

OPERATION			RECEIPT
Check#	1234		<div style="border: 1px solid black; padding: 5px;"> <p>CHECK No. 1234</p> <p>TBL# 000033</p> <p>1 DEPT01 \$10.00</p> <p>1 DEPT01 \$10.00</p> <p>1 DEPT02 \$20.00</p> <p>1 DEPT02 \$20.00</p> <p>1 DEPT03 \$30.00</p> <p>+ \$0.50 — New balance fee</p> <p>SRVC TL \$90.50</p> </div>
Table#	33		
Item 1	Dept 1	\$10.00	
	Quantity	2	
Item 2	Dept 2	\$20.00	
	Quantity	2	
Item 3	Dept 3	\$30.00	
	Quantity	1	

1 2 3 4 NEW CHECK

3 3 TABLE #

1 0 00 1

2 0 00 2

3 0 00 3

Insert slip

NB

Remove slip

Press <NEW BALANCE> to temporarily close the transaction. If you want to finalize a check immediately, use <CASH>, <CHARGE>, <CREDIT> or <CHECK>.

Adding to a check

Example

OPERATION			RECEIPT
Check#	1234		<div style="border: 1px solid black; padding: 5px;"> <p>TABLE No. 000033 CT 1</p> <p>CHECK No. 1234</p> <p>ST \$90.50</p> <p>1 DEPT01 \$30.00</p> <p>1 DEPT02 \$10.00</p> <p>+ \$0.50</p> <p>SRVC TL</p> <p style="text-align: right;">- 131.00</p> </div>
Table#	33		
Item 1	Dept 1	\$30.00	
	Quantity	1	
Item 2	Dept 2	\$10.00	
	Quantity	1	

1 2 3 4 OLD CHECK

3 0 00 1

1 0 00 2

Insert slip

NB

Remove slip

- The table number is stored in the check tracking index memory so its input is not required in this operation even if table number input is preset as compulsory. Table number input after inputting the check number may be performed, however, without generating an error.
- Once a check is opened under a number in a certain mode (REG1 or REG2), the same mode must be used to make additions to the check.

Advanced Operations

Issuing a guest receipt

The following operation can be used to print out the balance of a temporarily finalized check.

Example

OPERATION	RECEIPT																																				
<p> <input type="button" value="1"/> <input type="button" value="2"/> <input type="button" value="3"/> <input type="button" value="4"/> <input type="button" value="GUEST RECEIPT"/> </p> <p>Input the number of check you want.</p>	<table border="1"> <tr> <td>TABLE No. 000033</td> <td>CT</td> <td>1</td> </tr> <tr> <td>CHECK No. 1234</td> <td></td> <td></td> </tr> <tr> <td>1 DEPT01</td> <td></td> <td>\$10.00</td> </tr> <tr> <td>1 DEPT01</td> <td></td> <td>\$10.00</td> </tr> <tr> <td>1 DEPT02</td> <td></td> <td>\$20.00</td> </tr> <tr> <td>1 DEPT02</td> <td></td> <td>\$20.00</td> </tr> <tr> <td>1 DEPT03</td> <td></td> <td>\$30.00</td> </tr> <tr> <td>+</td> <td></td> <td>\$0.50</td> </tr> <tr> <td>1 DEPT01</td> <td></td> <td>\$30.00</td> </tr> <tr> <td>1 DEPT02</td> <td></td> <td>\$10.00</td> </tr> <tr> <td>+</td> <td></td> <td>\$0.50</td> </tr> <tr> <td>SRVC TL</td> <td></td> <td>\$131.00</td> </tr> </table>	TABLE No. 000033	CT	1	CHECK No. 1234			1 DEPT01		\$10.00	1 DEPT01		\$10.00	1 DEPT02		\$20.00	1 DEPT02		\$20.00	1 DEPT03		\$30.00	+		\$0.50	1 DEPT01		\$30.00	1 DEPT02		\$10.00	+		\$0.50	SRVC TL		\$131.00
TABLE No. 000033	CT	1																																			
CHECK No. 1234																																					
1 DEPT01		\$10.00																																			
1 DEPT01		\$10.00																																			
1 DEPT02		\$20.00																																			
1 DEPT02		\$20.00																																			
1 DEPT03		\$30.00																																			
+		\$0.50																																			
1 DEPT01		\$30.00																																			
1 DEPT02		\$10.00																																			
+		\$0.50																																			
SRVC TL		\$131.00																																			

Closing a check memory

Example

OPERATION	RECEIPT																		
<p> <input type="button" value="1"/> <input type="button" value="2"/> <input type="button" value="3"/> <input type="button" value="4"/> <input type="button" value="OLD CHECK"/> </p> <p> <input type="button" value="1"/> <input type="button" value="5"/> <input type="button" value="0"/> <input type="button" value="00"/> <input type="button" value="CA / AMT TEND"/> </p>	<table border="1"> <tr> <td>TABLE No. 000033</td> <td>CT</td> <td>1</td> </tr> <tr> <td>CHECK No. 1234</td> <td></td> <td></td> </tr> <tr> <td>ST</td> <td></td> <td>\$131.00</td> </tr> <tr> <td>TL</td> <td></td> <td>\$131.00</td> </tr> <tr> <td>CASH</td> <td></td> <td>\$150.00</td> </tr> <tr> <td>CG</td> <td></td> <td>\$19.00</td> </tr> </table>	TABLE No. 000033	CT	1	CHECK No. 1234			ST		\$131.00	TL		\$131.00	CASH		\$150.00	CG		\$19.00
TABLE No. 000033	CT	1																	
CHECK No. 1234																			
ST		\$131.00																	
TL		\$131.00																	
CASH		\$150.00																	
CG		\$19.00																	

SLIP

REG	03-04-2006	17:05
CO1	MC#01	000150
TABLE No.	000033	CT 1
CHECK No.	1234	
1	DEPT01	\$10.00
1	DEPT01	\$10.00
1	DEPT02	\$20.00
1	DEPT02	\$20.00
1	DEPT03	\$30.00
	+	\$0.50
#12	SRVC TL	\$90.50
1	DEPT01	\$30.00
1	DEPT02	\$10.00
	+	\$0.50
#16	SRVC TL	\$131.00
	TL	\$131.00
	CASH	\$150.00
	CG	\$19.00

New/old check key operation

Example 1

When a check number is input and <NEW/OLD> is pressed, the key works as a new check key function if there is no matching check number in the check tracking memory.

OPERATION

RECEIPT

Input a check number and press
 <NEW/OLD>.

CHECK No. 3456	
1	DEPT01 \$10.00
1	DEPT02 \$20.00
	+ \$0.50
	SRVC TL \$30.50

Example 2

When a check number is input and <NEW/OLD> is pressed, the key works as an old check key if there is matching check number in the check tracking memory.

OPERATION

RECEIPT

CHECK No. 3456	
ST	\$30.50
TL	\$30.50
CASH	\$31.00
CG	\$0.50

Advanced Operations

Add check

This operation lets you combine the amounts of more than one check into a single check.

Example

Registration for check number 1234

Original check			OPERATION	RECEIPT
Check#	1234		<div style="display: flex; justify-content: space-around;"> 1234 </div> <div style="display: flex; justify-content: space-around;"> 33 </div> <div style="display: flex; justify-content: space-around;"> 1000 </div> <div style="display: flex; justify-content: space-around;"> 2000 </div>	CHECK No. 1234 TBL# 000033 1 DEPT01 \$10.00 1 DEPT02 \$20.00 + \$0.50 SRVC TL \$30.50
Item 1	Dept 1	\$10.00	<div style="display: flex; justify-content: space-around;"> NEW CHECK </div> <div style="display: flex; justify-content: space-around;"> TABLE # </div> <div style="display: flex; justify-content: space-around;"> 1 </div> <div style="display: flex; justify-content: space-around;"> NB </div>	
	Quantity	1		
Item 2	Dept 2	\$20.00		
	Quantity	1		

Registration for check number 3456

Added check			OPERATION	RECEIPT
Check#	3456		<div style="display: flex; justify-content: space-around;"> 3456 </div> <div style="display: flex; justify-content: space-around;"> 3000 </div>	CHECK No. 3456 1 DEPT01 \$30.00 + \$0.50 SRVC TL \$30.50
Item	Dept 1	\$30.00	<div style="display: flex; justify-content: space-around;"> NEW CHECK </div> <div style="display: flex; justify-content: space-around;"> 1 </div> <div style="display: flex; justify-content: space-around;"> NB </div>	
	Quantity	1		

Registration for check number 1234

Check No. : 1234		OPERATION	RECEIPT
	Check No. : 3456	<div style="display: flex; justify-content: space-around;"> 1234 </div> <div style="display: flex; justify-content: space-around;"> 3456 </div>	TABLE No. 000033 CT 1 CHECK No. 1234 ST \$30.50 ADD CHK 3456 ST \$30.50 + \$0.50 SRVC TL \$61.50
	<div style="display: flex; justify-content: space-between;"> ← </div>	<div style="display: flex; justify-content: space-around;"> OLD CHECK </div> <div style="display: flex; justify-content: space-around;"> ADD CHECK </div> <div style="display: flex; justify-content: space-around;"> NB </div>	

Separate check

This operation makes it possible to split a single check into separate checks.

Example

Check# 1234		
Item 1	Dept 1	\$10.00
	Quantity	1
Item 2	Dept 2	\$20.00
	Quantity	1
Item 3	Dept 3	\$30.00
	Quantity	1
Item 4	Dept 4	\$40.00
	Quantity	1

→

↗

Check# 3456		
Item 1	Dept 1	\$10.00
	Quantity	1
Item 2	Dept 3	\$30.00
	Quantity	1
Payment	Cash	\$40.00

OPERATION

RECEIPT

3 4 5 6 NEW CHECK

This input of a temporary check number can be skipped.

1 2 3 4 SEPARATE CHECK

Input the original check number by <SEP CHK>.

Display shows the 1st item which will be separated.

SEPARATE CHECK

After <SEP CHK>, this item is separated.

REVIEW

Display shows the 3rd item which will be separated.

SEPARATE CHECK

NB

4 0 00 CA / AMT / TEND

CHECK No. 3456		
SEP CHK		1234
1 DEPT01		\$10.00
1 DEPT03		\$30.00
TL	\$40.00	
CASH		\$40.00
CG		\$0.00

Price reductions (red price)

You can use the reduced price function to change a price; generally to an amount that is less than the normal price. You can program the register so that it prints the normal price, and the difference between the two prices on the receipt, while on journal, these items are always printed.

The following functions are able to work with red price.

- Department and PLU
- Quantity extension (Preset price is required for both department and PLU.)
- Amount limitation of item program (It effects to new price.)

Note that you cannot use red price with the following types of item.

- Department and PLUs programmed with negative unit prices
- Set menus and link PLUs
- Multiplication operations that use the format: Amount × Quantity

Example 1

OPERATION			RECEIPT			
Item	Dept 1	\$6.00	4 00 RED PRICE	RED	\$6.00	Old price Reduced price New price (Difference between two prices)
	Red price	\$4.00	Input a reduced price.	RED PRC	-2.00	
Payment	Cash	\$4.00	6 00 1	1 DEPT01	*4.00	
			CA/AMT /TEND	TL	\$4.00	
				CASH	\$4.00	

Example 2

OPERATION			RECEIPT			
Item	PLU 1	\$4.00	3 X / FOR DATE TIME	RED	\$12.00	Old price Reduced price New price (Difference between two prices)
	Red price	\$2.00	2 00 RED PRICE	RED PRC	-6.00	
Payment	Cash	\$6.00	Input a reduced price.	3 PLU0001	*6.00	
			1 PLU	TL	\$6.00	
			CA/AMT /TEND	CASH	\$6.00	

Condiment/preparation PLUs

You can force entering condiment or preparation PLU after the main PLU registration by programming.

Example (condiment PLU)

OPERATION			RECEIPT																		
Main item	PLU 1	\$10.00	<table style="width: 100%; border-collapse: collapse;"> <tr> <td style="width: 10%;">1</td> <td style="width: 60%;">PLU0001</td> <td style="width: 30%; text-align: right;">\$10.00</td> </tr> <tr> <td></td> <td>PLU0011</td> <td style="text-align: right;">\$0.10</td> </tr> <tr> <td></td> <td>PLU0012</td> <td style="text-align: right;">\$0.20</td> </tr> <tr> <td></td> <td>PLU0013</td> <td style="text-align: right;">\$0.30</td> </tr> <tr> <td></td> <td>TL</td> <td style="text-align: right;">\$ 10.60</td> </tr> <tr> <td></td> <td>CASH</td> <td style="text-align: right;">\$10.60</td> </tr> </table>	1	PLU0001	\$10.00		PLU0011	\$0.10		PLU0012	\$0.20		PLU0013	\$0.30		TL	\$ 10.60		CASH	\$10.60
1	PLU0001	\$10.00																			
	PLU0011	\$0.10																			
	PLU0012	\$0.20																			
	PLU0013	\$0.30																			
	TL	\$ 10.60																			
	CASH	\$10.60																			
	PLU 11	\$0.10																			
Condiment	PLU 12	\$0.20																			
	PLU 13	\$0.30																			
Payment	Cash	\$10.60																			

1
PLU

Registering main PLU.
No condiment registration occurs an error condition.

1
1
PLU

1
2
PLU

1
3
PLU

CA/AMT
/TEND

Example (preparation PLU)

OPERATION			RECEIPT																		
Main item	PLU 20	\$20.00	<table style="width: 100%; border-collapse: collapse;"> <tr> <td style="width: 10%;">1</td> <td style="width: 60%;">PLU0020</td> <td style="width: 30%; text-align: right;">\$20.00</td> </tr> <tr> <td></td> <td>PLU0021</td> <td></td> </tr> <tr> <td></td> <td>PLU0022</td> <td></td> </tr> <tr> <td></td> <td>PLU0023</td> <td></td> </tr> <tr> <td></td> <td>TL</td> <td style="text-align: right;">\$ 20.00</td> </tr> <tr> <td></td> <td>CASH</td> <td style="text-align: right;">\$20.00</td> </tr> </table>	1	PLU0020	\$20.00		PLU0021			PLU0022			PLU0023			TL	\$ 20.00		CASH	\$20.00
1	PLU0020	\$20.00																			
	PLU0021																				
	PLU0022																				
	PLU0023																				
	TL	\$ 20.00																			
	CASH	\$20.00																			
	PLU 21	\$0.00																			
Preparation	PLU 22	\$0.00																			
	PLU 23	\$0.00																			
Payment	Cash	\$20.00																			

2
0
PLU

Registering main PLU.

2
1
PLU

2
2
PLU

2
3
PLU

CA/AMT
/TEND

VAT breakdown printing

You can force printing of the VAT breakdown at the finalize stage, regardless of whether the cash register is programmed to print or skip printing of the VAT breakdown. Every time you want to have VAT breakdown, press <VAT>.

Example

OPERATION			RECEIPT		
Item 1	Dept 1	\$1.00	1 00 1	1 DEPT01 T1 \$1.00	1 PLU0001 T2 \$2.00
	Taxable	1			
Item 2	PLU 1	(\$2.00)	1 PLU	TA1 \$0.90	TX1 \$0.10
	Taxable	2		TA2 \$1.90	TX2 \$0.10
Payment	Cash	\$3.00	VAT	TL \$3.00	CASH \$3.00
			CA/AMT/TEND		

Actual stock quantity inquiry

With this operation, you can recall the actual stock quantity for PLUs and show it on the display of the cash register.

Example

To check the actual stock quantity of PLU 32 and flat-PLU 001.

OPERATION	DISPLAY (7segment)
3 2 PLU	12345
STOCK INQ	
STOCK INQ	1
001	

Actual stock quantity are appeared.

Unit price inquiry

Use this operation to recall the unit prices of departments, PLUs, or scanning PLUs. The unit prices appear on the display of the cash register when recalled.

Example

To check the unit price of PLU 32, flat-PLU 001, department 1.

OPERATION	DISPLAY (7 segment)
3 2 PLU	145
PRICE INQ	
PRICE INQ	3.00
001	
PRICE INQ	
1	14.00

Bill copy

To issue a copy of a bill dated February 1, 2006 in the amount of \$35.00 cash.

OPERATION	RECEIPT
<div style="display: flex; justify-content: space-around; align-items: center;"> <div style="display: flex; gap: 5px;"> <div style="border: 1px solid black; padding: 2px 5px;">0</div> <div style="border: 1px solid black; padding: 2px 5px;">2</div> <div style="border: 1px solid black; padding: 2px 5px;">0</div> <div style="border: 1px solid black; padding: 2px 5px;">1</div> <div style="border: 1px solid black; padding: 2px 5px;">2</div> <div style="border: 1px solid black; padding: 2px 5px;">0</div> <div style="border: 1px solid black; padding: 2px 5px;">0</div> <div style="border: 1px solid black; padding: 2px 5px;">6</div> </div> <div style="border: 1px solid black; padding: 2px 5px; font-size: 8px;">BILL COPY</div> </div> <p style="text-align: center; margin-top: 5px;">Enter date by date order.</p> <div style="display: flex; justify-content: space-around; align-items: center; margin-top: 10px;"> <div style="display: flex; gap: 5px;"> <div style="border: 1px solid black; padding: 2px 5px;">3</div> <div style="border: 1px solid black; padding: 2px 5px;">5</div> <div style="border: 1px solid black; padding: 2px 5px;">00</div> </div> <div style="border: 1px solid black; padding: 2px 5px; font-size: 8px;">CA/AMT TEND</div> </div>	<div style="border: 1px solid black; padding: 5px; font-family: monospace; font-size: 10px;"> <pre> ** BILL TOP MESSAGE 1 ** ** BILL TOP MESSAGE 2 ** ** BILL TOP MESSAGE 3 ** ** BILL TOP MESSAGE 4 ** REG 02-01-2006 CO1 MC#01 * BILL COPY MESSAGE 1 ** * BILL COPY MESSAGE 2 ** * BILL COPY MESSAGE 3 ** * BILL COPY MESSAGE 4 ** TA1 \$35.00 TX1 \$3.50 TL \$38.50 CASH \$38.50 ** BILL BTM MESSAGE 1 ** ** BILL BTM MESSAGE 2 ** ** BILL BTM MESSAGE 3 ** ** BILL BTM MESSAGE 4 ** </pre> </div> <div style="margin-top: 5px;"> <p>Bill top message *1</p> <p>Bill copy message *1</p> <p>Add-on tax amount</p> <p>Bill bottom message *1</p> <p>*1 Programmable option</p> </div>

Note that you can finalize this operation using the cash amount tendered key.

Deposit registrations

Use the following procedures to register deposits.

Deposit from customer

OPERATION	RECEIPT			
<table border="1" style="width: 100%; border-collapse: collapse; text-align: center;"> <tr> <td style="width: 20%;">Deposit</td> <td style="width: 20%;">Cash</td> <td style="width: 60%;">\$50.00</td> </tr> </table> <div style="display: flex; justify-content: space-around; align-items: center; margin-top: 10px;"> <div style="display: flex; gap: 5px;"> <div style="border: 1px solid black; padding: 2px 5px;">5</div> <div style="border: 1px solid black; padding: 2px 5px;">0</div> <div style="border: 1px solid black; padding: 2px 5px;">00</div> </div> <div style="border: 1px solid black; padding: 2px 5px; font-size: 8px;">DEPOSIT -</div> </div> <div style="display: flex; justify-content: space-around; align-items: center; margin-top: 5px;"> <div style="border: 1px solid black; padding: 2px 5px; font-size: 8px;">CA/AMT TEND</div> </div>	Deposit	Cash	\$50.00	<div style="border: 1px solid black; padding: 5px; font-family: monospace; font-size: 10px;"> <pre> DEPO- \$50.00 TL \$50.00 CASH \$50.00 </pre> </div>
Deposit	Cash	\$50.00		

Deposit from customer during sales transaction

OPERATION	RECEIPT											
<table border="1" style="width: 100%; border-collapse: collapse; text-align: center;"> <tr> <td rowspan="2" style="width: 15%;">Items</td> <td style="width: 15%;">Dept 1</td> <td style="width: 70%;">\$10.00</td> </tr> <tr> <td>Dept 2</td> <td>\$20.00</td> </tr> <tr> <td>Deposit</td> <td></td> <td>\$20.00</td> </tr> <tr> <td>Payment</td> <td>Cash</td> <td>\$10.00</td> </tr> </table> <div style="display: flex; justify-content: space-around; align-items: center; margin-top: 10px;"> <div style="display: flex; gap: 5px;"> <div style="border: 1px solid black; padding: 2px 5px;">1</div> <div style="border: 1px solid black; padding: 2px 5px;">0</div> <div style="border: 1px solid black; padding: 2px 5px;">00</div> <div style="border: 1px solid black; padding: 2px 5px; font-size: 8px;">1</div> </div> <div style="display: flex; gap: 5px;"> <div style="border: 1px solid black; padding: 2px 5px;">2</div> <div style="border: 1px solid black; padding: 2px 5px;">0</div> <div style="border: 1px solid black; padding: 2px 5px;">00</div> <div style="border: 1px solid black; padding: 2px 5px; font-size: 8px;">2</div> </div> <div style="display: flex; gap: 5px;"> <div style="border: 1px solid black; padding: 2px 5px;">2</div> <div style="border: 1px solid black; padding: 2px 5px;">0</div> <div style="border: 1px solid black; padding: 2px 5px;">00</div> <div style="border: 1px solid black; padding: 2px 5px; font-size: 8px;">DEPOSIT +</div> </div> </div> <div style="display: flex; justify-content: space-around; align-items: center; margin-top: 5px;"> <div style="border: 1px solid black; padding: 2px 5px; font-size: 8px;">CA/AMT TEND</div> </div>	Items	Dept 1	\$10.00	Dept 2	\$20.00	Deposit		\$20.00	Payment	Cash	\$10.00	<div style="border: 1px solid black; padding: 5px; font-family: monospace; font-size: 10px;"> <pre> 1 DEPT01 \$10.00 1 DEPT02 \$20.00 DEPO+ -20.00 TL \$10.00 CASH \$10.00 </pre> </div>
Items		Dept 1	\$10.00									
	Dept 2	\$20.00										
Deposit		\$20.00										
Payment	Cash	\$10.00										

Previous item void using <REVIEW>

You can correct the previously registered item(s) in the same transaction by using <REVIEW> (review key).

Example

			OPERATION	DISPLAY
Item 1	Dept. 1	\$2.35	<div style="display: flex; justify-content: space-around;"> 2 3 5 1 </div>	DEPT01 2.35
	Quantity	1		
Item 2	Dept. 2	\$2.00	<div style="display: flex; justify-content: space-around;"> 2 00 2 </div>	DEPT02 2.00
	Quantity	1		
Item 3	PLU 1	(\$1.20) _{preset}	<div style="display: flex; justify-content: space-around;"> 1 PLU </div>	PLU001 1.20
	Quantity	1		
Corrected Item 1	Dept. 1	\$2.35	<div style="display: flex; justify-content: space-around;"> REVIEW </div>	DEPT01 2.35
	Quantity	1		
Payment	Cash	\$3.20	<div style="display: flex; justify-content: space-around;"> VOID </div> <p style="font-size: small;">Press <VOID> to correct.</p> <div style="display: flex; justify-content: space-around; margin-top: 10px;"> CA/AMT TEND </div>	DEPT02 2.00
				CASH 3.20

RECEIPT

1	DEPT01	\$2.35	*1
1	DEPT02	\$2.00	
1	PLU0001	\$1.20	
	VOID	*1
1	DEPT01	-2.35	*1
	TL	\$3.20	
	CASH	\$3.20	

*1 These items can be skipped by program.

Scanning PLU

Product barcodes are read by scanning with hand-held scanner, and are filed in the scanning PLU file together with the unit price, item descriptor, programming status, link department, totalizer and counter.

When a barcode is entered by scanning, or from the keyboard by using <OBR> (OBR key) or <One touch NLU> (One touch NLU key) and it has been filed in the scanning PLU file, the preset unit price is accumulated to its own totalizer and other appropriate totalizers.

Scanning PLUs include UPC-A/UPC-E/EAN-13/EAN-8, source marking, in-store marking code.

Item registration

By scanner/code input/one touch NLU key

	OPERATION	RECEIPT																																									
<table border="1" style="width: 100%; border-collapse: collapse;"> <tr> <td rowspan="2">Item 1 (scan)</td> <td>Scan-PLU</td> <td>(\$2.35)</td> </tr> <tr> <td>PLU code</td> <td>49012347</td> </tr> <tr> <td rowspan="2">Item 2 (code)</td> <td>Scan-PLU</td> <td>(\$2.00)</td> </tr> <tr> <td>PLU code</td> <td>123456</td> </tr> <tr> <td rowspan="2">Item 3 (OTN)</td> <td>Scan-PLU</td> <td>(\$1.23)</td> </tr> <tr> <td>PLU code</td> <td>49012354</td> </tr> <tr> <td>Payment</td> <td>Cash</td> <td>\$5.58</td> </tr> </table>	Item 1 (scan)	Scan-PLU	(\$2.35)	PLU code	49012347	Item 2 (code)	Scan-PLU	(\$2.00)	PLU code	123456	Item 3 (OTN)	Scan-PLU	(\$1.23)	PLU code	49012354	Payment	Cash	\$5.58	<p>“Scanning”</p> <div style="display: flex; justify-content: center; gap: 10px;"> <div style="border: 1px solid black; padding: 2px 5px;">1</div> <div style="border: 1px solid black; padding: 2px 5px;">2</div> <div style="border: 1px solid black; padding: 2px 5px;">3</div> </div> <div style="display: flex; justify-content: center; gap: 10px; margin-top: 5px;"> <div style="border: 1px solid black; padding: 2px 5px;">4</div> <div style="border: 1px solid black; padding: 2px 5px;">5</div> <div style="border: 1px solid black; padding: 2px 5px;">6</div> <div style="border: 1px solid black; padding: 2px 5px;">OBR</div> </div> <p>Scanning-PLU code and OBR key</p> <div style="display: flex; justify-content: center; margin-top: 10px;"> <div style="border: 1px solid black; padding: 2px 5px;">NLU</div> </div> <p>One touch NLU</p> <div style="display: flex; justify-content: center; margin-top: 10px;"> <div style="border: 1px solid black; padding: 2px 5px;">CA/AMT TEND</div> </div>	<table border="1" style="width: 100%; border-collapse: collapse;"> <tr> <td>1 Scan-PLU01</td> <td style="text-align: right;">\$2.35</td> <td rowspan="2">Scanning PLU code *1</td> </tr> <tr> <td>#49012347</td> <td></td> </tr> <tr> <td>1 Scan-PLU02</td> <td style="text-align: right;">\$2.00</td> <td></td> </tr> <tr> <td>#123456</td> <td></td> <td></td> </tr> <tr> <td>1 Scan-PLU03</td> <td style="text-align: right;">\$1.23</td> <td></td> </tr> <tr> <td>#49012354</td> <td></td> <td></td> </tr> <tr> <td>TL</td> <td style="text-align: right;">\$5.58</td> <td></td> </tr> <tr> <td>CASH</td> <td style="text-align: right;">\$5.58</td> <td>*1 Programmable option</td> </tr> </table>	1 Scan-PLU01	\$2.35	Scanning PLU code *1	#49012347		1 Scan-PLU02	\$2.00		#123456			1 Scan-PLU03	\$1.23		#49012354			TL	\$5.58		CASH	\$5.58	*1 Programmable option
Item 1 (scan)		Scan-PLU	(\$2.35)																																								
	PLU code	49012347																																									
Item 2 (code)	Scan-PLU	(\$2.00)																																									
	PLU code	123456																																									
Item 3 (OTN)	Scan-PLU	(\$1.23)																																									
	PLU code	49012354																																									
Payment	Cash	\$5.58																																									
1 Scan-PLU01	\$2.35	Scanning PLU code *1																																									
#49012347																																											
1 Scan-PLU02	\$2.00																																										
#123456																																											
1 Scan-PLU03	\$1.23																																										
#49012354																																											
TL	\$5.58																																										
CASH	\$5.58	*1 Programmable option																																									

Not found PLU

When a scanning PLU item which does not exist in the scanning PLU file is registered, an error occurs (Item not found error). In this case, you can input this item to the ECR and register it at the same time. After this operation, “Item not found error” does not occur during the next registration.

	OPERATION	RECEIPT																																
<table border="1" style="width: 100%; border-collapse: collapse;"> <tr> <td rowspan="3">Item 1 (scan)</td> <td>Scan-PLU</td> <td>(\$1.00)</td> </tr> <tr> <td>PLU code</td> <td>49012361</td> </tr> <tr> <td>Dept.</td> <td>1</td> </tr> <tr> <td rowspan="2">Item 2 (scan)</td> <td>Scan-PLU</td> <td>(\$1.00)</td> </tr> <tr> <td>PLU code</td> <td>49012361</td> </tr> <tr> <td>Payment</td> <td>Cash</td> <td>\$2.00</td> </tr> </table>	Item 1 (scan)	Scan-PLU	(\$1.00)	PLU code	49012361	Dept.	1	Item 2 (scan)	Scan-PLU	(\$1.00)	PLU code	49012361	Payment	Cash	\$2.00	<p>“Scanning”</p> <p>Does not exist in the scanning PLU file</p> <p>“Not Found Error”</p> <p>The display shows; “[NOT FOUND ERROR] INPUT UNIT PRICE, AND PRESS DEPT KEY”</p> <div style="display: flex; justify-content: center; gap: 10px; margin-top: 5px;"> <div style="border: 1px solid black; padding: 2px 5px;">1</div> <div style="border: 1px solid black; padding: 2px 5px;">0</div> <div style="border: 1px solid black; padding: 2px 5px;">0</div> <div style="border: 1px solid black; padding: 2px 5px;">1</div> </div> <p>Input price and press the linked department key.</p> <p>“Scanning”</p> <p>Register normally.</p> <div style="display: flex; justify-content: center; margin-top: 10px;"> <div style="border: 1px solid black; padding: 2px 5px;">CA/AMT TEND</div> </div>	<table border="1" style="width: 100%; border-collapse: collapse;"> <tr> <td>1 DEPT01</td> <td style="text-align: right;">\$1.00</td> <td rowspan="2">Link department descriptor/amount</td> </tr> <tr> <td>#49012361</td> <td></td> </tr> <tr> <td>1 DEPT01</td> <td style="text-align: right;">\$1.00</td> <td></td> </tr> <tr> <td>#49012361</td> <td></td> <td></td> </tr> <tr> <td>TL</td> <td style="text-align: right;">\$2.00</td> <td></td> </tr> <tr> <td>CASH</td> <td style="text-align: right;">\$2.00</td> <td></td> </tr> </table>	1 DEPT01	\$1.00	Link department descriptor/amount	#49012361		1 DEPT01	\$1.00		#49012361			TL	\$2.00		CASH	\$2.00	
Item 1 (scan)		Scan-PLU	(\$1.00)																															
		PLU code	49012361																															
	Dept.	1																																
Item 2 (scan)	Scan-PLU	(\$1.00)																																
	PLU code	49012361																																
Payment	Cash	\$2.00																																
1 DEPT01	\$1.00	Link department descriptor/amount																																
#49012361																																		
1 DEPT01	\$1.00																																	
#49012361																																		
TL	\$2.00																																	
CASH	\$2.00																																	

Programming to clerk

You can program up to 4-digit assigning number (clerk number), trainee status of clerk (i.e. training cashier) and commission rate for each clerk.

Programming clerk number

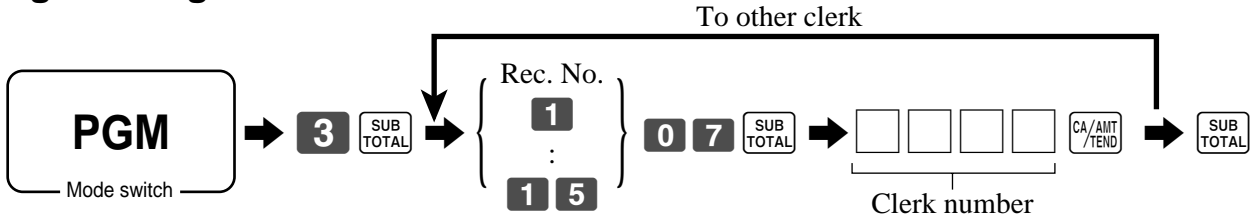

Programming trainee status

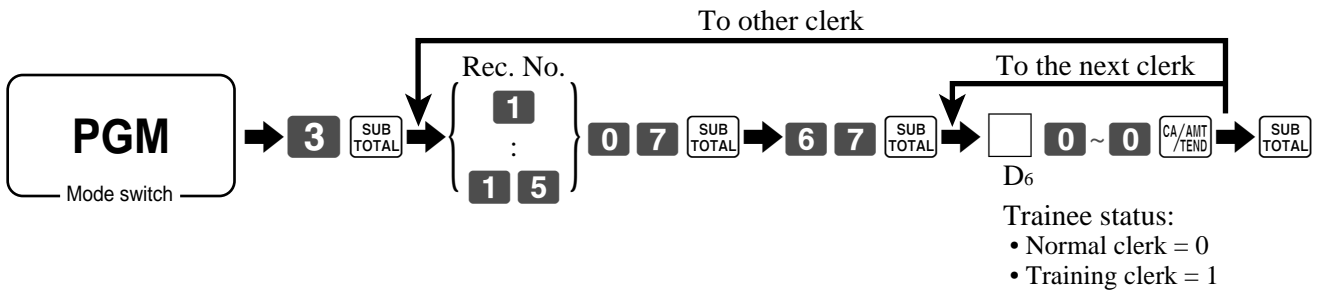

Programming commission rate

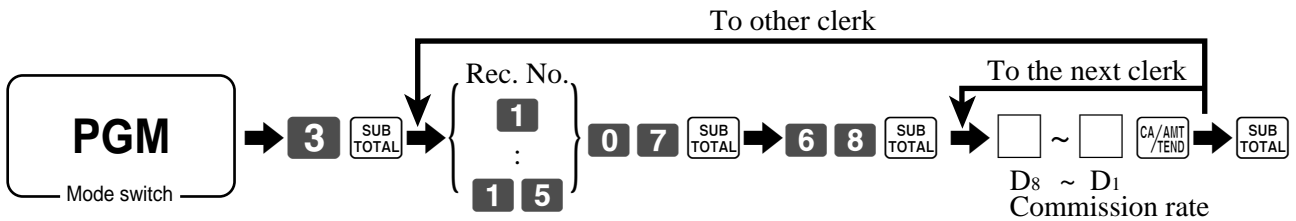

Record No.	Clerk number				Trainee status	Commission rate								
						Commission rate 1				Commission rate 2				
	D ₄	D ₃	D ₂	D ₁		D ₆	00000	Integer		Decimal		Integer		Decimal
						D ₈	D ₇	D ₆	D ₅	D ₄	D ₃	D ₂	D ₁	
1						00000								
2						00000								
3						00000								
4						00000								
5						00000								
6						00000								
7						00000								
8						00000								
9						00000								
10						00000								
11						00000								
12						00000								
13						00000								
14						00000								
15						00000								

Character programming can be performed in two ways:

- Character keyboard programming (see page 91),
or
- Entering characters by code (see page 92).

Programming descriptors and messages

The following descriptors and messages can be programmed;

- Messages (Logo, commercial and bottom message)
- Clerk name
- PLU item descriptor
- Department key descriptor
- Machine number

Programming receipt message, machine No. and clerk name

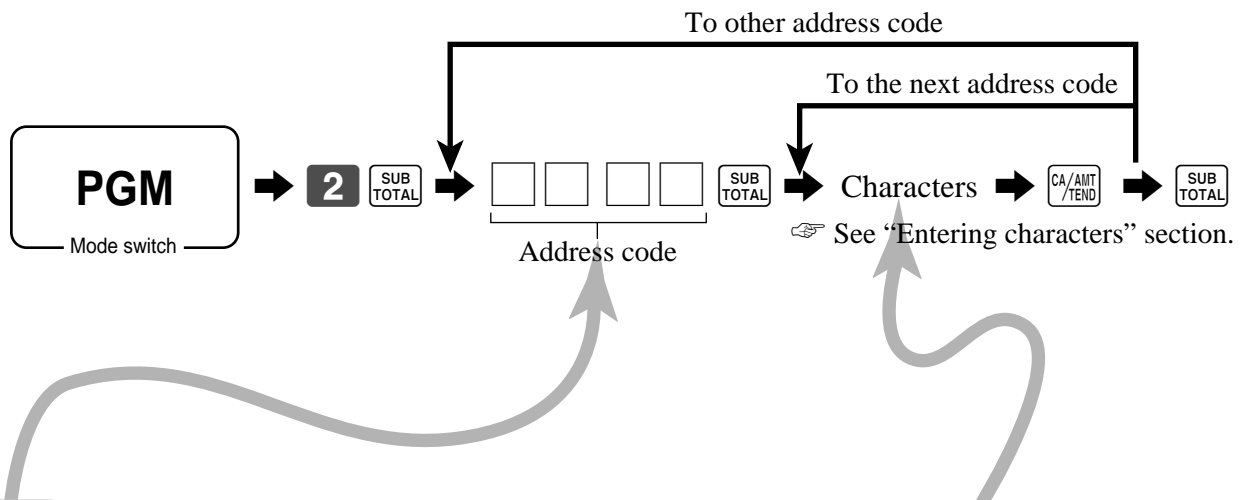

Address code	Contents	Initial character	Yours																				
0107	Clerk 01	C01																					
0207	Clerk 02	C02																					
0307	Clerk 03	C03																					
0407	Clerk 04	C04																					
0507	Clerk 05	C05																					
0607	Clerk 06	C06																					
0707	Clerk 07	C07																					
0807	Clerk 08	C08																					
0907	Clerk 09	C09																					
1007	Clerk 10	C10																					
1107	Clerk 11	C11																					
1207	Clerk 12	C12																					
1307	Clerk 13	C13																					
1407	Clerk 14	C14																					
1507	Clerk 15	C15																					
0191	Machine number	MC#01																					

Advanced Operations

Address code	Contents	Initial character	Yours
0132	1st line of logo message	YOUR RECEIPT THANK YOU CALL AGAIN	
0232	2nd line of logo message		
0332	3rd line of logo message		
0432	4th line of logo message		
0532	1st line of commercial message		
0632	2nd line of commercial message		
0732	3rd line of commercial message		
0832	4th line of commercial message		
0932	1st line of bottom message		
1032	2nd line of bottom message		
1132	3rd line of bottom message		
1232	4th line of bottom message		
1332	1st line of bill top message		
1432	2nd line of bill top message		
1532	3rd line of bill top message		
1632	4th line of bill top message		
1732	1st line of bill copy message		
1832	2nd line of bill copy message		
1932	3rd line of bill copy message		
2032	4th line of bill copy message		
2132	1st line of bill bottom message		
2232	2nd line of bill bottom message		
2332	3rd line of bill bottom message		
2432	4th line of bill bottom message		
2532	Post receipt message	DUPLICATE RECEIPT	
2632	1st line of guest intermediate msg.		
2732	2nd line of guest intermediate msg.		
2832	3rd line of guest intermediate msg.		
2932	4th line of guest intermediate msg.		
3032	1st line of guest bottom msg.		
3132	2nd line of guest bottom msg.		
3232	3rd line of guest bottom msg.		
3332	4th line of guest bottom msg.		
3432	5th line of guest bottom msg.		
3532	6th line of guest bottom msg.		
3632	7th line of guest bottom msg.		
3732	8th line of guest bottom msg.		
3832	9th line of guest bottom msg.		
3932	10th line of guest bottom msg.		
4032	1st line of Australian GST MOF msg.	TAX INVOICE	
4132	2nd line of Australian GST MOF msg.	* INDICATES	
4232	3rd line of Australian GST MOF msg.	TAXABLE SUPPLY	

Programming department/transaction key descriptor

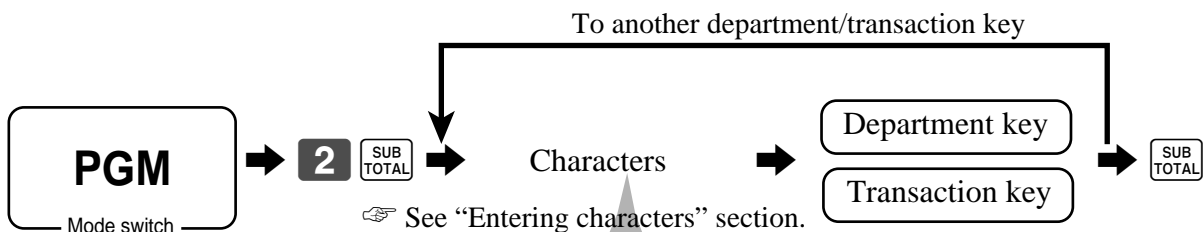

Contents	Initial character	Yours											
Department 01	DEPT01												
Department 02	DEPT02												
Department 03	DEPT03												
Department 04	DEPT04												
Department 05	DEPT05												
Department 06	DEPT06												
Department 07	DEPT07												
:	:												

Contents	Initial character	Yours											
Cash / Amount tendered	CASH												
Charge	CHARGE												
Check	CHECK												
Credit 1	CREDIT1												
Credit 2	CREDIT2												
Received on account	RC												
Paid out	PD												
Minus	-												
Discount	%-												
Refund	RF												
Correction	CORR												
Receipt	RCT												
Non add / No sale	#/NS												
Menu shift	MENU												
Tax shift 1	T/S1												
Tax shift 2	T/S2												
Clerk number	CLK#												
Subtotal	SUBTOTAL												
Receipt on / off	RCT ON/OFF												
Multiplication / for / Date time	QT												
Two zero	00												
Decimal point	.												
Help	HELP												

Programming flat-PLU descriptor

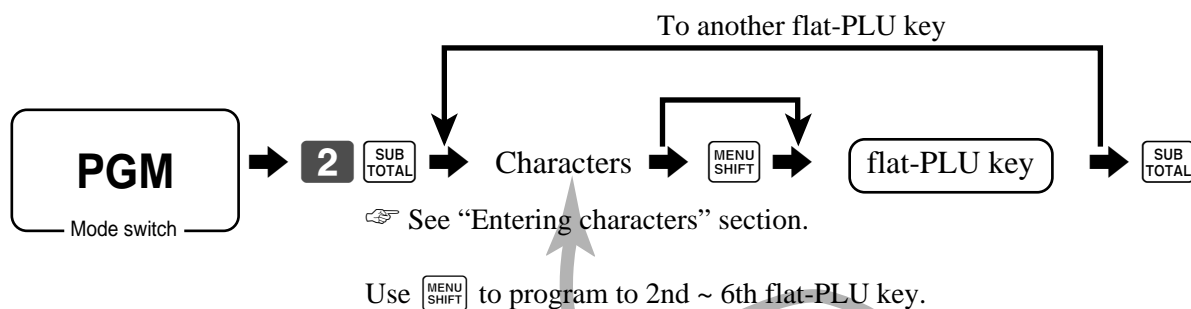

PLU No.	Contents	Initial character	Yours											
001	PLU 001	PLU0001												
002	PLU 002	PLU0002												
003	PLU 003	PLU0003												
004	PLU 004	PLU0004												
005	PLU 005	PLU0005												
006	PLU 006	PLU0006												
007	PLU 007	PLU0007												
008	PLU 008	PLU0008												
009	PLU 009	PLU0009												
010	PLU 010	PLU0010												
011	PLU 011	PLU0011												
012	PLU 012	PLU0012												
013	PLU 013	PLU0013												
014	PLU 014	PLU0014												
015	PLU 015	PLU0015												
016	PLU 016	PLU0016												
017	PLU 017	PLU0017												
018	PLU 018	PLU0018												
019	PLU 019	PLU0019												
020	PLU 020	PLU0020												
021	PLU 021	PLU0021												
022	PLU 022	PLU0022												
023	PLU 023	PLU0023												
024	PLU 024	PLU0024												
025	PLU 025	PLU0025												
026	PLU 026	PLU0026												
027	PLU 027	PLU0027												
028	PLU 028	PLU0028												
029	PLU 029	PLU0029												
030	PLU 030	PLU0030												
031	PLU 031	PLU0031												
032	PLU 032	PLU0032												
033	PLU 033	PLU0033												
034	PLU 034	PLU0034												
035	PLU 035	PLU0035												

Entering characters

In this section, the method to enter descriptors or messages (characters) to the cash register during programming is described.

Characters are specified by character keyboard or by codes. In the first half of this section, the usage of character keyboard is described. In the latter half, inputting method by character code is described.

Using character keyboard

Example:

Input “ **A** p p l e J u i c e ”,
 enter “DBL”“A” “SHIFT”“p” “p” “l” “e” “SPACE” “CAP”“J” “SHIFT”“u” “i” “c” “e” **00** .

													MENU			RECEIPT FEED	JOURNAL FEED		
7	007	014	021	028	035	042	049	056	063	070			2	3					
	:	-	+	/	?	*	.	'	^	~			←	→					
	1	2	3	4	5	6	7	8	9	0			C						
	Q	W	E	R	T	Y	U	I	O	P			7	8	9				
	A	S	D	F	G	H	J	K	L				4	5	6				
	Z	X	C	V	B	N	M						1	2	3			#-2	
6	CAP	1	5					13	4	OVR /INS	DBL			9	10			12	#-1
	001	008	015	022	029	036	043	050	057	064			0	00	.				

- ① **Shift key**
Press this key to shift the following characters from the uppercase letter to lowercase letter and returns to the uppercase letter in sequence.
- ② **Left cursor key**
Press this key to shift the character setting position to the left one by one. This key is used to correct already entered characters.
- ③ **Right cursor key**
Press this key to shift the character setting position to the right one by one. This key is used to correct already entered characters.
- ④ **Double size letter key**
Press this key to specify that the next character you input to a double size character.
- ⑤ **Space key**
Press this key to set a space.
- ⑥ **CAP key**
Press this key to shift the character to the uppercase letter.
- ⑦ **Alphabet keys**
Press these keys to input characters.
- ⑧ **Numeric keys**
Press these keys to enter program codes, memory number and character codes.
- ⑨ **Character fixed key**
Press this key to enter when the alphabetic entry for a descriptor, name or message has been completed.
- ⑩ **Backspace/Character code fixed key**
Press this key to register one character with code (2 or 3 digit). It clears the last input character, much like a back space key. (Does not clear the double size letter key entry.)
- ⑪ **Program end key**
Press this key to terminate the character programming.
- ⑫ **Character enter key**
Press this key to register the programmed characters.
- ⑬ **Insert/Override key**
Press this key to change the status “Insert” between the original characters or “Override” the original characters.

Advanced Operations

Entering characters by code

Every time you enter a character, choose character codes by the character code list (below) and press the  key to settle it. After you complete entering characters, press the **00** key to fix them.

Example:

Input “ **A** p p l e J u i c e ”,
 enter “ 255  65  112  112  108  101  32  74  117  105  99  101  **00** ”

Character code list

Chara	Code	Chara	Code	Chara	Code	Chara	Code	Chara	Code	Chara	Code	Chara	Code
Space	32	0	48	@	64	P	80	'	96	p	112	Ç	128
!	33	1	49	A	65	Q	81	a	97	q	113	ü	129
"	34	2	50	B	66	R	82	b	98	r	114	é	130
#	35	3	51	C	67	S	83	c	99	s	115	â	131
\$	36	4	52	D	68	T	84	d	100	t	116	ä	132
%	37	5	53	E	69	U	85	e	101	u	117	à	133
&	38	6	54	F	70	V	86	f	102	v	118	å	134
'	39	7	55	G	71	W	87	g	103	w	119	ç	135
(40	8	56	H	72	X	88	h	104	x	120	ê	136
)	41	9	57	I	73	Y	89	i	105	y	121	ë	137
*	42	:	58	J	74	Z	90	j	106	z	122	è	138
+	43	;	59	K	75	[91	k	107	{	123	ï	139
,	44	<	60	L	76	\	92	l	108		124	î	140
-	45	=	61	M	77]	93	m	109	}	125	ì	141
.	46	>	62	N	78	^	94	n	110	~	126	Ä	142
/	47	?	63	O	79	_	95	o	111		127	Å	143
É	144	á	160	■	176	ℓ	192	ø	208	Ó	224	-	240
æ	145	í	161	■	177	⊥	193	Ð	209	ß	225	±	241
Æ	146	ó	162	■	178	⊥	194	Ê	210	Ô	226	_	242
ô	147	ú	163		179	†	195	Ë	211	Ò	227	3/4	243
ö	148	ñ	164	†	180	—	196	È	212	õ	228	¶	244
ò	149	Ñ	165	Á	181	†	197	€	213	Õ	229	§	245
û	150	ª	166	Â	182	ã	198	í	214	μ	230	÷	246
ù	151	º	167	À	183	Ã	199	î	215	þ	231	¸	247
ÿ	152	¿	168	©	184	ℓ	200	ï	216	Þ	232	°	248
Ö	153	®	169	†	185	⌈	201	¸	217	Ú	233	ˆ	249
Ü	154	¬	170		186	⊥	202	⌈	218	Û	234	•	250
ø	155	1/2	171	⌈	187	⊥	203	■	219	Ù	235	¹	251
£	156	1/4	172	¸	188	†	204	■	220	ý	236	³	252
Ø	157	¡	173	¢	189	—	205		221	Ý	237	²	253
×	158	«	174	¥	190	†	206	ì	222	—	238	■	254
f	159	»	175	¡	191	¤	207	■	223	'	239	Double size	255

Editing characters

Correcting a character just entered

OPERATION		DISPLAY (14segment)
“L” “E” “N” “O” “N”	↵ Enter LENON, instead of LEMON.	
	↵ Press left arrow key three times.	
	↵ Override mode	
“M”	↵ Enter “M”.	

Blinking

Correcting and adding a PLU descriptor already set

OPERATION		DISPLAY (14segment)
	↵ Enter “00”.	
	↵ Enter PLU No.	
“S” “O” “D” “A” “ ”	↵ Enter “Soda” and “space”.	
	↵ Override mode	
“L”	↵ Enter “L”.	

Blinking

Correcting a key descriptor already set

OPERATION		DISPLAY (14segment)
	↵ Enter “00”.	
	↵ Designate an appropriate key.	
	↵ Press right arrow key two times.	
“M”	↵ Enter “M”.	
	↵ Delete “N”.	

Blinking

Correcting a message descriptor already set

OPERATION		DISPLAY (14segment)
	↵ Enter record and file number.	
	↵ Press right arrow key two times.	
“O”	↵ Enter “O”.	
	↵ Delete “A”.	

Blinking

Printing read/reset reports

• Daily sales read report (“X1” mode)

You can print read reports at any time during the business day without affecting the data stored in the cash register's memory.

• Daily sales reset report (“Z1” mode)

You should print reset reports at the end of the business day.

Important!

- The reset operation issues a report and also clears all sales data from the cash register's memory.
- Be sure to perform the reset operations at the end of each business day. Otherwise, you will not be able to distinguish between the sales data for different dates.

To print the individual department, PLU/flat-PLU read report

This report shows sales for specific departments or PLUs/flat-PLUs.

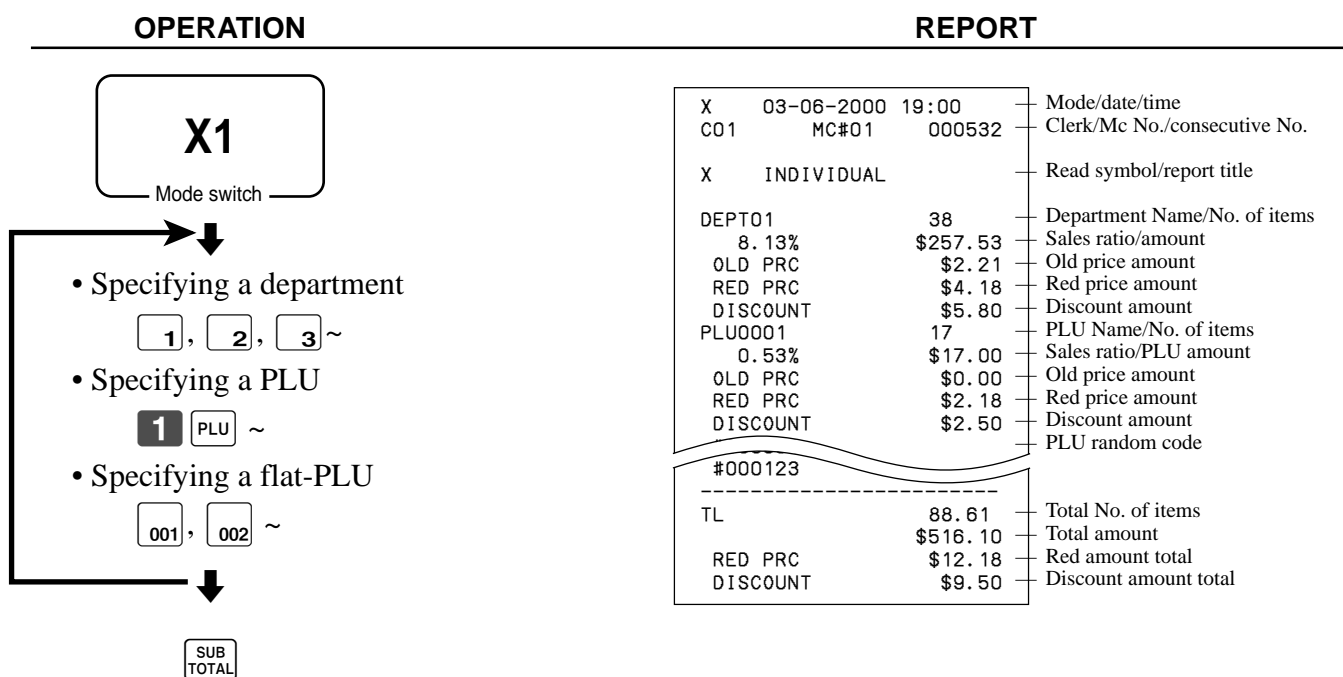

After you finish to select items, press SUB TOTAL to terminate.

To print the financial read report

This report shows gross sales, net sales, cash in drawer and check in drawer.

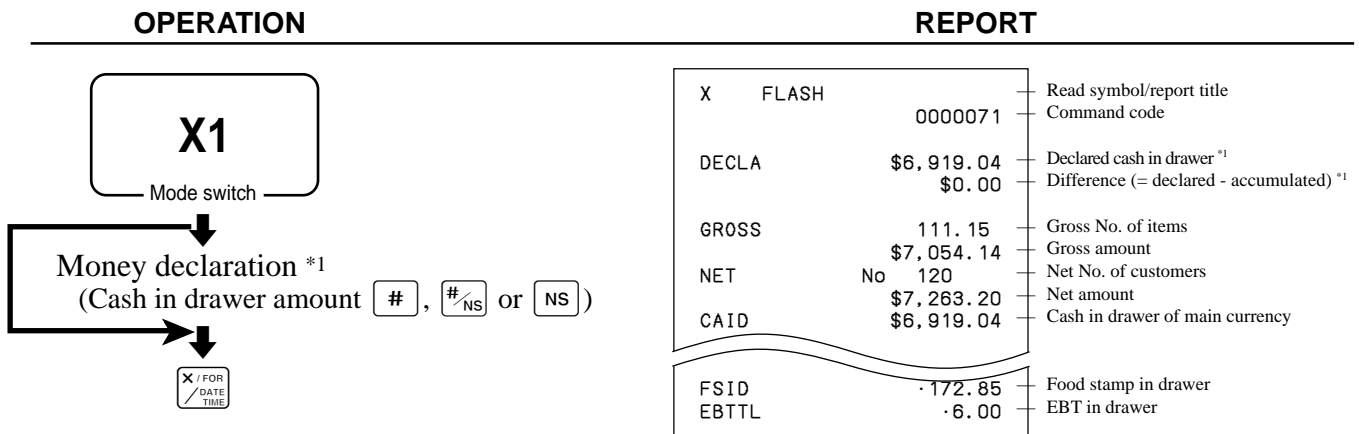

To print the individual clerk read/reset report

This report shows individual clerk totals.

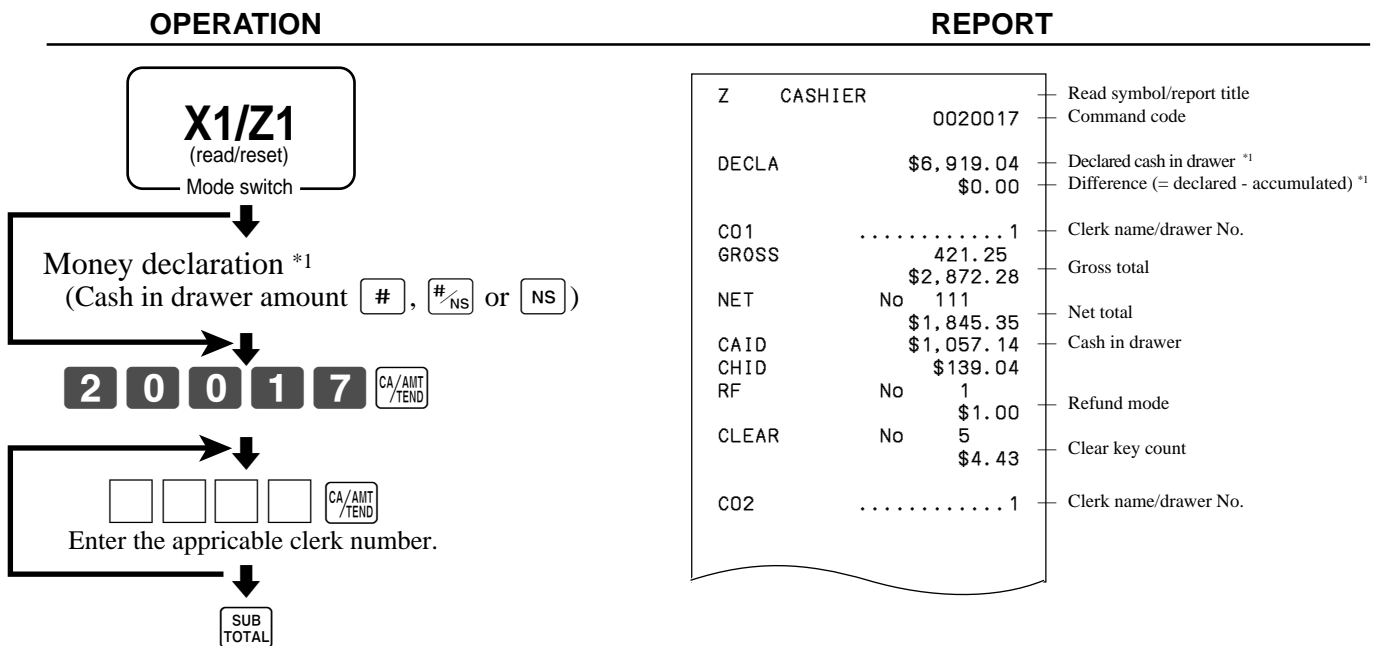

After you finish to select clerks, press **SUB TOTAL** to terminate.

*1 Money declaration:

Count how much cash is in the drawer and input this amount (up to 10 digits).

The cash register will automatically compare the input with the cash in drawer in the memory and print the difference between these two amounts.

Note that if money declaration is required by programming, you cannot skip this procedure.

Advanced Operations

To print the daily sales read/reset report

This report shows sales except for PLUs.

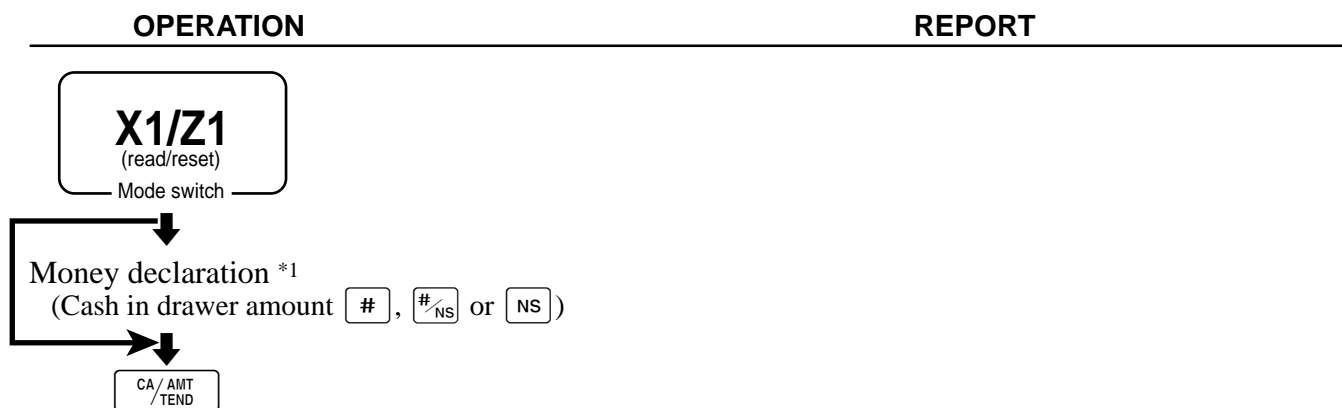

Z	BATCH 01		Report title
Z	FIX	0001	Fixed total report title/reset counter *4
		0001011	Report code
DECLA		\$6,919.04	Declared cash in drawer *1
		.00	Difference (= declared - accumulated) *1
GROSS		981.25	Gross total *3
		\$6,574.40	
NET	No	111	Net total *3
		\$7,057.14	
CAID		\$6,919.04	Cash in drawer *3
CHID		\$139.04	Charge in drawer *3
CKID		\$859.85	Check in drawer *3
CRID(1)		\$709.85	Credit in drawer *3
RF	No	3	Refund mode *3
		\$10.22	
CUST	CT	111	Customer number *3
AVRG		\$63.57	Average sales per customer *3
DC		\$1.22	Discount total *3
REF		\$2.42	Refund key *3
CLEAR	No	85	Clear key count *3
ROUND		\$0.00	Rounding total *3
CANCEL	No	2	Cancellation *3
		\$12.97	
TA1		\$2,369.69	Taxable 1 amount *3
TX1		\$128.86	Tax 1 amount *3
TA2		\$2,172.96	Taxable 2 amount *3
TX2		\$217.33	Tax 2 amount *3
GT1		\$00000000125478.96	Grand total 1 *3
GT2		\$00000000346284.23	Grand total 2 *3
GT3		\$00000000123212.75	Grand total 3 *3

Z	TRANS		0001	Function key report title/reset counter
			0001012	Report code
CASH	No	362		Function key count/amount *2
		\$1,638.04		
CHARGE	No	56		
		\$1,174.85		
RC	No	4		
		\$810.00		
PD	No	5		
		\$520.00		

CORR	No	14		
		\$39.55		
VLD	No	19		
RCT	No	3		
NS	No	5		

Z	DEPT		0001	Department report title/reset counter
			0001015	Report code
DEPT01		38		Department name/No. of items *2
8.13%		\$257.53		Sales ratio/amount *2
OLD PRC		\$2.21		Old price amount *2
RED PRC		\$4.18		Red price amount *2
DISCOUNT		\$5.80		Discount amount *2
DEPT02		183		
		\$1,362.26		

RED PRC		\$12.21		
DISCOUNT		\$17.22		

TL		88.61		Total No. of items
		\$1,916.10		Total amount
RED PRC		\$12.18		Red amount total
DISCOUNT		\$9.50		Discount amount total

Z	CASHIER		0001	Clerk report title/reset counter
			0001017	Report code
C01	1		Clerk name/drawer No.
GROSS		421.25		Gross total
		\$2,872.28		
NET	No	111		Net total
		\$1,845.35		
CAID		\$1,057.14		Cash in drawer
CHID		\$139.04		
RF	No	1		Refund mode
		\$1.00		
CLEAR	No	5		Clear key count
		\$4.43		

C02	1		Clerk name/drawer No.

*1 Money declaration:

Count how much cash is in the drawer and input this amount (up to 10 digits).

The cash register will automatically compare the input with the cash in drawer in the memory and print the difference between these two amounts.

Note that if money declaration is required by programming, you cannot skip this procedure.

*2 Zero totalled departments/functions (the amount and item numbers are both zero) are not printed.

*3 These items can be skipped by programming.

4 The "" symbol is printed on the reset report, memory overflow occurred in the counter/totalizer.

Advanced Operations

To print the PLU/flat-PLU read/reset report

This report shows sales for PLUs.

OPERATION	REPORT																																																																												
<div style="border: 1px solid black; padding: 5px; width: fit-content; margin: 0 auto;"> <p>X1/Z1 (read/reset)</p> <p>Mode switch</p> </div> <p style="text-align: center;">↓</p> <div style="display: flex; justify-content: center; gap: 10px;"> <div style="border: 1px solid black; padding: 2px 10px; font-weight: bold;">0</div> <div style="border: 1px solid black; padding: 2px 10px; font-weight: bold;">1</div> <div style="border: 1px solid black; padding: 2px 10px; font-weight: bold;">4</div> <div style="border: 1px solid black; padding: 2px 10px; font-size: 8px;">CA/AMT /TEND</div> </div>	<table border="1" style="width: 100%; border-collapse: collapse;"> <tbody> <tr> <td>X</td> <td>PLU</td> <td></td> <td>Read symbol/report title</td> </tr> <tr> <td></td> <td></td> <td>0000014</td> <td>Report code</td> </tr> <tr> <td>PLU0001</td> <td></td> <td>17</td> <td>PLU name/No. of items</td> </tr> <tr> <td>0.53%</td> <td></td> <td>\$17.00</td> <td>Sales ratio/PLU amount</td> </tr> <tr> <td>OLD PRC</td> <td></td> <td>\$0.00</td> <td>Old price amount</td> </tr> <tr> <td>RED PRC</td> <td></td> <td>\$2.18</td> <td>Red price amount</td> </tr> <tr> <td>DISCOUNT</td> <td></td> <td>\$2.50</td> <td>Discount amount</td> </tr> <tr> <td>#000001</td> <td></td> <td></td> <td>PLU random code</td> </tr> <tr> <td>PLU0100</td> <td></td> <td>42</td> <td></td> </tr> <tr> <td>4.03%</td> <td></td> <td>\$69.00</td> <td></td> </tr> <tr> <td>OLD PRC</td> <td></td> <td>\$0.00</td> <td></td> </tr> <tr> <td>RED PRC</td> <td></td> <td>\$5.18</td> <td></td> </tr> <tr> <td>DISCOUNT</td> <td></td> <td>\$0.50</td> <td></td> </tr> <tr> <td>#000100</td> <td></td> <td></td> <td></td> </tr> <tr> <td colspan="4" style="text-align: center;">-----</td> </tr> <tr> <td>TL</td> <td></td> <td>188.61</td> <td>Total No. of items</td> </tr> <tr> <td></td> <td></td> <td>\$516.10</td> <td>Total amount</td> </tr> <tr> <td>RED PRC</td> <td></td> <td>\$12.18</td> <td>Red amount total</td> </tr> <tr> <td>DISCOUNT</td> <td></td> <td>\$9.50</td> <td>Discount amount total</td> </tr> </tbody> </table>	X	PLU		Read symbol/report title			0000014	Report code	PLU0001		17	PLU name/No. of items	0.53%		\$17.00	Sales ratio/PLU amount	OLD PRC		\$0.00	Old price amount	RED PRC		\$2.18	Red price amount	DISCOUNT		\$2.50	Discount amount	#000001			PLU random code	PLU0100		42		4.03%		\$69.00		OLD PRC		\$0.00		RED PRC		\$5.18		DISCOUNT		\$0.50		#000100				-----				TL		188.61	Total No. of items			\$516.10	Total amount	RED PRC		\$12.18	Red amount total	DISCOUNT		\$9.50	Discount amount total
X	PLU		Read symbol/report title																																																																										
		0000014	Report code																																																																										
PLU0001		17	PLU name/No. of items																																																																										
0.53%		\$17.00	Sales ratio/PLU amount																																																																										
OLD PRC		\$0.00	Old price amount																																																																										
RED PRC		\$2.18	Red price amount																																																																										
DISCOUNT		\$2.50	Discount amount																																																																										
#000001			PLU random code																																																																										
PLU0100		42																																																																											
4.03%		\$69.00																																																																											
OLD PRC		\$0.00																																																																											
RED PRC		\$5.18																																																																											
DISCOUNT		\$0.50																																																																											
#000100																																																																													

TL		188.61	Total No. of items																																																																										
		\$516.10	Total amount																																																																										
RED PRC		\$12.18	Red amount total																																																																										
DISCOUNT		\$9.50	Discount amount total																																																																										

To print the hourly sales read/reset report

This report shows hourly breakdowns of sales.

OPERATION	REPORT																																																																				
<div style="border: 1px solid black; padding: 5px; width: fit-content; margin: 0 auto;"> <p>X1/Z1 (read/reset)</p> <p>Mode switch</p> </div> <p style="text-align: center;">↓</p> <div style="display: flex; justify-content: center; gap: 10px;"> <div style="border: 1px solid black; padding: 2px 10px; font-weight: bold;">0</div> <div style="border: 1px solid black; padding: 2px 10px; font-weight: bold;">1</div> <div style="border: 1px solid black; padding: 2px 10px; font-weight: bold;">9</div> <div style="border: 1px solid black; padding: 2px 10px; font-size: 8px;">CA/AMT /TEND</div> </div>	<table border="1" style="width: 100%; border-collapse: collapse;"> <tbody> <tr> <td>X</td> <td>HOURLY</td> <td></td> <td>Read symbol/report title</td> </tr> <tr> <td></td> <td></td> <td>0000019</td> <td>Report code</td> </tr> <tr> <td>00:00->01:00</td> <td></td> <td></td> <td>Time range</td> </tr> <tr> <td></td> <td>CT</td> <td>1</td> <td>No. of customers</td> </tr> <tr> <td>GROSS</td> <td></td> <td>\$1.10</td> <td>Gross sales amount</td> </tr> <tr> <td>NET</td> <td>No</td> <td>1</td> <td>No. of receipt</td> </tr> <tr> <td>1.90%</td> <td></td> <td>\$1.20</td> <td>Sales ratio/net sales amount</td> </tr> <tr> <td>23:00->00:00</td> <td></td> <td></td> <td></td> </tr> <tr> <td></td> <td>CT</td> <td>1</td> <td></td> </tr> <tr> <td></td> <td></td> <td>\$3.45</td> <td></td> </tr> <tr> <td>NET</td> <td>No</td> <td>1</td> <td></td> </tr> <tr> <td>3.90%</td> <td></td> <td>\$3.59</td> <td></td> </tr> <tr> <td colspan="4" style="text-align: center;">-----</td> </tr> <tr> <td>TL</td> <td>CT</td> <td>280</td> <td>Total No. of customers</td> </tr> <tr> <td>GROSS</td> <td></td> <td>\$1,937.61</td> <td>Gross total amount</td> </tr> <tr> <td>NET</td> <td>No</td> <td>25</td> <td>Total No. of receipt</td> </tr> <tr> <td></td> <td></td> <td>\$2,096.80</td> <td>Net total amount</td> </tr> </tbody> </table>	X	HOURLY		Read symbol/report title			0000019	Report code	00:00->01:00			Time range		CT	1	No. of customers	GROSS		\$1.10	Gross sales amount	NET	No	1	No. of receipt	1.90%		\$1.20	Sales ratio/net sales amount	23:00->00:00					CT	1				\$3.45		NET	No	1		3.90%		\$3.59		-----				TL	CT	280	Total No. of customers	GROSS		\$1,937.61	Gross total amount	NET	No	25	Total No. of receipt			\$2,096.80	Net total amount
X	HOURLY		Read symbol/report title																																																																		
		0000019	Report code																																																																		
00:00->01:00			Time range																																																																		
	CT	1	No. of customers																																																																		
GROSS		\$1.10	Gross sales amount																																																																		
NET	No	1	No. of receipt																																																																		
1.90%		\$1.20	Sales ratio/net sales amount																																																																		
23:00->00:00																																																																					
	CT	1																																																																			
		\$3.45																																																																			
NET	No	1																																																																			
3.90%		\$3.59																																																																			

TL	CT	280	Total No. of customers																																																																		
GROSS		\$1,937.61	Gross total amount																																																																		
NET	No	25	Total No. of receipt																																																																		
		\$2,096.80	Net total amount																																																																		

To print the monthly sales read/reset report

This report shows monthly breakdowns of sales.

OPERATION	REPORT																																																																																
<div style="border: 1px solid black; padding: 5px; display: inline-block;"> X1/Z1 (read/reset) Mode switch </div> <div style="display: flex; align-items: center; justify-content: center;"> <div style="border: 1px solid black; padding: 2px 5px; margin: 0 2px;">0</div> <div style="border: 1px solid black; padding: 2px 5px; margin: 0 2px;">2</div> <div style="border: 1px solid black; padding: 2px 5px; margin: 0 2px;">0</div> <div style="border: 1px solid black; padding: 2px 5px; margin: 0 2px;">CA/AMT /TEND</div> </div>	<table border="1"> <tbody> <tr> <td>X</td> <td>MONTHLY</td> <td>0000020</td> <td>Read symbol/report title Report code</td> </tr> <tr> <td></td> <td>1.....</td> <td></td> <td>Date of a month</td> </tr> <tr> <td>GROSS</td> <td></td> <td>1236.76</td> <td>Gross symbol/No. of items</td> </tr> <tr> <td></td> <td></td> <td>\$12,202.57</td> <td>Gross sales amount</td> </tr> <tr> <td>NET</td> <td>No</td> <td>214</td> <td>Net symbol/No. of customers</td> </tr> <tr> <td></td> <td></td> <td>\$12,202.57</td> <td>Net sales amount</td> </tr> <tr> <td colspan="4" style="text-align: center;">-----</td> </tr> <tr> <td></td> <td>31.....</td> <td></td> <td></td> </tr> <tr> <td>GROSS</td> <td></td> <td>2132</td> <td>Total symbol</td> </tr> <tr> <td></td> <td></td> <td>\$14,187.57</td> <td>Gross symbol/No. of items</td> </tr> <tr> <td>NET</td> <td>No</td> <td>205</td> <td>Gross sales amount</td> </tr> <tr> <td></td> <td></td> <td>\$13,398.76</td> <td>Average daily gross sales</td> </tr> <tr> <td colspan="4" style="text-align: center;">-----</td> </tr> <tr> <td>TL</td> <td></td> <td></td> <td>Total symbol</td> </tr> <tr> <td>GROSS</td> <td></td> <td>9746.63</td> <td>Gross symbol/No. of items</td> </tr> <tr> <td></td> <td></td> <td>\$161,022.49</td> <td>Gross sales amount</td> </tr> <tr> <td></td> <td></td> <td>.16.52</td> <td>Average daily gross sales</td> </tr> <tr> <td>NET</td> <td>No</td> <td>2351</td> <td>Net symbol/No. of customers</td> </tr> <tr> <td></td> <td></td> <td>\$161,022.49</td> <td>Net sales amount</td> </tr> <tr> <td></td> <td></td> <td>.68.49</td> <td>Average daily net sales</td> </tr> </tbody> </table>	X	MONTHLY	0000020	Read symbol/report title Report code		1.....		Date of a month	GROSS		1236.76	Gross symbol/No. of items			\$12,202.57	Gross sales amount	NET	No	214	Net symbol/No. of customers			\$12,202.57	Net sales amount	-----					31.....			GROSS		2132	Total symbol			\$14,187.57	Gross symbol/No. of items	NET	No	205	Gross sales amount			\$13,398.76	Average daily gross sales	-----				TL			Total symbol	GROSS		9746.63	Gross symbol/No. of items			\$161,022.49	Gross sales amount			.16.52	Average daily gross sales	NET	No	2351	Net symbol/No. of customers			\$161,022.49	Net sales amount			.68.49	Average daily net sales
X	MONTHLY	0000020	Read symbol/report title Report code																																																																														
	1.....		Date of a month																																																																														
GROSS		1236.76	Gross symbol/No. of items																																																																														
		\$12,202.57	Gross sales amount																																																																														
NET	No	214	Net symbol/No. of customers																																																																														
		\$12,202.57	Net sales amount																																																																														

	31.....																																																																																
GROSS		2132	Total symbol																																																																														
		\$14,187.57	Gross symbol/No. of items																																																																														
NET	No	205	Gross sales amount																																																																														
		\$13,398.76	Average daily gross sales																																																																														

TL			Total symbol																																																																														
GROSS		9746.63	Gross symbol/No. of items																																																																														
		\$161,022.49	Gross sales amount																																																																														
		.16.52	Average daily gross sales																																																																														
NET	No	2351	Net symbol/No. of customers																																																																														
		\$161,022.49	Net sales amount																																																																														
		.68.49	Average daily net sales																																																																														

To print the group read/reset report

This report shows PLU/department group totals.

OPERATION	REPORT																																																				
<div style="border: 1px solid black; padding: 5px; display: inline-block;"> X1/Z1 (read/reset) Mode switch </div> <div style="display: flex; align-items: center; justify-content: center;"> <div style="border: 1px solid black; padding: 2px 5px; margin: 0 2px;">0</div> <div style="border: 1px solid black; padding: 2px 5px; margin: 0 2px;">1</div> <div style="border: 1px solid black; padding: 2px 5px; margin: 0 2px;">6</div> <div style="border: 1px solid black; padding: 2px 5px; margin: 0 2px;">CA/AMT /TEND</div> </div>	<table border="1"> <tbody> <tr> <td>X</td> <td>GROUP</td> <td>0000016</td> <td>Read symbol/report title Report code</td> </tr> <tr> <td>GROUP01</td> <td></td> <td>203.25</td> <td>Group No./No. of items</td> </tr> <tr> <td></td> <td>33.87%</td> <td>\$1,108.54</td> <td>Sales ratio/group amount</td> </tr> <tr> <td>GROUP02</td> <td></td> <td>183</td> <td></td> </tr> <tr> <td></td> <td>40.58%</td> <td>\$1,327.80</td> <td></td> </tr> <tr> <td>GROUP03</td> <td></td> <td>12</td> <td></td> </tr> <tr> <td></td> <td></td> <td>\$13.25</td> <td></td> </tr> <tr> <td colspan="4" style="text-align: center;">-----</td> </tr> <tr> <td>GROUP99</td> <td></td> <td>12</td> <td></td> </tr> <tr> <td></td> <td>0.54%</td> <td>\$17.80</td> <td></td> </tr> <tr> <td colspan="4" style="text-align: center;">-----</td> </tr> <tr> <td>TL</td> <td></td> <td>862</td> <td>Group total No. of items</td> </tr> <tr> <td></td> <td></td> <td>\$3,272.00</td> <td>Group total amount</td> </tr> </tbody> </table>	X	GROUP	0000016	Read symbol/report title Report code	GROUP01		203.25	Group No./No. of items		33.87%	\$1,108.54	Sales ratio/group amount	GROUP02		183			40.58%	\$1,327.80		GROUP03		12				\$13.25		-----				GROUP99		12			0.54%	\$17.80		-----				TL		862	Group total No. of items			\$3,272.00	Group total amount
X	GROUP	0000016	Read symbol/report title Report code																																																		
GROUP01		203.25	Group No./No. of items																																																		
	33.87%	\$1,108.54	Sales ratio/group amount																																																		
GROUP02		183																																																			
	40.58%	\$1,327.80																																																			
GROUP03		12																																																			
		\$13.25																																																			

GROUP99		12																																																			
	0.54%	\$17.80																																																			

TL		862	Group total No. of items																																																		
		\$3,272.00	Group total amount																																																		

Advanced Operations

• Periodic sales read report (“X2” mode)

You can print read reports at any time during the business day without affecting the data stored in the cash register's memory.

• Periodic sales reset report (“Z2” mode)

You should print reset reports at the end of the business day.

To print the periodic 1/2 sales read/reset reports

These reports show sales breakdowns of sales by any two kinds of period you want.

OPERATION

REPORT

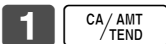
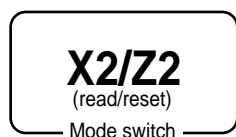

ZZ1	BATCH	02			Report title

ZZ1	FIX		0001		Fixed total report title/reset counter
			0001111		Report code
GROSS			981.25		Gross total *2
			\$6,574.40		
NET	No		111		Net total *2
			\$7,057.14		
CAID			\$6,919.04		Cash in drawer *2
CHID			\$139.04		Charge in drawer *2
CKID			\$859.85		Check in drawer *2
CRID(1)			\$709.85		Credit in drawer *2

RF	No		3		Refund mode *2
			\$10.22		
CUST	CT		111		Customer number *2
AVRG			\$63.57		Average sales per customer *2
DC			\$1.22		Discount total *2
REF			\$2.42		Refund key *2
CLEAR	No		85		Clear key count *2
ROUND			\$0.00		Rounding total *2
CANCEL	No		2		Cancellation *2
			\$12.97		

TA1			\$2,369.69		Taxable 1 amount *2
TX1			\$128.86		Tax 1 amount *2
TA2			\$2,172.96		Taxable 2 amount *2
TX2			\$217.33		Tax 2 amount *2

ZZ1	TRANS		0001		Function key report title/reset counter
			0001112		Report code
CASH	No		362		Function key count/amount *1
			\$1,638.04		
CHARGE	No		56		
			\$1,174.85		
RC	No		4		
			\$810.00		
PD	No		5		
			\$5.00		
CORR	No		14		
			\$39.55		
VLD	No		19		
RCT	No		3		
NS	No		5		

ZZ1 DEPT	0001	Department report title/reset counter
	0001115	Report code
DEPT01	38	Department Name/No. of items *1
8.13%	\$257.53	Sales ratio/amount *1
OLD PRC	\$2.21	Old price amount *1
RED PRC	\$4.18	Red price amount *1
DISCOUNT	\$5.80	Discount amount *1
DEPT02	183	
	\$1,362.26	
RED PRC	\$123.21	
DISCOUNT		

TL	88.61	Total No. of items
	\$1,916.10	Total amount
RED PRC	\$12.18	Red amount total
DISCOUNT	\$9.50	Discount amount total

ZZ1 CASHIER	0001	Clerk report title/reset counter
	0001117	Report code
C01 1	Clerk name/drawer No.
GROSS	421.25	Gross total
	\$2,872.28	
NET	No 111	Net total
	\$1,845.35	
CAID	\$1,057.14	Cash in drawer
CHID	\$139.04	
RF	No 1	Refund mode
	\$1.00	
CLEAR	No 5	Clear key count
	\$4.43	
C02 1	Clerk name/drawer No.

*1 Zero totalled departments/functions (the amount and item numbers are both zero) are not printed.

*2 These items can be skipped by programming.

Advanced Operations

To print other sales read/reset reports

The following reports can be issued.

Procedure

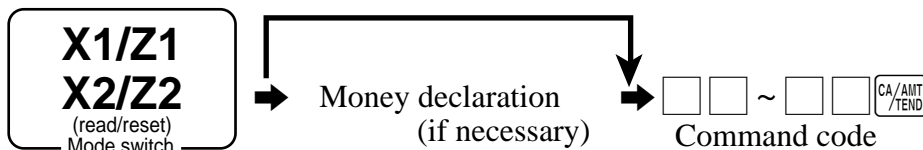

Report/command code list

Report name	Command code # = 0 # = 1 (read) (reset)			Report name	Command code # = 0 # = 1 (read) (reset)		
	Daily	Periodic 1	Periodic 2		Daily	Periodic 1	Periodic 2
Fix totalizer	11	#111	#211	Department	15	#115	#215
Transaction key	12	#112	#212	best 50 (amount order)	60015	60115	60215
PLU by record number (all) *	14	#114	#214	best 50 (quantity order)	70015	70115	70215
all PLU by random code *	14	#114	#214	Group	16	#116	#216
by group	1000014	100#114	100#214	Clerk	17	#117	#217
by department	2000014	200#114	200#214	individual	20017	2#117	2#217
individual by group	1020014	102#114	102#214	Hourly sales	19	#119	#219
individual by department	2020014	202#114	202#214	Monthly sales	20	#120	#220
range by record number *	10014	1#114	1#214	Open check	25	-----	-----
range by random code *	10014	1#114	1#214	total	40025	-----	-----
best 50 (amount order)	60014	60114	60214	Scanning PLU by range department (all)	26	-----	-----
best 50 (quantity order)	70014	70114	70214	by range group	1000026	-----	-----
menu (1st)	81	#181	#281	by range department	2000026	-----	-----
menu (2nd)	82	#182	#282	best 50 by range department	80026	-----	-----
menu (3rd)	83	#183	#283	inactive item by range department	90026	-----	-----
menu (4th)	84	#184	#284	Scanning PLU stock by range department (all)	65	-----	-----
menu (5th)	85	#185	#285	by range group	1000065	-----	-----
menu (6th)	86	#186	#286	by range department	2000065	-----	-----
PLU stock all PLU by record number *	64	-----	-----	Table analysis	28	#128	#228
all by random PLU code *	64	-----	-----	Mix & match	61	#161	#261
by group	1000064	-----	-----	Financial	71	-----	-----
by department	2000064	-----	-----	Individual (item / transaction key)	No code	-----	-----
individual by group	1020064	-----	-----	PLU reset (no report)	50014	51114	51214
individual by department	2020064	-----	-----	Scanning PLU reset (no report)	50026	-----	-----
range by record number *	10064	-----	-----	Scanning PLU stock reset (no report)	50065	-----	-----
range by random code *	10064	-----	-----				

* You can choose by record number / random code by program.

Reading the cash register's program

To print unit price/rate program (except PLU/scanning PLU)

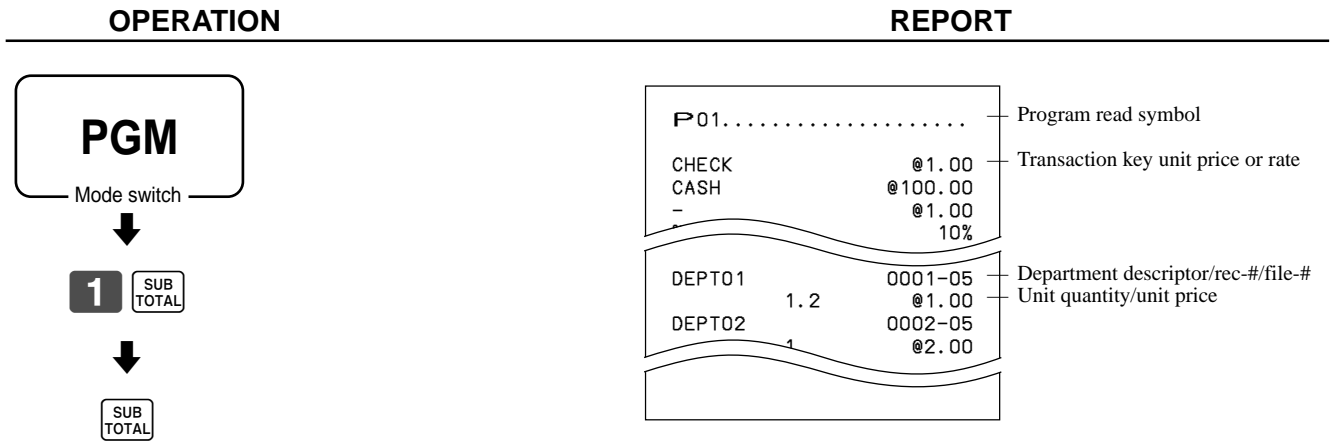

Advanced Operations

To print key descriptor, name, message program (except PLU)

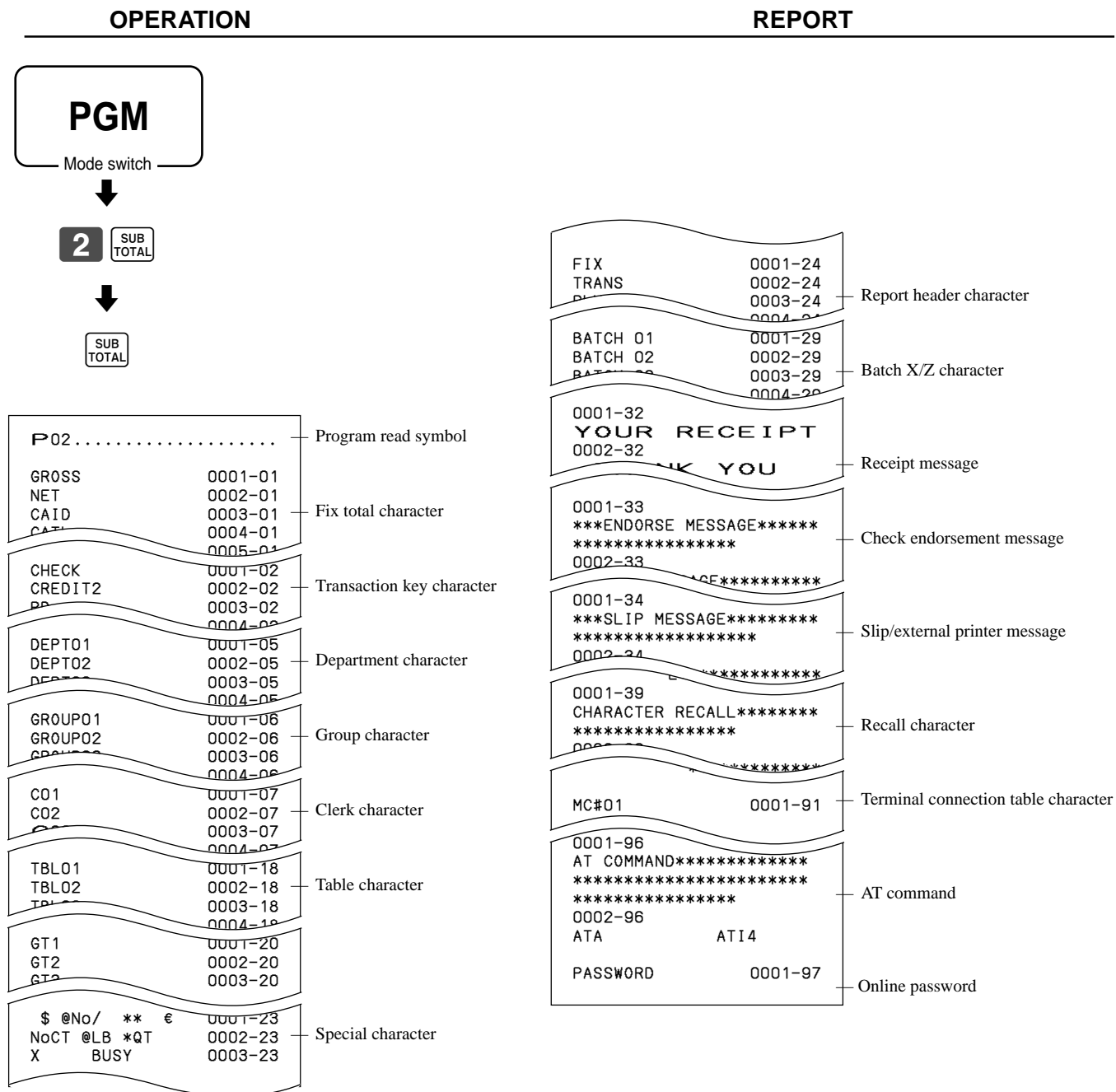

To print the PLU/flat-PLU program

OPERATION

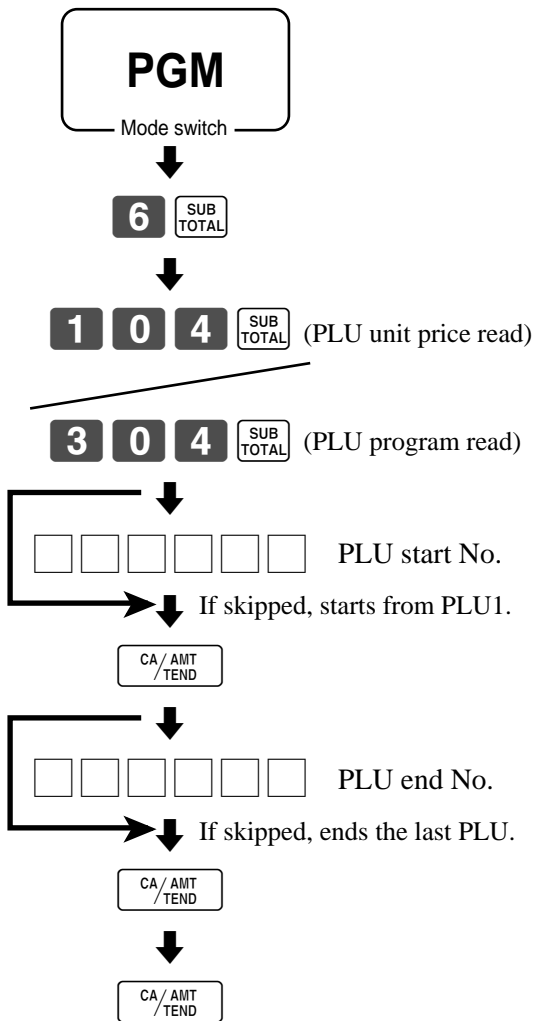

REPORT

P01.....	Program read symbol
#000001 - #999999	Read range
PLU0001 0001-04	Item character/rec-#/file-#
#000001	Random code
@1.00	Unit quantity/unit price
PLU0002 0002-04	
#000002	
@2.00	
1	
P03.....	Program read symbol
#000001 - #999999	Read range
PLU0001 0001-04	Item character/rec-#/file-#
00000000000000	Batch program 01 ~ 1066, 18 ~ 1966
11-66 0000	Batch program 1166
12-66 #000001	Batch program 1266
13-66 <- 0001-28	Batch program 1366
14-66 0	Batch program 1466
15-66 @1234.56	Batch program 1566
PLU0002 0002-04	
00000000000000	
11-66 000000	

Troubleshooting

This section describes what to do when you have problems with operation.

When an error occurs

Errors are indicated by an error codes. When this happens, you can usually find out what the problem is as illustrated below.

Press **C** and check the appropriate section of this manual for the operation you want to perform.

Error code	Message	Meaning	Action
E001	WRONG MODE	Mode switch position changed before finalization.	Return the mode switch to its original setting and finalize the operation.
E003	WRONG OPERATOR	Clerk button pressed before finalization of a registration being performed under another clerk button. The signed on clerk differs from the clerk performed the tracking check registration.	Press the original clerk button and finalize the transaction before pressing another clerk button. Input correct check number or assign the proper clerk number.
E004	ERROR INIT/FC	Initialization or unit lock clear operation in progress.	Complete operation.
E005	INSUFFICIENT MEMORY	Memory allocation exceeds total memory capacity.	Reallocate memory or expand memory (if possible).
E008	PLEASE SIGN ON	Registration without entering a clerk number.	Enter a clerk number.
E009	ENTER PASSWORD	Operation without entering the password.	Enter password.
E010	CLOSE THE DRAWER	The drawer is left open longer than the program time (drawer open alarm).	Close the drawer.
E011	CLOSE THE DRAWER	Attempt to register while the cash drawer is open.	Shut the cash drawer.
E016	CHANGE BACK TO REG MODE	Two consecutive transactions attempted in the refund mode.	Switch to another mode and then back to the RF mode for the next transaction.
E017	ENTER CHK/TBL NUMBER	Attempt made to register an item without inputting a check number.	Input a check number.
E018	ENTER TABLE NUMBER	Attempt made to register an item without inputting a table number.	Input a table number.
E019	ENTER NUMBER OF CUSTOMERS	Finalize operation attempted without entering the number of customer.	Enter the number of customer.
E021	NO DEPT LINK	No department linked PLU is registered.	Correct the program.
E023	STOCK SHORTAGE	Actual stock quantity becomes less than the minimum stock quantity.	Perform stock maintenance.
E024	NO STOCK	Actual stock quantity becomes/is negative.	Perform stock maintenance.
E026	ENTER CONDIMENT/PREPARATION PLU	No condiment/preparation PLU is registered.	Register condiment/preparation PLU.
E029	IN THE TENDER OPERATION	Item registration is prohibited, while partial tender.	Finalize the transaction.
E030	PRESS RATE TAX KEY	Finalization of a transaction attempted without registering rate-tax.	Register <RATE TAX>.
E031	PRESS ST KEY	Finalization of a transaction attempted without confirming the subtotal.	Press <SUBTOTAL>.
E032	PRESS FSST KEY	Finalization of a transaction attempted without confirming of the food stamp subtotal.	Press <FS/ST>.
E033	ENTER TENDERED AMOUNT	Finalize operation attempted without entering amount tender.	Enter the amount tendered.
E035	CHANGE AMOUNT EXCEEDS LIMIT	Change amount exceeds preset limit.	Input amount tendered again.
E036	REMOVE MONEY FROM THE DRAWER	Contents of the drawer exceed programmed limit.	Perform pick up operation.
E037	DIGIT OR AMOUNT LIMITATION OVER	High amount lock out/low digit lock out error	Enter correct amount.
E038	PERFORM MONEY DECLARATION	Read/reset operation without declaring cash in drawer. This error appears only when this function is activated.	Perform money declaration.
E040	ISSUE GUEST RECEIPT	Attempt to register a new transaction without issuing a guest receipt.	Issue a guest receipt.
E041	PRINT VALIDATION	Attempt to register a new transaction without validation.	Perform validation operation.
E042	INSERT VLD PAPER AND RETRY	Validation paper (slip printer) has run out.	Insert new validation paper.
E044	PRINT CHEQUE	Attempt to register a new transaction without printing check.	Perform check print.
E045	PRINT CHECK ENDORSEMENT	Attempt to register a new transaction without printing check endorsement.	Perform check endorsement.
E046	REG BUFFER FULL	Registration buffer full.	Finalize the transaction.
E047	PRINT BILL	Separate check buffer full.	Allocate sufficient separate check buffer.
E048	INSERT SLIP PAPER	Attempt to register a new transaction without printing slip.	Perform slip printing operation.

Troubleshooting

Error code	Message	Meaning	Action
	AND RETRY	No paper is inserted or paper is out in the slip printer.	Insert new slip paper.
E049	CHECK MEMORY FULL	Check tracking index memory full.	Finalize and close the check number currently used.
E050	DETAIL MEMORY FULL	Check tracking detail memory full.	Finalize and close the check number currently used.
E051	CHK/TBL NO. IS OCCUPIED	Attempt to made use <New Check> to open a new check using a number that is already used for an existing check in check tracking memory.	Finalize and close the check that is currently under the number that you want to use or use a different check number.
E052	CHK/TBL NO. IS BUSY	Attempt to use the same check number whilst the specified number is being used in the other terminal.	Use another check number or close the check at that terminal.
E053	CHK/TBL NO. IS NOT OPENED	Attempt made to use <Old Check> reopen a new check using a number that is not used for an existing check in check tracking memory.	Use the correct check number (if you want to reopen a check that already exists in check tracking memory) or use <New Check> to open a new check.
E054	OUT OF CHK/TBL NO. RANGE	Check number range over.	Enter correct number.
E055	IN THE SEP CHK OPERATION	Normal registration is prohibited during separate check operation.	Terminate separate check operation.
E056	CHK RANGE FULL	All check number are occupied in range.	Recall the stored data.
E059	PRESS EAT-IN OR TAKE-OUT KEY	Attempt to finalize a transaction without specifying <EAT-IN> or <TAKE-OUT>.	Press <EAT-IN> or <TAKE-OUT>.
E060	PRINTER OFFLINE	External printer offline	
E061	PRINTER ERROR	External printer went down.	
E062	PRINTER PAPER END	External printer paper end	Replace new paper.
E064	PRINT BUFFER FULL	Printing buffer full	
E066	PRINT FROM THE BEGINNING OF THE TRANSACTION	Attempt to print the last separated transaction on slip.	Print from the beginning of the transaction
E075	NEGATIVE BALANCE CANNOT BE FINALIZED	Attempt to finalize a transaction when balance is less than or equal to zero.	Register item(s) until the balance becomes positive amount.
E085	DATA EXIST IN CONSOLIDATION FILE	Data exists in the consolidation file.	Clear the data.
E100	OPERATE AT THE MASTER TERMINAL	Prohibit master operation.	Perform it at master terminal.
E101	PLU MAINTENANCE FILE FULL. PRESS <#2> TO EXIT	Scanning PLU direct maintenance/batch maintenance file becomes full.	Terminate the maintenance.
E103	PLU CODE IS NOT EXIST. INPUT THE PLU CODE	PLU code is not existed in the file.	Enter proper PLU code.
E105	PLU FILE FULL	Scanning PLU/not found PLU file full	Modify the designated item.
E106	ITEM EXISTS IN THE PLU FILE	The designated item has already existed in the scanning PLU file.	
E112	CLOSE THE JOURNAL PLATEN ARM	The journal platen arm is opened.	Close the journal platen arm.
E114	CLOSE THE RECEIPT PLATEN ARM	The receipt platen arm is opened.	Close the receipt platen arm.
E139	NEGATIVE BALANCE IS NOT ALLOWED	Attempt to register <-> or <CPN> when the balance becomes negative.	Enter proper minus/coupon amount.
E146	ARRANGEMENT FILE FULL	Arrangement file is full.	Set the arrangement properly.
E164	EMPLOYEE NO. IS NOT FOUND IN THE EMPLOYEE FILE	Attempt to enter a wrong employee number which is not set to the employee file.	Enter proper employee number.
E165	EMPLOYEE NO. IS NOT CLOCKING-IN.	Attempt to clock out the employee who is not clocked in.	Enter proper employee number.
E166	EMPLOYEE NO. IS OCCUPIED	Attempt to clock in the employee who has clocked in already.	Enter proper employee number.
E176	TIME&ATTENDANCE FILE FULL	Time and attendance file becomes full.	Delete unused employee number or reallocate the time and attendance file.
E200	INSERT CF CARD	No CF card is set.	Set CF card.
E201	ILLEGAL FORMAT	Illegally formatted CF card	Format the CF card.
E202	FILE NOT FOUND	The designated file is not found in the CF card.	Enter proper file name.
E203	INSUFFICIENT MEMORY	Insufficient memory in the CF card.	Use a vacant (formatted) CF card.
E205	FILE ALREADY EXIST.	Can not write, because designated file has already been in the CF card.	Check the operation and retry.

When the register does not operate at all

Perform the following check whenever the cash register enter an error condition as soon as you switch it on. The results of this check are required by service personnel, so be sure to perform this check before you contact a CASIO representative for servicing.

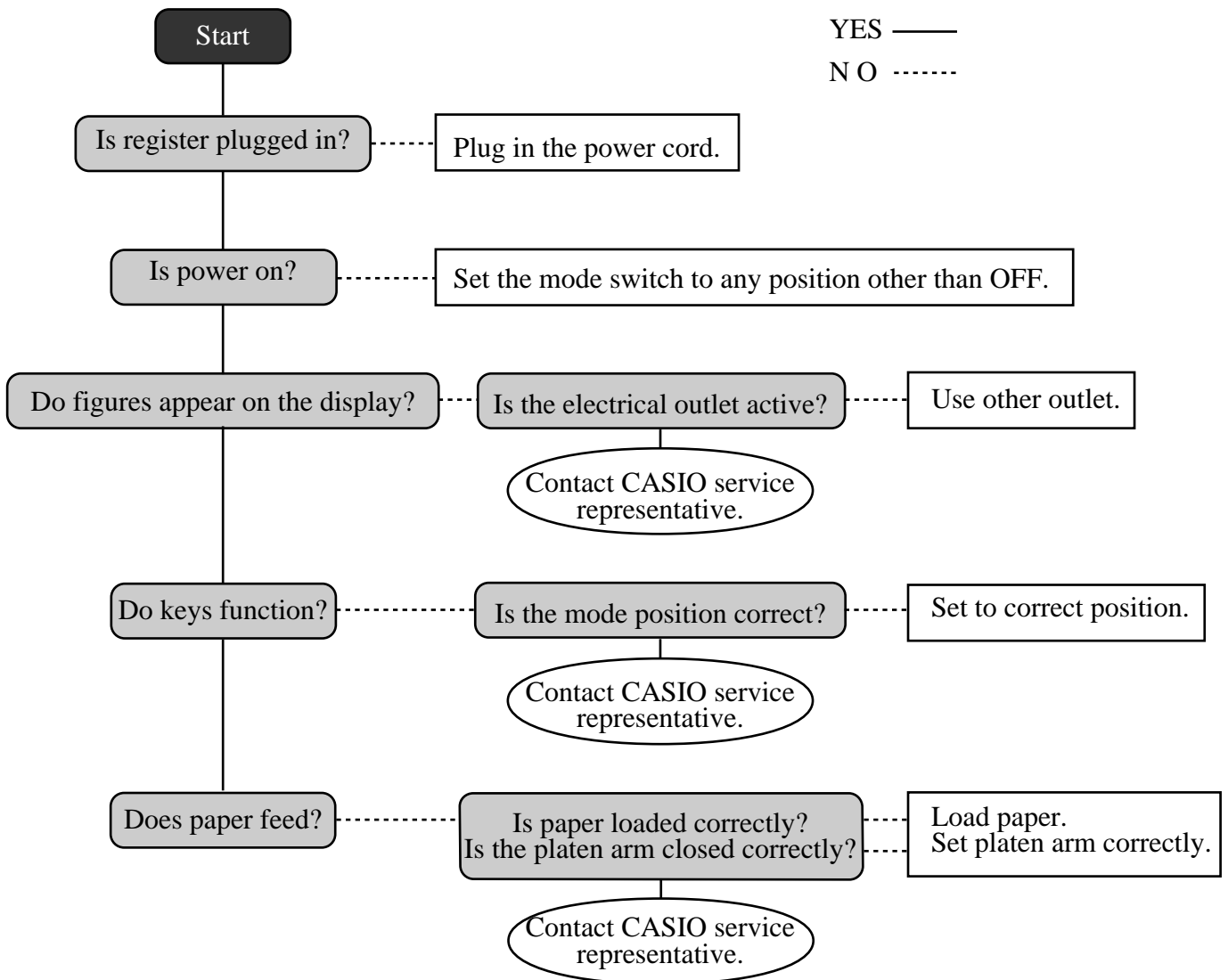

Clearing a machine lock up

If you make a mistake in operation, the cash register may lock up to avoid damage to programs and preset data. Should it happens, you can use the following procedure to clear the lock up without losing any data.

- 1 Power off the register.
- 2 Insert the PGM key in the mode switch.
- 3 Press down **RECEIPT FEED**, and turn the mode switch to PGM mode.
- 4 The display shows ten Fs, then release **RECEIPT FEED**.
- 5 Press **SUB TOTAL**. The display shows ten Fs and issue a receipt.

Important!

- If the register does not show ten Fs, never press **SUB TOTAL** and call service representative.

In case of power failure

If the power supply to the cash register is cut by a power failure or any other reason, simply wait for power to be restored. The details of any on-going transaction as well as all sales data in memory are protected by the memory backup batteries.

- Power failure during a registration
The subtotal for items registered up to the power failure is retained in memory. You will be able to continue with the registration when power is restored.
- Power failure during printing a read/reset report
The data already printed before the power failure is retained in memory. You will be able to issue a report when power is restored.
- Power failure during printing of a receipt and the journal
Printing will resume after power is restored. A line that was being printed when the power failure occurred is printed in full.
- Other
The power failure symbol is printed and any item that was being printed when the power failure occurred is reprinted in full.

Notes



If this indicator appears when you switch the cash register on, it can mean one of three things:

- No memory backup batteries are loaded in the cash register.
- The power of the batteries loaded in the unit is below a certain level.
- The batteries loaded in the unit are dead.

To clear this sign, press **C** key.

Important !

Whenever the low battery indicator appears on the display, load a set of three new batteries as soon as possible. If there is a power failure or you unplug the cash register when this indicator appears, you will lose all of your sales data and settings.

**BE SURE TO KEEP THE POWER CORD OF THE CASH REGISTER
PLUGGED IN WHENEVER YOU REPLACE THE BATTERIES.**

To replace journal paper

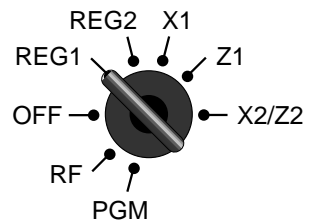

Step 1

Set the mode switch to the REG position and remove the printer cover.



Step 2

Press **JOURNAL FEED** to feed about 20 cm of paper.



Step 6

Slide the printed journal from the take-up reel.



Step 3

Cut the journal paper at the point where nothing is printed.



Step 7

Open the platen arm.



Step 4

Remove the journal take-up reel from its holder.



Step 8

Remove the old paper roll from the cash register.



Step 5

Remove the paper guide from the take-up reel.

Step 9

Load new paper.
Go to the step 3 described on page 13 of this manual.

To replace receipt paper



Step 1

Set the mode switch to the REG position and remove the printer cover.



Step 2

Open the platen arm.



Step 3

Remove the old paper roll from the cash register.

Step 4

Load new paper.
Go to the step 3 described on page 12 of this manual.

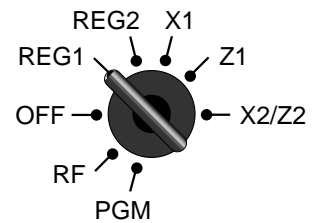

Options

Roll paper: P-5880T
Wetproof cover: WT-87
Hand held scanner: HHS-15

External printer: UP-360
Cable: PRT-CB-8A or PRT-CB-8B
Slip printer: SP-1300
Cable: PRT-CB-8C
Power supply: 31AD-U or 31AD-E

Consult with your CASIO dealer for details.

Specifications

Input method

Entry: 10-key system, buffer memory 8 keys (2-key roll over)
 Department: Full key system

Display

Main: Amount 10 digits (zero suppression); No. of repeats, total, change, receipt on/off, transaction indicator
 Descriptor 8 digits; item descriptor, clerk name
 Customer: Amount 8 digits (zero suppression): total, change indicator

Printer

Receipt: Thermal alpha-numeric system 24 digits, receipt on/off switch (key)
 Store name or slogan is printed automatically
 Journal: Thermal alpha-numeric system 24 digits
 Automatic take up roll winding
 Paper roll: 58 (W) × 80 (D) mm
 Paper thickness: 0.06 ~ 0.085 mm
 Paper feed: Separate for receipt and journal
 Print speed: About 14 l/s

Listing capacity

Amount: 99999999
 Quantity: 9999.999
 Tendered amount: 9999999999
 Percent: 99.99
 Tax rate: 9999.9999
 Numbers: 9999999999999999

Chronological data

Date print: Automatic date printout on receipt or journal, automatic calendar
 Time print: Automatic time printout on receipt or journal, 24-hour system/12-hour system

Alarm

Key catch tone, error alarm, sentinel alarm

Memory protection battery

The effective service life of the memory protection batteries (three new SUM-3 or UM-3 type batteries) is approximately one year from installation into the machine.

Power supply/power consumption

See the rating plate.

Operation temperature

0°C ~ 40°C (32°F ~ 104°F)

Humidity

10 ~ 90%

Dimensions and weight

277mm (H) × 400mm (W) × 450mm (D) / 12kg ...with medium size drawer
 (10 7/8" (H) × 15 3/4" (W) × 17 3/4" (D) / 26lbs. 7oz.)

Totalizers	Contents						
	Category	No. of totalizers	Amount (10 digits)	No. of items (6 integer/3 decimal)	Count (4 digits)	No. of customers (6 digits)	Periodic totalizers
Department	Up to 99	✓	✓				✓
PLU	Up to 2000	✓	✓				
Clerk	15	✓	✓	✓	✓	✓	✓
Hourly sales	24	✓				✓	
Monthly sales	31	✓	✓			✓	
Transaction	Variable with program						✓
Non ressettable grand total	3	✓ (16 digits)					
Reset counter	12/15				✓		
Consecutive No.	1				✓ (6 digits)		

* Specifications and design are subject to change without notice.

- A**
- add check 26, 78
 - adding to a check 75
 - addition (+) 52
 - alphabet key 91
 - arrangement 26, 59
 - assigning a clerk 30
- B**
- backspace key 91
 - bill copy 26, 83
 - bottle link 58
 - bottle return 26, 58
 - bottom message 28, 87
- C**
- cancel 24, 26, 48
 - CAP key 91
 - cash/amount tendered 25, 43
 - change 32
 - character code 92
 - character code fixed key 91
 - character enter key 91
 - character fixed key 91
 - character keyboard 91
 - charge 24, 43
 - check 24, 43
 - check endorsement 26
 - check print 26
 - check tracking 74
 - clearing a machine lock up 108
 - clerk interrupt 50
 - clerk key 21, 30
 - clerk name 30, 87
 - clerk number 24, 86
 - clerk read/reset report 95
 - clerk secret number key 21, 30
 - closing a check 76
 - commercial message 28, 87
 - commission rate 86
 - condiment 81
 - consecutive No. 28
 - correction 46
 - coupon 26, 55
 - coupon II (2) 26, 55
 - credit 24
 - cube 26
 - currency exchange 26, 60
 - cursor key 91
 - customer display 22
 - customer number 26
- D**
- daily sales read/reset report 96
 - daily sales reset report 49
 - date display 31
 - date setting 15
 - declaration 26
 - department 24, 32
 - deposit 26, 83
 - descriptor 87
 - discount (%-) 24, 40
 - display 22
 - double size letter key 91
 - drawer 21
- E**
- eat-in 26
 - EBT (electronic benefits transfer) 26, 69
 - editing character 93
 - entering characters 91
 - error code 106
 - error correction 24, 46
- F**
- financial read report 95
 - flat PLU 24, 32
 - food stamp 62
 - food stamp shift 26, 62
 - food stamp subtotal 26, 62
 - food stamp tender 26, 62
- G**
- group read/reset report 99
 - guest receipt 76
- H**
- high amount limitation 34
 - hourly sales read/reset report 98
- I**
- Illinois rule 65
 - indicator 23
 - individual clerk read/reset report 95
 - individual department, PLU/flat-PLU read report 94
 - item counter 28
- J**
- journal 28
 - journal skip 28
- K**
- keyboard 20, 24

L

loan 26, 56
logo message 28, 87

M

machine No. 28
main display 20, 22
manual tax 26
media change 26, 57
menu shift 24
merchandise subtotal 26, 39
message 28, 87
minus 24, 41
mixed tender 43
mode keys 20
mode switch 21
money declaration 95, 97
monthly sales read/reset report 99
multiplication 33, 37
multiplication/for 24, 33, 38

N

new balance 26, 75
new check 26, 74
new/old check 26, 74
no sale 25, 26
non add 25, 26
not found PLU 85
number of customers 71

O

OBR (optical barcode reader) 26
old check 26, 74
one touch NLU 27, 85
open 27
open 2 27
open 2 (release compulsion) 27, 72
open check 27
open PLU 38
opening a check 75
operator number 27
operator X/Z 27
option 111

P

paid out 24, 45
paper feed 25
paper installation 12
paper loading 12
paper replacement 110, 111
periodic sales 100

pick up 27, 57
platen arm 20
PLU 36
PLU/flat-PLU read/reset report 98
pop-up display 20
post receipt 24
power failure 109
premium (%+) 27, 53
preparation 81
preset price 35
preset tax status 35
preset tender 56
previous balance 27
previous balance subtotal 27
previous item void 84
price 27, 38
price change 27
price inquiry 27
price reductions (red price) 80
price shift 27
printer 20
printer cover 20
printing slip 73
program end key 91

R

read report 94
recall 27
receipt 28
receipt on/off 24
receipt on/off key 20
received on account 25, 45
red price 27, 80
reduction 41
refund 24, 44
repeat 23, 32, 37
reset report 49, 94
return 44
review 27, 79, 84
RF mode 44
roll paper 20
roll paper installation 12

S

scanning PLU 85
separate check 27, 79
set menu 59
shift key 91
sign off 30
sign on 30
single item 32, 37, 51
slip 73
slip back feed/release 27, 73
slip feed/release 27, 73
slip print 27, 73

space key 91
split sales of packaged item 33, 38
square 27
stock check 50
stock inquiry 27, 82
store 27

T

table number 27, 75
take-up reel 20
takeout 27
tax exempt 27
tax shift 24, 39
tax table 16
taxable amount subtotal 27
taxable status 39
text print 27
text recall 27, 72
time display 31
time setting 15
tip 27, 70
trainee status 86
tray total 27, 54

U

unit price inquiry 82

V

validation 27
VAT 27, 82
void 27

W

wetproof cover 111

CASIO®

CASIO COMPUTER CO., LTD.
6-2, Hon-machi 1-chome
Shibuya-ku, Tokyo 151-8543, Japan

TE-2400*INC

MO0506-A Printed in Malaysia

Printed on recycled paper.

Free Manuals Download Website

<http://myh66.com>

<http://usermanuals.us>

<http://www.somanuals.com>

<http://www.4manuals.cc>

<http://www.manual-lib.com>

<http://www.404manual.com>

<http://www.luxmanual.com>

<http://aubethermostatmanual.com>

Golf course search by state

<http://golfingnear.com>

Email search by domain

<http://emailbydomain.com>

Auto manuals search

<http://auto.somanuals.com>

TV manuals search

<http://tv.somanuals.com>