

DATA PROJECTOR

XJ-L8300HN

User's Guide

- Be sure to read the “Safety Precautions”, and make sure you use this product correctly.
- Keep this manual in a safe place for future reference.
- Visit the site below for the latest version of this manual.
<http://world.casio.com/manual/projector/>

- DLP is a registered trademark of Texas Instruments of the United States.
- HDMI, the HDMI Logo and High-Definition Multimedia Interface are trademarks or registered trademarks of HDMI Licensing, LLC.
- HDBaseT™ and the HDBaseT Alliance logo are trademarks of the HDBaseT Alliance.
- Blu-ray™ and the logo are trademarks of the Blu-ray Disc Association.
- PJLink is a pending trademark or a registered trademark in Japan, the United States, and other countries and areas.
- Crestron, Crestron Connected and Crestron Connected Logo are registered trademarks of Crestron Electronics, Inc. of the United States.
- AMX is a registered trademark of AMX LLC of the United States.
- XGA is a registered trademark of IBM Corporation of the United States.
- Other company and product names may be registered trademarks or trademarks of their respective owners.
- The contents of this User's Guide are subject to change without notice.
- Copying of this manual, either in part or its entirety is forbidden. You are allowed to use this manual for your own personal use. Any other use is forbidden without the permission of CASIO COMPUTER CO., LTD.
- CASIO COMPUTER CO., LTD. shall not be held liable for any lost profits or claims from third parties arising out of the use of this product or this manual.
- CASIO COMPUTER CO., LTD. shall not be held liable for any loss or lost profits due to loss of data due to malfunction or maintenance of this product, or any other reason.
- The sample screens shown in this manual are for illustrative purposes only, and may not be exactly the same as the screens actually produced by the product.

Table of Contents



Important safety instructions	4
Laser and High Temperature Precautions (See the label on the projector)	11
Other Precautions	12
Introduction	14
Shipping contents	14
Projector exterior view	15
Controls and functions	16
Positioning your projector	18
Choosing a location	18
Obtaining a preferred projected image size	18
Mounting the projector	20
Adjusting the projected image	21
Connection	22
Operation	25
Starting up the projector	25
Using the menus	26
Securing the projector.....	27
Switching input signal	28
Shutting down the projector	29
Menu operation	30
PICTURE menu	30
DISPLAY menu	33
INSTALLATION menu	34
SYSTEM SETUP: BASIC menu.....	35
SYSTEM SETUP: ADVANCED menu	35
INFORMATION menu	37
Controlling the projector remotely	38
Projector RS-232C Control	41
Maintenance	46
Care of the projector	46
Light source information.....	47
Troubleshooting	49
Specifications	50
Projector specifications	50
Dimensions	51
Timing chart	52

Important safety instructions

Safety Precautions

About safety symbols

Various symbols are used in this User's Guide and on the product itself to ensure safe use, and to protect you and others against the risk of injury and against material damage. The meaning of each of the symbols is explained below.

 Danger	This symbol indicates information that, if ignored or applied incorrectly, creates the risk of death or serious personal injury.
 Warning	This symbol indicates information that, if ignored or applied incorrectly, could possibly create the risk of death or serious personal injury.

Icon Examples



A triangle indicates a situation against which you need to exercise caution. The example shown here indicates you should take precaution against electric shock.



A circle with a line through it indicates information about an action that you should not perform. The specific action is indicated by the figure inside the circle. The example shown here means disassembly is prohibited.



A black circle indicates information about an action that you must perform. The specific action is indicated by the figure inside the circle. The example shown here indicates you must unplug the power cord from the power outlet.

Precautions During Use

Warning

- **Adult supervision is required whenever there are young children present and especially when there is the possibility of young children coming into contact with the projector.**

- **Smoke, odor, heat, and other abnormalities**



Should you ever notice smoke, strange odor, or any other abnormality, immediately stop using the projector. Continued use creates the risk of fire and electric shock. Immediately perform the following steps.

1. Unplug the projector.
2. Contact your original dealer or authorized CASIO service center.

- **Malfunction**



Immediately stop using the projector if the screen appears abnormal, or if any other abnormal operation occurs even though you are operating the projector correctly. Continued use creates the risk of fire and electric shock. Immediately perform the following steps.

1. Turn off the projector.
2. Unplug the projector.
3. Contact your original dealer or authorized CASIO service center.

• **Power cord**



Misuse of the power cord creates the risk of fire and electric shock.

Make sure that you always observe the following precautions.

- Be sure to use only the accessories that come with the projector.
- Make sure that you use a power source with the same voltage as that specified for the projector.
- Do not overload a power outlet with too many devices.
- Do not locate the power cord near a stove.
- Do not use the power cord that comes with the projector with any other device.
- Do not share the outlet supplying power to the projector with other devices. If you are using an extension cord, make sure that the ampere rating of the extension cord is compatible with the power consumption value of this projector.
- Never use the power cord while it is still bundled together.
- Use a conveniently located power outlet that you can reach easily when you need to unplug the projector.



A damaged power cord creates the risk of fire and electric shock.

Make sure that you always observe the following precautions.

- Never place heavy objects on the power cord and never expose it to heat.
- Make sure the power cord is not pinched between the wall and the rack or table where the projector is located, and never cover the power cord with a cushion or other object.
- Never try to modify the power cord, allow it to become damaged, or subject it to excessive bending.
- Do not twist the power cord or pull on it.



Never touch the power cord or plug while your hands are wet. Doing so creates the risk of electric shock.

- When using this projector in the country where you purchased it, be sure to use the power cord that came with it. Whenever using the projector in another country, be sure to purchase and use a power cord that is rated for the voltage of that country. Also make sure that you are aware of the Safety Standards that apply in that country.



When going out, make sure the projector is in a location away from pets and other animals, and unplug the power plug from the power outlet. A power cord damaged by chewing can cause shorts, and creates the risk of fire.

• **Water and foreign matter**



Never allow water to get on the projector. Water creates the risk of fire and electric shock.



Never place a vase or any other container of water on top of the projector. Water creates the risk of fire and electric shock.



Water or other liquid, or foreign matter (metal, etc.) getting into the projector creates the risk of fire and electric shock. Should anything get inside the projector, immediately perform the following steps.

1. Turn off the projector.
2. Unplug the projector.
3. Contact your original dealer or authorized CASIO service center.

• **Disassembly and modification**



Never try to take the projector apart or modify it in any way. The projector contains a large number of high-voltage components that create the risk of electric shock and burn injury. Also, note that problems caused by unauthorized projector disassembly or modification are not covered by the warranty and are not eligible for repair by CASIO.

Be sure to leave all internal inspection, adjustment, and repair up to your original dealer or authorized CASIO service center.

• **Dropping and impact**



Continued use of the projector after it has been damaged by dropping or other mistreatment creates the risk of fire and electric shock. Immediately perform the following steps.

1. Turn off the projector.
2. Unplug the projector.
3. Contact your original dealer or authorized CASIO service center.

• **Disposal by burning**



Never try to dispose of the projector by burning it. Doing so can cause an explosion, which creates the risk of fire and personal injury.

• **Projector light emission**



- Never look directly into the lens, intake vents, or exhaust vents while the light is on. When turning on the projector, check to make sure that no one is looking directly into its lens, intake vents, or exhaust vents. The strong light emitted by the projector creates the risk of eye damage.
- Do not attempt to use a magnifying glass, mirror, or other similar object to bend or reflect the projector's light, and never hold or place such object in the path of the projector's light. Refracted or reflected light can shine into a person's eyes and create the risk of eye damage.

• **Blocking the vents**



Never allow the vents to become blocked. Doing so causes internal heat build up, which creates the risk of fire and breakdown of the projector. Touching the projector while it is hot creates the risk of burn injury. Make sure that you always observe the following precautions.

- Allow at least 30cm (11.8 inches) between the projector and walls. Maintain a distance of at least 30 cm (11.8 inches) between surfaces and the other sides of the projector.
- Do not insert the projector into any space where air circulation is poor.
- Never cover the projector with a blanket or any similar item.
- Locate the projector on a firm, flat surface during use. Never use the projector while it is on a carpet, blanket, towel, seat cushion, or other pliable surface.
- Never stand the projector up on either end during use.
- **Projector cabinet**



Never open the projector's cabinet. Doing so creates the risk of electric shock.

- **Cleaning**



Before cleaning the projector, be sure to turn it off and unplug it from the power outlet. Failure to do so creates the risk of electric shock.

- **Exhaust vents**

The exhaust vents become very hot while the projector is running. Never touch them. Doing so creates the risk of burn injury. The areas near the exhaust vents also become quite hot. Never locate objects made of plastic or other heat-sensitive materials near or under the projector. Doing so creates the risk of deformation and discoloration of the object.

- **Lens cover (If your projector has a lens cover)**

Be sure to remove the lens cover before turning on the projector. Never leave the lens cover attached while the projector is in use.

- **Location**

Never locate the projector in any of the following types of locations. Doing so creates the risk of fire and electric shock.

- Near an area subject to strong vibration
- An area subject to large amounts of moisture or dust
- In a kitchen or other area exposed to oil smoke
- Near a heater, on a heated carpet, or in an area exposed to direct sunlight
- An area subject to temperature extremes (Operating temperature range is 5°C to 35°C (41°F to 95°F)).

- **Heavy objects**

Never place heavy objects on the projector or climb on top of the projector. Doing so creates the risk of fire and electric shock.

- **Water**

Never locate the projector in a bathroom or anywhere else there is the chance that it will be splashed with water.

- **Unstable location**



Never place the projector on an unstable surface or on a high shelf. Doing so can cause it to fall, creating the risk of personal injury.

• Using the projector on a base with casters

Whenever using the projector on a base that has casters, make sure that you lock the casters when not moving the base.

• Lightening

During a lightening storm, do not touch the plug of the projector's power cord.

• Remote controller



Never try to take the remote controller apart or modify it in any way. Doing so creates the risk of electric shock, burn injury, and other personal injury. Be sure to leave all internal inspection, adjustment, and repair up to your original dealer or authorized CASIO service center.



Never allow the remote controller to become wet. Water creates the risk of fire and electric shock.

• Do not use flammable gas sprays nearby



Do not spray flammable gas into or in the vicinity of the projector. The gas may ignite and create the risk of fire.

Battery Precautions



Danger



Should liquid leaking from an alkaline battery get into the eyes, immediately take the following steps.

1. Do not rub the eyes! Wash the eyes with clean water.
2. Contact a physician immediately. Failure to take immediate action can lead to loss of eyesight.



Warning

Misuse of batteries can cause them to leak and stain the area around them, or to explode, creating the risk of fire and personal injury. Make sure that you always observe the following precautions.



- Never try to take batteries apart and do not allow them to become shorted.
- Never expose batteries to heat or throw them into fire.
- Never mix old batteries and new ones.
- Never mix batteries of different types.
- Never try to charge batteries.



- Take care that batteries are oriented correctly when you load them.



Caution

Misuse of batteries can cause them to leak and stain the area around them, or to explode, creating the risk of fire and personal injury. Make sure that you always observe the following precaution.



- Use only the type of batteries that is specified for the remote controller.

• Dead batteries

Be sure to remove batteries from the remote controller as soon as they go dead.



- Remove batteries from the remote controller if you do not plan to use it for a long time.

• Disposing of batteries

Make sure that you dispose of used batteries in accordance with the rules and regulations in your local area.

Projector Light Emission



- Never block light output while the light is on.



- Never look directly into the lens while the light is on. Particular care is required when children are present.



Risk Group 2

1. As with any bright light source, do not stare into the beam, RG2 IEC 62471-5:2015
2. Possibly hazardous optical radiation emitted from this product.
3. Do not stare at operating lamp. May be harmful to the eyes.

About the Light Source Unit

- The projector's light source unit uses a laser.
- The life of the light source unit is rated at approximately 20,000 hours. The actual life will depend on use conditions, the settings configured on the setup menu, and differences between each individual light source unit.
- The light source unit is warranted for the period noted on the warranty certificate or for 6,000 hours, whichever comes first.
- The failure of the light source unit to light or a noticeable drop in light source unit brightness indicates the end of the light source unit's life. Contact your original dealer or authorized CASIO service center for replacement. Note that problems caused by unauthorized projector disassembly or modification are not covered by the warranty and are not eligible for repair by CASIO.

Setup Precautions

- Use a conveniently located power outlet that you can reach easily when you need to unplug the projector.
- Allow at least 30cm (11.8 inches) between the projector and walls. Maintain a distance of at least 30 cm (11.8 inches) between surfaces and the other sides of the projector. There should be no other objects within the above distances from the projector. Particular care is required to keep objects away from projector air intake and exhaust openings.
- Airflow from air conditioning equipment can blow the heat being exhausted from the area around the projector's lens in a way that causes heat ripples to appear in the projected image. If this happens, adjust the airflow of the air conditioning equipment or move the projector.

Laser and High Temperature Precautions (See the label on the projector)

Laser Precautions

Non- U.S. Label ① : This projector is a Class 1 laser device that conforms to IEC 60825-1: 2014.

- This projector has a built-in laser module. Disassembly or modification is very dangerous and should never be attempted.
- Any operation or adjustment not specifically instructed by the user's guide creates the risk of hazardous laser radiation exposure.

U.S. Label ② : This projector is a Class 3R laser device that conforms to IEC 60825-1: 2007.

- This projector has a built-in laser module. Disassembly or modification is very dangerous and should never be attempted.
- Any operation or adjustment not specifically instructed by the user's guide creates the risk of hazardous laser radiation exposure.

Vent Outlet Precautions (Label ③)



- Vent outlets become very hot during projection. Never touch vents or allow them to become blocked.
- Do not insert foreign objects.

Left side of the projector (viewed from the back)

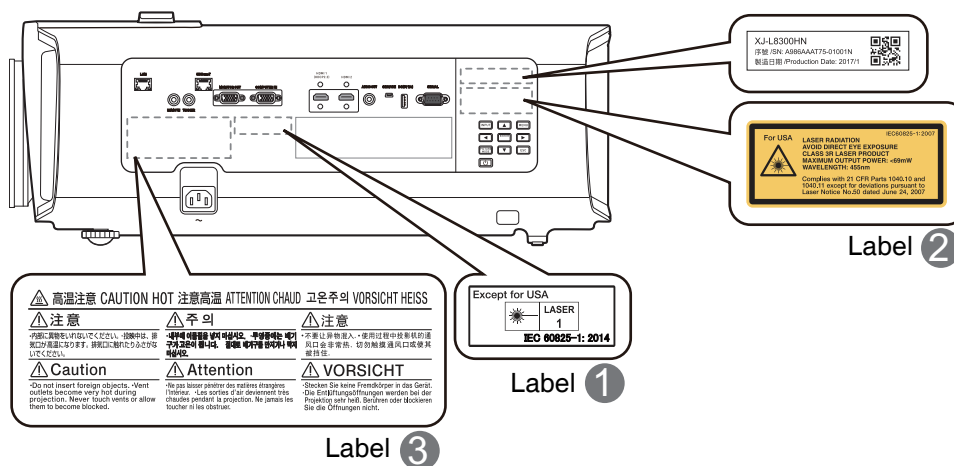

Other Precautions

This projector is made of precision components. Failure to observe the following precautions can result in inability to correctly save data and malfunction.

- Never use or store the projector in the following locations. Doing so creates the risk of malfunction of and damage to the projector.
 - Locations subjected to electrostatic charge
 - Locations subjected to temperature extremes
 - Locations where there is extreme moisture
 - Locations subjected to sudden temperature changes
 - Locations where there is a lot of dust
 - On a shaky, slanted, or otherwise unstable surface
 - Locations where there is the danger of getting wet
 - Locations where there are large amounts of oil smoke or other smoke
 - Locations where there is the risk of salt damage
 - Locations where corrosive gas (such as the sulfur gas at hot springs) is generated
- Ensure that the remote control signal receiver is not exposed fluorescent light, sunlight, or other strong light. Strong light can cause malfunction.
- Avoid using the projector under the following conditions. Such conditions create the risk of malfunction of and damage to the projector.
 - Avoid areas subject to temperature extremes (operating temperature range is 5°C to 35°C (41°F to 95°F)).
 - Never place heavy objects on the projector or climb on top of the projector.
 - Never insert or allow foreign objects to drop into the projector.
 - Never place a vase or any other container of water on top of the projector.
- Whenever setting the projector down or performing any operation that involves moving or reorienting it, take care that you do not pinch your fingers under the projector.
- Never leave dead batteries inside the remote controller for a long time.

Dead batteries can leak, which leads to malfunction of and damage to the remote controller. Be sure to replace the batteries at least once every one year, no matter how much you use the remote controller during that time.

- Clean with a soft, dry cloth.

When very dirty, use a soft cloth that has been dampened in a weak solution of water and a mild neutral detergent. Wring all excess water from the cloth before wiping. Never use thinner, benzine, or any other volatile agent to clean the projector. Doing so can remove its markings and cause staining of the case.

- Missing Screen Dots

Though this projector is manufactured using the most advanced digital technology available today, some of the dots on the screen may be missing. This is normal, and does not indicate malfunction.

- Never subject the projector to strong impact while it is projecting.

If the projector is accidentally subjected to strong impact, the projection image will momentarily go blank. The image will reappear after some time, but it may be the wrong color or it may be accompanied by an error message.

If the projected image is the wrong color, re-select the current input source. If this does not return the projected image to its proper color, turn projector power off and then back on again.

- Use a power outlet near the projector. Always use the projector so that the power cord can be easily unplugged.
- Even if your projector is still within the warranty period, you will be charged for repair if a problem is due to running the projector non-stop for very long periods (like 24 hours) or if the projector was set up and used without following the “Setup Precautions”.
- Use under high ambient temperature or in environments subjected to large amounts of dust, oil smoke, tobacco smoke, or other types of smoke can shorten the replacement cycles and require more frequent replacement of the optical engine and other components. Note that you are charged for such replacement. For details about replacement cycles and fees, contact an authorized CASIO service center.

- Condensation

Moving the projector from a cold room to a heated room, turning on a heater in a cold room, and other similar conditions can cause condensation (fogging) to form on the projector lens and/or inside the projector, which will make the projected image appear out of focus and can lead to malfunction and other trouble. If this happens, turn off the projector and wait for a while until the condensation clears naturally. When it does, you will be able to project images normally.

- Power Supply to External Equipment

Turning off projector power also cuts power being supplied to external equipment. Note that power being supplied is also cut when the projector is turned off due to restarting by its self-check function or Auto Power Off, due to some error, or for any other reason. Depending on the external equipment being used, cut off of the power supply may cause data that is being edited to be lost or corrupted. Make it a habit to frequently save data on external equipment being powered by the projector. Note that CASIO COMPUTER CO., LTD. shall be held in no way liable for any loss or corruption of data.

Introduction

Shipping contents

Carefully unpack and verify that you have all of the items shown below. If any of these items are missing, please contact your place of purchase.

Standard accessories

- Projector
- Remote control, YT-310
- Cable tie set x 2
- Test batteries (AA-size x 2)
- AC Power cord
- RGB cable
- "Safety Precautions" sheet
- "Read this first" sheet
- Warranty*



- The supplied accessories will be suitable for your region.
- *The warranty card is only supplied in some specific regions. Please consult your dealer for detailed information.

Replacing the remote control batteries

1. Press on the finger grip on the cover and push it up in the direction of the arrow as illustrated.
2. Remove the old batteries (if applicable) and install two AA batteries. Make sure that the positive and negative ends are positioned correctly, as illustrated.
3. Refit the cover by aligning it with the base and pushing it back down into position. Stop when it clicks into place.

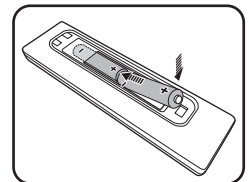
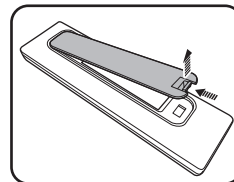

- Avoid leaving the remote control and batteries in an excessive heat or humid environment like the kitchen, bathroom, sauna, sunroom or in a closed car.
- Replace only with the same or equivalent type recommended by the battery manufacturer.
- Dispose of the used batteries according to the manufacturer's instructions and local environment regulations for your region.
- Never throw the batteries into a fire. There may be danger of an explosion.
- If the batteries are dead or if you will not be using the remote control for an extended period of time, remove the batteries to avoid damage to the remote control from possible battery leakage.

Projector exterior view

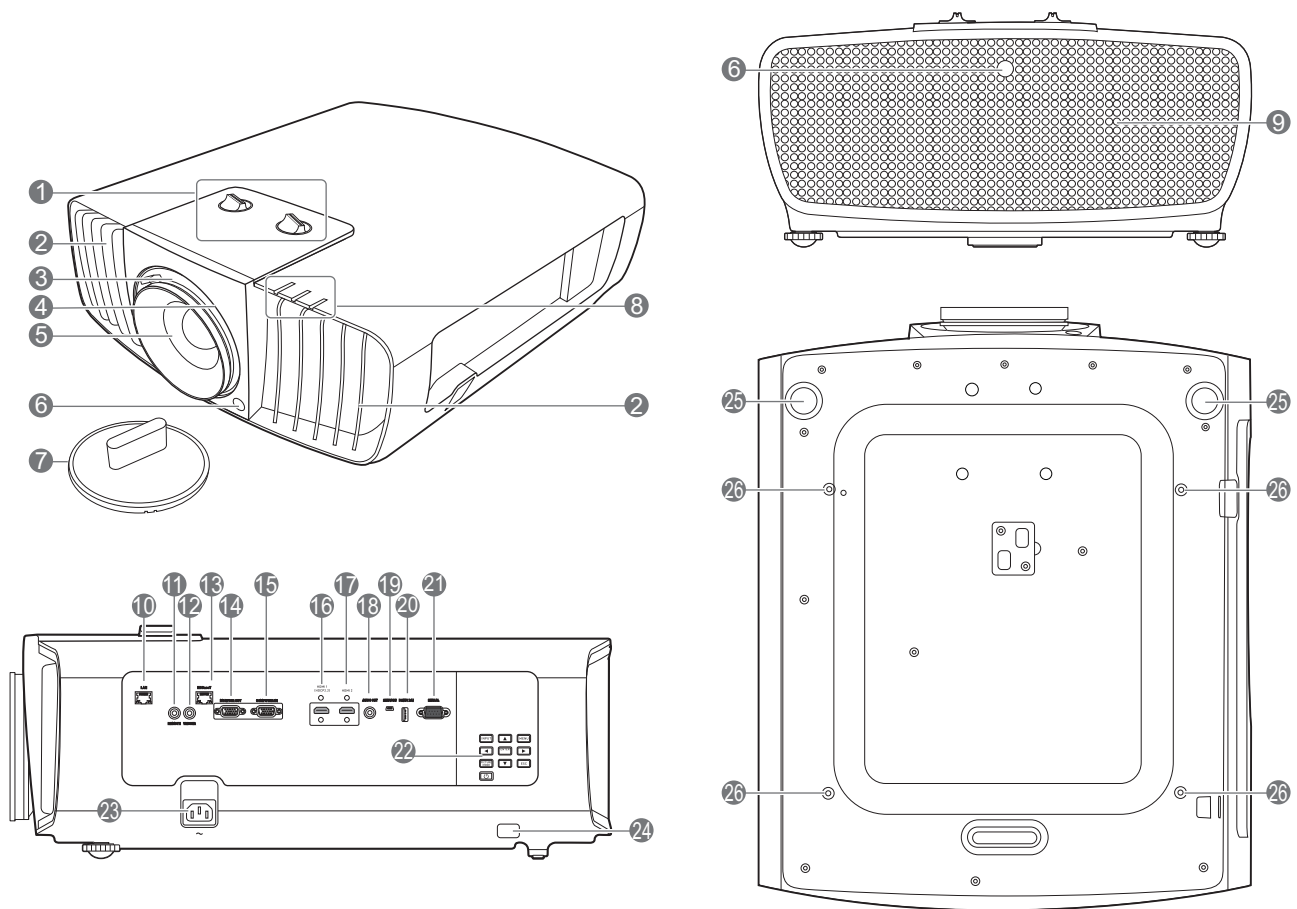

- | | |
|---|--|
| <ol style="list-style-type: none"> 1. Lens shift adjustment knobs (LEFT/RIGHT, UP/DOWN) 2. Vent (heated air exhaust) 3. Focus ring 4. Zoom ring 5. Projection lens 6. IR remote sensor 7. Lens cover 8. POWER indicator light/TEMPerature warning light/LIGHT indicator light (See "Indicators" on page 48.) 9. Vent (cool air intake) 10. RJ-45 LAN input jack 11. Remote control jack
For use with a wired remote control. 12. 12 VDC output terminal
Trigger external devices such as an electric screen or light control, etc. | <ol style="list-style-type: none"> 13. HDBaseT input port 14. RGB (PC) signal output jack 15. RGB (PC)/Component Video (YPbPr / YCbCr) signal input jack 16. HDMI 1 input port (HDCP 2.2) 17. HDMI 2 input port 18. Audio output jack 19. Service port 20. DC (5V 2A) output port 21. Serial port 22. External control panel (See "Controls and functions" on page 16.) 23. AC power jack 24. Security bar 25. Adjuster feet 26. Ceiling mount holes |
|---|--|

Controls and functions

Projector & Remote control



All the key presses described in this document are available on the remote control or projector.

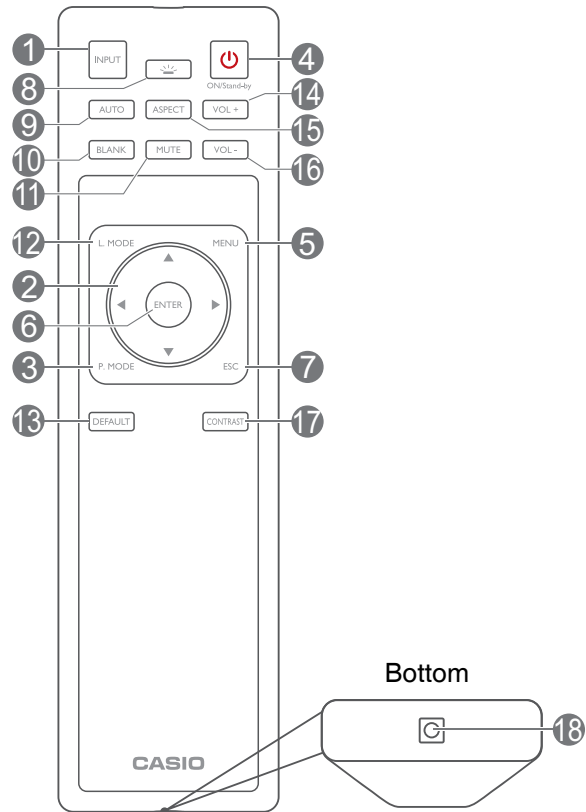
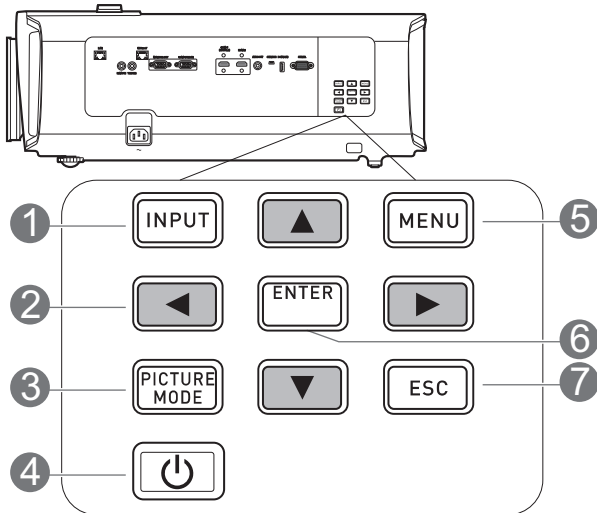

1. INPUT

Displays the input selection bar.

2. Arrow keys (▲, ▼, ◀, ▶)

When the On-Screen Display (OSD) menu is activated, these keys are used as directional arrows to select the desired menu items and to make adjustments.

3. PICTURE MODE

Selects an available picture setup mode.

4. ON/Stand-by

Toggles the projector between standby mode and on.

5. MENU

Turns on the On-Screen Display (OSD) menu.

6. ENTER

Confirms the selected On-Screen Display (OSD) menu item.

7. ESC

Goes back to previous OSD menu, exits and saves menu settings.

8. KEY LIGHT

Turns on the remote control back light for a few seconds. To keep the back light on, press any other key while the back light is on. Press the key again to turn the back light off.

9. AUTO

Automatically determines the best picture timings for the displayed image.

10. BLANK

Used to hide the screen picture.



Do not block the projection lens from projecting as this could cause the blocking object to become heated and deformed or even cause a fire.

11. MUTE

Toggles the projector audio between on and off.

12. L. MODE

Selects a suitable light source power from among the provided modes.

13. DEFAULT

Resets the current function to default factory setting.

14. VOL+

Increases the projector volume.

15. ASPECT

Selects the display aspect ratio.

16. VOL-

Lowers the projector volume.

17. CONTRAST

Displays the contrast setting bar for adjustment.

18. Port for wired remote control

Connects a cable to the projector for remote control operation.

Remote control effective range

The remote control must be held at an angle within 30 degrees perpendicular to the projector's IR remote control sensor(s) to function correctly. The distance between the remote control and the sensor(s) should not exceed 8 meters (~ 26 feet).

Make sure that there are no obstacles between the remote control and the IR sensor(s) on the projector that might obstruct the infra-red beam.

• Operating the projector from the front

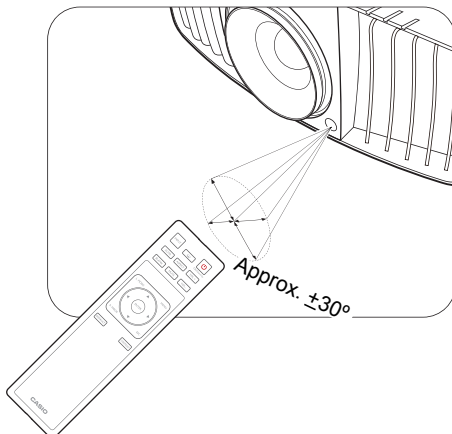

• Operating the projector from the rear

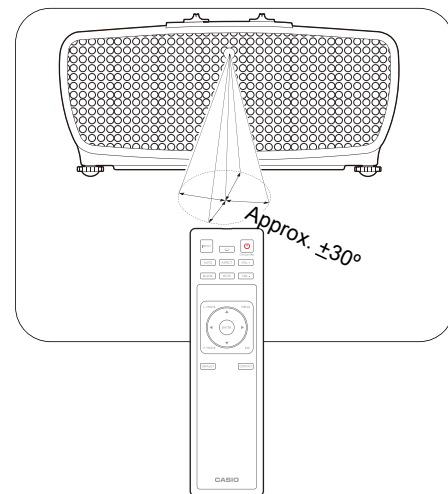

Positioning your projector

Choosing a location

Before choosing an installation location for your projector, take the following factors into consideration:

- Size and position of your screen
- Electrical outlet location
- Location and distance between the projector and the rest of your equipment

You can install your projector in the following ways.

1. Front

Select this location with the projector placed on the table in front of the screen. This is the most common way to position the projector for quick setup and portability.

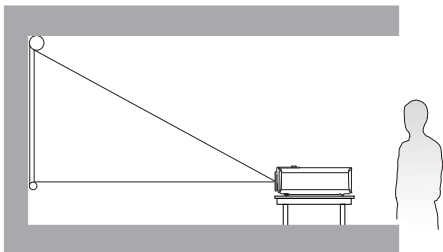

2. Front Ceiling

Select this location with the projector suspended upside-down from the ceiling in front of the screen. Purchase a projector ceiling mount kit from your dealer to mount your projector on the ceiling.

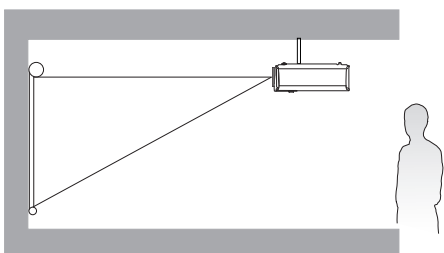

3. Rear Ceiling

Select this location with the projector suspended upside-down from the ceiling behind the screen. Note that a special rear projection screen and a projector ceiling mount kit are required for this installation location.

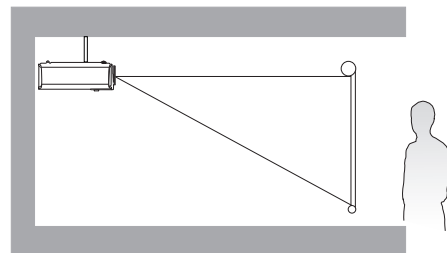

4. Rear

Select this location with the projector placed on the table behind the screen. Note that a special rear projection screen is required.

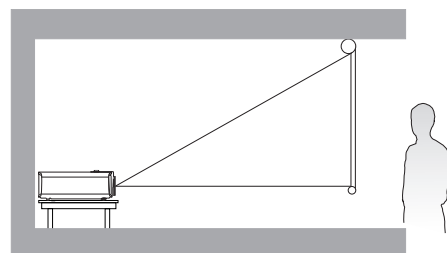

After turning on the projector, go to **INSTALLATION > Projector Mode** and press ◀▶ to select a setting.

Obtaining a preferred projected image size

The distance from the projector lens to the screen, the zoom setting, and the video format each factors in the projected image size. To shift the lens, turn the knobs on the projector to shift the

projection lens in any direction within the allowable range depending on your desired image position

Front projection

- When adjusting the projection position vertically in lens shift
- When adjusting the projection position horizontally in lens shift

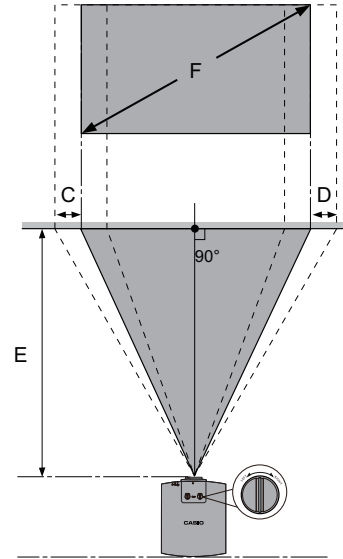
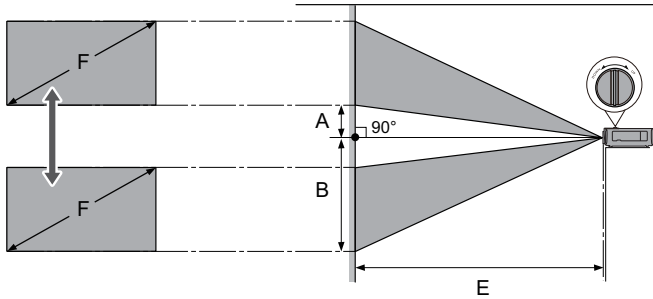

- A: Distance from the center of the lens to the bottom edge of the projected image (when lens shift is raised to its highest level)
- B: Distance from the center of the lens to the bottom edge of the projected image (when lens shift is lowered to its lowest level)
- C: Lens center movement distance (when lens shift is set to maximum left)
- D: Lens center movement distance (when lens shift is set to maximum right)
- E: Projection distance from the projector to the screen
- F: Size of the projected image

- The screen aspect ratio is 16:9 and the projected picture is in a 16:9 aspect ratio

Screen size		Size of the projected image (F)				Projection distance (E)				Offset (A)		Offset (B)		Offset (C, D)	
Diagonal		Height		Width		Shortest (Wide)		Longest (Tele)							
Inch	cm	Inch	cm	Inch	cm	Inch	cm	Inch	cm	Inch	cm	Inch	cm	Inch	cm
95	241	47	118	83	210	114	289	167	425	4.7	12	51.2	130	20.7	53
100	254	49	125	87	221	120	305	176	448	4.9	12	53.9	137	21.8	55
120	305	59	149	105	266	144	366	212	537	5.9	15	64.7	164	26.1	66
150	381	74	187	131	332	180	457	264	672	7.4	19	80.9	205	32.7	83
180	457	88	224	157	398	216	548	317	806	8.8	22	97.1	247	39.2	100
200	508	98	249	174	443	240	609	353	896	9.8	25	107.9	274	43.6	111



All measurements are approximate and may vary from the actual sizes.

We recommend that if you intend to permanently install the projector, you should physically test the projection size and distance using the actual projector in situ before you permanently install it, so as to make allowance for this projector's optical characteristics. This will help you determine the exact mounting position so that it best suits your installation location.

The projection range for lens shift

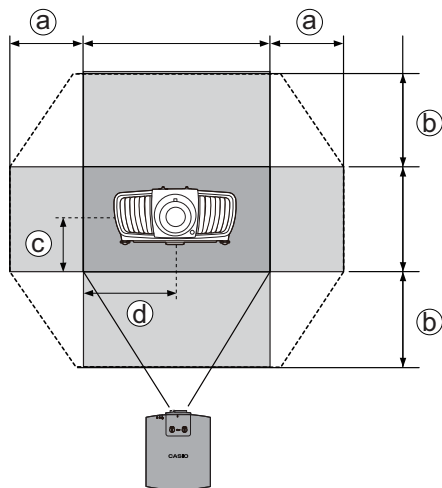

a: Maximum horizontal range ($H \times 25\%$)

b: Maximum vertical range ($V \times 60\%$)

c: 1/2 the vertical height of the image

d: 1/2 the horizontal width of the image



Be sure to stop turning the adjustment knob when you hear a clicking sound indicating that the knob has reached its limit. Over-turning the knob may cause damage.



You cannot move the image to both the horizontal and vertical maximum values.

Mounting the projector

If you intend to mount your projector, we strongly recommend that you use a projector ceiling mount kit and that you ensure it is securely and safely installed.

Before mounting the projector

- Ask your dealer to install the projector for you. Installing the projector on your own may cause it to fall and result in injury.
- Take necessary procedures to prevent the projector from falling off such as during an earthquake.
- The warranty on this projector does not cover any damage caused by installation of the ceiling mount kit in an improper location.
- Consider the surrounding temperature where the projector is ceiling mounted. If a heater is used, the temperature around the ceiling may be higher than expected.
- Read the user's guide for the mounting kit about the range of torque. Tightening with torque exceeding the recommended range may cause damage to the projector and subsequently falling off.
- Make sure the power outlet is at an accessible height so that you can easily shut down the projector.

Adjusting the projected image

Adjusting the projection angle

If the projector is not placed on a flat surface or the screen and the projector are not perpendicular to each other, the projected image becomes trapezoidal. You can screw the adjuster feet to fine-tune the horizontal angle.

To retract the feet, screw the adjuster feet in a reverse direction.

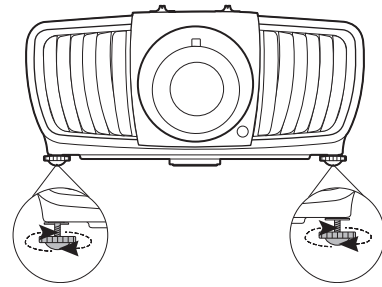

- Do not look into the lens while the light source is on. The strong light from the light source may cause damage to your eyes.
- If you keep on screwing the adjuster feet clockwise, they will come off. This is not a malfunction. When it happens, turn the adjuster feet counterclockwise to put them back on.

Auto-adjusting the image

In some cases, you may need to optimize the picture quality. To do this, press **AUTO**. Within 3 seconds, the built-in Intelligent Auto Adjustment function will re-adjust the values of Frequency and Clock to provide the best picture quality.

The current source information will be displayed in the corner of the screen for 3 seconds.



This function is only available when PC signal (analog RGB) is selected.

Fine-tuning the image size and clarity

1. Adjust the projected image to the size that you need using the zoom ring.
2. Sharpen the image by rotating the focus ring.

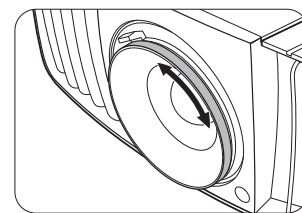
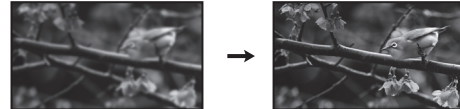
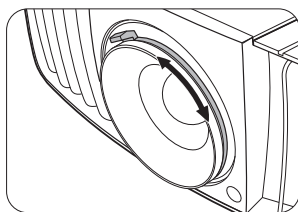

Connection

When connecting a signal source to the projector, be sure to:

1. Turn all equipment off before making any connections.
2. Use the correct signal cables for each source.
3. Ensure the cables are firmly inserted.

1	RJ-45 cable
2	Wired remote control
3	Powered screen, etc.
4	HDBaseT transmitter
5	VGA cable
6	HDMI cable
7	Audio cable
8	RS-232C cable

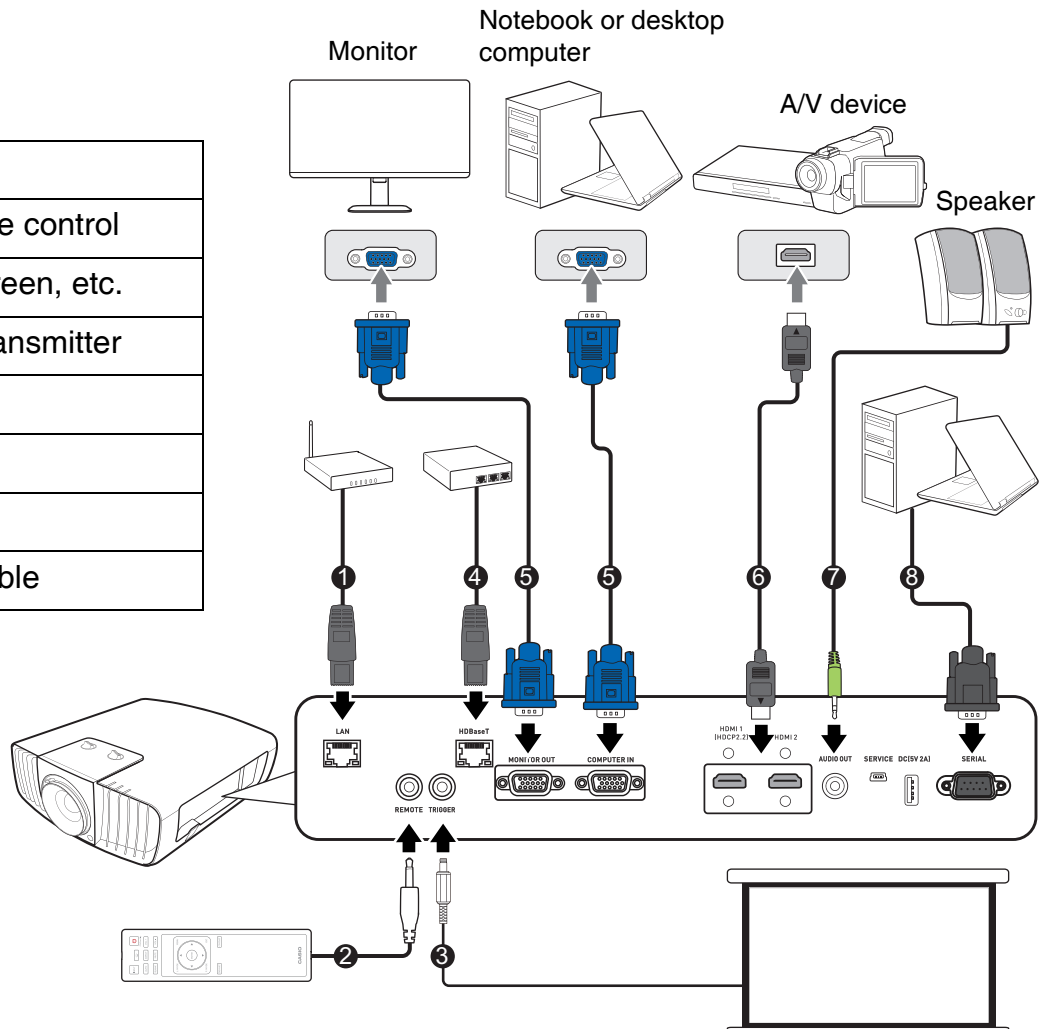

- In the connections above, some cables may not be included with the projector (see ["Shipping contents" on page 14](#)). They are commercially available from electronics stores.
- The connection illustrations are for reference only. The rear connecting jacks available on the projector vary with each projector model.
- Many notebooks do not turn on their external video ports when connected to a projector. Usually a key combo like FN + function key with a monitor symbol turns the external display on/off. Press FN and the labeled function key simultaneously. Refer to your notebook's documentation to find your notebook's key combination.
- If the selected video image is not displayed after the projector is turned on and the correct video source has been selected, check that the video source device is turned on and operating correctly. Also check that the signal cables have been connected correctly.
- LAN port provides Ethernet functions.
- Be sure to use a High Speed HDMI Cable for HDMI connection.
- Use a Premium High Speed cable to project 4K content through the HDMI 1 port.
- Be sure to use a shielded RS-232C cable for RS-232C connection.

Using the cable tie set

The cable tie set helps prevent a cable plug from falling out of the connecting port. It contains the following parts.

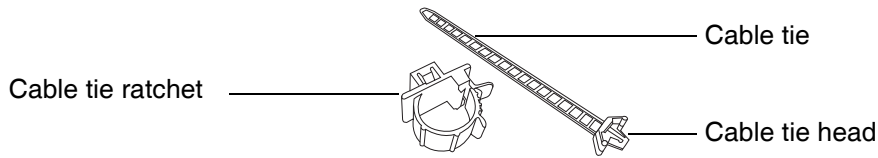

To use the cable tie set:

1. Firmly plug a cable to a correct port on the projector. Insert the cable tie head to the cable tie hole right above the connecting port. Note that the cable tie cannot be removed from the hole once it is inserted.

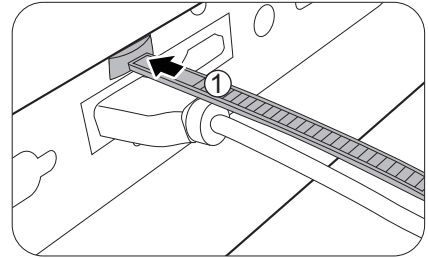

2. Take the cable tie ratchet. Slightly open the ratchet to surround the connecting cable.

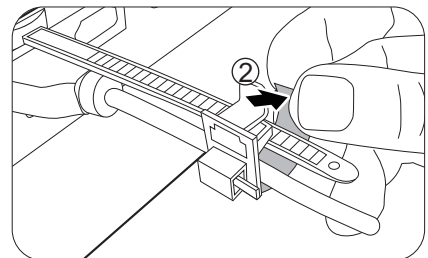

3. Insert the end of the cable tie to the cable tie ratchet as illustrated.
4. Close the cable tie ratchet by pressing its tab.

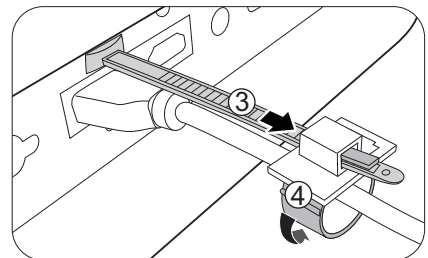

5. Move the cable tie ratchet along with the cable tie to the end of the cable plug.

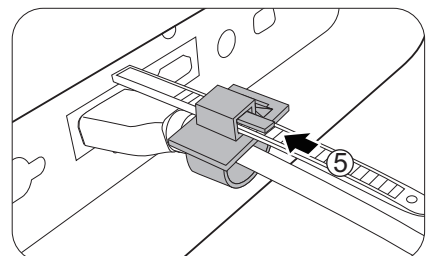

Connecting multiple sources through HDBaseT

HDBaseT of this model combine HD digital video, audio, and a control signal. With the use of HDBaseT transmitter (commercially available), you may connect multiple sources to your projector with HDBaseT connection.



The illustration below is for reference only, actual layout may vary.

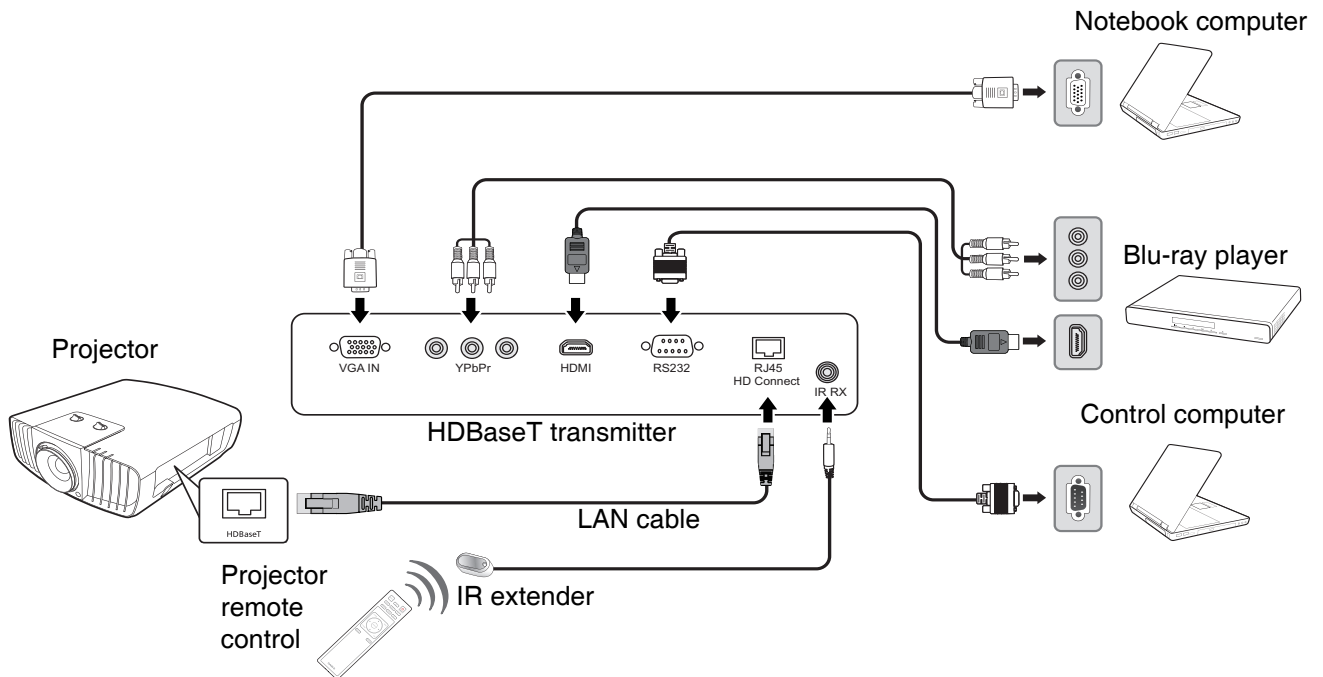

- Use the following types of LAN cables:
 - a shielded LAN cable rated at CAT5e or better
 - Twisted pair LAN cable
 - Single wire
 - Straight cable
- Maximum transmission distance is 100 m.
- However, maximum transmission distance may be shorter in some environments.
- Do not use the LAN cable when it is coiled or bundled.
- Inserting or removing the LAN cable during projection may cause noise.
- Connectivity with all HDBaseT transmitters on the market is not guaranteed.
- Some HDBaseT transmitters may not enable correct projection when used to connect source equipment to the projector.
- Commands cannot be received through HDBaseT when the projector is in standby mode.





Operation

Starting up the projector

1. Plug the power cord. Turn on the power outlet switch (where fitted). The power indicator on the projector lights red after power has been applied.
2. Press  on the projector or remote control to start the projector. The power indicator flashes green and stays green when the projector is on.

(If necessary) Rotate the focus ring to adjust the image clearness.

3. If this is the first time you turn on the projector, the setup wizard appears to guide you through setting up the projector. If you have already done this, skip this step and move on to the next step.

- Use the arrow keys (, , , ) on the projector or remote control to move through the menu items.
- Use **ENTER** to confirm the selected menu item.

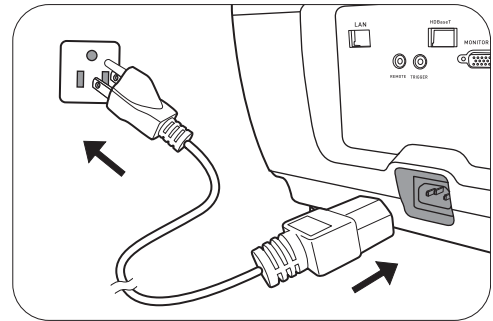

Step 1:

Specify **Projector Position**.

For more information about projector position, see [Choosing a location](#).

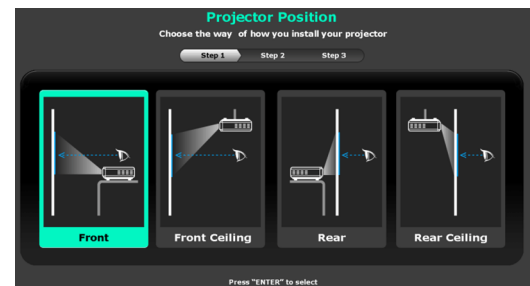

Step 2:

Specify OSD **Language**.

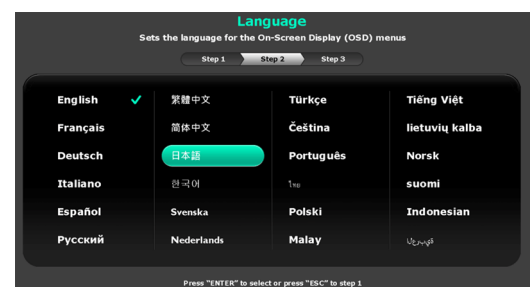

Step 3:

Specify **Auto Source**.

Select **On** if you want the projector to always search for available signals automatically when the projector is turned on.

Now you've completed the initial setup.

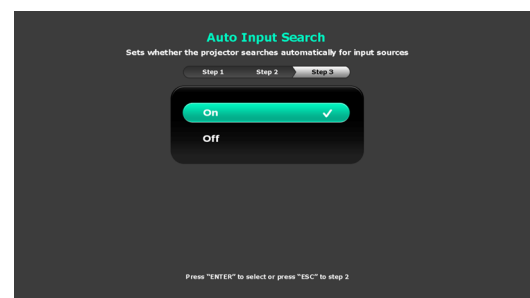

4. If you are prompted for a password, press the arrow keys to enter a 6-digit password. See ["Utilizing the password function" on page 27](#).

5. Switch all of the connected equipment on.
6. The projector will search for input signals. The current input signal being scanned appears. If the projector does not detect a valid signal, the message "No Signal" will continue displaying until an input signal is found.

You can also press **INPUT** to select your desired input signal. See "[Switching input signal](#)" on page 28.



- Please use the original accessories (e.g. power cord) to avoid possible dangers such as electric shock and fire.
- The Setup Wizard screenshots are for reference only and may differ from the actual design.
- If the frequency/resolution of the input signal exceeds the projector's operating range, you will see the message "Out of Range" displayed on the background screen. Please change to an input signal which is compatible with the projector's resolution or set the input signal to a lower setting. See "[Timing chart](#)" on page 52.
- If no signal is detected for 3 minutes, the projector automatically enters saving mode.

Using the menus

The projector is equipped with On-Screen Display (OSD) menus for making various adjustments and settings.



The OSD screenshots below are for reference only, and may differ from the actual design.

Below is the overview of the OSD menu.

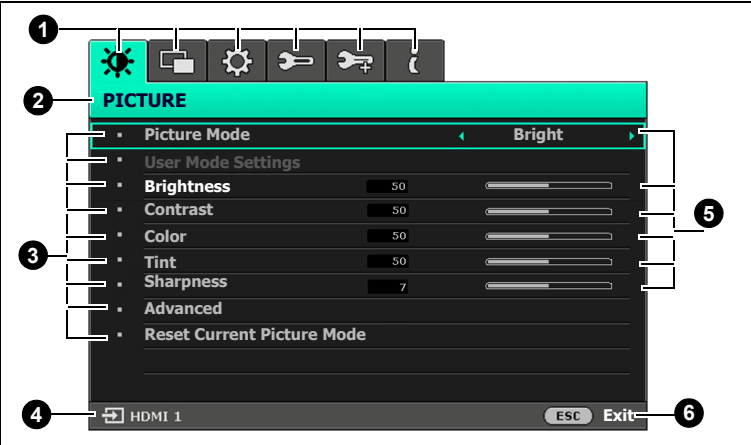
	<p>1 Main menu icon</p>	<p>4 Current input signal</p>
	<p>2 Main menu</p>	<p>5 Status</p>
	<p>3 Sub-menu</p>	<p>6 Button operation guidance.</p>

To access the OSD menu, press **MENU** on the projector or remote control.

- Use the arrow keys (**▲/▼/◀/▶**) on the projector or remote control to move through the menu items.
- Use **ENTER** on the projector or remote control to confirm the selected menu item.

Securing the projector

Using a security cable lock

The projector has to be installed in a safe place to prevent theft. Otherwise, purchase a lock to secure the projector. You can locate a security bar on the projector. See item 24 on [page 15](#).

A Kensington security cable lock is usually a combination of key(s) and the lock. Refer to the lock's documentation for finding out how to use it.

Utilizing the password function

Setting a password

1. Go to **SYSTEM SETUP: ADVANCED > Password**. Press **ENTER**. The **Password** page appears.
2. Highlight **Change Password** and press **ENTER**.
3. The four arrow keys (**▲**, **▼**, **◀**, **▶**) respectively represent 4 digits (1, 2, 3, 4). According to the password you desire to set, press the arrow keys to enter six digits for the password.
4. Confirm the new password by re-entering the new password.
Once the password is set, the OSD menu returns to the **Password** page.
5. To activate the **Power On Lock** function, press **▲/▼** to highlight **Power On Lock** and press **◀/▶** to select **On**. Input the password again.

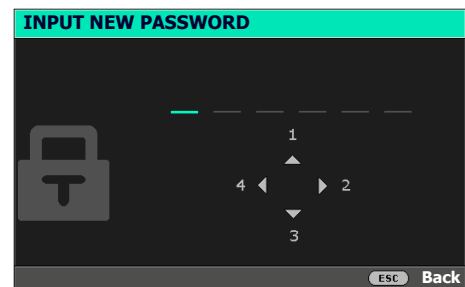

- The digits being input will display as asterisks on-screen. Make a note of your selected password and keep it in a safe place in advance or right after the password is entered so that it is available to you should you ever forget it.
- Once a password has been set and the power on lock is activated, the projector cannot be used unless the correct password is entered every time the projector is started.

If you forget the password

If you enter the wrong password, the password error message will appear, and the **Input Current Password** message follows. If you absolutely do not remember the password, you can use the password recall procedure. See "[Entering the password recall procedure](#)" on [page 28](#).

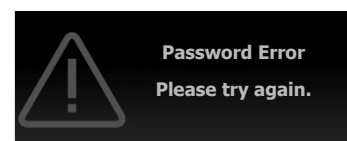

If you enter an incorrect password 5 times in succession, the projector will automatically shut down in a short time.

Entering the password recall procedure

1. Press and hold **ENTER** for 3 seconds. The projector will display a coded number on the screen.
2. Write down the number and turn off your projector.
3. Seek help from the local CASIO service center to decode the number. You may be required to provide proof of purchase documentation to verify that you are an authorized user of the projector.

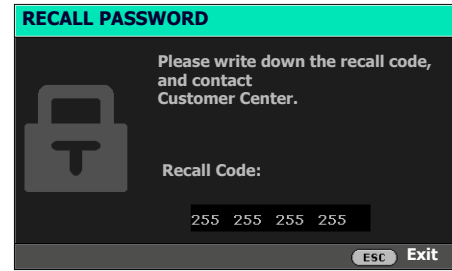

Changing the password

1. Go to **SYSTEM SETUP: ADVANCED > Password > Change Password**.
2. Press **ENTER**. The message “**Input Current Password**” appears.
3. Enter the old password.
 - If the password is correct, another message “**Input New Password**” appears.
 - If the password is incorrect, the password error message will appear, and the message “**Input Current Password**” appears for your retry. You can press **ESC** to cancel the change or try another password.
4. Enter a new password.
5. Confirm the new password by re-entering the new password.

Disabling the password function

To disable password protection, go to **SYSTEM SETUP: ADVANCED > Password > Power On Lock** and press **◀/▶** to select **Off**. The message “**Input Current Password**” appears. Enter the current password.

- If the password is correct, the OSD menu returns to the **Password** page. You will not have to enter the password next time turning on the projector.
- If the password is incorrect, the password error message will appear, and the message “**Input Current Password**” appears for your retry. You can press **ESC** to cancel the change or try another password.



Though the password function is disabled, you need to keep the old password in hand should you ever need to re-activate the password function by entering the old password.

Switching input signal

The projector can be connected to multiple devices at the same time. However, it can only display one full screen at a time. When starting up, the projector automatically searches for the available signals.

Be sure the **SYSTEM SETUP: BASIC > Auto Input Search** menu is **On** if you want the projector to automatically search for the signals.

To select the source:

1. Press **INPUT**. A source selection bar appears.
2. Press **▲/▼** until your desired signal is selected and press **ENTER**.

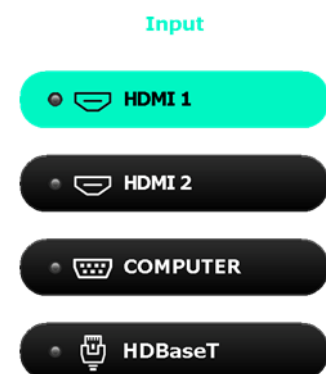



Once detected, the selected source information will appear at the corner of the screen for seconds. If there is multiple equipment connected to the projector, repeat steps 1-2 to search for another signal.



- The brightness level of the projected image will change accordingly when you switch between different input signals.
- For best display picture results, you should select and use an input signal which outputs at the projector's native resolution. Any other resolutions will be scaled by the projector depending upon the "aspect ratio" setting, which may cause some image distortion or loss of picture clarity. See "[Aspect Ratio](#)" on page 33.

Shutting down the projector

1. Press  and a confirmation message will appear prompting you. If you don't respond in a few seconds, the message will disappear.
2. Press  a second time.
3. The power indicator becomes a steady red and fans stop. Disconnect the power cord from the power outlet.

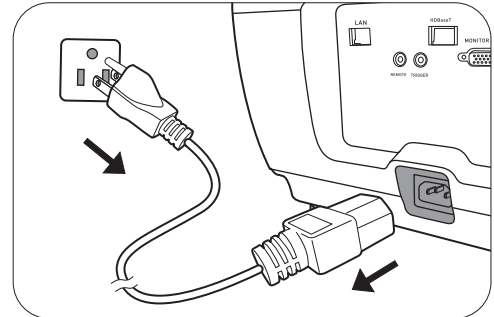

The indicator lights may stay lit even after you unplug the power cord. However, this is not a malfunction.

Menu operation

Please note that the on-screen display (OSD) menus vary according to the signal type selected and the projector model you are using.

The menu items are available when the projector detects at least one valid signal. If there is no equipment connected to the projector or no signal detected, limited menu items are accessible.

PICTURE menu

Picture Mode	<p>The projector is preset with several predefined picture modes so that you can choose one to suit your operating environment and input signal picture type.</p> <ul style="list-style-type: none">• Bright: Maximizes the brightness of the projected image. This mode is suitable for environments where extra-high brightness is required, such as using the projector in well lit rooms.• Vivid: Being slightly brighter than Natural mode, it is suitable for presentation in rooms where you need more brightness.• Natural: With well-balanced color saturation and contrast with a low brightness level, this is most suitable for presentation.• User 1/User 2: Recalls the settings customized based on the current available picture modes. See "User Mode Settings" on page 30.
User Mode Settings	<p>There are 2 user-definable modes if the current available picture modes are not suitable for your need. You can use one of the picture modes (except the User 1/User 2) as a starting point and customize the settings.</p> <ul style="list-style-type: none">• Load Settings<ol style="list-style-type: none">1. Go to PICTURE > Picture Mode.2. Press ◀/▶ to select User 1 or User 2.3. Press ▼ to highlight User Mode Settings, and press ENTER. The User Mode Settings page is displayed.4. Select Load Settings and press ENTER.5. Press ▲/▼ to select a picture mode that is closest to your need.6. Press ENTER and ESC to return to the PICTURE menu.7. Press ▼ to select the sub-menu items you want to change and adjust the values with ◀/▶. The adjustments define the selected user mode.

<p>User Mode Settings (Continued)</p>	<p>• Rename User Mode</p> <p>Select to rename the customized picture modes (User 1 or User 2). The new name can be up to 9 characters including English letters (A-Z, a-z), digits (0-9), and space (_).</p> <ol style="list-style-type: none"> 1. Go to PICTURE > Picture Mode. 2. Press ◀/▶ to select User 1 or User 2. 3. Press ▼ to highlight User Mode Settings, and press ENTER. The User Mode Settings page is displayed. 4. Press ▼ to highlight Rename User Mode and press ENTER. The Rename User Mode page is displayed. 5. Use ▲/▼/◀/▶ to select desired characters. 6. When done, press ENTER or ESC to exit.
<p>Brightness</p>	<p>The higher the value, the brighter the image. Adjust this control so the black areas of the image appear just as black and that detail in the dark areas is visible.</p>
<p>Contrast</p>	<p>The higher the value, the greater the contrast. Use this to set the peak white level after you have previously adjusted the Brightness setting to suit your selected input and viewing environment.</p>
<p>Color</p>	<p>Lower setting produces less saturated colors. If the setting is too high, colors on the image will be overpowering, which makes the image unrealistic.</p>
<p>Tint</p>	<p>The higher the value, the more greenish the picture becomes. The lower the value, the more reddish the picture becomes.</p>
<p>Sharpness</p>	<p>The higher the value, the sharper the picture becomes.</p>
<p>Advanced</p>	<p>• Select Gamma</p> <p>Gamma refers to the relationship between input source and picture brightness.</p> <ul style="list-style-type: none"> • 1.6/1.8/2.0/2.1: Select these values according to your preference. • 2.2/2.3: Increases the average brightness of the picture. Best for a lit environment, meeting room or family room. • 2.4/2.5: Best for viewing movies in a dark environment. • 2.6/2.8: Best for viewing movies which are mostly composed of dark scenes. <p>High Brightness Low Contrast</p> <p>Low Brightness High Contrast</p>  <p>1.6 1.8 2.0 2.1 2.2 2.3 2.4 2.5 2.6 2.8</p>

• Color Temperature

There are several preset color temperature settings available. The available settings may vary according to the signal type selected.

- **Normal:** Maintains normal colorings for white.
- **Cool:** Makes images appear bluish white.
- **Warm:** Makes images appear reddish white.

You can also set a preferred color temperature by adjusting the following options.

- **Red Gain/Green Gain/Blue Gain:** Adjusts the contrast levels of Red, Green, and Blue.
- **Red Offset/Green Offset/Blue Offset:** Adjusts the brightness levels of Red, Green, and Blue.

• 3D Color Management

The Color Management provides six sets (RGBCMY) of colors to be adjusted. When you select each color, you can independently adjust its range and saturation according to your preference.

- **Primary Color:** Selects a color from among Red, Yellow, Green, Cyan, Blue, or Magenta.
- **Hue:** Increase in the range will include colors consisted of more proportions of its two adjacent colors. Please refer to the illustration for how the colors relate to each other.

For example, if you select Red and set its range at 0, only pure red in the projected picture will be selected. Increasing its range will include red close to yellow and red close to magenta.

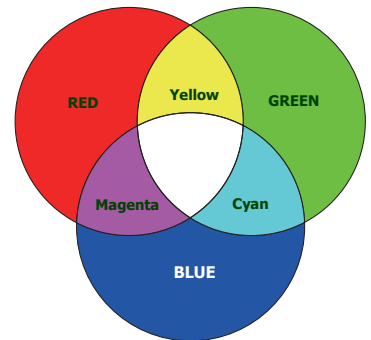



- **Gain:** Adjusts the values to your preference. The contrast level of the primary color you select will be affected. Every adjustment made will reflect to the image immediately.
- **Saturation:** Adjusts the values to your preference. Every adjustment made will reflect to the image immediately. For example, if you select Red and set its value at 0, only the saturation of pure red will be affected.





Saturation is the amount of that color in a video picture. Lower settings produce less saturated colors; a setting of “0” removes that color from the image entirely. If the saturation is too high, that color will be overpowering and unrealistic.

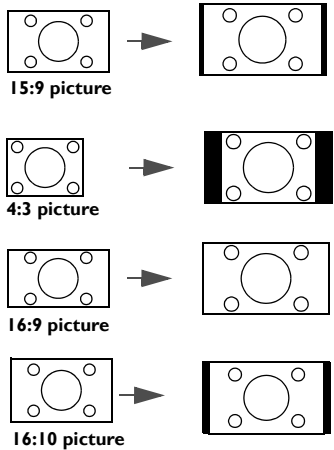

<p>Advanced (Continued)</p>	<ul style="list-style-type: none"> • MoviePro <ul style="list-style-type: none"> • Color Enhancement: Allows you to fine-tune the saturation of colors with larger flexibility. It modulates complex color algorithms to flawlessly render saturated colors, fine gradients, intermediate hues and subtle pigments. • Skin Tone: Provides a smart adjustment of hue only for calibrating people's skin color, not other colors in the image. It prevents discoloration of skin tones from the light of the projection beam, portraying every skin tone in its most beautiful shade. • Super Resolution: It is a super-resolution technology which radically enhances Full HD content in terms of colors, contrast, and textures. It's also a detail enhancement technology refines surface details for true-to-life images that pop off the screen. Users can adjust levels of sharpness and detail enhancement for optimal viewing.
<p>Reset Current Picture Mode</p>	<p>Returns all of the adjustments you've made for the selected Picture Mode (including preset modes, User 1, and User 2) to the factory preset values.</p> <ol style="list-style-type: none"> 1. Press ENTER. The confirmation message is displayed. 2. Use ◀/▶ to select Reset and press ENTER. The current picture mode returns to the factory preset settings.

DISPLAY menu

<p>Aspect Ratio</p>	<p>There are several options to set the image's aspect ratio depending on your input signal source.</p> <ul style="list-style-type: none"> • Auto: Scales an image proportionally to fit the projector's native resolution in its horizontal or vertical width. • 4:3: Scales an image so that it is displayed in the center of the screen with a 4:3 aspect ratio. • 16:9: Scales an image so that it is displayed in the center of the screen with a 16:9 aspect ratio. • 16:10: Scales an image so that it is displayed in the center of the screen with a 16:10 aspect ratio.  <p> Note that enlarging or reducing the size of an image using the ASPECT key for commercial purposes or public presentation may infringe on the legally protected copyright of the copyright holder of the original material.</p>
<p>Image Position</p>	<p>Displays the position adjustment page. To move the projected image, use the directional arrow keys. This function is only available when a PC signal (analog RGB) is selected.</p>
<p>Overscan Adjustment</p>	<p>Conceals the poor picture quality in the four edges.</p> <p>The greater the value, the more portion of the picture is concealed while the screen remains filled and geometrically accurate. Setting 0 means the picture is 100% displayed.</p>

<p>Phase</p>	<p>Adjusts the clock phase to reduce image distortion.</p>  <p>This function is only available when a PC signal (analog RGB) is selected.</p>	
<p>H. Size</p>	<p>Adjusts the horizontal width of the image.</p>  <p>This function is only available when a PC signal (analog RGB) is selected.</p>	

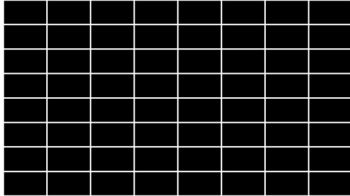
INSTALLATION menu



<p>Projector Mode</p>	<p>The projector can be installed on a ceiling or behind a screen. See "Choosing a location" on page 18.</p>	
<p>Test Pattern</p>	<p>Is used to adjust the image size and focus and check that the projected image is free from distortion. To close the test pattern, press MENU and select Off.</p>	
<p>Light Source Settings</p>	<ul style="list-style-type: none"> • Light Source Mode: Selects a suitable light source power from among the provided modes. See "Saving power" on page 47. • Light Source Information: See "Getting to know the light source hour" on page 47. 	
<p>12V Trigger</p>	<p>There is one 12V trigger that works according to your needs for installation scenarios. Two selections are available:</p> <ul style="list-style-type: none"> • Off: If this is selected, the projector will not send electronic signal out when it is turned on. • On: The projector will send a low to high electronic signal out when it is turned on, a high to low signal out when it is turned off. 	
<p>High Altitude Mode</p>	<p>We recommend you use the High Altitude Mode when your environment is between 1500 m –3000 m above sea level, and ambient temperature is between 5°C–30°C.</p> <p>Operation under "High Altitude Mode" may cause a higher decibel operating noise level because of increased fan speed necessary to improve overall system cooling and performance.</p> <p>If you use this projector under other extreme conditions excluding the above, it may display auto shut-down symptoms, which is designed to protect your projector from over-heating. In cases like this, you should switch to High Altitude mode to solve these symptoms. However, this is not to state that this projector can operate under any and all harsh or extreme conditions.</p>  <p>Do not use the High Altitude Mode if your altitude is between 0 m and 1500 m and ambient temperature is between 5°C and 35°C. The projector will be over cooled, if you turn the mode on under such a condition.</p>	

SYSTEM SETUP: BASIC menu

Language	Sets the language for the On-Screen Display (OSD) menus.
Background Color	Sets the background color for the projector.
Splash Screen	Allows you to select which screen will be displayed during projector start-up.
Auto Power Off	Allows the projector to turn off automatically if no input signal is detected after a set period of time to prevent unnecessary waste of light source power.
Direct Power On	Allows the projector to turn on automatically once the power is fed through the power cord.
Menu Settings	<ul style="list-style-type: none"> • Menu Position: Sets the On-Screen Display (OSD) menu position. • Menu Display Time: Sets the length of time the OSD will remain active after your last key press. • Reminder Message: Sets the reminder messages on or off.
Rename Input	<p>Renames the current input source to your desired name.</p> <p>On the Rename Input page, use ▲/▼/◀/▶ and ENTER to set the desired characters for the connected source item.</p> <p>When done, press ESC to exit and save the changes.</p>
Auto Input Search	Allows the projector to automatically search for a signal.

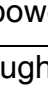
SYSTEM SETUP: ADVANCED menu

Audio Out Volume	Adjusts the sound level.
Mute	Temporarily turns off the sound.
HDMI Range	<p>Selects a suitable RGB color range to correct the color accuracy.</p> <ul style="list-style-type: none"> • Auto: Automatically selects a suitable color range for the incoming HDMI signal. • Full Range: Utilizes the Full range RGB 0-255. • Limited Range: Utilizes the Limited range RGB 16-235.
Password	See " Utilizing the password function " on page 27.
Panel Key Lock	<p>With the control keys on the projector and remote control locked, you can prevent your projector settings from being changed accidentally (by children, for example). When the Panel Key Lock is on, no control keys on the projector and remote control will operate except ON/Stand-by .</p> <p>To release panel key lock, press and hold ▶ (the right key) on the projector or remote control for 3 seconds.</p> <p></p> <p>If you turn off the projector without disabling panel key lock, the projector will still be in locked status the next time it is turned on.</p>

Serial Port Setting	Allows you to select a preferred control port: through the RS-232C port (SERIAL port on the projector) or the HDBaseT port (HDBaseT input port on the projector).							
Network Settings	<p>This projector is equipped with network function. You can manage and control the projector from a remote computer using a web browser when they are properly connected to the same local area network.</p> <ul style="list-style-type: none"> • Wired LAN <ul style="list-style-type: none"> • Status: Shows the connection status. • DHCP: Select On if you are in a DHCP environment and IP Address, Subnet Mask, Default Gateway, DNS Server settings will be automatically retrieved. Select Off if you are in a non-DHCP environment and make adjustments to below settings. <table border="1" data-bbox="413 663 1460 882"> <tr> <td data-bbox="413 663 735 703">• IP Address</td> <td data-bbox="740 663 1460 882" rowspan="4">Only available when DHCP is set to Off. Use ◀/▶ to select a column and use ▲/▼ to adjust the value.</td> </tr> <tr> <td data-bbox="413 710 735 750">• Subnet Mask</td> </tr> <tr> <td data-bbox="413 757 735 797">• Default Gateway</td> </tr> <tr> <td data-bbox="413 804 735 844">• DNS Server</td> </tr> <tr> <td data-bbox="413 851 735 891">• Apply</td> <td data-bbox="740 851 1460 891">Enacts these settings.</td> </tr> </table> <p> For details on controlling the projector from a remote computer, see "Controlling the projector remotely" on page 38.</p> <ul style="list-style-type: none"> • AMX Device Discovery: When this function is On, the projector can be detected by AMX controller. • MAC Address: Displays the mac address for this projector. 	• IP Address	Only available when DHCP is set to Off . Use ◀/▶ to select a column and use ▲/▼ to adjust the value.	• Subnet Mask	• Default Gateway	• DNS Server	• Apply	Enacts these settings.
• IP Address	Only available when DHCP is set to Off . Use ◀/▶ to select a column and use ▲/▼ to adjust the value.							
• Subnet Mask								
• Default Gateway								
• DNS Server								
• Apply	Enacts these settings.							
Network Standby	<ul style="list-style-type: none"> • Enable Network Standby Mode: Allows the projector to provide the network function in standby mode. • Auto Disable Network Standby Mode: Allows the projector to disable the network function after a set period of time after it enters standby mode. For instance, if 20 min is selected, the projector is able to provide the network function for 20 minutes after it enters standby mode. When 20 minutes is up, the projector enters normal standby mode. 							
Reset All Settings	<p>Returns all settings to the factory preset values.</p> <p> The following settings will still remain: Picture Mode, User Mode Settings, Brightness, Contrast, Color, Tint, Sharpness, Advanced, Projector Mode, Rename Input, Audio Out Volume, Mute, Password, Network Settings and Network Standby.</p>							

INFORMATION menu

Input	Shows the current signal source.
Picture Mode	Shows the selected mode in the PICTURE menu.
Resolution	Shows the native resolution of the input signal.
Color System	Shows input system format.

Light Source Usage Time	Shows the number of hours the light source has been used.
Firmware Version	Shows the firmware version of your projector.

Controlling the projector remotely

Once you have the correct IP address for the projector and the projector is on or in standby mode, you can use any computer that is on the same local area network to control the projector.



The screenshots in this user's guide are for reference only, and may differ from the actual design.

1. Enter the address of the projector in the address bar of your browser and press Enter.



2. The Crestron (eControl) page displays the Crestron eControl user interface. The eControl page provides a variety of virtual keys to control the projector or adjust the projected pictures.

- Main page



- i. These buttons function the same as the ones on the OSD menus, projector or remote control. See "[Projector & Remote control](#)" on page 16 and "[Menu operation](#)" on page 30 for details. However, if you intend to go back to previous OSD menu, exit and save menu settings, press **MENU**.
- ii. To switch input source, click your desired signal.

- Tools page

The tools page allows you to manage the projector, configure the LAN control settings and secure access of remote network operation on this projector.



i. You can name the projector, keep track of its location and the person in charge of it.

ii. You can adjust the **Network Settings**.

iii. Once set, access to the remote network operation on this projector has been password-protected.

iv. Once set, access to the tools page has been password-protected.



After making the adjustments, press the Send button and the data will be saved in the projector.

v. Press this button to go back to the remote network operation page.

- Info page

The info page displays the information and status of this projector.



i. Press this button to go back to the remote network operation page.

PJLink Commands

This projector supports standard protocol PJLink for projector control. Supported commands are as below.

Command	Control details	Notes
POWR	Power supply control	Parameters 0 = Standby 1 = Power ON
POWR ?	Power supply status query	Parameters 0 = Standby 1 = Power ON
INST ?	Input selection index query	No.1 11 No.2 31 No.3 32 No.4 51
INPT	Input selection	Parameters 11: RGB 1 31: HDMI 1
INPT ?	Input selection query	32: HDMI 2 51: HDBaseT
AVMT	AV MUTE control	Parameters VIDEO & AUDIO MUTE mode off
AVMT ?	AV MUTE status query	VIDEO & AUDIO MUTE mode on
ERST ?	Error status query	Parameters 1st byte: Indicates fan errors, range 0 , 2 2nd byte: Indicates light source errors, range 0 , 2 3rd byte: Indicates temperature errors, range 0 , 2 4th byte: Fixed at 0 Definitions for each value from 0 or 2 are as follows. 0 = No error known 1 = Warning 2 = Error
LAMP ?	Light source status query	Parameters 1st digits (1 – 5 digits) : Light source cumulative operating time
NAME ?	Projector name query	"CASIO" is returned.
INF1 ?	Manufacturer name query	"CASIO" is returned.
INF2 ?	Model name query	"XJ-L8300HN" is returned.
INFO ?	Other information query	"" (null) is returned.
CLSS ?	Class information query	"1" is returned.



For details, visit the CASIO website at the URL below.

<http://world.casio.com/download/projector/>

Projector RS-232C Control

To control the projector using RS-232C commands from a computer, you need to connect the projector and computer using a commercially available serial cable (cross).

Interface settings

RS-232C Protocol	
Baud rate	Fixed at 9600
Data length	8 bit
Parity check	None
Stop bit	1 bit
Flow control	None

Commnad table

Function	Type	Operation	ASCII
Power	Write	Power On	<CR>*pow=on#<CR>
	Write	Power off	<CR>*pow=off#<CR>
	Read	Power Status	<CR>*pow=?#<CR>
Source Selection	Write	COMPUTER/YpbPr	<CR>*sour=RGB#<CR>
	Write	HDMI	<CR>*sour=hdmi#<CR>
	Write	HDMI 2	<CR>*sour=hdmi2#<CR>
	Write	HDBaseT	<CR>*sour=hdbaset#<CR>
	Read	Current source	<CR>*sour=?#<CR>
Audio	Write	Mute On	<CR>*mute=on#<CR>
	Write	Mute Off	<CR>*mute=off#<CR>
	Read	Mute Status	<CR>*mute=?#<CR>
	Write	Volume +	<CR>*vol=+#<CR>
	Write	Volume -	<CR>*vol=-#<CR>
	Write	Volume = value	<CR>*vol=value#<CR>
	Read	Volume Status	<CR>*vol=?#<CR>
Picture Mode	Write	Bright	<CR>*appmod=bright#<CR>
	Write	Vivid	<CR>*appmod=vivid#<CR>
	Write	Natural	<CR>*appmod=natural#<CR>
	Write	User1	<CR>*appmod=user1#<CR>
	Write	User2	<CR>*appmod=user2#<CR>
	Read	Picture Mode	<CR>*appmod=?#<CR>

Picture Setting

Write	Contrast +	<CR>*con=+#<CR>
Write	Contrast -	<CR>*con=-#<CR>
Read	Contrast value	<CR>*con=?#<CR>
Write	Brightness +	<CR>*bri=+#<CR>
Write	Brightness -	<CR>*bri=-#<CR>
Read	Brightness value	<CR>*bri=?#<CR>
Write	Color +	<CR>*color=+#<CR>
Write	Color -	<CR>*color=-#<CR>
Read	Color value	<CR>*color=?#<CR>
Write	Tint +	<CR>*tint=+#<CR>
Write	Tint -	<CR>*tint=-#<CR>
Read	Tint value	<CR>*tint=?#<CR>
Write	Sharpness +	<CR>*sharp=+#<CR>
Write	Sharpness -	<CR>*sharp=-#<CR>
Read	Sharpness value	<CR>*sharp=?#<CR>
Write	Skin Tone +	<CR>*skintone=+#<CR>
Write	Skin Tone -	<CR>*skintone=-#<CR>
Read	Skin Tone value	<CR>*skintone=?#<CR>
Write	Color Temperature-Warm	<CR>*ct=warm#<CR>
Write	Color Temperature-Normal	<CR>*ct=normal#<CR>
Write	Color Temperature-Cool	<CR>*ct=cool#<CR>
Read	Color Temperature Status	<CR>*ct=?#<CR>
Write	Aspect 4:3	<CR>*asp=4:3#<CR>
Write	Aspect 16:9	<CR>*asp=16:9#<CR>
Write	Aspect 16:10	<CR>*asp=16:10#<CR>
Write	Aspect Auto	<CR>*asp=AUTO#<CR>
Read	Aspect Status	<CR>*asp=?#<CR>
Write	Overscan Adjustment +	<CR>*overscan=+#<CR>
Write	Overscan Adjustment -	<CR>*overscan=-#<CR>
Read	Overscan Adjustment value	<CR>*overscan=?#<CR>
Write	Auto	<CR>*auto#<CR>
Write	Red Gain +	<CR>*RGain=+#<CR>
Write	Red Gain -	<CR>*RGain=-#<CR>
Read	Red Gain value	<CR>*RGain=?#<CR>
Write	Green Gain +	<CR>*GGain=+#<CR>
Write	Green Gain -	<CR>*GGain=-#<CR>
Read	Green Gain value	<CR>*GGain=?#<CR>
Write	Blue Gain +	<CR>*BGain=+#<CR>
Write	Blue Gain -	<CR>*BGain=-#<CR>
Read	Blue Gain value	<CR>*BGain=?#<CR>

Picture Setting	Write	Red Offset +	<CR>*ROffset=+#<CR>
	Write	Red Offset -	<CR>*ROffset=-#<CR>
	Read	Red Offset value	<CR>*ROffset=?#<CR>
	Write	Green Offset +	<CR>*GOffset=+#<CR>
	Write	Green Offset -	<CR>*GOffset=-#<CR>
	Read	Green Offset value	<CR>*GOffset=?#<CR>
	Write	Blue Offset +	<CR>*BOffset=+#<CR>
	Write	Blue Offset -	<CR>*BOffset=-#<CR>
	Read	Blue Offset value	<CR>*BOffset=?#<CR>
	Write	Gamma Selection-1.6	<CR>*gamma=1.6#<CR>
	Write	Gamma Selection-1.8	<CR>*gamma=1.8#<CR>
	Write	Gamma Selection-2.0	<CR>*gamma=2.0#<CR>
	Write	Gamma Selection-2.1	<CR>*gamma=2.1#<CR>
	Write	Gamma Selection-2.2	<CR>*gamma=2.2#<CR>
	Write	Gamma Selection-2.3	<CR>*gamma=2.3#<CR>
	Write	Gamma Selection-2.4	<CR>*gamma=2.4#<CR>
	Write	Gamma Selection-2.5	<CR>*gamma=2.5#<CR>
	Write	Gamma Selection-2.6	<CR>*gamma=2.6#<CR>
	Write	Gamma Selection-2.8	<CR>*gamma=2.8#<CR>
Read	Gamma Selection Status	<CR>*gamma=?#<CR>	

Operation Settings	Write	Splash Screen -Casio	<CR>*splash=casio#<CR>
	Write	Splash Screen -Black	<CR>*splash=black#<CR>
	Write	Splash Screen -Blue	<CR>*splash=blue#<CR>
	Read	Splash Screen Status	<CR>*splash=?#<CR>
	Write	Background Color - Green	<CR>*background=green#<CR>
	Write	Background Color - Black	<CR>*background=black#<CR>
	Write	Background Color - Blue	<CR>*background=blue#<CR>
	Read	Background Color States	<CR>*background=?#<CR>
	Write	Projector Position-Front Table	<CR>*pp=FT#<CR>
	Write	Projector Position-Rear Table	<CR>*pp=RE#<CR>
	Write	Projector Position-Rear Ceiling	<CR>*pp=RC#<CR>
	Write	Projector Position-Front Ceiling	<CR>*pp=FC#<CR>
	Read	Projector Position Status	<CR>*pp=?#<CR>
	Write	Quick auto search/Auto source search	<CR>*QAS=on#<CR>
	Write	Quick auto search/Auto source search	<CR>*QAS=off#<CR>
	Read	Quick auto search status/Auto source search status	<CR>*QAS=?#<CR>
	Write	Menu Display Time -Always On	<CR>*menutime=on#<CR>
	Write	Menu Display Time -5 sec	<CR>*menutime=5s#<CR>
	Write	Menu Display Time -10 sec	<CR>*menutime=10s#<CR>
	Write	Menu Display Time -15 sec	<CR>*menutime=15s#<CR>
	Write	Menu Display Time -20 sec	<CR>*menutime=20s#<CR>
	Write	Menu Display Time -25 sec	<CR>*menutime=25s#<CR>
	Write	Menu Display Time -30 sec	<CR>*menutime=30s#<CR>
	Read	Menu Display Time Status	<CR>*menutime=?#<CR>
	Write	Menu Position - Center	<CR>*menuposition=center#<CR>
	Write	Menu Position - Top-Left	<CR>*menuposition=tl#<CR>
	Write	Menu Position - Top-Right	<CR>*menuposition=tr#<CR>
	Write	Menu Position - Bottom-Right	<CR>*menuposition=br#<CR>
	Write	Menu Position - Bottom-Left	<CR>*menuposition=bl#<CR>
	Read	Menu Position Status	<CR>*menuposition=?#<CR>
	Write	Reminder Message - On	<CR>*reminder=on#<CR>
	Write	Reminder Message - Off	<CR>*reminder=off#<CR>
	Read	Reminder Message Status	<CR>*reminder=?#<CR>
	Write	Direct Power On-on	<CR>*directpower=on#<CR>
	Write	Direct Power On-off	<CR>*directpower=off#<CR>
	Read	Direct Power On-Status	<CR>*directpower=?#<CR>
Write	Standby Settings-Network on	<CR>*standbynet=on#<CR>	
Write	Standby Settings-Network off	<CR>*standbynet=off#<CR>	
Read	Standby Settings-Network Status	<CR>*standbynet=?#<CR>	

Lamp Control	Read	Light Source Usage Time	<CR>*ltim=?#<CR>
	Write	Normal mode	<CR>*lampm=lnor#<CR>
	Write	Eco mode	<CR>*lampm=eco#<CR>
	Write	360 & Portrait	<CR>*lampm=portrait360#<CR>
	Read	Lamp Mode Status	<CR>*lampm=?#<CR>
Miscellaneous	Read	Model Name	<CR>*modelName=?#<CR>
	Write	Blank On	<CR>*blank=on#<CR>
	Write	Blank Off	<CR>*blank=off#<CR>
	Read	Blank Status	<CR>*blank=?#<CR>
	Write	Menu On	<CR>*menu=on#<CR>
	Write	Menu Off	<CR>*menu=off#<CR>
	Write	Up	<CR>*up#<CR>
	Write	Down	<CR>*down#<CR>
	Write	Right	<CR>*right#<CR>
	Write	Left	<CR>*left#<CR>
	Write	Enter/OK	<CR>*enter#<CR>
	Write	BACK	<CR>*back#<CR>
	Write	Language +	<CR>*lang=+#<CR>
	Write	Language -	<CR>*lang=-#<CR>
	Read	Language Status	<CR>*lang=?#<CR>
	Write	Auto Power off -disable	<CR>*APOFF=DIS#<CR>
	Write	Auto Power off - 5 min	<CR>*APOFF=5#<CR>
	Write	Auto Power off - 10 min	<CR>*APOFF=10#<CR>
	Write	Auto Power off - 15 min	<CR>*APOFF=15#<CR>
	Write	Auto Power off - 20 min	<CR>*APOFF=20#<CR>
	Write	Auto Power off - 25 min	<CR>*APOFF=25#<CR>
	Write	Auto Power off - 30 min	<CR>*APOFF=30#<CR>
	Read	Auto Power off Status	<CR>*APOFF=?#<CR>
	Write	AMX Device Discovery-on	<CR>*amxdd=on#<CR>
	Write	AMX Device Discovery-off	<CR>*amxdd=off#<CR>
	Read	AMX Device Discovery Status	<CR>*amxdd=?#<CR>
	Read	Mac Address	<CR>*macaddr=?#<CR>
	Write	High Altitude mode on	<CR>*Highaltitude=on#<CR>
	Write	High Altitude mode off	<CR>*Highaltitude=off#<CR>
	Read	High Altitude mode status	<CR>*Highaltitude=?#<CR>
	Write	Key Lock on	<CR>*keylock=on#<CR>
	Write	Key Lock off	<CR>*keylock=off#<CR>
Read	Key Lock status	<CR>*keylock=?#<CR>	

Maintenance

Care of the projector

Cleaning the lens

Clean the lens whenever you notice dirt or dust on the surface. Please be sure to turn off the projector and let it cool down completely before cleaning the lens.

- If there is dirt or smears, use lens-cleaning paper or moisten a soft cloth with lens cleaner and gently wipe the lens surface.
- Never use any type of abrasive pad, alkaline/acid cleaner, scouring powder, or volatile solvent, such as alcohol, benzene, thinner or insecticide. Using such materials or maintaining prolonged contact with rubber or vinyl materials may result in damage to the projector surface and cabinet material.

Cleaning the projector case

Before you clean the case, turn the projector off using the proper shutdown procedure as described in "[Shutting down the projector](#)" on [page 29](#) and unplug the power cord.

- To remove dirt or dust, wipe the case with a soft, lint-free cloth.
- To remove stubborn dirt or stains, moisten a soft cloth with water and a neutral pH detergent. Then wipe the case.



Never use wax, alcohol, benzene, thinner or other chemical detergents. These can damage the case.

Storing the projector

If you need to store the projector for an extended time, please follow the instructions below:

- Make sure the temperature and humidity of the storage area are within the recommended range for the projector. Please refer to "[Specifications](#)" on [page 50](#) or consult your dealer about the range.
- Retract the adjuster feet.
- Remove the battery from the remote control.
- Pack the projector in its original packing or equivalent.

Transporting the projector

It is recommended that you ship the projector with its original packing or equivalent.

Light source information

Getting to know the light source hour

When the projector is in operation, the duration (in hours) of light source usage is automatically calculated by the built-in timer.

To obtain the light source hour information:

1. Go to **INSTALLATION > Light Source Settings** and press **ENTER**. The **Light Source Settings** page appears.
2. Press **▼** to select **Light Source Information** and press **ENTER**. The light source information is displayed.

You can also get the light source hour information on the **INFORMATION** menu.

Saving power

• Setting the **Light Source Mode**

Go to **INSTALLATION > Light Source Settings > Light Source Mode** and press **◀/▶** or press **L. MODE** on the remote control to select a suitable light source mode from among the provided modes.

Setting the projector in **Eco/360 & Portrait** mode saves power.

Light source mode	Description
Normal	Provides full light source brightness
Eco	Lowers brightness to save power and decreases the fan noise
360 & Portrait	Lowers brightness to save power, most suitable for 360-degree and portrait projection

• Setting **Auto Power Off**

This function allows the projector to turn off automatically if no input signal is detected after a set period of time to save power.









To set **Auto Power Off**, go to **SYSTEM SETUP: BASIC > Auto Power Off** and press **◀/▶**.



- The apparent brightness of the projected image will vary depending on the ambient lighting conditions, selected input signal contrast/brightness settings, and is directly proportional to projection distance.
- The light source brightness will decline over time and may vary within the light source manufacturers specifications. This is normal and expected behavior.

Indicators

Light			Status & Description
POWER / STANDBY	TEMP	LIGHT	
Power events			
			Stand-by mode (The indicator lights may stay lit even after you unplug the power cord. However, this is not a malfunction.)
			Powering up
			Normal operation
			Normal power-down cooling
			Phosphor/color wheel start fail
			Phosphor/color wheel spin fail
Light source events			
			Light source error in normal operation
			Light source is not lit up
Thermal events			
			Fan 1 error (the actual fan speed is outside the desired speed)
			Fan 2 error (the actual fan speed is outside the desired speed)
			Fan 3 error (the actual fan speed is outside the desired speed)
			Fan 4 error (the actual fan speed is outside the desired speed)
			Fan 5 error (the actual fan speed is outside the desired speed)
			Fan 6 error (the actual fan speed is outside the desired speed)
			Fan 7 error (the actual fan speed is outside the desired speed)
			Fan 8 error (the actual fan speed is outside the desired speed)
			Temperature 1 error (over limited temperature)
			Temperature 2 error (over limited temperature)
			Water pump error (The water from liquid cooler is insufficient)

	 : Off	 : Orange On	 : Green On	 : Red On
		 : Orange Flashing	 : Green Flashing	 : Red Flashing

Troubleshooting

? The projector does not turn on.

Cause	Remedy
There is no power from the power cord.	Plug the power cord into the AC power jack on the projector, and plug the power cord into the power outlet. If the power outlet has a switch, make sure that it is switched on.
Attempting to turn the projector on again during the cooling process.	Wait until the cooling down process has completed.

? No picture

Cause	Remedy
The video source is not turned on or connected correctly.	Turn the video source on and check that the signal cable is connected correctly.
The projector is not correctly connected to the input signal device.	Check the connection.
The input signal has not been correctly selected.	Select the correct input signal with the INPUT key.
The lens cover is still closed.	Open the lens cover.

? Blurred image

Cause	Remedy
The projection lens is not correctly focused.	Adjust the focus of the lens using the focus ring.
The projector and the screen are not aligned properly.	Adjust the projection angle and direction as well as the height of the projector if necessary.
The lens cover is still closed.	Open the lens cover.

? Remote control does not work.

Cause	Remedy
The batteries are out of power.	Replace both of the batteries with new ones.
There is an obstacle between the remote control and the projector.	Remove the obstacle.
You are too far away from the projector.	Stand within 8 meters (26 feet) of the projector.

? The password is incorrect.

Cause	Remedy
You do not remember the password.	See "Entering the password recall procedure" on page 28.

Specifications

Projector specifications



All specifications are subject to change without notice.

Optical

Resolution

4K UHD 3840 x 2160

Display system

1-CHIP DLP

Clear focus range

2.89–6.09 m @ Wide, 4.25–8.96 m @ Tele

Lens

F = 2.1 to 2.4, f = 20.6 to 30.3 mm

Electrical

Power supply

100 to 240V ~ (AC), 50/60Hz

Power consumption

595 W (Max); < 0.5 W (Standby);
< 3.0 W (Network standby)

Mechanical

Weight

19.8 Kg (43.7 lbs)

Output terminals

RGB output

15-pin mini D-Sub (female) x 1

Audio signal output

3.5 mm stereo mini jack x 1

USB

DC (5V 2A) Output port x 1

12V Trigger (0.5A) x 1

Control

RS-232C serial control

9-pin D-sub male x 1

LAN control

RJ-45 x 1

Service Port x 1

Wired Remote x 1

IR receiver x 2

Input terminals

Computer input

RGB input

15-pin mini D-Sub (female) x 1

Video signal input

Digital

HDMI1 (HDCP2.2) x1;

HDMI2 x1

HDBaseT x 1

Environmental Requirements

Operating temperature

5°C–35°C at sea level

Storage temperature

-10°C–65°C at sea level

Operating/Storage relative humidity

10%–90% (without condensation)

Operating altitude

0 up to 1500 m at 5°C–35°C

1500–3000 m at 5°C–30°C (with

High Altitude Mode on)

Dimensions

471 mm (W) x 223 mm (H) x 565 mm (D)

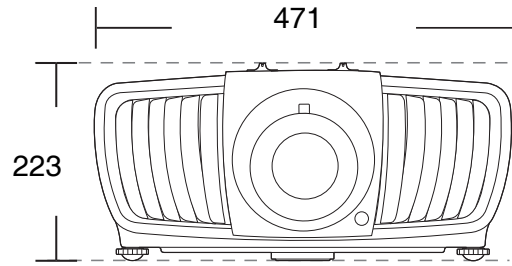
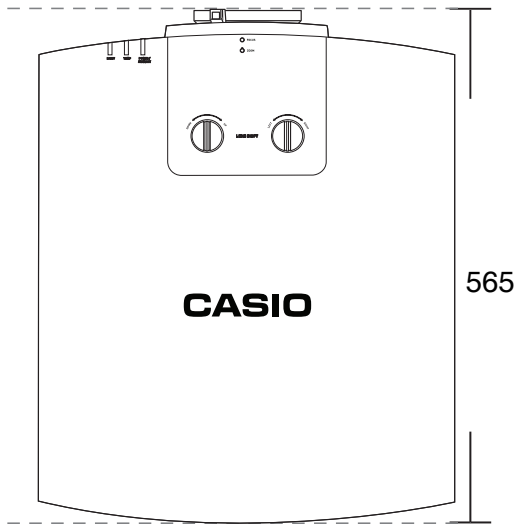

Unit: mm

Timing chart

Supported timing for RGB input

Resolution	Mode	Vertical Frequency (Hz)	Horizontal Frequency (kHz)	Pixel Frequency (MHz)
640 x 480	VGA_60	59.940	31.469	25.175
	VGA_72	72.809	37.861	31.500
	VGA_75	75.000	37.500	31.500
	VGA_85	85.008	43.269	36.000
800 x 600	SVGA_60	60.317	37.879	40.000
	SVGA_72	72.188	48.077	50.000
	SVGA_75	75.000	46.875	49.500
	SVGA_85	85.061	53.674	56.250
1024 x 768	XGA_60	60.004	48.363	65.000
	XGA_70	70.069	56.476	75.000
	XGA_75	75.029	60.023	78.750
	XGA_85	84.997	68.667	94.500
1152 x 864	1152 x 864_75	75.00	67.500	108.000
1280 x 720	1280 x 720_60	60	45.000	74.250
1280 x 768	1280 x 768_60	59.870	47.776	79.5
1280 x 800	WXGA_60	59.810	49.702	83.500
1280 x 1024	SXGA_60	60.020	63.981	108.000
	SXGA_75	75.025	79.976	135.000
	SXGA_85	85.024	91.146	157.500
1280 x 960	1280 x 960_60	60.000	60.000	108
1366 x 768	1366 x 768_60	59.790	47.712	85.500
1440 x 900	WXGA+_60	59.887	55.935	106.500
1400 x 1050	SXGA+_60	59.978	65.317	121.750
1600 x 1200	UXGA	60.000	75.000	162.000
1680 x 1050	1680 x 1050_60	59.954	65.290	146.250
1920 x 1200@60Hz	1920 x 1200_60 (Reduce Blanking)	59.95	74.038	154
1920 x 1080 (VESA)	1920 x 1080_60	59.963	67.158	173



The timings showing above may not be supported due to EDID file and VGA graphic card limitations. It is possible that some timings cannot be chosen.

Supported timing for HDMI input

• PC timings

Resolution	Mode	Vertical Frequency (Hz)	Horizontal Frequency (kHz)	Pixel Frequency (MHz)
640 x 480	VGA_60	59.940	31.469	25.175
800 x 600	SVGA_60	60.317	37.879	40.000
1024 x 768	XGA_60	60.004	48.363	65.000
1280 x 720	1280 x 720_60	60	45.000	74.250
1280 x 768	1280 x 768_60	59.870	47.776	79.5
1280 x 800	WXGA_60	59.810	49.702	83.500
1280 x 1024	SXGA_60	60.020	63.981	108.000
1280 x 960	1280 x 960_60	60.000	60.000	108
1400 x 1050	SXGA+_60	59.978	65.317	121.750
1920 x 1200@60Hz	1920 x 1200_60 (Reduce Blanking)	59.95	74.038	154
1920 x 1080 (VESA)	1920 x 1080_60	59.963	67.158	173



The timings showing above may not be supported due to EDID file and VGA graphic card limitations. It is possible that some timings cannot be chosen.

• Video timings

Timing	Resolution	Vertical Frequency (Hz)	Horizontal Frequency (kHz)	Pixel Frequency (MHz)
480p	720 x 480	59.94	31.47	27
576p	720 x 576	50	31.25	27
720/50p	1280 x 720	50	37.5	74.25
720/60p	1280 x 720	60	45.00	74.25
1080/50i	1920 x 1080	50	28.13	74.25
1080/60i	1920 x 1080	60	33.75	74.25
1080/50P	1920 x 1080	50	56.25	148.5
1080/60P	1920 x 1080	60	67.5	148.5
2160/24P	3840 x 2160	24	54	297
2160/25P	3840 x 2160	25	56.25	297
2160/30P	3840 x 2160	30	67.5	297
2160/50P*	3840 x 2160	50	112.5	594
2160/60P*	3840 x 2160	60	135	594



*Supported only when an HDMI 1 (HDCP2.2) port is in use.

Supported timing for Component-YPbPr input

Timing	Resolution	Vertical Frequency (Hz)	Horizontal Frequency (kHz)	Pixel Frequency (MHz)
480i	720 x 480	59.94	15.73	13.5
480p	720 x 480	59.94	31.47	27
576i	720 x 576	50	15.63	13.5
576p	720 x 576	50	31.25	27
720/50p	1280 x 720	50	37.5	74.25
720/60p	1280 x 720	60	45.00	74.25
1080/50i	1920 x 1080	50	28.13	74.25
1080/60i	1920 x 1080	60	33.75	74.25
1080/50P	1920 x 1080	50	56.25	148.5
1080/60P	1920 x 1080	60	67.5	148.5

Supported timing for HDBaseT input

• PC timings

Resolution	Mode	Vertical Frequency (Hz)	Horizontal Frequency (kHz)	Pixel Frequency (MHz)
640 x 480	VGA_60	59.940	31.469	25.175
800 x 600	SVGA_60	60.317	37.879	40.000
1024 x 768	XGA_60	60.004	48.363	65.000
1280 x 720	1280 x 720_60	60	45.000	74.250
1280 x 768	1280 x 768_60	59.870	47.776	79.5
1280 x 800	WXGA_60	59.810	49.702	83.500
1280 x 1024	SXGA_60	60.020	63.981	108.000
1280 x 960	1280 x 960_60	60.000	60.000	108
1400 x 1050	SXGA+_60	59.978	65.317	121.750
1920 x 1200@60Hz	1920 x 1200_60 (Reduce Blanking)	59.95	74.038	154
1920 x 1080 (VESA)	1920 x 1080_60	59.963	67.158	173



The timings showing above may not be supported due to EDID file and VGA graphic card limitations. It is possible that some timings cannot be chosen.

• Video timings

Cable type	Cable Range	Pixel Frequency	Supported HDMI format		
CAT 5e/CAT 6a	100m	<=225MHz	720x480p/60Hz	4:3	24bit 30bit 36 bit
			1280x720p/60Hz	16:9	24bit 30bit 36 bit
			1920x1080i/60Hz	16:9	24bit 30bit 36 bit
			1920x1080p/60Hz	16:9	24bit 30bit 36 bit
			720x576p/50Hz	4:3	24bit 30bit 36 bit
			1280x720p/50Hz	16:9	24bit 30bit 36 bit
			1920x1080i/50Hz	16:9	24bit 30bit 36 bit
			1920x1080p/50Hz	16:9	24bit 30bit 36 bit
CAT 5e	70m	>225MHz	3840 x 2160 60Hz YUV 4:2:0		24bit
CAT 5e	70m	>225MHz	3840 x 2160 30Hz		24bit
CAT 6a	100m	>225MHz	3840 x 2160 30Hz		24bit

GUIDELINES LAID DOWN BY FCC RULES FOR USE OF THIS UNIT IN THE U.S.A. (not applicable to other areas).

NOTICE

This equipment has been tested and found to comply with the limits for a Class B digital device, pursuant to Part 15 of the FCC Rules. These limits are designed to provide reasonable protection against harmful interference in a residential installation. This equipment generates uses and can radiate radio frequency energy and, if not installed and used in accordance with the instructions, may cause harmful interference to radio communication. However, there is no guarantee that interference will not occur in a particular installation. If this equipment does cause harmful interference to radio or television reception, which can be determined by turning the equipment off and on, the user is encouraged to try to correct the interference by one or more of the following measures:

- Reorient or relocate the receiving antenna.
- Increase the separation between the equipment and receiver.
- Connect the equipment into an outlet on a circuit different from that to which the receiver is connected.
- Consult the dealer or an experienced radio/TV technician for help.

FCC CAUTION

Changes or modifications not expressly approved by the party responsible for compliance could void the user's authority to operate the equipment.

Proper connectors must be used for connection to host computer and/or peripherals in order to meet FCC emission limits.

Connector cable....XJ-L8300HN

Declaration of Conformity

Model Number: XJ-L8300HN

Trade Name: CASIO COMPUTER CO., LTD.

Responsible party: CASIO AMERICA, INC.

Address: 570 MT. PLEASANT AVENUE, DOVER, NEW JERSEY 07801

Telephone number: 973-361-5400

This device complies with Part 15 of the FCC Rules, Operation is subject to the following two conditions:

(1) This device may not cause harmful interference, and (2) this device must accept any interference received, including interference that may cause undesired operation.



FOR CALIFORNIA USA ONLY

Perchlorate Material – special handling may apply.
See www.dtsc.ca.gov/hazardouswaste/perchlorate.

This Class B digital apparatus complies with Canadian ICES-003.

Cet appareil numérique de la classe B est conforme à la norme NMB-003 du Canada.

HDMI[™]
HIGH DEFINITION MULTIMEDIA INTERFACE



Manufacturer:
CASIO COMPUTER CO., LTD.
6-2, Hon-machi 1-chome, Shibuya-ku, Tokyo 151-8543, Japan
Responsible within the European Union:
Casio Europe GmbH
Casio-Platz 1, 22848 Norderstedt, Germany
www.casio-europe.com

CASIO[®]

CASIO COMPUTER CO., LTD.
6-2, Hon-machi 1-chome
Shibuya-ku, Tokyo 151-8543, Japan

MQ008-01V01

Free Manuals Download Website

<http://myh66.com>

<http://usermanuals.us>

<http://www.somanuals.com>

<http://www.4manuals.cc>

<http://www.manual-lib.com>

<http://www.404manual.com>

<http://www.luxmanual.com>

<http://aubethermostatmanual.com>

Golf course search by state

<http://golfingnear.com>

Email search by domain

<http://emailbydomain.com>

Auto manuals search

<http://auto.somanuals.com>

TV manuals search

<http://tv.somanuals.com>