

# Dell Precision Mobile Workstation M6700 Owner's Manual

Regulatory Model: P22F  
Regulatory Type: P22F001



# Notes, Cautions, and Warnings



**NOTE:** A NOTE indicates important information that helps you make better use of your computer.



**CAUTION:** A CAUTION indicates either potential damage to hardware or loss of data and tells you how to avoid the problem.



**WARNING:** A WARNING indicates a potential for property damage, personal injury, or death.

© 2012 Dell Inc.

Trademarks used in this text: Dell™, the DELL logo, Dell Precision™, Precision ON™, ExpressCharge™, Latitude™, Latitude ON™, OptiPlex™, Vostro™, and Wi-Fi Catcher™ are trademarks of Dell Inc. Intel®, Pentium®, Xeon®, Core™, Atom™, Centrino®, and Celeron® are registered trademarks or trademarks of Intel Corporation in the U.S. and other countries. AMD® is a registered trademark and AMD Opteron™, AMD Phenom™, AMD Sempron™, AMD Athlon™, ATI Radeon™, and ATI FirePro™ are trademarks of Advanced Micro Devices, Inc. Microsoft®, Windows®, MS-DOS®, Windows Vista®, the Windows Vista start button, and Office Outlook® are either trademarks or registered trademarks of Microsoft Corporation in the United States and/or other countries. Blu-ray Disc™ is a trademark owned by the Blu-ray Disc Association (BDA) and licensed for use on discs and players. The Bluetooth® word mark is a registered trademark and owned by the Bluetooth® SIG, Inc. and any use of such mark by Dell Inc. is under license. Wi-Fi® is a registered trademark of Wireless Ethernet Compatibility Alliance, Inc.

2012 - 07

Rev. A00

# Contents

<b>Notes, Cautions, and Warnings</b> .....	<b>2</b>
<b>1 Working on Your Computer</b> .....	<b>7</b>
Before Working Inside Your Computer.....	7
Recommended Tools.....	8
Turning Off Your Computer.....	8
After Working Inside Your Computer.....	9
<b>2 Removing and Installing Components</b> .....	<b>11</b>
Removing the Secure Digital (SD) Card.....	11
Installing the SD Card.....	11
Removing the ExpressCard.....	11
Installing the ExpressCard.....	11
Removing the Battery.....	11
Installing the Battery.....	12
Removing the Subscriber Identity Module (SIM) Card.....	12
Installing the Subscriber Identity Module (SIM) Card.....	13
Removing the Base Cover.....	13
Installing the Base Cover.....	14
Removing the Wireless Local Area Network (WLAN) Card.....	15
Installing the Wireless Local Area Network (WLAN) Card.....	15
Removing Wireless Wide Area Network (WWAN) Card (Optional).....	15
Installing the Wireless Wide Area Network (WWAN) Card (Optional).....	16
Removing the Optical Drive.....	16
Installing the Optical Drive.....	17
Removing the Primary Hard Drive.....	18
Installing the Primary Hard Drive.....	19
Removing the Secondary Hard Drive.....	19
Installing the Secondary Hard Drive.....	20
Removing the Coin-Cell Battery.....	20
Installing the Coin-Cell Battery.....	21
Removing the Processor Fan.....	21
Installing the Processor Fan.....	22
Removing the Video-Card Fan.....	22
Installing the Video-Card Fan.....	22
Removing the Keyboard Trim.....	22
Installing the Keyboard Trim.....	24

Removing the Keyboard.....	24
Installing the Keyboard.....	26
Removing the Primary Memory.....	26
Installing the Primary Memory.....	27
Removing the Secondary Memory.....	27
Installing the Secondary Memory.....	28
Removing the Bluetooth Module.....	28
Installing the Bluetooth Module.....	29
Removing the Display Bezel.....	29
Installing the Display Bezel.....	31
Removing the Camera.....	31
Installing the Camera.....	31
Removing the Display Panel.....	31
Installing the Display Panel.....	34
Removing the Palmrest.....	34
Installing the Palmrest.....	39
Removing the ExpressCard Module.....	39
Installing the ExpressCard Module.....	40
Removing the Heat Sink.....	40
Installing the Heat Sink.....	41
Removing the Processor.....	42
Installing the Processor.....	42
Removing the Video-Card Heatsink.....	42
Installing the Video-Card Heatsink.....	43
Removing the Video Card.....	44
Installing the Video Card.....	44
Removing the Input/Output (I/O) Board.....	45
Installing the I/O Board.....	46
Removing the Display Assembly.....	46
Installing the Display Assembly.....	49
Removing the Display Hinges and Hinge Towers.....	49
Installing the Display Hinges and Hinge Towers.....	50
Removing the Hinge Cover.....	50
Installing the Hinge Cover.....	51
Removing the System Board.....	51
Installing the System Board.....	54
Removing the Power-Connector Port.....	55
Installing the Power Connector Port.....	56
Removing the Switch Board.....	56
Installing the Switch Board.....	57

### **3 System Setup.....59**

Boot Sequence.....	59
Navigation Keys.....	59
System Setup Options.....	60
Updating the BIOS .....	67
System and Setup Password.....	67
Assigning a System Password and Setup Password.....	68
Deleting or Changing an Existing System and/or Setup Password.....	68
<b>4 Diagnostics.....</b>	<b>71</b>
Enhanced Pre-Boot System Assessment (ePSA) Diagnostics.....	71
<b>5 Troubleshooting Your Computer.....</b>	<b>73</b>
Device Status Lights.....	73
Battery Status Lights.....	74
<b>6 Specifications.....</b>	<b>75</b>
Technical Specification.....	75
<b>7 Getting Help.....</b>	<b>83</b>
Contacting Dell.....	83





# Working on Your Computer

## Before Working Inside Your Computer

Use the following safety guidelines to help protect your computer from potential damage and to help to ensure your personal safety. Unless otherwise noted, each procedure included in this document assumes that the following conditions exist:

- You have performed the steps in Working on Your Computer.
- You have read the safety information that shipped with your computer.
- A component can be replaced or--if purchased separately--installed by performing the removal procedure in reverse order.

 **WARNING:** Before working inside your computer, read the safety information that shipped with your computer. For additional safety best practices information, see the Regulatory Compliance Homepage at [www.dell.com/regulatory\\_compliance](http://www.dell.com/regulatory_compliance)

 **CAUTION:** Many repairs may only be done by a certified service technician. You should only perform troubleshooting and simple repairs as authorized in your product documentation, or as directed by the online or telephone service and support team. Damage due to servicing that is not authorized by Dell is not covered by your warranty. Read and follow the safety instructions that came with the product.

 **CAUTION:** To avoid electrostatic discharge, ground yourself by using a wrist grounding strap or by periodically touching an unpainted metal surface, such as a connector on the back of the computer.

 **CAUTION:** Handle components and cards with care. Do not touch the components or contacts on a card. Hold a card by its edges or by its metal mounting bracket. Hold a component such as a processor by its edges, not by its pins.

 **CAUTION:** When you disconnect a cable, pull on its connector or on its pull-tab, not on the cable itself. Some cables have connectors with locking tabs; if you are disconnecting this type of cable, press in on the locking tabs before you disconnect the cable. As you pull connectors apart, keep them evenly aligned to avoid bending any connector pins. Also, before you connect a cable, ensure that both connectors are correctly oriented and aligned.

 **NOTE:** The color of your computer and certain components may appear differently than shown in this document.

To avoid damaging your computer, perform the following steps before you begin working inside the computer.

1. Ensure that your work surface is flat and clean to prevent the computer cover from being scratched.
2. Turn off your computer (see [Turning Off Your Computer](#)).
3. If the computer is connected to a docking device (docked) such as the optional Media Base or Battery Slice, undock it.

 **CAUTION:** To disconnect a network cable, first unplug the cable from your computer and then unplug the cable from the network device.

4. Disconnect all network cables from the computer.
5. Disconnect your computer and all attached devices from their electrical outlets.

6. Close the display and turn the computer upside-down on a flat work surface.

 **NOTE:** To avoid damaging the system board, you must remove the main battery before you service the computer.

7. Remove the main battery.
8. Turn the computer top-side up.
9. Open the display.
10. Press the power button to ground the system board.

 **CAUTION:** To guard against electrical shock, always unplug your computer from the electrical outlet before opening the display.

 **CAUTION:** Before touching anything inside your computer, ground yourself by touching an unpainted metal surface, such as the metal at the back of the computer. While you work, periodically touch an unpainted metal surface to dissipate static electricity, which could harm internal components.

11. Remove any installed ExpressCards or Smart Cards from the appropriate slots.

## Recommended Tools

The procedures in this document may require the following tools:

- Small flat-blade screwdriver
- #0 Phillips screwdriver
- #1 Phillips screwdriver
- Small plastic scribe
- Flash BIOS update program CD

## Turning Off Your Computer

 **CAUTION:** To avoid losing data, save and close all open files and exit all open programs before you turn off your computer.

1. Shut down the operating system:

- In Windows 7:

Click **Start** , then click **Shut Down**.

- In Windows Vista :

Click **Start** , then click the arrow in the lower-right corner of the **Start** menu as shown below, and then click **Shut Down**.



- In Windows XP:

Click **Start** → **Turn Off Computer** → **Turn Off** . The computer turns off after the operating system shutdown process is complete.

2. Ensure that the computer and all attached devices are turned off. If your computer and attached devices did not automatically turn off when you shut down your operating system, press and hold the power button for about 4 seconds to turn them off.



## After Working Inside Your Computer

After you complete any replacement procedure, ensure you connect any external devices, cards, and cables before turning on your computer.

 **CAUTION: To avoid damage to the computer, use only the battery designed for this particular Dell computer. Do not use batteries designed for other Dell computers.**

1. Connect any external devices, such as a port replicator, battery slice, or media base, and replace any cards, such as an ExpressCard.
2. Connect any telephone or network cables to your computer.

 **CAUTION: To connect a network cable, first plug the cable into the network device and then plug it into the computer.**

3. Replace the battery.
4. Connect your computer and all attached devices to their electrical outlets.
5. Turn on your computer.



## Removing and Installing Components

This section provides detailed information on how to remove or install the components from your computer.

### Removing the Secure Digital (SD) Card

1. Follow the procedures in *Before Working Inside Your Computer*.
2. Press in on the SD card to release it from the computer. Slide the SD card out of the computer.



### Installing the SD Card

1. Push in the SD card into its slot until it clicks into place.
2. Follow the procedures in *After Working Inside Your Computer*.

### Removing the ExpressCard

1. Follow the procedures in *Before Working On Your Computer*.
2. Push in on the ExpressCard.
3. Slide the ExpressCard out of the computer.

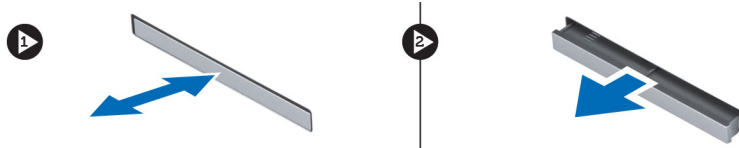

### Installing the ExpressCard

1. Insert the ExpressCard into the slot and press till it clicks into place. .
2. Follow the procedures in *After Working Inside Your Computer*.

### Removing the Battery

1. Follow the procedures in *Before Working Inside Your Computer*.
2. Slide the release latch to unlock the battery.



3. Flip and remove the battery from the computer.



## Installing the Battery

1. Slide the battery into its slot until it clicks into place.
2. Follow the procedures in *After Working Inside Your Computer*.

## Removing the Subscriber Identity Module (SIM) Card

1. Follow the procedures in *Before Working Inside Your Computer*.
2. Remove the battery.

3. Slide the SIM card out from the slot .

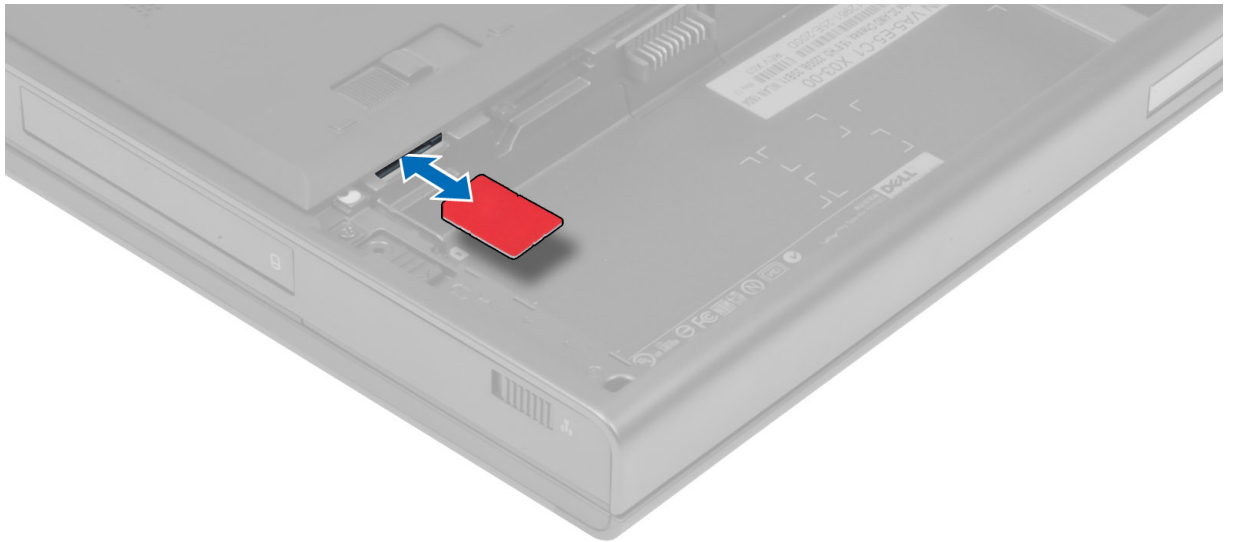

## Installing the Subscriber Identity Module (SIM) Card

1. Push in the SIM card into its slot.
2. Install the battery.
3. Follow the procedures in *After Working Inside Your Computer*.

## Removing the Base Cover

1. Follow the procedures in *Before Working Inside Your Computer*.
2. Remove the battery.
3. Remove the screws that secure the base cover to the computer. Press the rubber tabs towards the rear of the computer to disengage the base cover.



4. Flip and remove the base cover from the computer.



## Installing the Base Cover

1. Place the base cover to align with the screw holes correctly on the computer.
2. Tighten the screws to secure the base cover to the computer.
3. Install the battery.
4. Follow the procedures in *After Working Inside Your Computer*.

## Removing the Wireless Local Area Network (WLAN) Card

1. Follow the procedures in *Before Working Inside Your Computer*.
2. Remove the:
  - a) battery
  - b) base cover
3. Disconnect and un-route the antenna cables connected to the WLAN card. Remove the screw that secures the WLAN card to the computer. Remove the WLAN card from the computer.

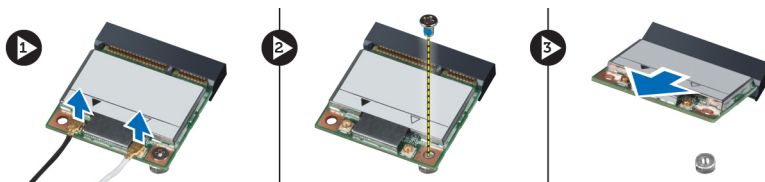

## Installing the Wireless Local Area Network (WLAN) Card

1. Insert the WLAN card in its slot in the computer.
2. Tighten the screw to secure the WLAN card to the computer.
3. Route through the routing channel and connect them to the WLAN card.
4. Install the:
  - a) base cover
  - b) battery
5. Follow the procedures in *After Working Inside Your Computer*.

## Removing Wireless Wide Area Network (WWAN) Card (Optional)

1. Follow the procedures in *Before Working Inside Your Computer*.
2. Remove the:
  - a) battery
  - b) base cover
3. Route and disconnect and remove the antenna cables connected to the WWAN card. Remove the screw that secures the WWAN card to the computer. Remove the WWAN card from the computer.

 **NOTE:** The location of the WWAN card may vary from what is displayed in the illustrations.



## Installing the Wireless Wide Area Network (WWAN) Card (Optional)

1. Slide the WWAN card in the WWAN card slot.
2. Tighten the screw to secure the WWAN card to the computer.
3. Route the cables through the routing channels and connect them to the WWAN card.
4. Install the:
  - a) base cover
  - b) battery
5. Follow the procedures in *After Working Inside Your Computer*.

## Removing the Optical Drive

1. Follow the procedures in *Before Working Inside Your Computer*.
2. Remove the:
  - a) battery
  - b) base cover
3. Remove the screw that secures the optical drive to the computer.

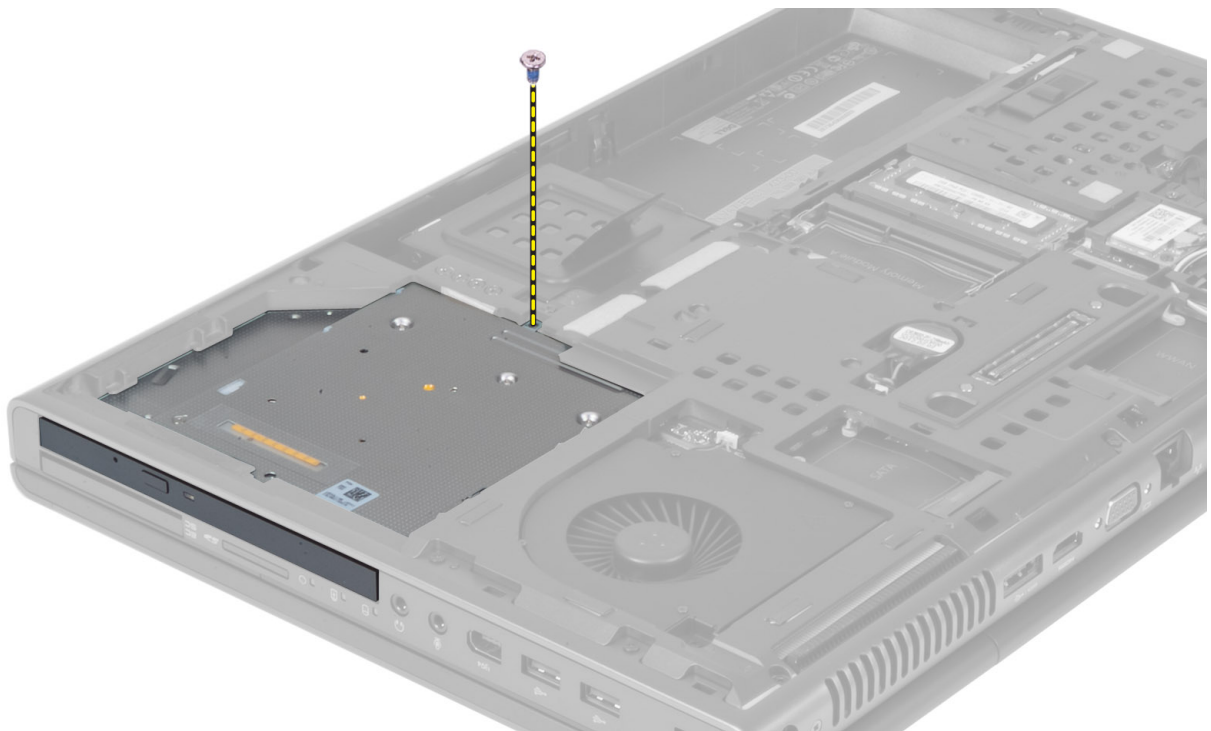

4. Pry and slide out the optical drive to remove it from the computer.



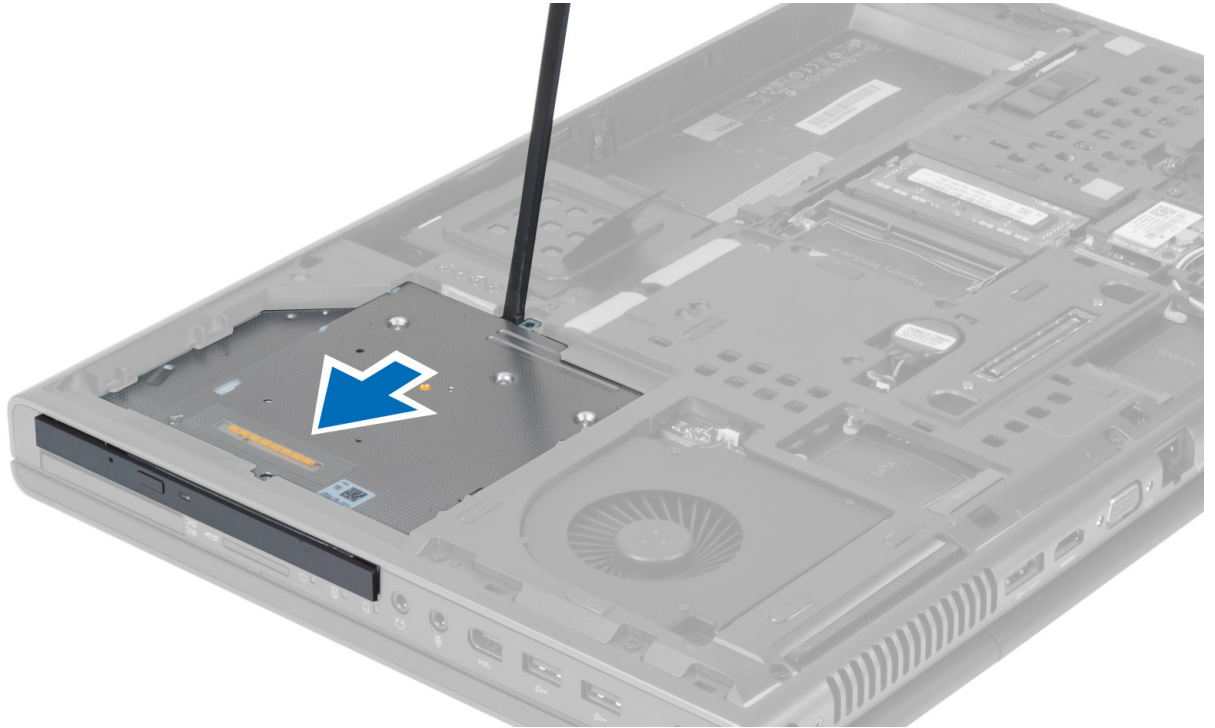

5. Remove the screws that secure the drive-latch bracket to the optical drive and remove the bracket.

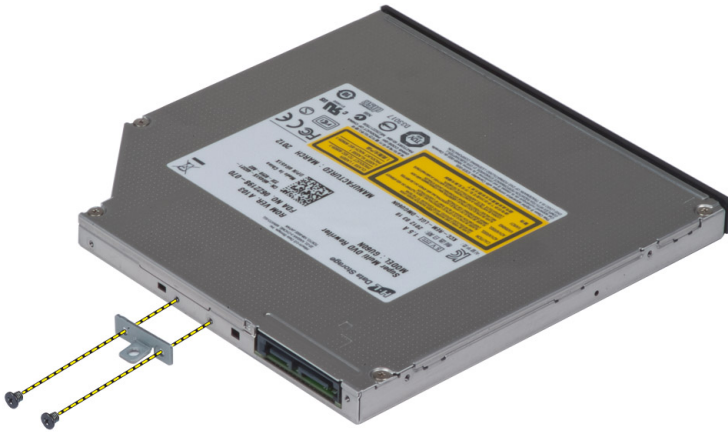

## Installing the Optical Drive

1. Tighten the screw to secure the drive-latch bracket to the optical drive.
2. Slide the optical drive into its slot and tighten the screw to secure the optical drive to the computer.
3. Install the:
  - a) battery
  - b) base cover
4. Follow the procedures in *After Working Inside Your Computer*.

## Removing the Primary Hard Drive

1. Follow the procedures in *Before Working Inside Your Computer*.
2. Remove the:
  - a) battery
  - b) base cover
3. Remove the screws that secure the primary hard drive to the computer. Slide the primary hard drive latch to the unlock position and pull out the hard drive from the computer.

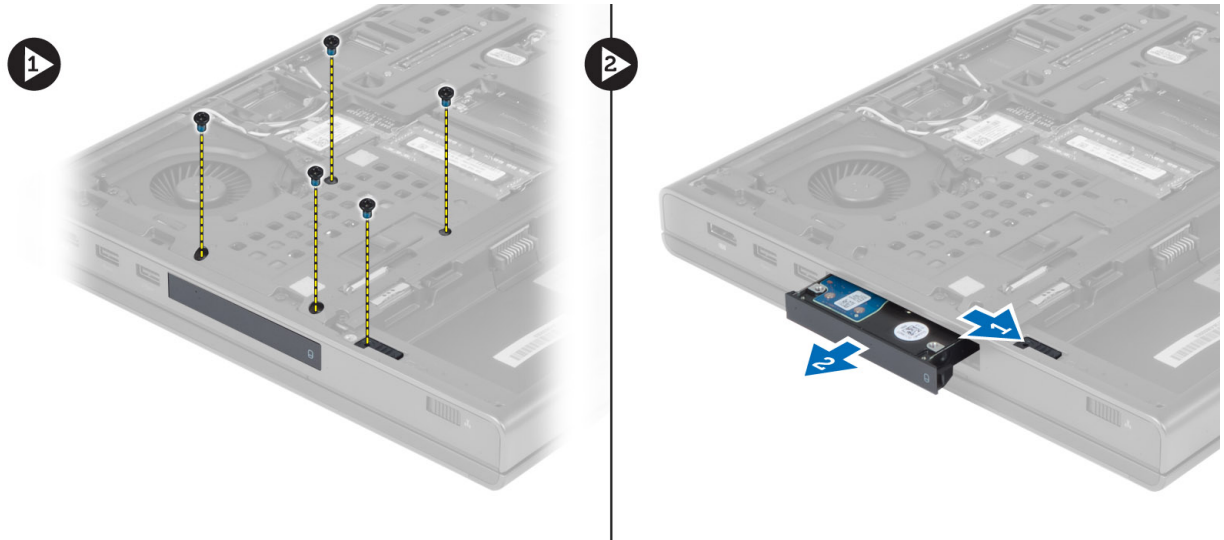

4. Flex the hard-drive bracket outward and pull out the hard drive from the bracket.



 **NOTE:** A rubber filler is installed to the hard-drive bracket for 7 mm hard drives. It is designed to prevent vibrations and for correct installation of the 7 mm hard drives. 9 mm hard drives does not require the filler when installed into hard-drive bracket.

## Installing the Primary Hard Drive

1. Engage the primary hard drive bracket to the primary hard .
2. Insert the primary hard drive into its slot in the computer till it clicks in place.
3. Tighten the screw to secure the primary hard drive to the computer.
4. Install the:
  - a) base cover
  - b) battery
5. Follow the procedures in *After Working Inside Your Computer*.

## Removing the Secondary Hard Drive

1. Follow the procedures in *Before Working Inside Your Computer*.
2. Remove the:
  - a) battery
  - b) base cover
3. Remove the screw that secure that secondary hard drive in place.
4. Pull the tab upward and remove the secondary hard drive from the computer.

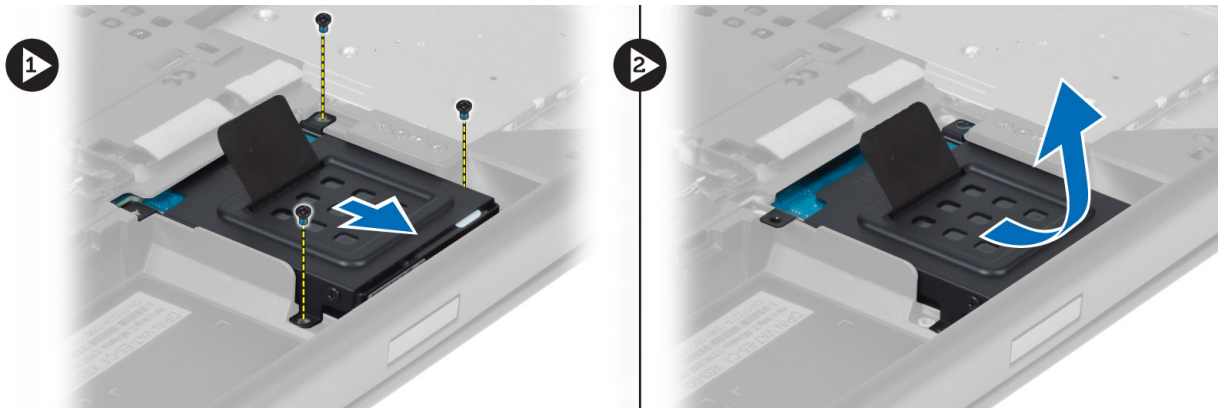

5. Remove the screw that secure secondary hard drive to the bracket.
6. Remove the secondary hard drive from the bracket.



## Installing the Secondary Hard Drive

1. Engage the secondary hard drive bracket to the secondary hard drive.
2. Tighten the screw that secure the secondary hard drive bracket.
3. Install the secondary hard drive into the computer.
4. Tighten the screw that secure the secondary hard drive in the computer.
5. Install the:
  - a) base cover
  - b) battery
6. Follow the procedures in *After Working Inside Your Computer*.

## Removing the Coin-Cell Battery

1. Follow the procedures in *Before Working Inside Your Computer*.
2. Remove the:
  - a) battery
  - b) base cover
3. Disconnect the coin-cell battery cable. Pry the coin-cell battery upward and remove it from the computer.

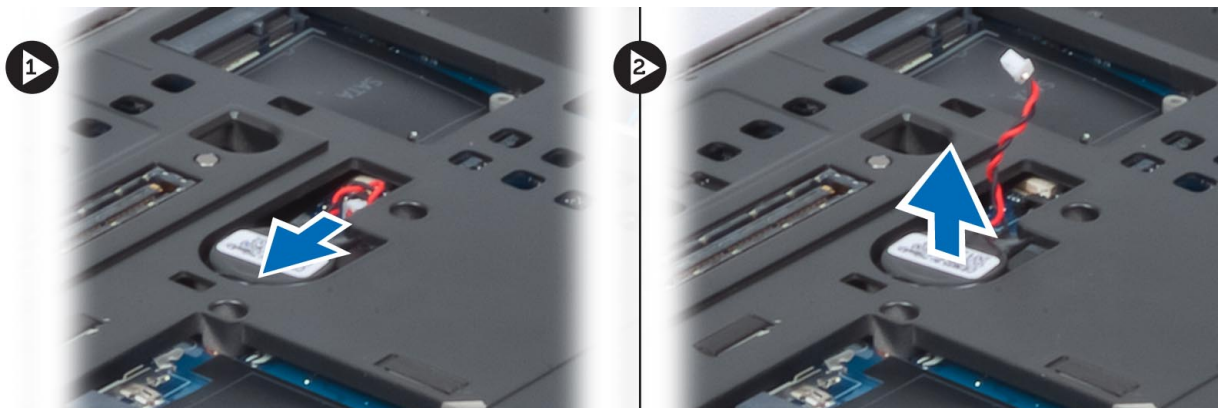

## Installing the Coin-Cell Battery

1. Replace the coin-cell battery in its slot in the computer.
2. Connect the coin-cell battery cable.
3. Install the:
  - a) base cover
  - b) battery
4. Follow the procedures in *After Working Inside Your Computer*.

## Removing the Processor Fan

1. Follow the procedures in *Before Working Inside Your Computer*.
2. Remove the:
  - a) battery
  - b) base cover
3. Remove the screws that secure the processor fan to the computer. Remove the processor fan from the computer.

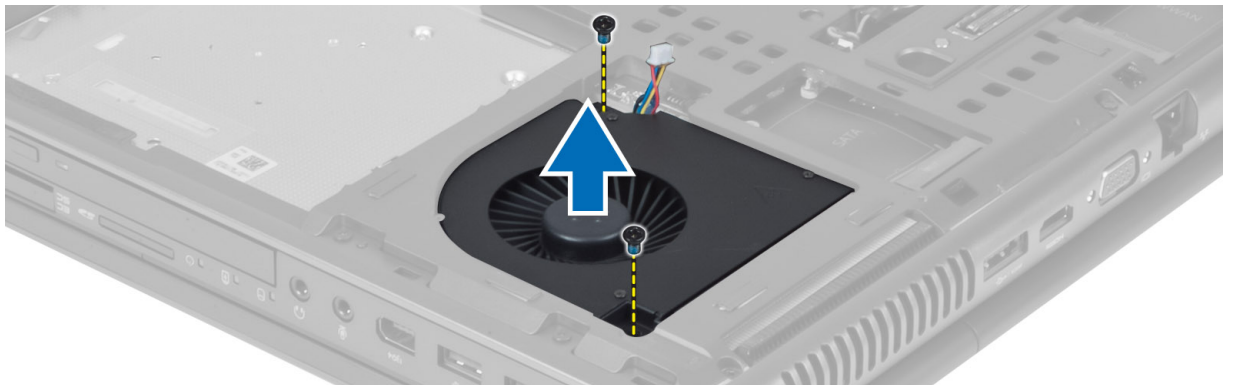

4. Disconnect the processor-fan cable.



## Installing the Processor Fan

1. Connect the processor-fan cable.
2. Insert the processor fan into its slot in the computer.
3. Tighten the screws that secure the processor fan to the computer.
4. Install the:
  - a) base cover
  - b) battery
5. Follow the procedures in *After Working Inside Your Computer*.

## Removing the Video-Card Fan

1. Follow the procedures in *Before Working Inside Your Computer*.
2. Remove the:
  - a) battery
  - b) base cover
3. Disconnect the video-card fan cable. Remove the screws that secure the video-card fan to the computer. Remove the video-card fan from the computer.

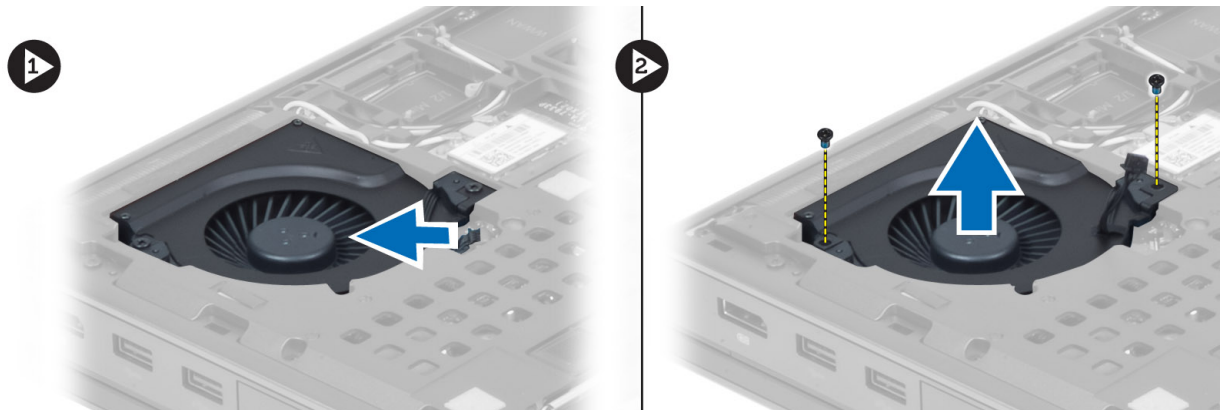

## Installing the Video-Card Fan

1. Insert the video-card fan into its slot and tighten the screws to secure it to the computer.
2. Connect the video-card fan cable.
3. Install the:
  - a) base cover
  - b) battery
4. Follow the procedures in *After Working Inside Your Computer*.

## Removing the Keyboard Trim

1. Follow the procedures in *Before Working Inside Your Computer*.
2. Remove the battery.
3. Pry up the keyboard trim starting from the top-inner edge.

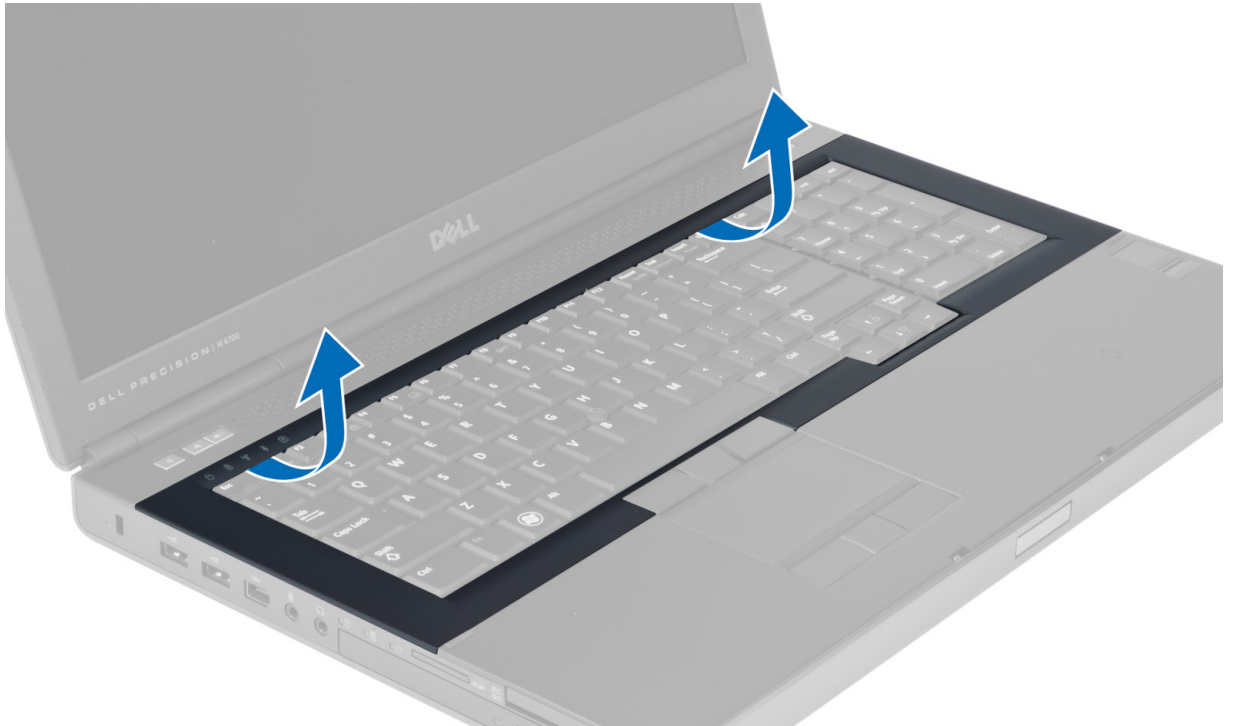

4. Pry up the bottom edge of the keyboard trim from the top-inner edge.

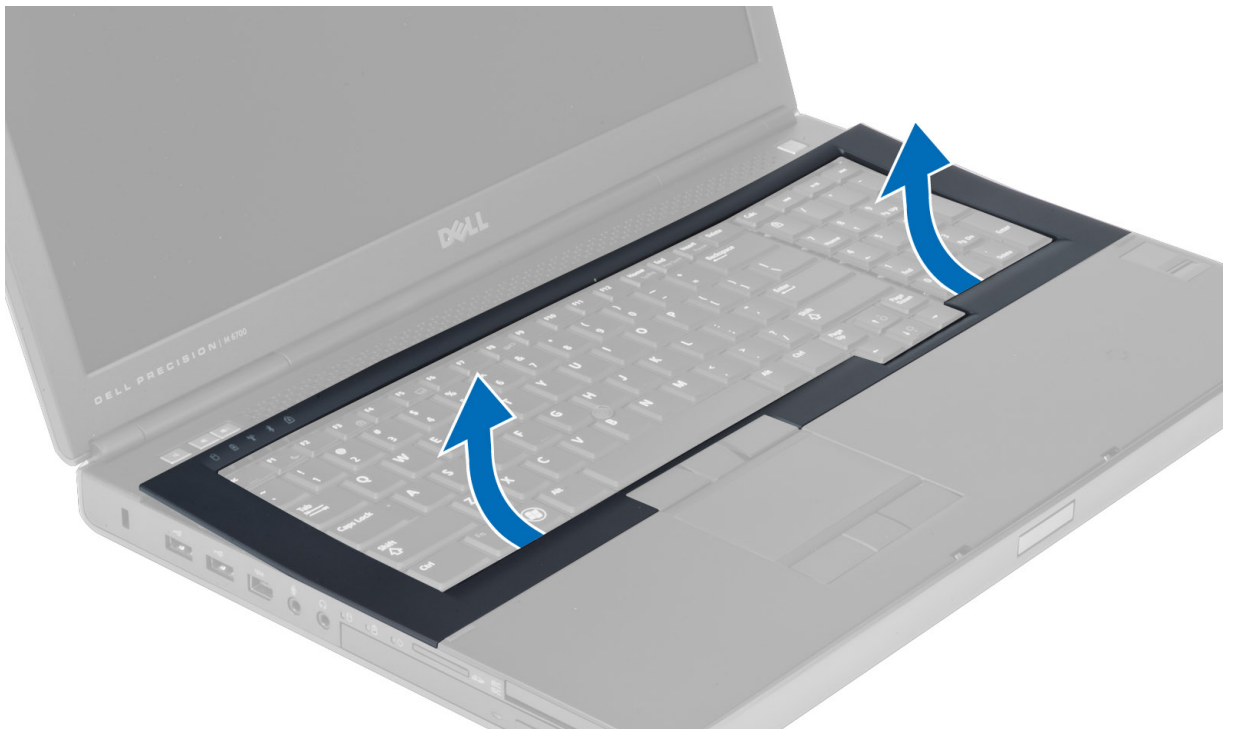

## Installing the Keyboard Trim

1. Align the keyboard trim to its compartment starting from the front.
2. Press along the sides of the keyboard trim until it snaps in place.
3. Install the battery.
4. Follow the procedures in *After Working Inside Your Computer*.

## Removing the Keyboard

1. Follow the procedures in *Before Working Inside Your Computer*.
2. Remove the:
  - a) battery
  - b) keyboard trim
3. Remove the screws that secure the keyboard to the computer.



4. Starting from the bottom of the keyboard, separate the keyboard from the computer and flip the keyboard over.





5. Disconnect the keyboard-data cable from the system board and remove the keyboard.

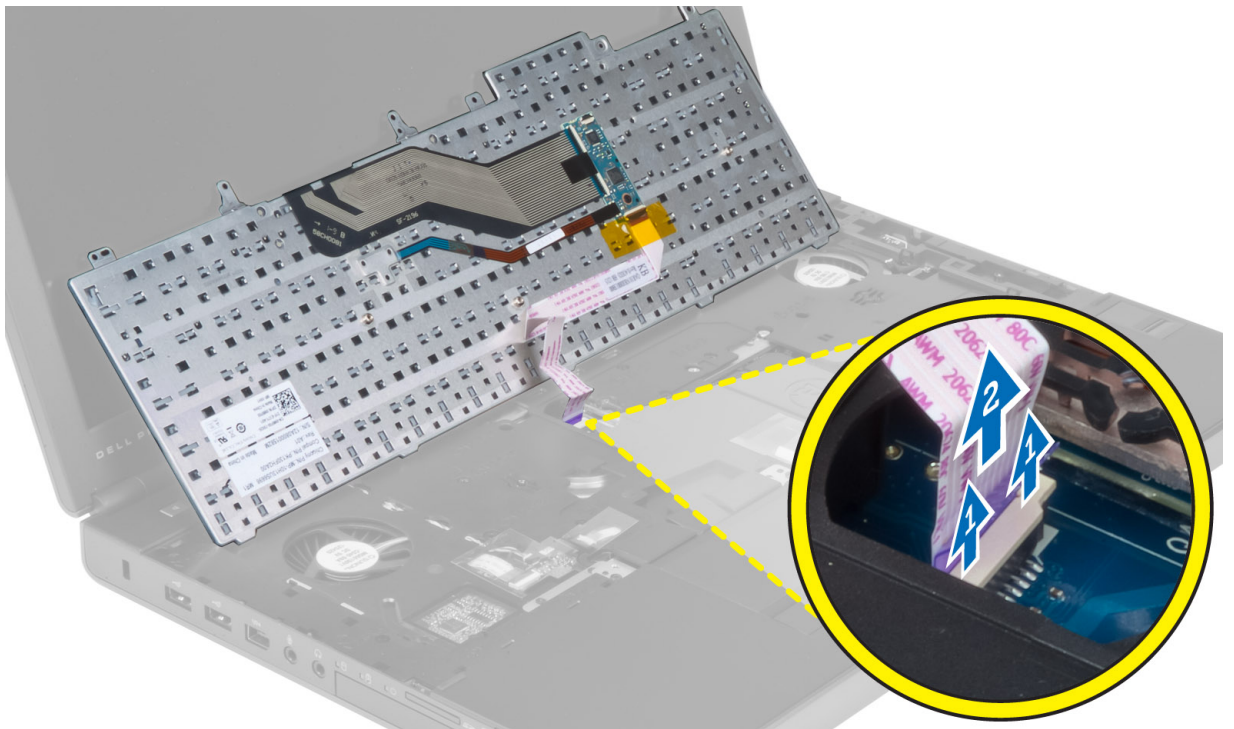

## Installing the Keyboard

1. Connect the keyboard-data cable to the system board.
  -  **NOTE:** Ensure that you fold the keyboard-data cable in perfect alignment.
2. Press the keyboard in its compartment.
3. Tighten the screws to secure the keyboard to the computer.
4. Press over the cross section of the following keys to secure the keyboard to the computer:
  - a) <R> , <T> , <F> and <G> keys
  - b) over the <9> key
  - c) NUMLOCK <9> key



5. Install the:
  - a) keyboard trim
  - b) battery
6. Follow the procedures in *After Working Inside Your Computer*.

## Removing the Primary Memory

1. Follow the procedures in *Before Working Inside Your Computer*.
2. Remove the:
  - a) battery
  - b) base cover
3. Pry the retention clips away from the primary memory until it pops up. Lift the primary memory and remove it from the computer.

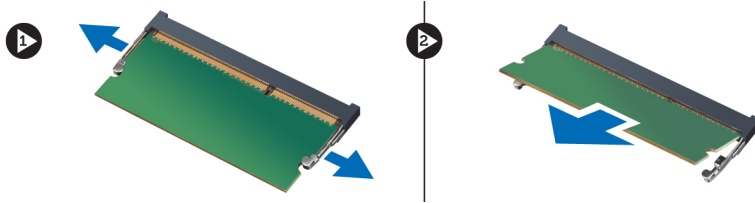

## Installing the Primary Memory

1. Insert the primary memory into the memory socket.
2. Press the clips to secure the primary memory to the system board.
3. Install the:
  - a) base cover
  - b) battery
4. Follow the procedures in *After Working Inside Your Computer*.

## Removing the Secondary Memory

1. Follow the procedures in *Before Working Inside Your Computer*.
2. Remove the:
  - a) battery
  - b) keyboard trim
  - c) keyboard
3. Remove the screw that secures the memory shield to the computer and remove the memory shield.

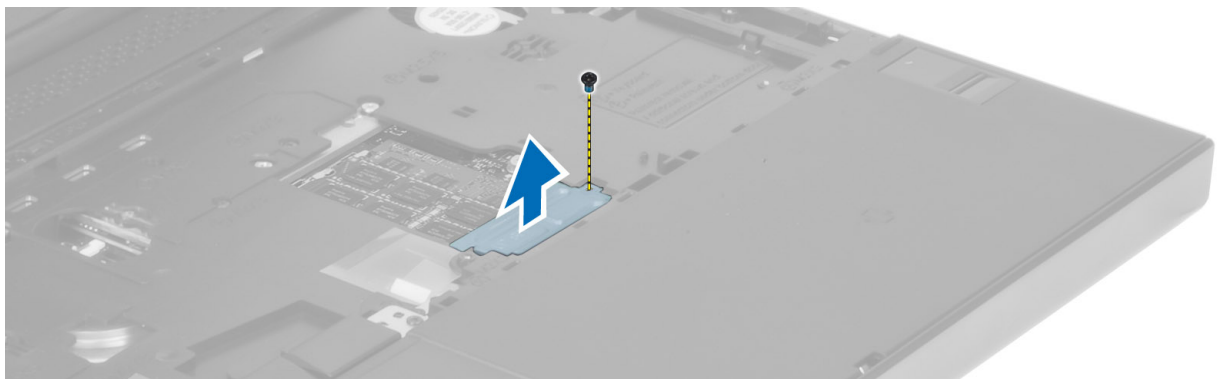

4. Pry the retention clips away from the memory module until it pops up. Lift up the memory module and remove it from the computer.

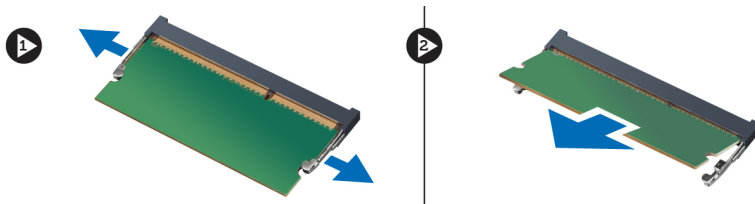

## Installing the Secondary Memory

1. Insert the secondary memory into the memory socket.
2. Press the clips to secure the memory module to the system board.
3. Place the memory shield in its original position on the computer and tighten the screw to secure it to the computer.
4. Install the:
  - a) keyboard
  - b) keyboard trim
  - c) battery
5. Follow the procedures in *After Working Inside Your Computer*.

## Removing the Bluetooth Module

1. Follow the procedures in *Before Working Inside Your Computer*.
2. Remove the:
  - a) battery
  - b) base cover
3. Disconnect and un-route the bluetooth cable. Slide the bluetooth door upward to release it.

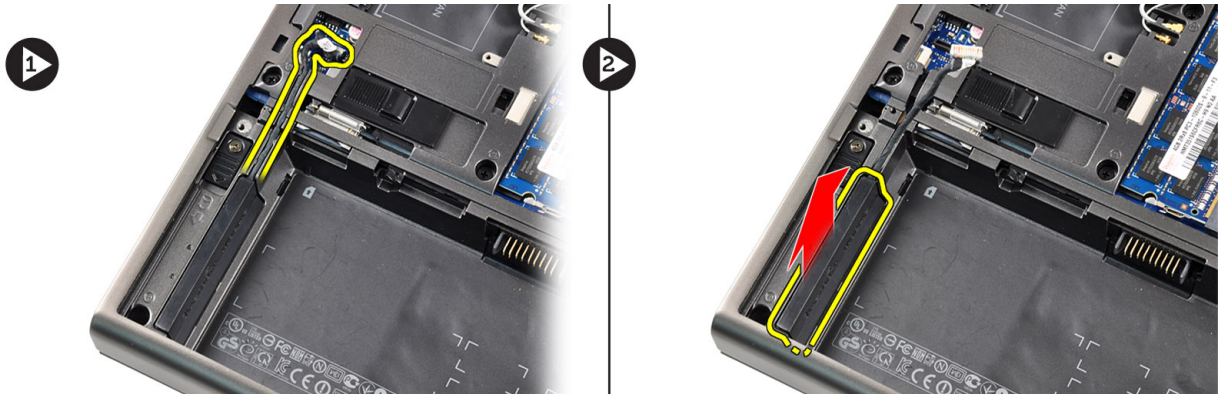

4. Remove the bluetooth module from the computer. Remove the screw that secures the bluetooth module in place.

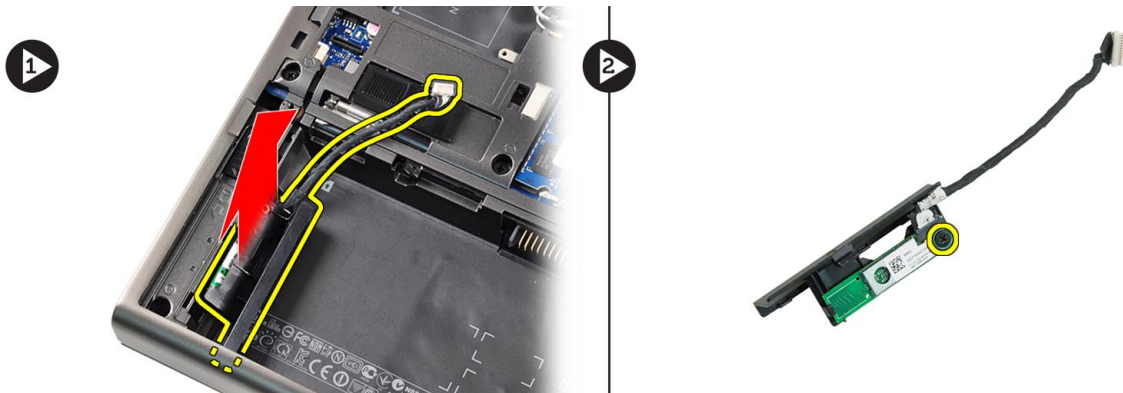

5. Remove the bluetooth module. Disconnect and remove the bluetooth cable from the module.

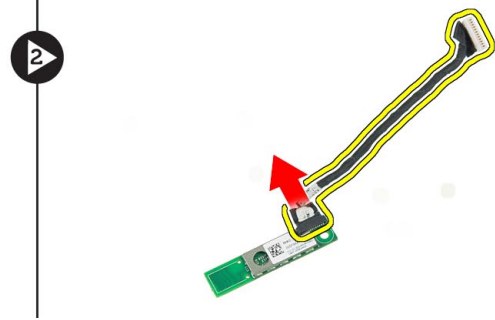

## Installing the Bluetooth Module

1. Connect the bluetooth cable to the bluetooth module.
2. Tighten the screw to secure the bluetooth module in place.
3. Insert the bluetooth module in its slot and press down the bluetooth door.
4. Route and connect the bluetooth cable.
5. Install the:
  - a) base cover
  - b) battery
6. Follow the procedures in *After Working Inside Your Computer*.

## Removing the Display Bezel

1. Follow the procedures in *After Working Inside Your Computer*.
2. Remove the battery.
3. Pry up the bottom edge of the display bezel.

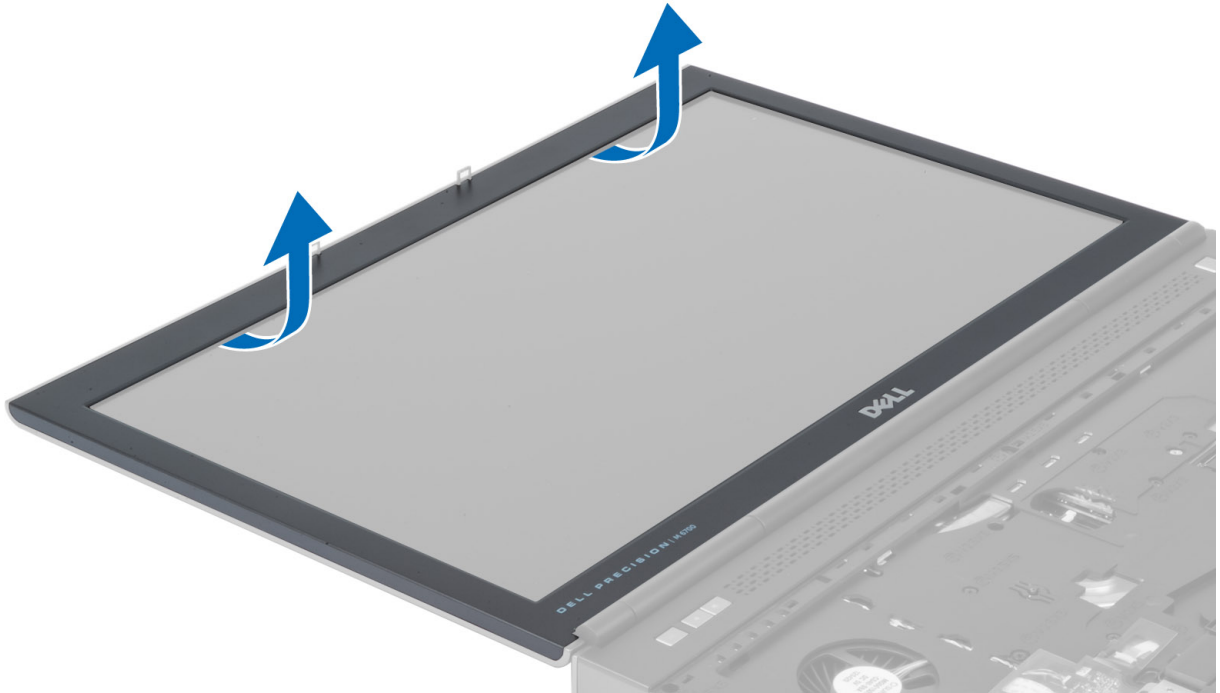

4. Work your way around the sides and top edge of the display bezel and remove the display bezel from the computer .

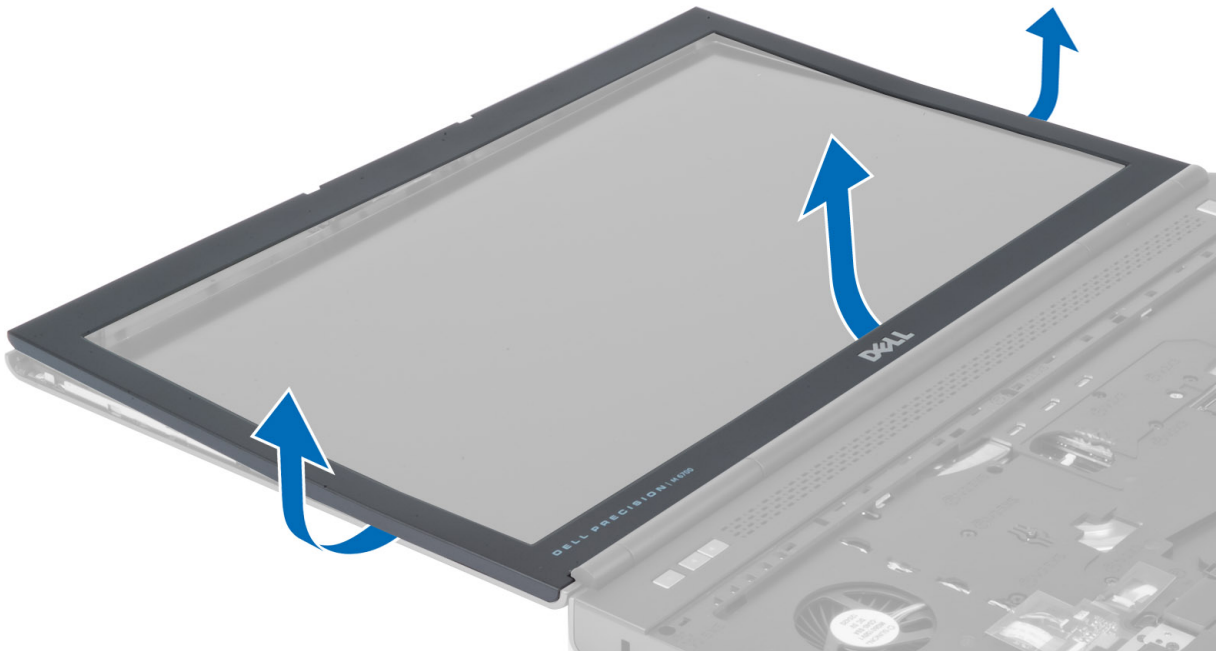

## Installing the Display Bezel

1. Toe-in the display bezel from the bottom and press on the display bezel.
2. Work around the entire bezel until it snaps onto the display assembly.
3. Install the battery.
4. Follow the procedures in *After Working Inside Your Computer*.

## Removing the Camera

1. Follow the procedures in *Before Working Inside Your Computer*.
2. Remove the:
  - a) battery
  - b) display bezel
3. Disconnect the camera cable. Remove the screw that secures the camera module to the computer. Remove the camera module from the computer.

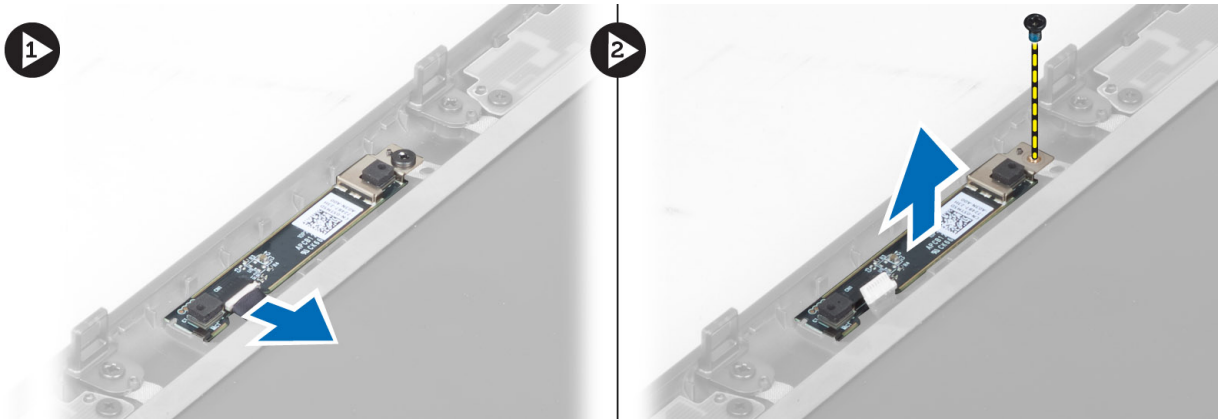

## Installing the Camera

1. Place the camera module in its slot on the computer.
2. Tighten the screw to secure the camera module to the computer.
3. Connect the camera cable.
4. Install the:
  - a) display bezel
  - b) battery
5. Follow the procedures in *After Working Inside Your Computer*.

## Removing the Display Panel

1. Follow the procedures in *Before Working Inside Your Computer*.
2. Remove the:
  - a) battery
  - b) display bezel
3. Remove the screw that secures the display panel to the display assembly. Flip the display panel over.

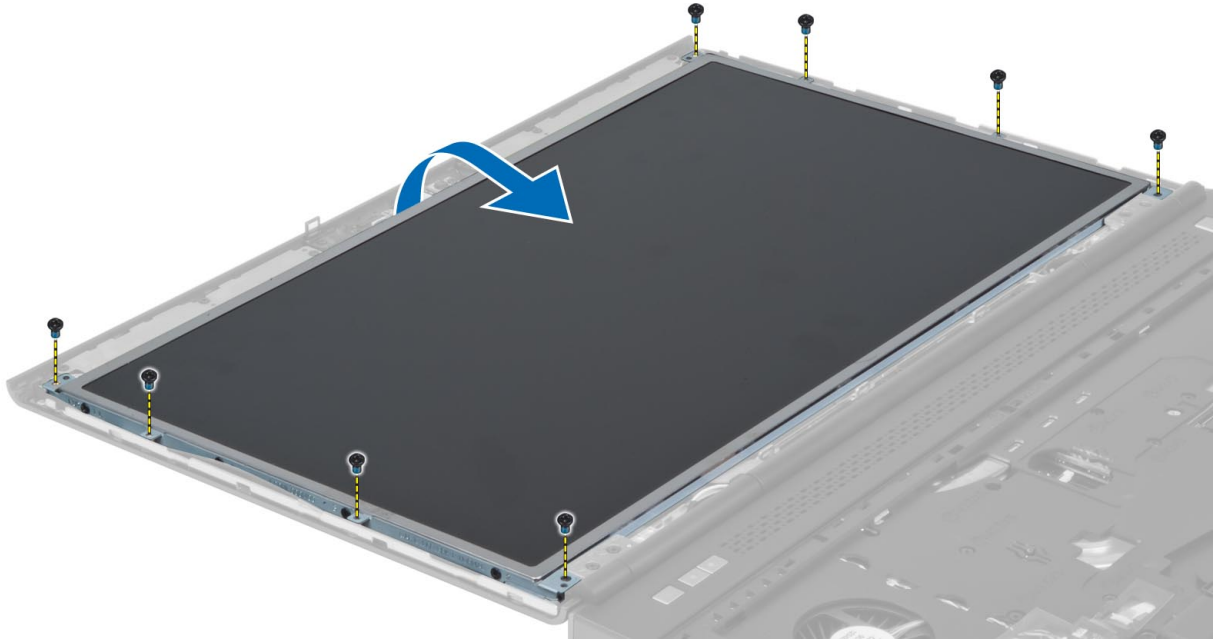

4. Peel back the adhesive tape that secures the LVDS cable to the display panel.

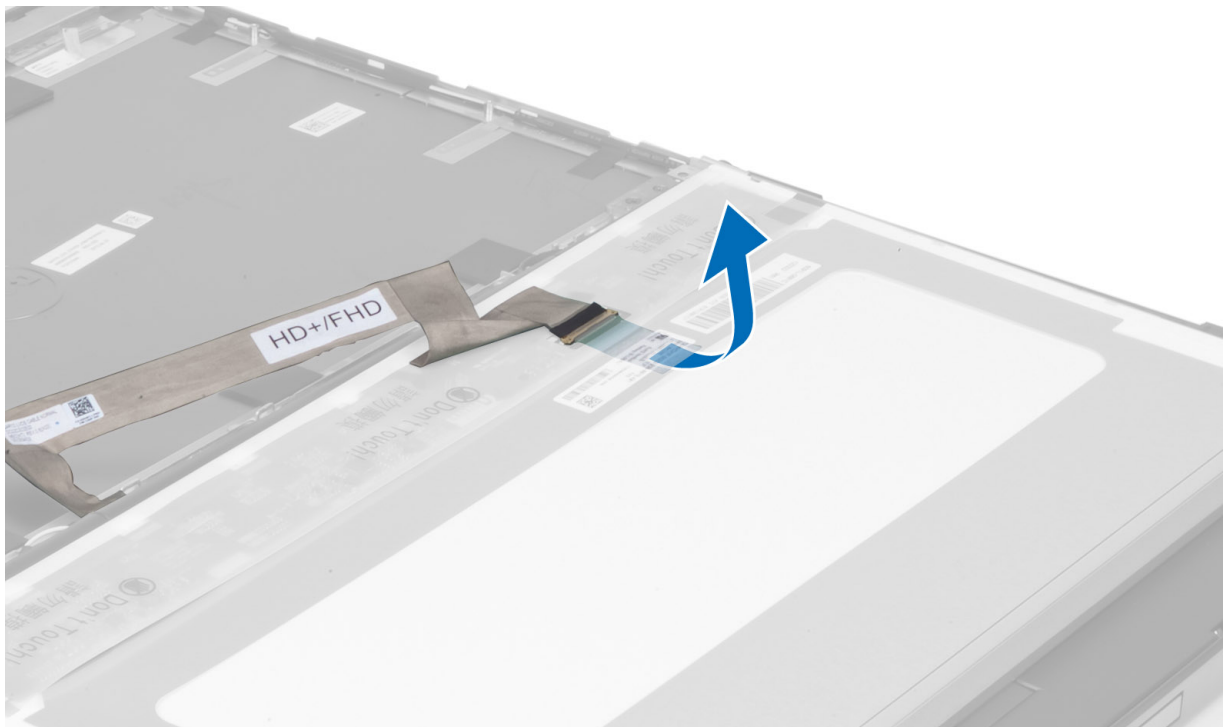

5. Disconnect the LVDS cable.



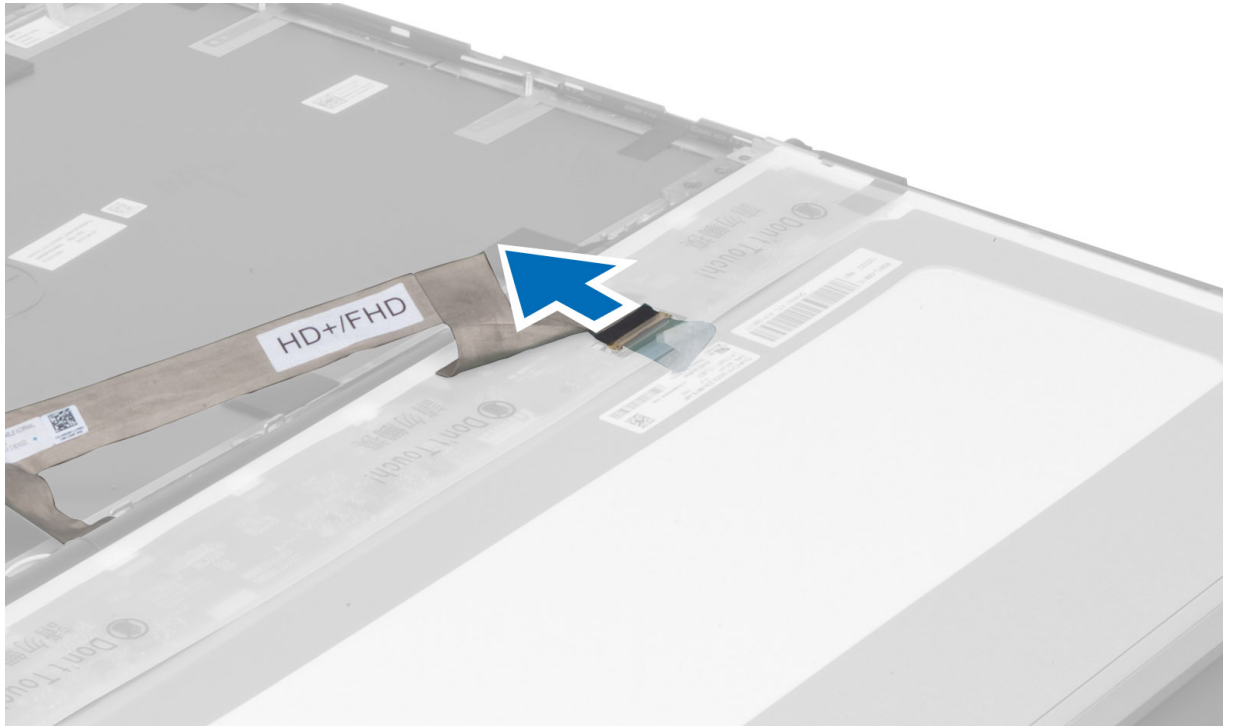

6. Remove the screws that secure the display brackets to the display panel. Remove the display brackets.

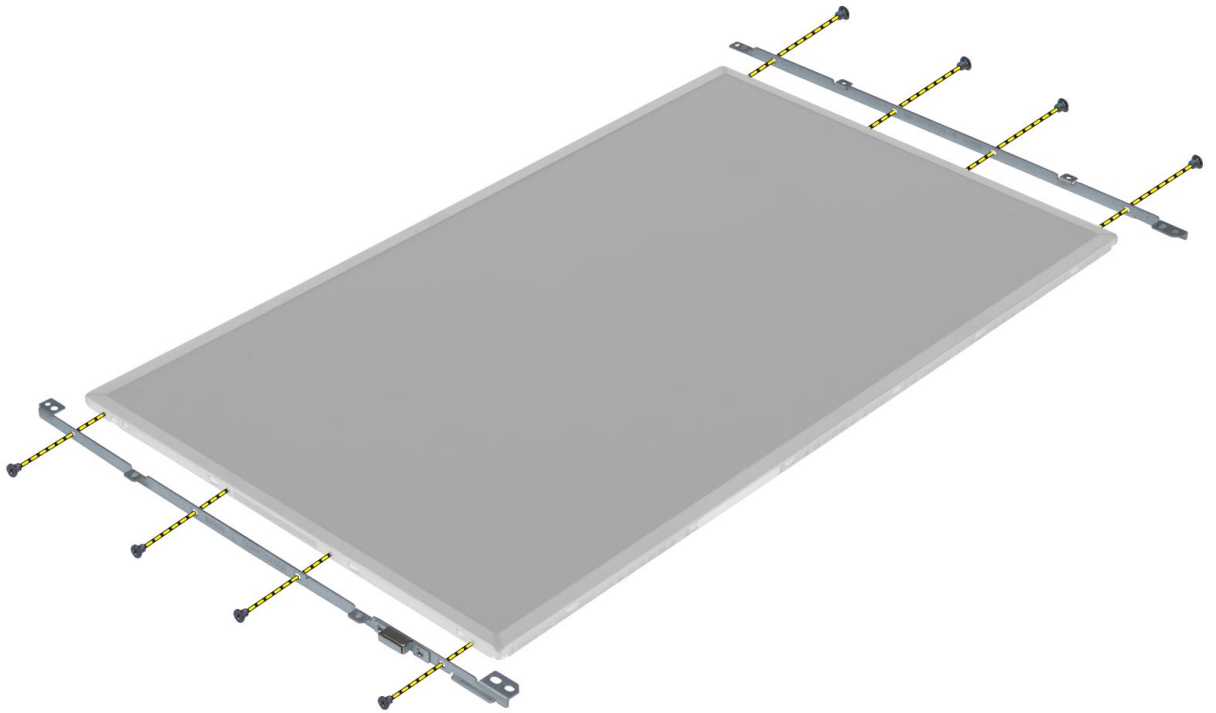

- 7.

## Installing the Display Panel

1. Align the display brackets to the display panel.
2. Tighten the screws to secure the display brackets to the display panel.
3. Connect the LVDS cable and affix the adhesive tape.
4. Align the display panel in its original position on the computer.
5. Tighten the screws to secure the display panel to the display assembly.
6. Install the:
  - a) display bezel
  - b) battery
7. Follow the procedures in *After Working Inside Your Computer*.

## Removing the Palmrest

1. Follow the procedures in *Before Working Inside Your Computer*.
2. Remove the:
  - a) battery
  - b) base cover
  - c) keyboard trim
  - d) keyboard
  - e) optical drive
  - f) primary hard drive
  - g) secondary hard drive
3. Peel back the adhesive tape that secures the smart card cable to the palmrest.

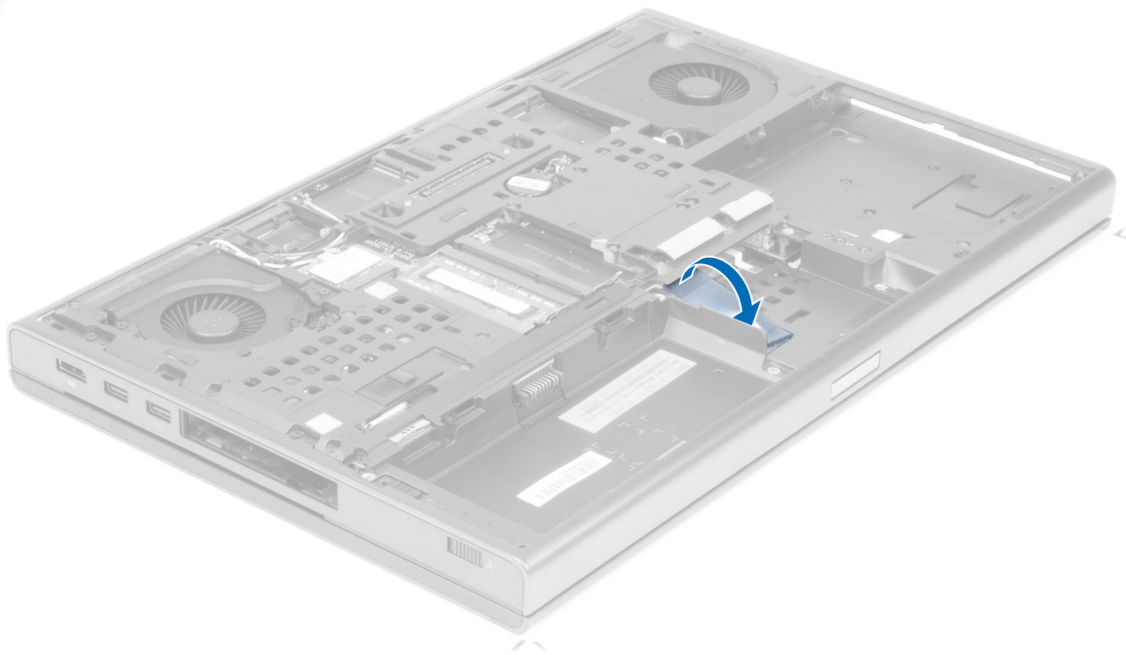

4. Disconnect the smart card cable.

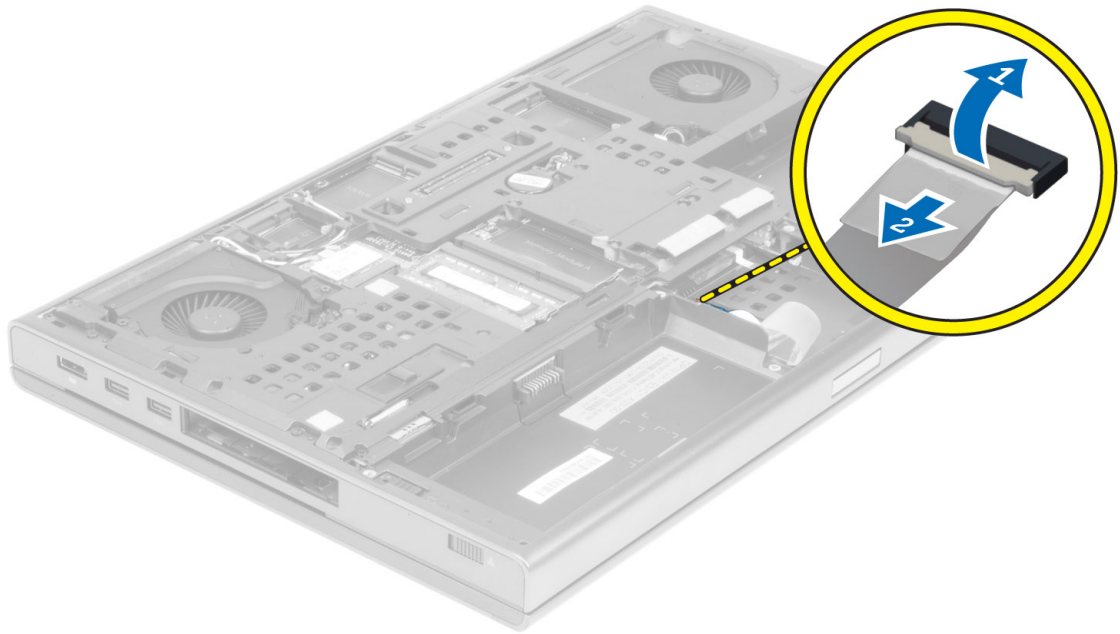

5. Remove the screws at the bottom of the computer.

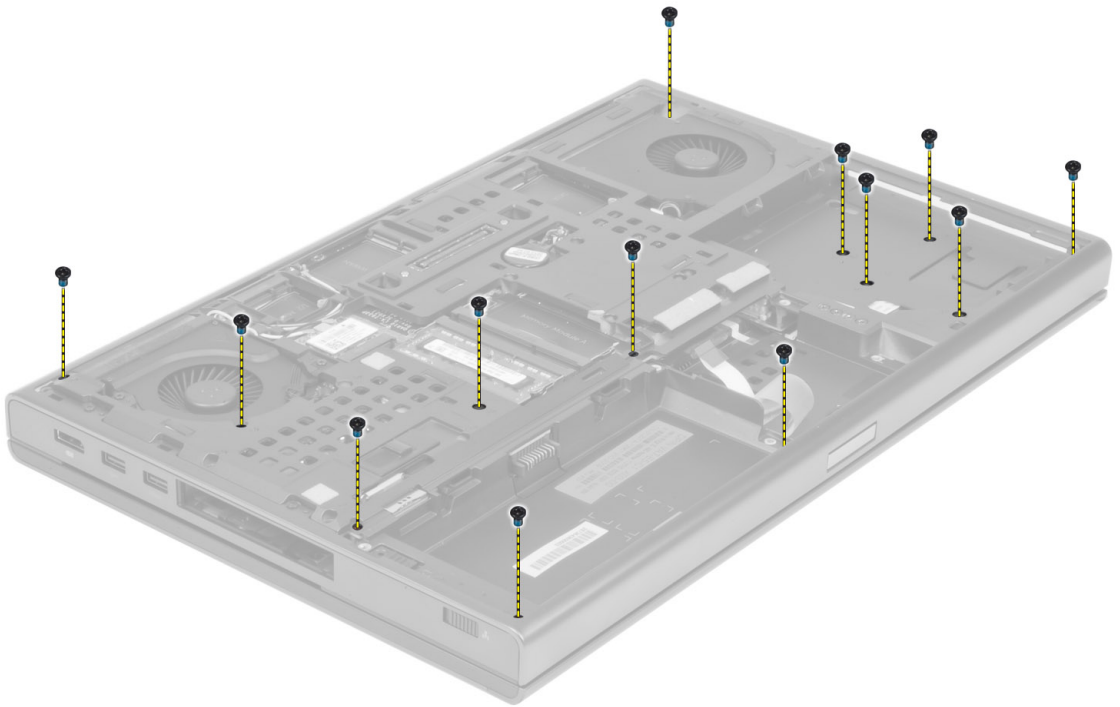

6. Peel the adhesive tape that secures the media board cable and speaker cable to the palmrest.

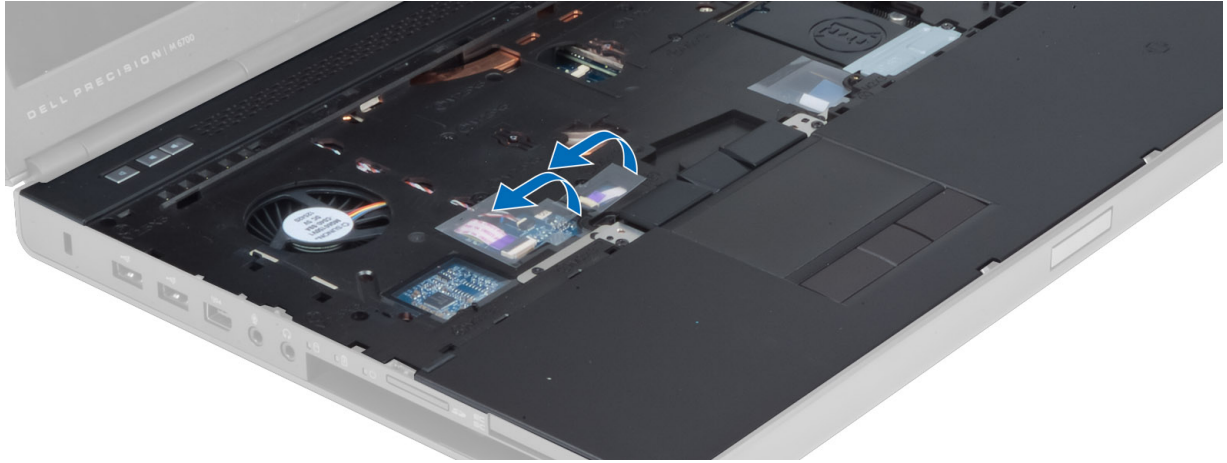

7. Disconnect the media board cable and the speaker cable.

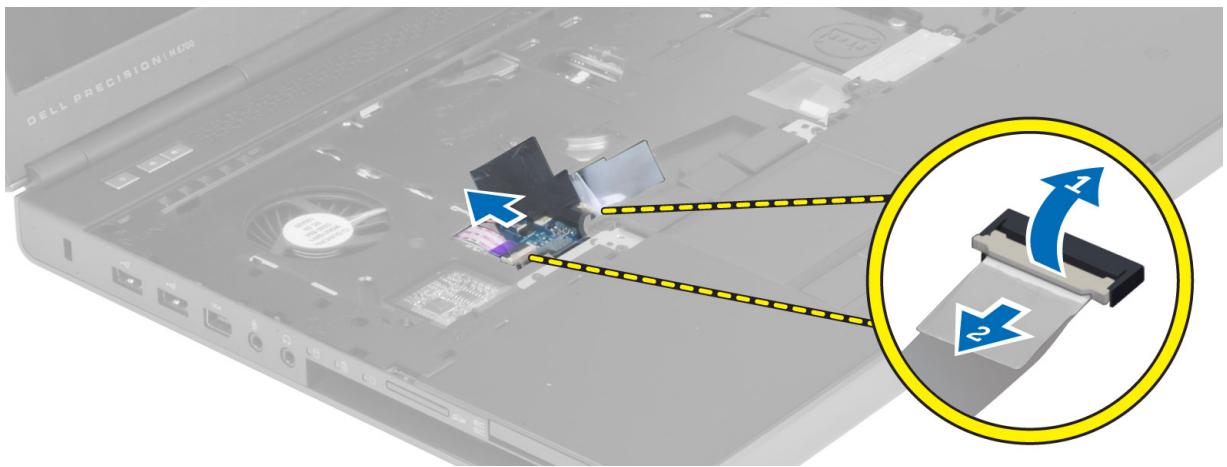

8. Peel the adhesive tape that secures the touchpad cable to the palmrest.

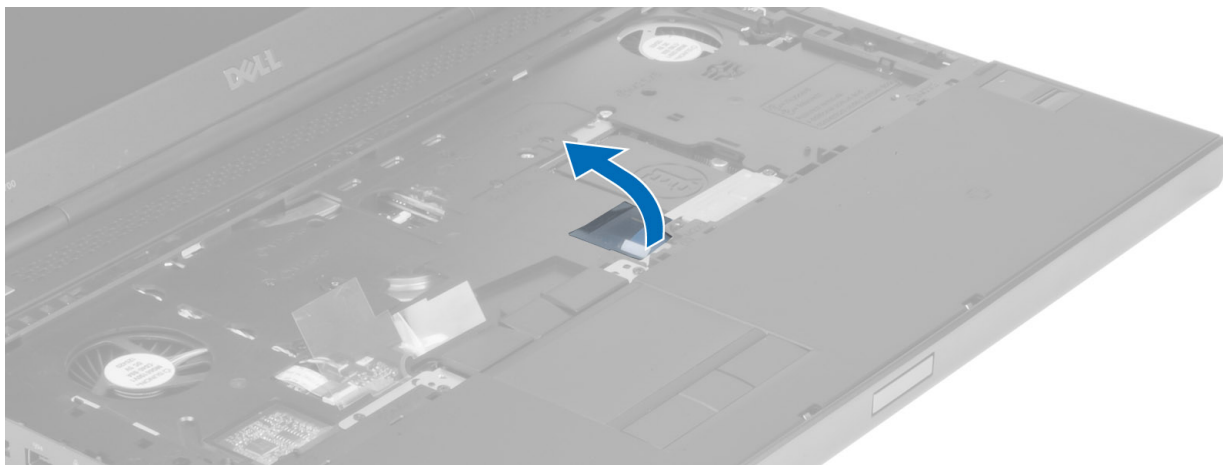

9. Disconnect the touchpad cable.

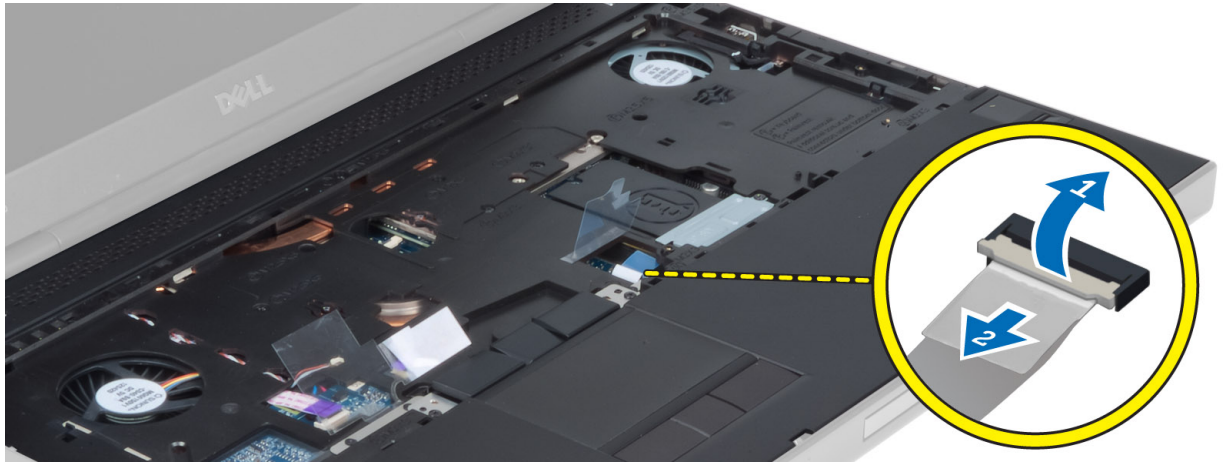

10. Disconnect the power button cable.



11. Disconnect the bluetooth module cable.



12. Remove the screw that secure the palmrest to the computer.

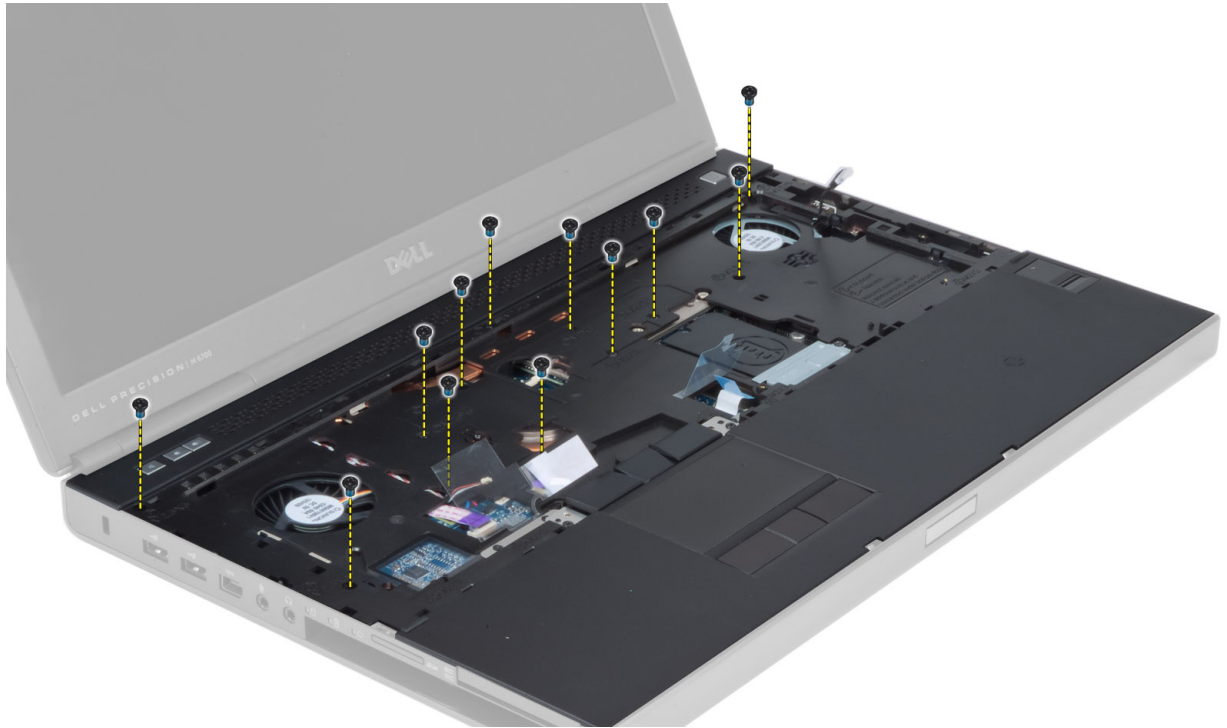

13. Lift the left edge of the palmrest. Release the tabs on the right edge of the palmrest and remove the palmrest from the computer.

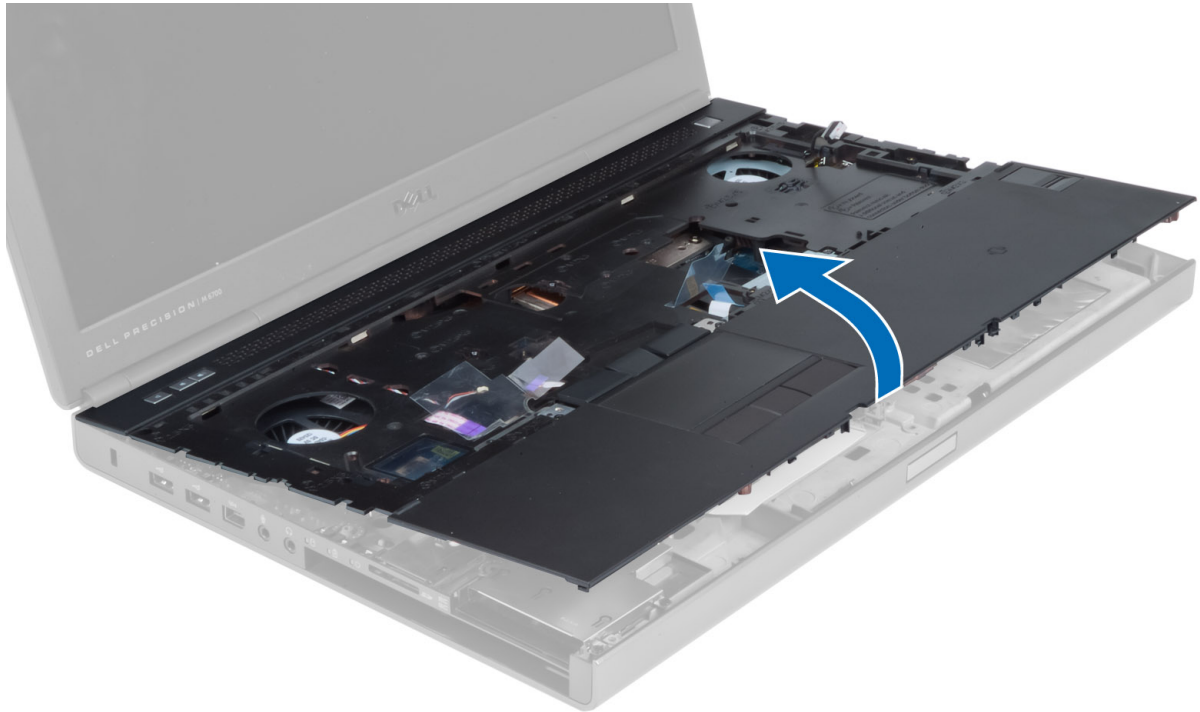

## Installing the Palmrest

1. Align the palmrest to its original position on the computer and press on the positions indicated until it snaps in place.
2. Tighten the screw that secures the palmrest to the computer.
3. Connect the following cables:
  - a) bluetooth module
  - b) power button
  - c) touchpad
  - d) media board
  - e) speaker
4. Affix the adhesive tape that secures the media card cable, speaker cable and touchpad cable.
5. Tighten the screw at the bottom of the computer.
6. Connect the smart card cable and affix the adhesive tape that secures it to the palmrest.
7. Install the:
  - a) secondary hard drive
  - b) primary hard drive
  - c) optical drive
  - d) keyboard
  - e) keyboard trim
  - f) base cover
  - g) battery
8. Follow the procedures in *After Working Inside Your Computer*.

## Removing the ExpressCard Module

1. Follow the procedures in *Before Working Inside Your Computer*.
2. Remove the:
  - a) ExpressCard
  - b) battery
  - c) base cover
  - d) keyboard trim
  - e) keyboard
  - f) optical drive
  - g) primary and secondary hard drive
  - h) palm rest
3. Disconnect the ExpressCard cables from both the system board and the smart card.

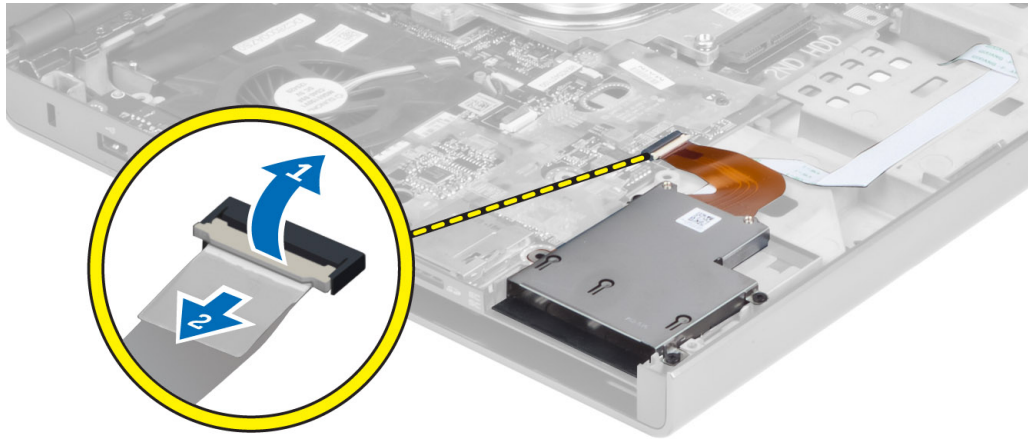

4. Remove the screws that secure the ExpressCard module to the computer and remove the ExpressCard module.

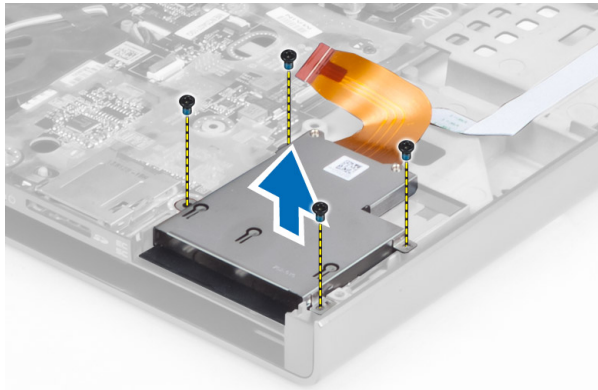

## Installing the ExpressCard Module

1. Insert the ExpressCard module into its compartment.
2. Tighten the screws to secure the ExpressCard module to the computer
3. Connect the ExpressCard cables to the system board and the smart card.
4. Install the:
  - a) palm rest
  - b) primary and secondary hard drive
  - c) optical drive
  - d) keyboard
  - e) keyboard trim
  - f) base cover
  - g) battery
  - h) ExpressCard
5. Follow the procedures in *After Working Inside Your Computer*.

## Removing the Heat Sink

1. Follow the procedures in *Before Working Inside Your Computer*.
2. Remove the:



- a) battery
- b) base cover
- c) keyboard trim
- d) keyboard
- e) optical drive
- f) primary and secondary hard drive
- g) palm rest
- h) processor fan

3. Disconnect the camera cable and loosen the captive screws that secure the heat sink to the computer.

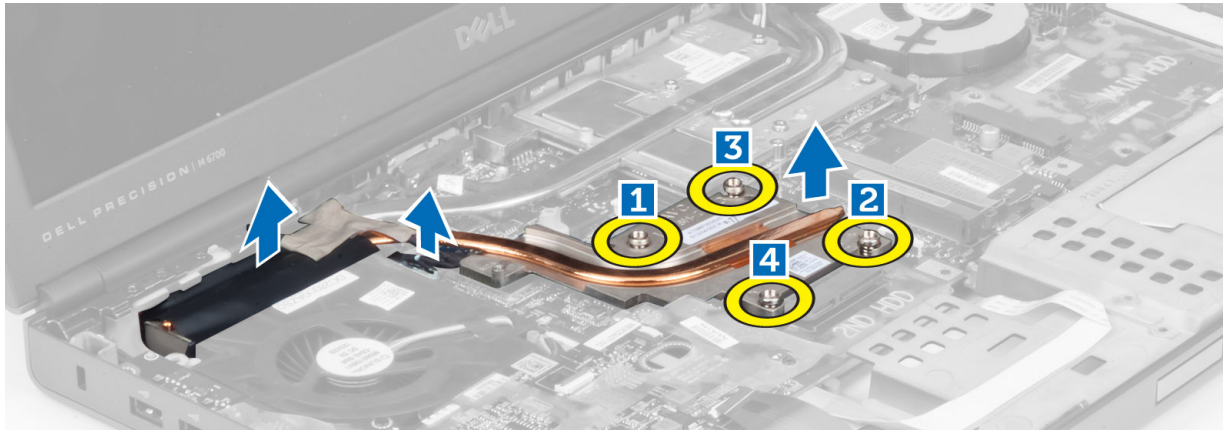

4. Remove the heat sink from the computer.



## Installing the Heat Sink

1. Replace the heat sink in its slot.
2. Tighten the captive screws to secure the heat sink to the computer.
3. Connect the camera cable to the system board.
4. Install the:
  - a) processor fan
  - b) palm rest
  - c) primary and secondary hard drive
  - d) optical drive
  - e) keyboard

- f) keyboard trim
- g) base cover
- h) battery

5. Follow the procedures in *After Working Inside Your Computer*.

## Removing the Processor

1. Follow the procedures in *Before Working Inside Your Computer*.

2. Remove the:

- a) battery
- b) base cover
- c) keyboard trim
- d) keyboard
- e) optical drive
- f) primary and secondary hard drive
- g) palm rest
- h) processor fan
- i) heat sink

3. Rotate the processor cam lock in a counter-clockwise direction. Remove the processor from the computer.

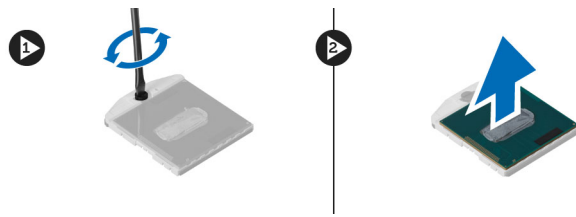

## Installing the Processor

1. Align the notches on the processor and the socket, and insert the processor into the socket.

2. Rotate the processor cam lock in a clockwise direction.

3. Install the:

- a) heat sink
- b) processor fan
- c) palm rest
- d) primary and secondary hard drive
- e) optical drive
- f) keyboard
- g) keyboard trim
- h) base cover
- i) battery

4. Follow the procedures in *After Working Inside Your Computer*.

## Removing the Video-Card Heatsink

1. Follow the procedures in *Before Working Inside Your Computer*.

2. Remove the:

- a) battery

- b) bottom door
- c) keyboard trim
- d) keyboard
- e) optical drive
- f) primary and secondary hard drive
- g) palmrest
- h) video-card fan
- i) heatsink

3. Loosen the captive screws that secures the video-card heatsink to the computer.

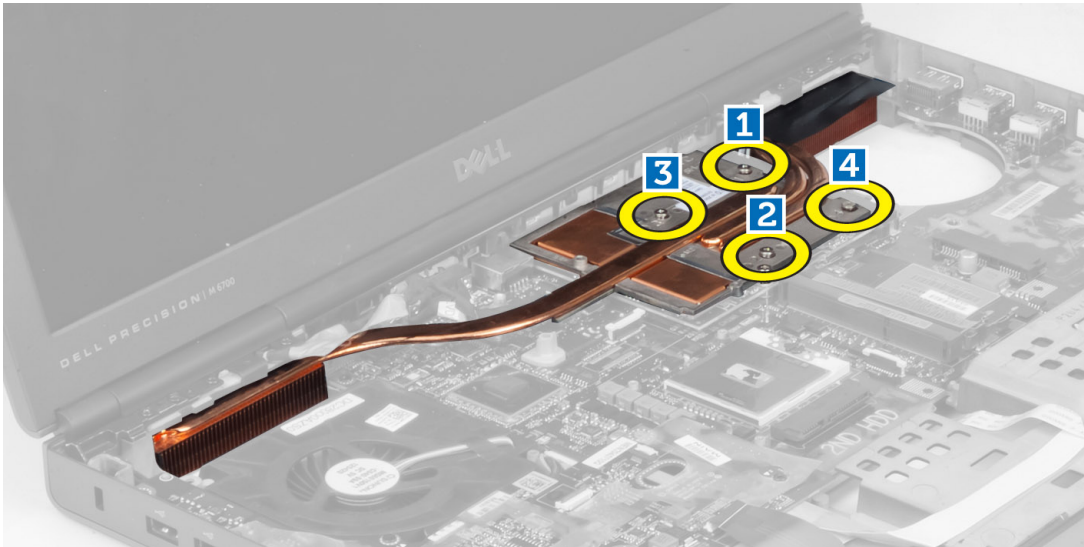

4. Remove the video-card heatsink from the computer.

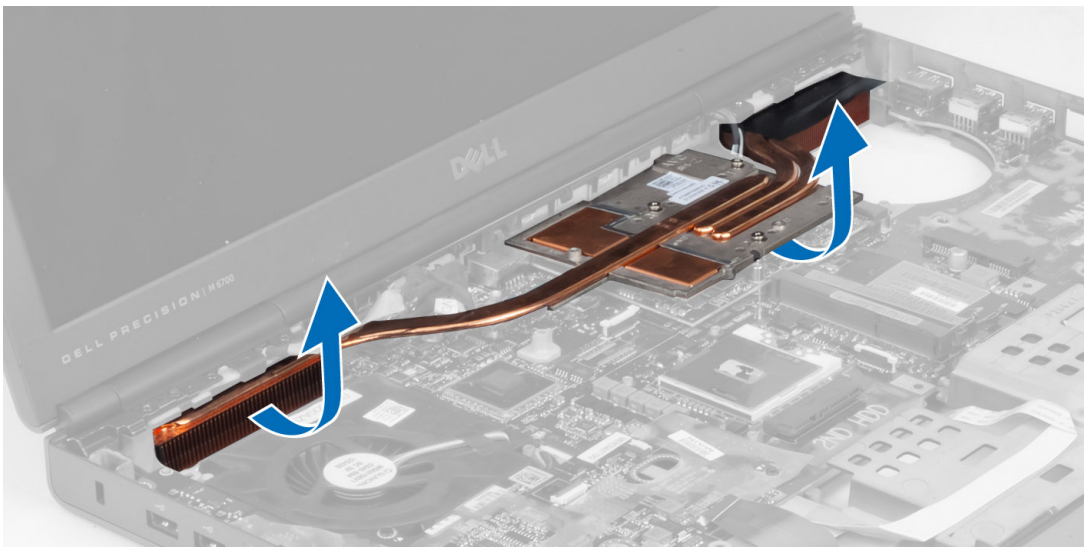

## Installing the Video-Card Heatsink

1. Place the heatsink on its original position in the computer.
2. Tighten the captive screws to secure the heatsink.

3. Install the:
  - a) heatsink
  - b) video-card fan
  - c) palmrest
  - d) primary and secondary hard drive
  - e) optical drive
  - f) keyboard
  - g) keyboard trim
  - h) base cover
  - i) battery
4. Follow the procedures in *After Working Inside Your Computer*.

## Removing the Video Card

1. Follow the procedures in *Before Working Inside Your Computer*.
2. Remove the:
  - a) battery
  - b) base cover
  - c) keyboard trim
  - d) keyboard
  - e) optical drive
  - f) primary and secondary hard drive
  - g) palm rest
  - h) video-card fan
  - i) video-card heat sink
  - j) heatsink
3. Remove the screws that secure the video card to the computer. Remove the video card from the computer.

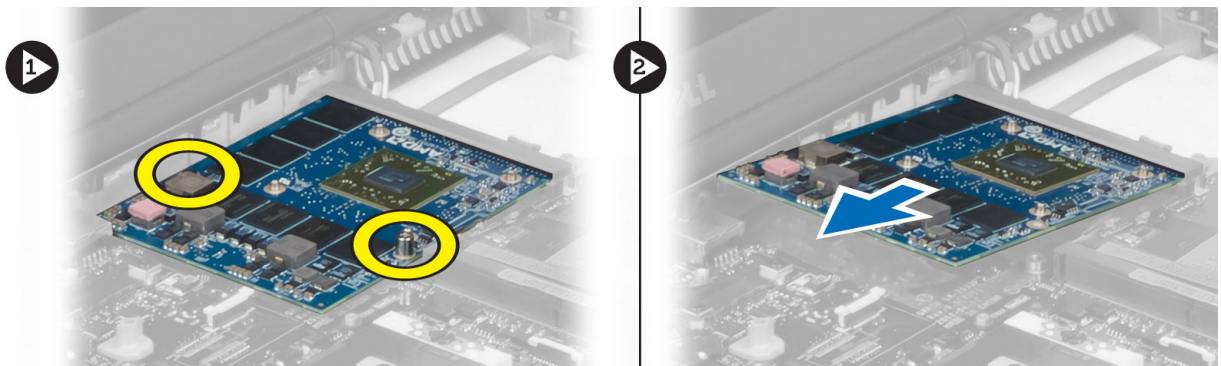

## Installing the Video Card

1. Insert the video card into its slot in the computer.
2. Tighten the screws to secure it to the computer.
3. Install the:
  - a) heatsink
  - b) video-card heat sink
  - c) video-card fan
  - d) palm rest

- e) primary and secondary hard drive
  - f) optical drive
  - g) keyboard
  - h) keyboard trim
  - i) base cover
  - j) battery
4. Follow the procedures in *After Working Inside Your Computer*.

## Removing the Input/Output (I/O) Board

1. Follow the procedures in *Before Working Inside Your Computer*.
2. Remove the:
  - a) SD card
  - b) battery
  - c) base cover
  - d) keyboard trim
  - e) keyboard
  - f) optical drive
  - g) primary and secondary hard drive
  - h) palmrest
3. Disconnect the ExpressCard module connector from the system board.

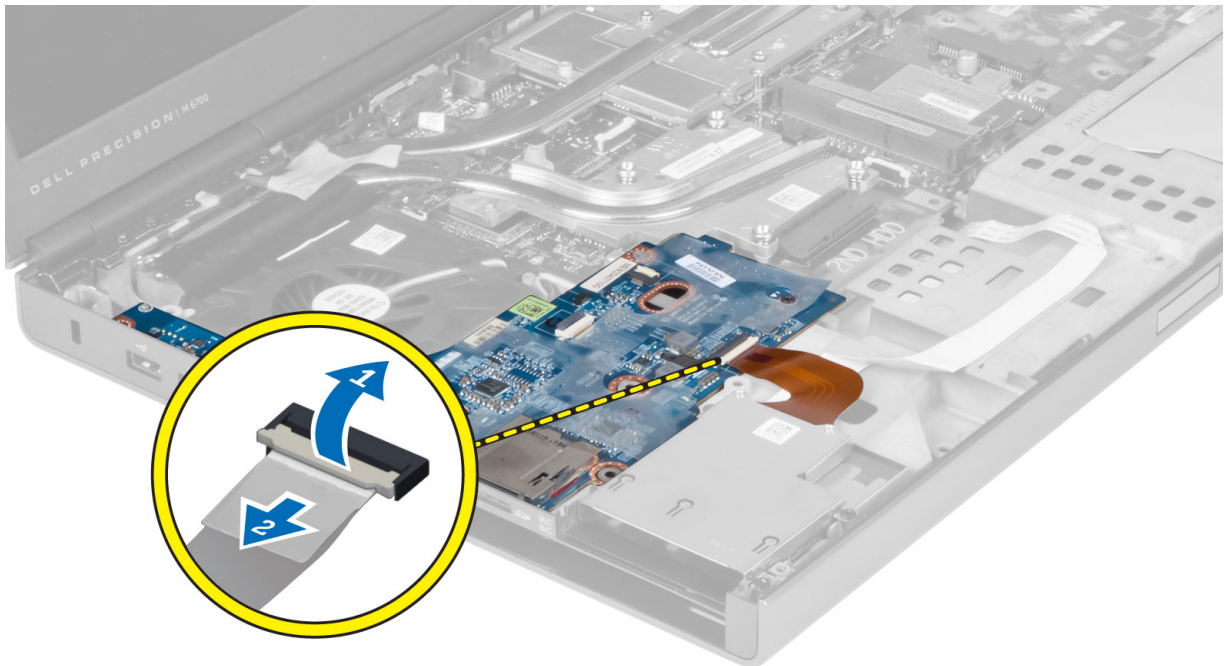

4. Remove the screws that secure the I/O board to the computer. Lift the right edge of the I/O board upwards to disengage the connector and remove it from computer.

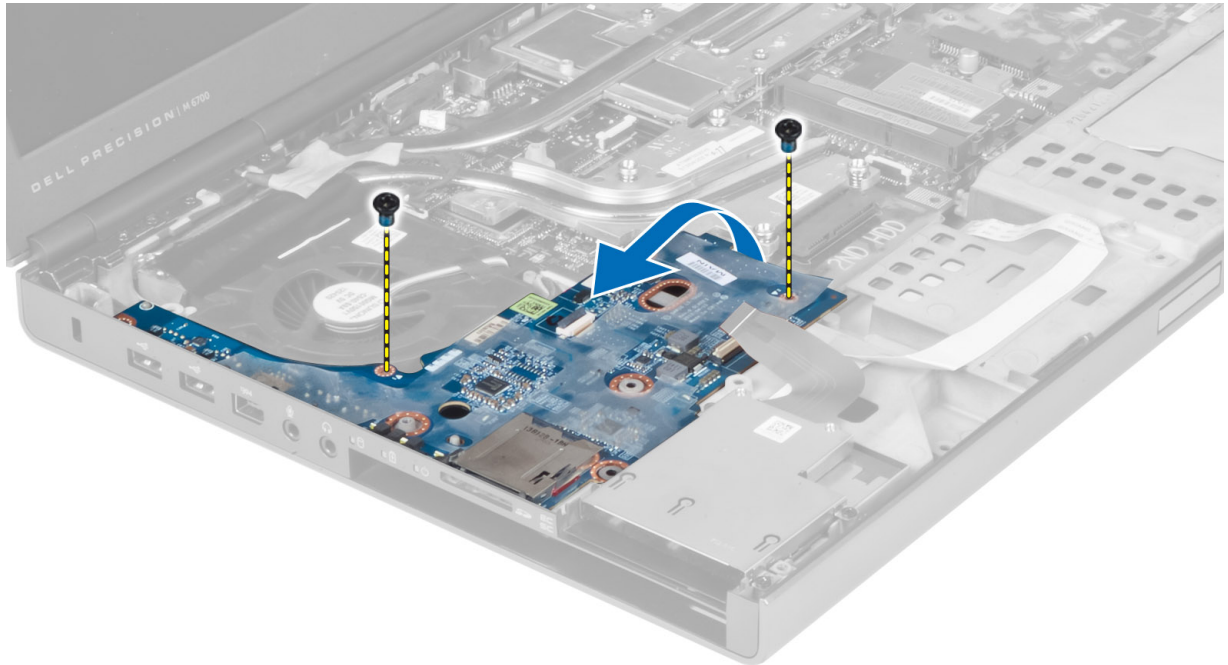

## Installing the I/O Board

1. Connect the I/O board connector and slide the I/O board into its slot in the computer.
2. Tighten the screws to secure the I/O board to the computer.
3. Connect the ExpressCard module connector.
4. Install the:
  - a) palmrest
  - b) primary and secondary hard drive
  - c) optical drive
  - d) keyboard
  - e) keyboard trim
  - f) base cover
  - g) battery
  - h) SD card
5. Follow the procedures in *After Working Inside Your Computer*.

## Removing the Display Assembly

1. Follow the procedures in *Before Working Inside Your Computer*.
2. Remove the:
  - a) battery
  - b) base cover
  - c) keyboard trim
  - d) keyboard
  - e) optical drive
  - f) primary and secondary hard drive
  - g) palmrest

3. Disconnect the antenna cables from the wireless cards, and push them down the routing hole.

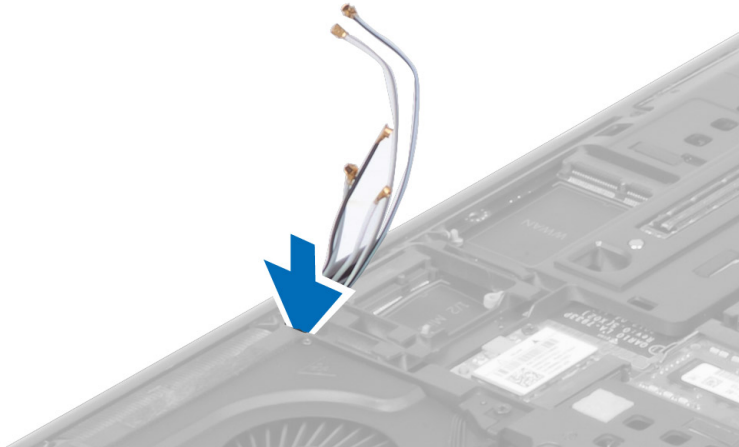

4. Flip the computer and pull up the antenna cables through the routing hole.

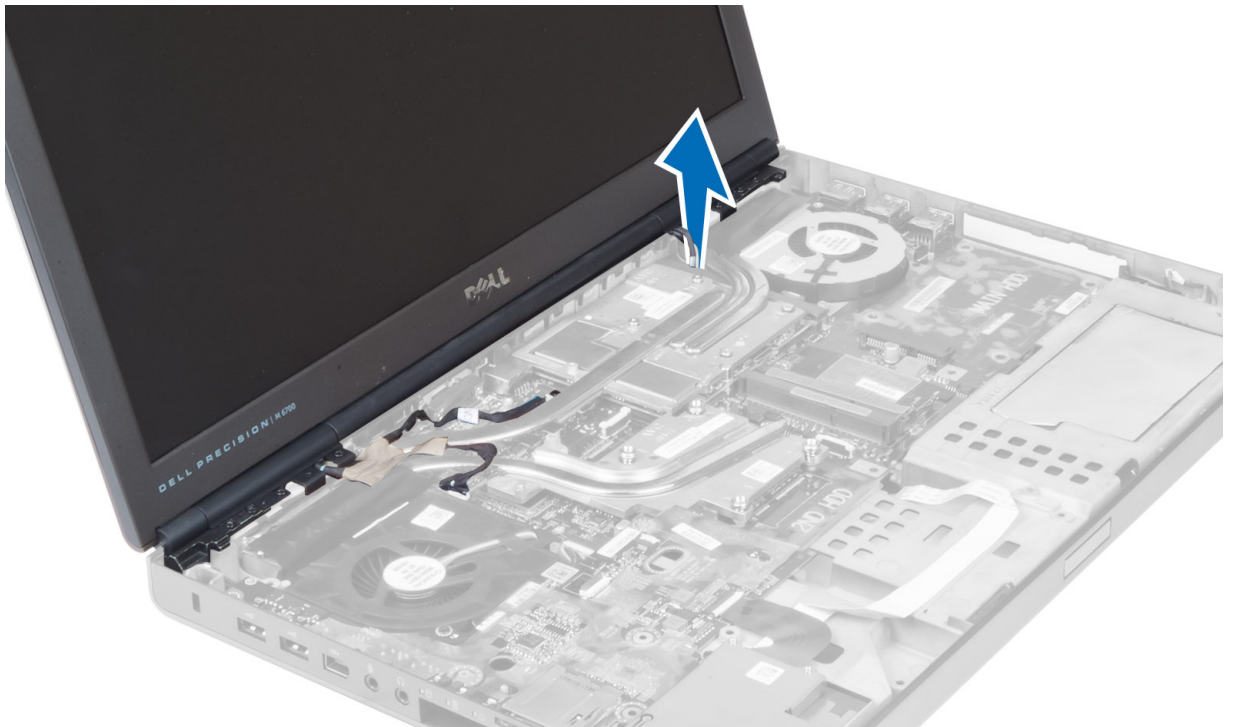

5. Flip the computer and remove the screws from the bottom and back of the computer.



6. Remove the screws that secure the low-voltage differential signalling (LVDS) cable bracket. Remove the LVDS cable bracket from the computer. Disconnect the LVDS cable and camera cable (for M6700 only).



7. Remove the screws that secure the display assembly to the computer. Remove the display assembly from the computer.



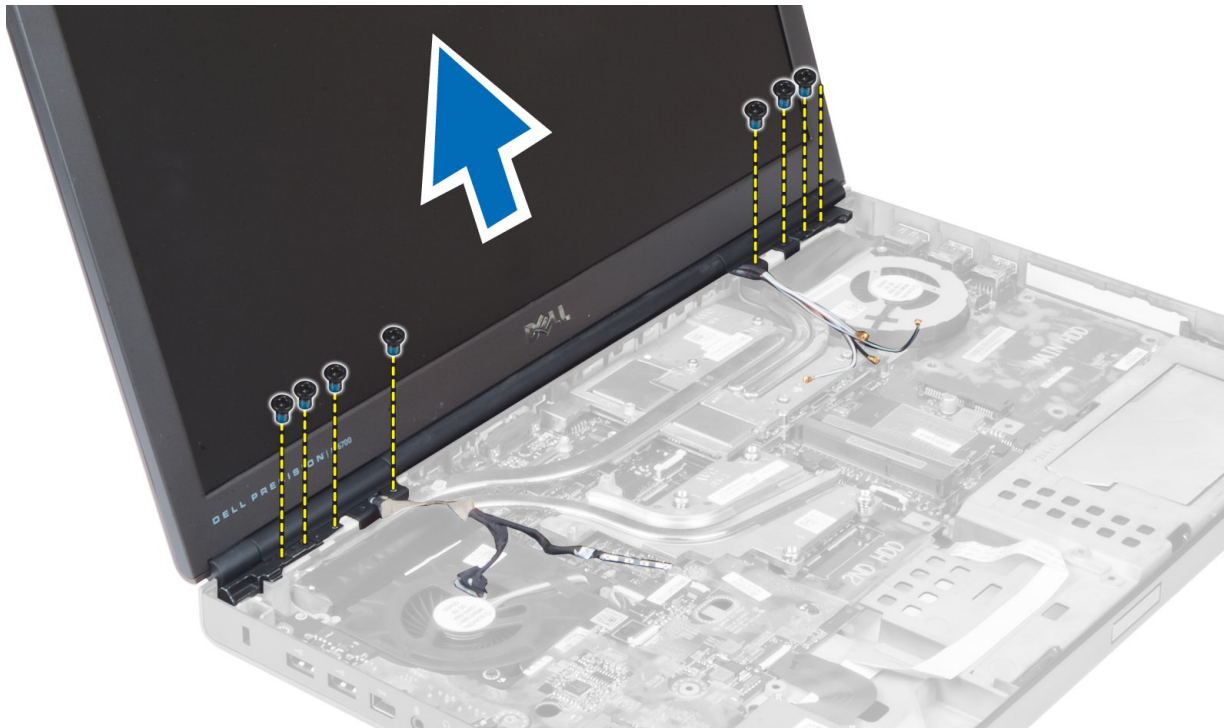

## Installing the Display Assembly

1. Tighten the screws to secure the display assembly in place.
2. Connect the camera and LVDS cables to the correct connectors on the system board.  
 **NOTE:** LVDS cable is available in M6700 only.
3. Place the LVDS cable bracket on the computer and tighten the screws to secure it to the computer (for M6700 only).
4. Route the cables through the routing channels.
5. Insert the wireless antenna cables through the routing hole on the chassis.
6. Tighten the screws at the bottom and back of the computer.
7. Route and connect the antenna cables to their connectors.
8. Install the:
  - a) palmrest
  - b) primary and secondary hard drive
  - c) optical drive
  - d) keyboard
  - e) keyboard trim
  - f) base cover
  - g) battery
9. Follow the procedures in *After Working Inside Your Computer*.

## Removing the Display Hinges and Hinge Towers

1. Follow the procedures in *After Working Inside Your Computer*.
2. Remove the:

- a) battery
  - b) base cover
  - c) keyboard trim
  - d) keyboard
  - e) optical drive
  - f) primary and secondary hard drive
  - g) palmrest
  - h) display assembly
  - i) display bezel
3. Remove the screw that secures the left display hinge to the computer.
  4. Remove the left display hinge and the left hinge tower from the computer.
  5. Repeat steps 3 and 4 to remove the right display hinge and right hinge tower.

## Installing the Display Hinges and Hinge Towers

1. Slide the right display hinge tower and the right hinge in their position on the computer.
2. Tighten the screws to secure the right display hinge tower and the right hinge to the computer.
3. Repeat steps 1 and 2 to secure the left hinge tower and the left display hinge to the computer.
4. Install the:
  - a) display bezel
  - b) display assembly
  - c) palmrest
  - d) primary and secondary hard drive
  - e) optical drive
  - f) keyboard
  - g) keyboard trim
  - h) base cover
  - i) battery
5. Follow the procedures in *After Working Inside Your Computer*.

## Removing the Hinge Cover

1. Follow the procedures in *Before Working Inside Your Computer*.
2. Remove the:
  - a) battery
  - b) base cover
  - c) keyboard trim
  - d) keyboard
  - e) optical drive
  - f) primary and secondary hard drive
  - g) display assembly
3. Remove the screws that secure the hinge cover to the computer. Remove the hinge cover from the computer.

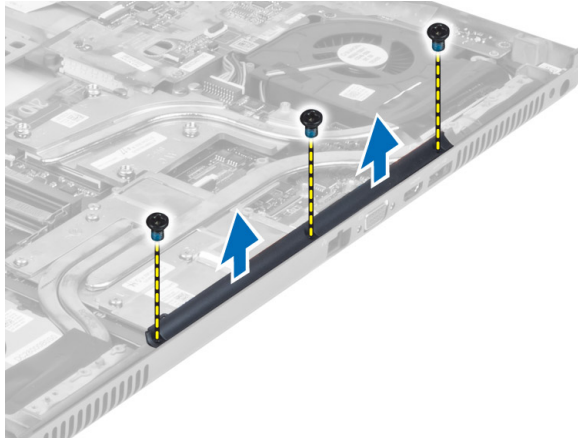

## Installing the Hinge Cover

1. Place the hinge cover in its position on the computer.
2. Tighten the screws to secure the hinge cover to the computer.
3. Install the:
  - a) display assembly
  - b) palmrest
  - c) primary and secondary hard drive
  - d) optical drive
  - e) keyboard
  - f) keyboard trim
  - g) base cover
  - h) battery
4. Follow the procedures in *After Working Inside Your Computer*.

## Removing the System Board

1. Follow the procedures in *Before Working Inside Your Computer*.
2. Remove the:
  - a) SD card
  - b) ExpressCard
  - c) battery
  - d) base cover
  - e) keyboard trim
  - f) keyboard
  - g) optical drive
  - h) primary and secondary hard drive
  - i) primary memory
  - j) secondary memory
  - k) video-card fan
  - l) palmrest
  - m) heatsink
  - n) processor
  - o) video-card heatsink.

- p) video card
- q) I/O board
- r) display assembly

3. Disconnect the processor-fan cable and the coin-cell battery cable.

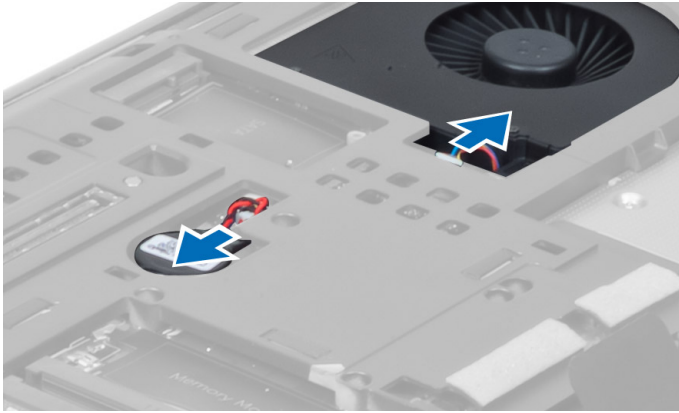

4. Remove the screw that secure the low-voltage differential signaling (LVDS) cable bracket to the computer and remove it.

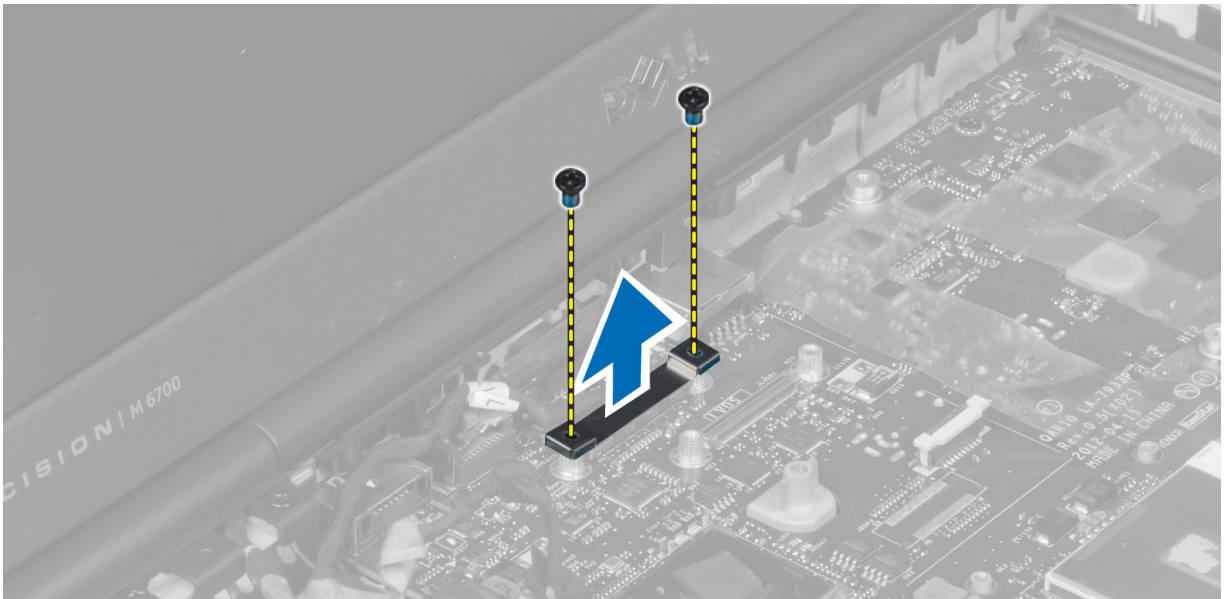

5. Disconnect the LVDS , camera and power connector cables.

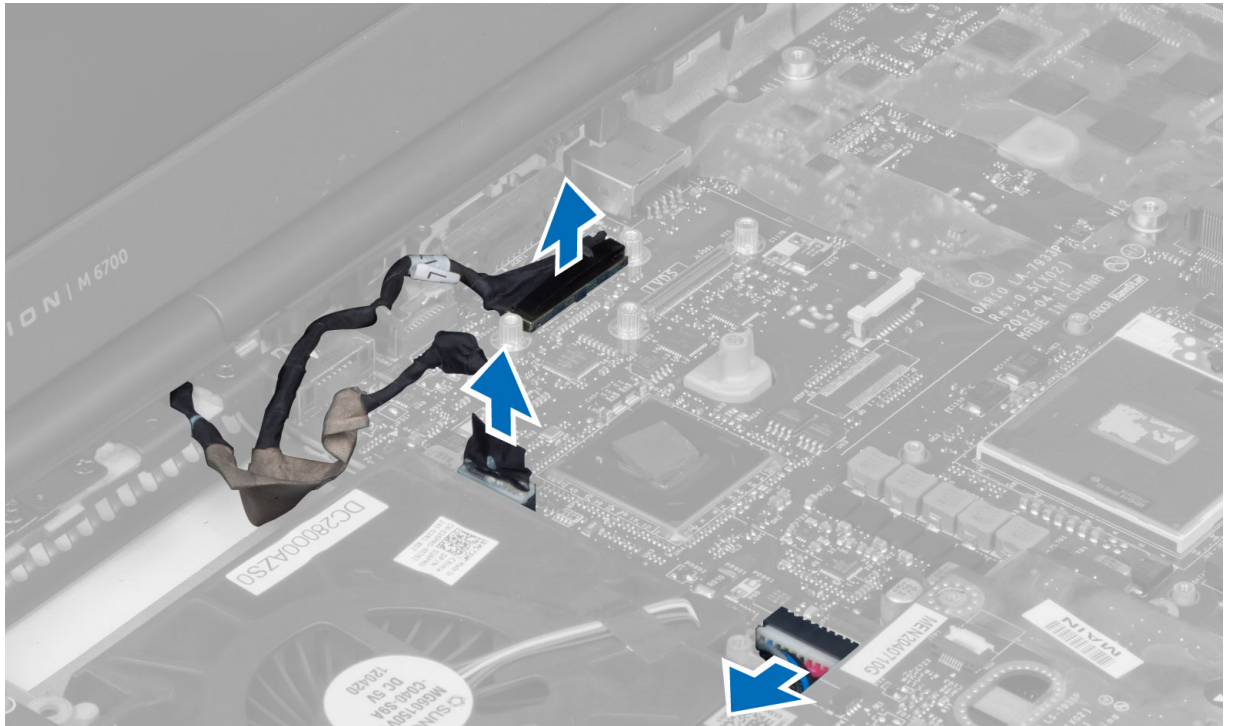

6. Disconnect the switch board cable.

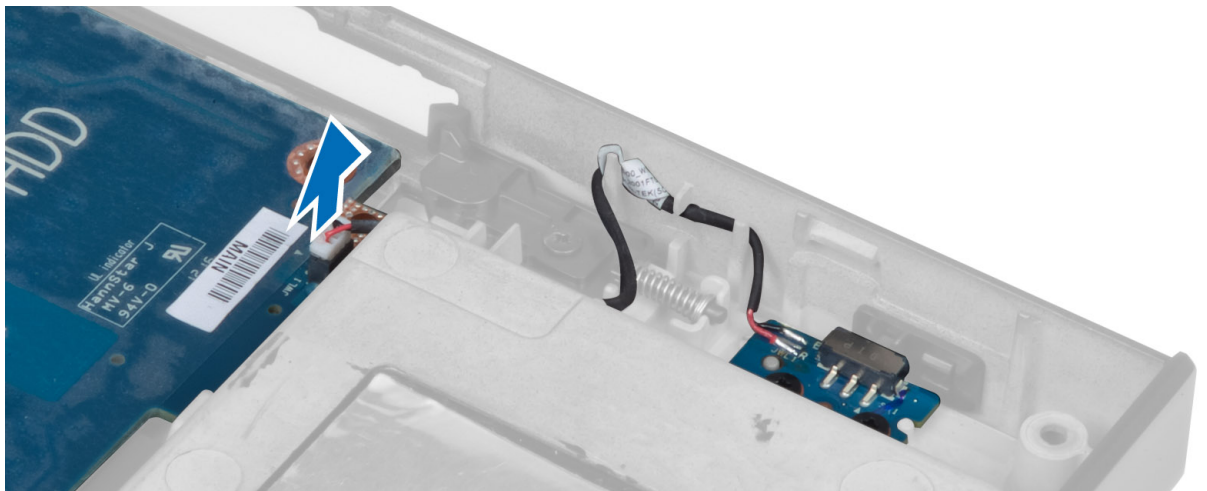

7. Remove any mini-cards (if available).
8. Remove the screw that secure the system board to the computer and lift the bottom edge of the system board at a 20-degree angle.

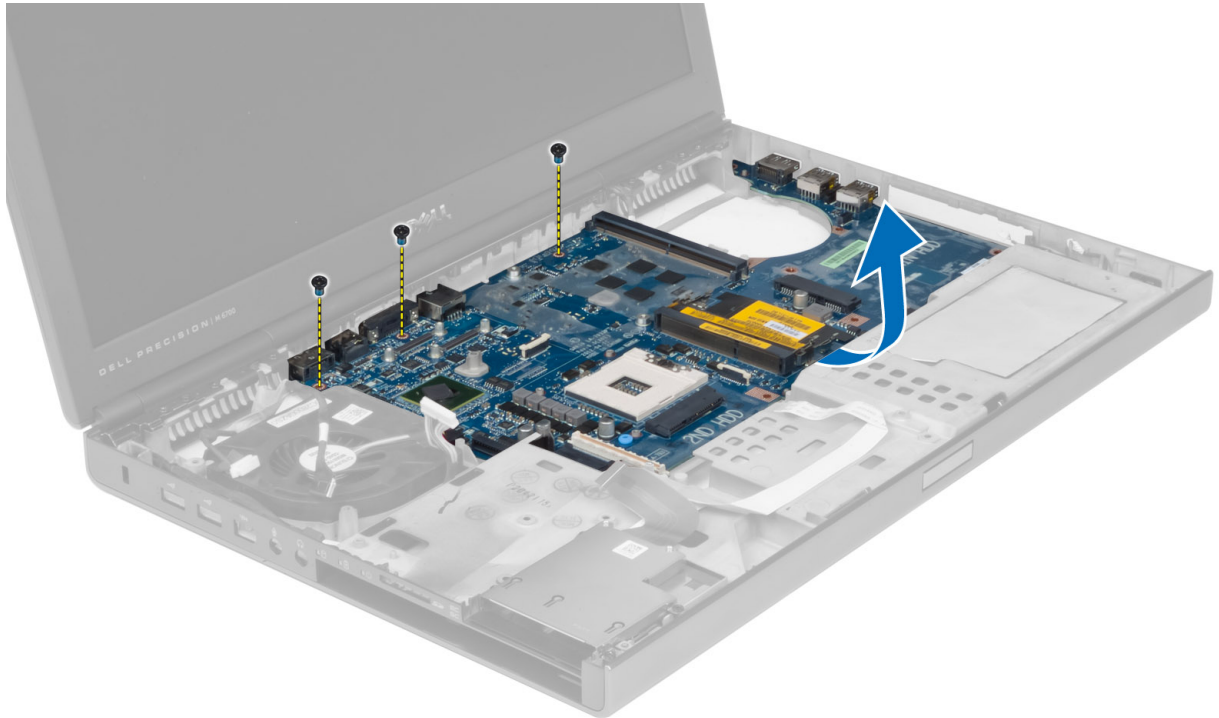

9. Remove the system board from the computer.

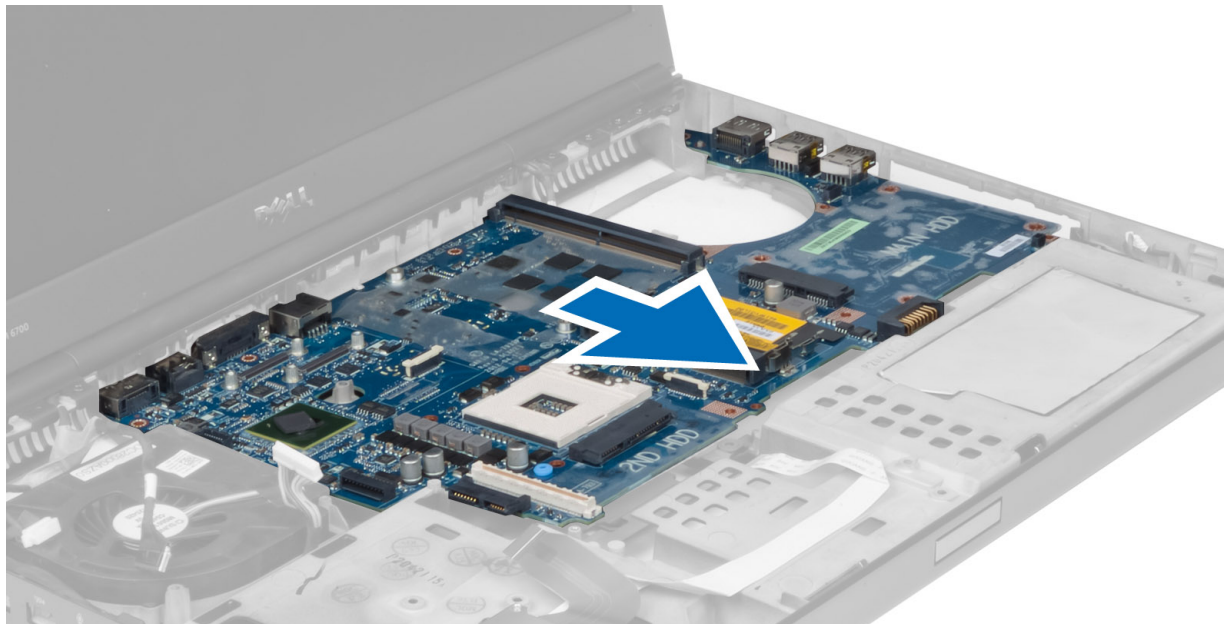

## Installing the System Board

1. Align the system board into its original position on the computer.
2. Tighten the screw to secure the system board to the computer.
3. Connect the following cables:

- a) switch board
  - b) power connector
  - c) LVDS
  - d) camera
  - e) coin-cell battery
  - f) processor fan
4. Install all the mini-cards (if available).
  5. Place the LVDS cable bracket in its original position on the computer and tighten the screw to secure it to the computer.
  6. Install the:
    - a) I/O board
    - b) video card
    - c) video-card heat sink.
    - d) processor
    - e) heatsink
    - f) palmrest
    - g) video-card fan
    - h) secondary memory
    - i) primary memory
    - j) primary and secondary hard drive
    - k) optical drive
    - l) keyboard
    - m) keyboard trim
    - n) base cover
    - o) battery
    - p) ExpressCard
    - q) SD card
  7. Follow the procedures in *After Working Inside Your Computer*.

## Removing the Power-Connector Port

1. Follow the procedures in *Before Working Inside Your Computer*.
2. Remove the:
  - a) battery
  - b) base cover
  - c) keyboard trim
  - d) keyboard
  - e) optical drive
  - f) primary and secondary hard drive
  - g) palmrest
  - h) I/O board
  - i) display assembly
3. Disconnect the power-connector cable from the system board and remove the power connector port from the computer.

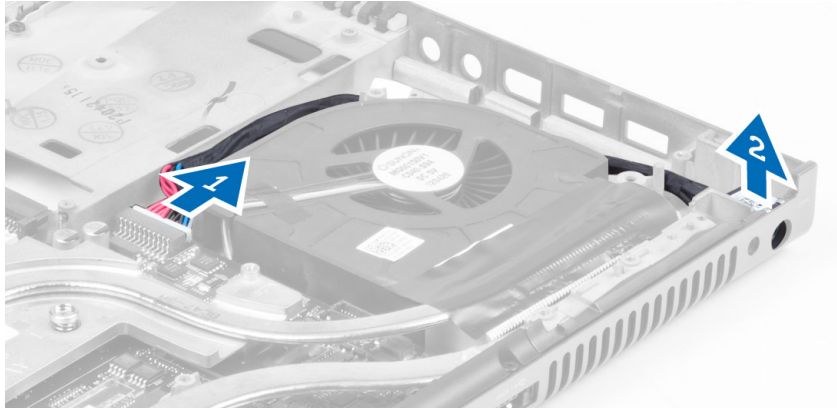

## Installing the Power Connector Port

1. Insert the power-connector port in its slot and connect the power-connector cable to the system board.
2. Install the:
  - a) display assembly
  - b) I/O board
  - c) palmrest
  - d) primary and secondary hard drive
  - e) optical drive
  - f) keyboard
  - g) keyboard trim
  - h) base cover
  - i) battery
3. Follow the procedures in *After Working Inside Your Computer*.

## Removing the Switch Board

1. Follow the procedures in *Before Working Inside Your Computer*.
2. Remove the:
  - a) battery
  - b) base cover
  - c) keyboard trim
  - d) keyboard
  - e) optical drive
  - f) primary and secondary hard drive
  - g) palmrest
3. Disconnect the switch-board cable from the system board and remove it from the latches. Remove the screws that secure the switch board to the computer and remove it from the computer.



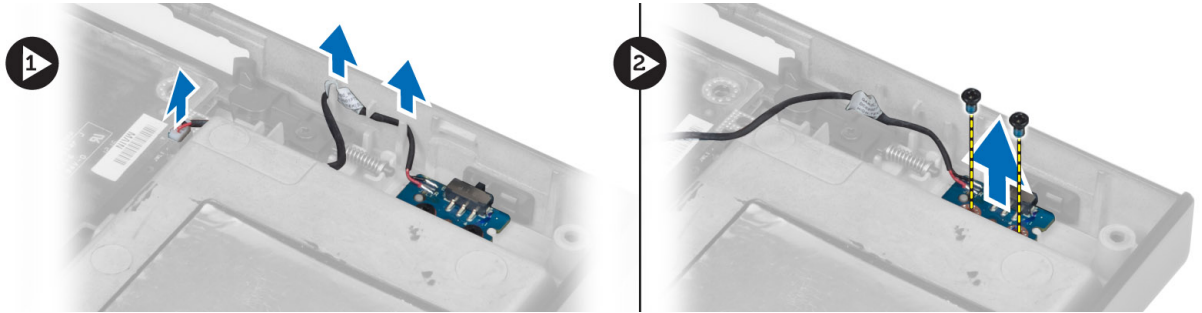

## Installing the Switch Board

1. Align the switch board to its original position on the computer.
2. Tighten the screws to secure the switch board to the computer.
3. Connect the switch-board cable to the system board and secure it through the routing channel.
4. Install the:
  - a) palmrest
  - b) primary and secondary hard drive
  - c) optical drive
  - d) keyboard
  - e) keyboard trim
  - f) base cover
  - g) battery
5. Follow the procedures in *After Working Inside Your Computer*.



## System Setup

System Setup enables you to manage your computer hardware and specify BIOS-level options. From the System Setup, you can:



- Change the NVRAM settings after you add or remove hardware
- View the system hardware configuration
- Enable or disable integrated devices
- Set performance and power management thresholds
- Manage your computer security

## Boot Sequence

Boot Sequence allows you to bypass the System Setup-defined boot device order and boot directly to a specific device (for example: optical drive or hard drive). During the Power-on Self Test (POST), when the Dell logo appears, you can:

- Access System Setup by pressing <F2> key
- Bring up the one-time boot menu by pressing <F12> key

The one-time boot menu displays the devices that you can boot from including the diagnostic option. The boot-menu options are:

- Removable Drive (if available)
- STXXXX Drive
  -  **NOTE:** XXX denotes the SATA drive number.
- Optical Drive
- Diagnostics
  -  **NOTE:** Choosing Diagnostics, will display the **ePSA diagnostics** screen.

The boot sequence screen also displays the option to access the System Setup screen.

## Navigation Keys

The following table displays the system setup navigation keys.

 **NOTE:** For most of the system setup options, changes that you make are recorded but do not take effect until you restart the system.

**Table 1. Navigation Keys**

Keys	Navigation
Up arrow	Moves to the previous field.
Down arrow	Moves to the next field.

Keys	Navigation
<Enter>	Allows you to select a value in the selected field (if applicable) or follow the link in the field.
Spacebar	Expands or collapses a drop-down list, if applicable.
<Tab>	Moves to the next focus area.
	 <b>NOTE:</b> For the standard graphics browser only.
<Esc>	Moves to the previous page till you view the main screen. Pressing <Esc> in the main screen displays a message that prompts you to save any unsaved changes and restarts the system.
<F1>	Displays the System Setup help file.

## System Setup Options



 **NOTE:** Depending on your computer and its installed devices, the items listed in this section may or may not appear.

**Table 2. General**

Option	Description
<b>System Information</b>	This section lists the primary hardware features of your computer. <ul style="list-style-type: none"> <li>• System Information</li> <li>• Memory Information</li> <li>• Processor Information</li> <li>• Device Information</li> </ul>
<b>Battery Information</b>	Displays the charge status of the battery.
<b>Boot Sequence</b>	Allows you to change the order in which the computer attempts to find an operating system. All the below options are selected. <ul style="list-style-type: none"> <li>• Diskette Drive</li> <li>• Internal HDD</li> <li>• USB Storage Device</li> <li>• CD/DVD/CD-RW Drive</li> <li>• Onboard NIC</li> </ul> <p>You can also choose the Boot List option. The options are:</p> <ul style="list-style-type: none"> <li>• <b>Legacy</b> (Default Setting)</li> <li>• UEFI</li> </ul>
<b>Date/Time</b>	Allows you to set the date and time.

**Table 3. System Configuration**

Option	Description
<b>Integrated NIC</b>	Allows you to configure the integrated network controller. The options are:



Option	Description
Parallel Port	<ul style="list-style-type: none"> <li>• Disabled</li> <li>• Enabled</li> <li>• <b>Enabled w/PXE</b> (Default Setting)</li> </ul> <p>Allows you to define and set how the parallel port on the docking station operates. You can set the parallel port to:</p> <ul style="list-style-type: none"> <li>• Disabled</li> <li>• <b>AT</b></li> <li>• PS2</li> <li>• ECP</li> </ul>
Serial Port	<p>Identifies and defines the serial port settings. You can set the serial port to:</p> <ul style="list-style-type: none"> <li>• Disabled</li> <li>• <b>COM1</b> (Default Setting)</li> <li>• COM2</li> <li>• COM3</li> <li>• COM4</li> </ul>
SATA Operation	<p> <b>NOTE:</b> The operating system may allocate resources even if the setting is disabled.</p> <p>Allows you to configure the internal SATA hard-drive controller. The options are:</p> <ul style="list-style-type: none"> <li>• Disabled</li> <li>• ATA</li> <li>• AHCI</li> <li>• <b>RAID On</b> (Default Setting)</li> </ul>
Drives	<p> <b>NOTE:</b> SATA is configured to support RAID mode.</p> <p>Allows you to configure the SATA drives on board. The options are:</p> <ul style="list-style-type: none"> <li>• SATA-0</li> <li>• SATA-1</li> <li>• SATA-3</li> <li>• SATA-4</li> <li>• SATA-5</li> </ul>
SMART Reporting	<p>Default Setting: All drives are enabled.</p> <p>This field controls if the hard drive errors for the integrated drives are reported during system startup. This technology is part of the SMART (Self Monitoring Analysis and Reporting Technology) specification.</p>

Option	Description
	<ul style="list-style-type: none"> <li>• <b>Enable SMART Reporting</b> - This option is disabled by default.</li> </ul>
<b>USB Configuration</b>	<p>Allows you to define the USB configuration. The options are:</p> <ul style="list-style-type: none"> <li>• Enable Boot Support</li> <li>• Enable External USB Port</li> </ul> <p>Default Setting: both the options are enabled.</p>
<b>USB PowerShare</b>	<p>Allows you to configure the behavior of the USB PowerShare feature. The option is disabled by default.</p> <ul style="list-style-type: none"> <li>• Enable USB PowerShare</li> </ul>
<b>Miscellaneous Devices</b>	<p>Allows you enable or disable the various on board devices. The options are:</p> <ul style="list-style-type: none"> <li>• <b>Enable Fixed Bay</b></li> <li>• <b>Enable Microphone</b></li> <li>• <b>Enable ExpressCard</b></li> <li>• <b>Enable eSATA Ports</b></li> <li>• <b>Enable Camera</b></li> <li>• Enable Hard Drive Free Fall Protection</li> <li>• <b>Enable Media Card and 1394</b></li> <li>• Enable Media Card Only</li> <li>• Disable MC, 1394</li> </ul> <p>Default Setting: The highlighted devices are enabled.</p>

**Table 4. Video**

Option	Description
<b>LCD Brightness</b>	Allows you to set the panel brightness when the ambient sensor is Off.
<b>Optimus</b>	<p>Allows you to enable or disable the NVIDIA Optimus technology.</p> <ul style="list-style-type: none"> <li>• <b>Enable Optimus</b> - Default Setting.</li> </ul>

**Table 5. Security**

Option	Description
<b>Admin Password</b>	<p>Allows you to set, change, or delete the administrator (admin) password.</p> <p> <b>NOTE:</b> You must set the admin password before you set the system or hard drive password.</p> <p> <b>NOTE:</b> Successful password changes take effect immediately.</p> <p> <b>NOTE:</b> Deleting the admin password automatically deletes the system password and the hard drive password.</p>



Option	Description
	 <b>NOTE:</b> Successful password changes take effect immediately. Default Setting: <b>Not set</b>
<b>System Password</b>	Allows you to set, change or delete the system password.
	 <b>NOTE:</b> Successful password changes take effect immediately. Default Setting: <b>Not set</b>
<b>Internal HDD-0 Password</b>	Allows you to set, change or delete the administrator password. Default Setting: <b>Not set</b>
<b>Strong Password</b>	Allows you to enforce the option to always set strong passwords. Default Setting: <b>Enable Strong Password</b> is not selected.
<b>Password Configuration</b>	You can define the length of your password. Min = 4 , Max = 32
<b>Password Bypass</b>	Allows you to enable or disable the permission to bypass the System and the Internal HDD password, when they are set. The options are: <ul style="list-style-type: none"> <li>• <b>Disabled</b> (Default Setting)</li> <li>• Reboot bypass</li> </ul>
<b>Password Change</b>	Allows you to enable the disable permission to the System and Hard Drive passwords when the admin password is set. Default Setting: <b>Allow Non-Admin Password Changes</b> is not selected
<b>Non-Admin Setup Changes</b>	Allows you to determine whether changes to setup option are permitted when an administrator password is set. The option is disabled. <ul style="list-style-type: none"> <li>• Allows Wireless Switch Changes</li> </ul>
<b>Computrace</b>	Allows you to activate or disable the optional Computrace software The options are: <ul style="list-style-type: none"> <li>• <b>Deactivate</b> (Default Setting)</li> <li>• Disable</li> <li>• Activate</li> </ul>
	 <b>NOTE:</b> The Activate and Disable options will permanently activate or disable the feature and no further changes will be allowed
<b>CPU XD Support</b>	Allows you to enable the Execute Disable mode of the processor. Default Setting: <b>Enable CPU XD Support</b>
<b>OROM Keyboard Access</b>	Allows you to set access to enter the Option ROM Configuration screens using hotkeys during boot process. The options are: <ul style="list-style-type: none"> <li>• <b>Enable</b> (Default Setting)</li> <li>• One Time Enable</li> <li>• Disable</li> </ul>
<b>Admin Setup Lockout</b>	Allows you to prevent users from entering Setup when an Administrator password is set. Default Setting: <b>Disabled</b>

Table 6. Performance

Option	Description
Multi Core Support	<p>This field specifies whether the process will have one or all cores enabled. The performance of some applications will improve with the additional cores. This option is enabled by default. Allows you to enable or disable multi-core support for the processor. The options are:</p> <ul style="list-style-type: none"> <li>• <b>All</b> (Default Setting)</li> <li>• 1</li> <li>• 2</li> </ul>
Intel SpeedStep	<p>Allows you to enable or disable the Intel SpeedStep feature. Default Setting: <b>Enable Intel SpeedStep</b></p>
C States Control	<p>Allows you to enable or disable the additional processor sleep states. Default Setting: The options <b>C states</b>, <b>C3</b>, <b>C6</b>, <b>Enhanced C-states</b>, and <b>C7</b> options are enabled.</p>
Intel TurboBoost	<p>Allows you to enable or disable the Intel TurboBoost mode of the processor. Default Setting: <b>Enable Intel TurboBoost</b></p>
Hyper-Thread Control	<p>Allows you to enable or disable the HyperThreading in the processor. Default Setting: <b>Enabled</b></p>
Rapid Start Technology	<p>Allows you to set the Rapid Start Technology feature. This feature is enabled by default. You can define the Rapid Start timer value.</p>

Table 7. Power Management

Option	Description
AC Behavior	<p>Allows the computer to power-upon automatically, when AC adapter is plugged. The option is disabled.</p> <ul style="list-style-type: none"> <li>• Wake on AC</li> </ul>
Auto On Time	<p>Allows you to set the time at which the computer must turn on automatically. The options are:</p> <ul style="list-style-type: none"> <li>• <b>Disabled</b> (Default Setting)</li> <li>• Every Day</li> <li>• Weekdays</li> </ul>
USB Wake Support	<p>Allows you to enable the USB devices to wake the computer from standby mode. The option is disabled</p> <ul style="list-style-type: none"> <li>• Enable USB Wake Support</li> </ul>



Option	Description
<b>Wireless Radio Control</b>	<p>Allows you to control the WLAN and WWAN radio. The options are:</p> <ul style="list-style-type: none"> <li>Control WLAN radio</li> <li>Control WWAN radio</li> </ul> <p>Default Setting: both the options are disabled.</p>
<b>Wake on LAN/WLAN</b>	<p>This option allows the computer to power up from the off state when triggered by a special LAN signal. Wake-up from the Standby state is unaffected by this setting and must be enabled in the operating system. This feature only works when the computer is connected to AC power supply.</p> <ul style="list-style-type: none"> <li><b>Disabled</b> - Does not allow the system to power on by special LAN signals when it receives a wake-up signal from the LAN or wireless LAN. (Default Setting)</li> <li>LAN Only - Allows the system to be powered on by special LAN signals.</li> <li>WLAN Only</li> <li>LAN or WLAN</li> </ul>
<b>Block Sleep</b>	<p>Allows you to block the computer from entering into the sleep state. Option is disabled by default.</p> <ul style="list-style-type: none"> <li>Block Sleep (S3)</li> </ul>
<b>Primary Battery Configuration</b>	<p>Allows you to define how to use the battery charge, when AC is plugged in. The options are:</p> <ul style="list-style-type: none"> <li>Standard Charge</li> <li>Express Charge</li> <li>Predominantly AC use</li> <li><b>Auto Charge</b> (Default Setting)</li> <li>Custom Charge — you can set the percentage to which the battery must charge .</li> </ul>
<b>Battery Slice Configuration</b>	<p>Allows you to define the how to charge the battery. The options are:</p> <ul style="list-style-type: none"> <li>Standard Charge</li> <li><b>Express Charge</b> (Default Setting)</li> </ul>

Table 8. POST Behavior

Option	Description
<b>Adapter Warnings</b>	<p>Allows you to activate the adapter warning messages when certain power adapters are used. The option is enabled by default.</p> <ul style="list-style-type: none"> <li>Enable Adapter Warnings</li> </ul>
<b>Mouse/Touchpad</b>	<p>Allows you to define how the computer handles the mouse and touchpad input. The options are:</p> <ul style="list-style-type: none"> <li>Serial Mouse</li> <li>PS2 Mouse</li> <li><b>Touchpad/PS-2 Mouse</b> (Default Setting)</li> </ul>

Option	Description
<b>Numlock Enable</b>	Specifies if the NumLock function can be enabled when the computer boots. This option is enabled by default. <ul style="list-style-type: none"> <li>• Enable Numlock</li> </ul>
<b>Fn Key Emulation</b>	Allows you to match the <Scroll Lock> key feature of PS-2 keyboard with the <Fn> key feature in an internal keyboard. The option is enabled by default. <ul style="list-style-type: none"> <li>• Enable Fn Key Emulation</li> </ul>
<b>Keyboard Errors</b>	Specifies whether keyboard related errors are reported when it boots. This option is enabled by default. <ul style="list-style-type: none"> <li>• Enable Keyboard Error Detection</li> </ul>
<b>POST Hotkeys</b>	Specifies whether the sign-on screen displays a message, that displays the keystroke sequence required to enter the BIOS Boot Option Menu. <ul style="list-style-type: none"> <li>• <b>Enable F12 Boot Option menu</b> - This option is enabled by default.</li> </ul>

**Table 9. Virtualization Support**

Option	Description
<b>Virtualization</b>	This option specifies whether a Virtual Machine Monitor (VMM) can utilize the additional hardware capabilities provided by Intel Virtualization technology. <ul style="list-style-type: none"> <li>• <b>Enable Intel Virtualization Technology</b> - Default Setting.</li> </ul>
<b>VT for Direct I/O</b>	Enables or disables the Virtual Machine Monitor (VMM) from utilizing the additional hardware capabilities provided by Intel Virtualization technology for direct I/O. <ul style="list-style-type: none"> <li>• <b>Enable Intel Virtualization Technology for Direct I/O</b> - Default Setting.</li> </ul>

**Table 10. Wireless**

Option	Description
<b>Wireless Switch</b>	Allows you to determine which wireless device can be controlled by the wireless switch. The options are: <ul style="list-style-type: none"> <li>• WWAN</li> <li>• Bluetooth</li> <li>• WLAN</li> </ul> <p>All options are enabled by default.</p>
<b>Wireless Device Enable</b>	Allows you to enable or disable the wireless devices. The options are: <ul style="list-style-type: none"> <li>• WWAN</li> <li>• Bluetooth</li> <li>• WLAN</li> </ul> <p>All options are enabled by default.</p>

**Table 11. Maintenance**



Option	Description
<b>Service Tag</b>	Displays the service tag of your computer.
<b>Asset Tag</b>	Allows you to create a system asset tag if an asset tag is not already set. This option is not set by default.

**Table 12. System Logs**

Option	Description
<b>BIOS events</b>	Displays the system event log and allows you to clear the log.
<b>Thermal Events</b>	Displays the thermal event logs and allows you clear the thermal event log.
<b>Power Events</b>	Displays the thermal event logs and allows you clear the thermal event log.

## Updating the BIOS

It is recommended to update your BIOS (system setup), on replacing the system board or if an update is available. For notebooks, ensure that your computer battery is fully charged and connected to a power outlet

- Restart the computer.
- Go to [support.dell.com/support/downloads](http://support.dell.com/support/downloads).
- If you have your computer's Service Tag or Express Service Code:
  -  **NOTE:** For desktops, the service tag label is available on the front of your computer.
  -  **NOTE:** For notebooks, the service tag label is available on the bottom of your computer.
  - Enter the **Service Tag** or **Express Service Code** and click **Submit**.
  - Click **Submit** and proceed to step 5.
- If you do not have your computer's service tag or express service code, select one of the following:
  - Automatically detect my Service Tag for me**
  - Choose from My Products and Services List**
  - Choose from a list of all Dell products**
- On the application and drivers screen, under the **Operating System** drop-down list, select **BIOS**.
- Identify the latest BIOS file and click **Download File**.
- Select your preferred download method in the **Please select your download method below window**; click **Download Now**.  
The **File Download** window appears.
- Click **Save** to save the file on your computer.
- Click **Run** to install the updated BIOS settings on your computer.  
Follow the instructions on the screen.

## System and Setup Password

You can create a system password and a setup password to secure your computer.

Password Type	Description
<b>System password</b>	Password that you must enter to log on to your system.

Password Type	Description
Setup password	Password that you must enter to access and make changes to the BIOS settings of your computer.

 **CAUTION:** The password features provide a basic level of security for the data on your computer.

 **CAUTION:** Anyone can access the data stored on your computer if it is not locked and left unattended.

 **NOTE:** Your computer is shipped with the system and setup password feature disabled.

## Assigning a System Password and Setup Password

You can assign a new **System Password** and/or **Setup Password** or change an existing **System Password** and/or **Setup Password** only when **Password Status** is **Unlocked**. If the Password Status is **Locked**, you cannot change the System Password.

 **NOTE:** If the password jumper is disabled, the existing System Password and Setup Password is deleted and you need not provide the system password to log on to the computer.

To enter a system setup, press <F2> immediately after a power-on or reboot.

1. In the **System BIOS** or **System Setup** screen, select **System Security** and press <Enter>. The **System Security** screen appears.
2. In the **System Security** screen, verify that **Password Status** is **Unlocked**.
3. Select **System Password**, enter your system password, and press <Enter> or <Tab>. Use the following guidelines to assign the system password:
  - A password can have up to 32 characters.
  - The password can contain the numbers 0 through 9.
  - Only lower case letters are valid, upper case letters are not allowed.
  - Only the following special characters are allowed: space, ("), (+), (,), (-), (.), (/), (:), (|), (\), (|), (').

Re-enter the system password when prompted.

4. Type the system password that you entered earlier and click **OK**.
5. Select **Setup Password**, type your system password and press <Enter> or <Tab>. A message prompts you to re-type the setup password.
6. Type the setup password that you entered earlier and click **OK**.
7. Press <Esc> and a message prompts you to save the changes.
8. Press <Y> to save the changes. The computer reboots.

## Deleting or Changing an Existing System and/or Setup Password

Ensure that the **Password Status** is **Unlocked** (in the System Setup) before attempting to delete or change the existing System and/or Setup password. You cannot delete or change an existing System or Setup password, if the **Password Status** is **Locked**.

To enter the System Setup, press <F2> immediately after a power-on or reboot.

1. In the **System BIOS** or **System Setup** screen, select **System Security** and press <Enter>.

The **System Security** screen is displayed.

2. In the **System Security** screen, verify that **Password Status** is **Unlocked**.
3. Select **System Password**, alter or delete the existing system password and press <Enter> or <Tab>.
4. Select **Setup Password**, alter or delete the existing setup password and press <Enter> or <Tab>.



**NOTE:** If you change the System and/or Setup password, re-enter the new password when promoted. If you delete the System and/or Setup password, confirm the deletion when promoted.

5. Press <Esc> and a message prompts you to save the changes.
6. Press <Y> to save the changes and exit from the System Setup.

The computer reboots.



# Diagnostics

If you experience a problem with your computer, run the ePSA diagnostics before contacting Dell for technical assistance. The purpose of running diagnostics is to test your computer's hardware without requiring additional equipment or risking data loss. If you are unable to fix the problem yourself, service and support personnel can use the diagnostics results to help you solve the problem.

## Enhanced Pre-Boot System Assessment (ePSA) Diagnostics

The ePSA diagnostics (also known as system diagnostics) performs a complete check of your hardware. The ePSA is embedded with the BIOS and is launched by the BIOS internally. The embedded system diagnostics provides a set of options for particular devices or device groups allowing you to:

- Run tests automatically or in an interactive mode
- Repeat tests
- Display or save test results
- Run thorough tests to introduce additional test options to provide extra information about the failed device(s)
- View status messages that inform you if tests are completed successfully
- View error messages that inform you of problems encountered during testing



**CAUTION:** Use the system diagnostics to test only your computer. Using this program with other computers may cause invalid results or error messages.



**NOTE:** Some tests for specific devices require user interaction. Always ensure that you are present at the computer terminal when the diagnostic tests are performed.

1. Power-on the computer.
2. As the computer boots, press the <F12> key as the Dell logo appears.
3. On the boot menu screen, select the **Diagnostics** option.  
The **Enhanced Pre-boot System Assessment** window is displayed, listing all devices detected in the computer. The diagnostics starts running the tests on all the detected devices.
4. If you wish to run a diagnostic test on a specific device, press <Esc> and click **Yes** to stop the diagnostic test.
5. Select the device from the left pane and click **Run Tests**.
6. If there are any issues, error codes are displayed.  
Note the error code and contact Dell.









# Troubleshooting Your Computer

You can troubleshoot your computer using indicators like Diagnostic Lights, Beep Codes, and Error Messages during the operation of the computer.

## Device Status Lights

**Table 13. Device Status Lights**

	Turns on when you turn on the computer and blinks when the computer is in a power management mode.
	Turns on when the computer reads or writes data.
	Turns on steadily or blinks to indicate battery charge status.
	Turns on when wireless networking is enabled.

The device status LEDs are usually located either on the top or left side of the keyboard. They are used to display the storage, battery and wireless devices connectivity and activity. Apart from that they can be useful as a diagnostic tool when there's a possible failure to the system.

The following table lists how to read the LED codes when possible errors occur.

**Table 14. LED Lights**

Storage LED	Power LED	Wireless LED	Fault Description
Blinking	Solid	Solid	A possible processor failure has occurred.
Solid	Blinking	Solid	The memory modules are detected but has encountered an error.
Blinking	Blinking	Blinking	A system board failure has occurred.
Blinking	Blinking	Solid	A possible graphics card/video failure has occurred.
Blinking	Blinking	Off	System failed on hard drive initialization OR System failed in Option ROM initialization.
Blinking	Off	Blinking	The USB controller encountered a problem during initialization.
Solid	Blinking	Blinking	No memory modules are installed/detected.
Blinking	Solid	Blinking	The display encountered a problem during initialization.
Off	Blinking	Blinking	The modem is preventing the system from completing POST
Off	Blinking	Off	Memory failed to initialize or memory is unsupported.



## Battery Status Lights

If the computer is connected to an electrical outlet, the battery light operates as follows:

<b>Alternately blinking amber light and white light</b>	An unauthenticated or unsupported non-Dell AC adapter is attached to your laptop.
<b>Alternately blinking amber light with steady white light</b>	Temporary battery failure with AC adapter present.
<b>Constantly blinking amber light</b>	Fatal battery failure with AC adapter present.
<b>Light off</b>	Battery in full charge mode with AC adapter present.
<b>White light on</b>	Battery in charge mode with AC adapter present.

# Specifications

## Technical Specification

 **NOTE:** Offerings may vary by region. For more information regarding the configuration of your computer, click Start  (Start icon) → **Help and Support**, and then select the option to view information about your computer.

**Table 15. System Information**

Feature	Specification
System Chipset	Mobile Intel QM77 Express Chipset
DMA Channels	two 82C37 DMA controllers with seven independently programmable channels
Interrupt Levels	Integrated I/O APIC capability with 24 interrupts
BIOS Chip (NVRAM)	96 Mb (12 MB)

**Table 16. Processor**

Feature	Specification
Processor type	<ul style="list-style-type: none"> <li>Intel Core i5 and i7 Dual Core</li> <li>Intel Core i7 Quad Extreme</li> <li>Intel Core i7 Quad Core</li> </ul>
L1 cache	Up to 32 KB cache depending on processor type
L2 cache	Up to 256 KB cache depending on processor type
L3 cache	Up to 8 MB cache depending on processor type

**Table 17. Memory**

Feature	Specification
Type	DDR3
Speed	1600 MHz and 1866 MHz
Connectors	<ul style="list-style-type: none"> <li>Intel Core i5 and i7 Dual Core processors — two DIMM slots</li> <li>Intel Core i7 Quad Core and i7 Quad Extreme processors — four DIMM slots</li> </ul>
Capacity	1 GB, 2 GB, 4 GB, and 8 GB
Minimum Memory	2 GB

Feature	Specification
Maximum memory	<ul style="list-style-type: none"> <li>Intel Core i5 and i7 Dual Core processors — 16 GB</li> <li>Intel Core i7 Quad Core and i7 Quad Extreme processors — 32 GB</li> </ul>

**Table 18. Video**

Feature	Specification
Type	discrete
Data bus	PCIe X16
Video controller and memory:	
M4700	<ul style="list-style-type: none"> <li>AMD FirePro M4000 with 1 GB GDDR5</li> <li>NVIDIA Quadro K1000M with 2 GB GDDR3</li> <li>NVIDIA Quadro K2000M with 2 GB GDDR3</li> </ul>
M6700	<ul style="list-style-type: none"> <li>AMD FirePro M6000 with 2 GB GDDR5</li> <li>NVIDIA Quadro K3000M with 2 GB GDDR5</li> <li>NVIDIA Quadro K4000M with 4 GB GDDR5</li> <li>NVIDIA Quadro K5000M with 4 GB GDDR5</li> </ul>

**Table 19. Audio**

Feature	Specification
Integrated	dual-channel High-Definition audio

**Table 20. Communication**

Feature	Specification
Network adapter	network interface card capable of 10/100/1000 Mb/s communication
Wireless	<ul style="list-style-type: none"> <li>internal wireless local area network (WLAN)</li> <li>internal wireless wide area network (WWAN)</li> <li>bluetooth wireless support</li> </ul>

**Table 21. Expansion Bus**

Feature	Specification
Bus Type	PCI 2.3, PCI Express 1.0 and 2.0, SATA 1.0A ,2.0 and 3.0, USB 2.0 and 3.0
Bus Width	PCIe X16
BIOS Chip (NVRAM)	96 Mb (12 MB)

**Table 22. Ports and Connectors**

Feature	Specification
Audio	two connectors for line-out and line-in/microphone
Network Adapter	one RJ45 connector
USB 2.0	two
USB 3.0	two
eSATA\USB 2.0	one
IEEE1394:	
M4700	one 4-pin IEEE 1394 connector
M6700	one 6-pin IEEE 1394 connector
Video	15-pin VGA connector, 19-pin HDMI connector, 20-pin DisplayPort connector
Memory card reader	one 8-in-1 memory card reader
Docking port	one
Subscriber Identity Module (SIM) port	one
ExpressCard	one
Smart card (optional)	one

**Table 23. Display**

Feature	M4700	M6700
Type	<ul style="list-style-type: none"> <li>• HD (1366 X 768)</li> <li>• FHD (1920 X 1080)</li> </ul>	<ul style="list-style-type: none"> <li>• HD+ (1600 X 900)</li> <li>• FHD (1920 X 1080)</li> </ul>
Size	15.6 inches	17.3 inches
Dimensions:		
Height	256 mm (10.07 inches)	270.60 mm (10.65 inches)
Width	376 mm (14.80 inches)	416.70 mm (16.40 inches)
Diagonal	396.24 mm (15.60 inches)	439.42 mm (17.3 inches)
Active area (X/Y)	344.23 mm X 193.54 mm	<ul style="list-style-type: none"> <li>• 382.08 mm X 214.92 mm (HD+)</li> <li>• 381.89 mm X 214.81 mm (FHD)</li> </ul>
Maximum resolution	1920 X 1080 pixels	1920 X 1080 pixels
Maximum Brightness	<ul style="list-style-type: none"> <li>• 220 nits (HD)</li> <li>• 300 nits (FHD)</li> </ul>	<ul style="list-style-type: none"> <li>• 220 nits (HD+)</li> <li>• 300 nits (FHD)</li> </ul>
Operating angle	0° (closed) to 135°	

Feature	M4700	M6700
Refresh rate	60 Hz	
Minimum viewing angles:		
Horizontal	+/- 40°, +/-60° (FHD)	
Vertical	+10°/-30°, +/- 50° (FHD)	

**Table 24. Keyboard**

Feature	Specification
Number of keys	<ul style="list-style-type: none"> <li>• United States: 86 keys</li> <li>• United Kingdom: 87 keys</li> <li>• Brazil: 87 keys</li> <li>• Japan: 90 keys</li> </ul>
Layout	QWERTY/AZERTY/Kanji

**Table 25. Touchpad**

Feature	Specification
Active Area:	
X-axis	80.00 mm
Y-axis	40.50 mm

**Table 26. Camera**

Feature	Specification
Type	HD 720P with dual mic
Resolution	HD (1280 X 720 pixels) 30 frames per second (FPS)

**Table 27. Storage**

Feature	Specification
Storage:	
Storage Interface	<ul style="list-style-type: none"> <li>• SATA 1 (1.5 Gb/s)</li> <li>• SATA 2 (3.0 Gb/s)</li> <li>• SATA 3 (6 Gb/s)</li> </ul>
Drives configurations:	
M4700	one internal 2.5 inch SATA HDD/SSD (SATA3) + one mSATA SSD (SATA2)
M6700	two internal 2.5 inch SATA HDD/SSD (SATA3) + one mSATA SSD (SATA2)
Size	1 TB 5400 rpm, 320/500/750 GB 7200 rpm, 320GB 7200 rpm SED FIPS; 128/256/512 GB SATA 3 SSD, 256 GB SATA 3 SSD

Feature	Specification
	 <b>NOTE:</b> The size of the hard drive is bound to change. For more information, see dell.com.
Optical Drive:	
Interface	<ul style="list-style-type: none"> <li>• SATA 1 (1.5 Gb/s)</li> <li>• SATA 2 (3.0 Gb/s)</li> </ul>
Configuration	support ODD modules and Air Bay with SATA HDD option

**Table 28. Battery**

Feature	Specification
Type	lithium ion
Dimensions (6-cell / 9-cell / 9-cell long cycle life (LCL)):	
Depth	82.60 mm (3.25 inches)
Height	190.65 mm (7.50 inches)
Width	20 mm (0.78 inches)
Weight	<ul style="list-style-type: none"> <li>• 6-cell - 345 g (0.76 lb)</li> <li>• 9-cell /9-cell LCL - 535 g (1.18 lb)</li> </ul>
Voltage	11.10 V
Temperature range:	
Operating	0 °C to 35 °C (32 °F to 95 °F)
Non-operating	-40 °C to 65 °C (-40 °F to 149 °F)
Coin-cell battery	3 V CR2032 lithium ion cell

**Table 29. AC Adapter**

Feature	M4700	M6700
Input voltage	90 VAC to 264 VAC	90 VAC to 264 VAC
Input current (maximum)	2.50 A	3.50 A
Input frequency	50 Hz to 60 Hz	50 Hz to 60 Hz
Output power	180 W	240 W
Output current	9.23 A	12.30 A
Rated output voltage	19.50 VDC	19.50 VDC
Dimensions:	180 W	240 W
Height	30 mm (1.18 inches)	25.40 mm (1 inch)
Width	155 mm (6.10 inches)	200 mm (7.87 inches)

Feature	M4700	M6700
Depth	76 mm (2.99 inches)	100 mm (3.93 inches)
Temperature range:		
Operating	0 °C to 40 °C (32 °F to 104 °F)	
Non Operating	-40 °C to 65 °C (-40 °F to 149 °F)	

**Table 30. Contactless Smart Card**

Feature	Specification
Supported Smart Cards and Technologies	<ul style="list-style-type: none"> <li>• ISO14443A — 160 kbps, 212 kbps, 424 kbps, and 848 kbps</li> <li>• ISO14443B — 160 kbps, 212 kbps, 424 kbps, and 848 kbps</li> <li>• ISO15693</li> <li>• HID iClass</li> <li>• FIPS201</li> <li>• NXP Desfire</li> </ul>

**Table 31. Physical Dimension**

Physical	M4700	M6700
Height	32.70 mm (1.28 inches)	33.10 mm (1.30 inches)
Width	376 mm (14.80 inches)	416.70 mm (16.40 inches)
Depth	256 mm (10.07 inches)	270.60 mm (10.65 inches)
Weight (Minimum)	2.79 kg (6.15 lb)	3.52 kg (7.77 lb)

**Table 32. Environmental**

Feature	Specification
Temperature range:	
Operating	0 °C to 40°C (32 °F to 104°F)
Storage	-40 °C to 65 °C (-40 °F to 149 °F)
Relative humidity (maximum):	
Operating	10 % to 90 % (non-condensing)
Storage	5 % to 95 % (non-condensing)
Maximum vibration:	
Operating	0.66 GRMS, 2 Hz - 600 Hz
Storage	1.3 GRMS, 2 Hz - 600 Hz
Maximum shock:	
Operating	140 G, 2 ms
Non-operating	163 G, 2 ms



---

<b>Feature</b>	<b>Specification</b>
Altitude:	
Operating	0 m to 3048 m (0 ft to 10,000 ft)
Storage	0 m to 10668 m (0 ft to 35,000 ft)
Airborne contaminant level	G1 or lower as defined by ANSI/ISA-S71.04-1985



# Getting Help

## Contacting Dell

 **NOTE:** If you do not have an active Internet connection, you can find contact information on your purchase invoice, packing slip, bill, or Dell product catalog.

Dell provides several online and telephone-based support and service options. Availability varies by country and product, and some services may not be available in your area. To contact Dell for sales, technical support, or customer service issues:

1. Visit **support.dell.com**.
2. Select your support category.
3. If you are not a U.S. customer, select your country code at the bottom of the **support.dell.com** page, or select **All** to see more choices.
4. Select the appropriate service or support link based on your need.

## Free Manuals Download Website

<http://myh66.com>

<http://usermanuals.us>

<http://www.somanuals.com>

<http://www.4manuals.cc>

<http://www.manual-lib.com>

<http://www.404manual.com>

<http://www.luxmanual.com>

<http://aubethermostatmanual.com>

Golf course search by state

<http://golfingnear.com>

Email search by domain

<http://emailbydomain.com>

Auto manuals search

<http://auto.somanuals.com>

TV manuals search

<http://tv.somanuals.com>