



Dell Studio™ 1435 Service Manual

[Before You Begin](#)
[Base Cover](#)
[Hard Drive](#)
[Memory](#)
[Wireless Mini-Cards](#)
[Fan](#)
[Processor Heat Sink](#)
[Processor](#)
[Center Control Cover](#)
[Keyboard](#)
[Palm Rest](#)

[Optical Drive](#)
[Speakers](#)
[Audio Board](#)
[Display](#)
[Camera \(Optional\)](#)
[Microphone](#)
[Coin-Cell Battery](#)
[System Board](#)
[WiFi Sniffer Board](#)
[Flashing the BIOS](#)

Notes, Notices, and Cautions

-  **NOTE:** A NOTE indicates important information that helps you make better use of your computer.
 -  **NOTICE:** A NOTICE indicates either potential damage to hardware or loss of data and tells you how to avoid the problem.
 -  **CAUTION:** A CAUTION indicates a potential for property damage, personal injury, or death.
-

Information in this document is subject to change without notice.
© 2008 Dell Inc. All rights reserved.

Reproduction of these materials in any manner whatsoever without the written permission of Dell Inc. is strictly forbidden.

Trademarks used in this text: *Dell* and the *DELL* logo are trademarks of Dell Inc.; *Bluetooth* is a registered trademark owned by Bluetooth SIG, Inc. and is used by Dell under license. *Microsoft*, *Windows*, and *Windows Vista* are either trademarks or registered trademarks of Microsoft Corporation in the United States and/or other countries.

Other trademarks and trade names may be used in this document to refer to either the entities claiming the marks and names or their products. Dell Inc. disclaims any proprietary interest in trademarks and trade names other than its own.

Model PP24L

October 2008 Rev. A00

[Back to Contents Page](#)

Audio Board

Dell Studio™ 1435 Service Manual

- [Removing the Audio Board](#)
- [Replacing the Audio Board](#)

⚠ CAUTION: Before you begin any of the procedures in this section, follow the safety instructions that shipped with your computer.

➡ NOTICE: To avoid electrostatic discharge, ground yourself by using a wrist grounding strap or by periodically touching an unpainted metal surface (such as the back panel) on the computer.

Removing the Audio Board

1. Follow the instructions in [Before You Begin](#).
2. Follow the instructions in [Removing the Palm Rest](#).
3. Remove the two screws that secure the audio board.
4. Lift the audio board out of the computer base.



1	screw (2)	2	audio board
---	-----------	---	-------------

Replacing the Audio Board

1. Place the audio board in the computer base and replace the two screws that secure it.
2. Follow the instructions in [Replacing the Palm Rest](#).

➡ NOTICE: Before turning on the computer, replace all screws and ensure that no stray screws remain inside the computer. Failure to do so may result in damage to the computer.

[Back to Contents Page](#)

Base Cover

Dell Studio™ 1435 Service Manual

- [Removing the Base Cover](#)
- [Replacing the Base Cover](#)

CAUTION: Before working inside your computer, follow the safety instructions that shipped with your computer.

CAUTION: Before performing this procedures, turn off the computer, disconnect the AC adapter from the electrical outlet and the computer, disconnect the modem from the wall connector and the computer, and remove any other external cables from the computer.

NOTICE: To avoid electrostatic discharge, ground yourself by using a wrist grounding strap or by periodically touching an unpainted metal surface (such as a connector on the back of the computer).

Removing the Base Cover

1. Ensure that the computer is turned off.
2. Remove the battery (see [Before Working Inside Your Computer](#)).
3. Loosen the seven captive screws on the base cover and lift the cover off the computer at an angle as shown in the figure.

CAUTION: Do not touch the processor heat sink. Processor components should be removed only by trained support personnel.

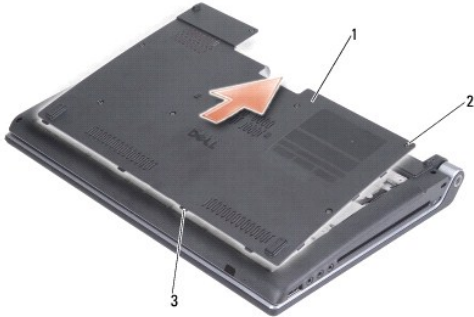

1	base cover	2	captive screw (7)
3	tab		

Replacing the Base Cover

1. Align the tabs on the base cover to the bottom of the computer.
2. Tighten the seven captive screws on the base cover.
3. Slide the battery into the battery bay until it clicks into place.

Before You Begin

Dell Studio™ 1435 Service Manual

- [Recommended Tools](#)
- [Turning Off Your Computer](#)
- [Before Working Inside Your Computer](#)

This section provides procedures for removing and installing the components in your computer. Unless otherwise noted, each procedure assumes that the following conditions exist:

- 1 You have performed the steps in [Turning Off Your Computer](#) and [Before Working Inside Your Computer](#).
- 1 You have read the safety information that shipped with your computer.
- 1 A component can be replaced or—if purchased separately—installed by performing the removal procedure in reverse order.



Recommended Tools

The procedures in this document may require the following tools:

- 1 Small flat-blade screwdriver
- 1 Phillips screwdriver
- 1 Hex nut driver
- 1 Flash BIOS update program CD

Turning Off Your Computer

 **NOTICE:** To avoid losing data, save and close all open files and exit all open programs before you turn off your computer.

1. Save and close all open files and exit all open programs.
2. In Windows Vista®, click **Start**  , click the arrow  , and then click **Shut Down**.

The computer turns off after the operating system shutdown process finishes.

3. Ensure that the computer and any attached devices are turned off. If your computer and attached devices did not automatically turn off when you shut down your operating system, press and hold the power button for at least 8 to 10 seconds until the computer turns off.

Before Working Inside Your Computer

Use the following safety guidelines to help protect your computer from potential damage and to help to ensure your own personal safety.

 **CAUTION:** Before you begin any of the procedures in this section, follow the safety instructions that shipped with your computer.

 **NOTICE:** Handle components and cards with care. Do not touch the components or contacts on a card. Hold a card by its edges or by its metal mounting bracket. Hold a component such as a processor by its edges, not by its pins.

 **NOTICE:** Only a certified service technician should perform repairs on your computer. Damage due to servicing that is not authorized by Dell is not covered by your warranty.

 **NOTICE:** When you disconnect a cable, pull on its connector or on its pull-tab, not on the cable itself. Some cables have connectors with locking tabs; if you are disconnecting this type of cable, press in on the locking tabs before you disconnect the cable. As you pull connectors apart, keep them evenly aligned to avoid bending any connector pins. Also, before you connect a cable, ensure that both connectors are correctly oriented and aligned.

 **NOTICE:** To avoid damaging the computer, perform the following steps before you begin working inside the computer.

1. Ensure that the work surface is flat and clean to prevent the computer cover from being scratched.
2. Turn off your computer (see [Turning Off Your Computer](#)).
3. If the computer is connected to a docking device (docked), undock it. See the documentation that came with your docking device for instructions.

 **NOTICE:** To disconnect a network cable, first unplug the cable from your computer and then unplug the cable from the network device.

4. During installation or removal of any hardware, always ensure all data is backed up properly.
5. Disconnect any external peripherals and cable.
6. Disconnect all telephone or network cables from the computer.
7. Press and eject any installed cards from the ExpressCard slot and the 8-in--1 memory card reader.
8. Disconnect your computer and all attached devices from their electrical outlets.

➡ **NOTICE:** To help prevent damage to the system board, you must remove the battery from the battery bay before you service the computer.

➡ **NOTICE:** To avoid damage to the computer, use only the battery designed for this particular Dell computer. Do not use batteries designed for other Dell computers.

9. Turn the computer over.
10. Slide the battery release latch to the side.
11. Slide the battery out of the battery bay.

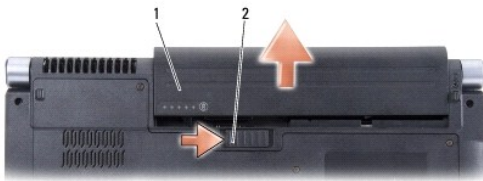

1	battery	2	battery latch release
---	---------	---	-----------------------

12. Press the power button to ground the system board.
-

[Back to Contents Page](#)

Flashing the BIOS

Dell Studio™ 1435 Service Manual

- [Flashing the BIOS From a CD](#)
- [Flashing the BIOS From the Hard Drive](#)

If a BIOS-update program CD is provided with the new system board, flash the BIOS from the CD. If you do not have a BIOS-update program CD, flash the BIOS from the hard drive.

Flashing the BIOS From a CD

1. Ensure that the AC adapter is plugged in and that the main battery is installed properly.

 **NOTE:** If you use a BIOS-update program CD to flash the BIOS, set up the computer to boot from a CD before inserting the CD.

2. Insert the BIOS-update program CD, and restart the computer.

Follow the instructions that appear on the screen. The computer continues to boot and updates the new BIOS. When the flash update is complete, the computer will automatically reboot.

3. Press <F2> during POST to enter the system setup program.
 4. Press <Alt> and <F> to reset the computer defaults.
 5. Press <Esc>, select **Save changes and reboot**, and press <Enter> to save configuration changes.
 6. Remove the flash BIOS-update program CD from the drive and restart the computer.
-

Flashing the BIOS From the Hard Drive

1. Ensure that the AC adapter is plugged in, the main battery is properly installed, and a network cable is attached.
 2. Turn on the computer.
 3. Locate the latest BIOS update file for your computer at support.dell.com.
 4. Click **Download Now** to download the file.
 5. If the **Export Compliance Disclaimer** window appears, click **Yes, I Accept this Agreement**.
The **File Download** window appears.
 6. Click **Save this program to disk** and then click **OK**.
The **Save In** window appears.
 7. Click the down arrow to view the **Save In** menu, select **Desktop**, and then click **Save**.
The file downloads to your desktop.
 8. Click **Close** if the **Download Complete** window appears.
The file icon appears on your desktop and is titled the same as the downloaded BIOS update file.
 9. Double-click the file icon on the desktop and follow the instructions on the screen.
-

Camera (Optional)

Dell Studio™ 1435 Service Manual

- [Removing the Camera](#)
- [Replacing the Camera](#)

⚠ CAUTION: Before working inside your computer, follow the safety instructions that shipped with your computer.

👉 NOTICE: To avoid electrostatic discharge, ground yourself by using a wrist grounding strap or by periodically touching an unpainted metal surface (such as a connector on the back of the computer).

Removing the Camera

1. Follow the instructions in [Before You Begin](#).
2. Follow the instructions in [Removing the Display Assembly](#).
3. Remove the display bezel (see [Display Bezel](#)).
4. Remove the two screws securing the camera board.
5. Release the securing tabs and disconnect the camera cable from the camera board connector.
6. Remove the camera board.

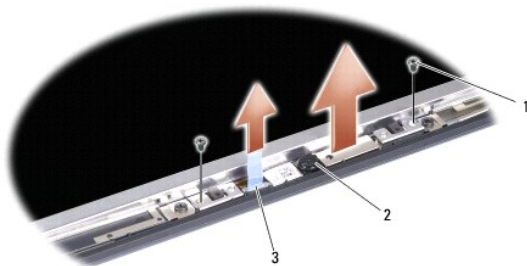

1	screw (2)	2	camera	3	camera cable pull-tab
---	-----------	---	--------	---	-----------------------

Replacing the Camera

1. Align the camera board over the screw holes.
 2. Replace the two screws that secure the camera board to the display cover.
 3. Connect the camera cable to the connector on the camera board.
 4. Replace the display bezel (see [Replacing the Display Bezel](#)).
 5. Follow the instructions in [Replacing the Display Assembly](#).
-

Center Control Cover

Dell Studio™ 1435 Service Manual

- [Removing the Center Control Cover](#)
- [Replacing the Center Control Cover](#)

- ⚠ CAUTION:** Before you begin any of the procedures in this section, follow the safety instructions that shipped with your computer.
- ➡ NOTICE:** To avoid electrostatic discharge, ground yourself by using a wrist grounding strap or by periodically touching an unpainted metal surface (such as a connector on the back of the computer).
- ➡ NOTICE:** To help prevent damage to the system board, you must remove the battery from the battery bay before you begin working inside the computer.
-

Removing the Center Control Cover

1. Follow the procedures in [Before You Begin](#).
2. Turn the computer over and remove the four screws in the battery bay.



3. Turn the computer top side up, and open the display as far as it will open.
 4. Ease the center control cover up with a plastic scribe from the back of the computer.
 5. Ease the center control cover up until you see the media control buttons cable that attaches the center control cover to the system board.
- ➡ NOTICE:** Be extremely careful when removing the center control cover. The cover along with the cable that attaches it to the system board are very fragile.

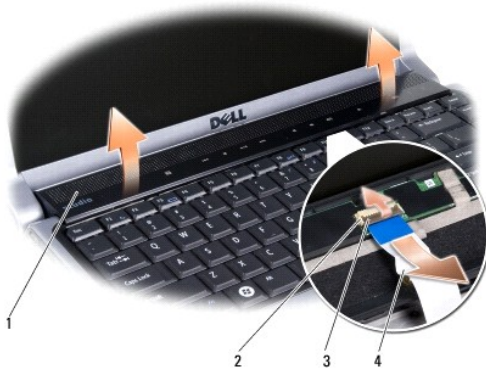

1	center control cover	2	media control buttons cable connector
3	connector latch	4	media control buttons cable

6. Release the connector latch that secures the cable to the connector on the center control cover and remove the cable.
 7. Lift the center control cover off the computer.
-

Replacing the Center Control Cover

1. Slide the media control buttons cable into the connector on the center control cover until it is in position and pull down on the connector latch that secures the cable to the connector.
 2. Align the hooks beneath the center control cover and snap the cover in place.
 3. Turn the computer over and replace the four screws that secure the center control cover to the computer base.
 4. Slide the battery into the bay until it clicks into place.
-

[Back to Contents Page](#)

Coin-Cell Battery

Dell Studio™ 1435 Service Manual

- [Removing the Coin-Cell Battery](#)
- [Replacing the Coin-Cell Battery](#)

- ⚠ CAUTION:** Before you begin any of the procedures in this section, follow the safety instructions that shipped with your computer.
- 👉 NOTICE:** To avoid electrostatic discharge, ground yourself by using a wrist grounding strap or by periodically touching an unpainted metal surface (such as a connector on the back of the computer).
- 👉 NOTICE:** To help prevent damage to the system board, you must remove the battery from the battery bay before you begin working inside the computer.
-

Removing the Coin-Cell Battery

1. Follow the procedures in [Before You Begin](#).
2. Turn the computer over and remove the base cover (see [Removing the Base Cover](#)).
3. Remove the center control cover (see [Removing the Center Control Cover](#)).
4. Remove the keyboard (see [Removing the Keyboard](#)).
5. Remove the palm rest (see [Removing the Palm Rest](#)).
6. Disconnect the coin-cell battery cable from the connector on the system board.
7. Remove the coin-cell battery.

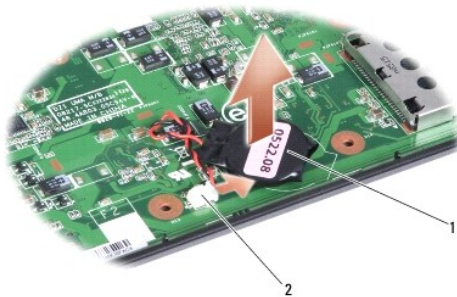

1	coin-cell battery	2	coin-cell battery cable connector
---	-------------------	---	-----------------------------------

Replacing the Coin-Cell Battery

1. Replace the coin-cell battery and connect the coin-cell battery cable to the connector on the system board.
 2. Replace the palm rest (see [Replacing the Palm Rest](#)).
 3. Replace the keyboard (see [Replacing the Keyboard](#)).
 4. Replace the center control cover (see [Replacing the Center Control Cover](#)).
 5. Replace the base cover (see [Replacing the Base Cover](#)).
 6. Slide the battery into the bay until it clicks into place.
-

Processor

Dell Studio™ 1435 Service Manual

- [Removing the Processor](#)
- [Installing the Processor](#)

- ⚠ CAUTION:** Before working inside your computer, follow the safety instructions that shipped with your computer.
- ➡ NOTICE:** To avoid electrostatic discharge, ground yourself by using a wrist grounding strap or by periodically touching an unpainted metal surface (such as a connector on the back of the computer).
- ➡ NOTICE:** To prevent intermittent contact between the ZIF-socket cam screw and the processor when removing or replacing the processor, press to apply slight pressure to the center of the processor while turning the cam screw.
- ➡ NOTICE:** To avoid damage to the processor, hold the screwdriver so that it is perpendicular to the processor when turning the cam screw.

Removing the Processor

1. Follow the instructions in [Before You Begin](#).
 2. Turn the computer over and remove the base cover (see [Removing the Base Cover](#)).
 3. Remove the fan (see [Removing the Fan](#)).
 4. Remove the processor heat sink (see [Removing the Processor Heat Sink](#)).
- ➡ NOTICE:** When removing the processor, pull it straight up. Be careful not to bend the pins on the processor.
5. Using a flathead screwdriver, rotate the processor release latch counterclockwise to release the processor from the processor socket.
 6. Use a processor extraction tool to remove the processor.

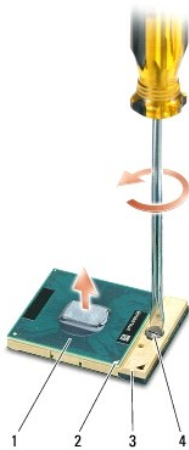

1	processor	2	pin-1 corner of processor	3	ZIF socket
4	ZIF-socket cam screw				

Installing the Processor

- ➡ NOTICE:** Ensure that the cam lock is in the fully open position before seating the processor. Seating the processor properly in the ZIF socket does not require force.
- ➡ NOTICE:** A processor that is not properly seated can result in an intermittent connection or permanent damage to the processor and ZIF socket.

1. Align the pin-1 corner of the processor so that it points to the triangle on the ZIF socket, and insert the processor into the ZIF socket.

When the processor is correctly seated, all four corners are aligned at the same height. If one or more corners of the processor are higher than the others, the processor is not seated correctly.

🔍 **NOTICE:** To prevent intermittent contact between the ZIF-socket cam screw and the processor when removing or replacing the processor, press to apply slight pressure to the center of the processor while turning the cam screw.

2. Tighten the ZIF socket by turning the cam screw clockwise to secure the processor to the system board.
3. Peel the backing off the thermal cooling pad and adhere the pad to the portion of the processor heat sink that covers the processor.
4. Replace the processor heat sink (see [Replacing the Processor Heat Sink](#)).
5. Replace the fan ([Replacing the Fan](#)).
6. Replace the base cover (see [Replacing the Base Cover](#)).
7. Slide the battery into the bay until it clicks into place.
8. Update the BIOS using a flash BIOS-update program CD. See ([Flashing the BIOS](#)).

[Back to Contents Page](#)

Processor Heat Sink

Dell Studio™ 1435 Service Manual

- [Removing the Processor Heat Sink](#)
- [Replacing the Processor Heat Sink](#)

⚠ CAUTION: Before working inside your computer, follow the safety instructions that shipped with your computer.

👉 NOTICE: To avoid electrostatic discharge, ground yourself by using a wrist grounding strap or by periodically touching an unpainted metal surface (such as a connector on the back of the computer).

Removing the Processor Heat Sink

1. Follow the instructions in [Before You Begin](#).
2. Turn the computer over and remove the base cover (see [Removing the Base Cover](#)).
3. Remove the fan (see [Removing the Fan](#)).
4. Loosen the five captive screws that secure the processor heat sink to the system board.

🔧 NOTE: According to the configuration you ordered, the number of screws may differ.

5. Lift the processor heat sink off the computer.

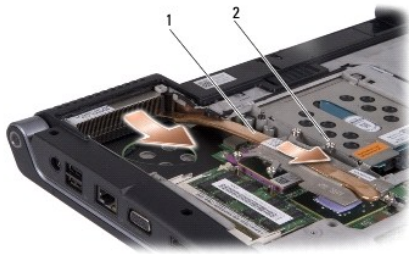

1	processor heat sink	2	captive screw (5)
---	---------------------	---	-------------------

Replacing the Processor Heat Sink

⚠ CAUTION: Before working inside your computer, follow the safety instructions that shipped with your computer.

👉 NOTICE: To prevent static damage to components inside your computer, discharge static electricity from your body before you touch any of your computer's electronic components. You can do so by touching an unpainted metal surface.

🔧 NOTE: The original pad can be reused if the original processor and heat sink are reinstalled together. If either the processor or heat sink is replaced, use the thermal pad provided in the kit to ensure that thermal conductivity is achieved.

🔧 NOTE: This procedure assumes that you have already removed the processor heat sink and are ready to replace it.

1. Peel the backing off the thermal cooling pad and adhere the pad to the portion of the heat sink that covers the processor.
 2. Place the processor heat sink on the system board.
 3. Tighten the five captive screws that secure the processor heat sink to the system board.
 4. Replace the base cover (see [Replacing the Base Cover](#)).
 5. Slide the battery into the bay until it clicks into place.
-

[Back to Contents Page](#)

Display

Dell Studio™ 1435 Service Manual

- [Display Assembly](#)
- [Display Bezel](#)
- [Display Panel](#)
- [Display Panel Cable](#)
- [Inverter Board](#)

⚠ CAUTION: Before you begin any of the procedures in this section, follow the safety instructions that shipped with your computer.

👉 NOTICE: To avoid electrostatic discharge, ground yourself by using a wrist grounding strap or by periodically touching an unpainted metal surface (such as a connector on the back of the computer).

👉 NOTICE: To help prevent damage to the system board, you must remove the battery from the battery bay before you begin working inside the computer.

Display Assembly

Removing the Display Assembly

1. Follow the instructions in [Before You Begin](#).
2. Remove the center control cover (see [Removing the Center Control Cover](#)).
3. Remove the base cover (see [Removing the Base Cover](#)).
4. Remove the keyboard (see [Removing the Keyboard](#)).
5. Remove the palm rest (see [Removing the Palm Rest](#)).
6. Remove the optical drive (see [Removing the Optical Drive](#)).
7. Remove the two screws from the computer base.



8. Make note of the routing guides and remove the antenna cables.

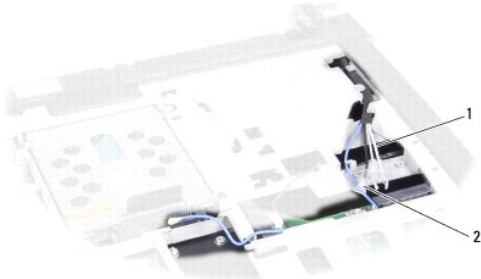

1	WLAN antenna cables	2	WPAN antenna cable
---	---------------------	---	--------------------

9. Remove the screw that secures the display cable and disconnect the cable from the system board connector.
10. Disconnect the camera cable (optional) and the power button cable.

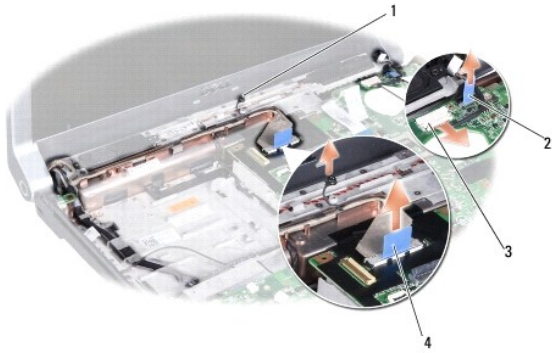

1	display cable screw	2	camera cable pull-tab (optional)
3	power button cable connector	4	display cable pull-tab

11. Remove the two screws (one on each hinge).
12. Remove the display assembly.

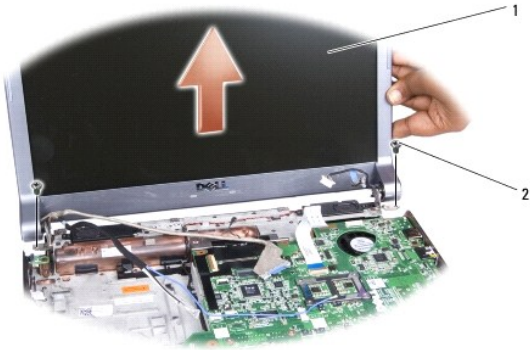

1	display assembly	2	screw (2)
---	------------------	---	-----------

Replacing the Display Assembly

1. Place the display assembly in position and replace the two screws.
2. Route the camera cable (optional), power button cable, and display cable through the routing guides and connect the cables to the respective system board connectors.
3. Replace the screw that secures the display cable.
4. Route the Mini-Card antenna cables through the routing guides.
5. Replace the two screws at the base of the computer.
6. Replace the optical drive (see [Replacing the Optical Drive](#)).
7. Replace the palm rest (see [Replacing the Palm Rest](#)).
8. Replace the keyboard (see [Replacing the Keyboard](#)).
9. Replace the center control cover (see [Replacing the Center Control Cover](#)).
10. Replace the base cover (see [Replacing the Base Cover](#)).

➡ **NOTICE:** Before turning on the computer, replace all screws and ensure that no stray screws remain inside the computer. Failure to do so may result in damage to the computer.

11. Slide the battery into the bay until it clicks into place.
-

Display Bezel

Removing the Display Bezel

 **NOTICE:** The display bezel is extremely fragile. Be careful when removing it to prevent damaging the bezel.

1. Follow the instructions in [Removing the Display Assembly](#).
2. Using your fingertips, carefully pry up the inside edge of the display bezel.
3. Remove the display bezel.



1	display bezel
---	---------------

Replacing the Display Bezel

1. Align the display bezel over the display panel, and gently snap the bezel into place.
 2. Follow the instructions in [Replacing the Display Assembly](#).
-

Display Panel

Removing the Display Panel

1. Follow the instructions in [Removing the Display Assembly](#).
2. Remove the display bezel (see [Removing the Display Bezel](#)).
3. Remove the four screws securing the display panel.
4. Remove the two screws securing the inverter board.

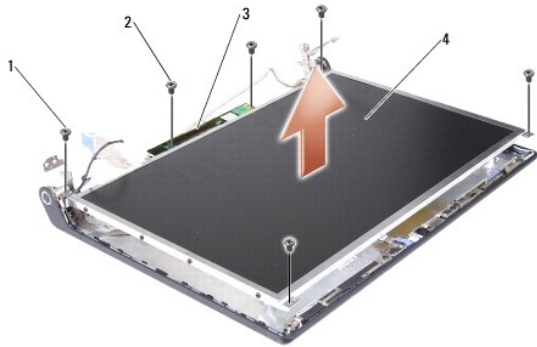

1	display panel screw (4)	2	inverter board screw (2)
3	inverter board	4	display panel

5. Remove the inverter board (see [Removing the Inverter Board](#)).
6. Remove the display panel assembly.
7. Remove the eight screws (four on either side)securing the display bracket.

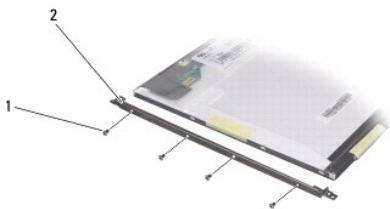

1	screw (8 total: 4 on each side)	2	display panel bracket (1 left, 1 right)
---	---------------------------------	---	---

Replacing the Display Panel

1. Attach the display brackets to the display panel by replacing the eight screws (four on either side).
2. Replace the inverter board (see [Replacing the Inverter Board](#)).
3. Align the display panel assembly and the inverter board with the display cover.
4. Replace the four screws securing the display panel assembly to the display cover.
5. Replace the two screws securing the inverter board to the display cover.
6. Replace the display bezel (see [Replacing the Display Bezel](#)).
7. Follow the instructions in [Replacing the Display Assembly](#).

Display Panel Cable

Removing the Display Panel Cable

NOTE: The Display Panel cables and connectors may differ depending on the Display Panel you ordered.

1. Follow the instructions in [Removing the Display Assembly](#).

2. Remove the display bezel (see [Removing the Display Bezel](#)).
3. Remove the display panel (see [Removing the Display Panel](#)).
4. Turn the display panel over and place it on a clean surface.

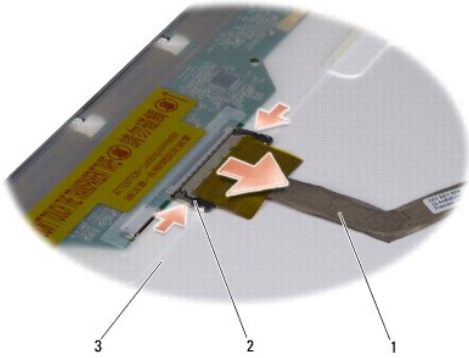

1	display cable	2	securing clip (2)
3	back of display panel		

5. Press the securing clips on either side and disconnect the display cable from the connector on top.

Replacing the Display Panel Cable

1. Connect the display cable to the connector on top.
2. Replace the display panel (see [Replacing the Display Panel](#)).
3. Replace the display bezel (see [Replacing the Display Bezel](#)).
4. Follow the instructions in [Replacing the Display Assembly](#).

Inverter Board

Removing the Inverter Board

1. Follow the instructions in [Removing the Display Assembly](#).
2. Remove the display bezel (see [Removing the Display Bezel](#)).
3. Remove the display panel (see [Removing the Display Panel](#)).
4. Turn the display panel and disconnect the cables from the connectors on either side of the inverter board.
5. Lift the inverter board off the display panel.

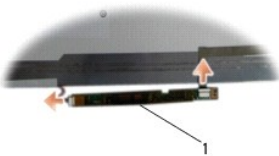

1	inverter board
---	----------------

Replacing the Inverter Board

1. Connect the cables to the connectors on either side of the inverter board.
2. Replace the display panel along with the inverter board (see [Replacing the Display Panel](#)).
3. Replace the display bezel (see [Replacing the Display Bezel](#)).
4. Follow the instructions in [Replacing the Display Assembly](#).

[Back to Contents Page](#)

Fan

Dell Studio™ 1435 Service Manual

- [Removing the Fan](#)
- [Replacing the Fan](#)

⚠ CAUTION: Before working inside your computer, follow the safety instructions that shipped with your computer.

🔌 NOTICE: To avoid electrostatic discharge, ground yourself by using a wrist grounding strap or by periodically touching an unpainted metal surface (such as a connector on the back of the computer).

Removing the Fan

1. Follow the instructions in [Before You Begin](#).
2. Turn the computer over and remove the base cover (see [Removing the Base Cover](#)).
3. Disconnect the fan cable from the system board connector.
4. Loosen the three captive screws securing the fan to the system board.
5. Lift the fan off the computer base.



1	captive screw (3)	2	fan
3	fan cable connector		

Replacing the Fan

⚠ CAUTION: Before working inside your computer, follow the safety instructions that shipped with your computer.

🔌 NOTICE: To prevent static damage to components inside your computer, discharge static electricity from your body before you touch any of your computer's electronic components. You can do so by touching an unpainted metal surface.

🔧 NOTE: The original pad can be reused if the original processor and heat sink are reinstalled together. If either the processor or heat sink is replaced, use the thermal pad provided in the kit to ensure that thermal conductivity is achieved.

🔧 NOTE: This procedure assumes that you have already removed the fan and are ready to replace it.

1. Place the fan on the computer base.
2. Tighten the three captive screws that secure the fan to the system board.
3. Connect the fan cable to the connector on the system board.
4. Replace the base cover (see [Replacing the Base Cover](#)).
5. Slide the battery into the bay until it clicks into place.

[Back to Contents Page](#)

Hard Drive

Dell Studio™ 1435 Service Manual

- [Removing the Hard Drive](#)
- [Replacing the Hard Drive](#)

⚠ CAUTION: If you remove the hard drive from the computer when the drive is hot, *do not touch* the metal housing of the hard drive.

⚠ CAUTION: Before you begin any of the procedures in this section, follow the safety instructions that shipped with your computer.

➡ NOTICE: To prevent data loss, turn off your computer (see [Turning Off Your Computer](#)) before removing the hard drive. Do not remove the hard drive while the computer is on or in Sleep state.

➡ NOTICE: Hard drives are extremely fragile. Exercise care when handling the hard drive.

➡ NOTICE: Only a certified service technician should perform repairs on your computer. Damage due to servicing that is not authorized by Dell is not covered by your warranty.

➡ NOTICE: When you disconnect a cable, pull on its connector or on its pull-tab, not on the cable itself. Some cables have connectors with locking tabs; if you are disconnecting this type of cable, press in on the locking tabs before you disconnect the cable. As you pull connectors apart, keep them evenly aligned to avoid bending any connector pins. Also, before you connect a cable, ensure that both connectors are correctly oriented and aligned.

🔧 NOTE: Dell does not guarantee compatibility or provide support for hard drives from sources other than Dell.

🔧 NOTE: If you are installing a hard drive from a source other than Dell, you need to install an operating system, drivers, and utilities on the new hard drive (see the *Dell Technology Guide*).

Removing the Hard Drive

1. Follow the procedures in [Before You Begin](#).
2. Turn the computer over and remove the base cover (see [Removing the Base Cover](#)).
3. Remove the two screws on the hard drive assembly.

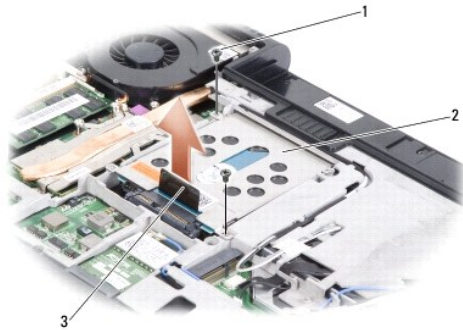

1	screw (2)	2	hard drive assembly
3	pull tab		

4. Pull the pull tab to disconnect the hard drive assembly from the system board connector.
5. Pull the interposer to detach it from the hard drive.



1	hard drive	2	interposer
3	screw (4)	4	hard drive cage

6. Remove the four screws (two on either side) to detach the hard drive cage from the hard drive.
7. Lift the hard drive cage off the hard drive.

Replacing the Hard Drive

1. Remove the new drive from its packaging.

Save the original packaging for storing or shipping the hard drive.

2. Replace the four screws (two on either side) securing the hard drive cage to the hard drive.
3. Connect the interposer to the hard drive.

 **NOTICE:** Use firm and even pressure to slide the drive into place. If you use excessive force, you may damage the connector.

4. Replace the two screws securing the hard drive assembly to the computer base.
5. Replace the base cover (see [Replacing the Base Cover](#)).

 **NOTICE:** Before turning on the computer, replace all screws and ensure that no stray screws remain inside the computer. Failure to do so may result in damage to the computer.

6. Slide the battery into the bay until it clicks into place.
7. Install the operating system for your computer, as needed (see *Dell Technology Guide*).
8. Install the drivers and utilities for your computer, as needed (see *Dell Technology Guide*).

[Back to Contents Page](#)

Keyboard

Dell Studio™ 1435 Service Manual

- [Removing the Keyboard](#)
- [Replacing the Keyboard](#)

- ⚠ CAUTION:** Before you begin any of the procedures in this section, follow the safety instructions that shipped with your computer.
- ➡ NOTICE:** To avoid electrostatic discharge, ground yourself by using a wrist grounding strap or by periodically touching an unpainted metal surface (such as a connector on the back of the computer).
- ➡ NOTICE:** To help prevent damage to the system board, you must remove the battery from the battery bay before you begin working inside the computer.
-

Removing the Keyboard

1. Follow the procedures in [Before You Begin](#).
2. Remove the center control cover (see [Removing the Center Control Cover](#)).
3. Ease the keyboard surround up with a plastic scribe.



1	keyboard surround
---	-------------------

4. Lift the keyboard surround off the computer.
- ➡ NOTICE:** The keycaps on the keyboard are fragile, easily dislodged, and time-consuming to replace. Be careful when removing and handling the keyboard.
5. Remove the two screws securing the keyboard to the palm rest.
- ➡ NOTICE:** Be extremely careful when removing and handling the keyboard. Failure to do so could result in scratching the display panel.
6. Carefully slide the keyboard out of the computer and turn it over as shown in the illustration. Do not pull hard on the keyboard.

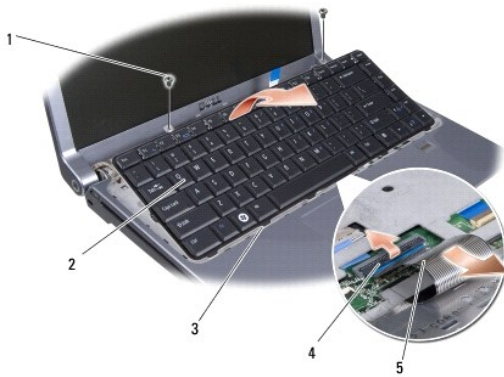

1	screw (2)	2	keyboard
3	keyboard tab (6)	4	connector latch
5	keyboard cable		

7. Rotate the keyboard downward to expose the keyboard cable.
8. Release the connector latch that secures the keyboard cable to the connector on the system board and remove the cable.
9. Lift the keyboard off the computer.

Replacing the Keyboard

1. Slide the keyboard cable into the connector on the system board and pull down on the connector latch that secures the keyboard cable to the system board.
- 👉 **NOTICE:** The keycaps on the keyboard are fragile, easily dislodged, and time-consuming to replace. Be careful when removing and handling the keyboard.
2. Align the tabs along the bottom of the keyboard with the slots of the palm rest and slide the keyboard under the palm rest.
 3. Replace the two screws at the top of the keyboard.
 4. Align the hooks beneath the keyboard surround and snap it into place.
 5. Replace the center control cover (see [Replacing the Center Control Cover](#)).
 6. Slide the battery into the bay until it clicks into place.

[Back to Contents Page](#)

Memory

Dell Studio™ 1435 Service Manual

- [Removing the Memory Module\(s\)](#)
- [Replacing the Memory Module\(s\)](#)

⚠ CAUTION: Before you begin any of the procedures in this section, follow the safety instructions that shipped with your computer.

You can increase your computer memory by installing memory modules on the system board. See "Specifications" in your *Setup Guide* for information on the memory supported by your computer. Install only memory modules that are intended for your computer.

📌 NOTE: Memory modules purchased from Dell are covered under your computer warranty.

Your computer has two user-accessible SODIMM sockets that can be accessed from the bottom of the computer. The DIMM B memory module is located directly above the DIMM A memory module located on the bottom of the computer.

➡ NOTICE: If you need to install memory modules in both connectors, install a memory module in the lower connector before you install a module in the upper connector.

Removing the Memory Module(s)

➡ NOTICE: To avoid electrostatic discharge, ground yourself by using a wrist grounding strap or by periodically touching an unpainted metal surface (such as a connector on the back of the computer).

1. Follow the procedures in [Before You Begin](#).
2. Turn the computer over and remove the base cover (see [Removing the Base Cover](#)).

➡ NOTICE: To prevent damage to the memory module connector, do not use tools to spread the memory module securing clips.

3. Use your fingertips to carefully spread apart the securing clips on each end of the memory module connector until the module pops up.
4. Remove the memory module from the connector.

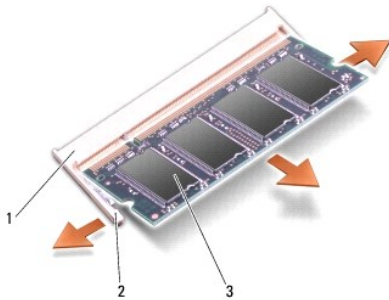

1	memory module connector	2	securing clip (2)
3	memory module		

Replacing the Memory Module(s)

➡ NOTICE: To avoid electrostatic discharge, ground yourself by using a wrist grounding strap or by periodically touching an unpainted metal surface (such as a connector on the back of the computer).

1. Align the notch in the module edge connector with the tab in the connector slot.
2. Slide the module firmly into the slot at a 45-degree angle, and press the module down until it clicks into place. If you do not feel the click, remove the module and reinstall it.

📌 NOTE: If the memory module is not installed properly, the computer may not boot.

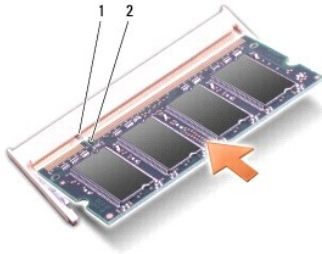

1	tab	2	notch
---	-----	---	-------

➡ **NOTICE:** If the cover is difficult to close, remove the module and reinstall it. Forcing the cover to close may damage your computer.

3. Replace the base cover (see [Replacing the Base Cover](#)).
4. Slide the battery into the battery bay until it clicks into place or connect the AC adapter to your computer and an electrical outlet.
5. Turn on the computer.

As the computer boots, it detects the additional memory and automatically updates the system configuration information.

To confirm the amount of memory installed in the computer, click **Start**  → **Help and Support** → **Dell System Information**.

[Back to Contents Page](#)

Microphone

Dell Studio™ 1435 Service Manual

- [Removing the Microphone](#)
- [Replacing the Microphone](#)

⚠ CAUTION: Before you begin any of the procedures in this section, follow the safety instructions that shipped with your computer.

🔧 NOTICE: To avoid electrostatic discharge, ground yourself by using a wrist grounding strap or by periodically touching an unpainted metal surface (such as the back panel) on the computer.

Removing the Microphone

1. Follow the instructions in [Before You Begin](#).
2. Follow the instructions in [Removing the Palm Rest](#).
3. Disconnect the microphone cable from the system board connector.
4. Remove the microphone from the computer base.



1	microphone	2	system board
3	microphone cable connector		

Replacing the Microphone

1. Place the microphone in the slot in the computer base.
2. Connect the microphone cable to the connector on the system board.
3. Follow the instructions in [Replacing the Palm Rest](#).
4. Reinstall the memory modules and Mini-Cards, if any.
5. Reinstall the ExpressCards in the ExpressCard slot, if any.

🔧 NOTICE: Before turning on the computer, replace all screws and ensure that no stray screws remain inside the computer. Failure to do so may result in damage to the computer.

Wireless Mini-Cards

Dell Studio™ 1435 Service Manual

- [Removing the Mini-Card](#)
- [Replacing the Mini-Card](#)

- ⚠ **CAUTION:** Before you begin any of the procedures in this section, follow the safety instructions that shipped with your computer.
- 🔧 **NOTICE:** To help prevent damage to the system board, you must remove the battery from the battery bay before you begin working inside the computer.
- 🔧 **NOTICE:** Only a certified service technician should perform repairs on your computer. Damage due to servicing that is not authorized by Dell™ is not covered by your warranty.
- 📌 **NOTE:** Dell does not guarantee compatibility or provide support for Mini-Cards from sources other than Dell.

If you ordered a wireless Mini-Card with your computer, the card is already installed.

Your computer supports two Mini-Card slots:

- 1 one Full Mini-Card slot – for WPAN
- 1 one Half Mini-Card slot – for WLAN

The types of Mini-Cards supported are:

- 1 Wireless Local Area Network (WLAN) — Half Mini-Card
- 1 Wireless Personal Area Network (WPAN) or Internal Card with Bluetooth® Wireless Technology — Full Mini-Card

- 📌 **NOTE:** Your computer can only support one Full Mini-Card and one Half Mini-Card at a time.
- 📌 **NOTE:** The WLAN slot supports a half Mini-Card.
- 📌 **NOTE:** Depending on the configuration of the system when it was sold, one or more of the Mini-Card slots may not have Mini-Cards installed in them.

Removing the Mini-Card

1. Follow the instructions in [Before You Begin](#).
2. Turn the computer over and remove the base cover (see [Removing the Base Cover](#)).

- 🔧 **NOTICE:** When you disconnect a cable, pull on its connector or on its pull-tab, not on the cable itself. Some cables have connectors with locking tabs; if you are disconnecting this type of cable, press in on the locking tabs before you disconnect the cable. As you pull connectors apart, keep them evenly aligned to avoid bending any connector pins. Also, before you connect a cable, ensure that both connectors are correctly oriented and aligned.

3. Disconnect the antenna cables from the Mini-Card.

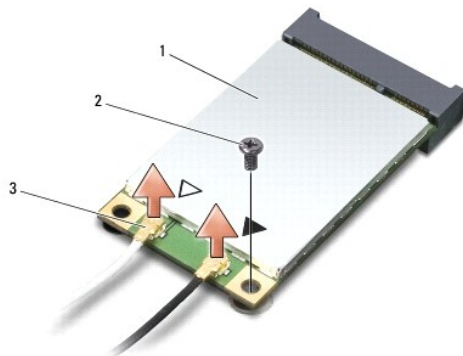

1	Mini-Card	2	screw	3	antenna cable connector (2)
---	-----------	---	-------	---	-----------------------------

- 📌 **NOTE:** If you are removing a WPAN Mini-Card, disconnect the blue antenna cable from the Mini-Card.

4. Remove the securing screw that connects the Mini-Card to the system board.

5. Lift the Mini-Card out of the system board connector.

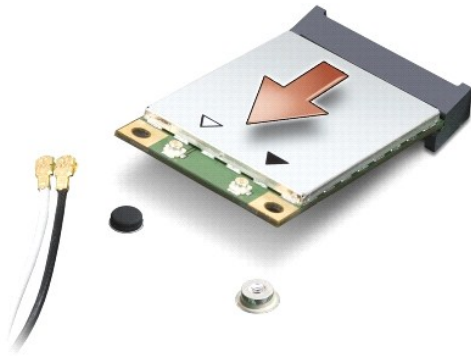

NOTICE: When the Mini-Card is not in the computer, store it in protective antistatic packaging. For more information, see "Protecting Against Electrostatic Discharge" in the safety information that shipped with your computer.

Replacing the Mini-Card

1. Remove the new Mini-Card from its packaging.

NOTICE: Use firm and even pressure to slide the card into place. If you use excessive force, you may damage the connector.

2. Insert the Mini-Card connector at a 45-degree angle into the appropriate system board connector. For example, the WLAN card connector is labeled **WLAN** and so on.
3. Press the other end of the Mini-Card down into the slot on the system board.
4. Replace the securing screw.
5. Connect the appropriate antenna cables to the Mini-Card you are installing. The following table provides the antenna cable color scheme for each Mini-Card supported by your computer.

Connectors on the Mini-Card	Antenna Cable Color Scheme
WLAN (3 antenna cables)	
Main WLAN (white triangle)	white
Auxiliary WLAN (black triangle)	black
MIMO WLAN (gray triangle)	gray
WPAN (one antenna cable)	
WPAN	blue

6. Secure the unused antenna cables in the protective mylar sleeve.
7. Replace the base cover (see [Replacing the Base Cover](#)).
8. Slide the battery into the bay until it clicks into place.
9. Install the drivers and utilities for your computer, as required. For more information, see the *Dell Technology Guide*.

NOTE: If you are installing a Mini-Card from a source other than Dell, you must install the appropriate drivers and utilities. For more generic driver information, see the *Dell Technology Guide*.

[Back to Contents Page](#)

Optical Drive

Dell Studio™ 1435 Service Manual

- [Removing the Optical Drive](#)
- [Replacing the Optical Drive](#)

⚠ CAUTION: Before you begin any of the procedures in this section, follow the safety instructions that shipped with your computer.

👉 NOTICE: To avoid electrostatic discharge, ground yourself by using a wrist grounding strap or by periodically touching an unpainted metal surface (such as the back panel) on the computer.

Removing the Optical Drive

1. Follow the instructions in [Before You Begin](#).
2. Follow the instructions in [Removing the Palm Rest](#).
3. Remove the two screws that secure the optical drive to the computer base.
4. Release the connector latch to disconnect the optical drive cable from the system board connector.
5. Lift the optical drive out of the computer base.



1	connector latch	2	optical drive
3	screw (2)		

Replacing the Optical Drive

1. Place the optical drive back in position and replace the two screws that secure the optical drive to the computer base.
 2. Connect the optical drive cable to the system board connector.
 3. Follow the instructions in [Replacing the Palm Rest](#).
-

Palm Rest

Dell Studio™ 1435 Service Manual

- [Removing the Palm Rest](#)
- [Replacing the Palm Rest](#)

⚠ CAUTION: Before you begin any of the procedures in this section, follow the safety instructions that shipped with your computer.

🔧 NOTICE: To avoid electrostatic discharge, ground yourself by using a wrist grounding strap or by periodically touching an unpainted metal surface (such as the back panel) on the computer.

Removing the Palm Rest

1. Follow the instructions in [Before You Begin](#).
2. Remove the center control cover (see [Removing the Center Control Cover](#)).
3. Remove the keyboard (see [Removing the Keyboard](#)).
4. Remove the eleven screws from the computer base.

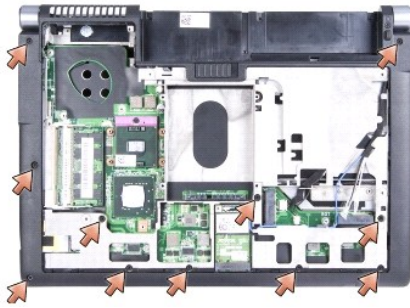

5. Remove the two screws on the top of the palm rest.
- 🔧 NOTICE:** Pull on the plastic tab on top of the connectors to avoid damaging the connectors.
6. Disconnect the power sensor cable, the touch pad cable, and the fingerprint cable (optional).

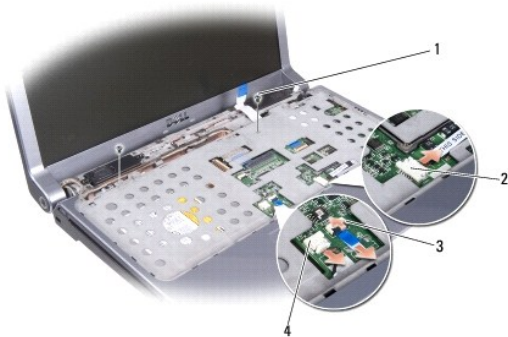

1	screw (2)	2	fingerprint cable connector
3	touch pad cable connector	4	power sensor cable connector

🔧 NOTICE: Carefully separate the palm rest from the computer base to avoid damage to the palm rest.

7. Starting at the back center of the palm rest, use your fingers to gently ease the palm rest from the computer base by lifting the inside of the palm rest

while pulling on the outside.

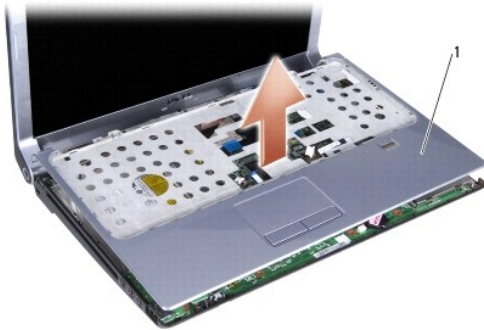

1	palm rest
---	-----------

Replacing the Palm Rest

1. Align the palm rest with the computer base and gently snap the palm rest in place.
 2. Connect the power sensor cable, touch pad cable, and fingerprint cable (optional) to the respective system board connectors.
 3. Replace the screws on the top of the palm rest.
 4. Turn the computer over and replace the eleven screws in the computer base.
 5. Replace the keyboard (see [Replacing the Keyboard](#)).
 6. Replace the center control cover (see [Replacing the Center Control Cover](#)).
 7. Replace the base cover (see [Replacing the Base Cover](#)).
 8. Slide the battery into the bay until it clicks into place.
-

[Back to Contents Page](#)

Speakers

Dell Studio™ 1435 Service Manual

- [Removing the Speakers](#)
- [Replacing the Speakers](#)

⚠ CAUTION: Before you begin any of the procedures in this section, follow the safety instructions that shipped with your computer.

👉 NOTICE: To avoid electrostatic discharge, ground yourself by using a wrist grounding strap or by periodically touching an unpainted metal surface (such as the back panel) on the computer.

Removing the Speakers

1. Follow the instructions in [Before You Begin](#).
2. Remove the center control cover (see [Removing the Center Control Cover](#)).
3. Remove keyboard (see [Removing the Keyboard](#)).
4. Remove the palm rest (see [Removing the Palm Rest](#)).
5. Remove the optical drive (see [Removing the Optical Drive](#)).
6. Remove the screw that secures the display cable.
7. Pull the display cable pull-tab to disconnect the display cable from the system board connector.
8. Remove the four screws (two on each speaker).
9. Disconnect the speaker cable from the connector on the system board.
10. Make note of the speaker cable routing.
11. Remove the speakers and the cable.

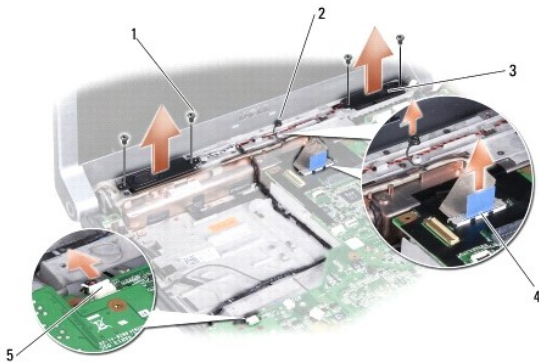

1	screw (4)	2	display cable screw	3	speaker (2)
4	display cable connector	5	speaker cable connector		

Replacing the Speakers

1. Replace the speakers and the speaker cable.
2. Connect the speaker cable to the connector on the system board.
3. Replace the four screws (two on each speaker).

4. Connect the display cable to the connector on the system board.
5. Replace the screw that secures the display cable.
6. Replace the optical drive (see [Replacing the Optical Drive](#)).
7. Replace the palm rest (see [Replacing the Palm Rest](#)).
8. Replace the keyboard (see [Replacing the Keyboard](#)).
9. Replace the center control cover (see [Replacing the Center Control Cover](#)).
10. Replace the base cover (see [Replacing the Base Cover](#)).
11. Slide the battery into the bay until it clicks into place.

[Back to Contents Page](#)

System Board

Dell Studio™ 1435 Service Manual

- [Removing the System Board](#)
- [Replacing the System Board](#)

⚠ CAUTION: Before you begin any of the procedures in this section, follow the safety instructions that shipped with your computer.

👉 NOTICE: To avoid electrostatic discharge, ground yourself by using a wrist grounding strap or by periodically touching an unpainted metal surface (such as the back panel) on the computer.

The system board's BIOS chip contains the Service Tag, which is also visible on a barcode label on the bottom of the computer. The replacement kit for the system board includes a CD that provides a utility for transferring the Service Tag to the replacement system board.

👉 NOTICE: Handle components and cards by their edges, and avoid touching pins and contacts.

Removing the System Board

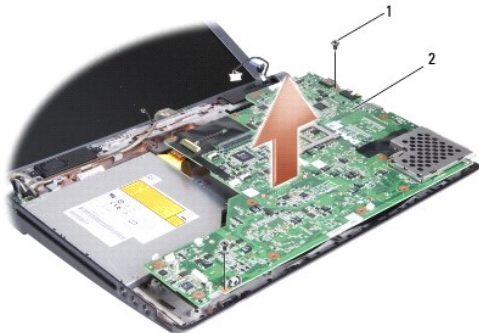

1. Follow the instructions in [Before You Begin](#).
2. Remove the hard drive (see [Removing the Hard Drive](#)).
3. Remove the processor heat sink and processor (see [Removing the Processor Heat Sink](#) and [Removing the Processor](#)).
4. Remove the center control cover (see [Removing the Center Control Cover](#)).
5. Remove the keyboard (see [Removing the Keyboard](#)).
6. Remove the palm rest (see [Removing the Palm Rest](#)).
7. Disconnect the WiFi sniffer board cable from the system board connector (see [Removing the WiFi Sniffer Board](#)).
8. Remove two screws on the system board.
9. Disconnect the speaker cable from the system board connector (see [Removing the Speakers](#)).
10. Lift the system board at an angle toward the side of the computer and out of the computer base.



1	screw (2)	2	system board
---	-----------	---	--------------

Replacing the System Board

1. Replace the system board in the computer base.
2. Replace the two screws that secure the system board to the computer base.
3. Connect the WiFi sniffer board cable to the system board connector (see [Replacing the WiFi Sniffer Board](#)).

4. Connect the speaker cable to the system board connector (see [Replacing the Speakers](#)).
 5. Replace the palm rest (see [Replacing the Palm Rest](#)).
 6. Replace the keyboard (see [Replacing the Keyboard](#)).
 7. Replace the center control cover (see [Replacing the Center Control Cover](#)).
 8. Replace the processor heat sink and processor (see [Replacing the Processor Heat Sink](#) and [Installing the Processor](#)).
 9. Replace the hard drive (see [Replacing the Hard Drive](#)).
 10. Reinstall the memory modules and Mini-Cards, if any.
 11. Reinstall the ExpressCards in the ExpressCard slot, if any.
 12. Turn on the computer.
 -  **NOTICE:** Before turning on the computer, replace all screws and ensure that no stray screws remain inside the computer. Failure to do so may result in damage to the computer.
 -  **NOTE:** After you have replaced the system board, enter the computer Service Tag into the BIOS of the replacement system board.
 13. Insert the CD that accompanied the replacement system board into the appropriate drive. Follow the instructions that appear on the screen.
-

[Back to Contents Page](#)

WiFi Sniffer Board

Dell Studio™ 1435 Service Manual

- [Removing the WiFi Sniffer Board](#)
- [Replacing the WiFi Sniffer Board](#)

Removing the WiFi Sniffer Board

1. Follow the instructions in [Before You Begin](#).
2. Remove the center control cover (see [Removing the Center Control Cover](#)).
3. Remove the keyboard (see [Removing the Keyboard](#)).
4. Remove the palm rest (see [Removing the Palm Rest](#)).
5. Remove the screw on WiFi sniffer board.

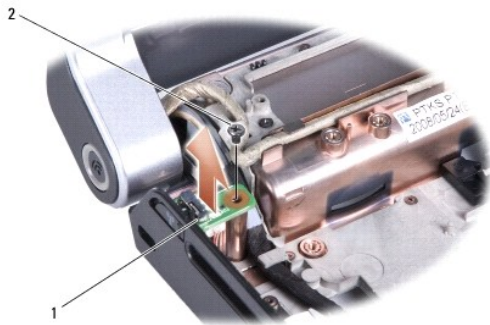

1	WiFi sniffer board	2	screw
---	--------------------	---	-------

6. Turn the computer over and disconnect the WiFi sniffer board cable from the system board connector.
7. Lift the WiFi sniffer board out of the computer base.



1	WiFi sniffer board cable connector
---	------------------------------------

Replacing the WiFi Sniffer Board

1. Replace the screw on the WiFi sniffer board.

2. Connect the WiFi sniffer board cable to the system board connector.
 3. Replace the palm rest (see [Replacing the Palm Rest](#)).
 4. Replace the keyboard (see [Replacing the Keyboard](#)).
 5. Replace the center control cover (see [Replacing the Center Control Cover](#)).
 6. Replace the base cover (see [Replacing the Base Cover](#)).
 7. Slide the battery into the bay until it clicks into place.
-

[Back to Contents Page](#)

Free Manuals Download Website

<http://myh66.com>

<http://usermanuals.us>

<http://www.somanuals.com>

<http://www.4manuals.cc>

<http://www.manual-lib.com>

<http://www.404manual.com>

<http://www.luxmanual.com>

<http://aubethermostatmanual.com>

Golf course search by state

<http://golfingnear.com>

Email search by domain

<http://emailbydomain.com>

Auto manuals search

<http://auto.somanuals.com>

TV manuals search

<http://tv.somanuals.com>