

# Dell™ XPS M140 Service Manual

[Before You Begin](#)

[System Components](#)

[Internal Card With Bluetooth® Wireless Technology](#)

[Hard Drive](#)

[Optical Drive](#)

[Memory Module and Modem](#)

[Hinge Cover](#)

[Keyboard](#)

[Coin-Cell Battery](#)

[Wireless Mini PCI Card](#)

[Display Assembly and Display Latch](#)

[Palm Rest](#)

[Microprocessor Thermal-Cooling Assembly](#)

[Fan](#)

[Microprocessor Module](#)

[Speakers](#)

[System Board](#)

[BIOS Updates](#)

[Pin Assignments for I/O Connectors](#)

---

## Notes, Notices, and Cautions



**NOTE:** A NOTE indicates important information that helps you make better use of your computer.



**NOTICE:** A NOTICE indicates either potential damage to hardware or loss of data and tells you how to avoid the problem.



**CAUTION:** A CAUTION indicates a potential for property damage, personal injury, or death.

---

**Information in this document is subject to change without notice.**

**© 2005 Dell Inc. All rights reserved.**

Reproduction in any manner whatsoever without the written permission of Dell Inc. is strictly forbidden.

Trademarks used in this text: *Dell*, the *DELL* logo, and *Inspiron* are trademarks of Dell Inc.; *Intel* is a registered trademark of Intel Corporation; *Microsoft* and *Windows* are registered trademarks of Microsoft Corporation; *Bluetooth* is a trademark owned by Bluetooth SIG, Inc. and is used by Dell Inc. under license.

Other trademarks and trade names may be used in this document to refer to either the entities claiming the marks and names or their products. Dell Inc. disclaims any proprietary interest in trademarks and trade names other than its own.

**Model PP19L**







**October 2005 Rev. A00**

# Before You Begin

## Dell™ XPS M140 Service Manual

- [Preparing to Work Inside the Computer](#)
  - [Recommended Tools](#)
  - [Computer Orientation](#)
  - [Screw Identification](#)
- 

## Preparing to Work Inside the Computer

-  **CAUTION:** Before you perform any of the procedures in this section, follow the safety instructions in the *Product Information Guide*.
-  **NOTICE:** Only a certified service technician should perform repairs on your computer. Damage due to servicing that is not authorized by Dell is not covered by your warranty.
-  **NOTICE:** To avoid electrostatic discharge, ground yourself by using a wrist grounding strap or by periodically touching an unpainted metal surface (such as the back panel) on the computer.
-  **NOTICE:** Handle components and cards with care. Do not touch the components or contacts on a card. Instead, hold a card by its edges or by its metal mounting bracket. Hold a component such as a microprocessor by its edges, not by its pins.
-  **NOTICE:** When disconnecting a cable, pull on the cable's connector or on its strain-relief loop, not on the cable itself. Some cables have connectors with locking tabs; before disconnecting this type of cable, press inward on the locking tabs to release the connector. When connecting or disconnecting a cable, ensure that the connectors are correctly oriented and aligned to avoid damage to the connector and/or the connector's pins.
-  **NOTICE:** To avoid damaging the computer, always perform the following steps before you begin working inside the computer.
1. Ensure that the work surface is flat and clean to prevent scratching the computer cover.
  2. Save any work in progress and exit all open programs.
  3. Turn off the computer and all attached devices.
-  **NOTE:** Ensure that the computer is off and not in a power management mode. If you cannot shut down the computer using the operating system, press and hold the power button for 4 seconds.
4. Disconnect the computer from the electrical outlet.

➡ NOTICE: To avoid damaging the system board, wait 10 to 20 seconds before disconnecting any attached devices.

5. Disconnect all attached devices.
6. Disconnect all external cables from the computer.
7. Close the display and turn the computer upside down on a flat work surface.

➡ NOTICE: To avoid damaging the system board, you must remove the main battery before servicing the computer.

8. Slide and hold the battery bay latch release on the bottom of the computer, then pull the battery out of the battery bay.

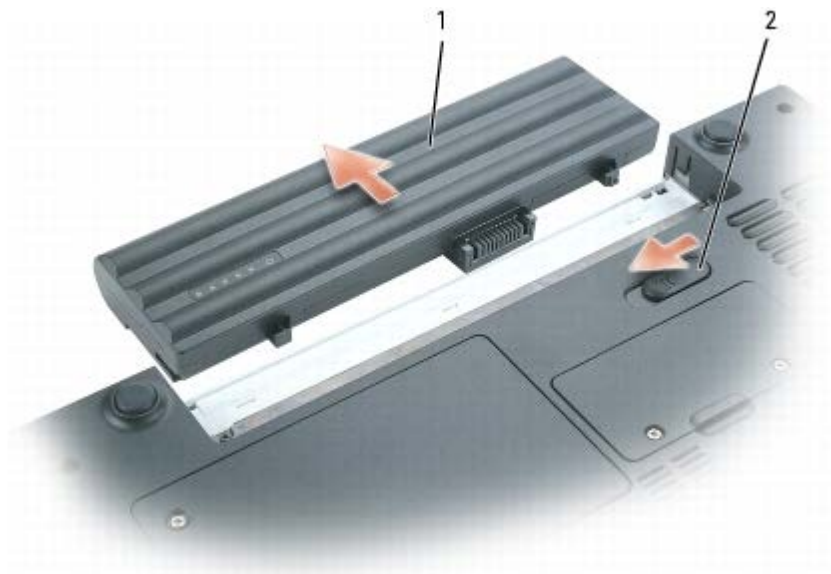

1	battery	2	battery bay latch release		
---	---------	---	---------------------------	--	--

---

## Recommended Tools

The procedures in this document will require one or more of the following tools:

- Small flat-blade screwdriver
  - Phillips screwdriver
  - Small plastic scribe
  - Flash BIOS update (see the Dell support website at [support.dell.com](http://support.dell.com))
-

# Computer Orientation





1	front	2	left	3	back
4	right				

## Screw Identification

The following chart provides the number of screws used to secure the various system components and their corresponding sizes. When removing and replacing components, print the screw identification chart as a placemat to lay out and keep track of the screws.



<p>Optical Drive: (1 each – optional)</p>  <p><i>M2.5 x 8 mm</i></p>	<p>Modem: (1 each)</p>  <p><i>M2 x 3 mm</i></p>	<p>Bluetooth Module: (1 each)</p>  <p><i>M2 x 3 mm</i></p>
---	--	---

Hinge Cover:

(2 each)



*M2 x 3 mm*

Display Assembly:

(4 each)



*M2.5 x 5 mm*

Display Bezel (screw):

(6 each)



*M2.5 x 5 mm*

Display Bezel (rubber bumper):

(6 each)



Display Panel:

(6 each)



*M2 x 3 mm*

Palm Rest (top):

(4 each)



*M2.5 x 5 mm*

Palm Rest (bottom):

(11 each)



*M2.5 x 8 mm*

Fan:

(3 each)



*M2.5 x 5 mm*

Speakers:

(3 total)



*M2.5 x 5 mm*

System Board (top):

(1 each)



*M2.5 x 5 mm*

System Board (bottom):

(2 each)



*M2 x 3 mm*

---

---

[Back to Contents Page](#)

# System Components

## Dell™ XPS M140 Service Manual

- ⓘ NOTICE: Only a certified service technician should perform repairs on your computer. Damage due to servicing that is not authorized by Dell is not covered by your warranty.
- 

## Exploded View of the Computer

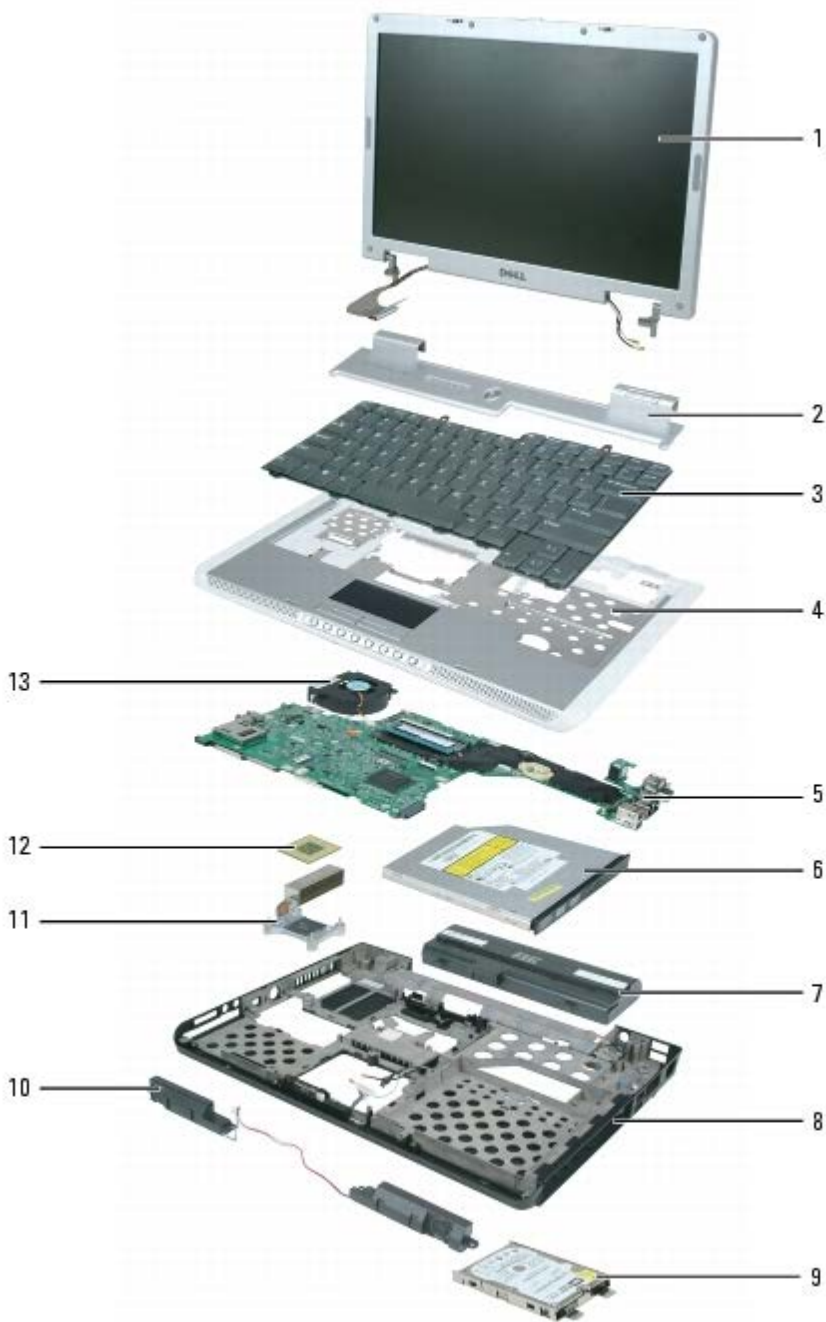

1	display assembly	6	optical drive	11	microprocessor thermal-cooling assembly
2	hinge cover	7	main battery	12	microprocessor
3	keyboard	8	computer base	13	fan
4	palm rest (with touch pad)	9	hard drive		
5	system board	10	speakers		





# Internal Card With Bluetooth® Wireless Technology

## Dell™ XPS M140 Service Manual

- [Removing the Bluetooth Module](#)
- [Replacing the Bluetooth Module](#)

 **NOTE:** If you ordered the optional internal card with Bluetooth wireless technology at the same time that you ordered your computer, the card is already installed.

---

## Removing the Bluetooth Module

 **CAUTION:** Before you perform any of the procedures in this section, follow the safety instructions in the *Product Information Guide*.

 **NOTICE:** To avoid electrostatic discharge, ground yourself by using a wrist grounding strap or by periodically touching an unpainted metal surface (such as the back panel) on the computer.

1. Follow the instructions in [Preparing to Work Inside the Computer](#).
2. Loosen the two captive screws on the modem/Mini PCI/wireless cover, then remove the cover and set it aside.



1	modem/Mini PCI/wireless cover	2	captive screws (2)		
---	-------------------------------	---	--------------------	--	--

3. Remove the M2 x 3-mm screw securing the Bluetooth module and set it aside.



1	Bluetooth module	2	M2 x 3-mm screw		
---	------------------	---	-----------------	--	--

4. Lift the Bluetooth module from its compartment.

5. Grasp the card and gently pull it apart from the connector cable.

 NOTE: Do not disconnect the Bluetooth connector cable from the system board.

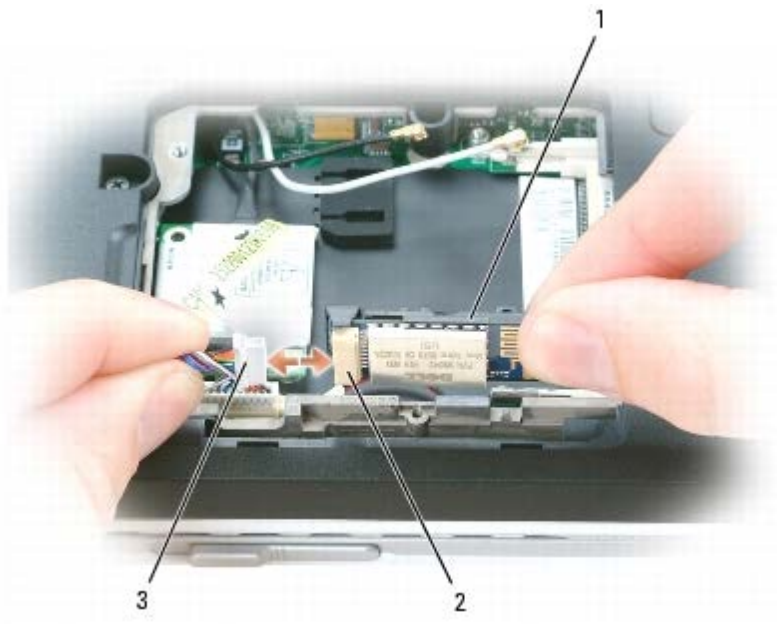

1	Bluetooth module	2	Bluetooth module connector	3	Bluetooth connector cable
---	------------------	---	----------------------------	---	---------------------------

# Replacing the Bluetooth Module

 **CAUTION:** Before you perform any of the procedures in this section, follow the safety instructions in the *Product Information Guide*.

 **NOTICE:** To avoid electrostatic discharge, ground yourself by using a wrist grounding strap or by periodically touching an unpainted metal surface (such as the back panel) on the computer.

1. Follow the instructions in [Preparing to Work Inside the Computer](#).
2. Follow the instructions in [Removing the Bluetooth Module](#), as applicable.
3. Connect the new Bluetooth module to the connector cable.
4. Place the Bluetooth module in its compartment.
5. Replace the M2 x 3-mm screw to secure the Bluetooth module to the base of the computer.
6. Replace the modem/Mini PCI/wireless cover and tighten the screws.

---







[Back to Contents Page](#)

# Hard Drive

## Dell™ XPS M140 Service Manual

- [Removing the Hard Drive](#)
  - [Replacing the Hard Drive](#)
  - [Returning a Hard Drive to Dell](#)
- 

## Removing the Hard Drive

-  **CAUTION:** Before you perform any of the procedures in this section, follow the safety instructions in the *Product Information Guide*.
-  **CAUTION:** *Do not touch* the metal housing of the hard drive if you remove the hard drive from the computer while the drive is hot.
-  **NOTICE:** To prevent data loss, turn off your computer before removing the hard drive. Do not remove the hard drive while the computer is on, in standby mode, or in hibernate mode.
-  **NOTICE:** To avoid electrostatic discharge, ground yourself by using a wrist grounding strap or by periodically touching an unpainted metal surface (such as the back panel) on the computer.
-  **NOTICE:** To avoid damaging the hard drive, handle the drive with care.
-  **NOTE:** Dell does not guarantee compatibility or provide support for hard drives obtained from sources other than Dell.
-  **NOTE:** If you are installing a hard drive obtained from a source other than Dell, you may need to install an operating system, drivers, and utilities on the new drive.

1. Follow the instructions in [Preparing to Work Inside the Computer](#).
2. Loosen the two captive screws securing the hard drive cover, then remove the cover and set it aside.

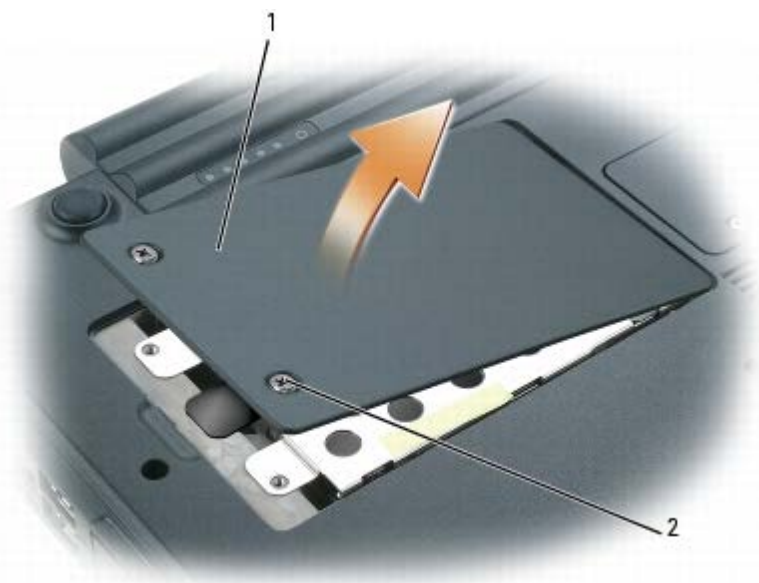

1	hard drive cover	2	captive screws (2)		
---	------------------	---	--------------------	--	--

➡ **NOTICE:** When the hard drive is not in the computer, store it in protective, antistatic packaging. See "Protecting Against Electrostatic Discharge" in the *Product Information Guide*.

- Use the pull-tab to slide the hard drive toward the screw holes, then lift the drive straight up to remove it from the computer.

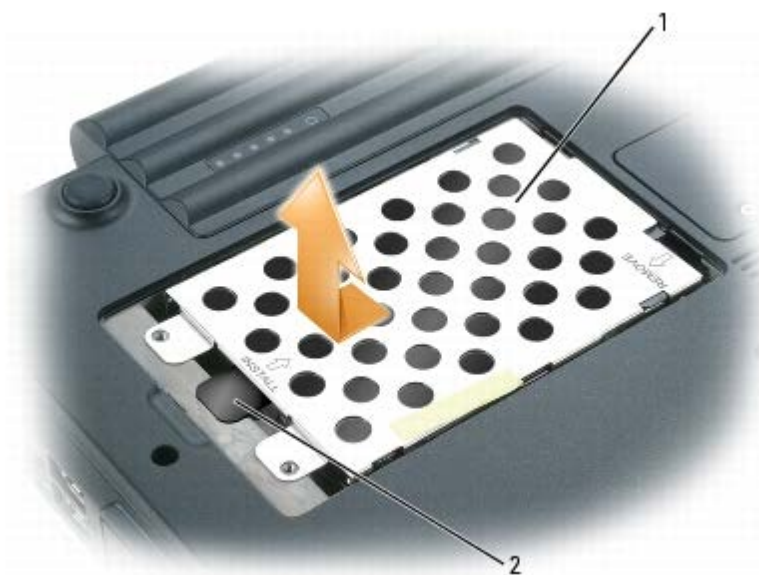

1	hard drive	2	pull tab		
---	------------	---	----------	--	--

## Replacing the Hard Drive

⚠ **CAUTION:** Before you perform any of the procedures in this section, follow the safety instructions in the *Product Information Guide*.

➡ NOTICE: To avoid electrostatic discharge, ground yourself by using a wrist grounding strap or by periodically touching an unpainted metal surface (such as the back panel) on the computer.

1. Follow the instructions in [Preparing to Work Inside the Computer](#).
2. Follow the instructions in [Removing the Hard Drive](#).

➡ NOTICE: Use firm and even pressure when sliding the hard drive into place. Excessive force may result in damage to the connector.

3. Place the new hard drive into the bay, then slide it away from the screw holes into the connector until it is fully seated.
4. Replace the hard drive cover and tighten the screws.
5. Install the operating system for your computer, if necessary (see "Restoring Your Operating System" in your *Owner's Manual*).
6. Install the drivers and utilities for your computer, if necessary (see "Reinstalling Drivers and Utilities" in your *Owner's Manual*).

---

## Returning a Hard Drive to Dell

Return your hard drive to Dell in the replacement drive's foam packaging. Otherwise, the hard drive may be damaged in transit.

📌 NOTE: The hard drive should be inserted in the replacement drive's antistatic bag before being placed in the foam packaging.

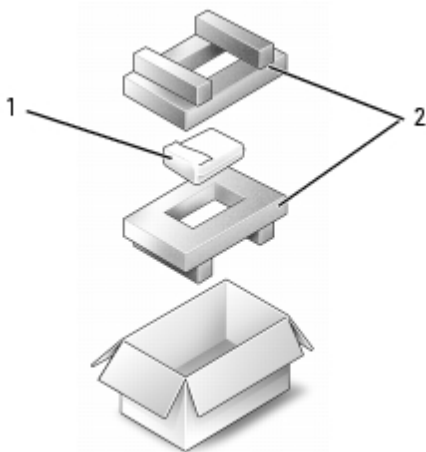

1	hard drive (in antistatic bag)	2	foam packaging		
---	--------------------------------	---	----------------	--	--





# Optical Drive

## Dell™ XPS M140 Service Manual

- [About the Device Security Screw](#)
  - [Removing the Optical Drive](#)
  - [Replacing the Optical Drive](#)
- 

## About the Device Security Screw

 **NOTE:** You do not need to install the device security screw unless you want to prevent the optical drive from being easily removed.

Your Dell™ computer ships with a CD/DVD drive installed in the optical drive bay along with an M2.5 x 8-mm device security screw. If the security screw is not already installed, it will be packaged separately. When you insert a drive into the bay, you can install the device security screw to prevent the drive from being easily removed.

---

## Removing the Optical Drive

 **CAUTION:** Before you perform any of the procedures in this section, follow the safety instructions in the *Product Information Guide*.

 **NOTICE:** To prevent damage to optical drives and other devices, store them in a safe, dry place when they are not installed in the computer. Avoid pressing down on them or placing heavy objects on top of them.

1. Follow the instructions in [Preparing to Work Inside the Computer](#).
2. Use a Phillips screwdriver to remove the M2.5 x 8-mm device security screw, if installed, from the indentation in the bottom of the computer.

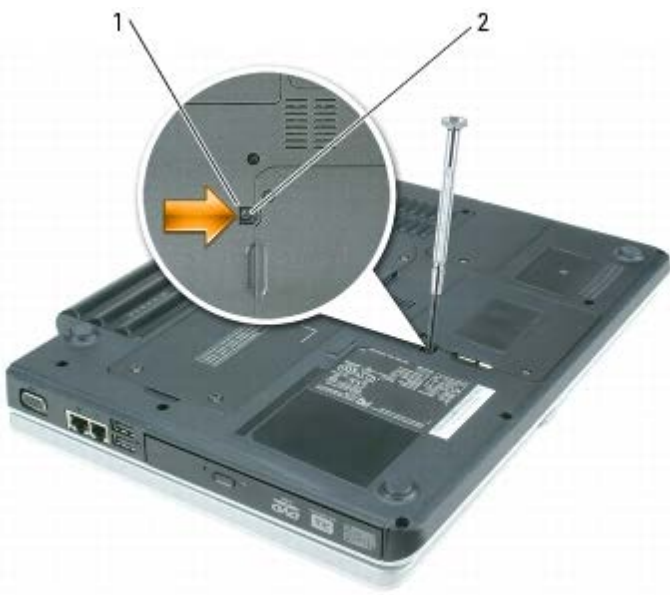

1	indention	2	M2.5 x 8-mm device security screw (optional)		
---	-----------	---	--	--	--

3. Insert the screwdriver into the indentation and push the notch on the metal tab to release the drive from the bay.



1	metal tab	2	optical drive		
---	-----------	---	---------------	--	--

4. Pull the drive out of the bay.

---

# Replacing the Optical Drive

 **CAUTION:** Before you perform any of the procedures in this section, follow the safety instructions in the *Product Information Guide*.

1. Follow the instructions in [Preparing to Work Inside the Computer](#).
2. Follow the instructions in [Removing the Optical Drive](#).
3. Slide the new drive into the bay until it snaps securely into place.
4. Replace the M2.5 x 8-mm device security screw (optional).

---

[Back to Contents Page](#)

# Memory Module and Modem

## Dell™ XPS M140 Service Manual

- [Removing a Memory Module](#)
- [Replacing a Memory Module](#)
- [Modem](#)



Your Dell computer comes equipped with two memory slots/connectors labeled DIMM A and DIMM B. DIMM A (located under the keyboard) holds the primary memory module as configured from the factory. DIMM B (located on the bottom of the computer) holds any additional memory you may have ordered. If you did not order additional memory, DIMM B will be empty.

Generally, if you are adding memory, you will install a memory module in DIMM B only. If you are upgrading the memory, you may need to install memory modules in DIMM A and DIMM B, depending on the extent of the upgrade.

 NOTE: Memory modules purchased from Dell™ are covered under your computer warranty.

---

## Removing a Memory Module

-  CAUTION: Before you perform any of the procedures in this section, follow the safety instructions in the *Product Information Guide*.
-  NOTICE: To avoid electrostatic discharge, ground yourself by using a wrist grounding strap or by periodically touching an unpainted metal surface (such as the back panel) on the computer.

### Memory Module DIMM B

1. Follow the instructions in [Preparing to Work Inside the Computer](#).
2. Loosen the two captive screws securing the memory module cover, then remove the cover and set it aside.

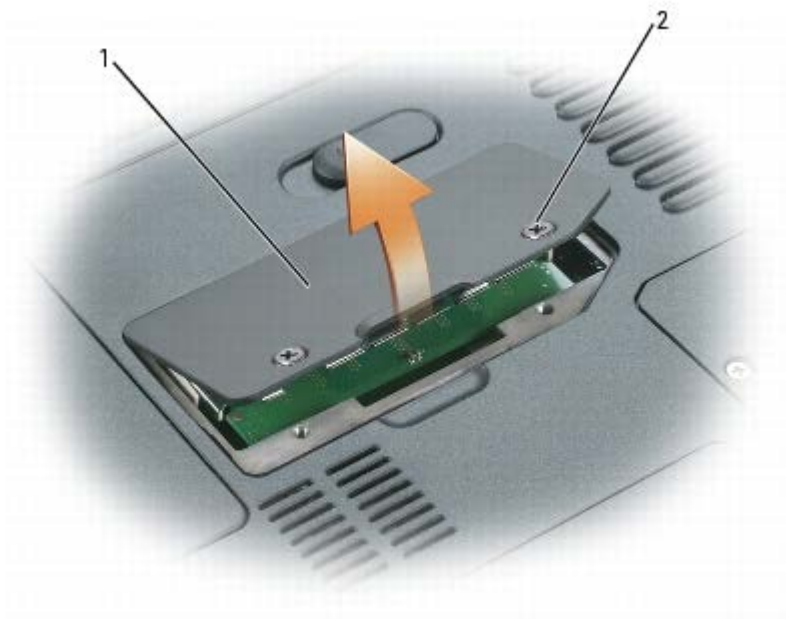

1	memory module cover	2	captive screws (2)		
---	---------------------	---	--------------------	--	--

➡ **NOTICE:** To prevent damage to the memory module connector, do not use tools of any kind to spread the metal clips that secure the module.

3. Use your fingertips to carefully spread apart the metal clips securing each end of the memory module until the module pops up.

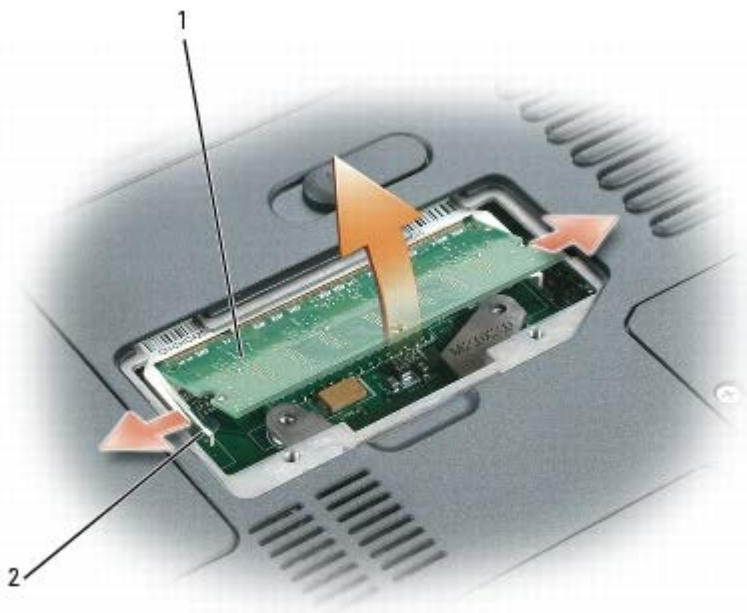

1	memory module	2	metal retention clips (2)		
---	---------------	---	---------------------------	--	--

4. Remove the module from the connector at a 45-degree angle.



## Memory Module DIMM A

1. Follow the instructions in [Preparing to Work Inside the Computer](#).
2. Remove the hinge cover (see [Removing the Hinge Cover](#)).
3. Remove the keyboard (see [Removing the Keyboard](#)).
4. Loosen the two captive screws securing the memory module cover, then remove the cover and set it aside.

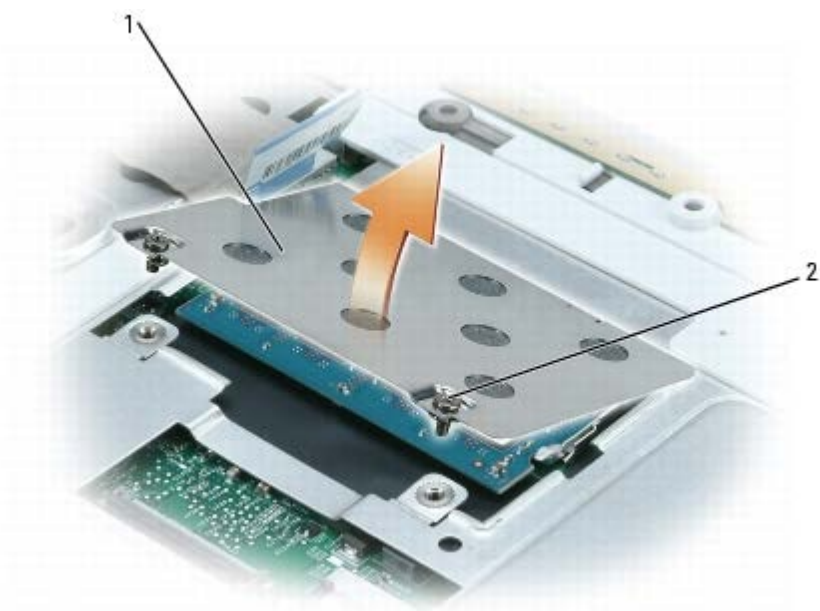

1	memory module cover	2	captive screws (2)		
---	---------------------	---	--------------------	--	--

**NOTICE:** To prevent damage to the memory module connector, do not use tools of any kind to spread the metal clips that secure the module.

5. Use your fingertips to carefully spread apart the metal clips securing each end of the memory module until the module pops up.

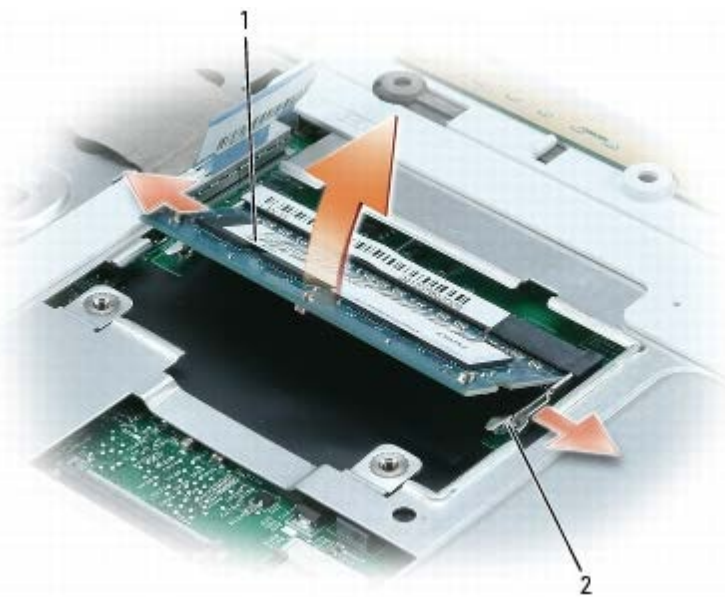

1	memory module	2	metal retention clips (2)		
---	---------------	---	---------------------------	--	--

6. Remove the memory module from the connector at a 45-degree angle.



---

## Replacing a Memory Module

- ⚠ CAUTION:** Before you perform any of the procedures in this section, follow the safety instructions in the *Product Information Guide*.
- ➡ NOTICE:** To avoid electrostatic discharge, ground yourself by using a wrist grounding strap or by periodically touching an unpainted metal surface (such as the back panel) on the computer.

➔ NOTICE: If you need to install more than one memory module, install a memory module in the memory slot labeled DIMM A before installing a module in the slot labeled DIMM B. Insert memory modules at a 45-degree angle to avoid damaging the connector.

🔧 NOTE: If a memory module is not installed properly, the computer may not boot. No error message will be displayed for this type of failure.

1. Follow the instructions in [Preparing to Work Inside the Computer](#).
2. Remove the appropriate memory module cover and memory module, if installed (see [Removing a Memory Module](#)).
3. Install the new memory module:
  - a. Align the notch in the memory module edge connector with the tab in the connector slot.
  - b. Slide the module firmly into the slot at a 45-degree angle, and then rotate the module down until it clicks into place. If you do not feel the click, remove the module and reinstall it.

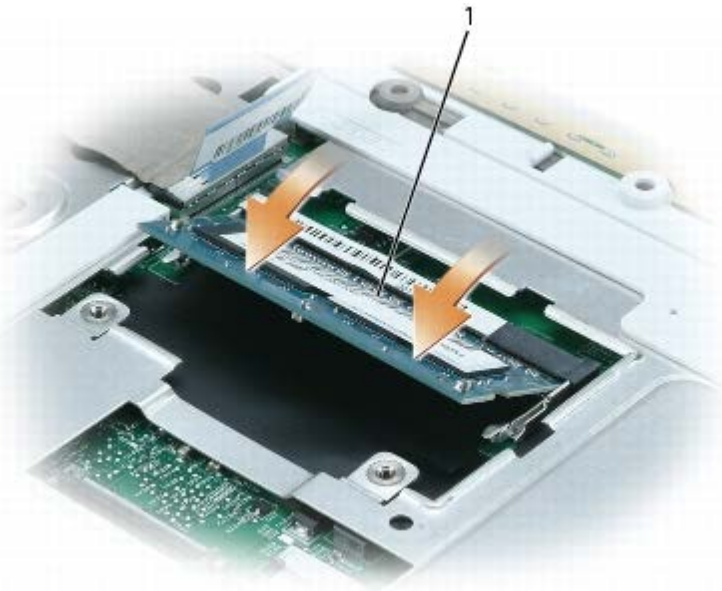

		1	memory module		
--	--	---	---------------	--	--

➔ NOTICE: If the memory module cover is difficult to close, remove the memory module and reinstall it. Forcing the cover to close may damage your computer.

4. Replace the memory module cover and tighten the screws.
5. Replace the keyboard (see [Replacing the Keyboard](#)—DIMM A only).
6. Replace the hinge cover (see [Replacing the Hinge Cover](#)—DIMM A only).

## If You Are Replacing Memory



As the computer boots, it detects the installed memory. The system configuration information remains the same.

## If You Are Adding or Upgrading Memory

As the computer boots, it detects the change in memory and automatically updates the system configuration information.

## Confirming Installed Memory

To confirm the amount of memory installed in the computer, use one of the following methods:

- Click the **Start** button, then click **Help and Support**. Under **Pick a task**, click **Use Tools to view your computer information and diagnose problems**. Under **Tools**, click **My Computer Information**, then click **Find information about the hardware installed on this computer**.
- Access the System Setup Program at startup by pressing <F2> immediately when the DELL logo appears. If you wait too long and the Microsoft® Windows® logo appears, continue to wait until you see the Windows desktop, then shut down your computer and try again. See "Using the System Setup Program" in your User's Guide.

---

## Modem

 **NOTE:** If you ordered the optional modem at the same time that you ordered your computer, the modem is already installed.

## Removing the Modem

 **CAUTION:** Before you perform any of the procedures in this section, follow the safety instructions in the *Product Information Guide*.

 **NOTICE:** To avoid electrostatic discharge, ground yourself by using a wrist grounding strap or by periodically touching an unpainted metal surface (such as the back panel) on the computer.

1. Follow the instructions in [Preparing to Work Inside the Computer](#).
2. Loosen the two captive screws on the modem/Mini PCI/wireless cover, then remove the cover and set it aside.

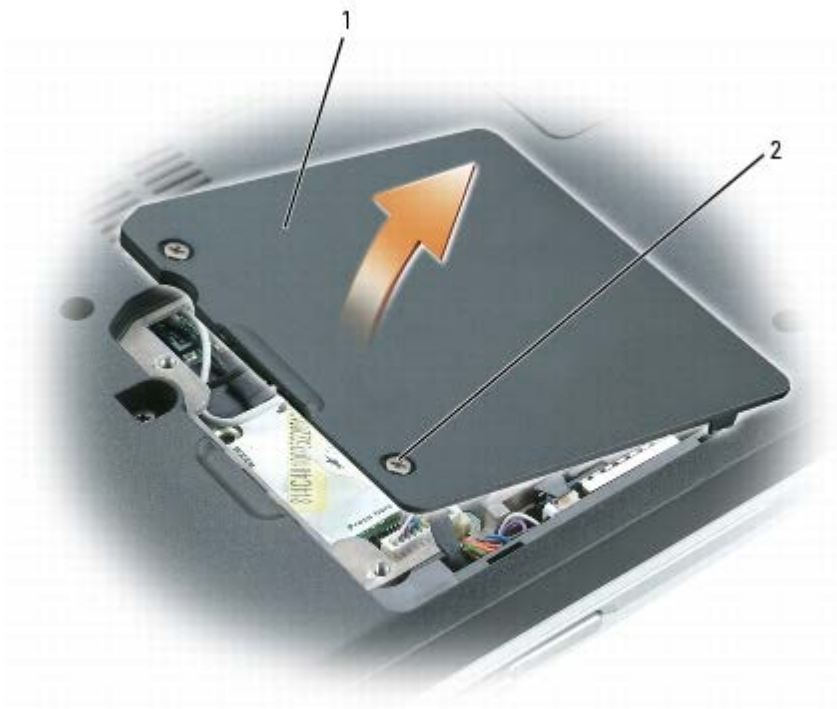

1	modem/Mini PCI/wireless cover	2	captive screws (2)		
---	-------------------------------	---	--------------------	--	--

3. Disconnect the antenna cables from the Mini PCI card, if applicable.

**NOTE:** The Mini PCI card is optional and may not be installed if one was not ordered with the computer.



	1	Mini PCI antenna cables		
--	---	-------------------------	--	--

4. Remove the M2 x 3-mm screw securing the modem to the system board and set it aside.

5. Pull straight up on the attached pull-tab to disconnect the modem from the connector on the system board.
6. Disconnect the modem cable from the modem.

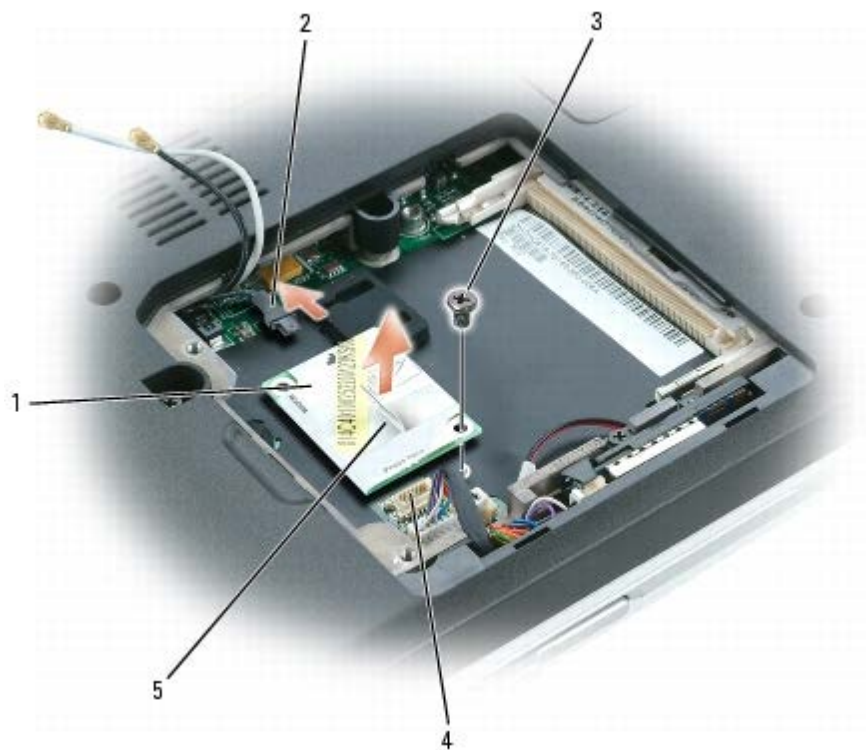

1	modem	3	M2 x 3-mm screw	5	pull tab
2	modem cable	4	system board connector		

## Replacing the Modem

**⚠ CAUTION:** Before you perform any of the procedures in this section, follow the safety instructions in the *Product Information Guide*.

**➡ NOTICE:** To avoid electrostatic discharge, ground yourself by using a wrist grounding strap or by periodically touching an unpainted metal surface (such as the back panel) on the computer.

1. Follow the instructions in [Preparing to Work Inside the Computer](#).
2. Follow the instructions in [Removing the Modem](#), as applicable.

**➡ NOTICE:** The modem connectors are keyed to ensure correct insertion. If you feel resistance, check the connectors for proper alignment.

3. Connect the modem cable to the new modem.
4. Connect the modem to the system board.

Align the modem with the screw hole and press the modem into the connector on the system board.

5. Replace the M2 x 3-mm screw and secure the modem to the system board.
6. Connect the Mini PCI antenna cables, if applicable.
7. Replace the modem/Mini PCI/wireless cover and tighten the screws.

---

[Back to Contents Page](#)

# Hinge Cover

## Dell™ XPS M140 Service Manual

- [Removing the Hinge Cover](#)
- [Replacing the Hinge Cover](#)

---

## Removing the Hinge Cover

**⚠ CAUTION:** Before you perform any of the procedures in this section, follow the safety instructions in the *Product Information Guide*.

- ➡ **NOTICE:** To avoid electrostatic discharge, ground yourself by using a wrist grounding strap or by periodically touching an unpainted metal surface (such as the back panel) on the computer.
- ➡ **NOTICE:** The hinge cover is fragile and can be damaged if extreme force is used. Exercise care when removing the hinge cover.

1. Follow the instructions in [Preparing to Work Inside the Computer](#).
2. Remove the two M2 x 3-mm screws inside the battery bay.



		1	M2 x 3-mm screws (2)		
--	--	---	----------------------	--	--

3. Turn the computer over, and then open the display all the way (180 degrees) so that it rests flat on your work surface.
4. Insert a plastic scribe into the indent along the right edge of the hinge cover to pry the hinge cover loose.
5. Moving from right to left, ease the hinge cover up and remove it from the computer.

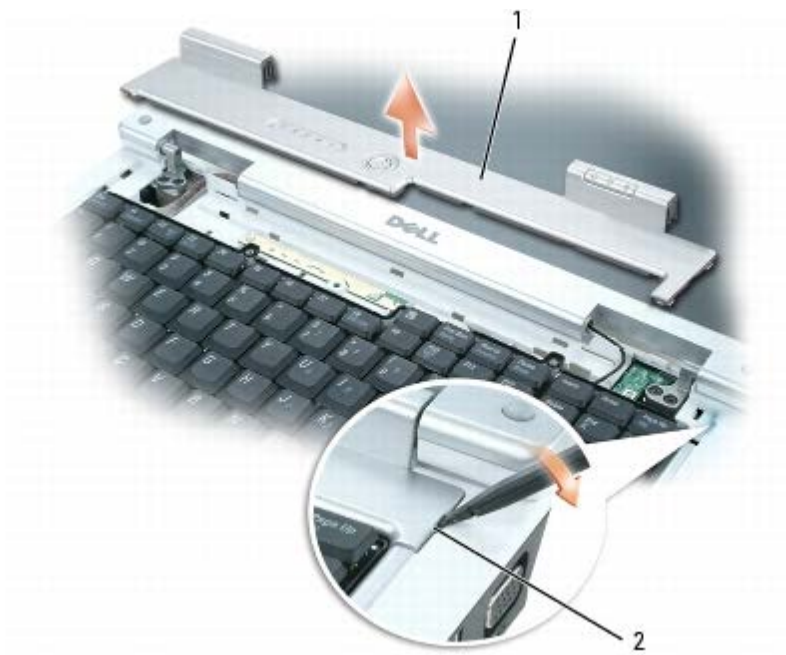

1	hinge cover	2	indent		
---	-------------	---	--------	--	--

## Replacing the Hinge Cover

**⚠ CAUTION:** Before you perform any of the procedures in this section, follow the safety instructions in the *Product Information Guide*.

**➡ NOTICE:** To avoid electrostatic discharge, ground yourself by using a wrist grounding strap or by periodically touching an unpainted metal surface (such as the back panel) on the computer.

1. Follow the instructions in [Preparing to Work Inside the Computer](#).

The hinge cover is fragile and can be damaged if extreme force is used. Exercise care when replacing the hinge cover.

2. Follow the instructions in [Removing the Hinge Cover](#).
3. Align the tabs along the left edge of the new hinge cover with the corresponding notches in the computer.
4. Moving from left to right, press down until the hinge cover snaps into place.
5. Replace the two M2 x 3-mm screws inside the battery bay to secure the hinge cover.

---

[Back to Contents Page](#)

# Keyboard

## Dell™ XPS M140 Service Manual

- [Removing the Keyboard](#)
  - [Replacing the Keyboard](#)
- 

## Removing the Keyboard

 **CAUTION:** Before you perform any of the procedures in this section, follow the safety instructions in the *Product Information Guide*.

 **NOTICE:** To avoid electrostatic discharge, ground yourself by using a wrist grounding strap or by periodically touching an unpainted metal surface (such as the back panel) on the computer.

1. Follow the instructions in [Preparing to Work Inside the Computer](#).
2. Remove the hinge cover (see [Removing the Hinge Cover](#)).

 **NOTICE:** The key caps on the keyboard are fragile, easily dislodged, and time-consuming to replace. Exercise care when removing and handling the keyboard.

3. Insert a plastic scribe or small flat-blade screwdriver near the keyboard retention tab on the left or right side of the palmrest to pry one side of the keyboard loose, then pry the remaining side of the keyboard loose, as necessary.

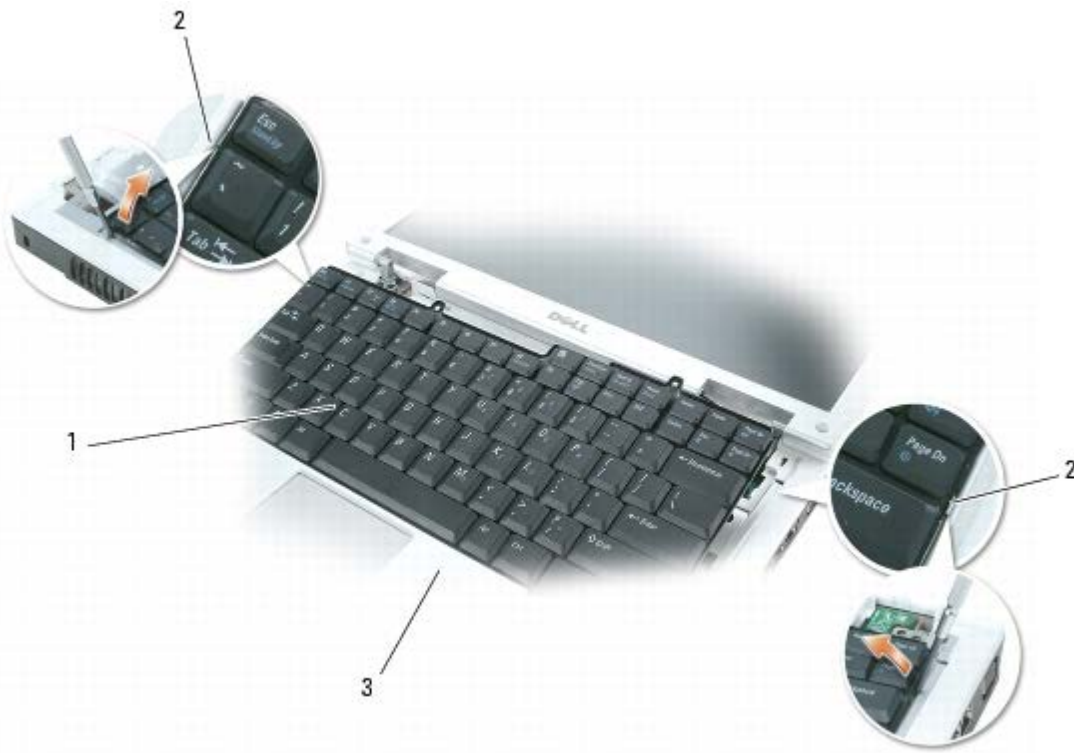

1	keyboard	2	keyboard retention tabs	3	palmrest
---	----------	---	-------------------------	---	----------

4. Lift the keyboard and hold it up and slightly forward to allow access to the keyboard connector.
5. Release the latch on the system board connector to disconnect the keyboard cable.

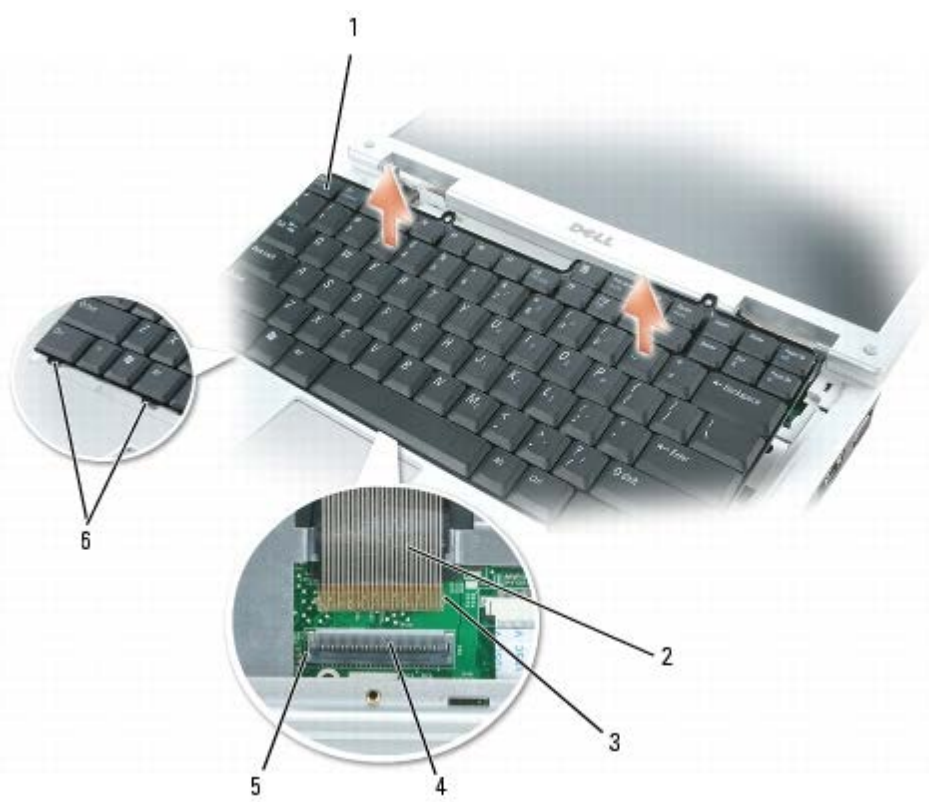

--	--	--	--	--	--



1	keyboard	3	keyboard connector tabs	5	system board connector slots
2	keyboard cable	4	system board connector	6	keyboard tabs (6)

---

## Replacing the Keyboard

 **CAUTION:** Before you perform any of the procedures in this section, follow the safety instructions in the *Product Information Guide*.

 **NOTICE:** To avoid electrostatic discharge, ground yourself by using a wrist grounding strap or by periodically touching an unpainted metal surface (such as the back panel) on the computer.

1. Follow the instructions in [Preparing to Work Inside the Computer](#).
2. Follow the instructions in [Removing the Keyboard](#).

 **NOTICE:** Before securing the latch on the system board connector, ensure that the keyboard connector is seated and the tabs on the connector are properly aligned with the slots on the system board connector. Failure to align the tabs could result in a malfunction of the computer or damage to the cable and/or the cable connector.

3. Align the tabs on the keyboard connector of the new keyboard with the corresponding slots on the system board connector, then press the latch on the system board connector down to lock the keyboard cable into place.
4. Slide the six tabs along the front edge of the keyboard beneath the palm rest.

 **NOTE:** You may need to push the bottom of the keyboard down slightly to slide the keyboard tabs into place.

5. Gently press down on the left and right sides of the keyboard near the keyboard retention tabs until the keyboard snaps into place.
6. Replace the hinge cover (see [Replacing the Hinge Cover](#)).

---

[Back to Contents Page](#)

# Coin-Cell Battery

## Dell™ XPS M140 Service Manual

- [Removing the Coin-Cell Battery](#)
- [Replacing the Coin-Cell Battery](#)

---

## Removing the Coin-Cell Battery

**⚠ CAUTION:** Before you perform any of the procedures in this section, follow the safety instructions in the *Product Information Guide*.

**➡ NOTICE:** To avoid electrostatic discharge, ground yourself by using a wrist grounding strap or by periodically touching an unpainted metal surface (such as the back panel) on the computer.

1. Follow the instructions in [Preparing to Work Inside the Computer](#).
2. Remove the hinge cover (see [Removing the Hinge Cover](#)).
3. Remove the keyboard (see [Removing the Keyboard](#)).
4. Use a plastic scribe to lift the battery upward and remove it from the system board.



		1	coin-cell battery		
--	--	---	-------------------	--	--

---

## Replacing the Coin-Cell Battery

 **CAUTION:** Before you perform any of the procedures in this section, follow the safety instructions in the *Product Information Guide*.

 **NOTICE:** To avoid electrostatic discharge, ground yourself by using a wrist grounding strap or by periodically touching an unpainted metal surface (such as the back panel) on the computer.

1. Follow the instructions in [Preparing to Work Inside the Computer](#).
  2. Follow the instructions in [Removing the Coin-Cell Battery](#).
  3. Insert the new battery into the circular socket with the positive side up, then push it into place.
  4. Replace the keyboard (see [Replacing the Keyboard](#)).
  5. Replace the hinge cover (see [Replacing the Hinge Cover](#)).
- 

[Back to Contents Page](#)

# Wireless Mini PCI Card



## Dell™ XPS M140 Service Manual

- [Removing the Mini PCI Card](#)
- [Replacing the Mini PCI Card](#)

 **NOTE:** If you ordered the optional Mini PCI card at the same time that you ordered your computer, the card is already installed.

---

## Removing the Mini PCI Card

-  **CAUTION:** Before you perform any of the procedures in this section, follow the safety instructions in the *Product Information Guide*.
-  **NOTICE:** To avoid electrostatic discharge, ground yourself by using a wrist grounding strap or by periodically touching an unpainted metal surface (such as the back panel) on the computer.

1. Follow the instructions in [Preparing to Work Inside the Computer](#).
2. Loosen the two captive screws on the modem/Mini PCI/wireless cover, then remove the cover and set it aside.



1	modem/Mini PCI/wireless cover	2	captive screws (2)		
---	-------------------------------	---	--------------------	--	--

3. Disconnect the antenna cables from the Mini PCI card.



	1	antenna cables		
--	---	----------------	--	--

ⓘ NOTICE: To prevent damage to the Mini PCI card connector, do not use tools of any kind to spread the metal clips that secure the Mini PCI card.

4. Use your fingertips to carefully spread apart the metal clips securing each end of the Mini PCI card until the card pops up.



1	Mini PCI card	2	metal retention clips (2)		
---	---------------	---	---------------------------	--	--

5. Remove the Mini PCI card from the connector at a 45-degree angle.



---

## Replacing the Mini PCI Card

- ⚠ CAUTION:** Before you perform any of the procedures in this section, follow the safety instructions in the *Product Information Guide*.
- ➡ NOTICE:** To avoid electrostatic discharge, ground yourself by using a wrist grounding strap or by periodically touching an unpainted metal surface (such as the back panel) on the computer.
1. Follow the instructions in [Preparing to Work Inside the Computer](#)
  2. Follow the instructions in [Removing the Mini PCI Card](#), as applicable.
- ➡ NOTICE:** To avoid damaging the Mini PCI card, make sure the antenna cables are not under the card when you secure the card into place.
- ➡ NOTICE:** The edge connector is keyed to ensure correct insertion. If you feel resistance, check the connector and realign the card.
3. Install the new Mini PCI card:
    - a. Align the notch in the Mini PCI card edge connector with the tab in the connector slot.
    - b. Slide the Mini PCI card firmly into the slot at a 45-degree angle, and then rotate the card down until it clicks into place. If you do not feel the click, remove the card and reinstall it.



		1	Mini PCI card		
--	--	---	---------------	--	--

4. Connect the antenna cables to the Mini PCI card. Make certain that the cable connectors snap securely into place.



		1	antenna cables		
--	--	---	----------------	--	--

5. Replace the modem/Mini PCI/wireless cover and tighten the screws.

# Display Assembly and Display Latch

## Dell™ XPS M140 Service Manual

- [Display Assembly](#)
  - [Display Bezel](#)
  - [Display Panel](#)
  - [Display Latch](#)
- 

## Display Assembly

### Removing the Display Assembly

 **CAUTION:** Before you perform any of the procedures in this section, follow the safety instructions in the *Product Information Guide*.

 **NOTICE:** To avoid electrostatic discharge, ground yourself by using a wrist grounding strap or by periodically touching an unpainted metal surface (such as the back panel) on the computer.

1. Follow the instructions in [Preparing to Work Inside the Computer](#).
2. Remove the hinge cover (see [Removing the Hinge Cover](#)).
3. Remove the keyboard (see [Removing the Keyboard](#)).
4. Open the display all the way (180 degrees) so that it rests flat against your work surface.
5. Use the pull-tab to disconnect the display cable from the system board.
6. Remove the Mini PCI antenna cables from the retaining clips on the base of the computer and pull apart the connectors.
7. Remove the four M2.5 x 5-mm screws (two on each side) that connect the display assembly to the computer.
8. Lift the display assembly straight out of the computer.



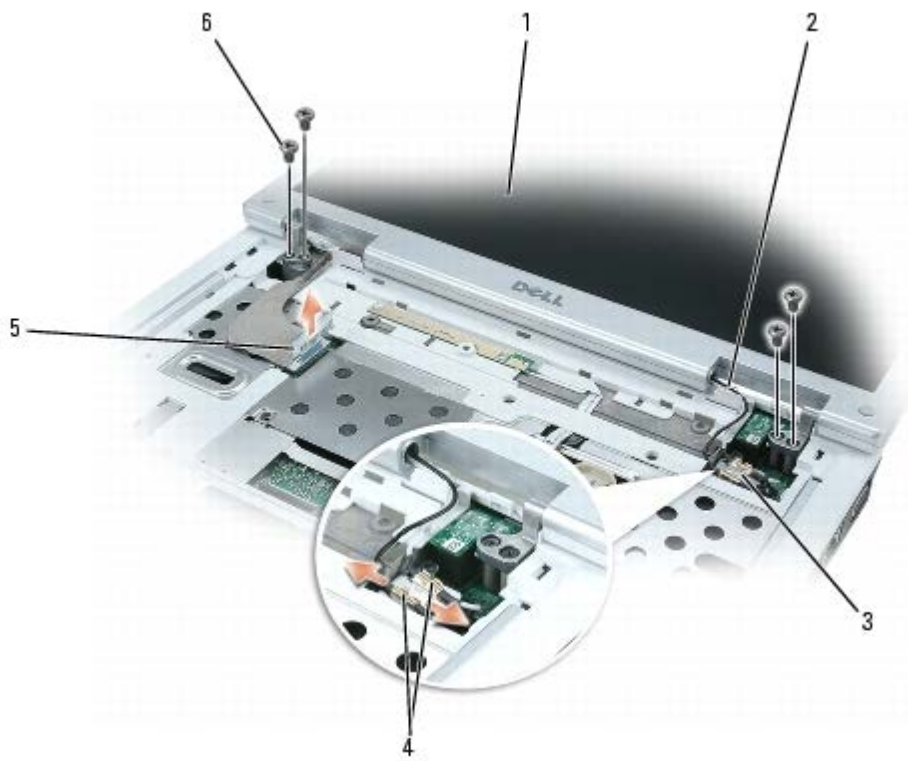

1	display assembly	3	antenna cable retaining clips	5	display cable
2	Mini PCI antenna cables	4	antenna cable connectors	6	M2.5 x 5-mm screws (4)

## Replacing the Display Assembly

**⚠ CAUTION:** Before you perform any of the procedures in this section, follow the safety instructions in the *Product Information Guide*.

**👉 NOTICE:** To avoid electrostatic discharge, ground yourself by using a wrist grounding strap or by periodically touching an unpainted metal surface (such as the back panel) on the computer.

1. Follow the instructions in [Preparing to Work Inside the Computer](#)
2. Follow the instructions in [Removing the Display Assembly](#).
3. Align the new display assembly over the screw holes in the base of the computer.
4. Replace the four M2.5 x 5-mm screws (two on each side) to secure the display assembly to the base of the computer.
5. Connect the Mini PCI antenna cable connectors and press the cables into the retaining clips on the base of the computer.
6. Connect the display cable to the system board.
7. Replace the keyboard (see [Replacing the Keyboard](#)).
8. Replace the hinge cover (see [Replacing the Hinge Cover](#)).

---

# Display Bezel

## Removing the Display Bezel

 **CAUTION:** Before you perform any of the procedures in this section, follow the safety instructions in the *Product Information Guide*.

 **NOTICE:** To avoid electrostatic discharge, ground yourself by using a wrist grounding strap or by periodically touching an unpainted metal surface (such as the back panel) on the computer.

1. Follow the instructions in [Preparing to Work Inside the Computer](#).
2. Remove the hinge cover (see [Removing the Hinge Cover](#)).
3. Remove the keyboard (see [Removing the Keyboard](#)).
4. Remove display assembly (see [Removing the Display Assembly](#)).
5. Use a plastic scribe to remove the six rubber bumpers from around the display assembly. It is not necessary to remove the oval bumpers located on the sides of the display.
6. Remove the six M2.5 x 5-mm screws from around the display assembly.

 **NOTICE:** To avoid damaging the bezel, carefully separate the bezel from the display assembly by starting along the bottom of the display (near the Dell logo) and working around the edge of the display towards the release latch.

7. Use your fingers to separate the bezel from the display assembly by lifting the inside edge of the bezel up and away from the center of the display assembly.

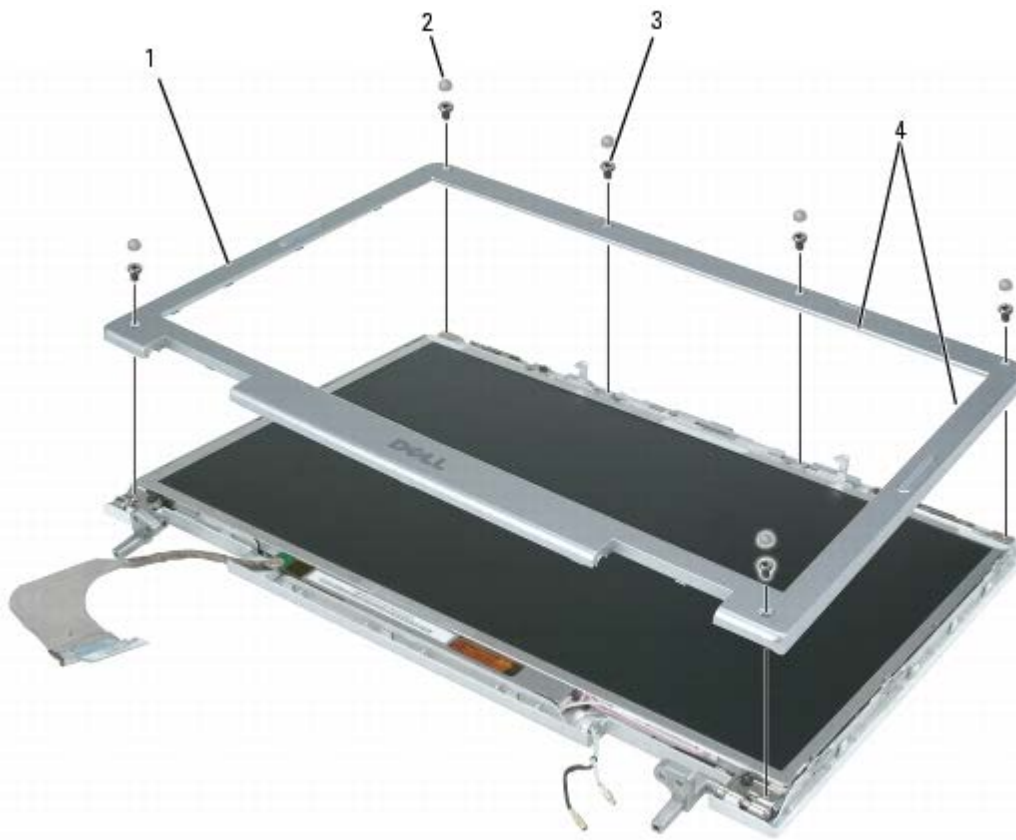

1	display bezel	2	rubber bumpers (6)	3	M2.5 x 5-mm screws (6)
4	inside edge of bezel				

## Replacing the Display Bezel

**⚠ CAUTION:** Before you perform any of the procedures in this section, follow the safety instructions in the *Product Information Guide*.

**🕒 NOTICE:** To avoid electrostatic discharge, ground yourself by using a wrist grounding strap or by periodically touching an unpainted metal surface (such as the back panel) on the computer.

1. Follow the instructions in [Preparing to Work Inside the Computer](#)
2. Follow the instructions in [Removing the Display Bezel](#).
3. Starting near the hinges (near the Dell logo), use your fingers to snap the new bezel into place.
4. Replace the six M2.5 x 5-mm screws to secure the bezel.
5. Replace the six rubber bumpers to cover the screws.
6. Replace the display assembly (see [Replacing the Display Assembly](#)).
7. Replace the keyboard (see [Replacing the Keyboard](#)).
8. Replace the hinge cover (see [Replacing the Hinge Cover](#)).

---

# Display Panel

## Removing the Display Panel

 **CAUTION:** Before you perform any of the procedures in this section, follow the safety instructions in the *Product Information Guide*.

 **NOTICE:** To avoid electrostatic discharge, ground yourself by using a wrist grounding strap or by periodically touching an unpainted metal surface (such as the back panel) on the computer.

1. Follow the instructions in [Preparing to Work Inside the Computer](#).
2. Remove the hinge cover (see [Removing the Hinge Cover](#)).
3. Remove the keyboard (see [Removing the Keyboard](#)).
4. Remove display assembly (see [Removing the Display Assembly](#)).
5. Remove the display bezel (see [Removing the Display Bezel](#)).
6. Remove the six M2 x 3-mm screws (three on each side)securing the display panel to the display (top) cover.
7. Gently lift the bottom of the display panel up, then slide the display panel forward to remove it from the display cover.

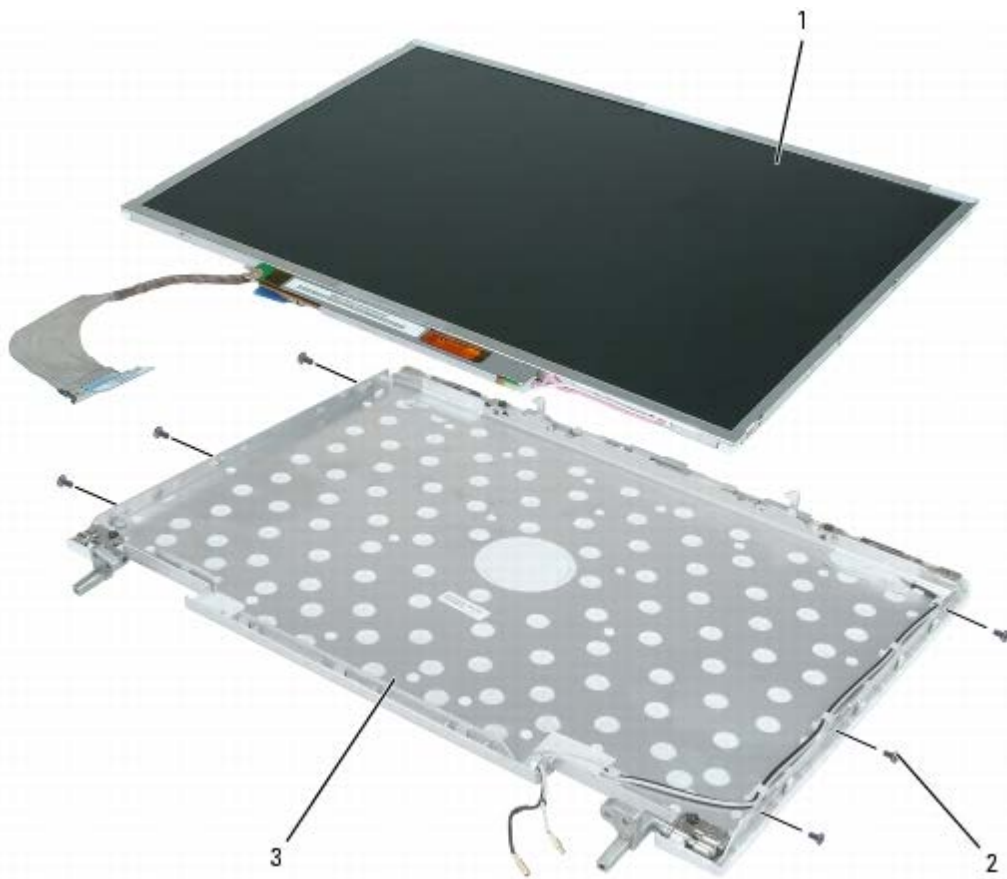

1	display panel	2	M2 x 3-mm screws (6)	3	display cover
---	---------------	---	----------------------	---	---------------

8. Press inward on the metal clamps on both sides of the top flex-cable connector and gently pull to disconnect the top flex-cable connector from the display locking connector.
9. Use the pull-tab to disconnect the bottom flex-cable connector from the inverter connector.

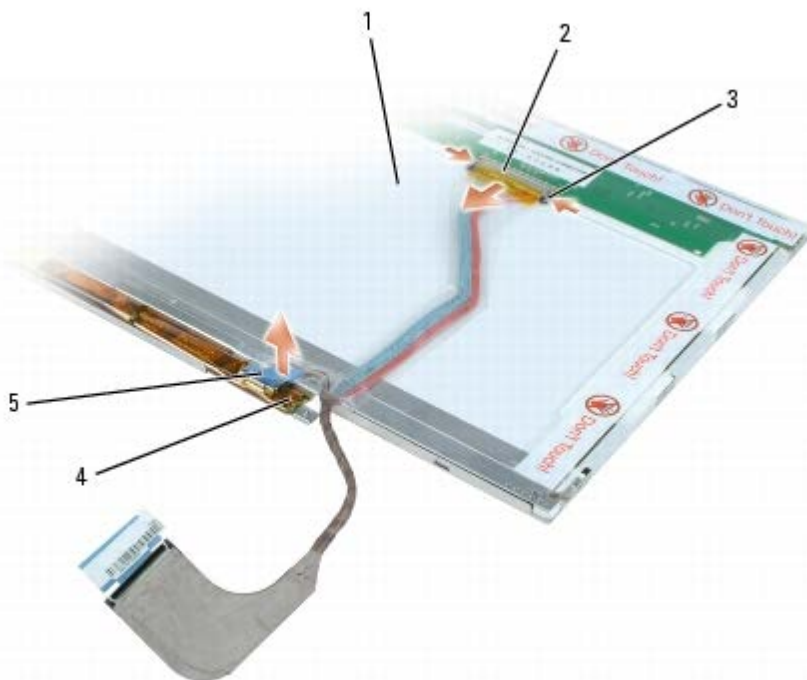

1	back of display panel	3	metal clamps	5	inverter connector
2	top flex-cable connector	4	bottom flex-cable connector		

## Replacing the Display Panel

 **CAUTION:** Before you perform any of the procedures in this section, follow the safety instructions in the *Product Information Guide*.

 **NOTICE:** To avoid electrostatic discharge, ground yourself by using a wrist grounding strap or by periodically touching an unpainted metal surface (such as the back panel) on the computer.

1. Follow the instructions in [Preparing to Work Inside the Computer](#)
2. Follow the instructions in [Removing the Display Panel](#).
3. Connect the top flex-cable connector to the display locking connector on the new display panel.
4. Connect the bottom flex-cable connector to the inverter connector.

 **NOTICE:** To avoid damaging the display cover and/or the display panel, ensure that the guide posts at the top of the display panel are properly aligned with the corresponding notches on the display cover.

5. Gently place the display panel inside the display cover.
6. Replace the six M2 x 3-mm screws (three on each side) to secure the display panel to the display cover.
7. Replace the display bezel (see [Replacing the Display Bezel](#)).
8. Replace display assembly (see [Replacing the Display Assembly](#)).
9. Replace the keyboard (see [Replacing the Keyboard](#)).
10. Replace the hinge cover (see [Replacing the Hinge Cover](#)).

---

## Display Latch

### Removing the Display Latch

 **CAUTION:** Before you perform any of the procedures in this section, follow the safety instructions in the *Product Information Guide*.

 **NOTICE:** To avoid electrostatic discharge, ground yourself by using a wrist grounding strap or by periodically touching an unpainted metal surface (such as the back panel) on the computer.

1. Follow the instructions in [Preparing to Work Inside the Computer](#).

2. Remove the hinge cover (see [Removing the Hinge Cover](#)).
3. Remove the keyboard (see [Removing the Keyboard](#)).
4. Remove display assembly (see [Removing the Display Assembly](#)).
5. Remove the display bezel (see [Removing the Display Bezel](#)).

➡ **NOTICE:** The display latch spring is not physically connected to the latch assembly. Exercise care that the spring is not lost.

6. Slightly rotate the left side of the display latch assembly away from the center of the top cover, then lift up and to the left to remove the latch assembly.

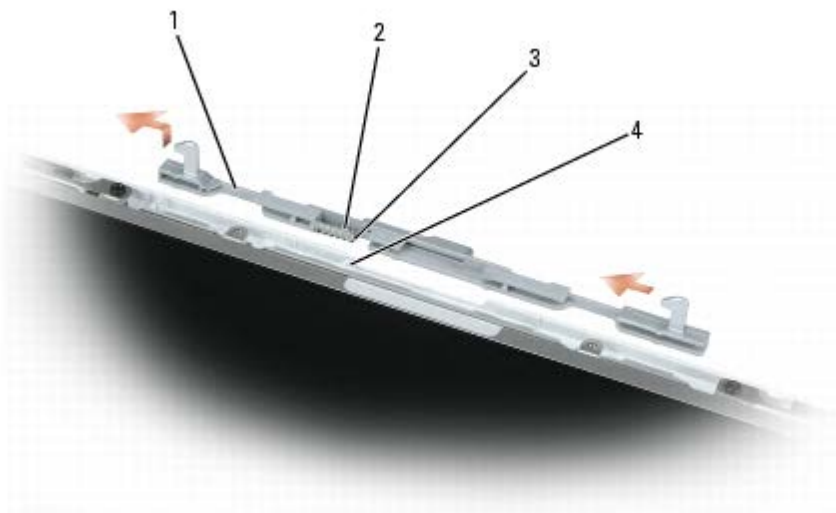

1	display latch assembly	2	latch spring	3	guide post
4	guide post slot				

## Replacing the Display Latch

⚠ **CAUTION:** Before you perform any of the procedures in this section, follow the safety instructions in the *Product Information Guide*.

➡ **NOTICE:** To avoid electrostatic discharge, ground yourself by using a wrist grounding strap or by periodically touching an unpainted metal surface (such as the back panel) on the computer.

1. Follow the instructions in [Preparing to Work Inside the Computer](#)
2. Follow the instructions in [Removing the Display Latch](#).

➡ **NOTICE:** Before replacing the display latch assembly, ensure that the latch spring is properly aligned on the guide post.

3. Insert the guide post of the new display latch assembly (with spring) into the slot on the display (top) cover.

 NOTE: When the guide post is in position, the display latch assembly may automatically snap into place.

4. Press the remainder of the display latch assembly into place, as needed.

5. Replace the display bezel (see [Replacing the Display Bezel](#)).

6. Replace display assembly (see [Replacing the Display Assembly](#)).

7. Replace the keyboard (see [Replacing the Keyboard](#)).

8. Replace the hinge cover (see [Replacing the Hinge Cover](#)).

---

[Back to Contents Page](#)



# Palm Rest

## Dell™ XPS M140 Service Manual

- [Removing the Palm Rest](#)
  - [Replacing the Palm Rest](#)
- 

## Removing the Palm Rest

 **CAUTION:** Before you perform any of the procedures in this section, follow the safety instructions in the *Product Information Guide*.

 **NOTICE:** To avoid electrostatic discharge, ground yourself by using a wrist grounding strap or by periodically touching an unpainted metal surface (such as the back panel) on the computer.

1. Follow the instructions in [Preparing to Work Inside the Computer](#).
2. Remove the optical drive (see [Removing the Optical Drive](#)).
3. Remove the hinge cover (see [Removing the Hinge Cover](#)).
4. Remove the keyboard (see [Removing the Keyboard](#)).
5. Remove the display assembly (see [Removing the Display Assembly](#)).
6. Remove the microprocessor thermal-cooling assembly (see [Removing the Microprocessor Thermal-Cooling Assembly](#)).
7. Loosen the two captive screws on the modem/Mini PCI/wireless cover, then remove the cover and set it aside.



1	modem/Mini PCI/wireless cover	2	captive screws (2)		
---	-------------------------------	---	--------------------	--	--

8. Remove the eleven M2.5 x 8-mm screws securing the palm rest from the bottom of the computer.



	1	M2.5 x 8-mm screws (11)		
--	---	-------------------------	--	--

9. Turn the computer over and remove the four M2.5 x 5-mm screws securing the top of the palm rest.

➡ **NOTICE:** Release the locking tabs on both sides of the system board connector before attempting to remove the touch pad or LED cable. Failure to release the locking tabs could result in damage to the cable and/or the cable

connector.

10. Disconnect the touch pad cable.

Use a plastic scribe to release the locking clips on both sides of the system board connector, and then gently pull to disconnect the touch pad connector from the system board connector.

11. Disconnect the LED board cable.

Use a plastic scribe to release the locking clips on both sides of the system board connector, and then gently pull to disconnect the LED board connector from the system board connector.

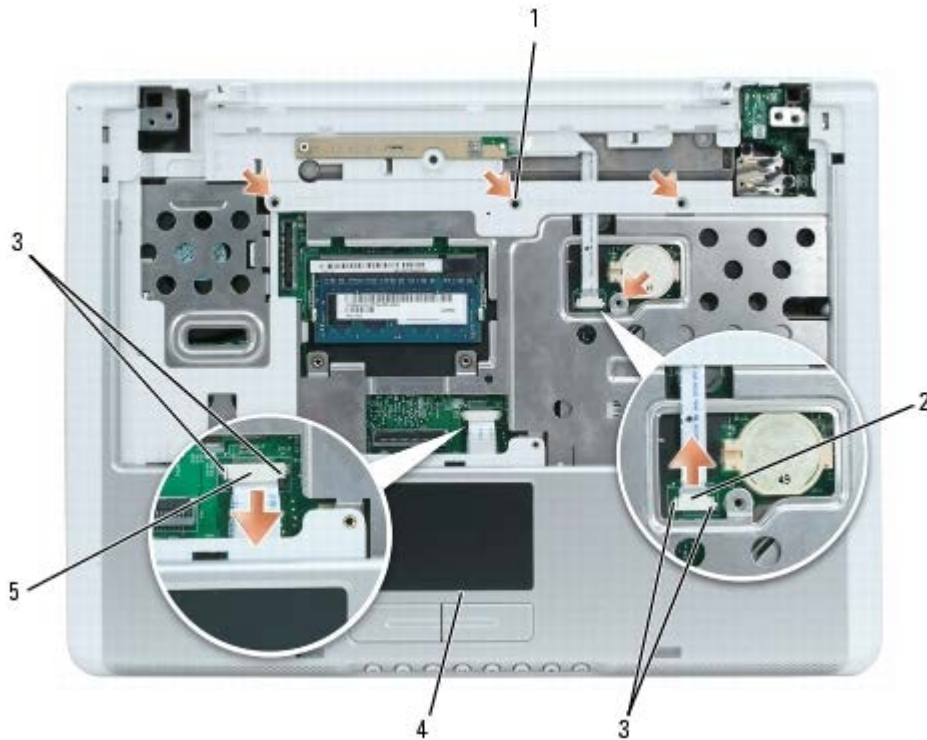

1	M2.5 x 5-mm screws (4)	3	locking clips	5	touch pad connector
2	LED board connector	4	palm rest		

12. Moving from left to right, carefully lift the palm rest along the rear edge, near the hinge brackets, then rotate the palmrest forward to remove it from the computer.



1	palmrest	2	hinge brackets		
---	----------	---	----------------	--	--

## Replacing the Palm Rest

**⚠ CAUTION:** Before you perform any of the procedures in this section, follow the safety instructions in the *Product Information Guide*.

**➡ NOTICE:** To avoid electrostatic discharge, ground yourself by using a wrist grounding strap or by periodically touching an unpainted metal surface (such as the back panel) on the computer.

1. Follow the instructions in [Preparing to Work Inside the Computer](#)
2. Follow the instructions in [Removing the Palm Rest](#).
3. Align the new palm rest with the base of the computer, and then snap the palm rest into place.

**➡ NOTICE:** To prevent damage to the cables or the cable connectors, ensure that the locking clips on both sides of each system board connector are firmly seated and the cables are secure.

4. Connect the touch pad cable to the system board.
5. Connect the LED board cable to the system board.
6. Replace the four M2.5 x 5-mm screws in the top of the palm rest.
7. Turn the computer over and replace the eleven M2.5 x 8-mm screws in the bottom of the computer to secure the palm rest.
8. Replace the microprocessor thermal-cooling assembly (see [Replacing the Microprocessor Thermal-Cooling Assembly](#)).
9. Replace the modem/Mini PCI/wireless cover and tighten the screws.

10. Replace the display assembly (see [Replacing the Display Assembly](#)).
  11. Replace the keyboard (see [Replacing the Keyboard](#)).
  12. Replace the hinge cover (see [Replacing the Hinge Cover](#)).
  13. Replace the optical drive (see [Replacing the Optical Drive](#)).
- 

[Back to Contents Page](#)

# Microprocessor Thermal-Cooling Assembly

## Dell™ XPS M140 Service Manual

- [Removing the Microprocessor Thermal-Cooling Assembly](#)
- [Replacing the Microprocessor Thermal-Cooling Assembly](#)

---

## Removing the Microprocessor Thermal-Cooling Assembly

**⚠ CAUTION:** Before you perform any of the procedures in this section, follow the safety instructions in the *Product Information Guide*.

**👉 NOTICE:** To avoid electrostatic discharge, ground yourself by using a wrist grounding strap or by periodically touching an unpainted metal surface (such as the back panel) on the computer.

1. Follow the instructions in [Preparing to Work Inside the Computer](#).
2. Loosen the three captive screws securing the microprocessor module cover, then remove the cover and set it aside.



1	microprocessor module cover	2	captive screws (3)		
---	-----------------------------	---	--------------------	--	--

3. Loosen the four captive screws securing the microprocessor thermal-cooling assembly to the system board, then carefully lift the assembly straight out of the computer.



1	microprocessor thermal-cooling assembly	2	captive screws (4)		
---	---	---	--------------------	--	--

## Replacing the Microprocessor Thermal-Cooling Assembly

**⚠ CAUTION:** Before you perform any of the procedures in this section, follow the safety instructions in the *Product Information Guide*.

**👉 NOTICE:** To avoid electrostatic discharge, ground yourself by using a wrist grounding strap or by periodically touching an unpainted metal surface (such as the back panel) on the computer.

1. Follow the instructions in [Preparing to Work Inside the Computer](#)
2. Follow the instructions in [Removing the Microprocessor Thermal-Cooling Assembly](#).
3. Align the four captive screws on the new microprocessor thermal-cooling assembly with the screw holes on the system board.
4. Tighten the four captive screws in the order that they are numbered to secure the microprocessor thermal-cooling assembly to the system board.
5. Replace the microprocessor module cover.

[Back to Contents Page](#)

# Fan

## Dell™ XPS M140 Service Manual

- [Removing the Fan](#)
  - [Replacing the Fan](#)
- 

## Removing the Fan

 **CAUTION:** Before you perform any of the procedures in this section, follow the safety instructions in the *Product Information Guide*.

 **NOTICE:** To avoid electrostatic discharge, ground yourself by using a wrist grounding strap or by periodically touching an unpainted metal surface (such as the back panel) on the computer.

1. Follow the instructions in [Preparing to Work Inside the Computer](#).
2. Remove the optical drive (see [Removing the Optical Drive](#)).
3. Remove the hinge cover (see [Removing the Hinge Cover](#)).
4. Remove the keyboard (see [Removing the Keyboard](#)).
5. Remove the display assembly (see [Removing the Display Assembly](#)).
6. Remove the palm rest (see [Removing the Palm Rest](#)).
7. Remove the three M2.5 x 5-mm screws securing the fan to the base of the computer.
8. Disconnect the fan connector from the system board connector.
9. Lift the fan out of the computer.



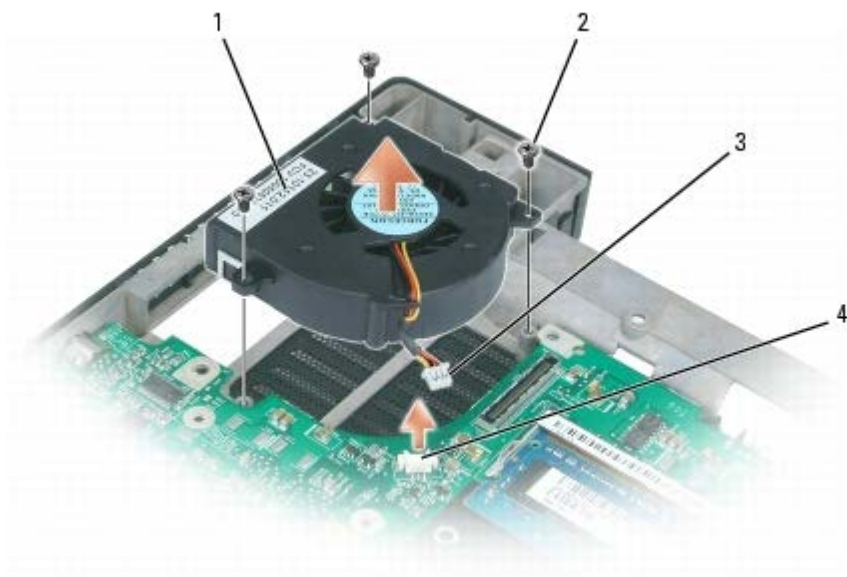

1	fan	2	M2.5 x 5-mm screws (3)	3	fan connector
4	system board connector				

## Replacing the Fan

**⚠ CAUTION:** Before you perform any of the procedures in this section, follow the safety instructions in the *Product Information Guide*.

**👉 NOTICE:** To avoid electrostatic discharge, ground yourself by using a wrist grounding strap or by periodically touching an unpainted metal surface (such as the back panel) on the computer.

1. Follow the instructions in [Preparing to Work Inside the Computer](#)
2. Follow the instructions in [Removing the Fan](#).
3. Align the three screw holes on the new fan with the corresponding screw holes on the system board.
4. Replace the three M2.5 x 5-mm screws to secure the fan to the base of the computer.
5. Connect the fan connector to the system board connector.
6. Replace the palm rest (see [Replacing the Palm Rest](#)).
7. Replace the display assembly (see [Replacing the Display Assembly](#)).
8. Replace the keyboard (see [Replacing the Keyboard](#)).
9. Replace the hinge cover (see [Replacing the Hinge Cover](#)).
10. Replace the optical drive (see [Replacing the Optical Drive](#)).



# Microprocessor Module

## Dell™ XPS M140 Service Manual

- [Removing the Microprocessor Module](#)
- [Replacing the Microprocessor Module](#)

---

## Removing the Microprocessor Module

**⚠ CAUTION:** Before you perform any of the procedures in this section, follow the safety instructions in the *Product Information Guide*.

- ➡ **NOTICE:** To avoid electrostatic discharge, ground yourself by using a wrist grounding strap or by periodically touching an unpainted metal surface (such as the back panel) on the computer.
- ➡ **NOTICE:** Handle the microprocessor module with care. Hold the microprocessor module by its edges and do not touch the processor die (the small chip in the center of the module).

1. Follow the instructions in [Preparing to Work Inside the Computer](#).
2. Loosen the three captive screws securing the microprocessor module cover, then remove the cover and set it aside.



1	microprocessor module cover	2	captive screws (3)		
---	-----------------------------	---	--------------------	--	--

- ➡ **NOTICE:** To ensure maximum cooling for the microprocessor, do not touch the heat transfer areas on the microprocessor thermal-cooling assembly. Oils in your skin can reduce the heat transfer capability of the

thermal pads.

3. Remove the microprocessor thermal-cooling assembly (see [Removing the Microprocessor Thermal- Cooling Assembly](#)).

➡ **NOTICE:** To avoid damaging the microprocessor, hold the screwdriver so that it is perpendicular to the microprocessor module when turning the cam screw.

4. To loosen the ZIF-socket cam lock, use a small, flat-blade screwdriver to rotate the ZIF-socket cam screw counterclockwise until it comes to the cam stop.

🔧 **NOTE:** The ZIF-socket cam screw secures the microprocessor module to the system board.

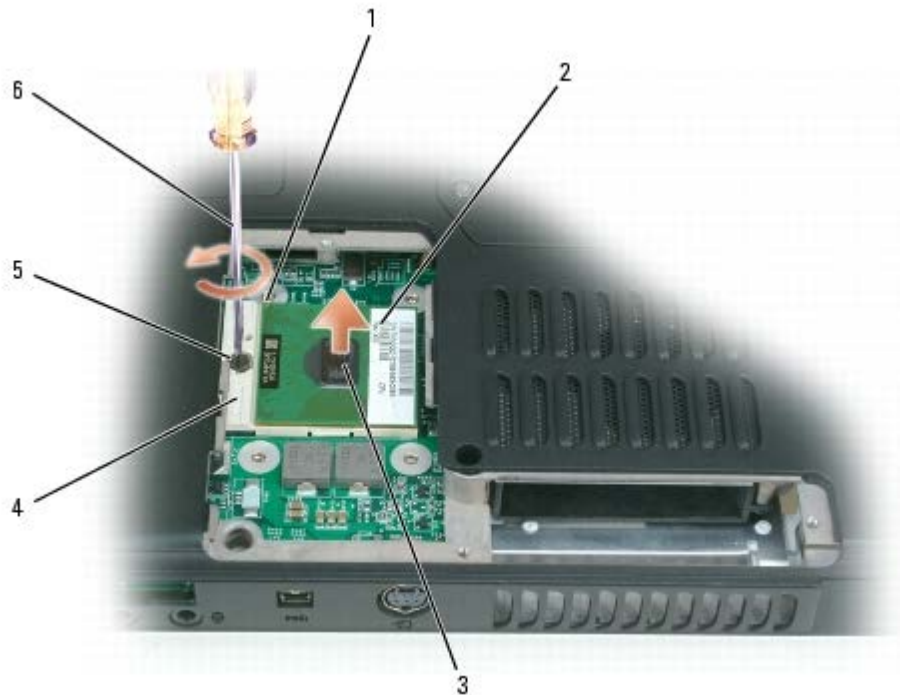

1	microprocessor pin-1 corner	3	processor die	5	ZIF-socket cam screw
2	microprocessor module	4	ZIF socket	6	screwdriver

➡ **NOTICE:** When removing the microprocessor module, pull the module straight up and out of the ZIF socket. Exercise care not to bend the pins on the microprocessor module.

5. Lift the microprocessor module straight up and out of the ZIF socket.

---

## Replacing the Microprocessor Module

⚠ **CAUTION:** Before you perform any of the procedures in this section, follow the safety instructions in the *Product Information Guide*.

➡ NOTICE: To avoid electrostatic discharge, ground yourself by using a wrist grounding strap or by periodically touching an unpainted metal surface (such as the back panel) on the computer.

1. Follow the instructions in [Preparing to Work Inside the Computer](#)

➡ NOTICE: Handle the microprocessor module with care. Hold the microprocessor module by its edges and do not touch the processor die (the small chip in the center of the module).

2. Follow the instructions in [Removing the Microprocessor Module](#).

➡ NOTICE: Ensure that the cam lock is in the fully open position before seating the microprocessor module. Seating the microprocessor module properly in the ZIF socket does not require force. A microprocessor module that is not properly seated can result in an intermittent connection or permanent damage to the microprocessor and ZIF socket.

3. Align the pin-1 corner of the new microprocessor module with the pin-1 corner of the ZIF socket, and insert the microprocessor module.

✎ NOTE: The pin-1 corner of the microprocessor module has a triangle that aligns with the triangle on the pin-1 corner of the ZIF socket.

✎ NOTE: Gently press down on the substrate on which the processor die is mounted to ensure the microprocessor module is properly seated.

When the microprocessor module is properly seated, all four corners of the module are aligned at the same height. If one or more corners of the module is higher than the others, the module is not properly seated.

➡ NOTICE: To avoid damaging the microprocessor, hold the screwdriver so that it is perpendicular to the microprocessor module when turning the cam screw.

4. Tighten the ZIF-socket cam lock by turning the cam screw clockwise to secure the microprocessor module to the system board.
5. Replace the microprocessor thermal-cooling assembly (see [Replacing the Microprocessor Thermal- Cooling Assembly](#)).
6. Replace the microprocessor module cover.
7. Update the BIOS using a flash BIOS update program floppy disk or CD. For instructions on how to flash the BIOS, see [BIOS Updates](#).

# Speakers

## Dell™ XPS M140 Service Manual

- [Removing the Speakers](#)
  - [Replacing the Speakers](#)
- 

## Removing the Speakers

 **CAUTION:** Before you perform any of the procedures in this section, follow the safety instructions in the *Product Information Guide*.

 **NOTICE:** To avoid electrostatic discharge, ground yourself by using a wrist grounding strap or by periodically touching an unpainted metal surface (such as the back panel) on the computer.

1. Follow the instructions in [Preparing to Work Inside the Computer](#).
2. Remove the optical drive (see [Removing the Optical Drive](#)).
3. Remove the hinge cover (see [Removing the Hinge Cover](#)).
4. Remove the keyboard (see [Removing the Keyboard](#)).
5. Remove the display assembly (see [Removing the Display Assembly](#)).
6. Remove the microprocessor thermal-cooling assembly (see [Removing the Microprocessor Thermal-Cooling Assembly](#)).
7. Remove the palmrest (see [Removing the Palm Rest](#)).

 **NOTICE:** Exercise care when removing and handling the speakers.

8. Disconnect the speaker connector from the system board connector.
9. Remove the three M2.5 x 5-mm screws securing the speakers to the base of the computer.

 **NOTE:** There are two screws securing the left speaker and one screw securing the right speaker.

10. Lift the speakers straight up and out of the computer.

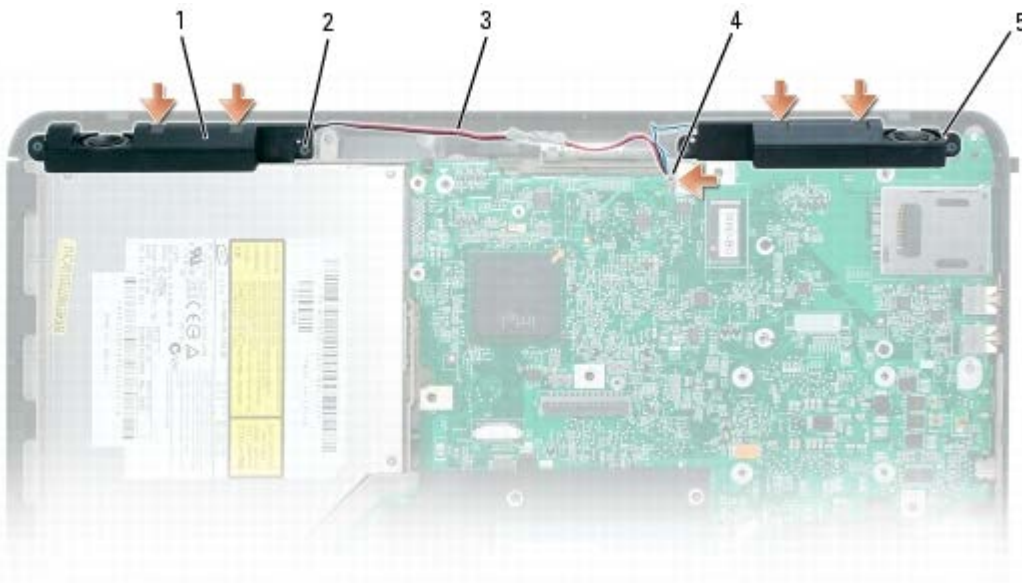

1	speakers (2)	3	speaker cable	5	guide post slots (4)
2	M2.5 x 5-mm screws (3)	4	speaker connector		

## Replacing the Speakers

**⚠ CAUTION:** Before you perform any of the procedures in this section, follow the safety instructions in the *Product Information Guide*.

**➡ NOTICE:** To avoid electrostatic discharge, ground yourself by using a wrist grounding strap or by periodically touching an unpainted metal surface (such as the back panel) on the computer.

1. Follow the instructions in [Preparing to Work Inside the Computer](#).
2. Follow the instructions in [Removing the Speakers](#).

**➡ NOTICE:** Exercise care when handling or replacing the speakers.

3. Place each of the new speakers in the appropriate speaker slot.

**🔧 NOTE:** For proper placement, align the slots on the speakers with the screw-hole guide posts on the base of the computer.

4. Replace the three M2.5 x 5-mm screws to secure the speakers to the base of the computer.
5. Connect the speaker cable to the system board.
6. Replace the palmrest (see [Replacing the Palm Rest](#)).
7. Replace the microprocessor thermal-cooling assembly (see [Replacing the Microprocessor Thermal- Cooling Assembly](#)).

8. Replace the display assembly (see [Replacing the Display Assembly](#)).
  9. Replace the keyboard (see [Replacing the Keyboard](#)).
  10. Replace the hinge cover (see [Replacing the Hinge Cover](#)).
  11. Replace the optical drive (see [Replacing the Optical Drive](#)).
- 

[Back to Contents Page](#)



# System Board

## Dell™ XPS M140 Service Manual

- [Removing the System Board](#)
  - [Replacing the System Board](#)
- 

## Removing the System Board

 **CAUTION:** Before you perform any of the procedures in this section, follow the safety instructions in the *Product Information Guide*.

 **NOTICE:** To avoid electrostatic discharge, ground yourself by using a wrist grounding strap or by periodically touching an unpainted metal surface (such as the back panel) on the computer.

The system board's BIOS chip contains the Service Tag, which is also visible on a barcode label on the bottom of the computer. The replacement kit for the system board includes a CD that provides a utility for transferring the Service Tag to the replacement system board.

1. Follow the instructions in [Preparing to Work Inside the Computer](#).
2. Remove the hard drive (see [Removing the Hard Drive](#)).
3. Remove the optical drive (see [Removing the Optical Drive](#)).
4. Remove the Mini PCI card, if applicable (see [Removing the Mini PCI Card](#)).
5. Remove the modem, if applicable (see [Removing the Modem](#)).
6. Remove the Bluetooth module, if applicable (see [Removing the Bluetooth Module](#)).
7. Disconnect the cable for the Bluetooth module from the system board.
8. Remove the hinge cover (see [Removing the Hinge Cover](#)).
9. Remove the keyboard (see [Removing the Keyboard](#)).
10. Remove the display assembly (see [Removing the Display Assembly](#)).
11. Remove all memory modules (see [Removing a Memory Module](#)).
12. Remove the microprocessor thermal-cooling assembly (see [Removing the Microprocessor Thermal- Cooling Assembly](#)).
13. Remove the microprocessor module (see [Removing the Microprocessor Module](#)).

14. Remove the palmrest (see [Removing the Palm Rest](#)).
15. Remove the two M2 x 3-mm screws securing the system board from the bottom of the computer.



		1	M2 x 3-mm screws (2)		
--	--	---	----------------------	--	--

16. Turn the computer over so that the bottom is facing down and remove the M2.5 x 5-mm screw securing the system board.
17. Disconnect the fan cable from the system board.
18. Disconnect the speaker cable from the system board.
19. Disconnect the modem cable from the system board.

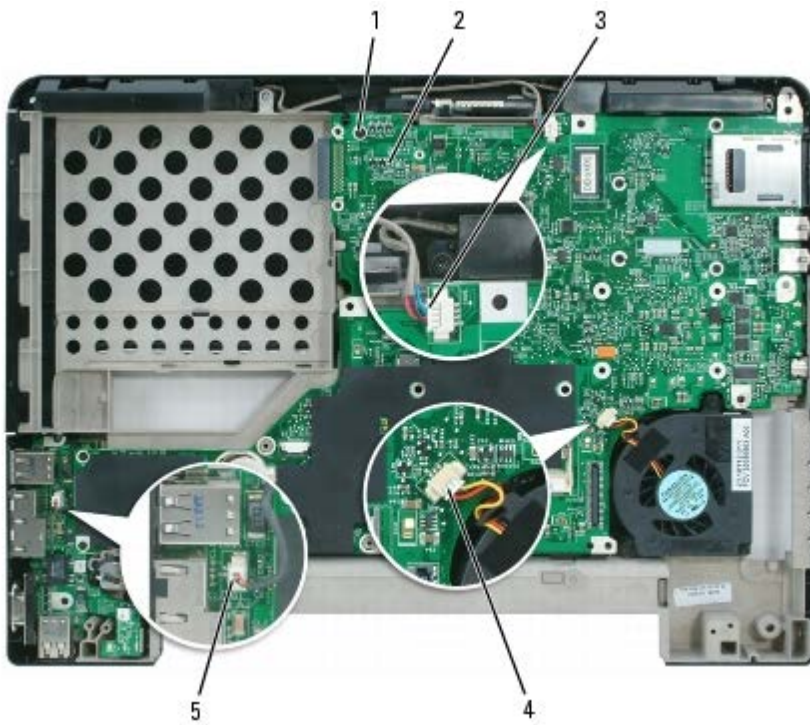

1	M2.5 x 5-mm screw	3	speaker connector	5	modem connector
2	system board	4	fan connector		

20. With the rear of the computer facing you, gently lift the system board assembly from the left side, then slide the system board assembly to the left and lift up on the right side to raise the assembly out of the computer.

**NOTE:** It may be necessary to press outward slightly on the plastic around the connectors on the left side of the computer to lift the system board and remove it.



		1	system board		
--	--	---	--------------	--	--

# Replacing the System Board

 **CAUTION:** Before you perform any of the procedures in this section, follow the safety instructions in the *Product Information Guide*.

 **NOTICE:** To avoid electrostatic discharge, ground yourself by using a wrist grounding strap or by periodically touching an unpainted metal surface (such as the back panel) on the computer.

1. Follow the instructions in [Preparing to Work Inside the Computer](#).
2. Follow the instructions in [Removing the System Board](#).
3. For replacement of the system board, perform the steps in [Removing the System Board](#) in reverse order.

 **NOTICE:** Before turning on the computer, replace all screws and ensure that no stray screws remain inside the computer. Failure to do so may result in damage to the computer.

4. Turn on the computer.

 **NOTE:** After replacing the system board, enter the computer's alpha-numeric Service Tag into the BIOS of the replacement system board.

5. Insert the floppy disk or CD that accompanied the replacement system board into the appropriate drive. Follow the instructions that appear on the screen.

---

[Back to Contents Page](#)

# BIOS Updates

## Dell™ XPS M 140 Service Manual

### ● [Flashing the BIOS](#)

---

## Flashing the BIOS

➡ NOTICE: Plug the AC adapter into a known-good power source to prevent a loss of power. Failure to do so may cause damage to the computer.

1. Ensure that the AC adapter is plugged in and that the main battery is properly installed.
2. Turn on the computer.

📀 NOTE: If you use a BIOS update program CD to flash the BIOS, set up the computer to boot from a CD before inserting the CD.

3. Insert the BIOS update program floppy disk or CD, then reboot the computer.

➡ NOTICE: Do not interrupt the flash BIOS process once it begins. Interrupting the process may cause damage to the computer.

Follow the instructions that appear on the screen. The computer continues to boot and updates the new BIOS. When the flash update is complete, the computer will automatically reboot.

4. Press <F2> during POST to enter the system setup program.
  5. Press <Alt> and <f> to reset the computer defaults.
  6. Press <Esc>, select **Save changes and reboot**, and press <Enter> to save configuration changes.
  7. Remove the flash BIOS update program floppy disk or CD from the drive and restart the computer.
-

# Pin Assignments for I/O Connectors

## Dell™ XPS M140 Service Manual

- [USB Connector](#)
  - [Video Connector](#)
  - [S-Video TV-Out Connector](#)
  - [IEEE 1394 Connector](#)
- 

### USB Connector

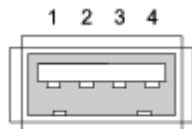

Pin	Signal
1	USB5V+
2	USBP-
3	USBP+
4	GND

---

### Video Connector

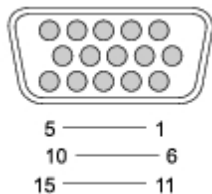

Pin	Signal	Pin	Signal
1	CRT_R	9	5V+
2	CRT_G	10	GND
3	CRT_B	11	MONITOR_DETECT-

4	NC	12	DDC_DATA
5	GND	13	CRT_HS
6	GND	14	CRT_VS
7	GND	15	DDC_CLK
8	GND		

## S-Video TV-Out Connector

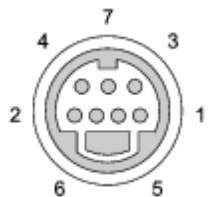

S-Video	
Pin	Signal
1	GND
2	GND
3	DLUMA-L
4	DCRMA-L

Composite Video	
Pin	Signal
5	NC
6	DCMPS-L
7	GND

## IEEE 1394 Connector



Pin	Signal

1	TPB-
2	TPB+
3	TPA-
4	TPA+

---

[Back to Contents Page](#)



## Free Manuals Download Website

<http://myh66.com>

<http://usermanuals.us>

<http://www.somanuals.com>

<http://www.4manuals.cc>

<http://www.manual-lib.com>

<http://www.404manual.com>

<http://www.luxmanual.com>

<http://aubethermostatmanual.com>

Golf course search by state

<http://golfingnear.com>

Email search by domain

<http://emailbydomain.com>

Auto manuals search

<http://auto.somanuals.com>

TV manuals search

<http://tv.somanuals.com>