



Thinking of you
Electrolux



EDH3284PDW

.....
EN TUMBLE DRYER

.....
USER MANUAL



CONTENTS

1. SAFETY INSTRUCTIONS	3
2. PRODUCT DESCRIPTION	5
3. CONTROL PANEL	6
4. PROGRAMME TABLE	7
5. OPTIONS	7
6. SETTINGS	9
7. DAILY USE	9
8. HINTS AND TIPS	10
9. CARE AND CLEANING	11
10. TROUBLESHOOTING	14
11. TECHNICAL DATA	15
12. ENVIRONMENT CONCERNS	16

WE'RE THINKING OF YOU

Thank you for purchasing an Electrolux appliance. You've chosen a product that brings with it decades of professional experience and innovation. Ingenious and stylish, it has been designed with you in mind. So whenever you use it, you can be safe in the knowledge that you'll get great results every time.

Welcome to Electrolux.

Visit our website for:



Get usage advice, brochures, trouble shooter, service information:
www.electrolux.com



Register your product for better service:
www.electrolux.com/productregistration

CUSTOMER CARE AND SERVICE

We recommend the use of original spare parts.
When contacting Service, ensure that you have the following data available.
The information can be found on the rating plate. Model, PNC, Serial Number.



Warning / Caution-Safety information



General information and tips



Environmental information

Subject to change without notice.

1. SAFETY INSTRUCTIONS

Before the installation and use of the appliance, carefully read the supplied instructions. The manufacturer is not responsible if an incorrect installation and use causes injuries and damages. Always keep the instructions with the appliance for future reference.



— Caution, risk of fire!

1.1 Children and vulnerable people safety



WARNING!

Risk of suffocation, injury or permanent disability.

- This appliance can be used by children aged from 8 years and above and persons with reduced physical, sensory or mental capabilities or lack of experience and knowledge if they have been given supervision or instruction for the operation of the appliance by a person who is responsible for their safety.
- Do not let children play with the appliance.
- Keep all packaging away from children.
- Keep all detergents away from children.
- Keep children and pets away from the appliance door when it is open.
- Cleaning and user maintenance shall not be made by children without supervision.

1.2 Installation

- Remove all the packaging.
- Do not install or use a damaged appliance.
- Obey the installation instruction supplied with the appliance.
- Make sure that the floor where you install the appliance is flat, stable, heat resistant and clean.
- Do not install or use the appliance where the temperature is less than 5°C or higher than 35°C.
- Do not install the appliance behind a lockable door, a sliding door or a door with a hinge on the opposite side,

where the appliance door can not be fully opened.

- Always be careful when you move the appliance because it is heavy. Always wear safety gloves.
- Always move the appliance vertically.
- The rear surface of the appliance must be put against the wall.
- Make sure that there is air circulation between the appliance and the floor.
- Make sure the carpet does not obstruct the ventilation openings in the base of the appliance (if applicable).
- Exhaust air must not be discharged into a flue which is used for exhausting fumes from appliances burning gas or other fuels.
- If the tumble dryer is put on top of a washing machine, use the stacking kit. The stacking kit, available from your authorized vendor, can be used only with the appliance specified in the instructions, supplied with the accessory. Read it carefully before installation (Refer to the Installation leaflet).
- Ensure you have good ventilation in the installation room to avoid the back flow of gases into the room from appliances burning other fuels, including open fires.
- The appliance can be installed as free-standing or below the kitchen counter with correct space (Refer to the Installation leaflet).
- When the appliance is put in its permanent position, check if it is fully level with the aid of a spirit level. If it is not, adjust the feet until it is.

Electrical connection



WARNING!

Risk of fire and electrical shock.

- The appliance must be earthed.
- Make sure that the electrical information on the rating plate agrees with the power supply. If not, contact an electrician.
- Always use a correctly installed shock-proof socket.
- Do not use multi-plug adapters and extension cables.

- Make sure not to cause damage to the mains plug and to the mains cable. Should the appliance power supply cable need to be replaced, this must be carried out by our Service Centre.
- Connect the mains plug to the mains socket only at the end of the installation. Make sure that there is access to the mains plug after the installation.
- Do not pull the mains cable to disconnect the appliance. Always pull the mains plug.
- Do not touch the mains cable or the mains plug with wet hands.
- This appliance complies with the E.E.C. Directives.

1.3 Use



WARNING!

Risk of fire, explosion, electric shock or damage to the appliance

- Use this appliance in a household only.
- Do not change the specification of this appliance.
- The final part of the drying cycle occurs without heat (cool down cycle) to ensure that the items will not be damaged.

If you stop the appliance before the end of the drying cycle, immediately remove and spread out all items, so that the heat can dissipate.

- If you use fabric softener or similar products, obey the instructions on the packaging.
- Do not run the appliance without a filter. Clean the lint filter before or after each use.
- Wipe away lint that has accumulated around the appliance.
- Do not dry the damaged items which contain padding or fillings.
- Do not dry items such as foam rubber (latex foam), shower caps, waterproof textiles, rubber backed articles and clothes or pillows fitted with foam rubber pads..
- Before drying items that have been in contact with substances such as cooking oil, acetone, alcohol, petrol, kerosene, spot removers, turpentine, waxes and wax removers, wash them in hot

water with an extra amount of detergent.

- Do not dry items in the appliance if industrial chemicals have been used for cleaning.
- Make sure that no gas lighters or matches have been left in the pockets of the clothing.
- Only dry fabrics which are applicable to dry in the tumble dryer. Follow the instructions on the fabric label.
- Do not dry not washed items in the appliance.
- If you have washed your laundry with a stain remover start an extra rinse cycle before you start the dryer.
- Do not drink or prepare food with the condensed water. It can cause health problems to people and pets.
- Do not sit or stand on the open door.
- Obey the maximum load volume of 8 kg (refer to the "Programme chart" chapter).
- Do not dry dripping wet clothes in the tumble dryer.
- Oil-affected items can ignite spontaneously, especially when exposed to heat sources such as in a tumble dryer. The items become warm, causing an oxidation reaction in the oil. Oxidation creates heat. If the heat cannot escape, the items can become hot enough to catch fire. Piling, stacking or storing oil-affected items can prevent heat from escaping and create a fire hazard.
- If it is unavoidable that fabrics that contain vegetable or cooking oil or have been contaminated by hair care products be placed in a tumble dryer they should first be washed in hot water with extra detergent -this will reduce, but not eliminate, the hazard.

1.4 Care and Cleaning



WARNING!

Risk of injury or damage to the appliance.

- Before maintenance, deactivate the appliance and disconnect the mains plug from the mains socket.
- Do not use water spray and steam to clean the appliance.

- Clean the appliance with a moist soft cloth. Only use neutral detergents. Do not use abrasive products, abrasive cleaning pads, solvents or metal objects.

1.5 Disposal



WARNING!

Risk of injury or suffocation.

- Disconnect the appliance from the mains supply.
- Cut off the mains cable and discard it.
- Remove the door catch to prevent children and pets to get closed in the appliance.

Compressor



WARNING!

Risk of damage of the appliance.

- The compressor and its system in the tumble dryer is filled with the special agent which is free from fluoro-chloro-hydrocarbons. This system must stay tight. The damage of the system can cause a leakage.

2. PRODUCT DESCRIPTION

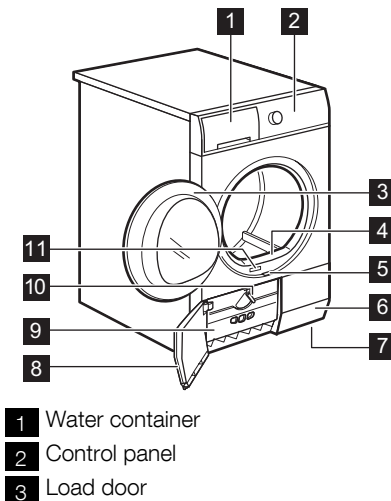

- 4 Primary Filter
- 5 The button to open the heat exchanger door
- 6 Airflow slots
- 7 Adjustable feet
- 8 Heat exchanger door
- 9 Heat exchanger cover
- 10 The knob to lock the heat exchanger cover
- 11 Rating plate



The load door can be installed by the user in the opposite side. It can help to easily put and remove the laundry or if there is a limit to install the appliance (see separate leaflet).

3. CONTROL PANEL

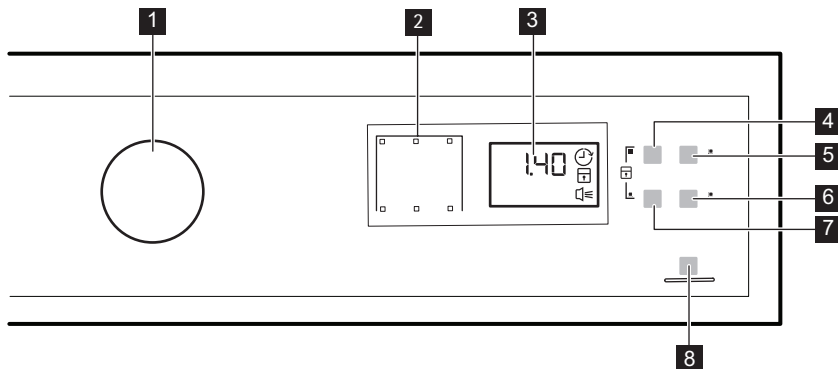

1 Programme knob and ⏻ OFF switch

2 Indicators

3 Display

4 🕒 Time touchpad

5 ⌚ Delay touchpad

6 🔊 Buzzer touchpad

7 🛑 Anticrease touchpad

8 ▶|| Start/Pause touchpad



Touch the touchpads with your finger in the area with the symbol or the name of the option.
Do not wear gloves when you operate with the control panel.
Make sure that the control panel is always clean and dry.

Indicators	Description
)))	Drying phase.
🍃	Cooling phase.
🛑	Crease guard phase.
⇒	Condenser.
👉	Water container.
🌐	Filter.
⌚	Delay start.
🔒	Child lock.
🔊	Acoustic signals.
2.00	Programme duration.
10' - 2.00	Time Drying duration.
30' - 20h	Delay start duration.

4. PROGRAMME TABLE

Programmes	Type of load / Load (max.) ¹⁾ / Fabric mark
Cotton fabrics	
Extra Dry	Drying level: extra dry. / 8kg / ☺☺
Strong Dry	Drying level: strong dry. / 8kg / ☺☺
Cupboard Dry ²⁾	Drying level: cupboard dry. / 8kg / ☺☺
Iron Dry ²⁾	Drying level: applicable for iron. / 8kg / ☺☺
Synthetic fabrics	
Extra Dry	Drying level: extra dry./ 3,5kg / ☺☺☺
Cupboard Dry ²⁾	Drying level: cupboard dry. / 3,5kg / ☺☺☺
Iron Dry	Drying level: applicable for iron. / 3,5kg / ☺☺☺
Sports	Sportswear, thin and light fabrics, microfiber, polyester, which are not ironed. / 2kg / ☺☺☺
Time Drying	With this programme you can use the option Time and set the programme duration. / 8kg / ☺☺☺
Refresh	Refreshing a textiles that were in storage. / 1kg
Wool Refresh	Refreshing a wool fabrics. Wool items become soft and cosy. Remove the items immediately after the programme end. / 1kg
Delicates	Delicate fabrics. / 3kg / ☺☺☺
Duvet	To dry one or two duvet and pillows (with feather, down or synthetic fillings). / 3kg / ☺☺☺
Easy Iron	Easy care fabrics for which a minimum of ironing is necessary. The drying results can be different from one type of fabric to the other. Shake the items before you put them in the appliance. When the programme is completed, Immediately remove the items and put them on a hanger. / 1 kg (or 5 shirts) / ☺☺☺

¹⁾ The maximum weight refers to dry items.

²⁾ **For test institutes only:** Standard programmes for tests are specified in the EN 61121 document.

5. OPTIONS

5.1 Time

This option is applicable only to the Time Drying programme. You can set the pro-

gramme duration, from a minimum of 10 minutes to a maximum of 2 hours. The setting of the duration is related to the quantity of laundry in the appliance.

We recommend that you set a short duration for small quantities of laundry or for only one item.

5.2 Anticrease

Extends of 60 minutes the standard anti-crease phase (30 minutes) at the end of the drying cycle. This function prevents the laundry from creases. The laundry can be removed during the anticrease phase.

- cycle end
- start and end of crease guard phase
- cycle interruption













The buzzer function is by default always on. You can use this function to activate or deactivate the sound.



You can activate the Buzzer option with all programmes.

5.3 Buzzer

When the buzzer function is activated, you can hear the buzzer at the:

Programmes ¹⁾			
Cotton fabrics			
 Extra Dry		•	•
 Strong Dry		•	•
 Cupboard Dry		•	•
 Iron Dry		•	•
Synthetic fabrics			
 Extra Dry		•	•
 Cupboard Dry ²⁾		•	•
 Iron Dry		•	•
 Sports		•	•
 Time Drying	•	•	•
 Refresh		•	•
 Wool Refresh	• ²⁾		•
 Delicates		•	•
 Duvets			•
 Easy Iron		•	•

¹⁾ Together with the programme you can set 1 or more options. To activate or deactivate them, press the related touchpad.

²⁾ Only with the Drying Rack

6. SETTINGS

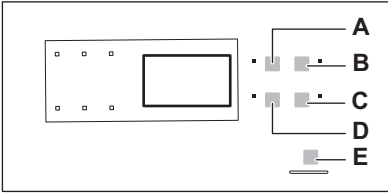

- A) Time touchpad
- B) Delay touchpad
- C) Buzzer touchpad
- D) Antcrease touchpad
- E) Start/Pause touchpad

6.1 Child lock function

This option prevents children to play with the appliance while a programme operates. The programme knob and the touchpads are locked. Only OFF switch is unlocked.

Activating the child lock option

1. Use the programme knob to set any programme.
2. Press and hold touchpads (A) and (D) at the same time until the child lock indicator comes on.
 - It is possible to deactivate the child lock option while a programme operates. Press and hold the same

touchpads until the child lock indicator goes off.

6.2 Water hardness and conductivity

Water hardness is different for different locations. Water hardness has an effect on the water conductivity and on the conductivity sensor of the appliance. If you know, the value of the water conductivity you can adjust the sensor in order to have better drying results.

Adjusting the conductivity sensor

1. Use the programme knob to set any programme.
2. Press and hold touchpads (A) and (B) at the same time until one of the these indicators comes on:
 - (low <300 µS/cm)
 - (moderate 300-600 µS/cm)
 - (high >600 µS/cm)
3. Press the touchpad (E) again and again until the indicator of the correct level comes on.
4. To confirm the adjustment, press and hold touchpads (A) and (B) at the same time for approximately 2 seconds.

7. DAILY USE



Before you use the appliance for the first time do one of these operations:

- Clean the tumble dryer drum with a moist cloth.
- Start a short programme (e.g. 30 minutes) with moist laundry.



At the beginning of drying cycle (3-5 min.) there could be a slightly higher sound level. It is because of start of the compressor that is normal for compressor powered appliances such: refrigerators, freezers .

7.1 Starting a programme without delay start

1. Prepare the laundry and load the appliance.
2. Set the correct programme and options for the type of load.
 - The display shows the programme duration.
3. Press the Start/Pause touchpad, the programme starts.

**CAUTION!**

Make sure that when you close the door, the laundry does not catch between the appliance door and the rubber seal.

7.2 Starting the programme with delay start

1. Set the correct programme and options for the type of load.
2. Press the delay start button again and again until the display shows the delay time you want to set.
 - You can delay the start of a programme from a minimum of 30 minutes to a maximum of 20 hours.
3. Press the Start/Pause touchpad, the countdown starts. The display shows the countdown of the delay start.
 - When the countdown is completed, the programme starts.



7.3 Change a programme

1. Turn the Programme knob to ① OFF
2. Set the programme.

7.4 At the end of the programme

When the programme is completed,

- An intermittent acoustic signal operates.
- The indicator  flashes.

- The indicator  comes on.
- The Start/Pause indicator is on. The appliance continues to operate with the crease guard phase for approximately other 30 minutes. The crease guard phase removes creases from your laundry. You can remove the laundry before the crease guard phase is completed. We recommend, for better results, that you remove the laundry when the phase is almost completed or completed. When the crease guard phase is completed:
 1. Turn the Programme knob to ① OFF
 2. Open the appliance door.
 3. Remove the laundry.
 4. Close the appliance door.
- The indicator  is on but does not flash.
- The indicator  goes off.
- Start/Pause indicator goes off.



Always clean the filter and empty the water container when a programme is completed.

7.5 Auto STAND-BY function

To decrease the energy consumption, this function automatically deactivates the appliance:

- After 5 minutes if you do not start the programme.
- After 5 minutes from the end of the programme.

8. HINTS AND TIPS

8.1 Preparing the laundry

- Close the zippers.
- Close the fasteners of the duvet covers.
- Do not keep ties or ribbons loose (e.g. apron ribbons). Tie them before you start a programme.
- Remove all items from the pockets.
- If an item has the internal layer made of cotton, turn it inside out. Make sure that the cotton layer is always external.
- We recommend that you set the correct programme applicable for the type of fabrics that are in the appliance.
- Do not put fabrics with strong colours together with fabrics with light colours. Strong colours can bleed.
- Use an applicable programme for cotton jersey and knitwear to prevent the items to shrink.
- Make sure that the laundry weight is not more than the maximum weight that is in the programme table.

- Dry only the laundry that is applicable for tumble dryer. Refer to the fabric label on the items.

Fabric label	Description
	Laundry that is applicable for tumble dryer.
	Laundry that is applicable for tumble dryer. Set the programme with standard temperature.
	Laundry that is applicable for tumble dryer. Set the programme with low temperature.
	Laundry that is not applicable for tumble dryer.

9. CARE AND CLEANING

9.1 Cleaning the filter

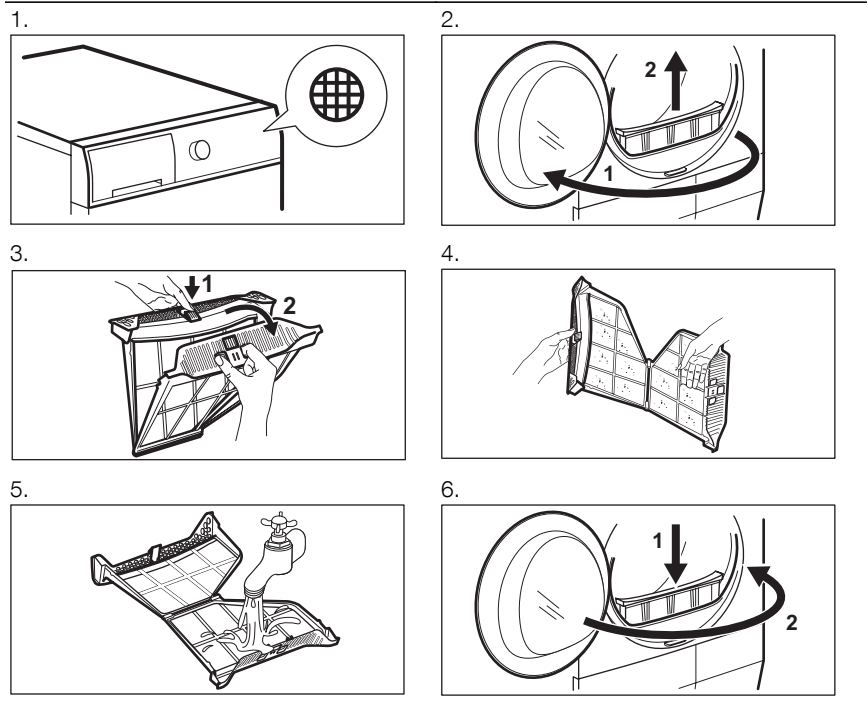

9.2 Draining the water container

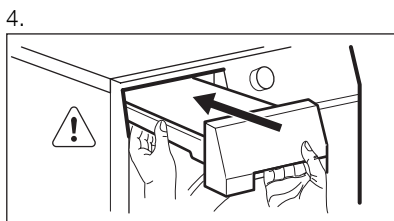
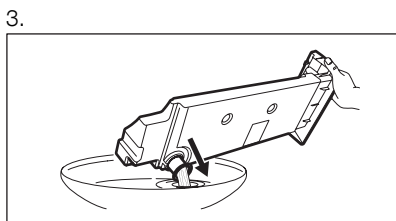
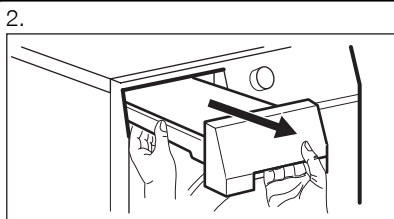
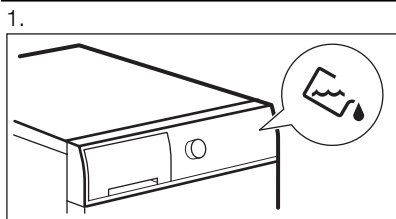

You can use the water from the water container as an alternative to distilled water (e.g. for steam ironing). Before you use the water, remove dirt residues with a filter.

9.3 Cleaning the condenser



The frequency to clean the filters is related to the laundry type and its quantity. If you dry with the maximum load, clean the filters after each 3 cycles.

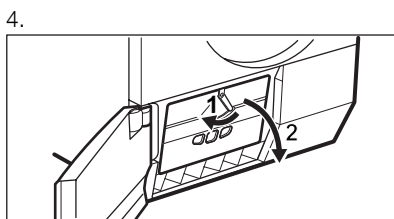
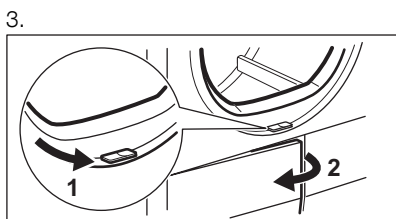
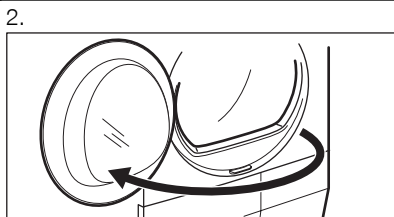
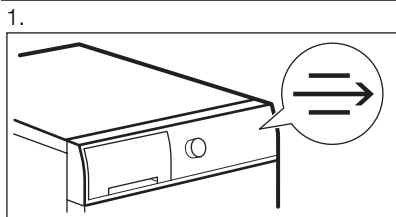

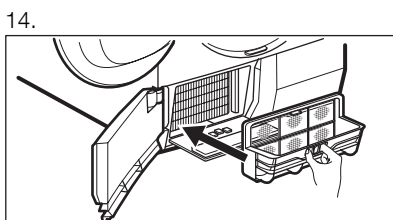
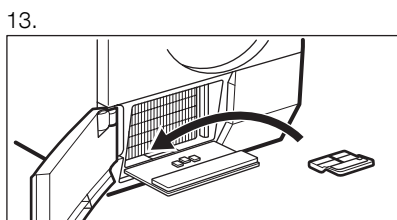
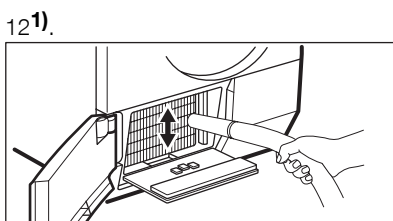
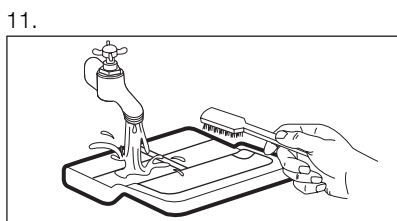
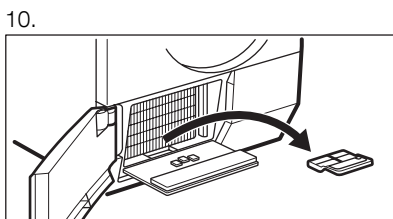
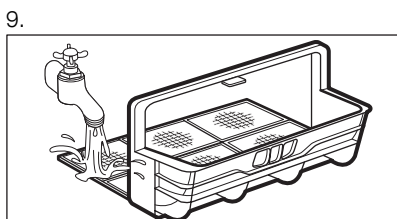
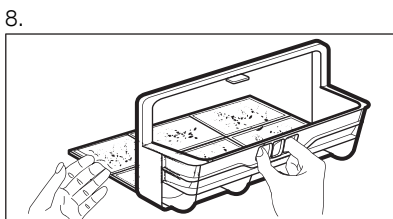
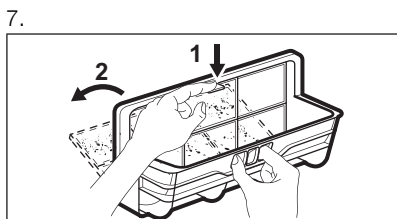
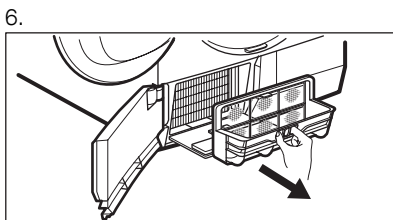
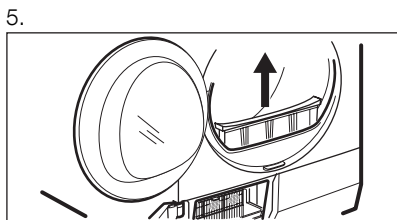

15.

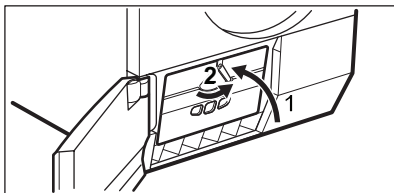

16.

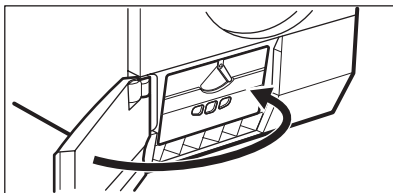

1) If necessary, one time for each 6 months, remove the fluff from the heat exchanger compartment. You can use a vacuum cleaner.

9.4 Cleaning the drum

Clean the drum with a moist cloth. Only use neutral detergents. Do not use abrasive products, abrasive cleaning pads or solvents.

Dry the drum with a soft cloth.

9.5 External Cleaning

Clean the appliance with a moist cloth. Only use neutral detergents. Do not use

abrasive products, abrasive cleaning pads or solvents.

Dry the appliance with a soft cloth.

9.6 Cleaning the airflow slots

Use a vacuum cleaner to remove the fluff from the airflow slots.

10. TROUBLESHOOTING

10.1

Problem	Possible solution
You cannot activate the appliance.	Make sure that the mains plug is connected to the mains socket.
	Make sure that there is not a damaged fuse in the fuse box.
The programme does not start.	Press Start/Pause .
	Make sure that the appliance door is closed.
The appliance door does not close.	Make sure that the installation of the filter is correct.
	Make sure that the laundry does not catch between the appliance door and the rubber seal.
The appliance stops during operation.	Make sure that the water container is empty. Press Start/Pause to start the programme again.
The display shows a long programme duration. ¹⁾	Make sure that the weight of the laundry is applicable to the duration of the programme.

Problem	Possible solution
	Make sure that the filter is clean.
	The laundry is too wet. Spin the laundry in the washing machine again.
	Make sure that the room temperature is not too warm.
The display shows a short programme duration.	Set the Time Drying or the Extra Dry programme.
The display shows Err.	If you want to set a new programme, deactivate and activate the appliance.
	Make sure that the options are applicable to the programme.
The display shows E51)	Deactivate and activate the appliance. Start a new programme. If the problem occurs again, contact the Service.

1) After maximum 5 hours, the programme ends automatically

10.2 If the drying results are not satisfactory

- The set programme was incorrect.
- The filter is clogged.
- The condenser is clogged.
- There was too much laundry in the appliance.
- The drum is dirty.
- Incorrect setting of the conductivity sensor.
- The airflow slots are clogged.

11. TECHNICAL DATA

Dimensions (mm)	Width / Height / Depth	600 / 850 – 865 / 600
Max. depth (with the appliance door open)		1090 mm
Max. width (with the appliance door open)		950 mm
Electrical connection	Voltage	230-240 V
	Frequency	50 Hz
	Fuse	4 A
	Total power	900 W
Drum volume		108 l
Weight of the appliance		57 kg
Laundry: max. weight		8 kg
Type of use		Household
Ambient temperature	Min.	5 °C
	Max.	35 °C

Energy consumption 1)	kWh/cycle	2,35 kWh
Annual energy consumption 2)		121,6 kWh
Energy efficiency class		A
Power consumption	Left-on mode	0,48 W
	Off-mode	0,48 W

1) With reference to EN 61121. 8 kg of cotton and a spin speed at 1000 rpm.

2) This is the approximate energy consumption for the 4 persons who correctly use the appliance.

12. ENVIRONMENT CONCERNS

Recycle the materials with the symbol  . Put the packaging in applicable containers to recycle it. Help protect the environment and human health and to recycle waste of electrical

and electronic appliances. Do not dispose appliances marked with the symbol  with the household waste. Return the product to your local recycling facility or contact your municipal office.

www.electrolux.com



136922530-A-082012



Free Manuals Download Website

<http://myh66.com>

<http://usermanuals.us>

<http://www.somanuals.com>

<http://www.4manuals.cc>

<http://www.manual-lib.com>

<http://www.404manual.com>

<http://www.luxmanual.com>

<http://aubethermostatmanual.com>

Golf course search by state

<http://golfingnear.com>

Email search by domain

<http://emailbydomain.com>

Auto manuals search

<http://auto.somanuals.com>

TV manuals search

<http://tv.somanuals.com>