

EKC6430AOW
EKC6430AOX



EN Cooker

User Manual



Electrolux

CONTENTS

1. SAFETY INFORMATION.....	3
2. SAFETY INSTRUCTIONS.....	5
3. PRODUCT DESCRIPTION.....	8
4. BEFORE FIRST USE.....	8
5. HOB - DAILY USE.....	9
6. HOB - HINTS AND TIPS.....	10
7. HOB - CARE AND CLEANING.....	11
8. OVEN - DAILY USE	11
9. OVEN - CLOCK FUNCTIONS.....	13
10. OVEN - HINTS AND TIPS.....	14
11. OVEN - CARE AND CLEANING.....	25
12. TROUBLESHOOTING.....	27
13. INSTALLATION.....	29
14. ENERGY EFFICIENCY.....	30

WE'RE THINKING OF YOU

Thank you for purchasing an Electrolux appliance. You've chosen a product that brings with it decades of professional experience and innovation. Ingenious and stylish, it has been designed with you in mind. So whenever you use it, you can be safe in the knowledge that you'll get great results every time.

Welcome to Electrolux.

Visit our website for:



Get usage advice, brochures, trouble shooter, service information:
www.electrolux.com/webselfservice



Register your product for better service:
www.registerelectrolux.com



Buy Accessories, Consumables and Original spare parts for your appliance:
www.electrolux.com/shop

CUSTOMER CARE AND SERVICE

Always use original spare parts.

When contacting our Authorised Service Centre, ensure that you have the following data available: Model, PNC, Serial Number.

The information can be found on the rating plate.

 Warning / Caution-Safety information

 General information and tips

 Environmental information

Subject to change without notice.

1. ⚠ SAFETY INFORMATION

Before the installation and use of the appliance, carefully read the supplied instructions. The manufacturer is not responsible for any injuries or damages that are the result of incorrect installation or usage. Always keep the instructions in a safe and accessible location for future reference.

1.1 Children and vulnerable people safety



WARNING!

Risk of suffocation, injury or permanent disability.

- This appliance can be used by children aged from 8 years and above and persons with reduced physical, sensory or mental capabilities or lack of experience and knowledge if they have been given supervision or instruction concerning the use of the appliance in a safe way and understand the hazards involved.
- Do not let children play with the appliance.
- Keep all packaging away from children and dispose of it appropriately.
- Keep children and pets away from the appliance when it operates or when it cools down. Accessible parts are hot.
- Children shall not carry out cleaning and user maintenance of the appliance without supervision.

1.2 General Safety

- Only a qualified person must install this appliance and replace the cable.
- This appliance must be connected to the mains with a H05VV-F type cable to withstand the temperature of the rear panel.
- This appliance is intended for use up to an altitude of 2000 m above sea level.

- This appliance is not intended to be used on a ships, boats or vessels.
- Do not install the appliance behind a decorative door in order to avoid overheating.
- Do not install the appliance on a platform.
- Do not operate the appliance by means of an external timer or separate remote-control system.
- **WARNING:** Unattended cooking on a hob with fat or oil can be dangerous and may result in fire.
- **NEVER** try to extinguish a fire with water, but switch off the appliance and then cover flame e.g. with a lid or a fire blanket.
- **CAUTION:** The cooking process has to be supervised. A short term cooking process has to be supervised continuously.
- **WARNING:** Danger of fire: Do not store items on the cooking surfaces.
- Do not use a steam cleaner to clean the appliance.
- Do not use harsh abrasive cleaners or sharp metal scrapers to clean the glass door or the glass of hinged lids of the hob since they can scratch the surface, which may result in shattering of the glass.
- Metallic objects such as knives, forks, spoons and lids should not be placed on the hob surface since they can get hot.
- If the glass ceramic surface / glass surface is cracked, switch off the appliance to avoid the possibility of electric shock.
- **WARNING:** The appliance and its accessible parts become hot during use. Care should be taken to avoid touching heating elements. Children less than 8 years of age shall be kept away unless continuously supervised.
- Always use oven gloves to remove or put in accessories or ovenware.
- Before maintenance cut the power supply.

- Ensure that the appliance is switched off before replacing the lamp to avoid the possibility of electric shock.
- If the mains power supply cable is damaged, it must be replaced by the manufacturer, its Authorised Service Centre or similarly qualified persons to avoid an electrical hazard.
- Be careful when you touch the storage drawer. It can get hot.
- To remove the shelf supports first pull the front of the shelf support and then the rear end away from the side walls. Install the shelf supports in the opposite sequence.
- The means for disconnection must be incorporated in the fixed wiring in accordance with the wiring rules.
- **WARNING:** Use only hob guards designed by the manufacturer of the cooking appliance or indicated by the manufacturer of the appliance in the instructions for use as suitable or hob guards incorporated in the appliance. The use of inappropriate guards can cause accidents.

2. SAFETY INSTRUCTIONS

2.1 Installation



WARNING!

Only a qualified person must install this appliance.

- Remove all the packaging.
- Do not install or use a damaged appliance.
- Follow the installation instruction supplied with the appliance.
- Always take care when moving the appliance as it is heavy. Always use safety gloves and enclosed footwear.
- Do not pull the appliance by the handle.
- The kitchen cabinet and the recess must have suitable dimensions.
- Keep the minimum distance from the other appliances and units.
- Make sure that the appliance is installed below and adjacent safe structures.
- Parts of the appliance carry current. Close the appliance with furniture to prevent touching the dangerous parts.
- The sides of the appliance must stay adjacent to appliances or to units with the same height.
- Do not install the appliance adjacent to a door or under a window. This prevents hot cookware to fall from the appliance when the door or the window is opened.
- Make sure to install a stabilizing means in order to prevent tipping of the appliance. Refer to Installation chapter.

2.2 Electrical Connection



WARNING!

Risk of fire and electrical shock.

- All electrical connections should be made by a qualified electrician.
- The appliance must be earthed.
- Make sure that the parameters on the rating plate are compatible with the electrical ratings of the mains power supply.
- Always use a correctly installed shockproof socket.
- Do not use multi-plug adapters and extension cables.
- Do not let mains cables touch or come near the appliance door, especially when the door is hot.
- The shock protection of live and insulated parts must be fastened in such a way that it cannot be removed without tools.
- Connect the mains plug to the mains socket only at the end of the installation. Make sure that there is access to the mains plug after the installation.
- If the mains socket is loose, do not connect the mains plug.
- Do not pull the mains cable to disconnect the appliance. Always pull the mains plug.
- Use only correct isolation devices: line protecting cut-outs, fuses (screw type fuses removed from the holder), earth leakage trips and contactors.
- The electrical installation must have an isolation device which lets you disconnect the appliance from the mains at all poles. The isolation device must have a contact opening width of minimum 3 mm.
- Fully close the appliance door, before you connect the mains plug to the mains socket.

2.3 Use



WARNING!

Risk of injury and burns.
Risk of electrical shock.

- This appliance is for household use only.

- Do not change the specification of this appliance.
- Make sure that the ventilation openings are not blocked.
- Do not let the appliance stay unattended during operation.
- Deactivate the appliance after each use.
- Be careful when you open the appliance door while the appliance is in operation. Hot air can release.
- Do not operate the appliance with wet hands or when it has contact with water.
- Do not use the appliance as a work surface or as a storage surface.



WARNING!

Risk of fire and explosion

- Fats and oil when heated can release flammable vapours. Keep flames or heated objects away from fats and oils when you cook with them.
- The vapours that very hot oil releases can cause spontaneous combustion.
- Used oil, that can contain food remnants, can cause fire at a lower temperature than oil used for the first time.
- Do not put flammable products or items that are wet with flammable products in, near or on the appliance.
- Do not let sparks or open flames to come in contact with the appliance when you open the door.
- Open the appliance door carefully. The use of ingredients with alcohol can cause a mixture of alcohol and air.



WARNING!

Risk of damage to the appliance.

- To prevent damage or discoloration to the enamel:
 - do not put ovenware or other objects in the appliance directly on the bottom.
 - do not put water directly into the hot appliance.
 - do not keep moist dishes and food in the appliance after you finish the cooking.
 - be careful when you remove or install the accessories.

- Discoloration of the enamel or stainless steel has no effect on the performance of the appliance.
- Use a deep pan for moist cakes. Fruit juices cause stains that can be permanent.
- Do not keep hot cookware on the control panel.
- Do not let cookware boil dry.
- Be careful not to let objects or cookware fall on the appliance. The surface can be damaged.
- Do not activate the cooking zones with empty cookware or without cookware.
- Do not put aluminium foil on the appliance or directly on the bottom of the appliance.
- Cookware made of cast iron, aluminium or with a damaged bottom can cause scratches. Always lift these objects up when you have to move them on the cooking surface.
- This appliance is for cooking purposes only. It must not be used for other purposes, for example room heating.
- Make sure the cavity and the door are wiped dry after each use. Steam produced during the operation of the appliance condensates on cavity walls and can cause corrosion. To decrease the condensation operate the appliance for 10 minutes before cooking.
- Clean the appliance with a moist soft cloth. Only use neutral detergents. Do not use any abrasive products, abrasive cleaning pads, solvents or metal objects.
- If you use an oven spray, obey the safety instructions on the packaging.
- Do not clean the catalytic enamel (if applicable) with any kind of detergent.

2.4 Care and Cleaning



WARNING!

Risk of injury, fire, or damage to the appliance.

- Before maintenance, deactivate the appliance. Disconnect the mains plug from the mains socket.
- Make sure the appliance is cold. There is the risk that the glass panels can break.
- Replace immediately the door glass panels when they are damaged. Contact the Authorised Service Centre.
- Be careful when you remove the door from the appliance. The door is heavy!
- Fat and food remaining in the appliance can cause fire.
- Clean regularly the appliance to prevent the deterioration of the surface material.

2.5 Internal light

- The type of light bulb or halogen lamp used for this appliance is only for household appliances. Do not use it for house lighting.



WARNING!

Risk of electrical shock.

- Before replacing the lamp, disconnect the appliance from the power supply.
- Only use lamps with the same specifications.

2.6 Disposal



WARNING!

Risk of injury or suffocation.

- Disconnect the appliance from the mains supply.
- Cut off the mains electrical cable close to the appliance and dispose of it.
- Remove the door catch to prevent children or pets from becoming trapped in the appliance.

2.7 Service

- To repair the appliance contact an Authorised Service Centre.
- Use original spare parts only.

3. PRODUCT DESCRIPTION

3.1 General overview

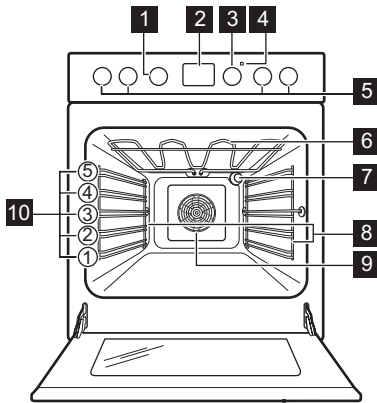

- 1 Knob for the oven functions
- 2 Electronic programmer
- 3 Knob for the temperature
- 4 Power lamp / symbol
- 5 Knobs for the hob
- 6 Heating element
- 7 Lamp
- 8 Shelf support, removable
- 9 Fan
- 10 Shelf positions

3.2 Cooking surface layout

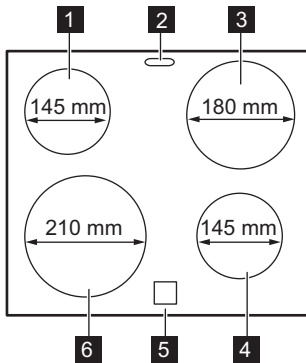

- 1 Cooking zone 1200 W
- 2 Steam outlet - number and position depend on the model
- 3 Cooking zone 1800 W
- 4 Cooking zone 1200 W
- 5 Residual heat indicator
- 6 Cooking zone 2300 W

3.3 Accessories

- **Wire shelf**
For cookware, cake tins, roasts.
- **Combi pan**
For cakes and biscuits. To bake and roast or as a pan to collect fat.

- **Storage drawer**

The storage drawer is below the oven cavity.

4. BEFORE FIRST USE



WARNING!
Refer to Safety chapters.

4.1 Initial Cleaning

Remove all accessories and removable shelf supports from the appliance.

 Refer to "Care and cleaning" chapter.



Clean the appliance and the accessories before first use.

Put the accessories and the removable shelf supports back to their initial position.

4.2 Setting the time



You must set the time before you operate the oven.

The  flashes when you connect the appliance to the electrical supply, when there was a power cut or when the timer is not set.

Press the  or  to set the correct time.

After approximately five seconds, the flashing stops and the display shows the time of day you set.

4.3 Changing the time



 You cannot change the time of day if the Duration  or End  function operates.

Press  again and again until the indicator for the Time of Day function flashes.

To set a new time, refer to "Setting the time".

4.4 Preheating

Preheat the empty appliance to burn off the remaining grease.

1. Set the function  and the maximum temperature.
2. Let the appliance operate for 1 hour.
3. Set the function  and set the maximum temperature.
4. Let the appliance operate for 15 minutes.

Accessories can become hotter than usual. The appliance can emit an odour and smoke. This is normal. Make sure that the airflow in the room is sufficient.

5. HOB - DAILY USE

 **WARNING!**
Refer to Safety chapters.

5.1 Heat setting

Symbols	Function
0	Off position
	Keep warm
1 - 9	Heat settings



Use the residual heat to decrease energy consumption. Deactivate the cooking zone approximately 5 - 10 minutes before the cooking process is completed.

Turn the knob to a necessary heat setting.

To complete the cooking process, turn the knob to the off position.

5.2 Residual heat indicator



WARNING!

There is a risk of burns from residual heat.

The indicator comes on when a cooking zone is hot.

6. HOB - HINTS AND TIPS



WARNING!

Refer to Safety chapters.

6.2 Examples of cooking applications

6.1 Cookware



The bottom of the cookware must be as thick and flat as possible.



Cookware made of enamelled steel and with aluminium or copper bottoms can cause the colour change on the glass-ceramic surface.



The data in the table is for guidance only.

Heat setting	Use to:	Time (min)	Hints
 - 1	Keep cooked food warm.	as necessary	Put a lid on the cookware.
1 - 2	Hollandaise sauce, melt: butter, chocolate, gelatine.	5 - 25	Mix from time to time.
1 - 2	Solidify: fluffy omelettes, baked eggs.	10 - 40	Cook with a lid on.
2 - 3	Simmer rice and milkbased dishes, heating up ready-cooked meals.	25 - 50	Add the minimum twice as much liquid as rice, mix milk dishes part procedure through.
3 - 4	Steam vegetables, fish, meat.	20 - 45	Add some tablespoons of liquid.
4 - 5	Steam potatoes.	20 - 60	Use max. ¼ l water for 750 g of potatoes.
4 - 5	Cook larger quantities of food, stews and soups.	60 - 150	Up to 3 l liquid plus ingredients.
6 - 7	Gentle fry: escalope, veal cordon bleu, cutlets, rissoles, sausages, liver, roux, eggs, pancakes, doughnuts.	as necessary	Turn halfway through.

Heat setting	Use to:	Time (min)	Hints
7 - 8	Heavy fry, hash browns, loin steaks, steaks.	5 - 15	Turn halfway through.
9	Boil water, cook pasta, sear meat (goulash, pot roast), deep-fry chips.		

7. HOB - CARE AND CLEANING



WARNING!

Refer to Safety chapters.

7.1 General information

- Clean the hob after each use.
- Always use cookware with clean bottom.
- Scratches or dark stains on the surface have no effect on how the hob operates.
- Use a special cleaner applicable for the surface of the hob.
- Use a special scraper for the glass.

7.2 Cleaning the hob

- **Remove immediately:** melted plastic, plastic foil, sugar and food with sugar.

If not, the dirt can cause damage to the hob. Take care to avoid burns. Put the special scraper on the glass surface at an acute angle and move the blade on the surface.

- **Remove when the hob is sufficiently cool:** limescale rings, water rings, fat stains, shiny metallic discoloration. Clean the hob with a moist cloth and non-abrasive detergent. After cleaning, wipe the hob dry with a soft cloth.
- **Remove shiny metallic discoloration:** use a solution of water with vinegar and clean the glass surface with a moist cloth.



8. OVEN - DAILY USE







WARNING!

Refer to Safety chapters.

8.1 Oven functions

Symbol	Oven function	Application
0	Off position	The appliance is off.
	Oven Lamp	To activate the lamp without a cooking function.
	Circulated cooking	To roast or roast and bake food with the same cooking temperature on more than one shelf position, without flavour transference.
	Conventional Cooking	To bake and roast food on one shelf position.

Symbol	Oven function	Application
	Bottom heat	To bake cakes with crispy bottom and to preserve food.
	Defrost	This function can be used for defrosting frozen foods, such as vegetables and fruits. The defrosting time depends on the amount and size of the frozen food.
	Grilling	To grill flat food and to toast bread.
	Light Cooking	To bake in tins and dry on one shelf level at a low temperature.
	Turbo Grilling	To roast larger meat joints or poultry with bones on one shelf position. Also to make gratins and to brown.

8.2 Activating and deactivating the oven



It depends on the model if your appliance has knob symbols, indicators or lamps:

- The indicator comes on when the oven heats up.
- The lamp comes on when the oven operates.
- The symbol shows whether the knob controls one of the cooking zones, the oven functions or the temperature.

1. Turn the knob for the oven functions to select an oven function.
2. Turn the knob for the temperature to select a temperature.
3. To deactivate the oven turn the knobs for the oven functions and temperature to the off position.

8.3 Cooling fan

When the appliance operates, the cooling fan activates automatically to keep the surfaces of the appliance cool. If you deactivate the appliance, the cooling fan can continue to operate until the appliance cools down.

8.4 Inserting the oven accessories

Deep pan:

Push the deep pan between the guide bars of the shelf support.

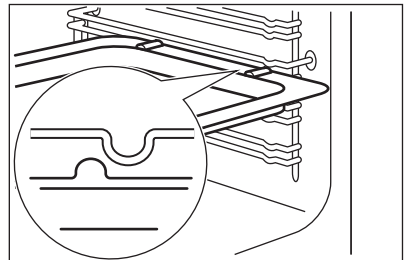

Wire shelf and the deep pan together:

Push the deep pan between the guide bars of the shelf support and the wire shelf on the guide bars above.

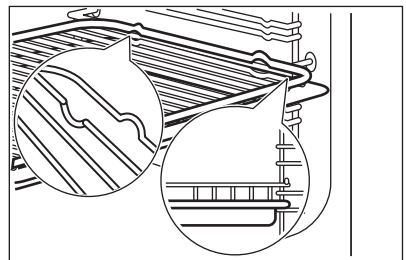

- i**
- All accessories have small indentations at the top of the right and left side to increase safety. The indentations are also anti-tip devices.
 - The high rim around the shelf is a device which prevents cookware from slipping.

9. OVEN - CLOCK FUNCTIONS

9.1 Display

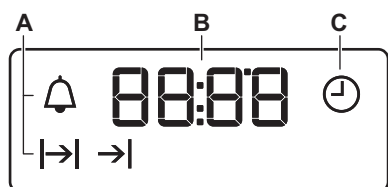

- A. Function indicators
 B. Time display
 C. Function indicator





9.2 Buttons

Button	Function	Description
—	MINUS	To set the time.
⌚	CLOCK	To set a clock function.
+	PLUS	To set the time.

9.3 Clock functions table

Clock function	Application
⌚ TIME OF DAY	To set, change or check the time of day.
-> DURATION	To set how long the appliance operates.
-> END	To set when the appliance deactivates.
-> -> TIME DELAY	To combine DURATION and END function.
🔔 MINUTE MINDER	To set countdown time. This function has no effect on the operation of the appliance. You can set the MINUTE MINDER at any time, also when the appliance is off.





9.4 Setting the DURATION

1. Set an oven function and temperature.
2. Press  again and again until  starts to flash.
3. Press  or  to set the DURATION time.

The display shows .

4. When the time ends,  flashes and an acoustic signal sounds. The appliance deactivates automatically.
5. Press any button to stop the acoustic signal.
6. Turn the knob for the oven functions and the knob for the temperature to the off position.





9.5 Setting the END

1. Set an oven function and temperature.
2. Press  again and again until  starts to flash.
3. Press  or  to set the time.



The display shows .

4. When the time ends,  flashes and an acoustic signal sounds. The appliance deactivates automatically.
5. Press any button to stop the signal.
6. Turn the knob for the oven functions and the knob for the temperature to the off position.

9.6 Setting the TIME DELAY

1. Set an oven function and temperature.
2. Press  again and again until  starts to flash.
3. Press  or  to set the time for DURATION.

4. Press .





5. Press  or  to set the time for END.

6. Press  to confirm.

Appliance turns on automatically later on, works for the set DURATION time and stops at the set END time. At the set time an acoustic signal sounds.

7. The appliance deactivates automatically. Press any button to stop the signal.
8. Turn the knob for the oven functions and the knob for the temperature to the off position.

9.7 Setting the MINUTE MINDER

1. Press  again and again until  starts to flash.
2. Press  or  to set the necessary time.

The Minute Minder starts automatically after 5 seconds.

3. When the set time ends, an acoustic signal sounds. Press any button to stop the acoustic signal.
4. Turn the knob for the oven functions and the knob for the temperature to the off position.

9.8 Cancelling the clock functions

1. Press the  again and again until the necessary function indicator starts to flash.

2. Press and hold .

The clock function goes out after some seconds.

10. OVEN - HINTS AND TIPS



WARNING!

Refer to Safety chapters.



The temperature and baking times in the tables are guidelines only. They depend on the recipes and the quality and quantity of the ingredients used.

Always preheat an empty oven at the temperature required for the food for 20 minutes before you start cooking.

10.1 Baking

- Your oven may bake or roast differently to the appliance you had before. Adapt your usual settings such as temperature, cooking time and shelf position to the values in the tables.

- Use the lower temperature the first time.
- If you cannot find the settings for a special recipe, look for the similar one.
- You can extend baking times by 10 – 15 minutes if you bake cakes on more than one shelf position.
- Cakes and pastries at different heights do not always brown equally at first. If this occurs, do not change the temperature setting. The differences equalize during the baking procedure.
- Trays in the oven can twist during baking. When the trays become cold again, the distortions disappear.

10.2 Tips on baking

Baking results	Possible cause	Remedy
The bottom of the cake is not browned sufficiently.	The shelf position is incorrect.	Put the cake on a lower shelf.
The cake sinks and becomes soggy, lumpy or streaky.	The oven temperature is too high.	The next time you bake, set a slightly lower oven temperature.
The cake sinks and becomes soggy, lumpy or streaky.	The baking time is too short.	Set a longer baking time. You cannot decrease baking times by setting higher temperatures.
The cake sinks and becomes soggy, lumpy or streaky.	There is too much liquid in the mixture.	Use less liquid. Be careful with mixing times, especially if you use a mixing machine.
The cake is too dry.	The oven temperature is too low.	The next time you bake, set a higher oven temperature.
The cake is too dry.	The baking time is too long.	The next time you bake, set a shorter baking time.
The cake browns unevenly.	The oven temperature is too high and the baking time is too short.	Set a lower oven temperature and a longer baking time.
The cake browns unevenly.	The mixture is unevenly distributed.	Spread the mixture evenly on the baking tray.

Baking results	Possible cause	Remedy
The cake is not ready in the baking time given.	The oven temperature is too low.	The next time you bake, set a slightly higher oven temperature.

10.3 Light Cooking

- Bake only one tin or tray at a time.

- Use the function to bake in tins and dry on one shelf level at a low temperature.

Food	Temperature (°C)	Time (min)
Biscuits	180 - 190	10 - 20 ¹⁾
Pastry: Choux	180 - 190	30 - 40 ¹⁾
Pastry: Shortcrust	180 - 190	25 - 35 ¹⁾
Meringues	80 - 100	120 - 150

¹⁾ Preheat the oven.

10.4 Circulated Cooking

Baking on one oven level

Baking in tins

Food	Temperature (°C)	Time (min)	Shelf position
Ring cake or brioche	150 - 160	50 - 70	2
Madeira cake / Fruit cakes	140 - 160	50 - 90	1 - 2
Fatless sponge cake	150 - 160 ¹⁾	25 - 40	3
Flan base - short pastry	170 - 180	10 - 25	2
Flan base - sponge mixture	150 - 170	20 - 25	2
Apple pie (2tins Ø20cm, diagonally off set)	160	60 - 90	2 - 3

¹⁾ Preheat the oven.

Cakes / pastries / breads on baking trays

Food	Temperature (°C)	Time (min)	Shelf position
Cake with crumble topping (dry)	150 - 160	20 - 40	3

Food	Temperature (°C)	Time (min)	Shelf position
Fruit flans (made with yeast dough / sponge mixture) ¹⁾	150	35 - 55	3
Fruit flans made with short pastry	160 - 170	40 - 80	3

¹⁾ Use deep pan.

Biscuits

Food	Temperature (°C)	Time (min)	Shelf position
Short pastry biscuits	150 - 160	10 - 20	3
Short bread / Pastry Stripes	140	20 - 35	3
Biscuits made with sponge mixture	150 - 160	15 - 20	3
Pastries made with egg white, meringues	80 - 100	120 - 150	3
Macaroons	100 - 120	30 - 50	3
Biscuits made with yeast dough	150 - 160	20 - 40	3
Puff pastries	170 - 180 ¹⁾	20 - 30	3
Rolls	160	10 - 35	3
Small cakes (20per tray)	150	20 - 35	3

¹⁾ Preheat the oven.

Bakes and gratins table

Food	Temperature (°C)	Time (min)	Shelf position
Baguettes topped with melted cheese	160 - 170 ¹⁾	15 - 30	1
Stuffed vegetables	160 - 170	30 - 60	1

¹⁾ Preheat the oven.

Multileveled Baking

Cakes / pastries / breads on baking trays

Food	Temperature (°C)	Time (min)	Shelf position 2 positions
Cream puffs / Eclairs	160 - 180 ¹⁾	25 - 45	2 / 4
Dry streusel cake	150 - 160	30 - 45	2 / 4

¹⁾ Preheat the oven.

Biscuits / small cakes / pastries / rolls

Food	Temperature (°C)	Time (min)	Shelf position 2 positions
Short pastry biscuits	150 - 160 ¹⁾	20 - 40	2 / 4
Short bread / Pastry Stripes	140	20 - 45	2 / 4
Biscuits made with sponge mixture	160 - 170	25 - 45	2 / 4
Biscuits made with egg white, meringues	80 - 100	130 - 170	2 / 4
Macaroons	100 - 120	40 - 80	2 / 4
Biscuits made with yeast dough	160 - 170	30 - 60	2 / 4
Puff pastries	170 - 180	30 - 50	2 / 4

1) Preheat the oven.

10.5 Conventional Baking on one level **Baking in tins**

Food	Temperature (°C)	Time (min)	Shelf position
Ring cake or brioche	160 - 180	50 - 70	2
Madeira cake / Fruit cakes	150 - 170	50 - 90	1 - 2
Fatless sponge cake	170 ¹⁾	25 - 40	3
Flan base - short pastry	190 - 210 ¹⁾	10 - 25	2
Flan base - sponge mixture	170 - 190	20 - 25	2
Apple pie (2tins Ø20cm, diagonally off set)	180	60 - 90	1 - 2
Savoury flan (e. g. quiche lorraine)	180 - 220	35 - 60	1
Cheesecake	160 - 180	60 - 90	1 - 2

1) Preheat the oven.

Cakes / pastries / breads on baking trays

Food	Temperature (°C)	Time (min)	Shelf position
Plaited bread / Bread crown	170 - 190	40 - 50	2
Christmas stollen	160 - 180 ¹⁾	50 - 70	2
Bread (rye bread): 1. First part of baking process. 2. Second part of baking process.	1. 230 ¹⁾ 2. 160 - 180 ¹⁾	1. 20 2. 30 - 60	1 - 2

Food	Temperature (°C)	Time (min)	Shelf position
Cream puffs / Eclairs	190 - 210 ¹⁾	20 - 35	3
Swiss roll	180 - 200 ¹⁾	10 - 20	3
Cake with crumble topping (dry)	160 - 180	20 - 40	3
Buttered almond cake / Sugar cakes	190 - 210 ¹⁾	20 - 30	3
Fruit flans (made with yeast dough / sponge mixture) ²⁾	170	35 - 55	3
Fruit flans made with short pastry	170 - 190	40 - 60	3
Yeast cakes with delicate toppings (e.g. quark, cream, custard)	160 - 180 ¹⁾	40 - 80	3
Pizza (with a lot of topping)	190 - 210 ¹⁾	30 - 50	1 - 2
Pizza (thin crust)	220 - 250 ¹⁾	15 - 25	1 - 2
Unleavened bread	230 - 250	10 - 15	1
Tarts (CH)	210 - 230	35 - 50	1

1) Preheat the oven.

2) Use deep pan.

Biscuits

Food	Temperature (°C)	Time (min)	Shelf position
Short pastry biscuits	170 - 190	10 - 20	3
Short bread / Pastry Stripes	160 ¹⁾	20 - 35	3
Biscuits made with sponge dough	170 - 190	20 - 30	3
Pastries made with egg white, meringues	80 - 100	120 - 150	3
Macaroons	120 - 130	30 - 60	3
Biscuits made with yeast dough	170 - 190	20 - 40	3
Puff pastries	190 - 210 ¹⁾	20 - 30	3
Rolls	190 - 210 ¹⁾	10 - 55	3
Small cakes (20 per tray)	170 ¹⁾	20 - 30	3 - 4

1) Preheat the oven.

Bakes and gratins table

Food	Temperature (°C)	Time (min)	Shelf position
Pasta bake	180 - 200	45 - 60	1
Lasagne	180 - 200	35 - 50	1
Vegetables au gratin	180 - 200 ¹⁾	15 - 30	1
Baguettes topped with melted cheese	200 - 220 ¹⁾	15 - 30	1
Sweet bakes	180 - 200	40 - 60	1
Fish bakes	180 - 200	40 - 60	1
Stuffed vegetables	180 - 200	40 - 60	1

1) Preheat the oven.

10.6 Roasting

- Use heat-resistant ovenware to roast. Refer to the instructions of the ovenware manufacturer.
- You can roast large roasting joints directly in the deep pan or on the wire shelf above the deep pan.
- Put some liquid in the deep pan to prevent the meat juices or fat from burning on it's surface.
- All types of meat that can be browned or have crackling can be roasted in the roasting tin without the lid.
- If necessary, turn the roast after 1/2 to 2/3 of the cooking time.
- To keep meat more succulent:
 - roast lean meat in the roasting tin with the lid or use roasting bag.
 - roast meat and fish in pieces weighting minimum 1 kg.
 - baste large roasts and poultry with their juices several times during roasting.

10.7 Conventional Roasting **Beef**

Food	Quantity	Temperature (°C)	Time (min)	Shelf position
Pot roast	1 - 1.5 kg	200 - 230	105 - 150	1
Roast beef or fillet: rare	per cm. of thickness	230 - 250 ¹⁾	6 - 8	1
Roast beef or fillet: medium	per cm. of thickness	220 - 230	8 - 10	1
Roast beef or fillet: well done	per cm. of thickness	200 - 220	10 - 12	1

1) Preheat the oven.

Pork

Food	Quantity	Temperature (°C)	Time (min)	Shelf position
Shoulder, neck, ham joint	1 - 1.5 kg	210 - 220	90 - 120	1
Chop, spare rib	1 - 1.5 kg	180 - 190	60 - 90	1
Meat loaf	750 g - 1 kg	170 - 190	50 - 60	1
Pork knuckle (pre-cooked)	750 g - 1 kg	200 - 220	90 - 120	1

Veal

Food	Quantity	Temperature (°C)	Time (min)	Shelf position
Roast veal ¹⁾	1 kg	210 - 220	90 - 120	1
Knuckle of veal	1.5 - 2 kg	200 - 220	150 - 180	1

¹⁾ Use a closed roasting dish.

Lamb

Food	Quantity	Temperature (°C)	Time (min)	Shelf position
Leg of lamb, roast lamb	1 - 1.5 kg	210 - 220	90 - 120	1
Saddle of lamb	1 - 1.5 kg	210 - 220	40 - 60	1

Game

Food	Quantity	Temperature (°C)	Time (min)	Shelf position
Saddle of hare, leg of hare	up to 1 kg	220 - 240 ¹⁾	30 - 40	1
Saddle of venison	1.5 - 2 kg	210 - 220	35 - 40	1
Haunch of venison	1.5 - 2 kg	200 - 210	90 - 120	1

¹⁾ Preheat the oven.

Poultry

Food	Quantity	Temperature (°C)	Time (min)	Shelf position
Poultry portions	200 - 250 g each	220 - 250	20 - 40	1
Half chicken	400 - 500 g each	220 - 250	35 - 50	1
Chicken, poulard	1 - 1.5 kg	220 - 250	50 - 70	1

Food	Quantity	Temperature (°C)	Time (min)	Shelf position
Duck	1.5 - 2 kg	210 - 220	80 - 100	1
Goose	3.5 - 5 kg	200 - 210	150 - 180	1
Turkey	2.5 - 3.5 kg	200 - 210	120 - 180	1
Turkey	4 - 6 kg	180 - 200	180 - 240	1

Fish

Food	Quantity	Temperature (°C)	Time (min)	Shelf position
Whole fish	1 - 1.5 kg	210 - 220	40 - 70	1

10.8 Roasting with Turbo Grilling

Beef

Food	Quantity	Temperature (°C)	Time (min)	Shelf position
Roast beef or fillet: rare	per cm. of thickness	190 - 200 ¹⁾	5 - 6	1
Roast beef or fillet: medium	per cm. of thickness	180 - 190	6 - 8	1
Roast beef or fillet: well done	per cm. of thickness	170 - 180	8 - 10	1

¹⁾ Preheat the oven.

Pork

Food	Quantity	Temperature (°C)	Time (min)	Shelf position
Shoulder, neck, ham joint	1 - 1.5 kg	160 - 180	90 - 120	1
Chop, spare rib	1 - 1.5 kg	170 - 180	60 - 90	1
Meat loaf	750 g - 1 kg	160 - 170	50 - 60	1
Pork knuckle (pre-cooked)	750 g - 1 kg	150 - 170	90 - 120	1

Veal

Food	Quantity	Temperature (°C)	Time (min)	Shelf position
Roast veal	1 kg	160 - 180	90 - 120	1
Knuckle of veal	1.5 - 2 kg	160 - 180	120 - 150	1

Lamb

Food	Quantity	Temperature (°C)	Time (min)	Shelf position
Leg of lamb, roast lamb	1 - 1.5 kg	150 - 170	100 - 120	1
Saddle of lamb	1 - 1.5 kg	160 - 180	40 - 60	1

Poultry

Food	Quantity	Temperature (°C)	Time (min)	Shelf position
Poultry portions	200 - 250 g each	200 - 220	30 - 50	1
Half chicken	400 - 500 g each	190 - 210	35 - 50	1
Chicken, poulard	1 - 1.5 kg	190 - 210	50 - 70	1
Duck	1.5 - 2 kg	180 - 200	80 - 100	1
Goose	3.5 - 5 kg	160 - 180	120 - 180	1
Turkey	2.5 - 3.5 kg	160 - 180	120 - 150	1
Turkey	4 - 6 kg	140 - 160	150 - 240	1

10.9 Grilling in general**WARNING!**

Always grill with the oven door closed.

- **Always grill with the maximum temperature setting.**
- Set the shelf into the shelf position as recommended in the grilling table.
- Always set the deep pan to collect the fat into the first shelf position.

- Grill only flat pieces of meat or fish.

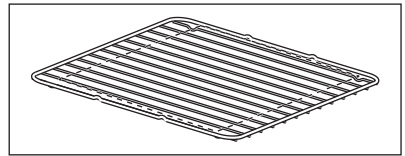

The grilling area is set in centre of the shelf.

10.10 Grilling

Food	Temperature (°C)	Time (min)		Shelf position
		1st side	2nd side	
Roast beef, medium	210 - 230	30 - 40	30 - 40	2
Filet of beef, medium	230	20 - 30	20 - 30	3
Back of pork	210 - 230	30 - 40	30 - 40	2
Back of veal	210 - 230	30 - 40	30 - 40	2
Back of lamb	210 - 230	25 - 35	20 - 35	3
Whole fish, 500 - 1000g	210 - 230	15 - 30	15 - 30	3 - 4

10.11 Preserving - Bottom heat



- Use only preserve jars of the same dimensions available on the market.
- Do not use jars with twist-off and bayonet type lids, or metal tins.
- Use the first shelf from the bottom for this function.
- Put no more than six one-litre preserve jars on the baking tray.
- Fill the jars up to the same level and close with a clamp.
- The jars cannot touch each other.
- Put approximately 1/2 litre of water into the baking tray to give sufficient moisture in the oven.
- When the liquid in the jars starts to simmer (after approx. 35 - 60 minutes with one-litre jars), stop the oven or decrease the temperature to 100 °C (see the table).

Soft fruit

Preserve	Temperature (°C)	Cooking time until simmering (min)	Continue to cook at 100 °C (min)
Strawberries, blueberries, raspberries, ripe gooseberries	160 - 170	35 - 45	-

Stone fruit

Preserve	Temperature (°C)	Cooking time until simmering (min)	Continue to cook at 100 °C (min)
Pears, quinces, plums	160 - 170	35 - 45	10 - 15

Vegetables

Preserve	Temperature (°C)	Cooking time until simmering (min)	Continue to cook at 100 °C (min)
Carrots ¹⁾	160 - 170	50 - 60	5 - 10
Cucumbers	160 - 170	50 - 60	-
Mixed pickles	160 - 170	50 - 60	5 - 10
Kohlrabi, peas, asparagus	160 - 170	50 - 60	15 - 20

¹⁾ Leave standing in oven when switched off.

10.12 Defrost

- Remove the food packaging. Put the food on a plate.
- Do not cover it with a bowl or a plate. This can extend the defrost time.
- Use the first oven shelf position. The one on the bottom.

Food	Quantity	Defrosting time (min)	Further defrosting time (min)	Comments
Chicken	1 kg	100 - 140	20 - 30	Put the chicken on an up-turned saucer in a big plate. Turn halfway through.
Meat	1 kg	100 - 140	20 - 30	Turn halfway through.
Meat	500 g	90 - 120	20 - 30	Turn halfway through.
Trout	150 g	25 - 35	10 - 15	-
Strawberries	300 g	30 - 40	10 - 20	-
Butter	250 g	30 - 40	10 - 15	-
Cream	2 x 200 g	80 - 100	10 - 15	Whip the cream when still slightly frozen in places.
Cake	1.4 kg	60	60	-

11. OVEN - CARE AND CLEANING



WARNING!

Refer to Safety chapters.

11.1 Notes on cleaning

- Clean the front of the appliance with a soft cloth with warm water and a cleaning agent.
- To clean metal surfaces, use a dedicated cleaning agent.
- Clean the appliance interior after each use. Fat accumulation or other food remains may result in a fire. The risk is higher for the grill pan.
- Clean stubborn dirt with a special oven cleaner.
- Clean all accessories after each use and let them dry. Use a soft cloth with warm water and a cleaning agent.
- If you have nonstick accessories, do not clean them using aggressive agents, sharp-edged objects or a dishwasher. It can cause damage to the nonstick coating.

11.2 Stainless steel or aluminium appliances



Clean the oven door with a damp cloth or sponge only. Dry it with a soft cloth. Do not use steel wool, acids or abrasive materials as they can damage the oven surface. Clean the oven control panel with the same precautions.

11.3 Removing the shelf supports

To clean the oven, remove the shelf supports.

1. Pull the front of the shelf support away from the side wall.

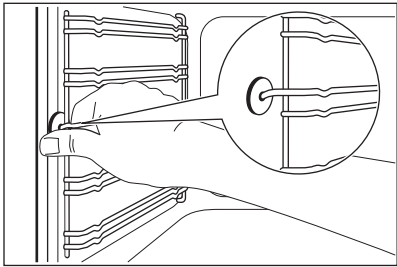

2. Pull the rear end of the shelf support away from the side wall and remove it.

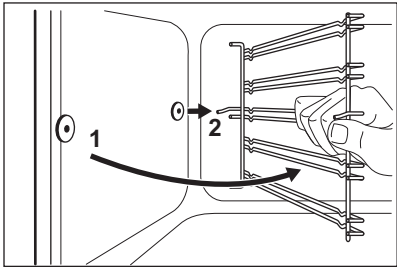

Install the shelf supports in the opposite sequence.



CAUTION!

Make sure that the longer fixing wire is in the front. The ends of the two wires must point to the rear. Incorrect installation can cause damage to the enamel.

11.4 Removing the oven door

To make the cleaning easier, remove the door.

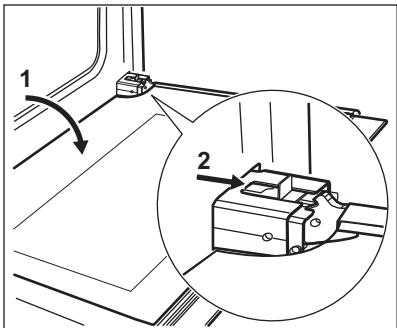

1. Open the door fully.
2. Move the slider until you hear a click.

3. Close the door until the slider locks.
4. Remove the door.
To remove the door, pull the door outwards first from one side, and then the other.

When the cleaning procedure is completed, insert the oven door in the opposite sequence. Make sure that you hear a click when you insert the door. Use force if necessary.

11.5 Removing and cleaning the door glasses



The door glass in your product can be different in type and shape from the examples you see in the images. The number of glasses can also be different.

1. Hold the door trim B on the top edge of the door at the two sides and push inwards to release the clip seal.

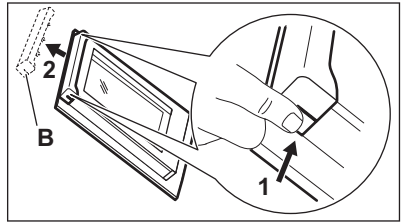

2. Pull the door trim to the front to remove it.
3. Hold the door glass panels on their top edge one by one and pull them upwards from the guide.

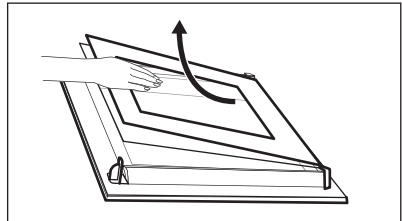

4. Clean the door glass panels.
To install panels, do the same steps in reverse.

11.6 Replacing the lamp

Put a cloth on the bottom of the interior of the appliance. It prevents damage to the lamp glass cover and the cavity.



WARNING!

Danger of electrocution!
Disconnect the fuse before you replace the lamp.
The lamp and the lamp glass cover can be hot.

1. Deactivate the appliance.
2. Remove the fuses from the fuse box or deactivate the circuit breaker.

The back lamp



The lamp glass cover is at the back of the cavity.

1. Turn the lamp glass cover counterclockwise to remove it.
2. Clean the glass cover.
3. Replace the oven lamp with a suitable 300 °C heat-resistant oven lamp.
Use the same oven lamp type.
4. Install the glass cover.

11.7 Removing the drawer



WARNING!

When the oven is in use, heat can build up in the drawer. Do not keep flammable things in there (e.g. cleaning materials, plastic bags, oven gloves, paper, cleaning sprays, etc.).

The drawer below the oven can be removed for cleaning.

1. Pull the drawer out until it stops.

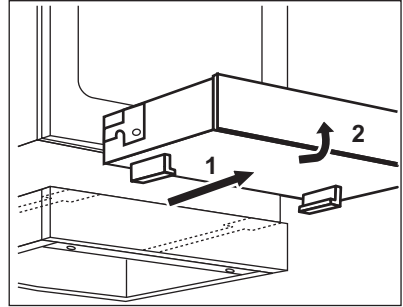

2. Lift the drawer at a small angle and remove it from the drawer support rails.

Inserting the drawer:

1. To insert the drawer set the drawer on the support rails. Make sure that the catches engage correctly into the rails
2. Lower the drawer until it is horizontal and push it in.

12. TROUBLESHOOTING



WARNING!

Refer to Safety chapters.

12.1 What to do if...

Problem	Possible cause	Remedy
You cannot activate the appliance.	The appliance is not connected to an electrical supply or it is connected incorrectly.	Check if the appliance is correctly connected to the electrical supply.
You cannot activate the appliance.	The fuse is blown.	Make sure that the fuse is the cause of the malfunction. If the fuse is blown again and again, contact a qualified electrician.
Residual heat indicator does not come on.	The zone is not hot because it operated only for a short time.	If the zone operated sufficiently long to be hot, speak to an Authorised Service Centre.
The oven does not heat up.	The oven is deactivated.	Activate the oven.
The oven does not heat up.	The clock is not set.	Set the clock.
The oven does not heat up.	The necessary settings are not set.	Make sure that the settings are correct.
The lamp does not operate.	The lamp is defective.	Replace the lamp.
The display shows "12.00".	There was a power cut.	Reset the clock.
Steam and condensation settle on the food and in the cavity of the oven.	You left the dish in the oven for too long.	Do not leave the dishes in the oven for longer than 15 - 20 minutes after the cooking process ends.

12.2 Service data

If you cannot find a solution to the problem yourself, contact your dealer or an Authorised Service Centre.

The necessary data for the service centre is on the rating plate. The rating

plate is on the front frame of the appliance cavity. Do not remove the rating plate from the appliance cavity.

We recommend that you write the data here:	
Model (MOD.)
Product number (PNC)
Serial number (S.N.)

13. INSTALLATION



WARNING!
Refer to Safety chapters.

13.1 Technical data

Dimensions	
Height	847 - 867 mm
Width	596 mm
Depth	600 mm

13.2 Location of the appliance

You can install your freestanding appliance with cabinets on one or two sides and in the corner.

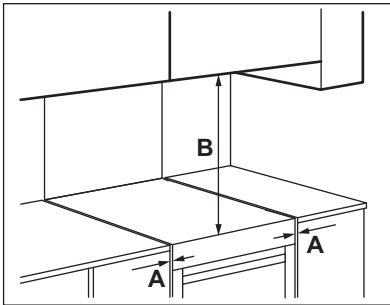

Minimum distances

Dimension	mm
A	2
B	685

13.3 Levelling of the appliance

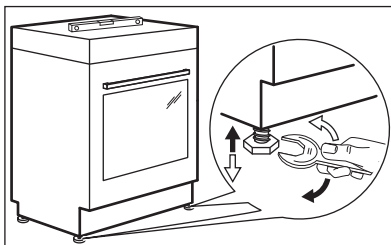

Use small feet on the bottom of appliance to set the appliance top surface level with other surfaces.

13.4 Anti-tilt protection



CAUTION!
Install the anti-tilt protection to prevent the appliance from falling under incorrect loads. The anti-tilt protection only works when the appliance is put in a correct area.

Your appliance has the symbols shown on the pictures (if applicable) to remind you about the installation of the anti-tilt protection.

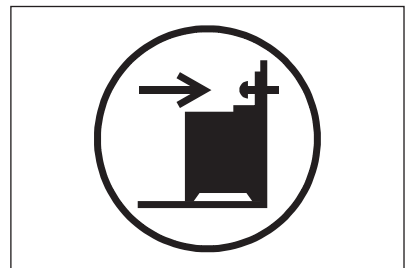

CAUTION!
Make sure you install the anti-tilt protection at the correct height.

Make sure that the surface behind the appliance is smooth.

1. Set the correct height and area for the appliance before you attach the anti-tilt protection.
2. Install the anti-tilt protection 77 mm down from the top surface of the appliance and 49 mm from the left side of the appliance into the circular hole on the bracket. See the illustration. Screw it into the solid material or use applicable reinforcement (wall).
3. You can find the hole on the left side at the back of the appliance. See the illustration. Lift the front of the appliance (1) and put it in the middle of the space between the cupboards (2). If the space between the bench cupboards is larger than the width of the appliance, you must adjust the side measurement to centre the appliance.

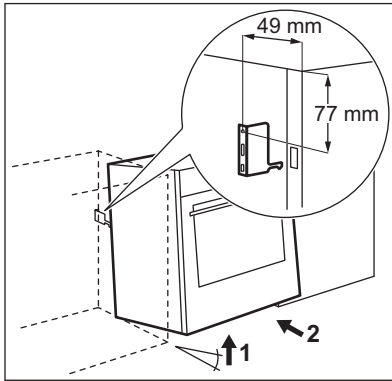

13.5 Electrical installation



WARNING!

The manufacturer is not responsible if you do not follow the safety precautions from Safety chapters.

This appliance is supplied without a main plug or a main cable.

Applicable types of cables for different phases:

Phase	Min. size cable
1	3x6.0 mm ²
3 with neutral	5x1.5 mm ²



WARNING!

The power cable must not touch the part of the appliance shaded in the illustration.

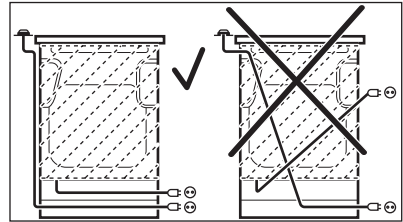

14. ENERGY EFFICIENCY

14.1 Product information for hob according to EU 66/2014

Model identification	EKC6430AOW EKC6430AOX	
Type of hob	Hob inside Freestanding Cooker	
Number of cooking zones	4	
Heating technology	Radiant Heater	
Diameter of circular cooking zones (Ø)	Left front	21.0 cm
	Left rear	14.5 cm
	Right front	14.5 cm
	Right rear	18.0 cm

Energy consumption per cooking zone (EC electric cooking)	Left front	182.3 Wh/kg
	Left rear	181.8 Wh/kg
	Right front	181.8 Wh/kg
	Right rear	182.1 Wh/kg
Energy consumption of the hob (EC electric hob)		182.0 Wh/kg

EN 60350-2 - Household electric cooking appliances - Part 2: Hobs - Methods for measuring performance.

14.2 Hob - Energy saving

You can save energy during everyday cooking if you follow below hints.

- When you heat up water, use only the amount you need.
- If it is possible, always put the lids on the cookware.
- Before you activate the cooking zone put the cookware on it.
- The cookware bottom should have the same diameter as the cooking zone.
- Put the smaller cookware on the smaller cooking zones.
- Put the cookware directly in the centre of the cooking zone.
- Use the residual heat to keep the food warm or to melt it.

14.3 Product Fiche and information for ovens according to EU 65-66/2014

Supplier's name	Electrolux	
Model identification	EKC6430AOW EKC6430AOX	
Energy Efficiency Index	100.0	
Energy efficiency class	A	
Energy consumption with a standard load, conventional mode	0.95 kWh/cycle	
Energy consumption with a standard load, fan-forced mode	0.85 kWh/cycle	
Number of cavities	1	
Heat source	Electricity	
Volume	72 l	
Type of oven	Oven inside Freestanding Cooker	
Mass	EKC6430AOW	45.7 kg
	EKC6430AOX	48.9 kg

EN 60350-1 - Household electric cooking appliances - Part 1: Ranges, ovens, steam ovens and grills - Methods for measuring performance.

14.4 Oven - Energy saving



The appliance contains features which help you save energy during everyday cooking.

General hints

Make sure that the oven door is closed properly when the appliance operates and keep it closed as much as possible during the cooking.

Use metal dishes to improve energy saving.

When possible, do not preheat the oven before you put the food inside.

When the cooking duration is longer than 30 minutes, reduce the oven temperature

to minimum 3 - 10 minutes before the end of the cooking time, depending on the duration of the cooking. The residual heat inside the oven will continue to cook.

Use the residual heat to warm up other dishes.

Cooking with fan

When possible, use the cooking functions with fan to save energy.

Keep food warm

Choose the lowest possible temperature setting to use residual heat and keep a meal warm.

15. ENVIRONMENTAL CONCERNS

Recycle the materials with the symbol . Put the packaging in applicable containers to recycle it. Help protect the environment and human health and to recycle waste of electrical and electronic appliances. Do not dispose appliances

marked with the symbol  with the household waste. Return the product to your local recycling facility or contact your municipal office.

www.electrolux.com/shop



867319973-B-032017



Free Manuals Download Website

<http://myh66.com>

<http://usermanuals.us>

<http://www.somanuals.com>

<http://www.4manuals.cc>

<http://www.manual-lib.com>

<http://www.404manual.com>

<http://www.luxmanual.com>

<http://aubethermostatmanual.com>

Golf course search by state

<http://golfingnear.com>

Email search by domain

<http://emailbydomain.com>

Auto manuals search

<http://auto.somanuals.com>

TV manuals search

<http://tv.somanuals.com>