

KODAK EASYSHARE Z915 Digital Camera

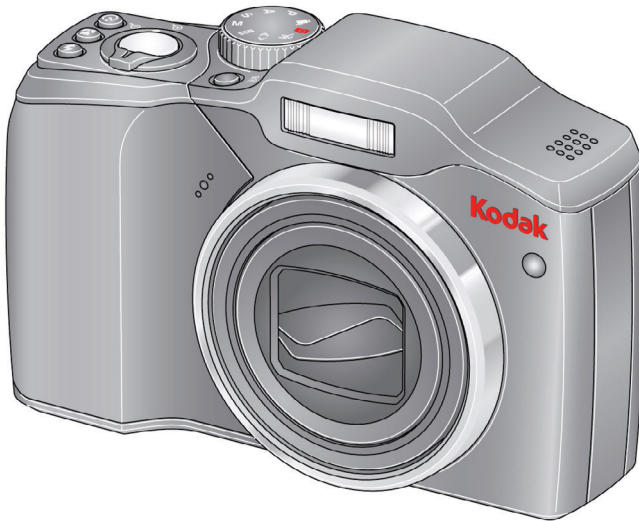

Extended user guide

www.kodak.com

For interactive tutorials, visit www.kodak.com/go/howto

For help with your camera, visit www.kodak.com/go/z915support

Kodak

Eastman Kodak Company

Rochester, NY 14650

© Kodak, 2009

All screen images are simulated.

Kodak, EasyShare, and Perfect Touch are trademarks of Eastman Kodak Company.

P/N 4H5245_en

Back view

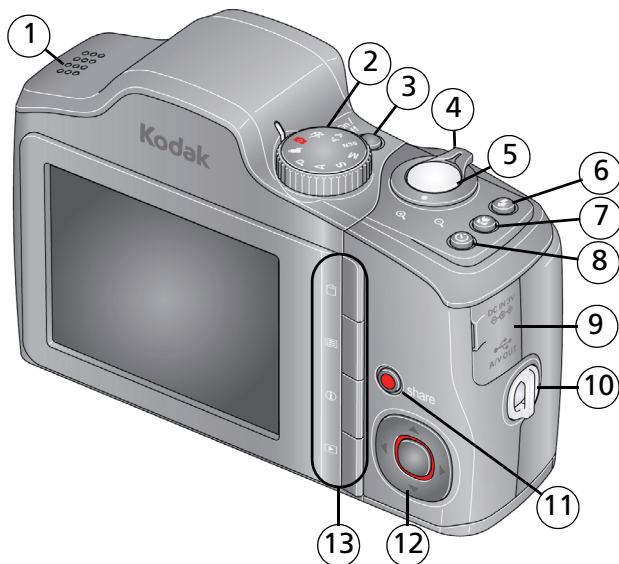

- | | | | |
|---|---------------------------------|----|---------------------------------|
| 1 | Speaker | 8 | Self-timer/Burst button |
| 2 | Mode dial | 9 | 3V DC-In/USB/AV out |
| 3 | On/Off button | 10 | Strap post |
| 4 | Zoom Wide Angle/Telephoto lever | 11 | Share button |
| 5 | Shutter button | 12 | ◀/▶ ▲/▼, OK |
| 6 | Flash button | 13 | Delete/Menu/Info/Review buttons |
| 7 | Focus (Macro/Infinity) button | | |

For batteries, [see page 1](#).

For SD/SDHC cards, [see page 3](#).

Front view

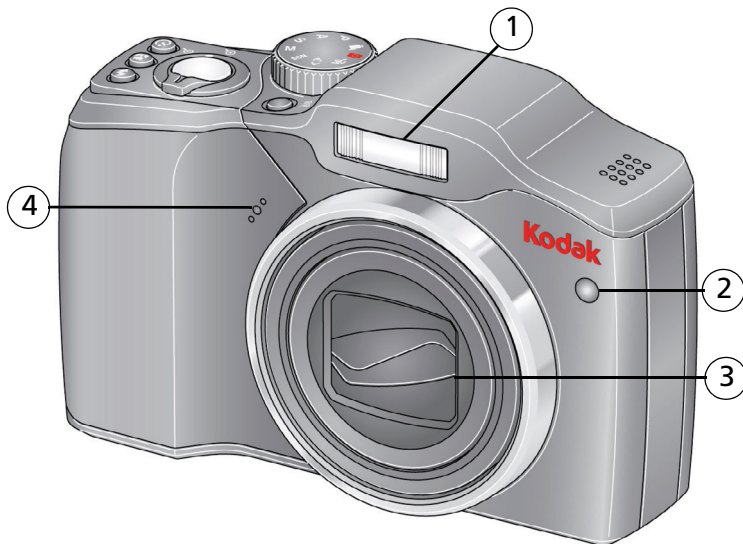

- 1 Flash
- 2 Self-timer/Video/AF Assist light
- 3 Lens/Cover
- 4 Microphone

Table of contents

1	Setting up your camera	1
	Attaching the strap	1
	Loading the batteries	1
	Turning on the camera	2
	Setting the language, date/time.....	2
	Storing pictures on an (accessory) SD or SDHC Card.....	3
2	Taking pictures/videos	4
	Taking a picture	4
	Taking a video	5
	Capture modes	6
	Using optical zoom	8
	Using the flash.....	9
	Using the Focus button	10
	Using the self-timer.....	11
	Using burst	11
	Taking panoramic pictures.....	12
	Getting help from your camera	13
	P, A, S, and M modes.....	14
	Using exposure compensation to adjust brightness	16
	Using the histogram to view picture brightness.....	17
	Understanding the picture-taking icons.....	17
3	Working with pictures/videos	18
	Reviewing pictures/videos	18
	Deleting pictures/videos	19
	Using shortcuts	21
	Using the menu button in Review.....	21
	Adding sound tags.....	22
	Cropping pictures.....	23
	Using KODAK PERFECT TOUCH Technology.....	24

Editing videos	25
Play a multimedia slide show.....	28
Displaying pictures/videos on a television.....	29
Viewing pictures/videos in different ways.....	30
Selecting multiple pictures/videos	30
Copying pictures/videos.....	31
Understanding the review icons.....	31
4 Using the menu button	32
Using the Setup menu	35
5 Transferring, printing, and sharing pictures	38
Installing the software.....	38
Transferring pictures with the USB cable.....	39
Printing pictures	40
Marking your pictures	42
6 Troubleshooting	46
7 Getting help	51
Helpful links.....	51
8 Appendix	53
Camera specifications	53
Storage capacities	55
Important safety instructions	56
Upgrading your software and firmware.....	57
Battery life	57
Care and maintenance	58
Limited warranty.....	58
Regulatory compliance	60

1

Setting up your camera

Attaching the strap

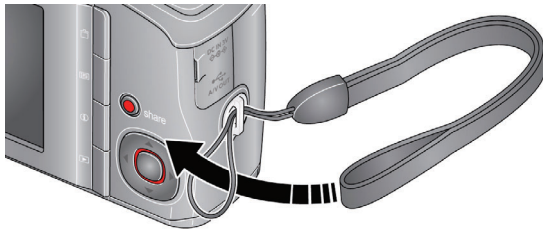

Loading the batteries

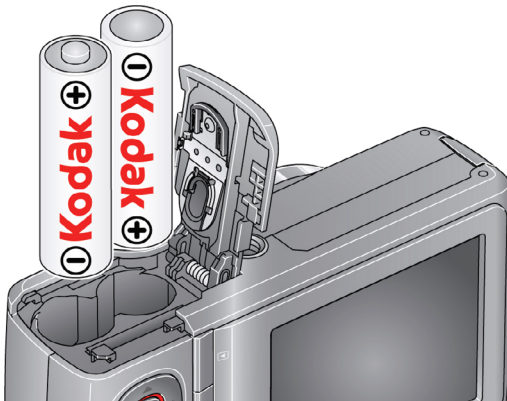

Other battery types

[see page 57](#)

Purchase accessories, such as batteries, battery chargers, SDHC cards, etc.

www.kodak.com/go/z915accessories

Turning on the camera

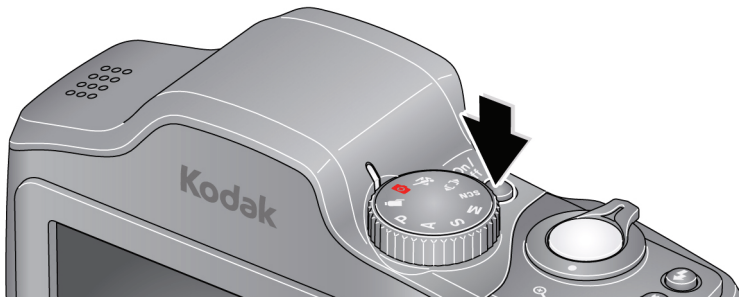

Setting the language, date/time

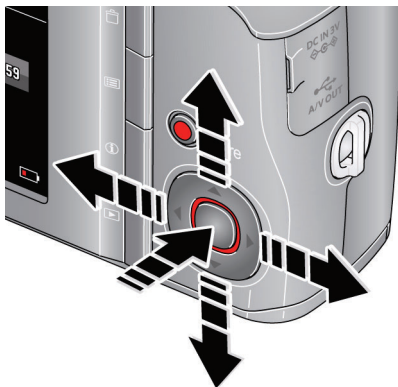

Language:

▲/▼ to change.
OK to accept.

Date/Time:

At the prompt, press OK.
▲/▼ to change current field.
◀/▶ for previous/next field.
OK to accept.

NOTE: To change language or date/time in the future, use the Setup  menu (see page 37).

Storing pictures on an (accessory) SD or SDHC Card

Your camera has internal memory. You can purchase an SD or SDHC Card to store more pictures and videos. (Maximum supported card size is 32 GB.)



CAUTION:

A card can only be inserted one way; forcing it may cause damage. Inserting or removing a card when the camera is on may damage the pictures, the card, or the camera.

- ① Turn off the camera.
- ② Insert or remove the optional card.
- ③ Turn on the camera.





Purchase accessories www.kodak.com/go/z915accessories

2

Taking pictures/videos

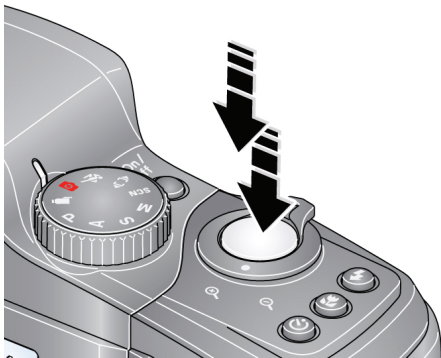
Taking a picture



- 1 Turn the Mode dial to Smart Capture .
- 2 Press the Shutter button halfway to lock on the subject. When the framing marks turn green, press the Shutter button completely down.

NOTE: For more information on Smart Capture and other modes, [see page 6](#). Framing marks do not appear in some SCN (scene) and Video modes.

Using the framing marks

Framing marks





Framing marks indicate the camera focus area.

- 1 Press the Shutter button **halfway**.
If the camera is not focusing on the desired subject, release the Shutter button and recompose the scene.
- 2 Press the Shutter button **completely down** to take the picture.

NOTE: Framing marks do not appear in all modes. Multiple framing marks may appear when faces are detected.

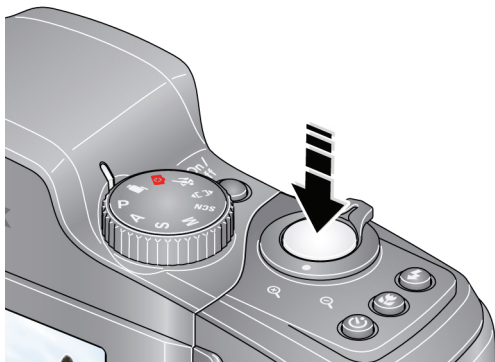
Taking a video



- ① Turn the Mode dial to Video .
- ② Press the Shutter button completely down and release. (To stop recording, press and release again.)

Reviewing the picture/video just taken

After you take a picture/video, the LCD displays a quickview for several seconds. (To dismiss the quickview sooner, press the Shutter button halfway.) The picture/video is saved unless you press the Delete  button.

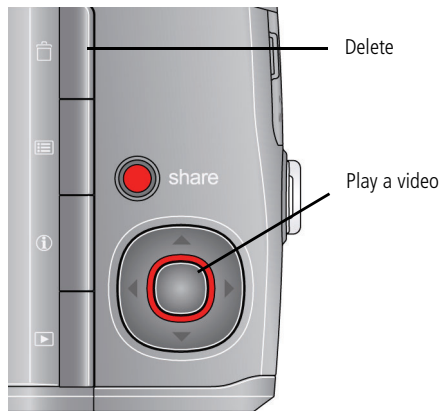



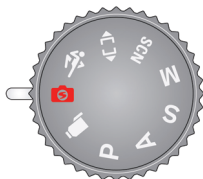

To review pictures/videos anytime, see [page 18](#).

Capture modes



Choose the mode that best suits your subjects and surroundings.

Capture mode	For
 Smart Capture	General picture taking—it offers excellent image quality and ease of use. <ul style="list-style-type: none"> ■ Faces are detected. ■ The scene is analyzed for other content and for lighting. ■ KODAK PERFECT TOUCH Technology is applied, for better pictures. You can choose the best picture size and aspect ratio for your needs—just press the Menu  button and choose Picture Size. <ul style="list-style-type: none"> ■ 3:2 (the best choice when making 4 x 6 prints) ■ 16:9 (wide screen) ■ 4:3 (the default setting)
 Sport	Subjects that are in motion. Shutter speed is fast.
 Panorama	“Stitching” 2 or 3 pictures into 1 panoramic scene. (See page 12.)
SCN Scene	Point-and-shoot simplicity when taking pictures under special conditions.
P Program A Aperture S Shutter M Manual	More creative control. (See page 14.)
 Video	Video with sound. (See page 5.)

Scene modes

1 Turn the Mode dial to Scene **SCN**.

2 Press **◀/▶** **▲/▼** to highlight Scene modes.

NOTE: If the mode description turns off before you finish reading it, press OK.

3 Press OK to choose a Scene mode.

SCN mode	For
Portrait	Full-frame portraits of people.
Children	Action pictures of children in bright light.
Backlight	Subjects that are in shadow or "backlit" (when light is behind the subject).
High ISO	People indoors, in low-light scenes.
Beach	Bright beach scenes.
Snow	Bright snow scenes.
Sunset	Capturing the deep hues seen at sunset.
Self-Portrait	Close-ups of yourself. Assures proper focus and minimizes red eye.
Night Portrait	Reducing red eye of people in night scenes or low-light conditions. Place the camera on a flat, steady surface or use a tripod.
Candle light	Capturing the ambiance of candle light.
Night Landscape	Distant scenery at night. Flash does not fire. Place the camera on a flat, steady surface or use a tripod.
Landscape	Far-away scenes. The camera uses infinity auto-focus. Framing marks are not available in Landscape.
Manner/Museum	Quiet occasions, like a wedding or lecture. Flash is off.
Stage	People on a lit stage. Fast shutter speed, high ISO. Flash and sounds are off. (Flash setting can be changed.)
Fireworks	Bright, colorful light displays. Flash does not fire. Place the camera on a flat, steady surface or use a tripod.

SCN mode	For
----------	-----

Flower	Close-ups of flowers or other small subjects in bright light. Focus is Macro.
--------	---

Text	Documents. Focus is Macro.
------	----------------------------

Using optical zoom

Use optical zoom to get up to 10X closer to your subject while taking pictures/videos.

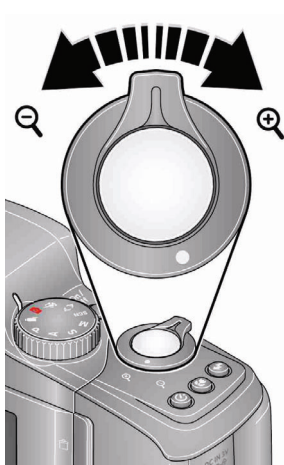

- 1 Use the LCD to frame your subject. For focus distances, see [Camera specifications, page 53](#).
- 2 Press Telephoto (T) to zoom in. Press Wide Angle (W) to zoom out.
- 3 Take the picture or video.

NOTE: To get a focused picture every time, remember:

- Use the framing marks, [page 4](#).
- As you zoom in, move away from your subject.

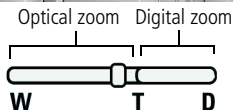

Use digital zoom to get up to 5X beyond optical zoom while taking pictures. Turn digital zoom on/off using the Setup  menu (see [page 35](#)). Digital zoom is not available in Smart Capture mode.

NOTE: You may notice decreased image quality when using digital zoom. The slider on the LCD turns red when the picture quality reaches the limit for an acceptable 4 x 6-in. (10 x 15 cm) print.

Using the flash

Use the flash when you take pictures at night, indoors, or outdoors in heavy shadows. Flash settings are limited in some capture modes.

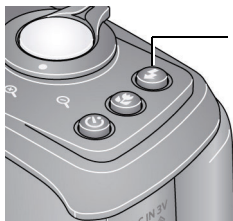

Press the Flash button repeatedly to scroll through flash modes. The current flash mode is shown on the LCD.

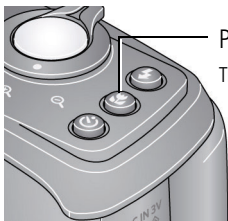

Flash modes		Flash fires
Auto		When the lighting conditions require it.
Fill		Every time you take a picture, regardless of the lighting conditions. Use when the subject is in shadow or is "backlit" (when the light is behind the subject). In low light, hold the camera steady or use a tripod. NOTE: (Not available in Smart Capture mode.)
Red-eye Reduction Choose Preflash or Digital Correction using the Setup menu (see page 35).	Preflash 	A preflash fires, shrinking the eye pupil, before the picture is taken.
	Digital Correction 	A preflash does not fire; the camera corrects red eye.
Off		Never.

Using the Focus button



Press the Focus button repeatedly to scroll through focus modes. The current Focus mode is shown on the LCD.

- 1 In most Still modes, press the Focus button until the desired focus icon is displayed on the LCD:

Mode	Icon	For
Auto Focus (AF)	No icon.	Normal picture taking.
Infinity		Distant scenery, or for taking pictures through a window.
Macro		Subjects that are 12–60 cm (4.7–23.6 in.) from the lens.

- 2 Press the Shutter button **halfway** to focus and set exposure, then **completely down** to take the picture.

Using the self-timer



Use the self-timer when you want to be included in a picture, or to ensure a steady Shutter button press. Place the camera on a tripod or flat surface.

- 1 Repeatedly press the Self-timer/Burst  button to choose a setting:
 - 10 seconds**—A picture is taken after a 10-second delay (so you have time to get into the scene).
 - 2 seconds**—A picture is taken after a 2-second delay (for a steady, shutter release on a tripod).
 - 2 shot**—The first picture is taken after a 10-second delay. A second picture is taken 8 seconds later.
 - 2 Compose the scene. Press the Shutter button **halfway**, then **completely down**.
The camera takes the picture/pictures after the delay.
- Use the same procedure to take a 2- or 10-second self-timer video, but press the Shutter button **completely down**.

Using burst

Use the Burst feature to take up to 3 pictures in quick succession.

NOTE: Burst is unavailable in Portrait, Night Portrait, Night Landscape, Backlight, Fireworks, and Panorama modes.

- 1 Repeatedly press the Self-timer/Burst button  until the Burst  icon appears on the LCD.
- 2 Press the Shutter button **halfway** to focus and set exposure.
- 3 Press the Shutter button **completely down and hold it** to take pictures.
The camera takes up to 3 pictures while the Shutter button is pressed.



NOTE: During quickview, you can delete all pictures in the burst series. To delete selectively, do so in Review (see [page 19](#)).

Taking panoramic pictures

Use panorama to “stitch” up to 3 pictures into a panoramic scene.

NOTE: For best results, use a tripod. Individual pictures are not saved, even if panorama capture is cancelled before stitching occurs. (Exposure Compensation, White Balance, Exposure Metering, AF Zone, AF Control, Color Mode, and Sharpness are set with the first picture. The flash is set to Off.)

You can use the self-timer (2- and 10-second delays) while taking panoramic pictures. [See page 11.](#)

- 1 Turn the Mode dial to Panorama .
- 2 Press   to highlight Panorama Left-Right or Panorama Right-Left (depending on the direction you want to pan), then press OK.
- 3 Take the first picture.

After a quickview, the LCD displays the liveview and an “overlay” from the first picture.

- 4 Compose the second picture. Make the overlay from the first picture cover the same portion in the new picture.
- 5 If you are taking only 2 pictures, press OK to stitch them together.

After you take 3 pictures, the pictures are automatically stitched together.

Take 2 or 3 pictures.



Get 1 panoramic picture.



Getting help from your camera

You want the most from your camera. You want to understand:

- What it can do for you
- And how to take the best possible pictures and videos

Great news!

Your camera offers a built-in Help system. It describes every setting for every menu choice. If you learn nothing else about your camera, learn how to use on-camera Help. Because the more you know your camera, the more confident you become!

Turning on camera Help







① Press the Menu button, then highlight a menu choice.

② Press the Info **i** button.

▲/▼ Scroll through a Help topic

P, A, S, and M modes





Use these modes when you want more control over your camera and pictures.

Mode	When to use	Press    
P	Program mode offers the ease of auto shooting with full access to all menu options. The camera automatically sets the shutter speed and aperture (f-stop) based on the scene lighting.	Exposure compensation (how much light enters the camera), flash compensation, and ISO speed
A	Aperture Priority mode controls depth of field (the range of sharpness). The aperture setting may be affected by optical zoom.	Aperture, exposure compensation, flash compensation, and ISO speed
S	Shutter Priority mode prevents blur when your subject is moving. The camera automatically sets the aperture for proper exposure. (To prevent blur, use a tripod for slow shutter speeds.)	Shutter speed and flash compensation
M	Manual mode offers the highest level of creative control. (To prevent blur, use a tripod for slow shutter speeds.)	Aperture, shutter speed, flash compensation, and ISO speed

NOTE: Settings you change in P, A, S, or M modes apply only to pictures taken in those modes. The settings, including Flash, are maintained for P, A, S, and M modes—even when you change modes or turn off the camera. Use Reset Camera ([see page 37](#)) to reset P, A, S, or M mode to its default setting.

Changing P, A, S, or M mode settings

PASM modes control the aperture (f-number, also known as f-stop), shutter speed, exposure compensation, flash compensation, and ISO. Use the Menu  button to control all other settings.

- 1 Turn the Mode dial to P, A, S, or M.
- 2 Press   to access a setting. Press  /  to change the setting.

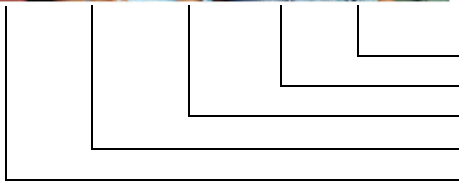
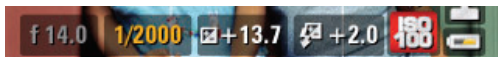

NOTE: A yellow setting indicates possible unsatisfactory results. (However, you can still take the picture.)

ISO
Flash compensation
Exposure compensation
Shutter speed
Aperture

ISO—adjust the camera’s sensitivity to light. Higher ISO indicates greater sensitivity.

NOTE: A higher ISO may produce unwanted “noise” in a picture.

Flash Compensation—adjust flash brightness.

Exposure Compensation—adjust the exposure. If the scene is too light, decrease the setting; if it’s too dark, increase the setting.





Shutter speed—control how long the shutter stays open. (Use a tripod for slow shutter speeds.)

Aperture—(also known as f-stop) control the size of the lens opening, which determines the depth of field.

- Smaller f-stop numbers indicate a larger lens opening; good for low-light.
- Larger f-stop numbers indicate a smaller lens opening; keeps the main subject sharp; good for landscapes and well-lit conditions.

Using exposure compensation to adjust brightness

In P, A, S, and Panorama modes, you can adjust exposure compensation before you take a picture to make your pictures darker or lighter. Only the first picture in Panorama mode can be adjusted—that adjustment is applied to the remaining pictures.

- Press /  to access the exposure compensation setting.
- Press  to decrease or  to increase exposure compensation.

An exposure compensation level is shown on the LCD and the image gets darker or lighter.

Take the picture when you are satisfied with the exposure compensation level.

Using exposure compensation with exposure bracketing

In P and A modes, you can use exposure compensation in conjunction with exposure bracketing to get the best exposure.

If the exposure compensation is set to:	And if the exposure bracketing interval is set to 0.3 steps:	Then the exposures taken are:
0.0	Set the Exposure Bracketing Interval in the Capture+ menu (see page 35).	-0.3, 0.0, +0.3
+1.0		+0.7, +1.0, +1.3
-1.0		-1.3, -1.0, -0.7

Using the histogram to view picture brightness

Use the histogram to evaluate the distribution of light before or after you take a picture. Optimal exposure is achieved when the peak is in the middle of the histogram. The flash may affect a picture's light and shadow.

To turn on the histogram in Capture mode or in Review, press the Info **i** button until the histogram appears.

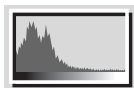

Dark picture

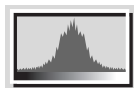

Balanced picture

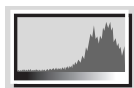

Bright picture

Understanding the picture-taking icons

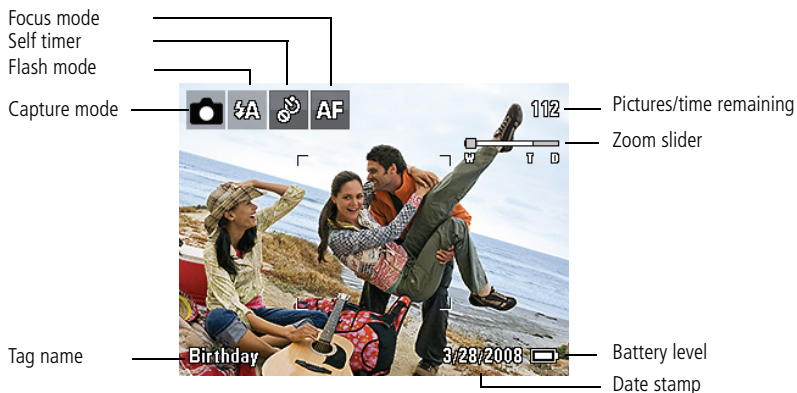



3

Working with pictures/videos

Reviewing pictures/videos





Press the Review  button to view and work with your pictures/videos. Press Review again to exit.

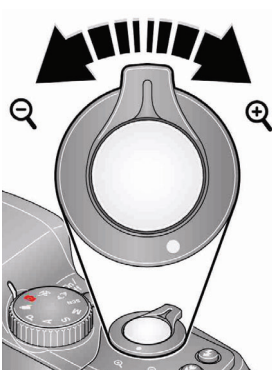

- 1 Press the Review  button.
- 2 Press   for previous/next picture/video.
 - Press the Review button to return to Capture mode.
 - To view pictures/videos as thumbnails, see [page 30](#).







Magnifying a picture during review

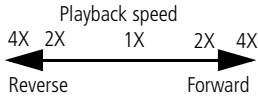

- 1 Press + to magnify 1X–8X.
- 2 Press     to view other parts of a picture.
 - Press OK to return to 1X.

Playing a video



- 1 Press the Review  button.
- 2 Press  to locate previous/next video.
- 3 Press OK to play a video.
 - Press  during playback to adjust the volume.
 - Press OK to pause/resume. (Press  during pause to go to previous/next frame.)
 - Press  during playback to play at 2X speed; press again for 4X. Press  during 4X to jump to a bookmark. (See [page 26](#).)
 - Press  during playback to reverse at 2X speed; press again for 4X.

Deleting pictures/videos

- 1 Press the Review  button.
- 2 Press  to find a picture/video.
- 3 Press the Delete  button.
- 4 Follow the screen prompts.

Using the undo delete feature

If you accidentally delete a picture/video, you may be able to use Undo Delete to retrieve it. This feature is only available immediately after you delete a single picture/video while in Review (not during a Quickview).

Protecting pictures/videos from deletion

1 Press the Review  button, then  to find a picture.

2 Press the Menu  button.

3 Press  to highlight Protect, then press OK.

The Protect icon  appears with the protected picture/video.

- Press the Menu button to exit the menu.



CAUTION:

Formatting internal memory or an SD or SDHC Card deletes all (including protected) pictures/videos. (Formatting internal memory also deletes email addresses, tag names, and favorites.)

IMPORTANT: *Your camera offers a built-in Help system. See [page 13](#).*

Using shortcuts

For quick access to the most popular functions:

- 1 Press the Info **i** button.

The shortcuts appear.

- 2 Press ◀/▶ to access functions like Select Picture, Add Text Tag, and View Multi-up.
- 3 Press ▲/▼ to choose a setting.

To hide the shortcuts again, press **i**.



Using the menu button in Review

- 1 Press the Review **▶** button, then the Menu **☰** button.
- 2 Press ◀/▶ to choose a tab:
 - **Review** to view pictures/videos
 - **Edit** to edit pictures/videos
 - **Setup** for other camera settings

NOTE: You may need to scroll up to highlight the current tab before you can choose another tab.

- 3 Press ▲/▼ to highlight a setting, then press OK.
- 4 Choose an option, then press OK.







IMPORTANT: *Your camera offers a built-in Help system. See page 13.*

Adding sound tags

You can record a voice or sound (up to 1 minute long) to add to a picture.

NOTE: Only one sound tag can be added to each picture (not to videos).

Recording a sound tag

- 1 Press the Review  button, then  to find a picture.
- 2 Press the Menu  button, then  to highlight the Edit  tab.
- 3 Press  to highlight Sound Tag, then press OK.
- 4 Follow the screen prompts.

The sound tag is applied to your picture.





- Press the Menu button to exit the menu.

IMPORTANT: Your camera offers a built-in Help system. See [page 13](#).

Playing a sound tag









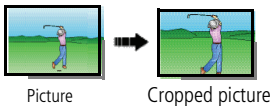

Review

- 1 Press the Review  button, then  to find a picture with a "Play Sound Tag" prompt.
- 2 Press  to play the sound tag.
- 3 Press  to adjust the volume.
 - Press OK to stop playback.

Cropping pictures

You can crop a picture so that only the desired portion of the picture remains. (You cannot crop these pictures: panoramic, 16:9, video action prints, pictures from a video, or pictures that are already cropped.)









- 1 Press the Review  button, then  to find a picture.
- 2 Press the Menu  button, then  to highlight the Edit  tab.
- 3 Press  to highlight Crop, then press OK.
- 4 Press the Zoom lever (T/W) to zoom in/out. Press   to move the crop box. Then press OK.
- 5 Follow the screen prompts.
The picture is cropped, the original saved. (Cropped pictures cannot be cropped again.)
 - Press the Menu button to exit the menu.

IMPORTANT: *Your camera offers a built-in Help system. See page 13.*

Using KODAK PERFECT TOUCH Technology

KODAK PERFECT TOUCH Technology helps ensure better, brighter pictures. PERFECT TOUCH Technology is automatically applied to pictures taken in Smart Capture mode. (You cannot enhance videos, panoramic pictures, or pictures that are already enhanced.)

- 1 Press the Review  button, then  to find a picture.
 - 2 Press the Menu  button, then  to highlight the Edit  tab.
 - 3 Press  to highlight Perfect Touch tech, then press OK.
A preview is shown in a split screen. Press  to view other parts of the picture.
 - 4 Press OK. Follow the screen prompts to replace the original picture or to save the enhanced picture as a new one.
- Press the Menu button to exit the menu.





IMPORTANT: *Your camera offers a built-in Help system. See page 13.*

Editing videos

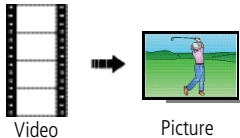
Making a picture from a video

You can choose a single frame from a video, then make a picture suitable for printing.



- 1 Press the Review  button, then  to find a video.
- 2 Press the Menu  button, then  to highlight the Edit  tab.

3 Press  to highlight Make Picture, then press OK.

4 Press OK to play the video. (Press OK to pause). Press  to navigate through video frames.

5 During play or pause, press  to make a picture.

A picture is created. (The original video is saved.)





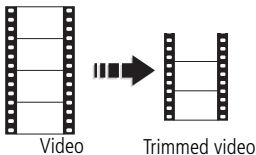

■ Press the Menu button to exit the menu.

IMPORTANT: *Your camera offers a built-in Help system. See page 13.*

Trimming a video

You can delete an unwanted portion from the beginning or end of a video.



- 1 Press the Review  button, then  to find a video.
- 2 Press the Menu  button, then  to highlight the Edit  tab.
- 3 Press  to highlight Trim, then press OK.

4 Follow the screen prompts.

The video is trimmed. (You can save it as a new video or replace the original.)







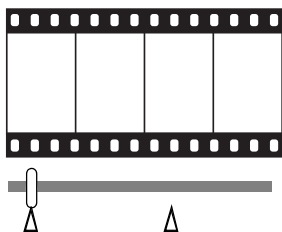

■ Press the Menu button to exit the menu.

Using video bookmarks

You can set bookmarks at interesting places in your video, then jump from one bookmark to another.

Setting bookmarks





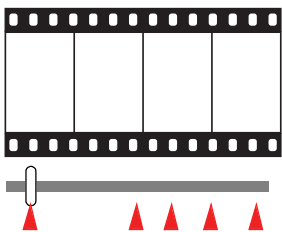

- 1 Press the Review  button, then  to find a video.
- 2 Press the Menu  button, then  to highlight the Edit  tab. Highlight Bookmark, then press OK.
- 3 Press  to highlight Create/Edit, then press OK.
- 4 While the video plays, press  to add bookmarks. When finished adding up to 9 bookmarks, press .
 - Press the Menu button to exit the menu.

IMPORTANT: *Your camera offers a built-in Help system. See page 13.*

Using bookmarks







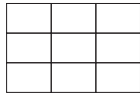
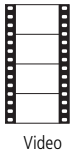

- 1 Press the Review  button, then  to find a video.
- 2 Press  to play the video. To jump to the first bookmark, press and hold  for 4 seconds while the video is playing.
 - After you jump to a bookmark, press  to jump to other bookmarks.
 - To view all bookmarked video frames, press the Wide Angle (W) button. To return to normal view, press the Telephoto (T) button.

Making a video action print

From a video, you can make a 4-, 9-, or 16-up picture, suitable for a 4 x 6-inch (10 x 15 cm) print.



4-, 9-, or
16-up picture

- 1 Press the Review  button, then  to find a video.
- 2 Press the Menu  button, then  to highlight the Edit  tab.
- 3 Press  to highlight Action Print, then press OK. Choose an option, then press OK:

- Auto options: The camera includes the first and last frames, then 2, 7, or 14 equally spaced frames.
- Manual: You choose the first and last frames; the camera chooses 2, 7, or 14 equally spaced frames.
- Use Bookmarks: Bookmarked frames are used.









A 4-, 9-, or 16-up picture is created. If you have less than 4 or 9 bookmarks, equally spaced video frames are used.

- Press the Menu button to exit the menu.

IMPORTANT: *Your camera offers a built-in Help system. See page 13.*

Play a multimedia slide show











To show all pictures/videos

- 1 Press the Review  button.
- 2 Press the Menu  button, then /  to highlight the Review tab.
- 3 Press /  to highlight Multimedia Slide Show, then press OK.
- 4 Press /  to highlight Preview Slide Show, then press OK.



All pictures/videos are displayed. To interrupt the slide show, press OK. After the slide show plays, you may save or modify it.

IMPORTANT: Your camera offers a built-in Help system. See [page 13](#).

To show selected pictures/videos

- 1 Press the Review  button.
- 2 Press the Menu  button, then /  to highlight the Review tab.
- 3 Press /  to highlight Multimedia Slide Show, then press OK.
- 4 Press /  to highlight Select Images, then press OK.
- 5 Press /  to locate a picture/video, then press OK.

A checkmark appears.

Press /  to continue adding pictures/videos. When finished, press /  to highlight Done, then press OK.

- 6 Press /  to highlight Preview Slide Show, then press OK.

Selected pictures/videos are displayed. To interrupt the slide show, press OK. After the slide show plays, you may save or modify it.

Displaying pictures/videos on a television

You can display pictures/videos on a television, computer monitor, or any device equipped with a video input. To connect the camera to a television, use an A/V cable (may be sold separately).

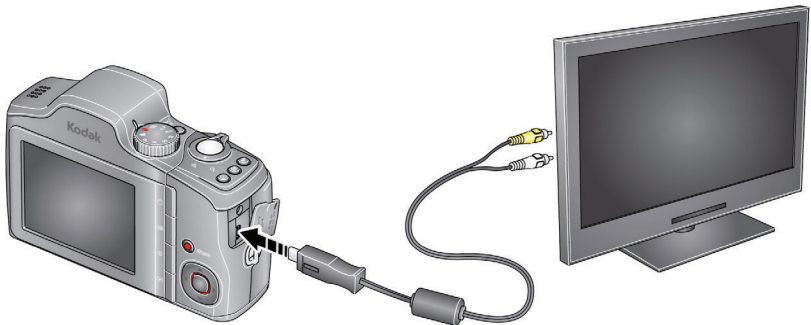

NOTE: Ensure that the Video Out setting (NTSC or PAL) is correct (see page 37). (Image quality on a television screen may not be as good as on a computer monitor or when printed.)

Viewing pictures/videos in different ways

Viewing as thumbnails (multi-up)

- 1 Press the Review  button.
- 2 Press the Wide Angle (W) button to change from single-picture view to multi-up thumbnails.
- 3 Press Telephoto (T) to return to single-picture view.
 - To select multiple pictures/videos, see [page 30](#).
 - Press the Review button to exit Review.

Selecting multiple pictures/videos

Use the multi-select feature when you have two or more pictures/videos to print or delete. (Multi-select can also be used in Multi-Up mode, [page 30](#).)

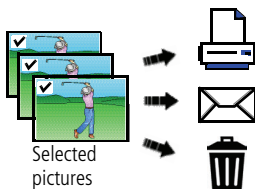

- 1 Press the Review  button, then /▶ to find a picture/video.
- 2 Press OK to select pictures/videos.



A check mark appears on the picture. You can now print or delete the selected pictures. You can press OK a second time to remove a check mark.

Copying pictures/videos

You can copy pictures/videos from a card to internal memory or from internal memory to a card.

NOTE: Before you copy, make sure that a card is inserted in the camera.

Copy pictures/videos:

- 1 Press the Review  button, then the Menu  button.
- 2 Press $\blacktriangle/\blacktriangledown$ to highlight Copy, then press OK.
- 3 Press $\blacktriangle/\blacktriangledown$ to highlight an option, then press OK.

IMPORTANT: Your camera offers a built-in Help system. See [page 13](#).

NOTE: Pictures/videos are copied, not moved. To remove pictures/videos from the original location after copying, delete them (see [page 19](#)).



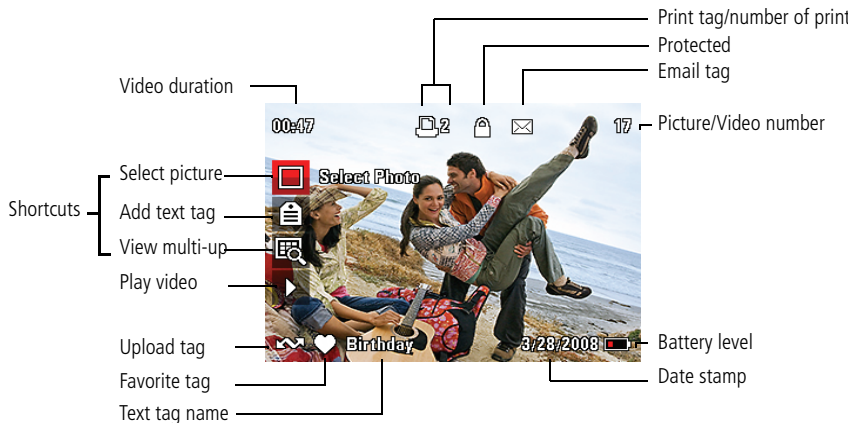

Understanding the review icons



4

Using the menu button

You can change settings to get the best results from your camera.

- 1 Press the Menu  button.
- 2 Press  to highlight a tab:
 - **Capture/Video** for the most common picture/video-taking settings
 - **Setup** for other camera settings
- 3 Press  to highlight a setting, then press OK.
- 4 Highlight an option, then press OK. (Some options let you use .)

IMPORTANT: *Your camera offers a built-in Help system. See page 13.*

NOTE: Some modes offer limited settings. Some settings remain until you change them; others, until you change modes or turn off the camera.

Press Menu, , , **Capture Options** and OK to access settings

Picture Size

Choose a picture resolution.

See [Camera specifications, page 53](#).

Video Size

Available only in Video mode.

VGA (640 x 480)—medium quality and file size. (4 GB maximum video size.)

QVGA (320 x 240)—lower quality; smallest file size. (4 GB maximum video size.)

Press Menu, ◀/▶, ▲/▼, Capture Options and OK to access settings

Color Mode

Choose color tones.

High Color

Natural Color

Low Color

Black & White

Sepia

NOTE: EASYSHARE Software also lets you change a color picture to black-and-white or sepia.

Unavailable in Video mode.

AF Control

Choose an auto-focus setting.
Available only in SCN, P, A, S, M, and Video modes.

Continuous AF—because the camera is always focusing, there is no need to press the Shutter button halfway down to focus.

Single AF—uses TTL-AF (through-the-lens auto focus) when the Shutter button is pressed halfway down.

White Balance

Choose your lighting condition.
Available only in P, A, S, M and Panorama modes.

Auto—automatically corrects white balance. Ideal for general picture taking.

Daylight—for pictures in natural lighting.

Tungsten—corrects the orange cast of household light bulbs. Ideal for indoor pictures under tungsten or halogen lighting without flash.

Fluorescent—corrects the green cast of fluorescent lighting. Ideal for indoor pictures under fluorescent lighting without flash.

Open Shade—for pictures in shade in natural lighting.

Press Menu, ◀/▶, ▲/▼, Capture Options and OK to access settings

Exposure Metering

Evaluate light levels at specific areas of a scene.

Available only in P, A, S, M and Panorama modes.

Multi-pattern—evaluates lighting conditions throughout the image to give an optimum picture exposure. Ideal for general picture taking.

Center-weighted—evaluates the lighting conditions of the subject centered in the LCD. Ideal for backlit subjects.

Center-Spot—similar to Center-weighted, except the metering is concentrated on a smaller area of the subject centered in the LCD.

AF Zone

Select a large or concentrated area of focus.

Available only in P, A, S, M and Panorama modes.

Multi-zone—evaluates 5 zones to give an even picture focus. Ideal for general picture taking.

Center-zone—evaluates the small area centered in the LCD. Ideal when precise focus of a specific area in the picture is needed.

Exposure Bracketing Interval

Choose the difference in exposure compensation while using exposure bracketing.

Available only in P, A, and M modes.

Off

+/- 0.3 EV

+/- 0.7 EV

+/- 1.0 EV

See [page 16](#).

Sharpness

Control picture sharpness.

Available only in P, A, S, M and Panorama modes.

High

Normal

Low

Histogram





Turn histogram on/off.





On





Off

Using the Setup menu

IMPORTANT: *Your camera offers a built-in Help system. See page 13.*

Press Menu,  ,  ,  ,  , and OK to access settings	Setup Options
<p>Share button Choose how pictures/videos are handled when you press the Share button (via EASYSHARE Software for WINDOWS OS only).</p> <p>NOTE: Some online services limit video file sizes. Where applicable, use EASYSHARE Software to choose a preferred online service.</p>	<p>Favorite and Upload—pictures/videos are tagged as Favorites and uploaded to your preferred online service when you connect to your computer or network.</p> <p>Favorite—pictures/videos are tagged as Favorites (5-star in EASYSHARE Software, on your computer).</p> <p>Upload—pictures/videos are uploaded to your preferred online service when you connect to your computer or network.</p>
<p>LCD Brightness</p>	<p>1, 2, 3, 4, 5—dimtest to brightest. (Use a dimmer setting to save battery power.)</p>
<p>Image Storage Choose a storage location for pictures/videos.</p>	<p>Auto—the camera uses the card if one is in the camera. If not, the camera uses internal memory.</p> <p>Internal Memory—the camera uses internal memory, even if a card is installed.</p>
<p>Set Tag Assign tag names to pictures/videos. Select tag name(s) before you take pictures or videos. Then, new pictures/videos are assigned that tag name(s).</p>	<p>Clear All Add Tag Delete Tag Exit Tag Name 1 Tag Name 2 See page 42.</p>

Press Menu, , , , , and OK to access settings	Setup Options
Capture Frame Grid Use the frame grid to divide the LCD screen into thirds, vertically and horizontally.	On Off
Date Stamp Imprint the date on pictures.	On Off
Red-eye Reduction Choose how red-eye is reduced.	Preflash —the flash fires to reduce the chance of red-eye. Digital correction —the camera digitally corrects red-eye after a picture is taken.
Image Stabilizer Choose when image stabilization occurs.	Continuous —stabilization occurs continuously. Single —stabilization occurs only when the Shutter button is pressed halfway down. Off
Quickview Show a picture/video as soon as it is taken.	Off 5 Seconds 10 Seconds
Advanced Digital Zoom Zoom using optical, then digital zoom. Not available in Smart Capture mode.	Continuous —zooming is continuous between optical and digital zoom. Pause —zooming pauses at the optical zoom maximum. To use digital zoom, release then press the Telephoto (T) zoom lever. None —digital zoom is off.
Orientation Sensor Orient pictures so that they are displayed with the correct side up.	For pictures —On, On Transfer, Off For videos —On, Off
Camera Sounds	Turn sounds on/off for individual functions.

Press Menu,  ,  ,  ,  , and OK to access settings	Setup Options
Sound Volume	High Medium Low Mute
Date & Time	See page 2 . The format chosen is used for all date/time features.
Auto Power Off Choose inactivity time until camera turns off.	10 minutes 5 minutes 3 minutes 1 minute
Video Out Choose the regional setting for connecting to a television or other external device.	Check settings used in your location. NTSC —used in North America and Japan. PAL —used in Europe and China.
Language	See page 2 .
Reset Camera	Reset all camera settings to their defaults. (After using the Reset Camera feature, turn the camera off and then on again.)
Format  CAUTION: Formatting deletes all pictures/videos, including those that are protected.	Memory Card —deletes everything on the card; formats the card. Cancel —exits without making a change. Internal Memory —deletes everything in internal memory including email addresses, and tag names; formats the internal memory.
About View camera information.	

5

Transferring, printing, and sharing pictures

Installing the software



CAUTION:

Install **EASYSHARE Software** *before* connecting the camera to the computer. Failure to do so may cause the software to load incorrectly.

- 1 Close all software applications that are open on your computer (including anti-virus software).
- 2 Place the EASYSHARE Software CD into the CD-ROM drive.
- 3 Load the software:

WINDOWS OS—if the install window does not appear, choose Run from the Start menu and type **d:\setup.exe** where **d** is the drive letter that contains the CD.

MAC OS X—double-click the CD icon on the desktop, then click the Install icon.

- 4 Follow the on-screen instructions to install the software.

NOTE: When prompted, take a few minutes to electronically register your camera and software. To register later, see www.kodak.com/go/register.

- 5 If prompted, restart the computer. If you turned off anti-virus software, turn it back on. See the anti-virus software manual for details.

For software help, click the Help button in EASYSHARE Software.

Transferring pictures with the USB cable



- ① Turn off the camera.
- ② Connect the KODAK USB Cable, Model U-8.
- ③ Turn on the camera. KODAK EASYSHARE Software opens on your computer and prompts you through the transfer process.

Using other options

You can also use a KODAK Card Reader to transfer your pictures/videos.

Purchase accessories www.kodak.com/go/z915accessories

Learn more about connecting www.kodak.com/go/howto

Printing pictures

Direct printing with a KODAK All-in-One Printer

Your camera is compatible with PICTBRIDGE Technology, so you can print directly to PICTBRIDGE enabled Printers. You need a camera with fully charged battery, a PICTBRIDGE enabled Printer, and a USB cable.

- 1 Turn **off** the printer. Turn **on** the camera.
- 2 Connect the appropriate USB cable from the camera to the printer.

The PICTBRIDGE logo is displayed, followed by the current picture and menu. (If no pictures are found, a message is displayed.) If the menu turns off, press any button to redisplay it.

- 3 Highlight a printing option, then press OK.

Current Picture—Press ◀/▶ to choose a picture. Choose the number of copies.

Tagged Pictures—Print pictures that you marked for printing and choose a print size.

Index Print—Print thumbnails of all pictures. (This option requires one or more sheets of paper.) If the printer is capable, choose a print size.

All Pictures—Print all pictures in internal memory or on a card. Choose the number of copies.

Image Storage—Access Auto or Internal Memory.

Disconnecting the camera from a KODAK All-in-One Printer

- 1 Turn off the camera and printer.
- 2 Disconnect the USB cable from the camera and the printer.

Using a printer that is not PICTBRIDGE Technology enabled

After you transfer pictures from the camera to your computer, you can print them from EASYSHARE Software. For details, see Help in EASYSHARE Software.

Ordering prints online

KODAK Gallery (www.kodakgallery.com) is one of the many online print services offered in EASYSHARE Software. You can easily:

- Upload your pictures.
- Edit, enhance, and add borders to your pictures.
- Store pictures, and share them with family and friends.
- Have prints, photo greeting cards, frames, and albums delivered to your door.

Printing from an optional SD or SDHC Card





- Automatically print marked pictures when you insert your card into a printer with an SD/SDHC Card slot. See your printer user's guide for details.
- Make prints at an SD/SDHC Card-capable KODAK Picture Kiosk. (Visit www.kodak.com/go/picturemaker.)
- Take the card to your local photo retailer for professional printing.



Marking your pictures

You can mark your pictures so they are easy to:

- Print
- Email
- Organize as a favorite
- Organize with a name that you create

Marking pictures for printing

- 1 Press the Review  button. Press  to locate a picture.
- 2 Press the Menu  button. Press  to highlight Print, then press OK.
- 3 Press  to select the number of copies.

Optional: You can apply a print quantity to other pictures. Press  for previous/next. Keep the print quantity as is, or press  to change it. Repeat this step until the desired print quantity is applied to the pictures.

- 4 Press OK.

The Print icon appears in the status area.

- Press the Review button to return to Capture mode.







IMPORTANT: *Your camera offers a built-in Help system. See [page 13](#).*

Printing marked pictures

When you transfer the marked pictures to your computer, the EASYSHARE Software print screen opens. For details on printing, see Help in EASYSHARE Software.

Marking pictures/videos for emailing

It's simple to mark pictures so that they're ready to email using KODAK EASYSHARE Software. First, create a new email address. (See "Add a new email address or name" on page 43.)

- 1 Press the Review  button. Press   to locate a picture, then press OK.
- 2 Press   to highlight Email, then press OK.
- 3 Press   to locate an email address, then press OK.

To mark other pictures/videos with the same address, scroll through them. When the picture you want is displayed, press OK.







To send the pictures/videos to more than one address, repeat step 3.

- To remove a selection, highlight a checked address and press OK. To remove all email selections, highlight Clear All, then press OK.
- Press the Review button to return to Capture mode.

The Email icon appears in the status area.

When you transfer the marked pictures/videos to your computer, EASYSHARE Software prompts you to send the pictures/videos. For details, see Help in EASYSHARE Software.

Add a new email address or name



- 1 Press the Review  button, then the Menu  button.
- 2 Press   to highlight Email or Tag, then press OK.
- 3 Press   to highlight New Email or New Tag, then press OK.
- 4 Use the on-camera keyboard, then press OK.

The email address or name is now available.

IMPORTANT: *Your camera offers a built-in Help system. See page 13.*

Marking pictures/videos as favorites



To make your favorite pictures/videos easier to locate in EASYSHARE Software, you can mark them as favorites.

- 1 Press the Review  button, then  to locate a picture/video.
- 2 Press the Share button.

The favorite mark appears with the picture. When you transfer these pictures/videos to your computer, EASYSHARE Software opens and categorizes your pictures/videos with a 5-star rating. (To configure the Share button in different ways see page 35.)

Assigning other tags to pictures/videos

First, create a new tag name. (See “Add a new email address or name” on page 43.)

- 1 Press the Review  button, then locate a picture/video.
- 2 Press the Menu  button.
- 3 Highlight Tag, then press OK.
- 4 Highlight a tag name, then press OK.

To assign the tag to other pictures, press  to locate a picture, then press OK.

The tag name appears with the picture.



To remove a selection, highlight a tag name and press OK. To remove all tag selections, highlight Clear All, then press OK.

When you transfer the tagged pictures/videos to your computer, EASYSHARE Software opens and categorizes your pictures/videos with the appropriate tag.

IMPORTANT: *Your camera offers a built-in Help system. See page 13.*

Assigning a tag to the pictures/videos you take next

Use the Set Tag feature to assign a tag name to the next pictures/videos you take. First, create a new tag name. (See “Add a new email address or name” on page 43.)

- 1 Press the Menu  button.
- 2 Highlight the Setup  tab.
- 3 Highlight Set Tag, then press OK.
- 4 Highlight a tag name, then press OK.
- 5 Press the Menu  button to exit the menu.

The selected tag is displayed on the LCD. The tag is applied to new pictures/videos.

When you transfer the tagged pictures/videos to your computer, EASYSHARE Software opens and categorizes your pictures/videos with the appropriate tag.

IMPORTANT: *Your camera offers a built-in Help system. See page 13.*

6

Troubleshooting

For step-by-step product support, visit www.kodak.com/go/z915support and select Interactive Troubleshooting & Repairs.

Camera problems

If	Try one or more of the following
Camera does not turn on.	<ul style="list-style-type: none"> ■ Install new batteries (page 1). ■ Charge rechargeable batteries.
Camera does not turn off.	<ul style="list-style-type: none"> ■ Remove the battery, then reinsert or replace it. If the camera still does not function, visit www.kodak.com/go/z915support and select Interactive Troubleshooting & Repairs.
Pictures remaining number does not decrease after taking a picture.	<ul style="list-style-type: none"> ■ The camera is operating normally. Continue taking pictures.
Stored pictures are corrupted.	<ul style="list-style-type: none"> ■ Retake pictures. Do not remove card while the camera is on. Keep rechargeable batteries charged. ■ Transfer the pictures to the computer (page 39), then format the card or internal memory (see page 37). <p>CAUTION: Formatting a card deletes all pictures and videos, including protected files.</p>
In Review mode, you do not see a picture (or the expected picture) on the LCD screen.	<ul style="list-style-type: none"> ■ Check the image storage location setting (page 35).

If	Try one or more of the following
In Review mode, a blue or black screen is displayed instead of a picture.	<ul style="list-style-type: none"> ■ Transfer the picture to the computer (page 39), then format the card or internal memory (see page 37). <p>CAUTION: Formatting a card deletes all pictures and videos, including protected files.</p>
Shutter button does not work.	<ul style="list-style-type: none"> ■ Turn on the camera (page 2). ■ Transfer pictures to the computer (page 39), delete pictures from the camera (page 19), switch image storage locations (page 35), or insert a card with available memory (page 3).
Slide show does not run on external video device.	<ul style="list-style-type: none"> ■ Adjust the camera Video Out setting (NTSC or PAL, see page 37). ■ See the external device's user's guide.
Picture is too light.	<ul style="list-style-type: none"> ■ Move so there is at least 2 ft (0.6 m) between the camera and the subject. ■ Decrease Exposure Compensation (page 16).
Picture is not clear.	<ul style="list-style-type: none"> ■ Clean the lens (page 58). ■ Make sure your camera is not in Close-up mode. ■ Move so there is at least 2 ft (0.6 m) between the camera and the subject. ■ Press the shutter button halfway to focus and set exposure. When the framing marks turn green, press the Shutter button completely down. ■ Place the camera on a flat, steady surface or use a tripod.
Picture is too dark.	<ul style="list-style-type: none"> ■ Turn on the flash (page 9). ■ Move so there is no more than 11.8 ft (3.6 m) in wide angle and 6.9 ft (2.1 m) in telephoto between the camera and the subject. ■ Use Fill flash (page 9) or change your position so light is not behind the subject. ■ Increase Exposure Compensation (page 16).

If	Try one or more of the following
Camera does not recognize SD/SDHC Card.	<ul style="list-style-type: none"> ■ Purchase a certified SD/SDHC Card. ■ Format the card (see page 37). <p>CAUTION: Formatting a card deletes all pictures and videos, including protected files.</p> <ul style="list-style-type: none"> ■ Insert a card into the slot (page 3).
Camera freezes up when a card is inserted or removed.	<ul style="list-style-type: none"> ■ Turn the camera off, then back on. Make sure the camera is turned off before inserting or removing a card.
Memory card full.	<ul style="list-style-type: none"> ■ Insert a new card (page 3), transfer pictures to the computer (page 39), or delete pictures (page 19).
Memory card and internal memory full.	<ul style="list-style-type: none"> ■ Transfer pictures to the computer (page 39), then format the card or internal memory (see page 37). <p>CAUTION: Formatting a card deletes all pictures and videos, including protected files.</p>
The Reset Camera feature did not take effect.	<ul style="list-style-type: none"> ■ After using the Reset Camera feature (see page 37), turn the camera off and then on again.
Pictures taken on a tripod are blurry.	<ul style="list-style-type: none"> ■ Occasionally, a tripod interferes with the camera's image stabilizer. In the Setup  menu, set Image Stabilizer to Off (see page 36).
Cannot delete some pictures.	<ul style="list-style-type: none"> ■ If a picture is marked as a favorite, a Protect tag is automatically applied (and remains even if the favorite mark is removed). A protected picture cannot be deleted unless the Protect tag is removed (page 20) or the card/internal memory is formatted (see page 37).
Pictures that have KODAK PERFECT TOUCH Technology applied (twice) are of lower image quality.	<ul style="list-style-type: none"> ■ If PERFECT TOUCH Technology has been applied to a picture on the camera, do not apply it again when the picture is on the computer (or on a KODAK Picture Kiosk). <p>NOTE: PERFECT TOUCH Technology is automatically applied to pictures taken in Smart Capture mode.</p>

Camera/computer communications

If	Try one or more of the following
Cannot transfer pictures. (The Add New Hardware Wizard cannot locate drivers.)	<ul style="list-style-type: none"> ■ Disconnect the USB cable. Close all open applications. Re-install the software (page 38).
The computer does not communicate with the camera.	<ul style="list-style-type: none"> ■ Turn on the camera (page 2). ■ Install new batteries (page 1) or charge rechargeable batteries. ■ Connect cable to camera and computer port (page 39). ■ Install the software (page 38). ■ Disconnect the USB cable. Close all open applications. Re-install the software (page 38). ■ Disconnect camera from the computer. Close all software applications, reconnect camera.
Pictures taken in Smart Capture with Orientation Sensor set to "On Transfer" are not correctly rotated when transferred to the computer.	<ul style="list-style-type: none"> ■ In the Setup  menu, change the Orientation Sensor setting to "On" (page 36). Then, take new pictures and transfer them to the computer.
HD videos longer than 20 minutes are not transferred to the computer.	<ul style="list-style-type: none"> ■ Use a card reader to drag and drop long videos to the computer. Then use the Add Pictures button in EASYSHARE Software to import the videos. ■ Take shorter videos.
Tags that are assigned to a video do not transfer to the computer.	<ul style="list-style-type: none"> ■ After a picture/video is transferred to the computer, assign tags using EASYSHARE Software.
Email tags are not transferred to the computer, or email address are deleted from the camera.	<ul style="list-style-type: none"> ■ After a picture/video is transferred to the computer, assign email tags using EASYSHARE Software.
Sound tags are not transferred to the computer with pictures.	<ul style="list-style-type: none"> ■ Assign a Sound tag to pictures taken in any mode except Smart Capture.

LCD messages

If	Try one or more of the following
No images to display	■ Change image storage location setting (see page 35).
Memory card requires formatting	■ Insert a new card (page 3) or format the card (see page 37). CAUTION: Formatting a card deletes all pictures and videos, including protected files.
Memory card cannot be read (Please format memory card or insert another card)	
Internal memory requires formatting	■ Format the internal memory (see page 37). CAUTION: Formatting a card deletes all pictures and videos, including protected files.
Internal memory cannot be read (Please format internal memory)	
Memory card is locked (Insert new memory card)	■ Insert a new card (page 3), move the switch on the card to unlock the card, or change the image storage location to internal memory (see page 35).
Memory card is unusable (Insert new memory card)	■ Insert a new card (page 3) or format the card (see page 37). CAUTION: Formatting a card deletes all pictures and videos, including protected files.
High camera temperature. (Camera will be turned off.)	■ Leave the camera off for ten minutes, then turn it back on. If the message reappears, visit www.kodak.com/go/z915support and select Interactive Troubleshooting & Repairs.
Unrecognized file format	■ Transfer the picture to the computer (page 39), or delete it (page 19).
Camera error #XXXX. See user's guide.	■ Turn camera off, then back on. If the message reappears, visit www.kodak.com/go/z915support and select Interactive Troubleshooting & Repairs.

7

Getting help

Helpful links

Camera

Email, write, or phone customer support	www.kodak.com/go/contact
Get support for your product (FAQs, arrange for repairs, troubleshooting information, etc.)	www.kodak.com/go/z915support
Purchase camera accessories (lenses, cards, etc.)	www.kodak.com/go/z915accessories
Download the latest camera firmware and software	www.kodak.com/go/z915downloads
See online demonstrations of your camera	www.kodak.com/go/howto

Software

Get information on EASYSHARE Software	www.kodak.com/go/easysharesw (or click the Help button in EASYSHARE Software)
Get help with the WINDOWS Operating System and working with digital pictures	www.kodak.com/go/pcbasics

Other

Get support for other cameras, software, accessories	www.kodak.com/go/support
Get information on KODAK Inkjet Products	www.kodak.com/go/inkjet
Register your camera	www.kodak.com/go/register

Getting help

NOTE: If you have questions concerning this product, you may speak with Kodak customer support.

Australia	1800 267 588	Netherlands	020 346 9372
Austria	0179 567 357	New Zealand	0800 880 120
Belgium	02 713 14 45	Norway	23 16 21 33
Brazil	0800 891 42 13	Philippines	1 800 1 888 9600
Canada	1 800 465 6325	Poland	00800 4411625
China	800 820 6027	Portugal	021 415 4125
Czech Republic	00 800 56325000	Russia	8 495 929 9166
Denmark	3 848 71 30	Singapore	800 6363 036
Finland	0800 1 17056	Slovakia	00 800 56325000
France	01 55 1740 77	Spain	91 749 76 53
Germany	069 5007 0035	Sweden	08 587 704 21
Greece	00800 44140775	Switzerland	044 838 53 51
Hong Kong	800 901 514	Taiwan	0800 096 868
Hungary	06 80 456 325	Thailand	001 800 631 0017
India	91 80 41374555 (toll free 000800 440 1227)	Turkey	00800 448827073
Ireland	01 407 3054	United Kingdom	0870 243 0270
Italy	02 696 33452	United States	1 800 235 6325
Japan	03 5540 9002	International Toll Line	+44 131 458 6714
Korea	080 708 5600	International Toll Fax	+44 131 458 6962

8

Appendix

Camera specifications

For more specifications, visit www.kodak.com/go/z915support.

Image sensor—1/2.3-type (4:3 aspect ratio)

Effective Pixels—3672 x 2748 (10 MP)

Color display—6.4 cm (2.5-type) color hybrid LCD; 230 K (960 x 240) dots; 25 fps

Lens—10X optical zoom lens, 35–350 mm (35 mm equivalent); f/3.5–f/4.8

Image stabilizer—Optical

Lens barrier—Automatic built-in

Digital zoom—5.0X continuous

Combined zoom—50X

Shutter speed—

Smart Capture mode: 1/8–1/1250 sec. (speed is automatically set by the camera)

Shutter Priority and Manual modes: 16–1/1000 sec. (speed is selectable)

External storage—Optional SD/SDHC Card . (The SD logo is a trademark of the SD Card Association.)

Internal storage—32 MB (13.5 MB available for image storage. 1 MB equals one million bytes.)

ISO speed—Auto, 100, 200, 400, 800, 1600

Exposure metering—TTL-AE; Multi-pattern, Center-weighted, Center-Spot

Exposure compensation—+/- 1.0 EV with 1/3 EV steps

Exposure bracketing—3 images with selectable +/- 0.3 EV steps

White balance—Auto, Daylight, Tungsten, Fluorescent, Open Shade

www.kodak.com/go/support

Focus system—TTL-AF (through-the-lens auto focus); Multi-zone AF, and Center-zone AF; Working range:

0.5 m (1.6 ft)—infinity @ wide

1.2 m (3.9 ft)—infinity @ telephoto

12–60 cm (4.7–23.6 in.) @ wide macro

0.6–1.3 m (2–4.3 ft) @ telephoto macro

Electronic flash—Auto flash; Guide no. 9.5 @ ISO 100; working range in Smart Capture mode with red eye reduction off: 5.4 m (17.7 ft) @ wide; 3.9 m (12.8 ft) @ telephoto

Flash modes—Auto, Fill, Red-eye Reduction, Off

Capture modes—Smart Capture, Sport, SCN Modes, Program, Aperture Priority, Shutter Priority, Manual, Panorama, Video

Drive modes—Single shot, burst, self-timer (10-second, 2-shot, and 2-second)

File format—Still: JPEG/EXIF 2.21; Video: QuickTime, Motion JPEG; Audio: G.711

Color modes—High Color, Natural Color, Low Color, Black & White, Sepia

Sharpness—High, Normal, Low

Video size—VGA (640 x 480 @ 30 fps); QVGA (320 x 240 @ 30 fps)

Video output—NTSC or PAL selectable

Power—KODAK AA Alkaline, Ni-MH, or Lithium Batteries; KODAK 3-Volt AC Adapter (Visit www.kodak.com/go/z915accessories.)

Burst mode—Maximum 3 pictures @ 1.5 fps; Auto Exposure, Auto Focus, Auto White Balance executed for first shot only

Microphone—Yes

Speaker—Yes

Output image size—

10 MP (4:3): 3648 x 2736 pixels

8.9 MP (3:2): 3648 x 2432 pixels

7.5 MP (16:9): 3648 x 2048 pixels

5.0 MP (4:3): 2592 x 1936 pixels

3.1 MP (4:3): 2048 x 1536 pixels

2.2 MP (3:2): 1824 x 1216 pixels

2.1 MP (16:9): 1920 x 1088 pixels

1.2 MP (4:3): 1280 x 960 pixels

Communication with computer—USB 2.0 high speed (PIMA 15740 protocol) via USB cable model U-8

PICTBRIDGE compatibility—Yes

Auto power off—Selectable 1, 3, 5, 10 minutes

Sound tag—Yes

Date stamp—Yes

Tripod mount—1/4 inch

Size—107 x 72.4 x 35.7 mm (4.2 x 2.9 x 1.4 in.) @ power off

Weight—220 g (7.8 oz) without battery or card

Operating temperature—32-104° F (0-40° C)

Storage capacities

The LCD displays the number of pictures (or minutes/seconds of video) remaining. For average SD Card capacities, visit www.kodak.com/go/SDcapacities. Actual storage capacity varies depending on subject composition, card size, and other factors. You may be able to store more or fewer pictures and videos.

Important safety instructions



CAUTION:

Do not disassemble this product; there are no user-serviceable parts inside. Refer servicing to qualified service personnel. KODAK AC Adapters and Battery Chargers are intended for indoor use only. The use of controls, adjustments, or procedures other than those specified herein may result in exposure to shock and/or electrical or mechanical hazards. If the LCD breaks, do not touch the glass or liquid. Contact Kodak customer support.

- The use of an accessory that is not recommended by Kodak may cause fire, electric shock, or injury. For approved accessories, visit www.kodak.com/go/accessories.
- Use only a USB-certified computer equipped with a current-limiting motherboard. Contact your computer manufacturer if you have questions.
- If using this product in an airplane, observe all instructions of the airline.
- When removing the battery, allow it to cool; it may be hot.
- Follow all warnings and instructions supplied by the battery manufacturer.
- Use only batteries approved for this product to avoid risk of explosion.
- Keep batteries out of the reach of children.
- Do not allow batteries to touch metal objects, including coins. Otherwise, a battery may short circuit, discharge energy, become hot, or leak.
- Do not disassemble, install backward, or expose batteries to liquid, moisture, fire, or extreme temperature.
- Remove the battery when the product is stored for an extended period of time. In the unlikely event that battery fluid leaks inside the product, contact Kodak customer support.
- In the unlikely event that battery fluid leaks onto your skin, wash immediately with water and contact your local health provider. For additional health-related information, contact your local Kodak customer support.

- Dispose of batteries according to local and national regulations. Visit www.kodak.com/go/kes.
- Do not charge non-rechargeable batteries.
For more information on batteries, see www.kodak.com/go/batterytupes.

Upgrading your software and firmware

Download the latest versions of the software included on the KODAK EASYSHARE Software CD and the camera firmware (the software that runs on the camera). See www.kodak.com/go/z915downloads.

Battery life

- KODAK MAX Alkaline Batteries, AA: < 150 pictures
- KODAK Ni-MH Rechargeable Digital Camera Batteries: 280 pictures

Battery life per CIPA testing method using 128 MB SD Card. Approximate number of pictures in Smart Capture mode. Actual life may vary based on usage.

Extending battery life

- Use power-saving features. (Examples: lower the Auto Power Off and set LCD Brightness settings; set Image Stabilizer to Single or Off.) See [Chapter 4, Using the menu button](#). Use the Review and Slide Show features sparingly.
- Keep battery contacts/terminals clean. Wipe with a dry cloth.
- Fully charge Ni-MH batteries prior to use and occasionally discharge to depletion. Avoid over-charging Ni-MH batteries.
- Battery performance is reduced at low temperatures. When using your camera in cold weather, keep spare batteries warm. Do not discard cold batteries that do not work; when they return to room temperature, they may be usable.

Care and maintenance

- If you suspect water has gotten inside the camera, remove the battery and card. Allow all components to air-dry for at least 24 hours before using the camera.
- Blow gently on the lens or LCD to remove dust and dirt. Wipe gently with a soft, lint-free cloth or an untreated lens-cleaning tissue. Do not use cleaning solutions unless designed specifically for camera lenses. Do not allow chemicals, such as suntan lotion, to contact painted surfaces.
- Service agreements may be available in your country. Contact a dealer of KODAK Products for more information.
- For digital camera disposal or recycling information, contact your local authorities. In the US, visit the Electronics Industry Alliance at www.eiae.org or the Kodak Web site at www.kodak.com/go/z915support.

Limited warranty

Kodak warrants its digital cameras and accessories (excluding batteries) to be free from malfunctions and defects in both materials and workmanship for the warranty period specified on your Kodak Product packaging. Retain the original dated sales receipt. Proof of purchase date is required with any request for warranty repair.

Limited warranty coverage

Warranty service is only available from within the country where the Products were originally purchased. You may be required to ship Products, at your expense, to the authorized service facility for the country where the Products were purchased. Kodak will repair or replace Products if they fail to function properly during the warranty period, subject to any conditions and/or limitations stated herein. Warranty service will include all labor as well as any necessary adjustments and/or replacement parts. If Kodak is unable to repair or replace a Product, Kodak will, at its option, refund the purchase price paid for the Product provided the Product has been returned to Kodak along with proof of the purchase price paid. Repair, replacement, or refund of the purchase price are the sole remedies under the warranty. If replacement parts are used in making repairs, those parts may be remanufactured, or may contain

remanufactured materials. If it is necessary to replace the entire Product, it may be replaced with a remanufactured Product. Remanufactured Products, parts and materials are warranted for the remaining warranty term of the original Product, or 90 days after the date of repair or replacement, whichever is longer.

Limitations

This warranty does not cover circumstances beyond Kodak's control. This warranty does not apply when failure is due to shipping damage, accident, alteration, modification, unauthorized service, misuse, abuse, use with incompatible accessories or attachments (such as third party ink or ink tanks), failure to follow Kodak's operation, maintenance or repacking instructions, failure to use items supplied by Kodak (such as adapters and cables), or claims made after the duration of this warranty. Kodak makes no other express or implied warranty for this product. In the event that the exclusion of any implied warranty is ineffective under the law, the duration of the implied warranty will be the length of the express warranty period specified on your Kodak product packaging. The option of repair, replacement, or refund is Kodak's only obligation. Kodak will not be responsible for any special, consequential or incidental damages resulting from the sale, purchase, or use of this product regardless of the cause. Liability for any special, consequential or incidental damages (including but not limited to loss of revenue or profit, downtime costs, loss of the use of the equipment, cost of substitute equipment, facilities or services, or claims of your customers for such damages resulting from the purchase, use, or failure of the Product), regardless of cause or for breach of any written or implied warranty is expressly disclaimed.

Your rights

Some states or jurisdictions do not allow exclusion or limitation of incidental or consequential damages, so the above limitation or exclusion may not apply to you. Some states or jurisdictions do not allow limitations on how long an implied warranty lasts, so the above limitation may not apply to you. This warranty gives you specific rights, and you may have other rights which vary from state to state or by jurisdiction.

Outside the United States and Canada

In countries other than the United States and Canada, the terms and conditions of this warranty may be different. Unless a specific Kodak warranty is communicated to the purchaser in writing by a Kodak company, no warranty or liability exists beyond any minimum requirements imposed by law, even though defect, damage, or loss may be by negligence or other act.

Regulatory compliance

FCC compliance and advisory

This equipment has been tested and found to comply with the limits for a Class B digital device, pursuant to Part 15 of the FCC Rules. These limits are designed to provide reasonable protection against harmful interference in a residential installation. This equipment generates, uses, and can radiate radio frequency energy and, if not installed or used in accordance with the instructions, may cause harmful interference to radio communications. However, there is no guarantee that interference will not occur in a particular installation. If this equipment does cause harmful interference to radio or television reception, which can be determined by turning the equipment off and on, the user is encouraged to try to correct the interference by one or more of the following measures: 1) reorient or relocate the receiving antenna; 2) increase the separation between the equipment and the receiver; 3) connect the equipment to an outlet on a circuit different from that to which the receiver is connected; 4) consult the dealer or an experienced radio/TV technician for additional suggestions. Any changes or modifications not expressly approved by the party responsible for compliance could void the user's authority to operate the equipment. Where shielded interface cables have been provided with the product or specified additional components or accessories elsewhere defined to be used with the installation of the product, they must be used in order to ensure compliance with FCC regulation.

Canadian DOC statement

DOC Class B Compliance—This Class B digital apparatus complies with Canadian ICES-003.

Observation des normes-Classe B—Cet appareil numérique de la classe B est conforme à la norme NMB-003 du Canada.

Waste Electrical and Electronic Equipment labeling/battery disposal



In Europe: For human/environmental protection, it is your responsibility to dispose of this equipment and batteries at a collection facility established for this purpose (separate from municipal waste.) For more information, contact your retailer,



collection facility, or appropriate local authorities; or visit www.kodak.com/go/recycle. Product weight: 220 g (7.8 oz)

Australian C-Tick



N137

Korean Class B ITE

B급 기기
(가정용 방송통신기기)

이 기기는 가정용(B급)으로 전자파적합등록을 한 기기로서 주로 가정에서 사용하는 것을 목적으로 하며, 모든 지역에서 사용할 수 있습니다.

VCCI Class B ITE

この装置は、情報処理装置等電波障害自主規制協議会（VCCI）の基準に基づくクラスB情報技術装置です。この装置は、家庭環境で使用することを目的としていますが、この装置がラジオやテレビジョン受信機に近接して使用されると、電波障害を引き起こすことがあります。
取扱説明書に従って正しい取り扱いをして下さい。

China RoHS

环保使用期限 (EPUP)

在中国大陆, 该值表示产品中存在的任何危险物质不得释放, 以免危及人身健康、财产或环境的时间期限(以年计)。该值根据操作说明中所规定的产品正常使用而定。

有毒有害物质或元素名称及含量标识表						
部件名称	有毒有害物质或元素					
	铅	汞	镉	六价铬	多溴联苯	多溴二苯醚
数码相机电路板元件	×	○	○	○	○	○

○: 表示该有毒有害物质在该部件所有均质材料中的含量均在SJ/T 11363-2006规定的限量要求以下。
 ×: 表示该有毒有害物质至少在该部件的某一均质材料中的含量超出SJ/T 11363-2006规定的限量要求。



USB 数据线

Russian GOST-R



Eastman Kodak Company

17 Rochester, NY 14650

A10-40

Фотокамера изготовлена в Китае; остальные элементы -
 в соответствии с маркировкой.

Index

A

- A/V out, 11
- about this camera, 6
- accessories, 2
 - battery, 5
 - buying, 1
 - SD/SDHC card, 3
- advanced digital zoom, 5
- AF control, 2
- aperture priority, 11
- appendix, 1
- auto
 - enhancement, 6
 - flash, 7
 - focus framing marks, 1

B

- backlight, 4
- battery
 - life, 5
 - loading, 1
- beach, 4
- bookmarks, 8
- burst, using, 13
- button
 - burst, 13
 - delete, 1, 2
 - flash, 7
 - review, 1
 - shutter, 1
 - telephoto, 1
 - wide angle, 1

zoom, 5

C

- cable
 - audio/video, 11
 - USB, 2
- camera sounds, 5
- candle light, 4
- capture frame grid, 4
- caring for your camera, 6
- clock, setting, 2
- color mode, 2
- continuous AF, 2
- copy pictures
 - card to memory, 13
 - memory to card, 13
 - to computer, 1
- cropping pictures, 5
- customer support, 1, 2

D

- date setting, 2
- date stamp, 4
- DC-in, 1
- delete button, 1
- deleting
 - during quickview, 2
 - pictures/video, 2
 - protecting pictures, videos, 3
- digital zoom, using, 5
- displaying slide show, 9
- disposal, recycling, 6, 10

doing more with your camera, 1
download pictures, 1

E

EASYSHARE Software, installing, 1
emailing pictures, videos, 6
error messages, 5
exposure
 bracketing interval, 3
 compensation, 11, 14
 metering, 3
external video device
 viewing pictures, videos, 11

F

favorites tagging, 7
fireworks, 4
firmware, upgrading, 4
flash
 settings, 7
flower, 4
focus
 zone, 3
focus framing marks, 1
format, card or internal memory, 6

G

guidelines, battery, 5

H

HDTV
 format, 1
help, 1
 web links, 1
high ISO, 3

histogram, 15

I

icons
 mode dial, 3
image stabilizer, 5
image storage, 4
installing
 batteries, 1
 SD/SDHC card, 3
 software, 1
internal memory, storage capacity, 4

K

KODAK EASYSHARE Software
 installing, 1
 upgrading, 4
Kodak Perfect Touch technology, 6
Kodak web sites, 1

L

landscape, 4
LCD, 1
 brightness, 4
 reviewing pictures, 1
 reviewing videos, 1
lens, cleaning, 6
light, ready, 4
loading
 batteries, 1
 SD/SDHC card, 3
 software, 1

M

MACINTOSH Computers, installing

- software on, 1
- magnify a picture, 1
- maintenance, camera, 6
- make picture from video, 7
- manner/museum, 4
- manual, 11
- memory
 - inserting card, 3
 - storage capacity, 4
- mode dial, 3
- modes
 - aperture priority, 11
 - manual, 11
 - shutter priority, 11
- modes, capture
 - high ISO, 3
 - SCN (scene), 3
 - smart capture, 3
 - video, 3
- multimedia slide show, 10
- multiple picture selections, 12
- multi-up, 12

N

- night landscape, 4
- night portrait, 4

O

- online prints, ordering, 4
- optical zoom, 5
- orientation sensor, 5

P

- panoramic pictures, 10
- PASM mode, 11

- Perfect Touch technology, 6
- PICTBRIDGE enabled printer, 3
- picture size, 1
- pictures
 - copying, 13
 - cropping, 5
 - deleting, 2
 - emailing tagged, 6
 - from video, 7
 - Kodak Perfect Touch, 6
 - printing, 4
 - printing tagged, 5
 - protecting, 3
 - review icons, 14
 - reviewing, 1
 - storage capacity, 4
 - tagging, 5
 - taking, modes, 3
 - transfer, 1
- portrait, 4
- power, camera, 2
- pre-tagging, 8
- printing
 - from a card, 4
 - from computer, 4
 - optimizing printer, 1
 - order online, 4
 - PICTBRIDGE, 3
 - tagged pictures, 4
- problem-solving, 1
- protecting pictures, videos, 3

Q

- quickview

setting, 5
using, 2

R

ready light, 1, 4
recycling, disposal, 6, 10
red-eye, flash, 7
regulatory information, 9
repair, 1
reset camera, 6
review button, 1
reviewing pictures/videos
 after taking, 1
 as you take them, 2
 deleting, 2
 protecting, 3
 slide show, 9
running a slide show, 9

S

scene modes, 4
 backlight, 4
 beach, 4
 candle light, 4
 fireworks, 4
 flower, 4
 landscape, 4
 manner/museum, 4
 night landscape, 4
 night portrait, 4
 panorama, 10
 portrait, 4
 self-portrait, 5
 snow, 4

stage, 5
sunset, 4
text, 4

SCN (scene), 3
SD/SDHC card
 inserting, 3
 printing from, 4
 storage capacities, 4
select multiple pictures/videos, 12
self-portrait, 5
self-timer, 9
service and support telephone
 numbers, 2

setting
 about this camera, 6
 advanced digital zoom, 5
 AF control, 2
 camera sounds, 5
 capture frame grid, 4
 color mode, 2
 date and time, 2
 date stamp, 4
 exposure bracketing, 3
 exposure metering, 3
 flash, 7
 focus zone, 3
 image stabilizer, 5
 image storage, 4
 LCD brightness, 4
 orientation sensor, 5
 picture size, 1
 picture taking modes, 3
 quickview, 5
 reset camera, 6

- self-timer, 9
- sharpness, 3
- sound volume, 5
- tag, 4
- video out, 6
- video size, 1
- white balance, 2
- sharpness, 3
- shutter
 - button, 1
 - priority, 11
 - problems, 2
 - self-timer delay, 9
 - speed, 11
- single AF, 2
- slide show
 - continuous loop, 10
 - problems, 2
 - running, 9
- smart capture, 3
- snow, 4
- software
 - installing, 1
 - upgrading, 4
- sound volume, 5
- sounds, camera, 5
- specifications, camera, 1
- stage, 5
- status, camera ready light, 4
- storage capacity, 4
- strap, 1
- sunset, 4
- support, technical, 1, 2

- T**
- tag
 - set, 4
- tagging
 - creating tags, 7
 - favorites, 7
 - for email, 6
 - for print, 5
 - pre-tagging, 8
- telephone support, 2
- telephoto button, 1
- television, slide show, 11
- text, 4
- time, setting, 2
- timer, shutter delay, 9
- transferring pictures, videos, 1
- trash can, deleting, 2
- troubleshooting, 1
 - camera, 1
 - camera/computer communications, 4
 - error messages, 5
 - ready light status, 4
- turning camera on/off, 2

- U**
- undelete, undo, 2
- upgrading software, firmware, 4
- URLs, Kodak web sites, 1
- USB cable, 2
- USB, A/V out, 1

- V**
- video, 3
 - action print, 9

- copying, 13
- emailing tagged, 6
- out, 6
- protecting, 3
- review icons, 14
- reviewing, 1
- size, 1
- storage capacities, 4
- transfer, 1
- viewing, 1
- video bookmarks, 8
- viewing
 - by multi-up, 12
- viewing picture/video
 - after taking, 2, 1
- volume, adjusting, 5

W

- warranty, 6
- WEEE, 10
- white balance, 2
- wide angle button, 1
- WINDOWS OS-based computers
 - installing software, 1

Z

- zoom
 - digital, 5
 - optical, 5

Free Manuals Download Website

<http://myh66.com>

<http://usermanuals.us>

<http://www.somanuals.com>

<http://www.4manuals.cc>

<http://www.manual-lib.com>

<http://www.404manual.com>

<http://www.luxmanual.com>

<http://aubethermostatmanual.com>

Golf course search by state

<http://golfingnear.com>

Email search by domain

<http://emailbydomain.com>

Auto manuals search

<http://auto.somanuals.com>

TV manuals search

<http://tv.somanuals.com>