Kodak EasyShare C310/CD40 digital camera



User's guide

www.kodak.com

For interactive tutorials, www.kodak.com/go/howto

For help with your camera, www.kodak.com/go/c310support or
www.kodak.com/go/cd40support



Eastman Kodak Company
Rochester, New York 14650

© Eastman Kodak Company, 2005

All screen images are simulated.

Kodak, EasyShare, and Retinar are trademarks of Eastman Kodak Company.

P/N 4J4295_en

Front view

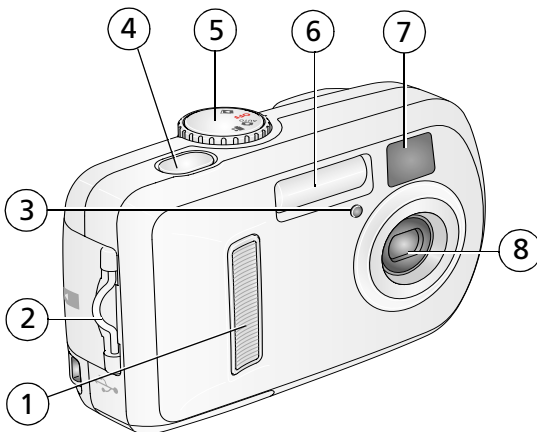

- | | |
|--------------------------|-------------------|
| 1 Grip | 5 Mode dial/Power |
| 2 Strap post | 6 Flash unit |
| 3 Self Timer/Video light | 7 Viewfinder lens |
| 4 Shutter button | 8 Lens |

Back view

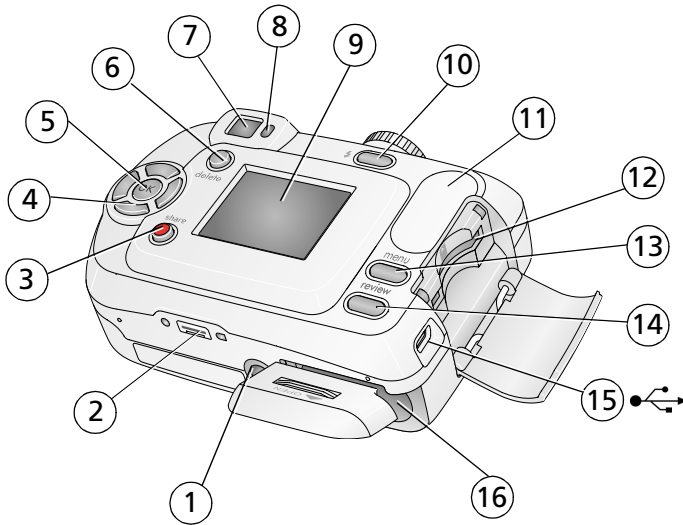







- | | |
|--|--|
| 1 Tripod socket | 9 Camera screen
(LCD: liquid crystal display) |
| 2 Dock connector | 10 Flash/Status  button |
| 3 Share button | 11 Grip |
| 4 Controller buttons (4)     | 12 Slot for optional SD/MMC card |
| 5 OK button | 13 Menu button |
| 6 Delete button | 14 Review button |
| 7 Viewfinder | 15 USB (Universal Serial Bus) port  |
| 8 Ready light | 16 Battery compartment |

Table of contents

1	Setting up your camera	1
	Attaching the wrist strap	1
	Loading the batteries	1
	Turning on the camera	2
	Setting the date/time, first time	2
	Setting the language and date/time, other times	3
	Storing pictures on an SD or MMC card	3
2	Taking pictures and videos	4
	Taking a picture	4
	Using digital zoom	6
	Using the flash	7
	Reviewing pictures and videos	7
	Protecting pictures and videos from deletion	10
3	Transferring and printing pictures	12
	Installing the software	12
	Transferring pictures with the USB cable	13
	Printing pictures	14
	Dock compatibility for your camera	17
4	Doing more with your camera	18
	Putting yourself in the picture or video	18
	Running a slide show	19
	Copying pictures and videos	20
	Choosing a flash setting	22
	Changing picture-taking settings	23
	Customizing your camera	25
	Viewing picture/video information	28
	Pre-tagging for album names	28
	Sharing your pictures	31

5 Troubleshooting	36
Camera problems.....	36
Camera/computer communications.....	40
LCD screen messages	41
Camera ready light status.....	44
6 Getting help	46
Helpful Web links.....	46
Software help.....	46
Telephone customer support	46
7 Appendix	49
Camera specifications	49
Storage capacities	52
Power-saving features.....	53
Important safety instructions	53
Battery information	55
Upgrading your software and firmware.....	56
Additional care and maintenance	56
Warranty.....	57
Regulatory compliance	59

1

Setting up your camera

Attaching the wrist strap

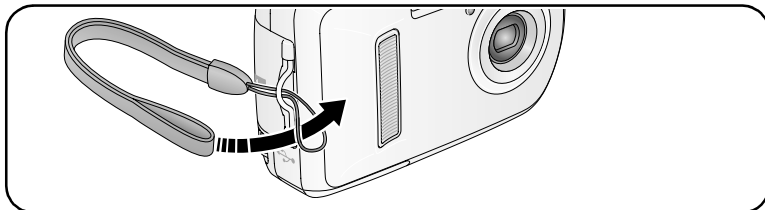

Loading the batteries

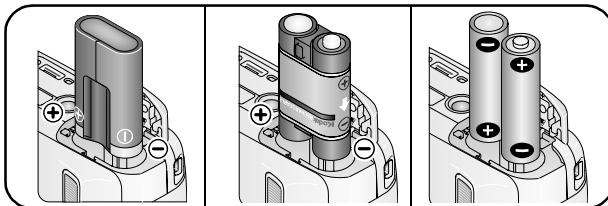
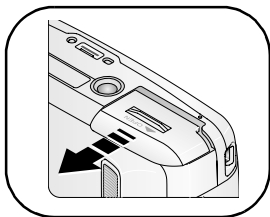

CRV3 lithium
(non-rechargeable)

Ni-MH KAA2HR
(rechargeable)

2-AA lithium, Ni-MH,
or oxy-alkaline AA

For information on replacing batteries and extending battery life, see [page 55](#).

Turning on the camera

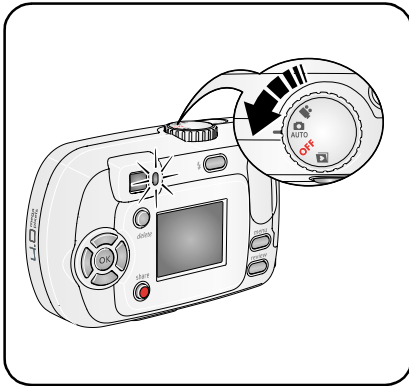

Setting the date/time, first time

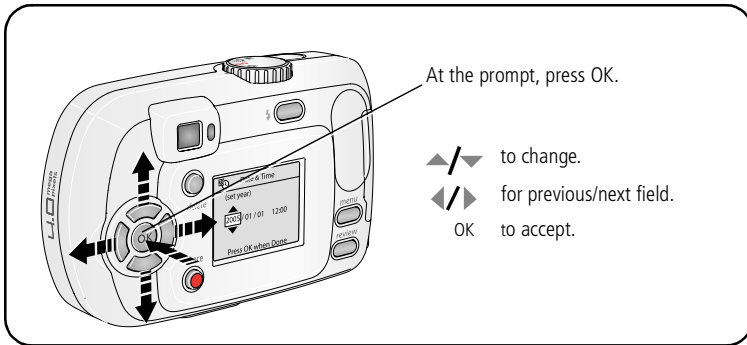

Setting the language and date/time, other times

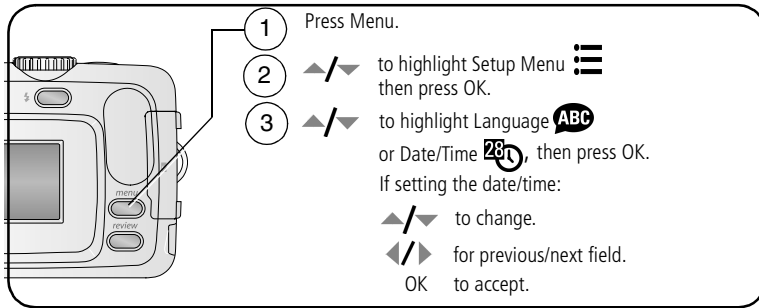

Storing pictures on an SD or MMC card

Your camera has 16 MB of internal memory. You can purchase an SD or MMC card to conveniently store more pictures and videos.

NOTE: We recommend Kodak SD and MMC cards. When using the card for the first time, format it in this camera before taking pictures (see [page 27](#)).

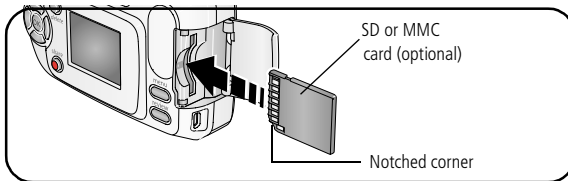

CAUTION:

A card can only be inserted one way; forcing it may cause damage. Inserting or removing a card when the Ready light is blinking may damage pictures, card, or camera.

See [page 52](#) for storage capacities. Purchase SD or MMC cards at a dealer of Kodak products or www.kodak.com/go/c310accessories or www.kodak.com/go/cd40accessories

2

Taking pictures and videos

Taking a picture

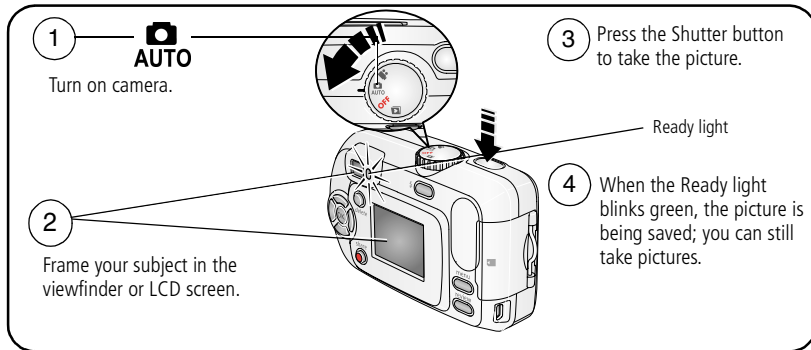

Taking a video

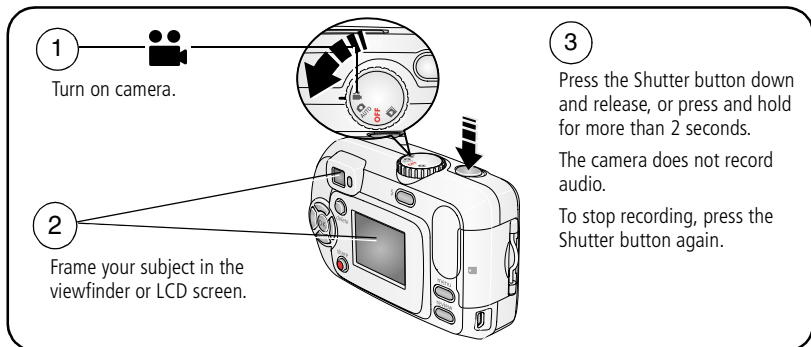

Reviewing the picture or video just taken

After you take a picture or video, the camera LCD screen displays a Quickview for approximately 5 seconds.

While the picture or video and  are displayed:

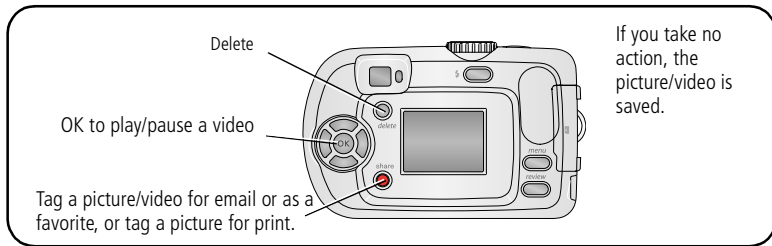

To view pictures and videos anytime, see [page 7](#).

Using the camera LCD screen as a viewfinder

IMPORTANT: *The Liveview feature significantly depletes battery power; use it sparingly.*



OK button

- 1 Turn the Mode dial to any Still mode.
- 2 Press the OK button to turn on the camera screen.
- 3 Frame your subject in the camera screen.
- 4 Press the Shutter button to take the picture.
- 5 To turn off the LCD screen, press the OK button.

To make the LCD screen turn on whenever the camera is on, see [Liveview, page 25](#)

Picture/video capture screens

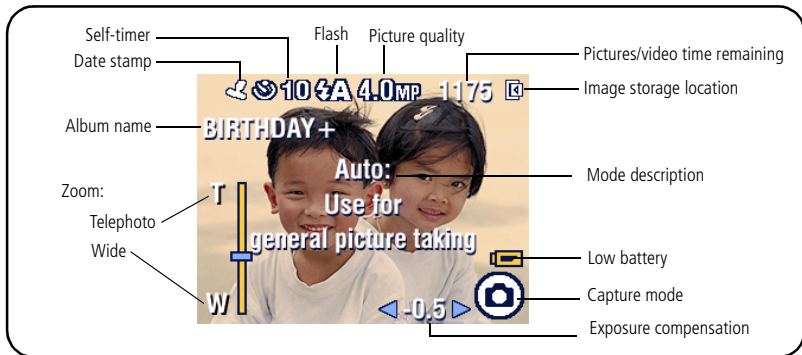

Using digital zoom

Use digital zoom in any Still mode to get up to 5X closer to your subject.

IMPORTANT: *You may notice a decrease in printed image quality when using digital zoom. The blue slider on the zoom indicator pauses and turns red when the picture quality reaches the limit for an acceptable 4 x 6 in. (10 x 15 cm) print.*

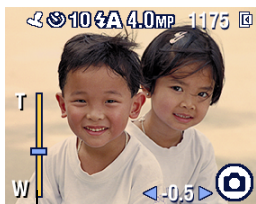

Zoom indicator

- 1 Press the OK button to turn on the LCD screen, then press ▲ to zoom in.

The LCD screen displays the zoomed image and the zoom indicator.

- 2 Press ▲/▼ to zoom in and out.
- 3 Press the Shutter button to take the picture.

To turn off digital zoom, from the lowest setting, press ▼.

NOTE: You cannot use digital zoom for video recording.

Digital zoom is available only when Liveview is turned on. (See [page 25](#).)

Using the flash

Use the flash when you take pictures at night, indoors, or outdoors in heavy shadows. Flash is effective between 2.6 - 7.9 ft (0.8 - 2.4 m). You can only change the flash setting in Still modes.

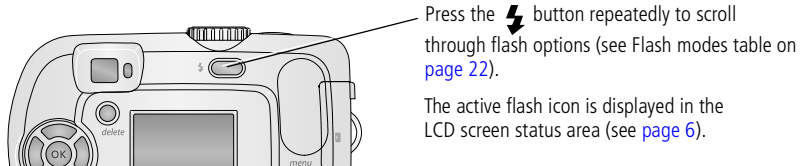

To change the flash settings, see [page 22](#).

Reviewing pictures and videos

Press the Review button to view and work with your pictures and videos.

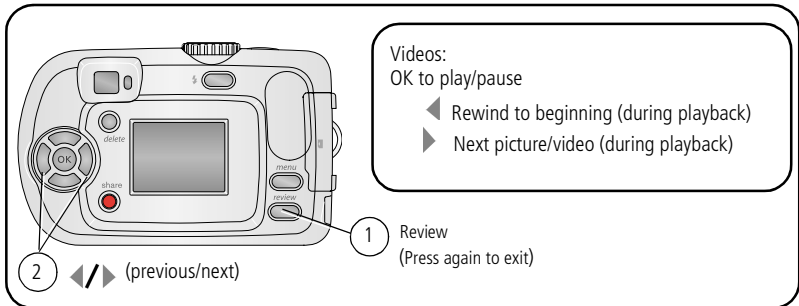

To save battery power, use the optional Kodak EasyShare camera or printer dock. (See www.kodak.com/go/c310accessories or www.kodak.com/go/cd40accessories.)

NOTE: Pictures taken at 3.5 MP (3:2) quality setting are displayed at a 3:2 aspect ratio with a black bar at the top of the screen.

What the review icons mean

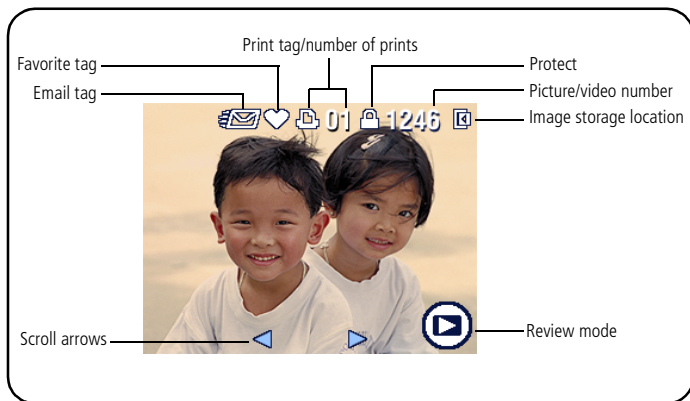

Magnifying a picture during review

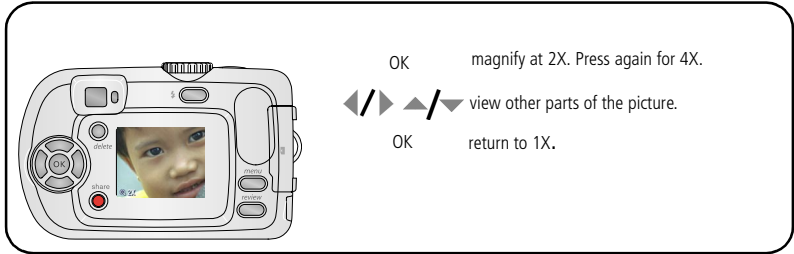

Viewing multi-up (thumbnails) during review

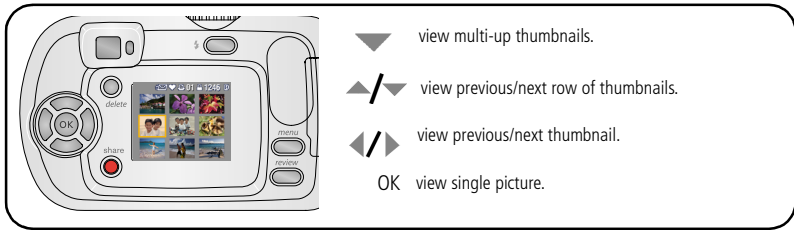

Protecting pictures and videos from deletion

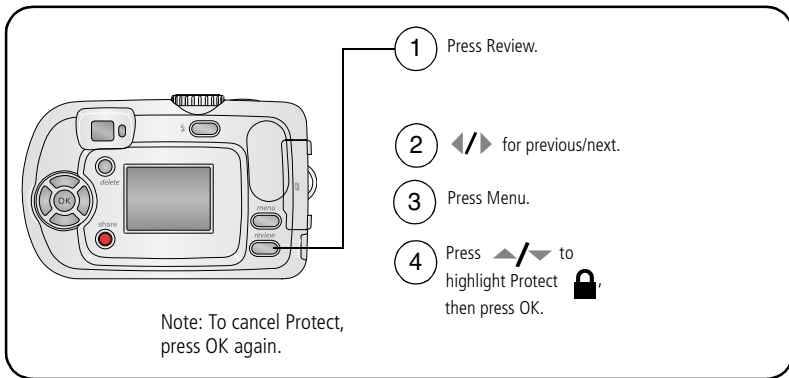

The picture or video is protected and cannot be deleted. The Protect icon  appears with the protected picture or video.

Press the Menu button to exit.



CAUTION:

Formatting internal memory or an SD or MMC card deletes all (including protected) pictures, videos. (Formatting internal memory also deletes email addresses, album names, and favorites. To restore them, see EasyShare software Help.)

Deleting pictures and videos

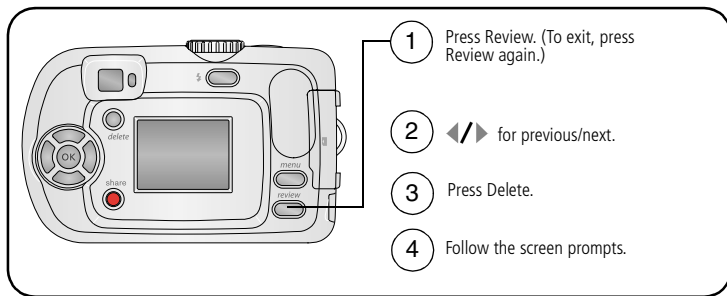

PICTURE or VIDEO—deletes the displayed picture or video.

EXIT—exits the Delete screen.

ALL—deletes all pictures and videos from your current storage location.

NOTE: To delete protected pictures and videos, remove protection before deleting.

3

Transferring and printing pictures

Installing the software



CAUTION:

Install Kodak EasyShare software *before* connecting the camera or optional dock to the computer. Failure to do so may cause the software to load incorrectly.

- 1 Close all software applications that are open on your computer (including anti-virus software).
- 2 Place the Kodak EasyShare software CD into the CD-ROM drive.
- 3 Load the software:

Windows OS—if the install window does not appear, choose Run from the Start menu and type **d:\setup.exe** where **d** is the drive letter that contains the CD.

Mac OS X—double-click the CD icon on the desktop, then click the Install icon.

- 4 Follow the on-screen instructions to install the software.

Windows OS—select Complete to automatically install the most commonly used applications. Select Custom to choose the applications you wish to install.

Mac OS X—follow the on-screen instructions.

NOTE: When prompted, register your camera and software. Registering lets you sign up for information that keeps your system up-to-date. To register later, visit www.kodak.com/go/register.

- 5 If prompted, restart the computer. If you turned off anti-virus software, turn it back on. See the anti-virus software manual for details.

For information on the software applications included on the Kodak EasyShare software CD, click the Help button in the Kodak EasyShare software.

Transferring pictures with the USB cable

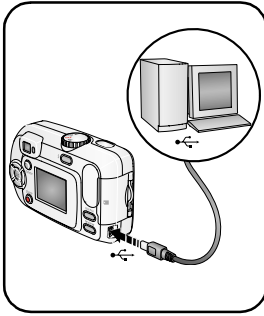

- 1 Turn off the camera.
- 2 Plug the labeled end of the USB cable (model U-8) into the labeled USB port on your computer. See your computer user's guide for details.
- 3 Plug the other end of the USB cable into the labeled USB port on the camera.
- 4 Turn on the camera.

Kodak EasyShare software opens on your computer. The software prompts you through the transfer process.

NOTE: Visit www.kodak.com/go/howto for an online tutorial on connecting.

Also available for transferring

You can also use these Kodak products to transfer your pictures and videos.

- Kodak EasyShare camera dock, Kodak EasyShare printer dock (see [page 17](#))
- Kodak multi-card reader, Kodak SD multimedia card reader-writer

Purchase these and other accessories at a dealer of Kodak products or www.kodak.com/go/c310accessories or www.kodak.com/go/cd40accessories

Printing pictures

Printing with a Kodak EasyShare printer dock

Dock your camera to the Kodak EasyShare printer dock and print directly—with or without a computer. Purchase this and other accessories at a dealer of Kodak products or www.kodak.com/go/c310accessories or www.kodak.com/go/cd40accessories

Direct printing with a PictBridge enabled printer

Your camera is compatible with PictBridge technology, so you can print directly to PictBridge enabled printers. You need:

- Camera with fully charged batteries, or with optional Kodak 3-volt AC adapter
- PictBridge enabled printer
- USB cable (may be sold separately)

Connecting the camera to a PictBridge enabled printer

- 1 Turn off the camera and printer.
- 2 Optional: If you have a Kodak 3-volt AC adapter (optional accessory), plug it into the camera and into an electrical outlet.

IMPORTANT: *Do not use the AC adapter included with the EasyShare camera dock or printer dock to power your camera.*

- 3 Connect the appropriate USB cable from the camera to the printer. (See your printer user guide or www.kodak.com/go/c310accessories or www.kodak.com/go/cd40accessories for details.)

Printing from a PictBridge enabled printer

- 1 Turn on the printer. Turn on the camera.

The PictBridge logo is displayed, followed by the current picture and menu. (If no pictures are found, a message is displayed.) If the menu interface turns off, press any button to redisplay it.

- 2 Press **▲/▼** to choose a printing option, then press the OK button.

Current Picture	Press ◀/▶ to choose a picture. Choose the number of copies.
Tagged Pictures	If your printer is capable, print pictures that you tagged for printing and choose a print size.
Index Print	Print thumbnails of all pictures. This option requires one or more sheets of paper. If the printer is capable, choose a print size.
All Pictures	Print all pictures in internal memory, on a card, or in Favorites. Choose the number of copies.
Image Storage	Access internal memory, a card, or Favorites.

NOTE: During direct printing, pictures are not permanently transferred or saved to the computer or printer. To transfer pictures to your computer, see [page 12](#). In Favorites mode, the current favorite picture is displayed.

Disconnecting the camera from a PictBridge enabled printer

- 1 Turn off the camera and printer.
- 2 Disconnect the USB cable from the camera and the printer.

Using a printer that is not PictBridge enabled

For details on printing pictures from your computer, click the Help button in the Kodak EasyShare software.

Ordering prints online

Kodak EasyShare Gallery (www.kodakgallery.com) is one of the many online print services offered in the Kodak EasyShare software. You can easily:

- Upload your pictures.
- Edit, enhance, and add borders to your pictures.
- Store pictures, and share them with family and friends.
- Order high-quality prints, photo greeting cards, frames, and albums—and have them delivered to your door.

Printing from an optional SD or MMC card

- Automatically print tagged pictures when you insert your card into a printer with an SD/MMC card slot. See your printer user's guide for details.
- Make prints at an SD/MMC card-capable Kodak picture maker. (Contact a location prior to visiting. See www.kodak.com/go/picturemaker.)
- Take the card to your local photo retailer for professional printing.

Dock compatibility for your camera

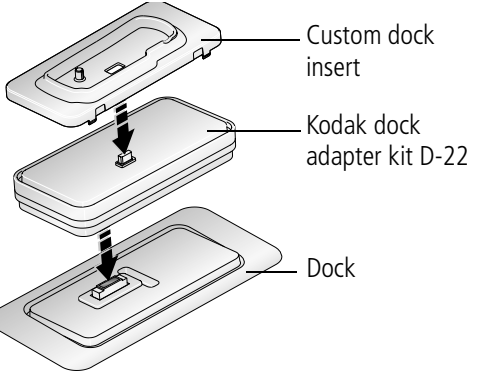
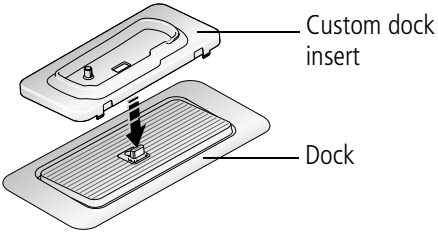
Kodak EasyShare dock	Docking configuration
<ul style="list-style-type: none"> ■ printer dock ■ printer dock plus ■ printer dock 6000 ■ camera dock 6000 	 <p>Custom dock insert</p> <p>Kodak dock adapter kit D-22</p> <p>Dock</p>
<ul style="list-style-type: none"> ■ others, including series 3 printer docks and camera docks 	 <p>Custom dock insert</p> <p>Dock</p>
<ul style="list-style-type: none"> ■ printer dock 4000 ■ camera dock II ■ LS420, LS443 camera dock 	<p>Not compatible</p>



Purchase camera docks, printer docks, and other accessories at a dealer of Kodak products or www.kodak.com/go/c310accessories or www.kodak.com/go/cd40accessories

4

Doing more with your camera

Putting yourself in the picture or video

The Self Timer creates a 10- or 2-second delay between the time you press the Shutter button and the time the picture or video is taken.

- 1 Turn the Mode dial to any Still mode for pictures, or to  for videos, then press the Menu button.
- 2 Press  to highlight Self Timer , then press the OK button.
- 3 Highlight 10 or 2 seconds, then press the OK button.
- 4 Press the Menu button to turn off the menu screen.

The Self Timer icon  and delay time appear in the status area.

- 5 Place the camera on a flat surface or use a tripod.
- 6 Compose the scene.

Press the Shutter button, then move so that you are in the scene.

If the Self Timer is set at 10 seconds, the Self Timer light blinks slowly for 8 seconds (then quickly for 2 seconds) before the picture or video is taken.

If the Self Timer is set at 2 seconds, the light blinks for 2 seconds before the picture or video is taken.

The Self Timer cancels after you take the picture, record the video, or turn off the camera.

NOTE: The video stops when you press the Shutter button or when no storage space remains.

Running a slide show

Use the Slide Show to display your pictures and videos on the LCD screen. To run a slide show on a television or on any external device, see [page 20](#).

Starting the slide show

- 1 Press the Review button, then press the Menu button.
- 2 Press $\blacktriangle/\blacktriangledown$ to highlight Slide Show , then press the OK button.
- 3 Press $\blacktriangle/\blacktriangledown$ to highlight Begin Show, then press the OK button.
Each picture and video is displayed once, in the order in which you took them.
- 4 To cancel the Slide Show, press the OK button.

Changing the slide show display interval

The default interval setting displays each picture for 5 seconds. You can set the display interval from 3 to 60 seconds.

- 1 On the Slide Show menu, press $\blacktriangle/\blacktriangledown$ to highlight Interval, then press the OK button.
- 2 Select a display interval.
To scroll through the seconds quickly, press and hold $\blacktriangle/\blacktriangledown$.
- 3 Press the OK button.
The interval setting remains until you change it.

Running a continuous slide show loop

When you turn on Loop, the slide show is continuously repeated.

- 1 On the Slide Show menu, press ▲/▼ to highlight Loop, then press the OK button.
- 2 Press ▲/▼ to highlight On, then press the OK button.

The slide show repeats until you press the OK button or until battery power is exhausted. This setting remains until you change it.

Displaying pictures and videos on a television

You can display pictures and videos on a television, computer monitor, or any device equipped with a video input using a compatible Kodak EasyShare printer dock and an optional audio/video cable (see the printer dock user's guide).

Purchase these and other accessories at a dealer of Kodak products or at www.kodak.com/go/c310accessories or www.kodak.com/go/cd40accessories

Copying pictures and videos

You can copy pictures and videos from a card to internal memory or from internal memory to a card.

Before you copy, make sure that:

- A card is inserted in the camera.
- The camera's picture storage location is set to the location **from** which you are copying. See [Image Storage, page 24](#).

Copy pictures or videos:

- 1 Press the Review button, then press the Menu button.
- 2 Press $\blacktriangle/\blacktriangledown$ to highlight Copy $\blacktriangleright\blacktriangleright$, then press the OK button.
- 3 Press $\blacktriangle/\blacktriangledown$ to highlight an option.
- 4 Press the OK button.

NOTE: Pictures and videos are copied, not moved. To remove pictures and videos from the original location after copying, delete them (see [page 10](#)).



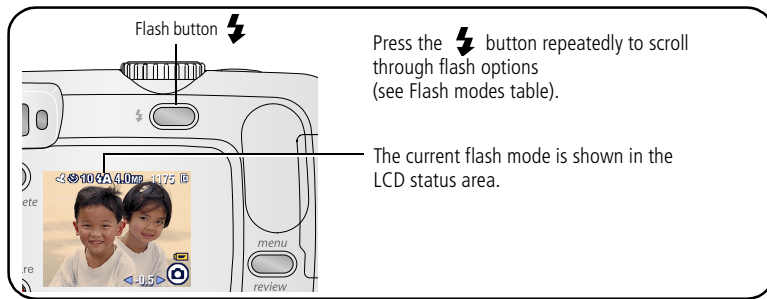

Tags that you applied for print, email, and favorites are not copied. Protection settings are not copied. To apply protection to a picture or video, see [page 10](#).

Choosing a flash setting



NOTE:



- Off and Fill flash options revert to Auto when the camera is turned off.
- When the picture is taken with Auto or Fill flash selected, the camera flashes twice: once to set the exposure and once to take the picture.



Flash modes	Flash fires
 Auto Flash	When the lighting conditions require it.
 Fill	Every time you take a picture, regardless of the lighting conditions. Use when the subject is in shadow or is "backlit" (when the sun is behind the subject).
 Red-eye	Three times: once to set the exposure, once to reduce red-eye, and once to take the picture.
 Off	Flash never fires.



Changing picture-taking settings

You can change settings to get the best results from your camera:

- 1 In any mode, press the Menu button.
- 2 Press $\blacktriangle/\blacktriangledown$ to highlight the setting you wish to change, then press the OK button.
- 3 Choose an option, then press the OK button.
- 4 Press the Menu button to exit.

Setting	Icon	Options
Self Timer Put yourself in the picture or video.		10, 2 seconds, Off. See page 18 .
Exposure Compensation (Still modes) Choose how much light enters the camera. <i>This setting remains until you turn the Mode dial.</i>		-2.0 to +2.0. If pictures are too dark, increase the value. If pictures are too light, decrease the value.

Setting	Icon	Options
<p>Picture Size (Still modes) Set picture resolution. <i>This setting remains until you change it.</i></p>		<p>4.0 MP (default)—for printing up to 20 x 30 in. (51 x 76 cm); pictures are highest resolution and largest file size.</p> <p>3.5 MP (3:2 Best)—ideal for printing 4 x 6 in. (10 x 15 cm) prints without cropping. Also for printing up to 20 x 30 in. (51 x 76 cm); some cropping may result due to the 3:2 aspect ratio.</p> <p>3.1 MP (Better)—for printing up to 11 x 14 in. (28 x 36 cm); pictures are medium resolution with smaller file size.</p> <p>2.1 MP—for printing up to 8 x 10 in. (20 x 25 cm); pictures are medium resolution with smaller file size.</p> <p>1.1 MP—for printing up to 5 x 7 in. (13 x 18 cm); for emailing, Internet, or screen display; pictures are lowest resolution and smallest file size.</p>
<p>Color Mode (Still modes) Choose color tones. <i>This setting remains until you turn the Mode dial.</i></p>		<p>Color (default)—for color pictures.</p> <p>Black & White—for black-and-white pictures.</p> <p>Sepia—for pictures with a reddish-brown, antique look.</p>
<p>Image Storage Choose an image storage location. <i>This setting remains until you change it.</i></p>		<p>Auto (default)—the camera uses the card if one is in the camera. If not, the camera uses internal memory.</p> <p>Internal Memory—the camera always uses internal memory, even if a card is installed.</p>







Setting	Icon	Options
<p>Set Album Choose Album names.</p>		<p>On or Off. Pre-select album names before you take pictures or videos. Then, all the pictures or videos you take are tagged with those album names. See page 28.</p>
<p>Video Length (Video mode) Choose the amount of recording time for videos. <i>This setting remains until you change it.</i></p>		<p>Continuous (default)— as long as there is room on the card or internal memory, or until the Shutter button is pressed. 5, 15, or 30—seconds NOTE: If the current image storage location does not have adequate space, some video length options are not displayed. See page 52 for storage capacities.</p>
<p>Setup Menu Choose additional settings.</p>		See Customizing your camera, page 25 .





Customizing your camera

Use Setup to customize your camera settings.

- 1 In any mode, press the Menu button.
- 2 Press $\blacktriangle/\blacktriangledown$ to highlight Setup , then press the OK button.
- 3 Press $\blacktriangle/\blacktriangledown$ to highlight the setting you wish to change, then press the OK button.
- 4 Choose an option, then press the OK button.

5 Press the Menu button to exit.

Setting	Icon	Options
Return Return to previous menu.		
Liveview Change the LCD screen setting so that it is always on or always off (see page 26). <i>This setting remains until you change it.</i>		On or Off.
Auto Power Off Select when you would like the camera to turn off.		3 minutes (default) 1, 3, 5, or 10 minutes
Date & Time Set the date and time. <i>This setting remains until you change it.</i>		See page 3 .
Video Out Choose the regional setting that lets you connect the camera to a television or other external device (see page 20). <i>This setting remains until you change it.</i>		NTSC (default) —used in most countries except those in Europe and China. North America and Japan use NTSC. PAL —used in Europe and China.
Date Stamp (Still modes) Imprint the date on pictures. <i>This setting remains until you change it.</i>		Turn the Date Stamp on or off, or change the date stamp format.









Setting	Icon	Options
<p>Video Date Display (Video mode)</p> <p>Display capture date and time before the video starts.</p> <p><i>This setting remains until you change it.</i></p>		<p>Choose None, or choose a date and time format.</p>
<p>Language</p> <p>Display the camera screen text in different languages.</p> <p><i>This setting remains until you change it.</i></p>		<p>See page 3.</p>
<p>Format</p> <p>Format camera memory.</p> <p> CAUTION: Formatting deletes all pictures and videos, including those that are protected. Removing a card during formatting may damage the card.</p>		<p>Memory Card—deletes everything on the card; formats the card.</p> <p>Cancel—exits without making a change.</p> <p>Internal Memory—deletes everything in internal memory including email addresses, album names, and Favorites; formats the internal memory.</p>
<p>About</p> <p>View camera and firmware information.</p>		

Viewing picture/video information

- 1 Press the Review button, then press the Menu button.
- 2 Press $\blacktriangle/\blacktriangledown$ to highlight Picture or Video Info, then press the OK button.
- 3 To view information on the next or previous picture or video, press $\blacktriangleleft/\blacktriangleright$.
- 4 Press the Menu button to exit.

Changing optional review settings

In Review mode, press the Menu button to access optional review settings.

	Magnify (pictures) (page 10)		Protect (page 11)
	Album (page 28)		Image Storage (page 24)
	Slide Show (page 19)		Picture/Video Information (page 28)
	Multi-up (page 10)		Setup Menu (page 25)
	Copy (page 20)		

Pre-tagging for album names

Use the Set Album (Still or Video) feature to pre-select album names before you take pictures or videos. Then, all the pictures or videos you take are tagged with those album names.

First—on your computer

Use Kodak EasyShare software to create album names on your computer. Then copy up to 32 album names to the album name list on your camera the next time you connect the camera to the computer. See Kodak EasyShare software Help for details.

Second—on your camera

- 1 In any mode, press the Menu button.
- 2 Press $\blacktriangle/\blacktriangledown$ to highlight Set Album , then press the OK button.
- 3 Press $\blacktriangle/\blacktriangledown$ to highlight an album name, then press the OK button. Repeat to mark pictures or videos for albums.
Selected albums are noted with a check mark.
- 4 To remove a selection, highlight an album name and press the OK button. To remove all album selections, select Clear All.
- 5 Highlight Exit, then press the OK button.
Your selections are saved. If you turn on the LCD screen, your album selection is displayed on the screen. A plus (+) after the album name means more than one album is selected.
- 6 Press the Menu button to exit.

This setting remains until you change it.

Third—transfer to your computer

When you transfer the tagged pictures and videos to your computer, Kodak EasyShare software opens and categorizes your pictures and videos in the appropriate album. See the Kodak EasyShare software Help for details.

Tagging pictures/videos for albums

Use the Album feature in Review mode to tag the pictures and videos in your camera with album names.

First—on your computer

Use Kodak EasyShare software to create album names on your computer, then copy up to 32 album names to the camera's internal memory. See Kodak EasyShare software Help for details.

Second—on your camera

- 1 Press the Review button.
- 2 Press ◀/▶ to locate a picture, then press the Menu button.
- 3 Press ▲/▼ to highlight Album , then press the OK button.
- 4 Highlight an album, then press the OK button.

The album name appears with the picture. A plus (+) after the album name means the picture was added to more than one album.

To add other pictures to the same album, press ◀/▶ to scroll through the pictures. When the picture you want is displayed, press the OK button.

To add the pictures to more than one album, repeat step 4 for each album.

- 5 To remove a selection, highlight an album name, then press the OK button. To remove all album selections, select Clear All.
- 6 Highlight Exit, then press the OK button.

Your selections are saved.



- 1 Press the Menu button to return to Review mode.

Third—transfer to your computer

When you transfer the tagged pictures and videos to your computer, Kodak EasyShare software opens and categorizes your pictures and videos in the appropriate album. See Kodak EasyShare software Help for details.

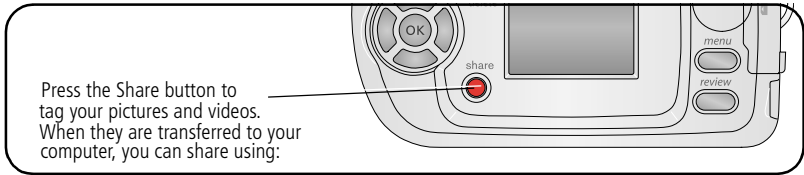



Sharing your pictures



	Pictures	Videos
 Print (page 16)	✓	
 Email (page 33)	✓	✓
 Favorites (page 33), for easy organization on your computer and for sharing on your camera	✓	✓

NOTE: Tags remain until removed. If a tagged picture or video is copied, the tag is **not** copied.

Tagging pictures for printing

- 1 Press the Share button.
- 2 Press  to locate a picture.
- 3 Press  to highlight Print , then press the OK button.*
- 4 Press  to select the number of copies (0 - 99). The default is one. Zero removes the tag for that picture.**

The Print icon  appears in the status area.

- 5 Press the OK button.

6 Press the Share button to exit.

* To tag all pictures in the image storage location, highlight Print All , press the OK button, then select the number of copies as described above. Print All is not available in Quickview.

**To remove the print tagging for all pictures in the image storage location, highlight Cancel Prts , then press the OK button. You cannot cancel prints in Quickview.

Printing tagged pictures

When you transfer the tagged pictures to your computer, the Kodak EasyShare software print screen opens. For details, click the Help button in the Kodak EasyShare software.

For more information on printing from your computer or card, see [page 32](#).

NOTE: For the best 4 x 6 in. (10 x 15 cm) prints, set the camera to 3.5MP (3:2) print quality setting.



See [page 24](#).

Tagging pictures and videos for emailing

First—on your computer



Use Kodak EasyShare software to create an email address book on your computer. Then, copy up to 32 email addresses to the camera's internal memory.

Second—tag pictures/videos on your camera

1 Press the Share button. Press   to locate a picture/video.

2 Highlight Email , then press the OK button.

3 Highlight an email address, then press the OK button.

To tag other pictures/videos with the same address, press   to scroll through the pictures. When the picture or video you want is displayed, press the OK button.

To send the pictures/videos to more than one address, repeat step 2 for each address.

Selected addresses are checked.

- 4 To remove a selection, highlight a checked address and press the OK button. To remove all email selections, highlight Clear All.
- 5 Highlight Exit, then press the OK button.
Your selections are saved. The Email icon  appears in the status area.
- 6 Press the Share button to exit.

Third—transfer and email







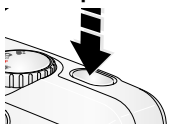

When you transfer the tagged pictures/videos to your computer, the Email screen opens and lets you send them to the addresses you specified. For details, click the Help button in the Kodak EasyShare software.

Tagging pictures as favorites

You can preserve your favorite pictures in the Favorites  section of your camera's internal memory, then share them with friends and family.

NOTE: When you transfer pictures from your camera to your computer, all pictures (including favorites) are stored on your computer at full size. Favorite pictures—smaller copies of your originals—are loaded back to your camera, so you can share and enjoy more.

Share your favorite pictures in 4 easy steps:

<p>1. Take pictures</p> 	
<p>2. Tag pictures as favorites</p> 	<ol style="list-style-type: none">1 Press the Share button. Press / to locate a picture.2 Press / to highlight Favorite , then press the OK button. <i>The Favorite icon  appears in the status area. To remove the tag, press the OK button again.</i> <p>Press the Share button to exit the menu.</p>

3. Transfer pictures to your computer

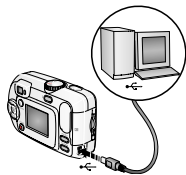



- 1 To enjoy full functionality, install and use the EasyShare software that was packaged with this camera. (See [page 12](#).)
- 2 Connect the camera to the computer using the USB cable (see [page 13](#)) or an EasyShare dock.

The first time you transfer pictures, the software helps you make choices about your favorite pictures. Then, your pictures are transferred to the computer. Favorite pictures (smaller versions of the originals) are loaded to the Favorites section of your camera's internal memory.

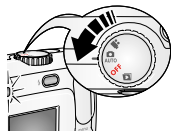
4. View favorites on your camera







- 1 Turn the Mode dial to Favorites .
- 2 Press  /  to scroll through favorites.

To exit Favorites mode, turn the Mode dial to any other position.

NOTE: The camera holds a limited number of favorites. Use Camera Favorites in the EasyShare software to customize the size of your camera Favorites  section. Videos tagged as favorites remain in the Favorites folder in the EasyShare software. For more details, click the Help button in the Kodak EasyShare software.



Optional settings

In Favorites mode, press the Menu button to access optional settings.

	Slide Show (page 19)		Picture Information (page 28)
	Multi-up (page 9)		Remove all favorites (page 35)
			Setup Menu (page 25)

NOTE: Pictures taken at the 3.5 MP (3:2) quality setting are displayed at a 3:2 aspect ratio with a black bar at the top of the screen. (See [Picture Size \(Still modes\)](#), [page 24](#).)

Removing all favorites from your camera

- 1 Turn the Mode dial to Favorites .
- 2 Press the Menu button.
- 3 Highlight , then press the OK button.

All pictures stored in the Favorites section of internal memory are removed. Favorites are restored the next time you transfer pictures to the computer.

- 4 Press the Menu button to exit the menu.

Preventing favorites from transferring to the camera

- 1 Open the Kodak EasyShare software. Click the My Collection tab.
- 2 Go to the Albums view.
- 3 Click the Camera Favorites Album for your camera.
- 4 Click Remove Album.

The next time you transfer pictures from your camera to the computer, use the Camera Favorites Wizard/Assistant in the Kodak EasyShare software to either recreate your Camera Favorites Album or to turn off the Camera Favorites feature.

Printing and emailing favorites

- 1 Turn the Mode dial to Favorites . Press / to locate a picture.
- 2 Press the Share button.
- 3 Highlight Print  or Email , then press the OK button.

NOTE: Favorites that were taken on this camera (not imported from another source) are good for prints up to 4 x 6 in. (10 x 15 cm).

5

Troubleshooting

For step-by-step product support, visit www.kodak.com/go/c310support or www.kodak.com/go/cd40support and select Interactive Troubleshooting & Repairs.

Camera problems

Problem	Cause	Solution
Camera does not turn on.	Batteries are not installed correctly.	Install new batteries (page 1) or charge rechargeable batteries.
Camera does not turn off.	Camera has locked up.	Remove the battery, then reinsert or replace it. If the camera still does not function, contact Customer Support (page 46).
Pictures remaining number does not decrease after taking a picture.	Picture does not take up enough space to decrease the number.	The camera is operating normally. Continue taking pictures.
Short battery life with Kodak Ni-MH rechargeable digital camera batteries.	Dirt or oxidation on the battery contacts.	Wipe the contacts with a clean, dry cloth (page 55) before loading batteries in the camera.
Stored pictures are corrupted.	Card was removed or the batteries expired while the ready light was blinking.	Retake picture. Do not remove card while the ready light is blinking. Keep rechargeable batteries charged.

Problem	Cause	Solution
In Review mode, you do not see a picture (or the expected picture) on the LCD screen.	Camera may not be accessing the correct image storage location.	Check the image storage location setting (page 24).
In Review mode, a blue or black screen is displayed instead of a picture.	File format is unrecognized.	Transfer the picture to the computer (page 13).
Shutter button does not work.	Camera is not turned on.	Turn on the camera (page 2).
	Camera is processing a picture; the ready light (near the viewfinder) is blinking red.	Wait until the ready light stops blinking red before attempting to take another picture.
	Card or internal memory is full.	Transfer pictures to the computer (page 13), delete pictures from the camera (page 11), switch image storage locations (page 24), or insert a card with available memory (page 3).
	Shutter button was not pressed.	For best pictures, see page 4 .
Slide show does not run on external video device.	Video Out setting is incorrect.	Adjust the camera Video Out setting (NTSC or PAL, page 26).
	External device is set incorrectly.	See the external device's user's guide.

Problem	Cause	Solution
Picture is too light.	Subject was too close for flash.	Move so there is at least 2.6 ft (0.8 m) between camera and subject.
	Too much light.	Decrease Exposure Compensation (page 23).
Picture is not clear.	Lens is dirty.	Clean the lens (page 56).
	Subject too close when taking picture.	Move so there is at least 2.6 ft (0.8 m) between the camera and the subject.
	Subject or the camera moved while the picture was taken.	Place the camera on a flat, steady surface or use a tripod.
Picture is too dark.	Flash is not on.	Turn on the flash (page 7).
	Subject is too far away for the flash to be effective.	Move so there is no more than 7.9 ft (2.4 m) between the camera and the subject.
	Subject is in front of a bright light (backlit).	Use Fill flash (page 22) or change your position so light is not behind the subject.
	Not enough light.	Increase Exposure Compensation (page 23).
Camera does not recognize SD/MMC card.	Card may not be SD/MMC certified.	Purchase a certified SD/MMC card.
	Card may be corrupt.	Reformat the card (page 27). Caution: Formatting a card deletes all pictures and videos, including protected files.
	Card is not properly inserted in camera.	Insert a card into the slot, then push to seat (page 3).

Problem	Cause	Solution
Camera freezes up when a card is inserted or removed.	Camera detected an error when the card was inserted or removed.	Turn the camera off, then back on. Make sure the camera is turned off before inserting or removing a card.
Memory card full.	Storage is full.	Insert a new card (page 3), transfer pictures to the computer (page 13), or delete pictures (page 11).
	Maximum number of files or folders is reached (or other directory concern).	Transfer pictures to the computer (page 13), then format the card or internal memory (page 27). Caution: Formatting a card deletes all pictures and videos, including protected files.

Camera/computer communications

Problem	Cause	Solution
The computer does not communicate with the camera.	There is a problem with the configuration of the USB port on the computer.	See this file on the EasyShare software CD: USB.html Or, visit www.kodak.com/go/camerasupport
	Camera power is off.	Turn on the camera (page 2).
	Batteries are exhausted or are not charged.	Install new batteries (page 1) or charge rechargeable batteries.
	Some Advanced Power Management utilities on laptops turn off ports to save battery life.	See the Power Management section of the laptop user's guide to disable this feature.
	USB cable is not securely connected.	Connect cable to camera and computer port (page 13).
	Software is not installed.	Install the software (page 12).
	Software is installed incorrectly.	Disconnect the USB cable. Close all open applications. Re-install the software (page 12).
	Too many applications are running on the computer.	Disconnect camera from the computer. Close all software applications, reconnect camera.
	The Battery Monitor or similar software runs constantly.	Close that software before starting the Kodak software.

Problem	Cause	Solution
Cannot transfer pictures. (The Add New Hardware Wizard cannot locate drivers.)	Software is not installed.	Disconnect USB cable. (If using camera dock or printer dock, disconnect cable and remove camera from dock). Close all open applications. Re-install the software (page 12).
	Software is installed incorrectly.	Disconnect the USB cable. Close all open applications. Re-install the software (page 12).

LCD screen messages

Message	Cause	Solution
No images to display	There are no pictures in the current image storage location.	Change image storage location setting (page 24).
Memory card requires formatting	Card is corrupted or formatted for another digital camera.	Insert a new card (page 3) or format the card (page 27). Caution: Formatting a card deletes all pictures and videos, including protected files.
Memory card cannot be read (Please format memory card or insert another card)		
Only one USB connection allowed. Disconnect cable or rem. (remove) camera from dock.	USB cable is connected to camera while docked.	Unplug the USB cable from the camera.

Message	Cause	Solution
Internal memory requires formatting	Camera internal memory is corrupted.	Format the internal memory (page 27). Caution: Formatting deletes all pictures and videos, including protected files. (Formatting internal memory also deletes email addresses, album names, and Favorites. To restore them, see the Kodak EasyShare software Help.)
Internal memory cannot be read (Please format internal memory)		
No memory card (Files not copied)	There is no card in the camera. Pictures were not copied.	Insert a card (page 3).
Not enough space to copy files (Files not copied)	There is not enough space in the image storage location you are copying to (internal memory or the card).	Delete pictures from the image storage location you are copying to (page 11), or insert a new card (page 3).
Memory card is locked (Insert new memory card)	Card is write-protected.	Insert a new card (page 3), move the switch on the card to unlock the card, or change the image storage location to internal memory (page 24).
Read-only memory card. Remove write protection to capture or write to card.		

Message	Cause	Solution
Memory card is unusable (Insert new memory card)	Card is slow, corrupted, or unreadable.	Insert a new card (page 3) or format the card (page 27). Caution: Formatting a card deletes all pictures and videos, including protected files.
Date and time have been reset	This is the first time you turned on the camera; or the batteries have been removed for an extended period of time; or the batteries are exhausted.	Reset the clock (page 3).
No address book on camera (Connect with computer to import address book)	No Email addresses appear because there is no address book.	Create and copy address book from computer. See the Kodak EasyShare software Help.
No album names on camera (Connect with computer to import album names)	Album names have not been copied to the camera from the computer.	Create and copy album names from computer. See the Kodak EasyShare software Help.
Can only mark image with 32 album names. Only the first 32 album names will be saved	The maximum number of album names (32) have been associated with an image. NOTE: Albums previously associated with an image persist even though they may not be contained in current album file on camera.	Delete one or more album names associated with the image (page 29).

Message	Cause	Solution
High camera temperature. (Camera will be turned off.)	Internal temperature of the camera is too high for the camera to operate. The viewfinder light glows red and the camera turns off.	Leave the camera off until it's cool to the touch, then turn it back on. If the message reappears, contact Customer Support (page 46).
Unrecognized file format	Camera cannot read the picture format.	Transfer the picture to the computer (page 13), or delete it (page 11).
Camera error #XXXX. See user's guide.	An error is detected.	Turn the Mode dial off, then back on. If the message reappears, contact Customer Support (page 46).

Camera ready light status

Status	Cause	Solution
Ready light does not turn on and the camera does not work.	Camera is not turned on.	Turn on the camera (page 2).
	Batteries are exhausted or are not charged.	Install new batteries (page 1) or charge rechargeable batteries.
	Mode dial was on when batteries were reloaded.	Turn Mode dial off, then back on.
Ready light blinks green.	Picture is being processed and saved to the camera.	Camera is operating normally.
Ready light blinks amber.	Flash is not charged.	Wait. Resume picture taking when the light stops blinking and turns green.
	Camera is initializing.	

Status	Cause	Solution
Ready light blinks red and camera turns off.	Batteries are low or exhausted.	Install new batteries (page 1) or charge rechargeable batteries.
Ready light glows steady red.	Camera's internal memory or card is full.	Transfer pictures to the computer (page 13), delete pictures from the camera (page 11), switch image storage locations (page 24), or insert a card with available memory (page 3).
	Camera processing memory is full.	Wait. Resume picture taking when the light turns green.
	Card is read-only.	Change the image storage location to internal memory (page 24), or use a different card.
Ready light glows steady green.	Camera is on; ready to take a picture or video.	Camera is operating normally.

6

Getting help

Helpful Web links

Help with your camera	www.kodak.com/go/c310support www.kodak.com/go/cd40support
Help with Windows operating system and working with digital pictures	www.kodak.com/go/pcbasics
Download the latest camera software and firmware	www.kodak.com/go/c310downloads www.kodak.com/go/cd40downloads
Optimize your printer for truer, more vibrant colors	www.kodak.com/go/onetouch
Get support for cameras, software, accessories, more	www.kodak.com/go/support
Purchase camera accessories	www.kodak.com/go/c310accessories www.kodak.com/go/cd40accessories
Register your camera	www.kodak.com/go/register
View online tutorials	www.kodak.com/go/howto

Software help

Click the Help button in the Kodak EasyShare software. Also, see the tutorial on the CD for help with connecting your camera to a computer.

Telephone customer support

If you have questions concerning the operation of the software or camera, you may speak with a customer support representative.

Before you call

Have the camera, camera dock, or printer dock connected to your computer. Be at your computer, and have the following information available:

- Operating system
- Processor speed (MHz)
- Computer model
- Amount of memory (MB)
- Exact error message you received
- Version of Kodak EasyShare software CD
- Camera serial number

NOTE: See next page for customer support numbers.

Australia	1800 147 701
Austria	0179 567 357
Belgium	02 713 14 45
Brazil	0800 150000
Canada	1 800 465 6325
China	800 820 6027
Denmark	3 848 71 30
Ireland	01 407 3054
Finland	0800 1 17056
France	01 55 1740 77
Germany	069 5007 0035
Greece	00800 44140775
Hong Kong	800 901 514
India	91 22 617 5823
Italy	02 696 33452
Japan	03 5540 9002
Korea	00798 631 0024

Netherlands	020 346 9372
New Zealand	0800 440 786
Norway	23 16 21 33
Philippines	1 800 1 888 9600
Poland	00800 4411625
Portugal	021 415 4125
Singapore	800 6363 036
Spain	91 749 76 53
Sweden	08 587 704 21
Switzerland	01 838 53 51
Taiwan	0800 096 868
Thailand	001 800 631 0017
Turkey	00800 448827073
United Kingdom	0870 243 0270
United States	1 800 235 6325 585 781 6231 (toll)
International Toll Line	+44 131 458 6714
International Toll Fax	+44 131 458 6962

For the most up-to-date listings, visit: <http://www.kodak.com/go/dfiswwcontacts>

7

Appendix

Camera specifications

For more specifications, visit www.kodak.com/go/c310support or www.kodak.com/go/cd40support.

Kodak EasyShare C310/CD40 digital camera	
CCD (charge-coupled device)	
CCD	1/2.5 in. CCD, 4:3 aspect ratio
Output image size	2304 x 1728 (4.0 M) pixels 2304 x 1536 (3.5 M) pixels 2048 x 1536 (3.1 M) pixels 1664 x 1248 (2.1 M) pixels 1216 x 912 (1.1 M) pixels
Displays	
Color display	1.6 in. (4 cm) color hybrid LCD, 220 x 279 (61K) pixels
Preview	Frame rate: 20 fps; Field-of-view: 99%.
Lens	
Taking lens	Aspheric all-glass Kodak Retinar lens, f/4.5 35 mm (35 mm equivalent)
Focus system	Fixed focus. Working range: 0.85 m to infinity
Digital zoom	1.0X–5X with 0.2X step Not supported for movie capture
Lens barrier	Integrated in lens barrel
Exposure	
Exposure metering	TTL-AE, Center-weighted

Kodak EasyShare C310/CD40 digital camera	
Exposure compensation	+/-2.0 EV with 0.5 EV step
Shutter speed	Mechanical with CCD electrical Auto: 1/2 - 1/2000 sec.
ISO speed	Auto: 100 to 400
Flash	
Electronic flash	Guide no. 9 (@ ISO 100) Auto flash by pre-flash Working range @ ISO 140: 0.8 - 2.4 m
Flash modes	Auto, Fill, Red-eye, Off
Capture	
Capture modes	Auto, Video
Video capture	QVGA (320 x 240) @ 20 fps
Image file format	Still: EXIF 2.2 (JPEG compression)
Image storage	Optional MMC or SD Card  . (The SD logo is a trademark of the SD Card Association.)
Internal storage capacity	16 MB internal memory/13 MB available for image storage (1 MB equals one million bytes)
Review	
Quickview	Yes
Video output	NTSC or PAL, selectable via dock connector

Kodak EasyShare C310/CD40 digital camera	
Power	
2 Kodak oxy-alkaline digital camera batteries AA ZR6 (non-rechargeable); 2-AA lithium digital camera batteries; 2 Kodak Ni-MH rechargeable digital camera batteries AA; 1 Kodak lithium digital camera battery CRV3 (non-rechargeable); 1 Kodak Ni-MH rechargeable digital camera battery KAA2HR	
Communication with computer	
USB 2.0 (PIMA 15740 protocol), via USB cable Model U-8, EasyShare camera dock or printer dock	
Other features	
PictBridge support	Yes
Self-timer	10 seconds, 2 seconds selectable
Auto power off	Selectable 1, 3, 5, 10 minutes
Color modes	Color, Black & White, Sepia
Date stamp	None, YYYY/MM/DD, MM/DD/YYYY, DD/MM/YYYY
Tripod mount	1/4 inch
Operating temperature	32-104 [°] F (0-40 [°] C)
Size	4.1 in. (103.5 mm) x 2.6 in. (65 mm) x 1.4 in. (35 mm) @ power off
Weight	4.7 oz (134 g) without battery or card

Storage capacities

Actual storage capacity varies depending on subject composition, card brand, and other factors. You may be able to store more or fewer pictures and videos. Favorites take up additional space in internal memory.

Picture storage capacity

	Number of pictures				
	4.0 MP	3.5 MP (3:2)	3.1 MP	2.1 MP	1.1 MP
16 MB internal memory	16	18	20	29	48
16 MB SD or MMC	19	21	24	34	56
32 MB SD or MMC	38	43	47	68	112
64 MB SD or MMC	77	85	95	136	223
128 MB SD or MMC	153	171	190	272	447
256 MB SD or MMC	307	341	379	543	893

Video storage capacity

	Minutes/seconds of video
	QVGA (320 x 240)
16 MB internal memory	35 sec.
16 MB SD or MMC	40 sec.
32 MB SD or MMC	1 min. 21 sec.
64 MB SD or MMC	2 min. 42 sec.
128 MB SD or MMC	5 min. 25 sec.
256 MB SD or MMC	10 min. 50 sec.

Power-saving features

If no action for	The camera	To turn it back on
1 minute	Screen turns off.	Press any button.
3 minutes or select 1, 5, or 10 minutes	Enters auto power off.	Turn the Mode dial off and on again.

Important safety instructions

Using this product

- Read and follow these instructions before using Kodak products. Always follow basic safety procedures.
- Use only a USB 2.0 certified computer equipped with a current-limiting motherboard. Contact your computer manufacturer if you have questions.
- The use of an accessory attachment that is not recommended by Kodak, such as an AC adapter, may cause fire, electric shock, or injury.
- If using this product in an airplane, observe all instructions of the airline.



CAUTION:

Do not disassemble this product; there are no user-serviceable parts inside. Refer servicing to qualified service personnel. Do not expose this product to liquid, moisture, or extreme temperatures. Kodak AC adapters and battery chargers are intended for indoor use only. The use of controls, adjustments, or procedures other than those specified herein may result in exposure to shock and/or electrical or mechanical hazards. If the LCD breaks, do not touch the glass or liquid. Contact Kodak Support.

Battery safety and handling



CAUTION:

When removing batteries, allow them to cool first; batteries may be hot.

- Read and follow all warnings and instructions supplied by the battery manufacturer.
- Use only batteries that are approved for this product.
- Keep batteries out of the reach of children.
- Do not allow batteries to touch metal objects, including coins. Otherwise, a battery may short circuit, discharge energy, become hot, or leak.
- Do not disassemble, install backward, or expose batteries to liquid, moisture, fire, or extreme temperature.
- Replace all batteries of a set at the same time. Do not mix new batteries with used ones. Do not mix rechargeable and non-rechargeable batteries. Do not mix lithium, Ni-MH, and Ni-Cd batteries together. Do not mix batteries of different chemistry types, grades, or brands. Failure to observe this precaution may cause leakage.
- Remove batteries when the product is stored for an extended period of time. In the unlikely event that battery fluid leaks inside the product, contact your local Kodak Customer Service representative.
- In the unlikely event that battery fluid leaks onto your skin, wash immediately with water and contact your local health provider. For additional health-related information, contact your local Kodak Customer Service representative.
- Dispose of batteries according to local and national regulations.
- Do not charge non-rechargeable batteries.

For more information on batteries, see

www.kodak.com/global/en/service/batteries/batteryUsage.jhtml

Battery information

Battery life for Kodak C-series digital cameras

Use the following batteries. Actual battery life may vary based on usage.

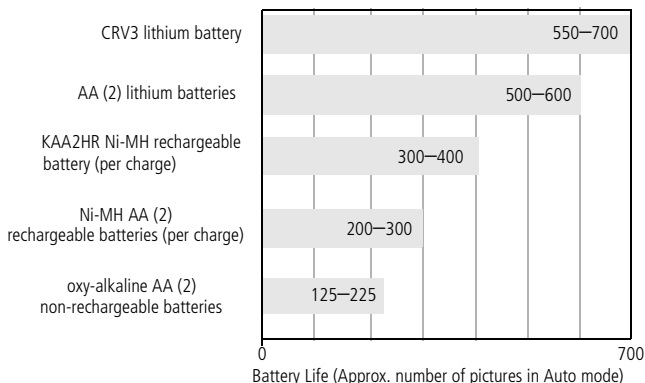

Battery life test method: CIPA

Memory card used in test: Kodak SD 128 MB memory card

We do not recommend or support alkaline batteries. For acceptable battery life, and to make sure your camera operates dependably, use the replacement batteries listed above.

Extending battery life

- Limit the following activities that quickly deplete battery power:
 - Reviewing your pictures on the camera screen (see [page 7](#))
 - Using the camera LCD screen as a viewfinder (see [page 5](#))
 - Excessive use of the flash (see [page 22](#))
- Dirt on the battery contacts can affect battery life. Wipe the contacts with a clean,

www.kodak.com/go/support

dry cloth before loading batteries in the camera.

- Battery performance is reduced at temperatures below 41°F (5°C). When using your camera in cold weather, carry spare batteries and keep them warm. Do not discard cold batteries that do not work; when they return to room temperature, they may be usable.

Visit www.kodak.com/go/c310accessories or www.kodak.com/go/cd40accessories for:

Kodak EasyShare camera dock—powers your camera, transfers pictures to your computer, and charges the available Kodak Ni-MH rechargeable digital camera battery KAA2HR.

Kodak EasyShare printer dock—powers your camera, makes 4 x 6 in. (10 x 15 cm) prints with or without a computer, transfers pictures, and charges the available Kodak Ni-MH rechargeable digital camera battery KAA2HR.

Upgrading your software and firmware

Download the latest versions of the software included on the Kodak EasyShare software CD and the camera firmware (the software that runs on the camera). Visit www.kodak.com/go/c310downloads or www.kodak.com/go/cd40downloads.

Additional care and maintenance

- If the camera has been subjected to inclement weather or you suspect water has gotten inside the camera, turn off the camera and remove the batteries and card. Allow all components to air-dry for at least 24 hours before using the camera again.
- Blow gently on the lens or camera screen to remove dust and dirt. Wipe gently with a soft, lint-free cloth or an untreated lens-cleaning tissue. Do not use cleaning solutions unless designed specifically for camera lenses. Do not allow chemicals, such as suntan lotion, to contact painted surfaces.
- Service agreements are available in some countries. Contact a dealer of Kodak products for more information.

- For digital camera disposal or recycling information, contact your local authorities. In the US, visit the Electronics Industry Alliance Web site at www.eiae.org or the Kodak Web site at www.kodak.com/go/c310support or www.kodak.com/go/cd40support

Warranty

Limited warranty

Kodak warrants Kodak EasyShare digital cameras and accessories (excluding batteries) to be free from malfunctions and defects in both materials and workmanship for one year from the date of purchase.

Retain the original dated sales receipt. Proof of the date of purchase will be required with any request for warranty repair.

Limited warranty coverage

This limited warranty will be honored only in the geographical location that Kodak digital cameras and accessories were purchased.

Kodak will REPAIR or REPLACE Kodak EasyShare digital cameras and accessories if they fail to function properly during the warranty period, subject to any conditions and/or limitations stated herein. Such repair service will include all labor as well as any necessary adjustments and/or replacement parts. Such repair or replacement is the sole remedy under this warranty.

If replacement parts are used in making repairs, these parts may be remanufactured, or may contain remanufactured materials. If it is necessary to replace the entire product, it may be replaced with a remanufactured product.

Limitations

Request for Warranty service will not be accepted without proof of date of purchase, such as a copy of the original dated Kodak EasyShare digital camera or accessory sales receipt. (Always keep the original for your records.)

This warranty does not apply to the battery(s) used in digital cameras or accessories.

www.kodak.com/go/support

This warranty does not cover circumstances beyond Kodak's control, nor problems caused by failure to follow the operating instructions in the Kodak EasyShare digital cameras and accessories User's Guides.

This warranty does not apply when failure is due to shipping damage, accident, alteration, modification, unauthorized service, misuse, abuse, use with incompatible accessories or attachments, failure to follow Kodak's operation, maintenance or repacking instructions, failure to use items supplied by Kodak (such as adapters and cables), or claims made after the duration of this warranty.

Kodak makes no other express or implied warranty for this product. In the event that the exclusion of any implied warranty is ineffective under the law, the duration of the implied warranty will be one year from the purchase date.

The option of replacement is Kodak's only obligation. Kodak will not be responsible for any special, consequential or incidental damages resulting from the sale, purchase, or use of this product, regardless of the cause. Liability for any special, consequential or incidental damages (including but not limited to loss of revenue or profit, downtime costs, loss of the use of the equipment, cost of substitute equipment, facilities or services, or claims of your customers for such damages resulting from the purchase, use or failure of the product), regardless of cause or for breach of any written or implied warranty is expressly disclaimed and excluded here from.

Your rights

Some states or jurisdictions do not allow exclusion or limitation of incidental or consequential damages, so the above limitation or exclusion may not apply to you. Some states or jurisdictions do not allow limitations on how long an implied warranty lasts, so the above limitation may not apply to you.

This warranty gives you specific rights, and you may have other rights which vary from state to state or by jurisdiction.

Outside the United States and Canada

In countries other than the United States and Canada, the terms and conditions of this warranty may be different. Unless specific Kodak warranty is communicated to the

purchaser in writing by a Kodak company, no warranty or liability exists beyond any minimum requirements imposed by law, even though defect, damage, or loss may be by negligence or other act.

Regulatory compliance

FCC compliance and advisory



Kodak EasyShare C310/CD40 digital camera

This equipment has been tested and found to comply with the limits for a Class B digital device, pursuant to Part 15 of the FCC Rules. These limits are designed to provide reasonable protection against harmful interference in a residential installation.

This equipment generates, uses, and can radiate radio frequency energy and, if not installed or used in accordance with the instructions, may cause harmful interference to radio communications. However, there is no guarantee that interference will not occur in a particular installation.

If this equipment does cause harmful interference to radio or television reception, which can be determined by turning the equipment off and on, the user is encouraged to try to correct the interference by one or more of the following measures: 1) reorient or relocate the receiving antenna; 2) increase the separation between the equipment and the receiver; 3) connect the equipment to an outlet on a circuit different from that to which the receiver is connected; 4) consult the dealer or an experienced radio/TV technician for additional suggestions.

Any changes or modifications not expressly approved by the party responsible for compliance could void the user's authority to operate the equipment. Where shielded interface cables have been provided with the product or specified additional components or accessories elsewhere defined to be used with the installation of the product, they must be used in order to ensure compliance with FCC regulation.

Canadian DOC statement

DOC Class B Compliance—This Class B digital apparatus complies with Canadian ICES-003.

Observation des normes-Class B—Cet appareil numérique de la classe B est conforme à la norme NMB-003 du Canada.

Waste Electrical and Electronic Equipment labeling



In the European Union, do not discard this product as unsorted municipal waste. Contact your local authorities or go to www.kodak.com/go/recycle for recycling program information.

Korean Class B ITE

이 기기는 가정용으로 전자파적합등록된 기기로서 주거지역에서는 물론 모든 지역에서 사용할 수 있습니다.

VCCI Class B ITE

この装置は、情報処理装置等電波障害自主規制協議会（VCCI）の基準に基づくクラスB情報技術装置です。この装置は、家庭環境で使用することを目的としていますが、この装置がラジオやテレビジョン受信機に近接して使用されると、受信障害を引き起こすことがあります。
取扱説明書に従って正しい取り扱いをして下さい。

English translation:

This is a Class B product based on the standard of the Voluntary Control Council for Interference from Information Technology Equipment (VCCI). If this is used near a radio or television receiver in a domestic environment, it may cause radio interference. Install and use the equipment according to the instruction manual.

Australian C-Tick



N137

Index

A

- AA battery, installing, 1
- About, 27
- accessories, 13
 - battery, 55
 - buying, 46
 - camera dock, 56
 - printer dock, 14, 56
 - SD/MMC card, 3
- albums, tagging pictures for, 28, 29
- alkaline batteries, warning, 1
- Australian C-Tick regulatory information, 60
- auto
 - flash, 7
 - power-down, 53

B

- batteries
 - expected life, 55
 - extending life, 55
 - loading, 1
 - types, 1, 51, 55
- battery
 - safety, 54
- battery compartment, ii
- button
 - controller, ii
 - Delete, ii
 - delete, 5
 - Flash/Status, ii
 - flash/status, 7

- Menu, ii
- Review, ii
- review, 7
- Share, ii
- shutter, i
- zoom, 6

C

- cable
 - audio/video, 20
 - USB, 13
- camera dock, 56
- camera screen, ii
 - error messages, 41
 - reviewing pictures, 7
 - reviewing videos, 7
 - turning Liveview default on/off, 26
- Canadian compliance, 60
- caring for your camera, 56
- Class B ITE, 60
- clock, setting, 2, 3, 26
- Color Mode, 24
- computer
 - connecting camera, 12, 13
 - transfer to, 12
- controller buttons, ii
- copy pictures
 - card to memory, 20
 - memory to card, 20
 - to computer via USB cable, 13
- CRV3 battery
 - loading, 1

customer support, 46
customizing camera settings, 25

D

date
 displaying on video, 27
 imprinting on pictures, 26
 setting, 26
Date and Time, 26
date setting, 2, 3
Date Stamp, 26
Delete button, ii
deleting
 during quickview, 5
 formatting precaution, 27
 from internal memory, 11
 from SD/MMC card, 11
 protecting pictures, videos, 10
digital zoom, 6
displaying slide show, 19
disposal, recycling, 57, 60
dock
 camera, 56
 printer, 14, 56
dock connector, ii
downloading pictures, 12

E

EasyShare software, 12
emailing pictures, videos, 32
error messages, 41
expected life, 55
Exposure Compensation, 23
external video device

setting video out, 26
viewing pictures, videos, 20

F

favorites
 removing, 35
 settings, 34
 tagging, 33
FCC compliance, 59
firmware
 finding version on camera, 27
firmware, upgrading, 56
flash, i
 settings, 7
Flash/Status button, ii
Format, 27
formatting internal memory/card, 27

G

grip, i, ii
guidelines, battery, 55

H

help
 camera, 36
 EasyShare software, 46
 support, 46
 web links, 46

I

Image Storage, 24
 setting storage location, 24
information
 about camera, 27
installing

batteries, 1
SD/MMC card, 3
software, 12

internal memory
formatting, 27
setting image storage location, 24
storage capacity, 52

K

Kodak digital camera batteries, 1

Kodak EasyShare software
getting help, 46
installing, 12
upgrading, 56

Kodak web sites, 46

Korean Class B ITE, 60

L

Language, 27

LCD (liquid crystal display), ii

lens, i
cleaning lens, 56

light
ready, ii, 44
Self Timer, i
video, i

Liveview, 26
turning default on/off, 26

loading
batteries, 1
SD/MMC card, 3
software, 12

M

Macintosh OS, installing software on, 12

maintenance, camera, 56

memory
inserting card, 3
internal, 24
removable card, 24
setting image storage location, 24
storage capacities, 52

Menu

button, ii

MMC card

formatting, 27
setting image storage location, 24

mode dial, i

movies. *See* videos

N

NTSC, video out setting, 26

O

OK button, ii

online prints, ordering, 16

P

PAL, video out setting, 26

PictBridge enabled printer, 14

Picture Quality, 24

pictures
checking settings, 8
copying, 20
deleting, 11
emailing tagged, 32
printing, 16
printing tagged, 31
protecting, 10
reviewing, 7

- storage capacity, 52
- tagging, 28, 29
- transfer via USB cable, 13
- power
 - auto off, 53
 - camera, 2
 - switch, i
- printer dock, 14, 56
- printing
 - from a card, 16
 - from computer, 16
 - optimizing printer, 46
 - order online, 16
 - PictBridge enabled, 14
 - tagged pictures, 16
 - with EasyShare printer dock, 14
- protecting pictures, videos, 10

Q

- quickview
 - using, 5

R

- ready light, ii, 44
- recycling, disposal, 57, 60
- red-eye, flash, 7
- regulatory information, 59, 60
 - Class B ITE, 60
- removing favorites, 35
- Return, 26
- Review button, ii
- review button, 7
- reviewing pictures
 - as you take them, 5

- camera screen, 7
 - deleting, 11
 - protecting, 10
 - slide show, 19
- reviewing videos
 - camera screen, 7
 - deleting, 11
 - protecting, 10
 - slide show, 19
- running slide show, 19

S

- safety
 - battery, 54
- SD/MMC card
 - formatting, 27
 - inserting, 3
 - printing from, 16
 - setting image storage location, 24
 - storage capacities, 52
- Self Timer, 23
 - light, i
- self timer
 - with pictures, 18
- service and support, telephone
 - numbers, 46
- Set Album, 25
- setting
 - album, 25
 - color mode, 24
 - date and time, 2, 3
 - date stamp, 26
 - date/time, 26
 - exposure compensation, 23

- flash, 7
 - image storage location, 24
 - language, 27
 - Liveview, 26
 - picture quality, 24
 - self timer, 18
 - video length, 25
 - video out, 26
 - setup mode, using, 25
 - Share button, ii
 - shutoff, auto, 53
 - shutter
 - self timer delay, 18
 - shutter button, i
 - shutter, problems, 37
 - sleep mode, 53
 - Slide Show
 - problems, 37
 - slide show
 - continuous loop, 20
 - running, 19
 - software
 - getting help, 46
 - installing, 12
 - upgrading, 56
 - specifications, camera, 49
 - status
 - camera ready light, 44
 - storage capacity, 52
 - support, technical, 46
- T**
- tagging
 - favorites, 33
 - for email, 32
 - for print, 32
 - tagging pictures
 - for albums, 28, 29
 - television, slide show, 20
 - time, setting, 2, 3, 26
 - timer, shutter delay, 18
 - tips
 - battery guidelines, 55
 - care & maintenance, 56
 - transfer, via USB cable, 13
 - trash can, deleting, 5
 - tripod socket, ii
 - troubleshooting
 - camera, 36
 - camera/computer
 - communications, 40
 - error messages, 41
 - ready light status, 44
 - turning camera on and off, 2
- U**
- upgrading software, firmware, 56
 - URLs, Kodak web sites, 46
 - USB (universal serial bus)
 - transferring pictures, 13
 - USB cable
 - camera port, ii
- V**
- VCCI compliance, 60
 - Video Date Display, 27
 - Video Length, 25
 - Video Out, 26

videos

- checking settings, 8
- copying, 20
- deleting, 11
- display date on, 27
- emailing tagged, 32
- protecting, 10
- record light, i
- reviewing, 7
- setting recording time, 25
- storage capacities, 52
- transfer to computer, 12
- viewing, 7

viewfinder, ii

- lens, i

viewing

- camera information, 27

viewing picture

- after taking, 5, 7

W

warranty, 57

WEEE

- Waste Electrical and Electronic
Equipment, 60

Windows OS-based computers

- installing software, 12

wrist strap post, i

Free Manuals Download Website

<http://myh66.com>

<http://usermanuals.us>

<http://www.somanuals.com>

<http://www.4manuals.cc>

<http://www.manual-lib.com>

<http://www.404manual.com>

<http://www.luxmanual.com>

<http://aubethermostatmanual.com>

Golf course search by state

<http://golfingnear.com>

Email search by domain

<http://emailbydomain.com>

Auto manuals search

<http://auto.somanuals.com>

TV manuals search

<http://tv.somanuals.com>