Kodak EasyShare digital picture frame



User's guide

for SV-710, SV-811, EX-811, EX-1011

www.kodak.com

For help with your picture frame, www.kodak.com/go/digitalframesupport

Kodak

Eastman Kodak Company
Rochester, New York 14650

© Eastman Kodak Company, 2007

All screen images are simulated.

Kodak and EasyShare are trademarks of Eastman Kodak Company.

Eastman Kodak Company is an authorized licensee of the CompactFlash trademark.

P/N 4J6125_en

Front View

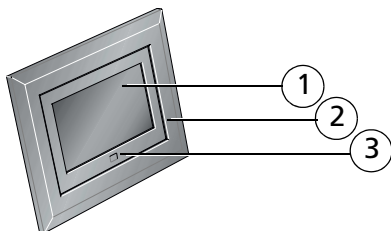

- 1 LCD screen
- 2 Faceplate
- 3 Remote control sensor

Back/Left Side View

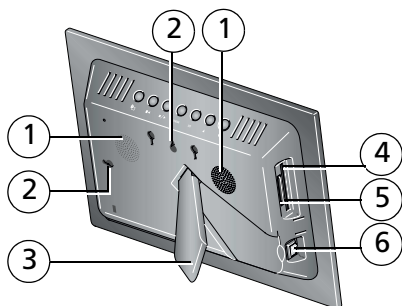

- 1 Speakers
- 2 Wall mount hangers
- 3 Frame stand
- 4 Memory card slot - CF, MD
- 5 Memory card slot - SD, MS, xD, MMC
- 6 On/Off switch
- 7 Remote control holder (removable)

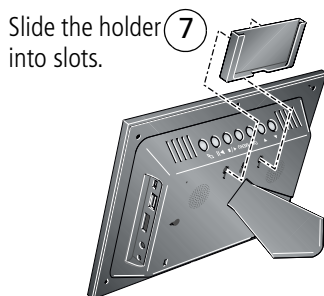

Top/Right Side View

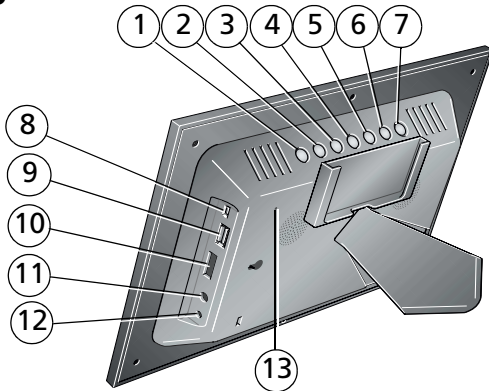





- | | | | |
|---|--|----|---|
| 1 | Picture/music toggle  | 8 | USB connector (All models, use to connect to computer; EX models, also use to connect to camera/USB device - with adapter cable.) |
| 2 | Play/Pause  | 9 | USB connector (SV models only, use to connect to camera/USB device. Not available on EX models.) |
| 3 | Stop/Back  | 10 | Volume control |
| 4 | Menu | 11 | Headphone jack  |
| 5 | OK | 12 | DC-In (12 V)  |
| 6 | Down ▼ | 13 | Reset button |
| 7 | Up ▲ | | |

Table of contents

1 Getting started	1
Installing the software.....	1
Using the remote control.....	2
Activating the remote control	2
Storing the remote control.....	2
Using the remote control buttons	3
Setting up your picture frame	4
Buttons and controls	4
Connecting the power cable.....	4
Inserting a card or camera	5
Turning on the frame.....	6
Setting your language	6
Viewing your first slide show!	6
2 Viewing pictures and videos	7
Running a slide show	7
Viewing thumbnails	7
Viewing a single picture	8
Playing a video.....	8
Choosing a different picture location	9
3 Doing more with your frame	10
Copying pictures on your frame	10
Copying between your frame and computer.....	10
Connecting to your computer	10
Copying pictures to/from your computer	11
Copying pictures from EasyShare software	11
Deleting pictures/videos	12
Selecting multiple pictures/videos	12
Selecting one at a time.....	12
Selecting all	13

Printing pictures	13
Connecting the frame to a PictBridge enabled printer.....	13
Printing from a PictBridge enabled printer.....	14
Manually changing connection mode.....	14
Playing music.....	15
4 Changing frame settings	16
Settings menus	16
Upgrading your firmware.....	18
5 Using Wi-Fi mode—EX models only	19
What are some of the wireless features of my frame?	19
Wireless networking and the Internet	19
Setting up your frame for wireless operation	19
Before you start.....	19
Perform the setup.....	20
Set up your network at a later time.....	21
Viewing pictures over your wireless network	21
Setting up your Gallery account	22
Viewing pictures from the Gallery	22
Creating My Slideshow.....	23
Copying pictures to your computer—wirelessly.....	23
Glossary of common wireless network terms.....	24
6 Troubleshooting and support	28
Picture frame problems	28
Picture frame/computer communications	28
Wireless network connection (EX models).....	29
Screen messages.....	32
7 Appendix	34
Digital frame specifications.....	34
Important safety instructions	36
Downloading your software and firmware	37

Additional care and maintenance	37
Limited warranty	38
Limited warranty coverage.....	38
Limitations	38
Your rights	39
Outside the United States and Canada.....	39
FCC compliance and advisory	40
FCC and Industry Canada	40
CE	41
Canadian DOC statement	41
Waste Electrical and Electronic Equipment labeling	41
Australian C-Tick.....	41
MPEG-4	41
MP3 Licensing.....	42

1

Getting started

Welcome to your Kodak EasyShare digital picture frame. Viewing your pictures and videos couldn't be simpler!

Installing the software

Install the software from the CD included with your frame. The software, which includes the latest version of Kodak EasyShare software, ensures the best experience when connecting the frame with your computer.

- 1 Close all software applications that are open on your computer (including anti-virus software, see the anti-virus software manual for details).
- 2 Place the EasyShare software CD into the CD-ROM drive.
- 3 Load the software. If the install window does not appear, choose Run from the Start menu and type **d:\setup.exe** where **d** is the drive letter that contains the CD.
- 4 Follow the on-screen instructions to install the software. Select Complete to automatically install the most commonly used applications, or Custom to choose the ones you wish to install.

NOTE: When prompted, take a few minutes to electronically register your picture frame and software. To register later, visit www.kodak.com/go/register.

- 5 If prompted, restart the computer. If you turned off anti-virus software, turn it back on.

Using the remote control

Activating the remote control

An activation tab protects the remote control's battery during shipment.

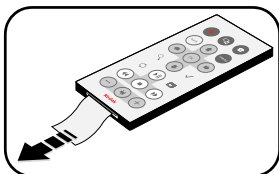

- Pull out the tab to start using the remote.

There is no need to open the battery compartment or remove the battery.

Storing the remote control

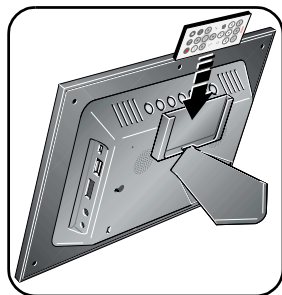

- 1 Install the remote control holder on the back of the frame ([page i](#)).
- 2 Slide the remote into the holder for convenient, out-of-the-way storage.

Using the remote control buttons

Some buttons are also on the back of the frame ([page ii](#)). They operate identically.

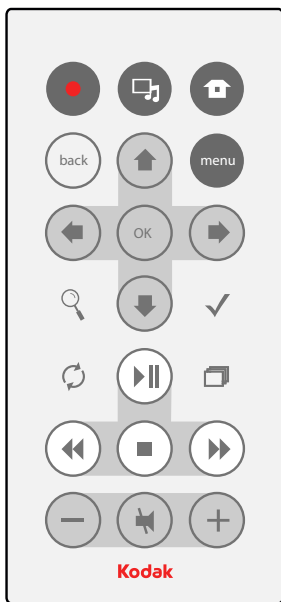



Button	Press to:
	power* turn on/off the picture frame.
	home return to the home screen.
	music/pics toggle between viewing pictures and selecting music.
	menu display the menu choices.
	back return to the previous screen. stop a slide show, display thumbnails.
	OK accept the current selection.
	4-way navigate through pictures or menus.
	zoom magnify the picture.
	rotate rotate the picture, 90° clockwise each press.
	select mark pictures for an operation.
	slide show play a slide show.
	play/pause play/pause a video or slide show.
	rewind rewind a video.
	fast forward fast forward a video.
	stop stop a video, display the first frame. stop a slide show, display thumbnails.
	volume decrease (-) or increase (+) the volume.
	mute mute audio.

* First, turn on the power switch on the frame.

Setting up your picture frame

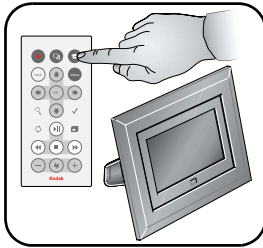
Buttons and controls



All buttons and controls described in this guide (for example: press ) are on the remote control unless otherwise noted.

Connecting the power cable

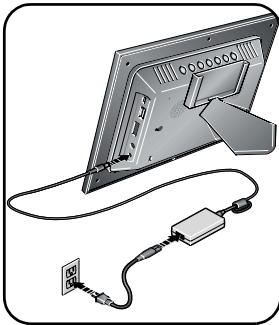

1 Plug in the power cable.

Your power cable (included with the frame) may be different from the one pictured. Use the plug that accommodates your type of power outlet.

2 Pull out and extend the stand on the frame back and place the frame on a flat, stable surface.

NOTE: Your frame is set up to display in landscape orientation .

You can turn it to portrait  but you must also change the

setting. Press Home , Settings  → Viewing options → Frame orientation. See [page 17](#).

Inserting a card or camera

- Insert a memory card.

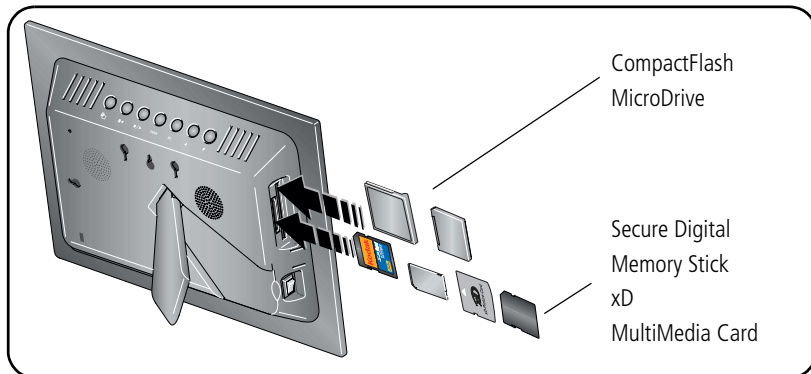

- Connect a digital camera or other USB device.

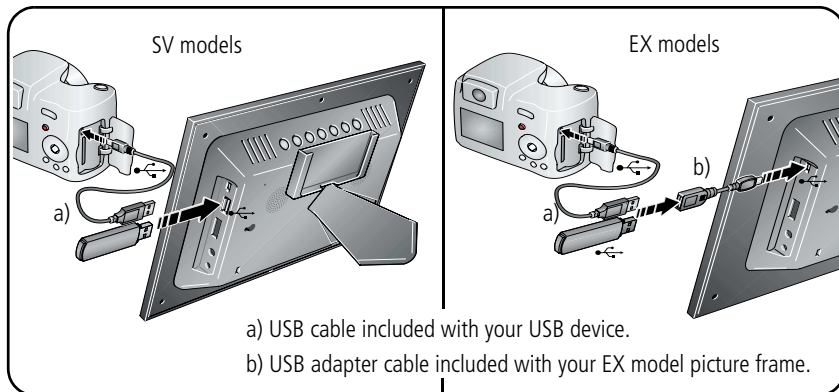

Turning on the frame

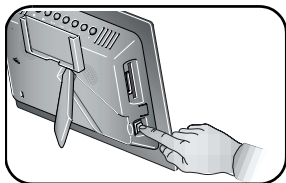



- Press the power switch to On.

NOTE: You can leave the power switch On, and use the remote control to turn the frame off and on.

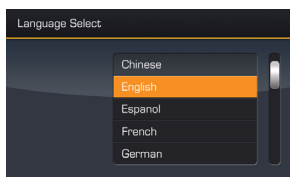

Setting your language



The language screen appears the first time you turn on your frame.

- Press   to select your language, then press OK.

To change the language at a later time, press Home

 , Settings  → Language. See [page 18](#).

Viewing your first slide show!



- A slide show starts automatically when you turn on the frame.
- The pictures/videos are displayed in the order they appear on the card or other device.

2

Viewing pictures and videos



When you turn on your frame, a slide show automatically starts. Depending on where pictures are stored in your frame or what devices are connected—the slide show plays from a memory card first, then from a USB device, and internal memory (My Frame), in that order.

Running a slide show



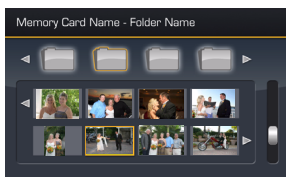

- A new slide show starts automatically when you insert a card or connect a USB device. The new slide show replaces whatever is currently displayed (slide show, thumbnails, single picture).
- A slide show plays continuously until you stop it or turn off the frame.
- To start a slide show from any selected picture (in thumbnail or single view), press .
- You can change the slide duration and transition style (see [page 17](#)).

Viewing thumbnails







- To view your pictures as multi-up thumbnails, press  when a slide show is playing or from a single view.
- To navigate through the thumbnails, press .
- Videos are marked with .

Viewing a single picture

- To view a single, full-screen picture, highlight it in thumbnails view and press OK.
- To magnify a picture up to 8X, press  repeatedly. To view other parts of the picture, press . Press  repeatedly to return.
- To rotate a picture, press .

Playing a video





- In thumbnails view, videos are marked with . To play the video, highlight it and press OK.
- During a slide show, videos play automatically. When the video ends, the slide show resumes.
- Video buttons on the remote control:

Press	To
	play, pause, and resume the video.
	rewind / fast forward.
	adjust the volume.
 or back	stop the video and return to thumbnails.

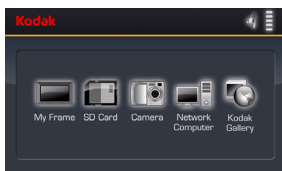
Choosing a different picture location

You can view pictures from different locations or sources.



- 1 On the remote control, press Home  .
Only available picture locations appear.
- 2 Press   to highlight a picture location.
- 3 Press OK to display thumbnails of the pictures in that location.
- 4 Press  to start a slide show. Or, navigate through folders or albums to your pictures, then press .

Possible picture locations:



My Slideshow (EX models)—designate your favorite pictures to run automatically on a wireless frame. See [page 23](#).



My Frame—the frame's internal memory. Copy your special pictures into My Frame from a memory card or other device ([page 10](#)).



Memory card—appears when you insert a card ([page 5](#)). The label and icon indicate the type of card.



Camera—appears when you connect a digital camera via USB cable ([page 5](#)).



USB drive—appears when you insert a USB flash drive ([page 5](#)).



Network computer (EX models)—appears if you are connected to a wireless network. Lets you display pictures that are stored on your computer. See [Using Wi-Fi mode—EX models only, page 19](#).



Kodak Gallery (EX models)—appears if you have set up your Gallery account and are connected to a wireless network. Lets you display your albums from the Gallery. See [Setting up your Gallery account, page 22](#).



Settings—customize and configure your frame. See [Changing frame settings, page 16](#).





3

Doing more with your frame

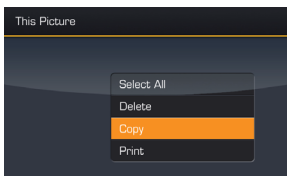
Copying pictures on your frame

Copy pictures/videos from your current picture location to any other connected device or location. For example, copy pictures from a memory card to the frame's internal memory (My Frame).



- 1 Press  to find a picture/video, then press .
- 2 Press  to highlight Copy, then press OK.
- 3 Press  to highlight the location you want to copy to, then press OK.

The picture/video is copied.

To copy multiple pictures/videos, [see page 12](#).

Copying between your frame and computer

Copy pictures/videos via the included USB cable. For wireless copying (EX models only), see [page 23](#).

Connecting to your computer

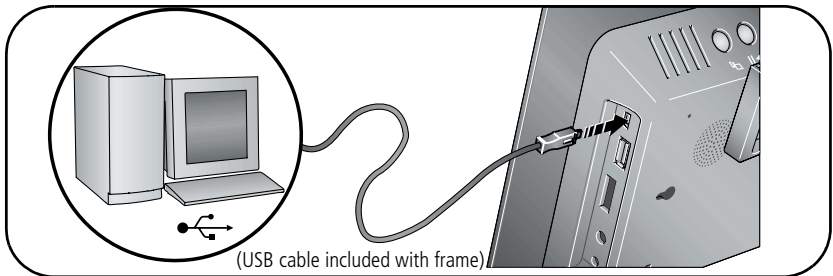

Copying pictures to/from your computer

Copy pictures between your frame and your computer using your computer's normal file copying tools. See [page 35](#) for the file formats that the frame can display.

1 Connect the USB cable from the frame to your computer ([see page 10](#)).



2 On your computer, open My Computer or Windows Explorer.

The picture frame appears as removable drives—one drive for each connected picture location in the frame, in this order: internal memory, memory cards, USB devices.

3 Navigate to the pictures you want to copy. Then drag and drop them to the new location.

See your computer documentation for more information on copying files.

Copying pictures from EasyShare software

It's easy to copy pictures/videos from My Collection to your frame.

1 Install EasyShare software to make sure you have the latest version ([see page 1](#)).

2 Connect the USB cable ([see page 10](#)).

3 On your computer, open EasyShare software. Select the pictures in My Collection and drag them into the Picture tray.

4 In the menu bar, select File → Copy to.

The picture frame appears as removable drives—one drive for each connected picture location in the frame, in this order: internal memory, memory cards, USB devices.

5 Select the frame location to which you are copying.

6 Select *Best For Digital Picture Frame* to reduce the resolution of the pictures you are copying. Full resolution is unnecessary and quickly fills up the frame's memory.

7 Click Copy. Pictures are copied to your frame.

Deleting pictures/videos

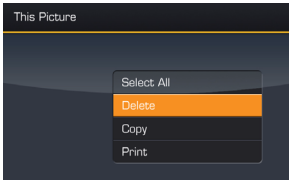

- 1 Press to find a picture/video, then press .
- 2 Press to highlight Delete, then press OK.
- 3 Highlight Delete and press OK again to confirm. To cancel the deletion, highlight Exit and press OK. *The picture/video is deleted.*

To delete multiple pictures/videos, [see page 12](#).

NOTE: You can delete pictures/videos from a card, internal memory, and some USB devices.

Selecting multiple pictures/videos

Use the multi-select feature to copy, delete, or print two or more pictures; or to play a slide show of selected pictures/videos.

Selecting one at a time

- 1 In thumbnails view, press to highlight a picture/video, then press .
- 2 Continue selecting pictures/videos.

A check mark appears on the selected pictures. Press again to remove a check mark. You can now view a slide show, copy, print, delete, etc. all selected pictures.

Selecting all

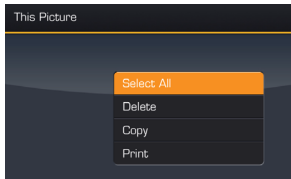

1 Press  whenever pictures/videos are displayed (slide show, video, single picture).

2 Press  to highlight Select all, then press OK.

A confirmation screen appears, then your picture display reappears. A check mark is displayed on all pictures/videos in your current location.

3 To remove all check marks, press , highlight Select / Unselect all and press OK.

4 Highlight Unselect all and press OK.

A confirmation screen appears, then your picture display reappears. All check marks are removed.

Printing pictures

Your frame is compatible with PictBridge technology, so you can print directly to PictBridge enabled printers.

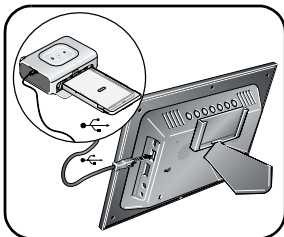

Connecting the frame to a PictBridge enabled printer



1 Turn off the frame and printer.



2 Connect the USB cable (included with your frame) from the frame to the printer.

Printing from a PictBridge enabled printer

- 1 Turn on the printer. Turn on the frame.
The USB connection mode screen appears on the frame.
- 2 Change your connection mode from computer to printer. Select Connect to printer, then press OK.
If the USB connection mode screen does not automatically appear, change the connection mode manually, see [Manually changing connection mode, page 14](#).
- 3 If you are in a slide show or single view, press . If you are in thumbnails view, press  to find a picture, then press .
- 4 On the Menu screen, highlight Print, press OK, then highlight Print again, and press OK
The picture is printed.
To print multiple pictures, see [page 12](#).
- 5 Change your connection mode back to Connect to computer. See [Manually changing connection mode, page 14](#).







Manually changing connection mode

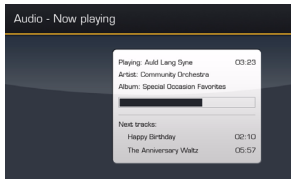



When your frame is connected to a computer, the connection mode must be Connect to computer. When it's connected to a printer, the connection mode must be Connect to printer. You can change the connection mode manually.

- 1 Disconnect the printer or computer from the frame.
- 2 On the remote control, press .
- 3 Select Settings  → Device configuration → USB connection mode. Select the mode you need, printer or computer. See [page 18](#).
- 4 Reconnect the printer or computer. If you are printing, continue with step 3 of the printing directions in [Printing from a PictBridge enabled printer, page 14](#).



Playing music



- 1 Press .
Your picture or slide show is paused.
- 2 Press   to highlight your music location. Then press OK.
- 3 Press   to locate your music files. Then press OK.
- 4 Press   to go to the next or previous song, or select Play all songs. Then press OK.
Your music starts playing.

- 5 Press  to return to your picture or slide show.
Your selected music continues to play as the slide show resumes. When music is playing, videos play without their related audio.
- 6 To turn off music, press , then .
- 7 Press  again to return to your pictures.





Notes on playing music:

- A headphone jack is available on the side of the frame ([page ii](#)).
- Adjust the volume with the   buttons.
- Press  to mute the music.

4





Changing frame settings

The options in the Setup menu let you customize and configure your frame.

- 1 Press Home .
- 2 Press   to highlight Settings , then press OK.
- 3 Choose a setting and follow the screen directions. Press OK to accept your selections.
- 4 Press the Back button to exit.

Settings menus

Setting	Options
Upgrade firmware This option is only displayed if the upgrade file (.img) is available on the frame (memory card, flash drive, internal memory, etc.).	Upgrade firmware —load the latest version of firmware on your frame (page 18). Exit —return to the Home screen.



Setting	Options
Viewing options	<p>Slide duration—specify how long each picture is displayed in a slide show, from 3 seconds (default) to 1 hour.</p> <p>Frame orientation—specify whether you wish to display your frame in landscape (default)  or portrait  orientation.</p> <p>Transitions—specify the transition style between pictures in a slide show. See screen for options. The default is Random.</p> <p>Screen Fit or Fill—Fit entire image  (default). Show the entire picture. Black borders may appear around the image. Fill the screen . The picture fills the entire screen, some of the picture may be cut off (cropped).</p> <p>Audio priority—when you are playing music (page 15), choose how to handle the audio portion of video playback.</p> <p>Play music (default). Music continues to play, video plays but its audio is muted. Play video soundtrack. Music stops playing while the video, with audio, plays.</p>
Brightness	Press ◀ ▶ to adjust the screen brightness according to your lighting conditions.
Clock and timer	<p>On/Off schedule—set your frame to turn on and off at a specified time every day.</p> <p>Get time from Internet—(EX models only) select your time zone and press OK. The frame’s internal clock is automatically set to the correct time.</p> <p>Set time—manually set the clock to the current time.</p>
Kodak Gallery EX models only	Set up your Kodak Gallery account on the frame (see page 22).
Network EX models only	Set up your frame for wireless operation (see page 19).

Setting	Options
Device configuration	<p>Frame name—EX models only. Assign a name to your frame. This name is referenced when connecting to your wireless network.</p> <p>USB connection mode—When you plug in a USB cable, choose to Connect to computer (default) or Connect to printer.</p>
Language	Choose your language.
About	Check your frame model number and firmware version.

Upgrading your firmware

Firmware is the software that runs on your frame. To check for the latest version of firmware, visit www.kodak.com/go/digitalframedownloads.

Follow these directions to download and upgrade your frame firmware.

- 1 On your computer, go to www.kodak.com/go/digitalframedownloads.
 - 2 Follow the screen directions to download the frame firmware to your computer.
 - 3 Copy the IMG file to your frame. See [page 10](#) for copying files.
 - You can copy the IMG file to a memory card or USB flash drive, then insert into the frame; or, you can connect your computer and frame with the USB cable and copy the IMG file directly to the frame.
 - 4 With the IMG file loaded on the frame, press Home , then select Settings  and press OK.
 - 5 Select Firmware Upgrade and press OK to begin the upgrade.
- IMPORTANT:** *Do not turn off the frame during the upgrade!*
- 6 When the upgrade is complete, turn off the frame and unplug the power cable. Plug the power cable back in and turn on the frame.

5

Using Wi-Fi mode—EX models only

Wireless operation is available on Kodak EasyShare EX-811 and EX-1011 digital picture frames.

For more information on wireless operation and networks, visit www.kodak.com/go/wifisupport or www.wi-fi.org.

What are some of the wireless features of my frame?

- Display pictures on your frame directly from your computer hard drive (see [page 21](#)).
- Display pictures from your *Kodak EasyShare* Gallery albums (see [page 22](#)).
- Copy pictures from your frame to your computer (see [page 23](#)).

Wireless networking and the Internet

Some wireless functions on your frame, including viewing pictures on *Kodak EasyShare* Gallery (see [page 22](#)), require access to the Internet. Most public and home networks are connected to the Internet, typically through an Internet Service Provider (ISP).

Setting up your frame for wireless operation

Before you start

On your computer, make sure you:

- Install the software from the CD that is packaged with your frame ([page 1](#)).
- Enable media sharing in Windows media player 11 (included on the CD). Select Library → Media Sharing, then follow the screen directions.

Perform the setup

- 1 Make sure your computer and router are on.
- 2 Remove all memory cards or other USB devices from your frame. Turn it on.

The first time you turn on your frame (after you select your language), the Network connection screen appears.

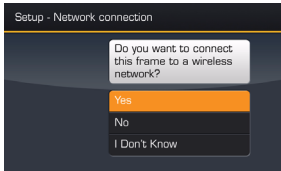

- 3 When asked "Do you want to connect your frame to a wireless network?", select Yes, then press OK to begin scanning for available networks.

If you select No, you can set up the network later: See [Set up your network at a later time, page 21](#).

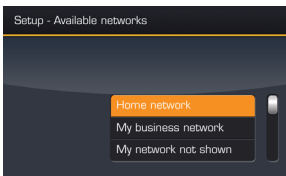

- 4 Select your network from the list of available networks, then press OK.

The frame connects to your network and then scans for available computers or other devices.

NOTE: If you have network security turned on, you are prompted to enter your security information. If you are not sure of your network information, contact your system administrator or the person who set up your network.

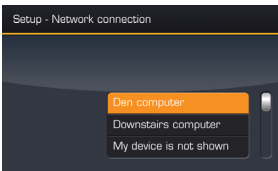



- 5 Select your home computer from the list, then press OK.

- 6 When the Setup complete message is displayed, press OK.

If you are unable to connect to your network or see your home computer, go to the troubleshooting help on [page 29](#) of this guide or visit www.kodak.com/go/digitalframesupport.





Set up your network at a later time

The first time you turn on your frame, the Network connection screen appears and asks if you want to connect your frame to a wireless network. You can answer No and perform the setup at a more convenient time.

- 1 Press , then go to Settings  → Manual → Enable/Disable connections.
- 2 Select Enable, then press the Back button.
- 3 Select Network again, then Scan for wireless networks.
- 4 Continue with step 4 of the setup directions on [page 20](#).

Viewing pictures over your wireless network

Pictures are accessed from your computer via Windows Media Player 11. To make sure you have version 11, install the software from the CD that was packaged with your frame (see [page 1](#)).

- 1 Turn on your computer and your picture frame. Then press Home .
- 2 Press   to highlight your network computer, then press OK.
If you have multiple computers on your network, first select Network Computer , then select the computer from the list.





NOTE: The first time you connect, a window may appear on your computer screen alerting you to a new device. Follow the prompts to "allow" the frame on your computer.

- 3 Follow the prompts to choose the pictures, then press OK.
Pictures are displayed as thumbnails. Press  to play a slide show.

If your network computer is not listed on the Home screen, or for more information, go to the troubleshooting help on [page 29](#) of this guide or visit www.kodak.com/go/digitalframesupport.



Setting up your Gallery account

You can display pictures directly from the *Kodak EasyShare* Gallery via the Internet. Perform this one-time setup to connect your frame to your existing Gallery account.

- 1 Press Home , then highlight Settings  and press OK.
- 2 Select *Kodak* Gallery and press OK.
- 3 If you are outside the United States, select your location and press OK.
- 4 Select Username. On the on-screen keyboard, press  to enter your existing Gallery username (usually your email address). Press OK after each character. When the entire username is entered, highlight Done, then press OK.
- 5 Select Password. On the on-screen keyboard, enter your existing Gallery password (as described for Username), highlight Done, then press OK.
- 6 Press Home . *Kodak* Gallery  appears on the Home screen.

Viewing pictures from the Gallery

View pictures you have uploaded to *Kodak EasyShare* Gallery.

- 1 Turn on your computer and your picture frame, and make sure your Internet connection is live.
- 2 Press Home , then press  to highlight Kodak gallery , then press OK.
- 3 Follow the prompts to choose the pictures, then press OK.

Pictures are displayed as thumbnails. Press  to play a slide show.



NOTE: Slide shows displayed from the Gallery may have a transition time between slides of 1 minute.

Creating My Slideshow

Designate any picture location on your home computer or from the Gallery as My Slideshow. My Slideshow will run automatically each time you turn on your frame.

- 1 When viewing thumbnails, a slideshow, or a single view picture, press .
- 2 Select Set as My Slideshow, then press OK.

The pictures/videos in your current viewing location will now be included in the slideshow that plays each time the frame is turned on.





You can also play My Slideshow anytime. Press Home , then select My Slideshow .

Copying pictures to your computer—wirelessly

Kodak picture transfer software (included on the software CD packaged with your EX-model frame) lets you wirelessly copy pictures and videos from the frame to your computer. Make sure you install the software before you proceed (see [page 1](#)).



- 1 Open Kodak picture transfer software on your computer: right-click the icon  in the lower right corner of the screen.
- 2 Follow the screen directions to allow your frame to have access to your computer.

- 3 On the frame, display a picture in single view, then press .
- 4 Press  to highlight Copy, then press OK.
- 5 Press  to highlight Network Computer , then press OK.

To copy multiple pictures/videos, see [page 12](#).

Glossary of common wireless network terms

Access point—(Also called AP.) A wireless network transceiver or “base station” hub, often used to connect a local area network to one or more wireless devices. An access point can also provide a communication link to a wired local area network.

Ad Hoc—A client setting for a wireless local area network that allows devices connected to the network to communicate with one another directly, independent of an access point or router.

Bridge—A product that connects a local area network to another local area network that uses the same protocol (for example, wireless, Ethernet or token ring). Wireless bridges are commonly used to link buildings in campuses.

Client—An application on a computer or device connected to a network that requests services (files, print capability) from another connected computer or device on the network.

Device-to-device—See Ad Hoc.

DHCP—Dynamic Host Configuration Protocol: a utility that enables a server to dynamically assign IP addresses from a predefined list and limit their time of use so they can be reassigned. Without DHCP, all of the IP addresses of all the clients on the network would have to be manually entered. With DHCP, whenever a client connects to the network, it automatically gets an IP address assigned to it.

DNS—Domain Name System (or Service, or Server): a program that translates domain names to IP addresses by accessing a database maintained on a collection of Internet servers. The program works behind the scenes to facilitate surfing the Web with alpha versus numeric addresses. A DNS server converts a name like mywebsite.com to a series of numbers like 107.22.55.26. Every Web site has its own specific IP address on the Internet.

Domain name— The portion of a URL or Web address that identifies a specific Web site. For example, the domain name portion of the URL *http://www.kodak.com* is *kodak.com*.

All domain names have a suffix that indicates the top level domain (TLD) it belongs to. Examples include:

- com: US commercial business
- gov: US government agency
- edu: US educational institution
- mil: US military organization
- net: US network organization
- org: US nonprofit organization
- au: Australia
- br: Brazil
- ca: Canada
- de: Germany
- do: Dominican Republic
- es: Spain
- fr: France
- it: Italy
- nl: Netherlands
- pr: Puerto Rico
- pt: Portugal
- ru: Russian Federation
- uk: United Kingdom

DSL—Digital Subscriber Lines: various technology protocols for high-speed data, voice and video transmission over ordinary twisted-pair copper POTS (Plain Old Telephone Service) telephone wires.

Dynamic IP address—An IP address assigned to a client, each time the client connects to the network. The dynamic IP address is configured by the DHCP server and can be different each time the client connects to the network.

Encryption key—An alphanumeric (letters and/or numbers) series that enables data to be encrypted then decrypted so it can be safely shared among members of a network. WEP uses an encryption key that automatically encrypts outgoing wireless data. On the receiving side, the same encryption key enables the computer to automatically decrypt the information so it can be read.

Infrastructure—A client setting for a local area network that allows devices connected to the network to communicate with one another through a central access point or router. This configuration is commonly used in wireless home networks.

IP—Internet Protocol: technology that supports voice, data and video transmission via IP-based local area networks, wide area networks, and the Internet. This includes VoIP (Voice over IP).

IP address—A number that identifies each sender or receiver of information that is sent across the Internet.

Network name—Identifies the wireless network for all the shared components. During the installation process for most wireless networks, you must enter the network name or SSID. Different network names are used when setting up your individual computer, wired local area network, or workgroup.

Passphrase—A text string used for WPA security on a Wi-Fi wireless network. A passphrase may contain up to 31 alphanumeric characters, including spaces and other special characters.

NOTE: A passphrase used for WPA security is not the same as a WEP key, nor is it the same as a passphrase commonly found in router software that is used to generate a WEP key.

Router—An access point (AP) or hub that sends data from one local area network (LAN) or wide area network (WAN) to another. A router monitors and controls data flow and sends information using the most efficient route based on traffic load, line costs, speed, bad connections, etc.

SSID—Service Set Identifier: also referred to as a network name, since it is essentially a name that identifies a wireless network. The identifier is attached to the wireless local area network (WLAN) and acts as an identifier when a device tries to connect to the system. A device will not be permitted to join the network unless it can provide

the unique SSID. An SSID can be broadcast by the network router, allowing devices to detect it as an available network. An SSID does not supply security to the network.

SSL—Secure Sockets Layer: a commonly used encryption scheme used by many online retail and banking sites to protect the financial integrity of transactions.

TCP/IP—Transmission Control Protocol/Internet Protocol: the underlying technology behind the Internet and communications between computers in a network.

URL—Uniform Resource Locator: also referred to as a Web address, since it identifies the location of a file or resource on the Web. For example, the URL for the Eastman Kodak Company Web site is <http://www.kodak.com>.

WEP—Wired Equivalent Privacy: basic wireless security provided by Wi-Fi. In some instances, WEP may be all a home or small-business user needs to protect wireless data. WEP is available in 40-bit (also called 64-bit), or in 108-bit (also called 128-bit) encryption modes. As 108-bit encryption provides a longer algorithm that takes longer to decode, it can provide better security than basic 40-bit (64-bit) encryption.

WEP key—A text string used for WEP security on a Wi-Fi wireless network. A WEP key with 10 or 23 characters can include numbers and the letters A - F and are not case-sensitive. 5 and 13 character WEP keys can include numbers and all letters (as well as some special characters) and are case sensitive.

WPA—Wi-Fi Protected Access: a Wi-Fi security standard that provides a high level of wireless network security. It uses data encryption through the Temporal Key Integrity Protocol (TKIP). TKIP scrambles the keys and ensures that the keys haven't been tampered with. User authentication is performed through the Extensible Authentication Protocol (EAP) to ensure that only authorized network users can access the network.

Wi-Fi—Wireless Fidelity: a term developed by the Wi-Fi Alliance commonly used to describe any type of 802.11 standard wireless network. Products tested and approved as "Wi-Fi Certified" (a registered trademark) by the Wi-Fi Alliance are certified as interoperable with each other, even if they are from different manufacturers.

For more information, visit www.kodak.com/go/wifisupport or www.wi-fi.org.

6

Troubleshooting and support

For step-by-step product support, visit www.kodak.com/go/digitalframesupport and select Interactive Troubleshooting & Repairs.

Picture frame problems

If...	Try one or more of the following
Frame does not turn on.	<ul style="list-style-type: none">■ Make sure the power cable is securely connected (page 4).■ Make sure you are using the power cable that was included with your frame.■ Make sure the power switch on the frame is On (page 6).
Remote control does not function.	<ul style="list-style-type: none">■ Check the battery in the remote.■ Make sure the power switch on the frame is On (page 6).
Frame does not recognize memory card.	<ul style="list-style-type: none">■ Purchase a certified SD/MMC card.■ Insert a card into the slot, then push to seat (page 5).
Frame freezes up.	<ul style="list-style-type: none">■ Use a pen or other slim object to press the recessed reset button on the back of the frame (page ii).

Picture frame/computer communications

If...	Try one or more of the following
Cannot copy pictures to my computer.	<ul style="list-style-type: none">■ Make sure your computer is on.■ Make sure the USB cable is securely connected (page 10).
Cannot see my frame as a removable drive.	<ul style="list-style-type: none">■ Make sure the power switch on the frame is On (page 6).

If...	Try one or more of the following
Cannot copy pictures from Kodak EasyShare software.	<ul style="list-style-type: none"> ■ Make sure your frame and computer are on. ■ Make sure the USB cable is securely connected (page 10). ■ Make sure you have installed the latest version of EasyShare software (page 1). ■ From My Collection in EasyShare software, make sure the pictures are in the Picture Tray.

Wireless network connection (EX models)

Problem	Possible causes and/or solutions
Frame cannot connect to the wireless network — "Wireless network not found" appears.	<ul style="list-style-type: none"> ■ Make sure you have a wireless router and that it is broadcasting the SSID, or enter the SSID manually. ■ Make sure your frame and computer are on. ■ Make sure you have installed Windows media player 11 (from the EasyShare software CD) and you have allowed sharing in media player (page 19). ■ Make sure the wireless router and network are running before the frame begins scanning for a network. ■ Make sure you are within the operating range of the network. Move the frame into the same room with the router. ■ Check for sources of interference in the wireless signal, such as a microwave oven or a cordless telephone. ■ Check with your router manufacturer for a possible firmware update. ■ Make sure your frame is using the latest firmware. Check www.kodak.com/go/digitalframesupport for updates.

Problem	Possible causes and/or solutions
<p><i>(Continued from previous table)</i></p> <p>Frame cannot connect to the wireless network — "Wireless network not found" appears.</p>	<ul style="list-style-type: none"> ■ Make sure the network profile settings on your frame match those of the network. In an Infrastructure network, you can usually view the network settings with the software program included with the router or through the interface of a connected device. See the router or device documentation for details. <p>If possible, note the following settings for the network, then change the profile settings on your frame to match them:</p> <ul style="list-style-type: none"> – SSID – Wi-Fi mode (Infrastructure) – Security (none, WEP, or WPA-PSK) – Dynamic IP (yes or no) – Connect Mode (yes - ask before connecting, or no - connect automatically) <p>NOTE: Many wireless network routers employ the use of a WEP passphrase for generating a WEP security key code. If WEP security is enabled for the network, make sure the key code, not the passphrase, is entered in the security settings for the network profile on the camera.</p>

Problem	Possible causes and/or solutions
(Continued)	<p>The wireless router did not assign a valid network IP address to the frame. Check and change the router settings, as indicated below. You can usually view the network settings with the software program included with the router.</p> <ul style="list-style-type: none"> ■ Enable DHCP on the router. ■ Change the setting on the router to allow both 802.11b and 802.11g Wi-Fi protocols. ■ Change router settings to allow enough IP addresses for the number of wireless devices on the network. ■ Disable MAC filtering on the router or enable the MAC for the frame. ■ Temporarily disable the QoS (Quality of Service) setting on the router. ■ Check with the router manufacturer for a possible firmware update. <p>See the router documentation for details.</p>
Frame cannot connect to Kodak EasyShare Gallery.	<ul style="list-style-type: none"> ■ The Gallery URL, account email address, or account password on the frame are incorrect. ■ Make sure the wireless router is connected to the Internet and an Internet connection is available. ■ The Gallery or online picture service is temporarily unavailable. Try again later. ■ There may not be an EasyShare Gallery service in the region you are in. <p>See <i>Frame cannot connect to the wireless network</i>, above, for other possible causes and/or solutions.</p>

Screen messages

Screen message	Try one or more of the following
Create file failed.	<p>The device (memory card, USB drive, camera, etc.) you are trying to copy to is protected.</p> <ul style="list-style-type: none"> ■ See your device documentation to remove write protection. ■ Insert or connect a different device.
Error attempting to open file or directory.	<ul style="list-style-type: none"> ■ Turn off the frame, then turn it back on. If the problem persists, contact customer support help, at www.kodak.com/go/digitalframesupport.
Error duplicate file name.	
Error occurred while closing a file.	
Error invalid file name	
Error reading from file.	
Error writing from file.	
Error writing a file.	
Error writing to a file.	
File Copy Failed!	
Internal error.	
Parameter is invalid.	
Unknown error.	
Please enter your SSID.	<ul style="list-style-type: none"> ■ Enter the name of your network. If you do not know it, contact your system administrator or the person who set up your wireless network.
Printer unavailable. Unable to connect to printer.	<ul style="list-style-type: none"> ■ Make sure your printer is on and the USB cable is securely connected (page 14). ■ Make sure you changed your USB connection mode from computer to printer (page 14).

Screen message	Try one or more of the following
Printing error.	<ul style="list-style-type: none"> ■ Make sure your printer is on and the USB cable is securely connected (page 14). ■ Check your printer for more info.
Time out occurred while printing.	<ul style="list-style-type: none"> ■ Check cables and printer supplies. Print again.
Unable to create file. Device write protected or full.	<p>The frame was unable to copy the picture.</p> <ul style="list-style-type: none"> ■ Insert a different card or device (page 5), or change the picture location setting (page 9). ■ Remove write protection, unlock card. ■ Delete pictures from card.
Verify network settings.	<ul style="list-style-type: none"> ■ Contact your system administrator or the person who set up your wireless network.
Verify security code.	<p>You have network security turned on.</p> <ul style="list-style-type: none"> ■ Enter the security code you created when you set up your wireless network. ■ Contact your system administrator or the person who set up your wireless network.
Write failed. Select another location.	<p>The frame was unable to copy the picture.</p> <ul style="list-style-type: none"> ■ Insert a different card or device (page 5), or change the picture location setting (page 9).

7

Appendix

Digital frame specifications

For more specifications, visit www.kodak.com/go/digitalframesupport.

Kodak EasyShare digital picture frame	
Wi-Fi wireless network compatibility	
SV-710, SV-811	No
EX-811, EX-1011	Yes. Wi-Fi 802.11b protocol—compatible with Wi-Fi wireless 802.11b and 802.11g networks.
Color display	
SV-710	17.8 cm (7 in.) diag. analog LCD, 480 x 234 pixels, 16:9 aspect ratio, 154 x 87 mm (6.1 x 3.4 in.) viewable area
SV-811, EX-811	20.3 cm (8 in.) diag. digital LCD, 800 x 480 pixels, 4:3 or 16:9 aspect ratio, 17.6 x 10 cm (6.9 x 3.9 in.) viewable area
EX-1011	25.4 cm (10 in.) diag. digital LCD, 800 x 480 pixels, 16:9 aspect ratio, 23.5 x 14.6 cm (9.3 x 5.8 in.) viewable area
Battery, remote control	
CR2025	3V lithium cell, included
Internal storage capacity	
SV-710	No
SV-811, EX-811, EX-1011	128 MB

Kodak EasyShare digital picture frame	
Power	
100-120V AC 60Hz (US), 100-240V 50-60Hz (WW), 12V DC adapter	
Communication with computer	
USB 2.0 (PIMA 15740 protocol), via USB cable model U-8	
Other features	
PictBridge support	Yes
Picture formats	JPEG, EXIF 2.2
Video formats	MOV, AVI, MPG, MPEG
Music format	MP3
Memory cards	CompactFlash, MicroDrive, Secure Digital, Memory Stick, xD, MultiMedia Card
Tripod mount	1/4 inch
Temperature	Operating: -4 to 140°F (-20 to 60°C) Storage: -22 to 185°F (-30 to 85°C)
Size	SV-710: 26.2 cm (10.3 in.) x 19.3 cm (7.6 in.) x 3.8 cm (1.5 in.) SV-811, EX-811: 28.5 cm (11.2 in.) x 21 cm (8.3 in.) x 3.8 cm (1.5 in.) EX-1011: 33 cm (13 in.) x 24 cm (9.5 in.) x 3.8 cm (1.5 in.)

Important safety instructions



CAUTION:

Do not disassemble this product; there are no user-serviceable parts inside. Refer servicing to qualified service personnel. Do not expose this product to liquid, moisture, or extreme temperatures. The use of controls, adjustments, or procedures other than those specified herein may result in exposure to shock and/or electrical or mechanical hazards. If the LCD breaks, do not touch the glass or liquid. Contact Kodak customer support.

- The use of an accessory that is not recommended by Kodak may cause fire, electric shock, or injury. For approved accessories, visit www.kodak/go/accessories.
- Use only a USB-certified computer equipped with a current-limiting motherboard. Contact your computer manufacturer if you have questions.
- When removing the battery from the remote, allow it to cool; it may be hot.
- Follow all warnings and instructions supplied by the battery manufacturer.
- Use only batteries approved for this product to avoid risk of explosion.
- Keep batteries out of the reach of children.
- Do not allow batteries to touch metal objects, including coins. Otherwise, a battery may short circuit, discharge energy, become hot, or leak.
- Do not disassemble, install backward, or expose batteries to liquid, moisture, fire, or extreme temperature.
- Remove the battery when the product is stored for an extended period of time. In the unlikely event that battery fluid leaks inside the product, contact Kodak customer support.
- In the unlikely event that battery fluid leaks onto your skin, wash immediately with water and contact your local health provider. For additional health-related information, contact your local Kodak customer support.
- Dispose of batteries according to local and national regulations. Visit

www.kodak.com/go/support

www.kodak.com/go/kes.

- Do not charge non-rechargeable batteries.
For more information on batteries, visit www.kodak.com/go/batterytypes.
- Digital picture frame and remote control battery may include perchlorate material. Special handling may apply in California.
- Read and follow all warnings and instructions supplied by the battery manufacturer.



CAUTION:

EX models only: When using this product, it should be installed and operated with a minimum distance of 7.9 in. (20 cm) for 2.4 GHz operations between the radiator and your body. This transmitter must not be collocated or operate in conjunction with any other antenna or transmitter.

Downloading your software and firmware

Download the latest versions of the software included on the Kodak EasyShare software CD and the frame firmware—www.kodak.com/go/digitalframedownloads. See [page 18](#) for upgrading firmware.

Additional care and maintenance

- Wipe the LCD gently with a soft, lint-free cloth or an untreated lens-cleaning tissue. Do not use cleaning solutions unless designed specifically for LCD screens. Do not allow chemicals, such as suntan lotion, to contact painted surfaces.
- Service agreements are available in some countries. Contact a dealer of Kodak products for more information.
- For digital frame disposal or recycling information, contact your local authorities. In the US, visit the Electronics Industry Alliance Web site at www.eiae.org or visit www.kodak.com/go/digitalframesupport.

Limited warranty

Kodak warrants Kodak consumer electronic products and accessories ("Products"), excluding batteries, to be free from malfunctions and defects in both materials and workmanship for one year from the date of purchase. Retain the original dated sales receipt. Proof of the date of purchase will be required with any request for warranty repair.

Limited warranty coverage

Warranty service is only available from within the country where the Products were originally purchased. You may be required to ship Products, at your expense, to the authorized service facility for the country where the Products were purchased. Kodak will repair or replace Products if they fail to function properly during the warranty period, subject to any conditions and/or limitations stated herein. Warranty service will include all labor as well as any necessary adjustments and/or replacement parts. If Kodak is unable to repair or replace a Product, Kodak will, at its option, refund the purchase price paid for the Product provided the Product has been returned to Kodak along with proof of the purchase price paid. Repair, replacement, or refund of the purchase price are the sole remedies under the warranty. If replacement parts are used in making repairs, those parts may be remanufactured, or may contain remanufactured materials. If it is necessary to replace the entire Product, it may be replaced with a remanufactured Product. Remanufactured Products, parts and materials are warranted for the remaining warranty term of the original Product, or 90 days after the date of repair or replacement, whichever is longer.

Limitations

This warranty does not cover circumstances beyond Kodak's control. This warranty does not apply when failure is due to shipping damage, accident, alteration, modification, unauthorized service, misuse, abuse, use with incompatible accessories or attachments (such as third party ink or ink tanks), failure to follow Kodak 's operation, maintenance or repacking instructions, failure to use items supplied by Kodak (such as adapters and cables), or claims made after the duration of this warranty. Kodak makes no other express or implied warranty for this product, and

www.kodak.com/go/support

disclaims the implied warranties of merchantability and fitness for a particular purpose. In the event that the exclusion of any implied warranty is ineffective under the law, the duration of the implied warranty will be one year from the purchase date or such longer period as required by law. The option of repair, replacement, or refund is Kodak's only obligation. Kodak will not be responsible for any special, consequential or incidental damages resulting from the sale, purchase, or use of this product regardless of the cause. Liability for any special, consequential or incidental damages (including but not limited to loss of revenue or profit, downtime costs, loss of the use of the equipment, cost of substitute equipment, facilities or services, or claims of your customers for such damages resulting from the purchase use or failure of the Product), regardless of cause or for breach of any written or implied warranty is expressly disclaimed.

Your rights

Some states or jurisdictions do not allow exclusion or limitation of incidental or consequential damages, so the above limitation or exclusion may not apply to you. Some states or jurisdictions do not allow limitations on how long an implied warranty lasts, so the above limitation may not apply to you. This warranty gives you specific rights, and you may have other rights which vary from state to state or by jurisdiction.

Outside the United States and Canada

In countries other than the United States and Canada, the terms and conditions of this warranty may be different. Unless a specific Kodak warranty is communicated to the purchaser in writing by a Kodak company, no warranty or liability exists beyond any minimum requirements imposed by law, even though defect, damage, or loss may be by negligence or other act.

FCC compliance and advisory



Kodak EasyShare digital picture frame

This equipment has been tested and found to comply with the limits for a Class B digital device, pursuant to Part 15 of the FCC Rules. These limits are designed to provide reasonable protection against harmful interference in a residential installation.

This equipment generates, uses, and can radiate radio frequency energy and, if not installed or used in accordance with the instructions, may cause harmful interference to radio communications. However, there is no guarantee that interference will not occur in a particular installation.

If this equipment does cause harmful interference to radio or television reception, which can be determined by turning the equipment off and on, the user is encouraged to try to correct the interference by one or more of the following measures: 1) reorient or relocate the receiving antenna; 2) increase the separation between the equipment and the receiver; 3) connect the equipment to an outlet on a circuit different from that to which the receiver is connected; 4) consult the dealer or an experienced radio/TV technician for additional suggestions.

Any changes or modifications not expressly approved by the party responsible for compliance could void the user's authority to operate the equipment. Where shielded interface cables have been provided with the product or specified additional components or accessories elsewhere defined to be used with the installation of the product, they must be used in order to ensure compliance with FCC regulation.

FCC and Industry Canada

This device complies with Industry Canada RSS-210 and FCC Rules. Operation is subject to the following two conditions: (1) this device may not cause harmful interference, and (2) this device must accept any interference received, including interference that may cause undesired operation.

CE

Hereby, Eastman Kodak Company declares that this Kodak product is in compliance with the essential requirements and other relevant provisions of Directive 1999/5/EC.

This digital picture frame EX-811 and EX-1011 transmits in 12dBm. In France, the power level is limited to 10dBm in outdoor environments, per regulations. When in France, use the wireless functions of this device indoors only.

Canadian DOC statement

DOC Class B Compliance—This Class B digital apparatus complies with Canadian ICES-003.

Observation des normes-Classe B—Cet appareil numérique de la classe B est conforme à la norme NMB-003 du Canada.

Waste Electrical and Electronic Equipment labeling



In the European Union, do not discard this product as unsorted municipal waste. Contact your local authorities or go to www.kodak.com/go/recycle for recycling program information.

The lamps inside the EX-1011 model contain mercury and must be recycled or disposed of in accordance with local, state, or federal laws. For more information on recycling, visit www.lamprecycle.org or www.eiae.org. Find additional information at www.kodak.com/go/hse or 1-800-242-2424.

Australian C-Tick



MPEG-4

Use of this product in any manner that complies with the MPEG-4 visual standard is prohibited, except for use by a consumer engaging in personal and non-commercial activities.

Licensing

Supply of this product does not convey a license nor imply any right to distribute content created with this product in revenue-generating broadcast systems (terrestrial, satellite, cable and/or other distribution channels), streaming applications (via Internet, intranets and/or other networks), other content distribution systems (pay-audio or audio-on-demand applications and the like) or on physical media (compact discs, digital versatile discs, semiconductor chips, hard drives, memory cards and the like). An independent license for such use is required. For details, please visit <http://mp3licensing.com>.

Index

A

about, frame, 18
appendix, 34
arrow buttons on remote, 3
automatic on/off, 17

B

back button on remote, 3
battery
 remote control, 34
 safety, 36
brightness, screen, 17
buttons
 on back of frame, ii
 on remote control, 3

C

cables
 power, connecting, 4
 USB, connecting, 5
camera, connecting, 5
card. see memory card
changing picture locations, 9
check mark, select button, 3
clock and timer, setting, 17
computer
 connecting to frame, 10
 copying to/from, 10
 help with communicating, 28
computer connection mode, 18
connection mode, 14, 18

connectors on frame, ii
copying
 from EasyShare software, 11
 on frame, 10
 to/from computer, USB, 10, 11
 wireless, 23

D

DC-in, ii
deleting pictures and videos, 12
device configuration, 18
displaying slide show, 7
disposal, recycling, 37
doing more with your frame, 10

E

EasyShare gallery
 problem connecting, 31
 set up account, 17, 22
 viewing your albums, 22
EasyShare software
 copying pictures from, 11
 installing, 1
error messages, 32

F

faceplate, i
fast forward video, 3, 8
firmware
 checking version, 18
 upgrading, 16, 18, 37

flash drive, connecting, 5
frame, picture
 assign a name, 18
 checking model, firmware, 18
 product views, i
 setup, 4
 setup wireless network, 17
 specifications, 34
 troubleshooting, 28
 turning on/off, 6

G

glossary, wireless terms, 24

H

headphone jack, ii
help
 communicating with computer, 28
 connecting to Gallery, 31
 frame, 28
 troubleshooting problems, 28
holder, remote control, i
home
 button on remote, 3
 changing picture locations, 9
 screen, 9

I

installing software, 1
internal memory capacity, 34
internet requirements for wireless, 19

L

landscape, set orientation, 17

language
 setting, 18
 setting first time, 6
LCD. see screen
loading software, 1

M

magnify picture, 3
memory card
 inserting, 5
 slots, i
 types, 5
menu button on remote, 3
multi-up view, 7
music
 adjust volume, 3
 button on remote, 3
 mute, 3
 playing, 15

N

name, frame, 18
network, wireless setup, 17

O

OK button on remote, 3
on/off switch, i
on/off, setting auto, 17
orientation setting, 17

P

PictBridge enabled printer, 13
pictures
 copying connected, 10, 11

- copying from EasyShare software, 11
 - copying on frame, 10
 - copying wireless, 23
 - deleting, 12
 - location, changing, 9
 - printing, 13
 - selecting more than one, 12
 - viewing, 7
 - play/pause, video, 8
 - button on remote, 3
 - playing
 - music, 15
 - video, 8
 - portrait, set orientation, 17
 - power
 - button on remote, 3
 - connecting, 4
 - connector, ii
 - specifications, 35
 - turning on, 6
 - printer connection mode, 14, 18
 - printing, PictBridge printer, 13
- R**
- recycling, disposal, 37
 - regulatory compliance, 40
 - remote control
 - activating, 2
 - battery type, 34
 - holder, i
 - sensor on frame, i
 - storing, 2
 - using, 3
 - reset button, recessed, ii
 - rewind video, 8
 - button on remote, 3
 - rotate picture, 3
 - running slide show, 7
- S**
- safety information, 36
 - screen, i
 - cleaning, 37
 - error messages, 32
 - setting brightness, 17
 - select button on remote, 3
 - selecting multiple pictures, 12
 - sensor, remote control, i
 - setting
 - auto on/off, 17
 - language, 18
 - language first time, 6
 - screen brightness, 17
 - time, 17
 - viewing options, 17
 - wireless operation, 19
 - settings, changing, 16
 - setup
 - EasyShare gallery account, 22
 - picture frame, 4
 - wireless network, 17, 19
 - slide duration, setting, 17
 - slide show
 - button on remote, 3
 - running, 7
 - viewing first, 6

slide transitions, setting, 17
software
 installing, 1
 upgrading, 37
source, picture location, 9
speakers, i
specifications, frame, 34
stand, frame, i
stop
 button on remote, 3
 video, 8
storage capacity, internal memory, 34
switch, on/off, i

T

thumbnails, 7
time, setting, 17
transitions, slides, setting, 17
troubleshooting
 error messages, 32
 frame, 28
 wireless network connection, 29
turning on/off frame, 6

U

upgrading
 firmware, 16, 18
 software and firmware, 37
USB connection mode, 14, 18
USB connector, ii
USB device, connecting, 5

V

video, playing, 8
viewing
 first slide show, 6
 from EasyShare gallery, 22
 full screen picture, 8
 pictures, wireless network, 21
 pictures/videos, 7
 thumbnails, 7
volume, adjust, ii, 3, 8

W

wall mount hangers, i
warranty, 38
wireless
 copying, 23
 features on frame, overview, 19
 glossary of terms, 24
 internet requirements, 19
 network, troubleshooting, 29
 setup, 17, 19
 viewing pictures, 21

Z

zoom picture, 3

Free Manuals Download Website

<http://myh66.com>

<http://usermanuals.us>

<http://www.somanuals.com>

<http://www.4manuals.cc>

<http://www.manual-lib.com>

<http://www.404manual.com>

<http://www.luxmanual.com>

<http://aubethermostatmanual.com>

Golf course search by state

<http://golfingnear.com>

Email search by domain

<http://emailbydomain.com>

Auto manuals search

<http://auto.somanuals.com>

TV manuals search

<http://tv.somanuals.com>