

Kodak

i800 Series Scanners

User's Guide

A-61169
Part No. 3E9708

Safety and Installation Information for the *Kodak i800 Series Scanners*

IMPORTANT: *Equipment shall be installed by qualified personnel.*

WARNING: **Dangerous voltage. Disconnect the main power before installation.**

WARNING: **Before changing a lamp, always power down the scanner and let it cool a minimum of 10 minutes before proceeding (see *Warning Labels* below).**



CAUTION: Hot surface, avoid contact

إحذر: سطح ساخن، تفادى الإحتكاك

POZOR: Horký povrch -- nedotýkat se

DIKKAT: Hareketli parçalar, dokunmayın



CAUTION: Moving parts, avoid contact

إحذر: أجزاء متحركة، تفادى الإحتكاك

POZOR: Pohybující sečástie -- nedotýkat se

DIKKAT: Sıcak yüzey, dokunmayın

User Precautions

Users and their employer need to observe the common sense precautions applicable to the operation of any machinery. These include, but are not limited to, the following:

- Do not wear loose clothing, unbuttoned sleeves, etc.
- Do not wear loose jewelry, bracelets, bulky rings, long necklaces, etc.
- Hair length should be kept short, using a hair net if needed, or tying long hair up in a bundle.
- Remove all other loose objects from the area that could be drawn into the machine.
- Take sufficient breaks to maintain mental alertness.

Supervisors should review their practices and make compliance with these precautions a part of the job description for operation of the *Kodak i800 Series Scanners* or any mechanical device.

ElectroMagnetic Compatibility Statements

European Union

This is a Class A product. In a domestic environment this product may cause radio interference in which case the user may be required to take adequate measures.

United States

This equipment has been tested and found to comply with the limits for a Class A digital device, pursuant to part 15 of the FCC rules. These limits are designed to provide reasonable protection against harmful interference when the equipment is operated in a commercial environment. This equipment generates, uses and can radiate radio frequency energy and, if not installed and used in accordance with the instruction manual, may cause harmful interference to radio communications. Operation of this equipment in a residential area is likely to cause harmful interference in which case the user will be required to correct the interference at their own expense.

Taiwan

警告使用者：

這是甲類的資訊產品，在居住的環境中使用時，可能會造成射頻干擾，在這種情況下，使用者會被要求採取某些適當的對策。

Japan Class A

This equipment is in the Class A category (Information Technology Equipment to be used in commercial and/or industrial areas) and conforms to the standards set by the Voluntary Control Council for Interference by Information Technology Equipment aimed at preventing radio interference in commercial and/or industrial areas.

Consequently, when used in a residential area or in an adjacent area thereto, radio interference may be caused to radio and TV receivers, etc.

Read the instructions for correct handling.

Peoples Republic of China Class A

声 明

此为 A 级产品，在生活环境中，该产品可能会造成无线电干扰。在这种情况下，可能需要用户对其干扰采取切实可行的措施。

1 Introduction

This User's Guide provides information and operator procedures for the *Kodak* i800 Series Scanners. The information in this guide is for use with all of the i800 Series Scanners unless otherwise noted.

Chapter 1, Introduction — provides general information about the i800 Series Scanners including a product description, features and benefits, specifications, an overview of external components and user precautions.

Chapter 2, Using the Scanner — includes information on how to prepare your documents for scanning, elevator tray and output tray adjustments, turning the scanner on and off and how to scan documents.

Chapter 3, Operator Control Panel Functions — provides a list of the icons found on the Operator Control Panel and what functions can be performed using the Operator Control Panel.

Chapter 4, Document Printer and Patch Reader — provides instructions for using and changing the location of the Document Printer 1 and the Patch Reader. This chapter also instructs how to change and purge the ink cartridge.

Chapter 5, Maintenance — provides complete maintenance procedures for the i800 Scanner, including replacement procedures for the feeder module and tires, separation roller and tires, exposure lamps and imaging guides.

Chapter 6, Troubleshooting/Messages — provides a message listing, a problem solving chart and how to clear a document jam.

Product description

The *Kodak* i800 Series Scanners are ideal for operation with bi-tonal and/or color documents, documents with shaded backgrounds or foregrounds, and mixed document sets. These scanners offer a new, user interface and Kodak-patented technologies that produce high quality production images.

Standard features

The following features are standard on the *Kodak* i800 Series Scanners.

- Simultaneous output of color and bi-tonal images (i820 and i840 scanners only)
- SurePath paper handling, featuring:
 - 1,000-sheet QuickSet elevator that automatically returns to the batch level you set
 - Automatic feeder with single-sheet feeding and operator-assisted document stacks. Allows you to set the elevator level to accommodate 25-, 250- 500-, 750- 1000-document stacks
 - 3D Multi-feed Detection, using ultrasonic technology, offering outstanding reliability
 - Flexible document feeding — center- and edge-aligned
 - An adjustable output tray that handles documents of varying sizes
- The Tri-Color Plus Array provides, in one pass, true color and bi-tonal images
- Zone Processing allows operator selection of a fixed subsection or zone (i820 and i840 scanners only)
- PerfectPage, now with iThresholding (color and bi-tonal)
- Built-in iThresholding, Adaptive Threshold Processing (ATP), image compression, despeckle, error diffusion, and dithering for bi-tonal scanning
- Electronic Color Dropout
- Color on-the-fly
- Accepts custom color tables
- A wide variety of image output resolutions in bi-tonal and color are available
- Easily upgradeable models, at your site, with minimal downtime
- Bundled ISIS and TWAIN drivers
- Friendly operator interface — only seven operator control buttons
- Ease-of-use — easy replacement of consumables
- Illumination tracking with calibration alert
- Diagnostics and modular design simplify service and minimize downtime
- Image address with Patch Reader support
- Document Printer 1 imprinting on scanned documents

Standard configurations

Four models of the *Kodak i800 Series Scanners* are available:

- **Kodak i810 Scanner (bi-tonal)** — provides bi-tonal scanning with throughput speeds up to 120 ppm
- **Kodak i820 Scanner** — provides both color and bi-tonal scanning simultaneously with throughput speeds up to 120 ppm
- **Kodak i830 Scanner (bi-tonal)** — provides bi-tonal scanning with throughput speeds up to 160 ppm
- **Kodak i840 Scanner** — provides both color and bi-tonal scanning simultaneously with throughput speeds up to 160 ppm

Transport speed

Following is the minimum and maximum paper transport speed and capacity of the scanner:

Dimension	Minimum	Maximum	Operational Mode
Length	6.4 cm (2.5 in.)	27.9 cm (11 in.)	Auto-feed
Length	27.9 cm (11 in.)	43.2 cm (17 in.)	Auto-feed with extensions
Length	43.2 cm (17 in.)	76.1 cm (30 in.)	Operator assistance
Width	6.4 cm (2.5 in.)	8.9 cm (3.5 in.)	Operator assistance
Width	8.9 cm (3.6 in.)	30.5 cm (12 in.)*	Auto-feed

* The scanner transport will allow feeding a 30.5 cm (12-inch)-wide document but will only scan an area of 29.7 cm (11.7 inches) in width.

Speeds and resolutions

The chart below provides speeds and resolutions for the i800 Series Scanners:

Scanner	Throughput (ppm)	Speed (ips)	Bi-tonal Resolution (dpi)	Color Resolution (dpi)
i810	120	21	200	N/A
	80	14	300, 240	
	45	14	400	
i820	120	21	200	200, 150, 100
	80	14	300, 240	200, 150
	45*	14	400	200
i830	160	28	200	N/A
	106	18.67	300, 240	N/A
	60	18.67	400	N/A
i840	160	28	200	200, 150, 100
	106	18.67	300, 240	300*, 200, 150, 100
	60*	18.67	400	300, 200

* Throughput at these settings may vary based on system limitations.

Scanner specifications Following are the dimensions and clearances for the *Kodak i800 Series* Scanners:

Dimensions

- Height:** 124 cm (49 in.)
- Width:** 66 cm (26 in.)
- Depth:** 127 cm (50 in.)
- Weight:** 204 kg (450 lbs) including packaging
188 kg (414 lbs) without packaging

Minimum clearances

The table below provides the minimum clearances for normal operation and maintenance of the i800 Series Scanners:

	Front	Rear	Right Side	Left Side	Top
Normal Operation	N/A	4 in. 10 cm	4 in. 10 cm	4 in. 10 cm	10 in. 25 cm
Maintenance	40 in. 102 cm	4 in. 10 cm	24 in. 61 cm	4 in. 10 cm	24 in. 61 cm

Acoustic noise

- Operator position standby mode:
 - Sound Pressure Level (L_A): 39.8 dB(A)
- Operator position full system operating mode:
 - Sound Pressure Level (L_A): 65.4 dB(A)
 - Instantaneous Peak Values \geq 130 dB(C) None
- Sound Power Level (L_{WA}):
 - Standby 56.4 dB(A)
 - Full System 72.0 dB(A)

NOTE: All data was measured in accordance with DIN 45635, ANSI S12.10-1985, and ISO 7779 in a hemi-anechoic chamber.

Electrical

- 100 – 127 V, 6.5 A, 50/60 Hz
- 200 – 240 V, 3.5 A, 50/60 Hz

Power system connection

This product is also designed for Norwegian IT power system with phase-to-phase voltage 230V.

Environmental

- Temperature: 15 to 35°C (59 to 95°F)
- Humidity: 15 to 76% (dry bulb)
- Altitude: up to 8000 feet (2438 meters)

External components

See the illustration below for the location of the external components of the scanner.

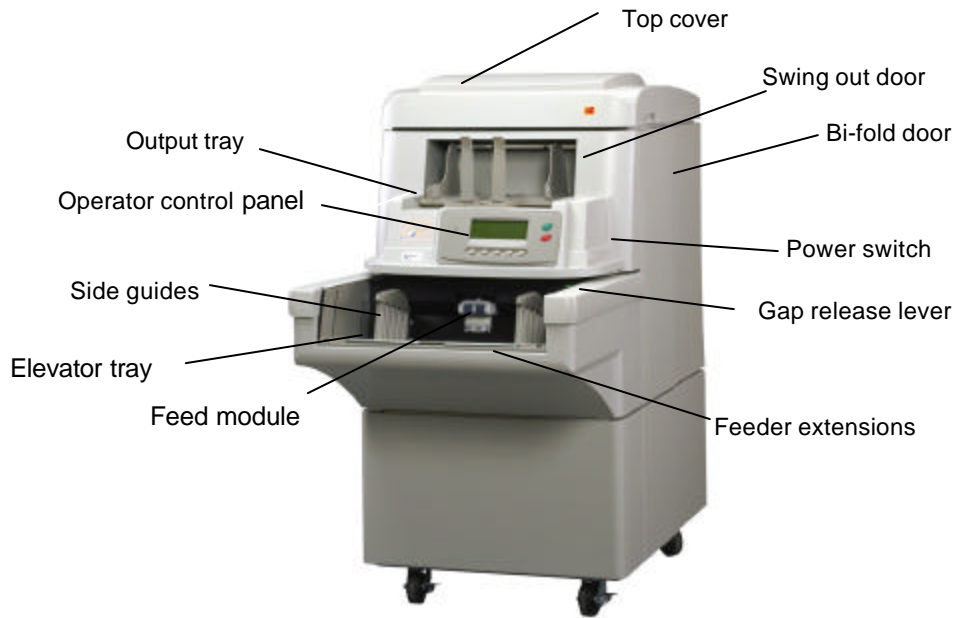

Back of scanner

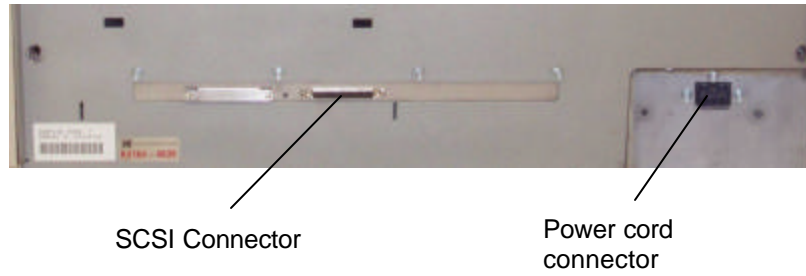

**Environmental
information and
equipment disposal**

- The *Kodak* i800 Series Scanners are designed to meet worldwide environmental requirements.
- Guidelines are available for the disposal of consumable items that are replaced during maintenance or service; follow local regulations or contact Kodak locally for more information
- The product packaging is recyclable.
- Parts are designed for reuse or recycling.
- The *Kodak* i800 Series Scanners contain lead in the circuit boards and mercury in the lamps. Disposal of these materials may be regulated due to environmental considerations. For disposal or recycling information, please contact your local authorities or visit the Electronics Industry Alliance website: www.eiae.org.

2 Using the Scanner

This chapter provides the following operational procedures:

- Turning on the scanner
- Document preparation
- Adjusting the input tray, side guides and output tray
- Scanning documents
- Feeding long documents
- Continuous and manual feeding

Other functions, such as calibration, using the programmable keys, using multi-feed detection, setting the elevator level, etc. can be performed using the Operator Control Panel. See Chapter 3, *Operator Control Panel Functions* for procedures.

Turning on the scanner To turn on the scanner:

- Toggle the power switch to the On position.



When the menu bar is displayed on the Operator Control Panel, the scanner is Ready.



IMPORTANT: *Always power-up the scanner to its Ready state before powering-up the host computer.*

Document preparation

Kodak scanners have been tested with a range of documents that represent the broad spectrum of document types found in the most common business applications. Optimal scanner performance is achieved when you scan documents within the recommended document specifications listed below. Scanning documents that are outside of these specifications may lead to undesirable results in terms of scanner reliability, image quality, and/or consumable life.

Before you start scanning, make sure the documents can be fed through the scanner easily. Best performance is obtained by feeding a good, clean lead edge. This means the side of the paper which enters the feeder first should be in the best possible condition.

Use the guidelines below when preparing your documents for scanning.

- Remove staples, rubber bands, loose mending tape or paper clips.
- Straighten wrinkled edges and tape any torn documents.
- Trim ragged edges (steno paper, perforated edges, tractor feed edges). If ragged edges cannot be trimmed, it is suggested that you try different feeding orientations to determine which orientation feeds best.
- A batch of documents to be fed into the scanner must be arranged to have a common leading edge. Documents may be left-, right-, or center-aligned in the elevator tray allowing the documents to be fed into the scanner one at a time.

IMPORTANT: *Proper alignment of documents is very important. Documents must be fed under both feed module tires.*

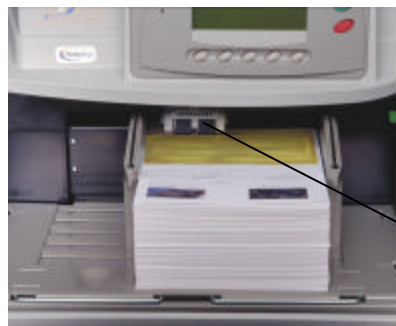

- Torn, damaged, or crushed pages can be transported successfully through the scanner. However, no scanner can transport every possible type of damaged paper. If damaged documents do not feed through the transport automatically, feed the documents manually. Use of the gap release lever may be required.

- For heavily damaged documents, a clear document protector can be used with the following limitations:
 - Manual feeding is recommended when using a clear document protector.
 - The document in the clear document protector must be fed under both feed module tires.
 - Multi-feed detection must be disabled when manually feeding a document in a clear document protector.

NOTE: When using a document protector, feed the fold of the document protector first rather than the open end.

The correct document preparation when using a document protector is illustrated below:

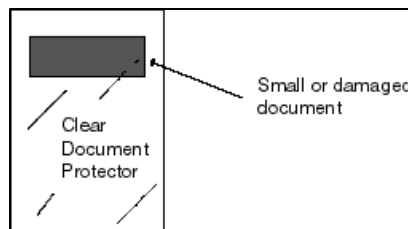

Acceptable document materials

- Original and recycled papers
- Photographic papers
- Bond (i.e., laser, inkjet, etc.)
- Carbonless paper (some types of carbonless papers contain chemicals that may react with feed module and separation tires possibly requiring more frequent tire changes)
- Offset printing papers (i.e., newspapers, magazine pages)

Recommended paper weights

The elevator tray handles a broad range of paper weights, from 50g (13 lb.) bond paper to 200g (110 lb.) index paper. Heavier documents may be fed up to 0.76 mm (0.030 in.). Manual feeding mode, using the gap release lever, may be required to feed heavier paper weights.

Acceptable document sizes

- Length:
 - Maximum of 76.2 cm (30 in.) with operator-assisted document feeding and stacking. 43.2 cm (17 in.) is the maximum length for unattended document feeding.
 - Minimum of 6.4 cm (2.5 in.).
- Width:
 - Maximum of 29.7 cm (11.7 in./image capture – 12 in./transport) (A3 width)
 - Minimum for automatic feeding of 8.9 cm (3.5 in.)
 - Minimum for manual feeding of 6.4 cm (2.5 in.)

Maximum document batch height for automatic feeding

When feeding batched documents, the maximum height of the batched documents is 10.2 cm (4 in.), approximately 1000 sheets of 75g (20 lb.) paper. The elevator tray can be set to accommodate 25-, 250- 500-, 750- 1000-document stacks.

Downward and upward curl documents

The elevator tray can handle some amount of lead edge curl, but to ensure reliable feeding the curl should be at a minimum. It is suggested that you try and minimize the curl before scanning by stacking the documents on a flat surface for a period of time to help flatten the documents.

Adjusting the side guides on the input tray

To accommodate multiple applications with variable feeding requirements, the side guides can be adjusted for center- or edge-feeding. Center-feeding is recommended for best paper handling performance. The side guides can be moved together or independently.

1. Pull the guides all the way out and then push them together (toward the center) to reset.



2. Open the side guides slightly wider than the documents you will be feeding.
3. Place the documents in the elevator tray.
4. Adjust the side guides to fit the documents.

Adjusting the output tray

Different paper types stack differently. The output tray can be set with either the front or the rear higher for best stacking.



To angle the output tray so the back of the output tray is higher:

1. Lift the output tray up and pull it out of its current slot.
2. Reset it in the slot that matches the desired height.

To angle the output tray so the front of the output tray is higher:

- Lift the front of the output tray up, swing the height adjustment leg out and insert it into the groove below the output tray.

NOTE: Short side guides are standard on the output tray. However, tall side guides and self-centering parts are included and can be changed by you. See Chapter 5, *Maintenance* for procedures.

Scanning documents

Before you scan documents, be sure the menu bar is displayed on the Operator Control Panel.



Documents must be fed under both feed module tires. For faster throughput, feed documents into the elevator tray in landscape orientation (longer side as the leading edge).

To start scanning:

1. Enable the scanner from the host.
2. Place the documents to be fed in the elevator tray.
3. Press **Start/Resume**.

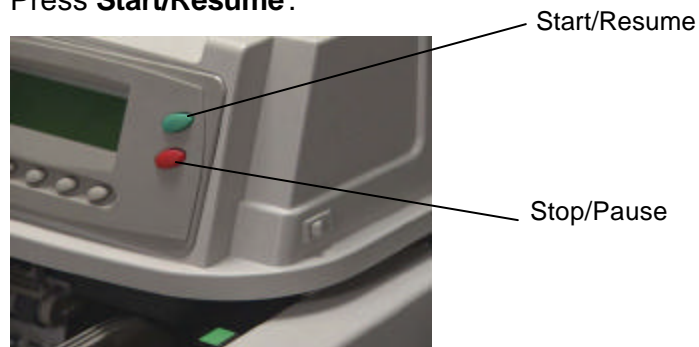

NOTES:

- Documents must be fed under both feed module tires.
- Do not lean on the elevator tray and/or document extenders while the scanner is running. If this happens, the elevator tray may make some noise and stop in position. See the Problem Solving Chart in Chapter 6, *Troubleshooting/Messages* for procedures on recovery from this situation.
- Use caution when feeding small documents; small documents may fall through the slots of the elevator tray and cannot be easily retrieved.

To stop scanning:

- Press **Stop/Pause**.

Loading long documents in the feeder

The feeder accommodates documents up to 76.2 cm (30 in.) in length. To feed documents longer than 30.5 cm (12 inches):

1. Pull out the document extenders.

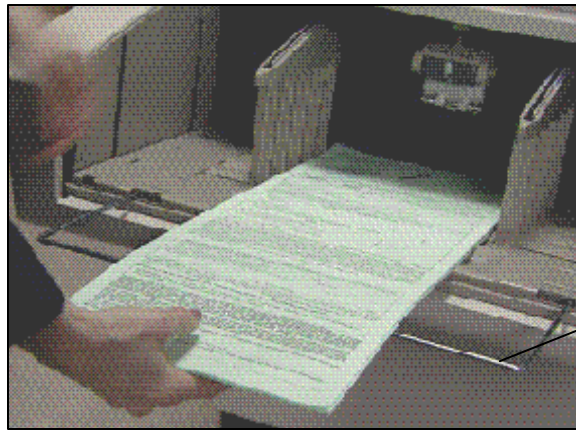

2. Place the documents in the elevator tray.

NOTE: Operator assistance is required when feeding documents longer than 43.2 cm (17 in.).

Continuous and manual feeding

Continuous feeding allows you to place additional batches of documents in the elevator tray (with operator assistance). Any time during continuous scanning, additional documents can be added at the bottom of the input stack. The elevator position must be set to 25 for continuous and manual feed operations.

To add to a batch of documents:

- Add a small stack of documents to the bottom of the batch in the elevator tray, by gently lifting the corner of the stack and adding the documents underneath the last document.

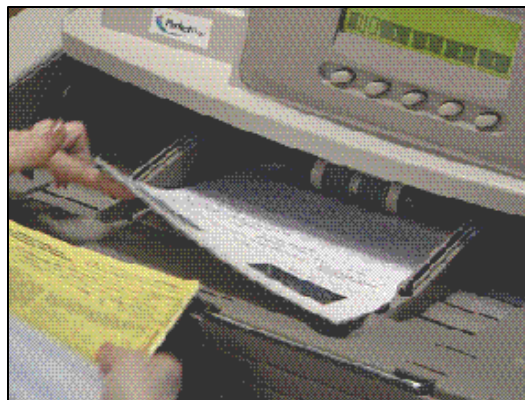

Manual feeding is recommended when you have a heavily damaged document, envelope or other thick documents, which may require additional clearance. Follow the guidelines for document size, weight, quantity, etc. outlined in the section entitled, "Document preparation" earlier in this chapter.

Feeding thick documents

To feed thick documents:

1. Press and hold the gap release lever — this provides more clearance to ease document feeding.



2. Push the envelope/thick document into the transport. If more than one document is to be scanned, feed them into the transport one at a time.
3. After the documents have been fed into the transport, release the gap release lever.

NOTE: Before feeding envelopes:

- Disable multi-feed detection via the host or programmable button (if the scanner is set up for multi-feed detection.)
- Be sure the envelope is empty and unsealed.
- When using the gap release lever, the maximum thickness allowed for a document is 0.76 mm (.030 inches).

3 Operator Control Panel Functions

There are a variety of functions available from the Operator Control Panel. This chapter provides procedures and information for:

- Enabling and disabling the scanner
- Control Panel functions overview
- Navigating through the functions on the Control Panel menu
- Accessing information
- Lowering the elevator tray
- Using the Diagnostics Settings menu
- Performing Diagnostic functions:
 - Performing a self-test or extended self-test
 - Running in count-only mode
 - Performing a print test
 - Performing a patch test
- Using the Setting menu:
 - Changing the alarm volume
 - Changing the display contrast
 - Changing the SCSI ID
 - Changing the SCSI termination
 - Setting the elevator tray position
- Calibrating the scanner
- Jogging the transport
- Programmable key assignments

Enabling and disabling the scanner

The five buttons at the bottom of the Control Panel correspond to the icons above the buttons. To activate the icons, press the corresponding button.

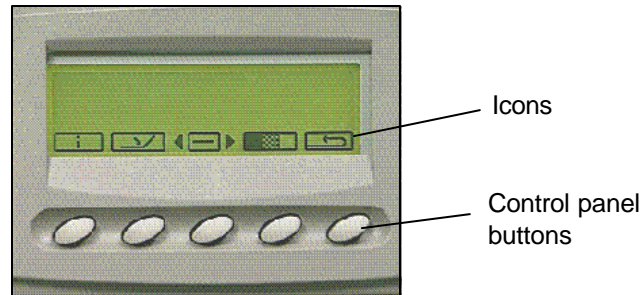

Enabling the scanner

The scanner can only be enabled from the host computer. When the scanner is enabled, you can change the image address level, override the elevator setting and use the programmable keys. When enabled, the icons on the Operator Control Panel will look like this:



These functions can be performed when the scanner is enabled:

- Increments the image address level. Depending on the image address level the icon may appear as follows:
 - indicating the next image address is level 3
 - indicating the next image address is level 2
 - indicating the next image address is level 1
- ☑ Lowers the elevator tray if it is not already in the lowest position.
- 1 Performs the first programmable function.
- 2 Performs the second programmable function.
- 3 Performs the third programmable function.

NOTE: Programmable keys are set-up during application setup. Check with your system administrator for the function of each programmable key. Possible programmable key assignments are as follows:

- No scanner functionality (default)
- Scanner End-of-Job
- Terminate Batch
- Omit Multi-feed Detection on Next Document
- Omit Printing on Next Document
- Omit Patch Reading on Next Document





Disabling the scanner

The scanner can be disabled from the host computer or the scanner, if the end-of-job function is assigned to one of the programmable keys. When the scanner is disabled, you can display scanner information, lower the elevator tray, use the Diagnostics Settings menu, calibrate the scanner and jog the transport.

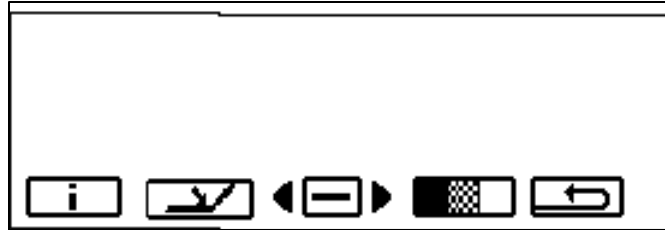
Disabled scanner functions





When the scanner is first powered on and disabled, the following icons will be displayed. These functions can only be performed when the scanner is disabled.

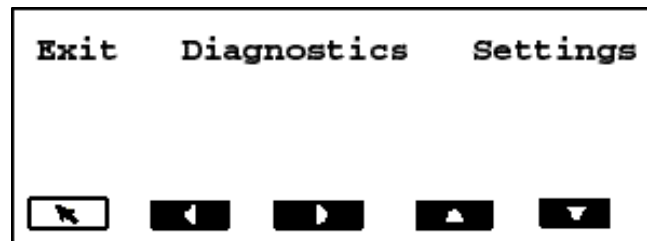

-  Displays information: including the last image address, meter values, scanner serial number.
-  Lowers the elevator tray if it is not already in the lowest position.
-  Displays the Diagnostics Settings menu, which allows you to perform additional functions.
-  Calibrates the scanner.
-  Temporarily turns on the transport to help clear a document jam.

When the Diagnostics Settings menu button  is selected, these functions are available:



-  Performs the selected function. *This button is referred to as **Return**.*
-  Moves left to the next selectable item (left arrow).
-  Moves right to the next selectable item (right arrow).
-  Moves up to the next selectable item (up arrow).
-  Moves down to the next selectable item (down arrow).

Navigating through the functions on the control panel menu

The left and right arrows navigate along the top of the menu bar.

In this example, the left and/or right arrow will rotate through the options of Exit, Diagnostics and Settings.

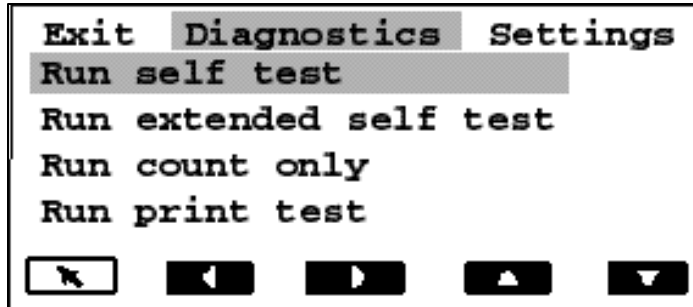

The up and down arrows navigate through the menu selections.

In this example, the up and/or down arrow will rotate through the options of Run self test, Run extended self test, Run count only, Run print test, Run patch test.

NOTE: Only four options can be displayed at a time. Selecting the down arrow will display additional options.

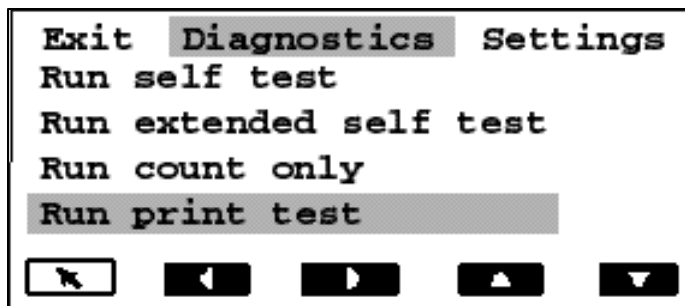

-  The Return arrow performs the selected function. In the example above, after you select **Run print test**, select the Return arrow to perform a print test.

Accessing information



The information icon will display information including the last image address, meter values, and scanner serial number.

- Select this icon to display information.

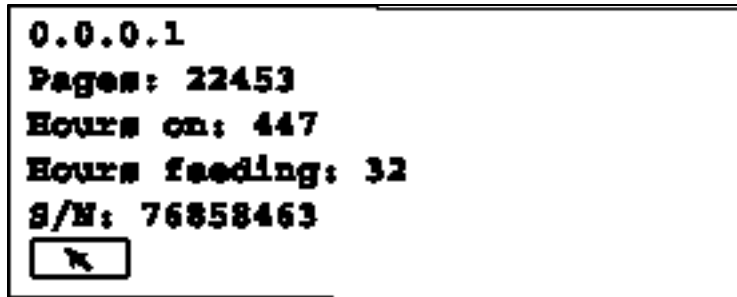

Lowering the elevator tray



The level of the elevator tray can be set to accommodate various sizes of document batches.

- Select this icon to lower the elevator tray to its lowest position.

NOTE: This will temporarily override the setting, which is configured for elevator position from the Settings menu. The next time the scanner is enabled from the host the menu setting will resume.

Using the Diagnostics Settings menu



The Menu icon displays the Diagnostics Settings menu.

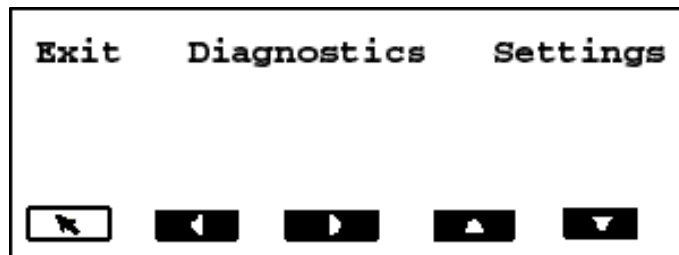

The following Diagnostics functions are available:

- Performing a self-test
- Performing an extended self-test
- Running in count-only mode
- Performing a print test
- Performing a patch test

Performing a self-test or extended self-test

You can perform a self-test or an extended self-test on the scanner. The self-test is the same test performed when the scanner is powered-up; the extended self-test is a more thorough test.

To perform a self-test or extended self-test:

1. Select the Diagnostics Settings menu  icon.
2. Use the right or left arrow to navigate to the Diagnostics function.
3. Use the down arrow to select **Run self-test** or **Run extended self-test**.

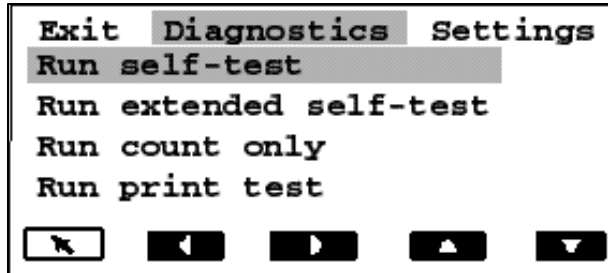

4. Select **Return**. The scanner will run the self-test and report the results on the display.

Running in count-only mode

You may want to count the number of documents entering the scanner without actually scanning.

To run in count-only mode:

1. Select the Diagnostics Settings menu  icon.
2. Use the right or left arrow to navigate to the Diagnostics function.
3. Use the down arrow to select **Run count only**.

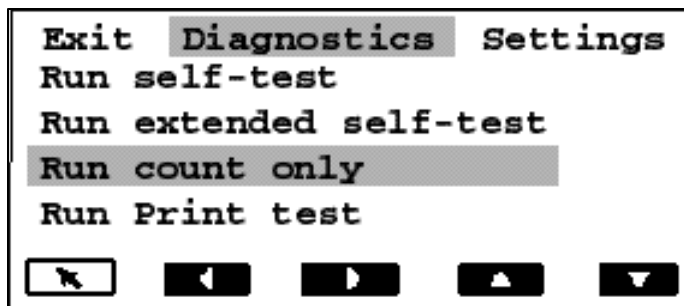

4. Place the documents in the elevator tray.
5. Select **Return**. The message **Counting Pages** will be displayed.
6. Press **Start/Resume**. The page count will be displayed.

Performing a print test

The print test checks to be sure the ink jets in the Document Printer are functioning properly.

To perform a print test:

1. Select the Diagnostics Settings menu  icon.
2. Use the right or left arrow to navigate to the Diagnostics function.
3. Use the down arrow to select **Run print test**.

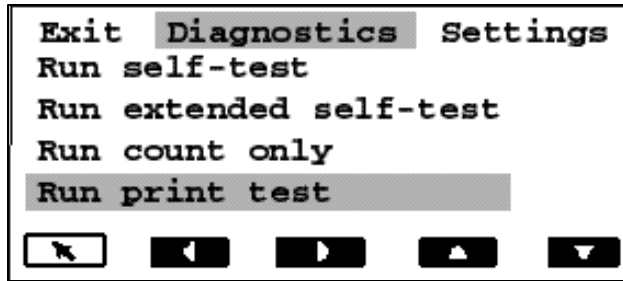

4. Select **Return**.
5. Feed a blank(s) sheet of paper.
6. Press **Start/Resume**.
7. Press **Stop/Pause**. The documents in the output tray will display the results of the print test.
8. Remove the documents from the output tray and evaluate the appearance of the test pattern.
 - If the pattern is complete, you are ready to begin.
 - If the pattern is not legible:
 - Check to see that the print cartridge is installed properly and purge the ink cartridge if necessary. Repeat the print test. See Chapter 4, *Document Printer and Patch Reader*, for more information.
 - If the pattern is still not legible, replace the ink cartridge.

Performing a patch test

Use this test to verify that the Patch Reader is operational and that your patches are within specification.

To perform a patch test:

1. Select the Diagnostics Settings menu  icon.
2. Use the right or left arrow to navigate to the Diagnostics function.
3. Press the down arrow until **Run Patch test** is displayed on the Operator Control Panel.

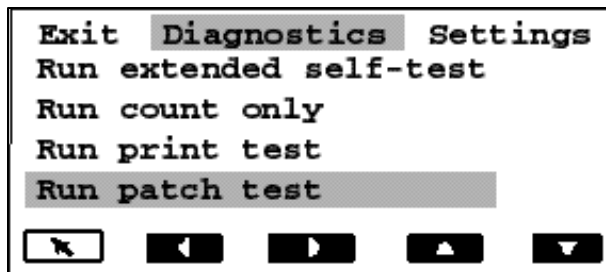

4. Select **Return**.
5. Feed a document(s) with a patch(es).
6. Press **Start/Resume**. When the documents have been scanned, the document count and number of patch types recognized by the scanner will be displayed.
7. Press **Stop/Pause**.

Using the Settings menu

The Menu icon  displays the Diagnostics Settings menu.

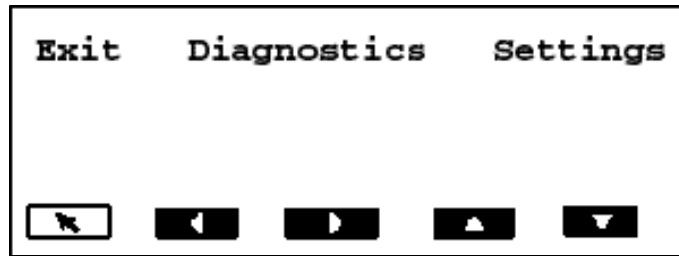

The following Settings functions are available:

- Changing the Alarm Volume
- Changing the Display Contrast
- Changing the SCSI ID
- Changing the SCSI Termination
- Setting the Elevator Position

Changing the alarm volume

This setting allows you to adjust the volume of the alarm from 0 to 4. 1 = quietest; 4 = loudest; 0 = no sound.

To set the alarm volume:

1. Select the Diagnostics Settings menu  icon.
2. Use the right or left arrow to navigate to the Settings function.
3. Use the down arrow to **Change Alarm Volume**.

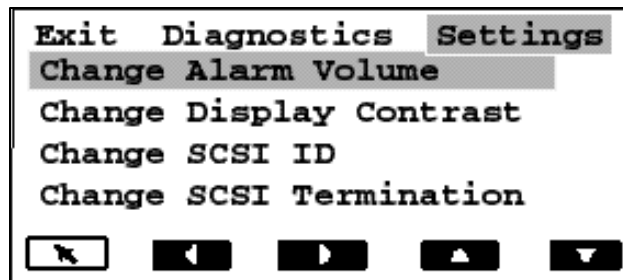

4. Select **Return**.

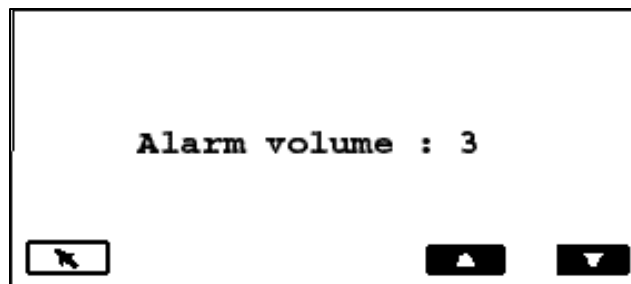

5. Use the up or down arrows to select the desired volume.
6. Select **Return**.

Changing the display contrast

This setting allows you to adjust the contrast of the display screen from 0 to 4. 0 = lightest, 4 = darkest.

To change the display contrast:

1. Select the Diagnostics Settings menu  icon.
2. Use the right or left arrow to navigate to the Settings function.
3. Use the down arrow to select **Change Display Contrast**.

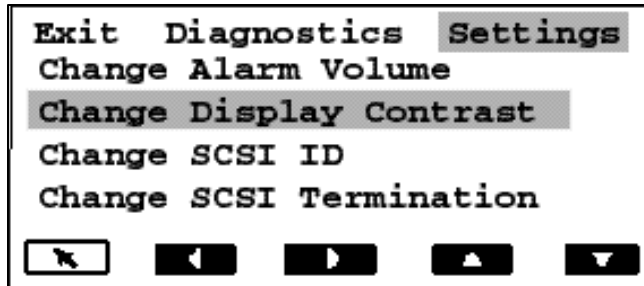

4. Select **Return**.



5. Use the up and down arrows to select the desired contrast.
6. Select **Return**.

Changing the SCSI ID

This setting allows you to enter the SCSI ID number (0 to 7). The SCSI ID should not be changed unless directed to do so by your integrator or Kodak Field Representative.

If the SCSI ID has been changed, you must reboot the scanner. After the scanner has been powered up and completed the self-test, reboot the host PC.

To change the SCSI ID:

1. Select the Diagnostics Settings menu  icon.
2. Use the right or left arrow to navigate to the Settings function.

- Use the down arrow to select **Change SCSI ID**.

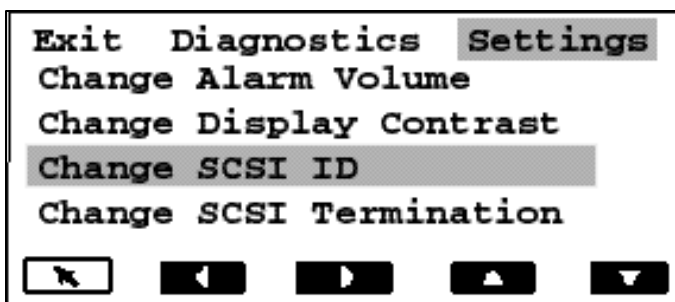

- Select **Return**.

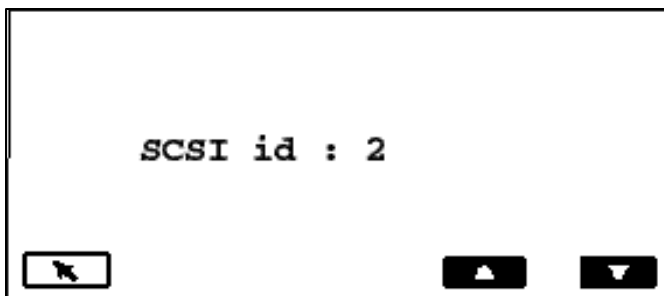

- Use the up and down arrows to select the desired SCSI ID number.
- Select **Return**.
- Turn the scanner off. Wait at least 10 seconds and turn the scanner back on again.
- After the scanner has completed the self-test, reboot the host PC.

Changing the SCSI termination

This setting allows you to change the SCSI termination. Values are 0 (disabled) or 1 (enabled). By default, the SCSI termination is enabled and remains enabled until you disable it and reboot the scanner. The SCSI termination should not be changed unless directed to do so by your integrator or Kodak Field Representative.

To change the SCSI termination:

- Select the Diagnostics Settings menu  icon.
- Use the right or left arrow to navigate to the Settings function.
- Use the down arrow to select **Change SCSI Termination**.

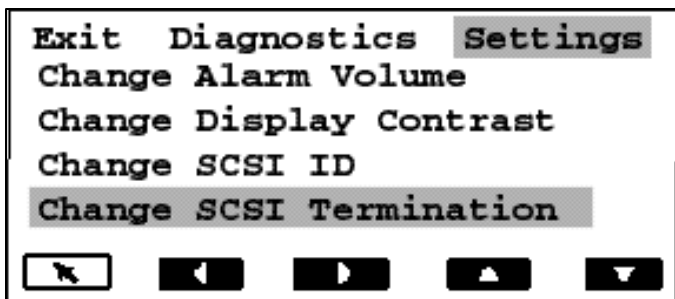

4. Select **Return**.

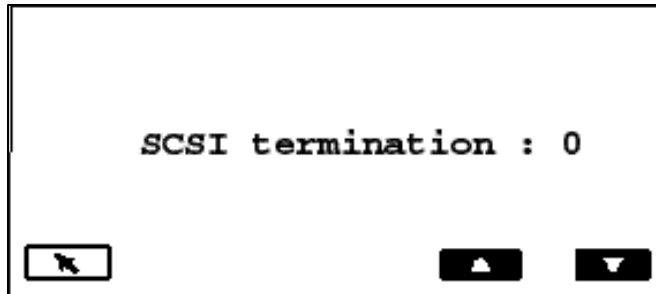

5. Use the up and down arrows to select the desired SCSI termination setting.
6. Select **Return**.
7. Turn the scanner off. Wait at least 10 seconds and turn the scanner back on again. The new termination setting will take effect.

Setting the elevator tray position

This setting allows you to select a position of the elevator tray. Elevator positions can be set to accommodate 25-, 250-, 500-, 750- or 1000- documents (20-lb bond paper). The position will remain as selected unless the Override Elevator icon () is selected.

NOTE: The setting of 25 should be used for manual or continuous feed operation.

To set the elevator tray position:

1. Select the Diagnostics Settings menu  icon.
2. Use the right or left arrow to navigate to the Settings function.
3. Press the down arrow until **Set elevator position** is displayed on the Operator Control Panel.

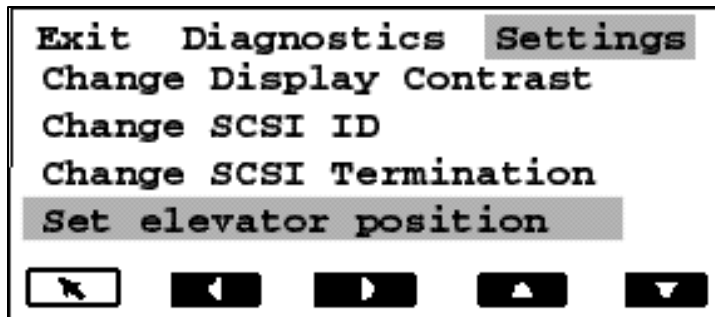

4. Select **Return**.

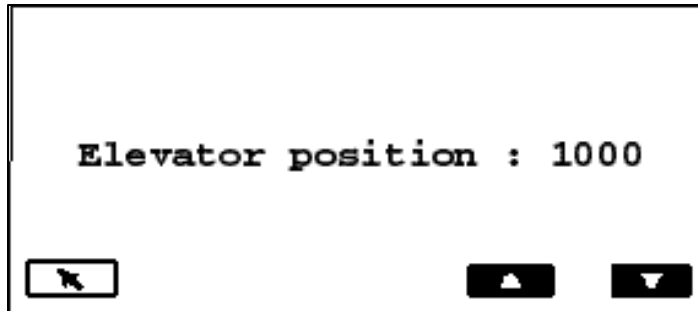

5. Use the down arrow to select the desired elevator position.
6. Select **Return**. The elevator position takes effect after the scanner is enabled.

Calibrating the scanner



Calibration optimizes your scanner to achieve the best image quality and feeding performance. The scanner can only be calibrated when it is disabled.

You should calibrate:

- when a message is displayed requiring calibration
- when image quality is poor
- when paper handling is degraded (false multi-feeds)
- after cleaning the scanner

Use the calibration target (shown below) provided with your scanner. Be sure to use a good, clean calibration target. Additional calibration targets can be ordered. See Chapter 5, *Maintenance*, "Ordering Supplies" for more information.

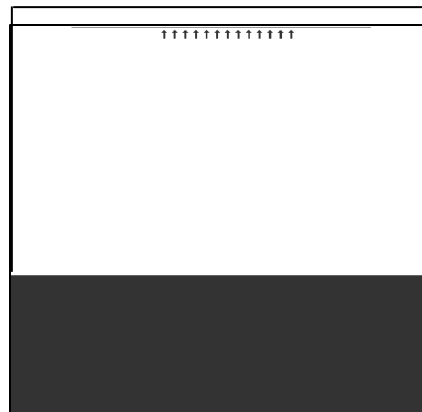

To calibrate the scanner:

1. Select the Calibrate  icon.
2. Place the calibration target in the elevator tray face up, arrows first.
3. Press **Start/Resume**.
4. Place the calibration target in the elevator tray face down, arrows first.
5. Press **Start/Resume**. Calibration results will be displayed.

Jogging the transport



The Jog button temporarily (4 seconds) turns on the transport to help clear a document jam. This function is only available when the scanner is disabled. The Jog button is intended to clear simple document jams. If documents are lodged in several locations within the scanner, use the procedures in Chapter 6, *Troubleshooting/Messages*.

If a document jam occurs:

- Select the Jog  icon.

Programmable key assignments

There are three programmable keys on the Operator Control Panel. These keys can be assigned functions by the host application.

Programmable keys are available for use when the scanner is enabled. The Operator Control Panel displays the numbers 1 through 3. These numbers correspond to the buttons on the Control Panel.

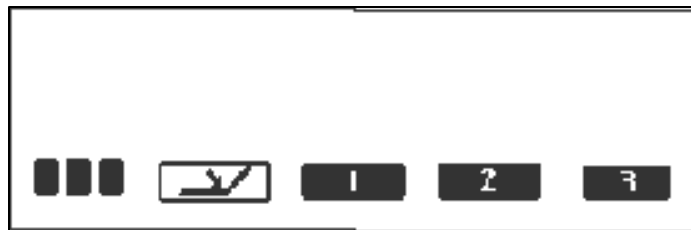

Each of the programmable keys can be assigned the following functions:

- No Scanner Functionality (default)
- Scanner End-of-Job
- Terminate Batch
- Skip Multi-feed Detection
- Skip Printing
- Skip Patch Recognition

Check with your System Administrator to determine what functions are programmed.

4 Document Printer and Patch Reader

This chapter provides instructions for using the *Kodak Imagelink* Document Printer 1 and the Patch Reader. The following can be found in this chapter:

- Purging the ink cartridge
- Replacing the ink cartridge
- Replacing the ink blotter strips
- Setting the printer position
- Patch types supported by the Patch Reader
- Setting the Patch Reader position

The Document Printer

The Document Printer 1 uses a standard ink cartridge, which is an inexpensive and effective way to apply information to the scanned document and utilize document management systems such as batching and time-stamping.

The Document Printer 1 provides a print capability that is programmed to support alphanumeric characters as defined by the host. It supports date, image address, time, document count and custom messages. All print information is captured in a document header record. All printer controls and functions are accessible via the ISIS and TWAIN drivers.

Printed information

The information printed by the Document Printer is defined during application setup by your system administrator or integrator.

Any combination of the following items can be printed, provided the total length does not exceed 40 characters.

- Document image address (any, all or none of the four image address fields, in any order)
- Date
- Time
- Document count
- Messages - up to 6 fields can be defined to build a print string

The Document Printer can print one line per document.

The information printed by the Document Printer appears in a single column perpendicular to the leading edge of the document(s) as shown:

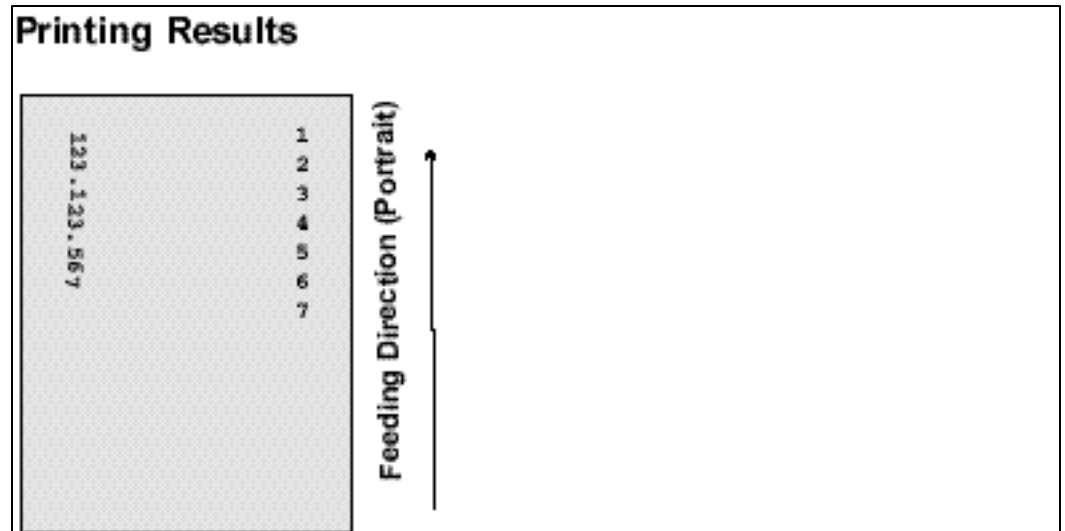

Font size: two different character sizes, referred to as Large and Small, are available. The way the characters appear on the document will be dependent on the way your application is set up.

Character orientation: information is printed on each document in either a Cine or Comic orientation.

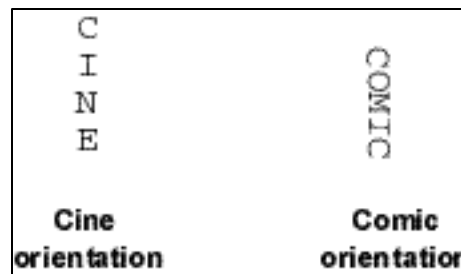

Horizontal print position

The horizontal print position is set using one of the 13 positions in the Document Printer well. Print position can be manually changed as required.

To change the print position:

1. Open the swing out door.
2. Slide the green ink cartridge carrier out of its slot.

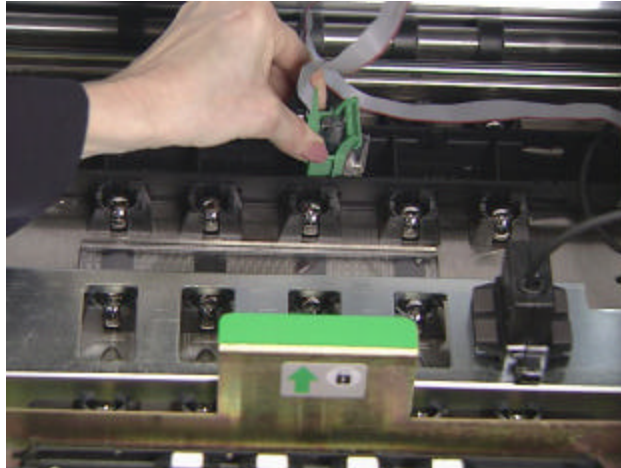

3. Move the ink cartridge to the desired position and insert it into the appropriate slot
4. Close the swing out door.

NOTE: Printing automatically stops ½-inch (1.27 cm) from the trailing edge of the document, even if the information has not been completely printed.

Purging the ink cartridge Additional ink cartridges can be purchased from an office supply retailer nearest you.

NOTES:

- If the Document Printer will not be used for a period of time (24 hours or more), remove the Document Printer from the carrier and place it on its side until you are ready to use it.

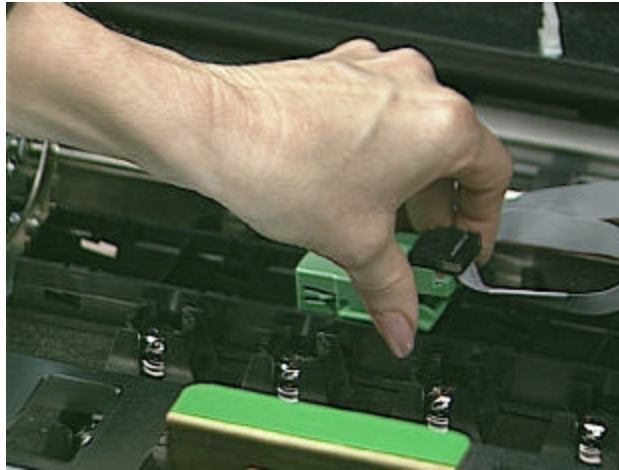

- Ink cartridges may be disposed of in accordance with local regulations.

Before installing the ink cartridge, it must be purged. Cartridges may also require purging when the print quality is unacceptable. Follow the steps below to purge the ink cartridge.

1. Remove the ink cartridge from the box and inner wrappings.
2. Hold the cartridge and insert a straightened paper clip into the large hole on top of the ink cartridge.

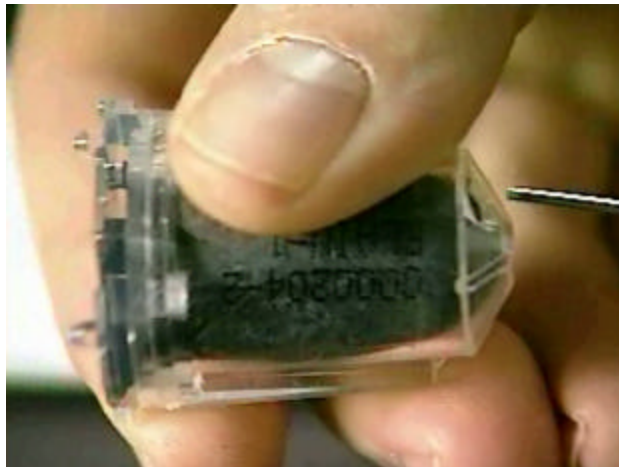

3. Rotate the ink cartridge until the bottom is face up.

4. Gently press the paper clip against the side of the ink bladder until a small bead of ink appears on the ink flow point on the ink cartridge.

CAUTION: Do not puncture the ink bladder with the paper clip.

5. Remove the paper clip.
6. Allow the ink bead to absorb back into the ink cartridge.



7. Blot the excess ink with a lint-free tissue.

CAUTION: Do not touch the ink flow point or you may cause improper ink flow.

Replacing the ink cartridge

Replace the ink cartridge when any of the following conditions occur:

- The ink bladder appears shrunken or deflated.
- The printed characters appear light or uneven.
- Missing characters are evident.
- The Print Test function reveals inconsistent character quality.
- The cleaning procedure has not improved the overall print quality.

To replace the ink cartridge:

1. Open the swing out door.
2. Slide the green ink cartridge carrier out of its slot.

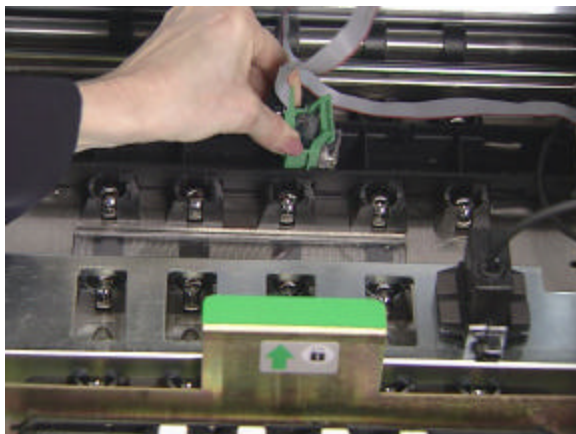

3. Raise the locking bar if it is not already in the raised position and remove the empty ink cartridge.

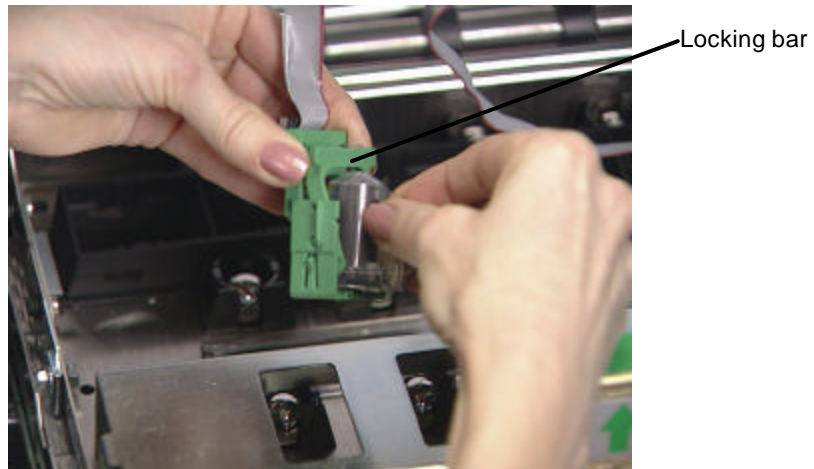

4. Insert a new, purged ink cartridge.
5. Lower the locking bar around the ink cartridge.
6. Slide the green ink cartridge carrier back into its slot.
7. Close the swing out door.

IMPORTANT:

- *Dispose of ink cartridges properly. Do not incinerate ink cartridges.*
- *The printer cable should always be kept in place by the white clip to prevent the cable from interfering with the imaging path.*

Replacing the ink blotter strips

Ink blotter strips collect ink overflow. They should be replaced when there is a build-up of ink. Replacement blotter strips may be purchased through your supplier. See Chapter 5, *Maintenance*, for a list of available supplies. To replace the ink blotter strips:

1. Open the swing out door.
2. Lift the horizontal transport plate.



3. Remove the horizontal belt module.



4. Locate the blotter strips. You can replace one, some or all of the strips as necessary.

5. Grasp a blotter strip and carefully pull it off the transport. Discard the soiled strips.

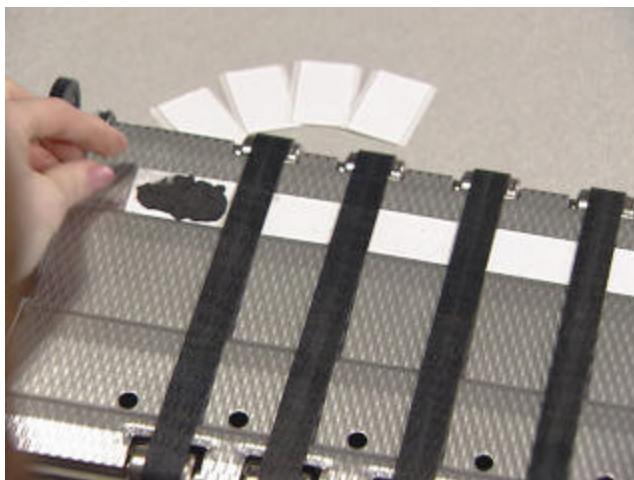

6. Install the new blotter strip. Make sure that you align it in the transport channel before pressing the adhesive side into the channel.

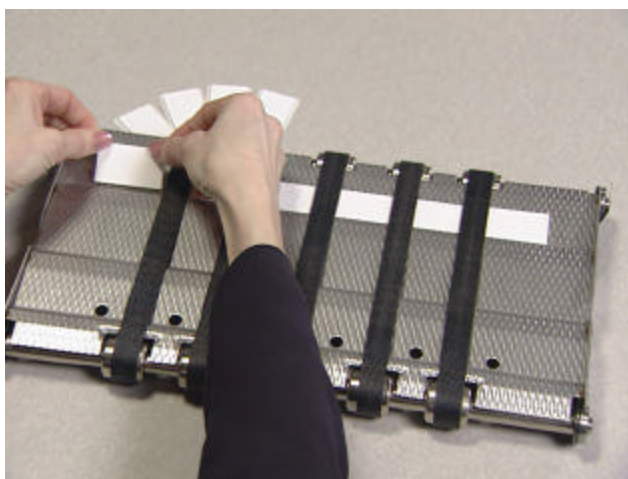

7. Re-insert the horizontal belt module.
8. Lower the horizontal transport plate.
9. Close the swing out door.

Setting the printer position

There are 13 possible positions for the printer. Make sure that the printer is in the correct position for your documents.

1. Open the swing out door.
2. Locate the printer positioning slots.
3. Determine which position is suitable for your printing needs.
4. Slide the green ink cartridge carrier out of its slot.

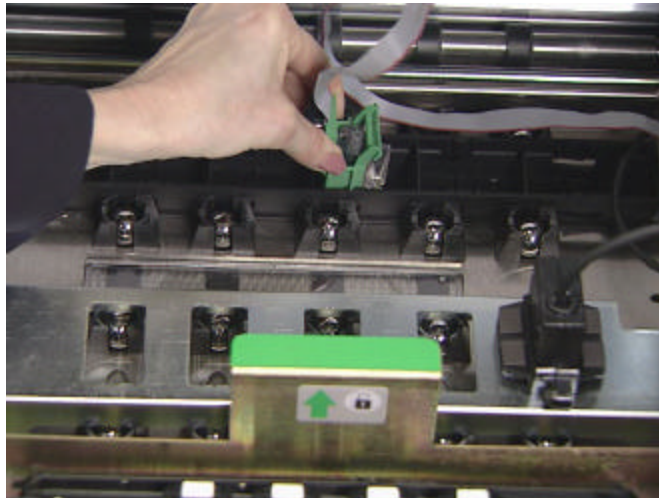

5. Slide the green ink cartridge carrier into the desired slot.

IMPORTANT: *The printer cable should always be kept in place by the white clip to prevent the cable from interfering with the imaging path.*

6. Close the swing out door.

The Patch Reader

The Patch Reader allows you to automatically increment the image address or initiate a special function. Patch sheets are placed in front of each document during document preparation or on the lead sheet of a document.

There are 5 possible patch head positions. The patch head position can be easily changed. Recognition of all patch types will be returned in the image header. This is in addition to document level information.

See Kodak publication A-61599, *Patch Code Information*, for complete information.

Patch types

Patch Types 1, 4 and 6 — these patch types can be used by the host for post-scan image control (they are not used for image addressing). For example, use these patch types for changing between bi-tonal and color imaging or workflow control.

IMPORTANT: *Do not use these illustrated patches for production – they are not to spec.*

Patch 1



Patch 4



Patch 6



Toggle Patch — the Toggle patch is a Type 4 patch that is used to trigger the scanner to switch from the current image stream (bi-tonal) to the alternative image stream (color).

Toggle Patch

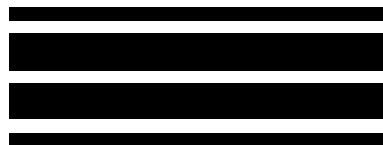

Patch Types 2, 3 and T — these patch types are used for image addressing. When the Patch Reader detects a patch, it automatically assigns a new image address to the new document. This eliminates the task of trying to determine where one document stops and the next starts when you are viewing electronic images. It provides a hierarchical document structure and offers an auto-batching alternative.

The Patch Reader controls document level changes by automatically sensing a predefined patch code and changing the document level accordingly.

IMPORTANT: *Do not use these illustrated patches for production – they are not to spec.*

Patch 2 — assigns a Level 2 to the *current* document



Patch 3 — assigns a Level 3 to the *current* document



Patch T/Transfer Patch — assigns a predetermined level to the *next* document



The Transfer Patch Definition is also defined by the application. The Transfer Patch Definition controls the level assigned to the next document when a Transfer Patch is used. For example, if the Transfer Patch Definition for the current operation is defined as Level 3 and a Transfer Patch is used, the next document will be assigned Level 3.

Patch code placement

Patches must appear parallel to the leading edge of the document:

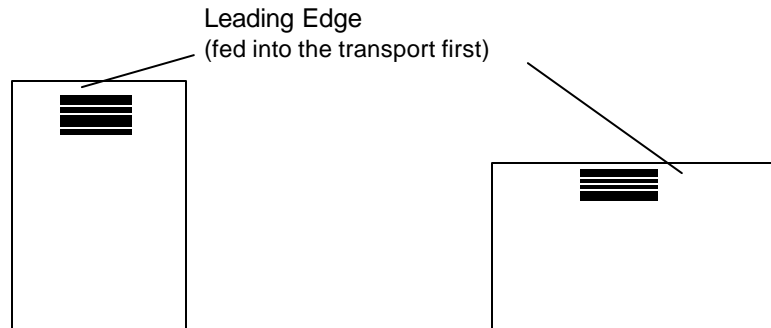

Setting the Patch Reader position

There are 5 patch locations available for patch reading.

1. Set the documents in the elevator tray.
2. Open the swing out door.
3. Align the patch head with the location of the patch on the documents.



4. Close the swing out door.

NOTE: If patches on the documents change location, repeat the procedure above for the new location.

5 Maintenance

This chapter provides cleaning and replacement procedures for your scanner. For best scanner performance clean the areas outlined in this chapter every 8-hour shift, unless otherwise noted.

Additional maintenance supplies can be ordering by calling DI Supply or through your Kodak Reseller. For a list of available supplies, see the section entitled, "Ordering Supplies" at the end of this chapter.

IMPORTANT: *All cleaning supplies can be disposed of in your normal waste management system, unless otherwise noted.*

Use the green handles when accessing scanner components.

Cleaning the paper path

The paper path should be cleaned with a Paper Path Cleaner fed several times through the transport. To clean the paper path:

1. Remove the wrapping from the Paper Path Cleaner.
2. Adjust the feeder guides to the widest position.
3. Run the scanner in count-only mode. See Chapter 3, *Operator Control Panel Functions*, for procedures.



4. Feed the cleaning sheet (adhesive side up) in the landscape orientation several times through the transport.
5. Feed the cleaning sheet (adhesive side down) in the landscape orientation several times through the transport.

NOTE: When a cleaning sheet gets dirty, discard it and use a new one.

Cleaning the upper transport area

Follow the steps below to clean the upper transport area:

1. Open the top cover.



2. Open the bi-fold door.



3. Grasp the end of the lower imaging guide and slowly pull it straight out.



4. Place the lower imaging guide on a clean surface.
5. Grasp the end of the upper imaging guide and slowly pull it straight out.

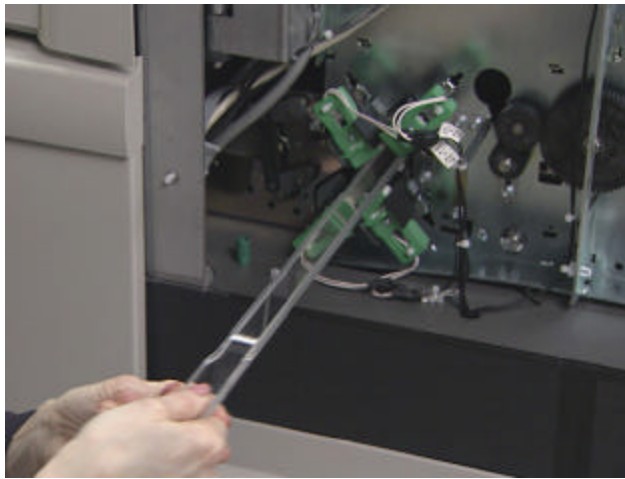

6. Place the upper imaging guide on a clean surface.

NOTE: To avoid getting any debris (from the cleaning process) on the imaging guides, they will be reinstalled after the scanner is thoroughly cleaned.

7. Release the top turn baffle.



8. Vacuum the area.

9. Close the top turn baffle.

10. Lift and hold the exit transport plate and vacuum.



11. Lower the exit transport plate.

Cleaning the vertical transport area

Follow the steps below to clean the vertical transport area:

1. Grasp the vertical transport plate and pull it down until it stops.



2. Slide the horizontal baffle plate out and vacuum inside the housing.

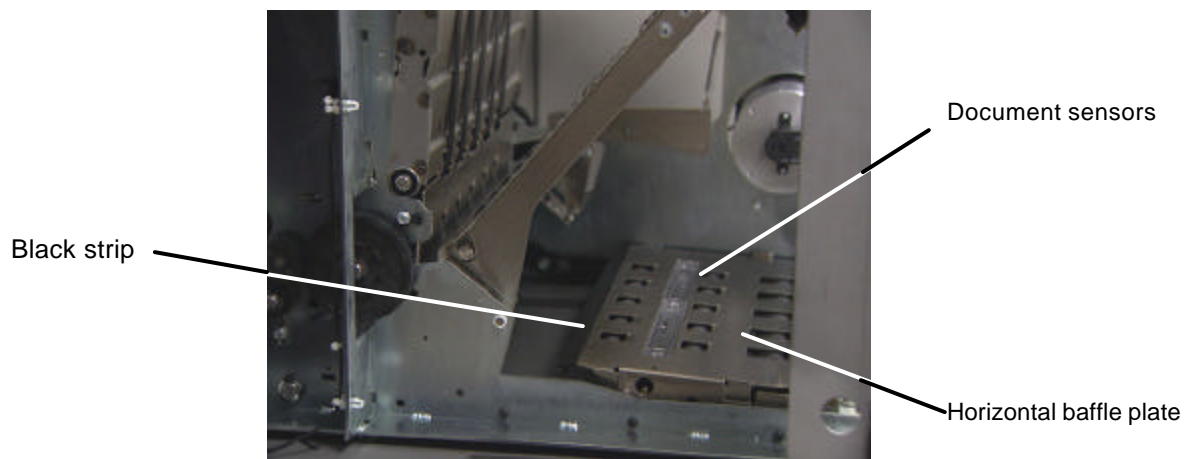

3. With a soft cloth, wipe the document sensors and the black strip on the horizontal baffle plate.

IMPORTANT: *When vacuuming the scanner, be careful not to scratch the sensors.*

4. Clean the document sensors.
5. Slide the horizontal baffle plate back in place.

6. Vacuum the floor of the lower transport area.



7. Raise the vertical transport plate into its original position.
8. Turn the vertical transport plate handle and latch it into place.
9. Close the bi-fold door.
10. Close the top cover.

Cleaning the transport area

Follow the steps below to clean the transport area:

1. Open the swing out door.



- Lift the roller cover and vacuum the sensors.

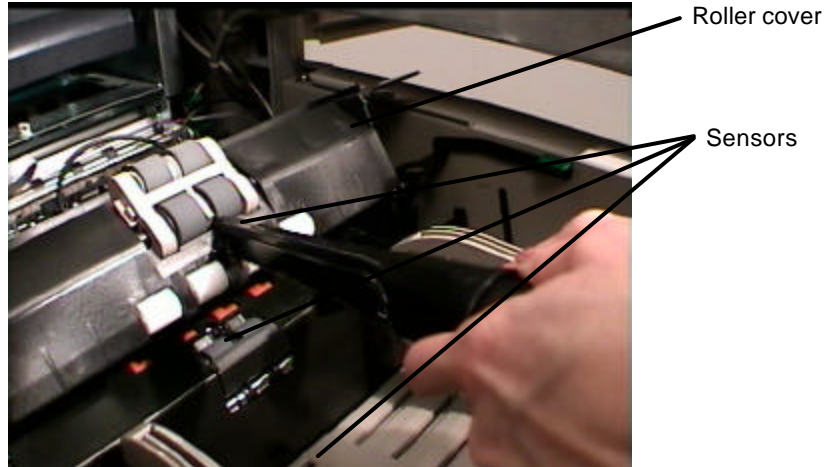

IMPORTANT: *When vacuuming the scanner, be careful not to scratch the sensors.*

- Close the roller cover.
- Lift the horizontal transport plate.



- Remove the horizontal belt module.

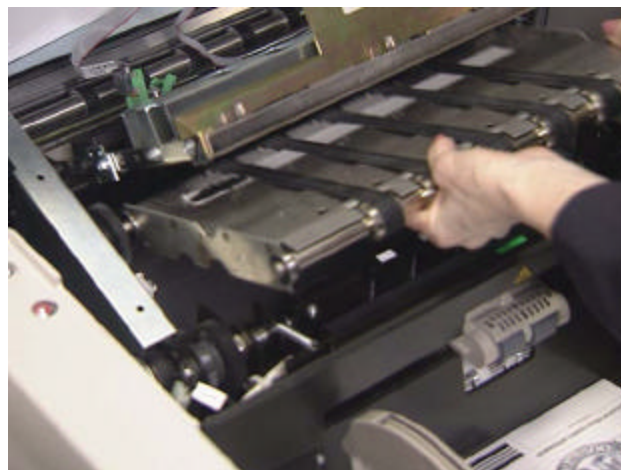

6. Vacuum the floor of the horizontal transport area.
7. Wipe the upper and lower sensors with a lint-free cloth.

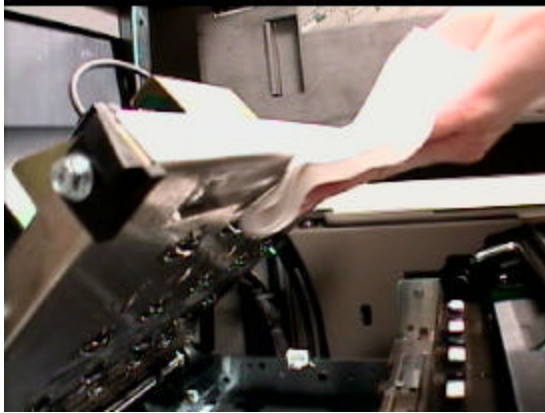

8. Reinstall the horizontal belt module.
9. Lower the horizontal transport plate.

Cleaning the printer and patch head

Follow the steps below to clean the Document Printer 1 and Patch Reader head. Complete instructions for the Document Printer and Patch Reader can be found in Chapter 4.

1. Remove the Document Printer head and clean it with a dry, lint-free cloth.

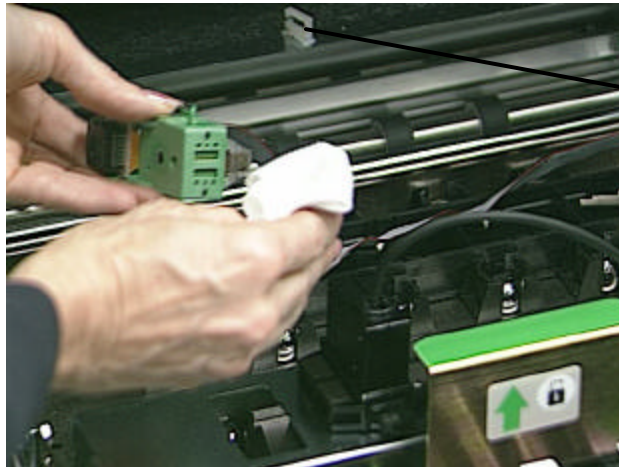

White clip

2. Reinstall the Document Printer head in the desired position.

IMPORTANT: *Be sure the cable is always kept in place by the white clip to prevent the cable from interfering with the imaging path.*

3. Remove the patch head and clean it with a dry, lint-free cloth.



4. Replace the patch head in the desired position.
5. Close the swing out door.

Cleaning the imaging guides

Avoid getting fingerprints on the imaging guides during the cleaning procedure.

1. Open the bi-fold door.
2. Get the upper imaging guide that was set aside previously. Clean the upper imaging guide with a clean, soft, lint-free cloth slightly moistened with water. Lightly wipe both sides with a Staticide wipe.



3. Reinstall the upper imaging guide. Make sure the notched side is facing up and that the imaging guide is pushed in all the way and fully seated in its slot.

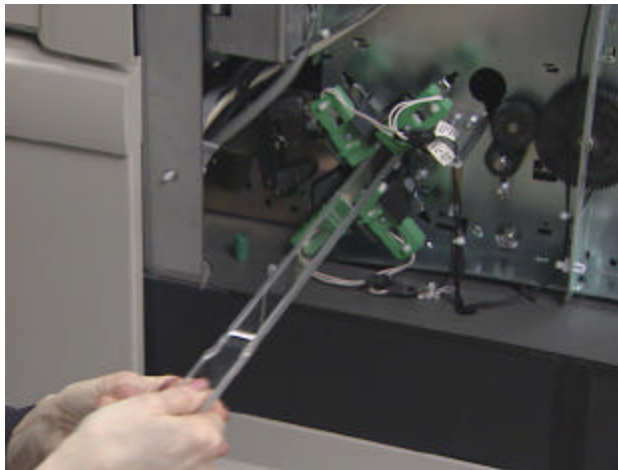

4. Get the lower imaging guide that was set aside previously. Clean the lower imaging guide with a clean, soft, lint-free cloth slightly moistened with water. Lightly wipe both sides with a Staticide wipe.
5. Reinstall the lower imaging guide. Make sure the notched side is facing down and that the imaging guide is pushed in all the way and fully seated in its slot.
6. Close the bi-fold door.

Maintenance and replacement procedures

This section provides procedures for replacing the following parts. Use the list below as a guideline for frequency of replacement.

- **Feed Module Tires and Separation Roller** – tire life will vary depending upon paper types, environment and cleanliness. Nominal tire life will be approximately 250,000 documents; results will vary. Degradation of feeder performance, multiple feeds, stoppages, etc. indicate a need to change tires. Change all the tires on the feed module and separation roller at the same time.
- **Feed Module Separation Roller** – it is recommended that you install a new feed module approximately every 5th tire change. See the checklist included in the Replenishment Kit. Install a new feed module and separation roller at the same time.
- **Pre-separation Pad** – change each time you change the tires on the feed module and separation roller.
- **Exposure Lamps** – it is suggested that all four lamps be replaced every 500 hours of operation or as necessary (i.e., as reported by the scanner, repeated image calibration failures, etc.)
- **Imaging Guides** – replace when the imaging guides are heavily scratched and defects show in the image.

This section also provides replacement procedures for the:

- **Gear for Self-Centering Side Guides** – a spacer is installed in the output tray, which allows the side guides to move independently. If you want the side guides to move together (self-centering) you can install the geared spacer that is included with the scanner.
- **Side Guides** – short side guides are standard with the scanner. A set of tall side guides is included with your scanner and can be changed as required by your application.

Replacing the feed module and feed module tires

Replacing the feed module

This section provides replacement procedures for the feed module and the feed module tires.

To replace the feed module:

1. Open the swing out door.
2. Push the release lever to the right to release the feed module.

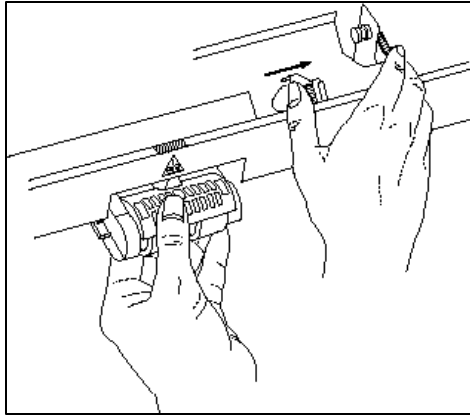

3. Remove the feed module.

To install the new feed module:

4. Push the release lever to the right and reinsert the new feed module by aligning the pins and fitting it into position. When the feed module is in position, release the lever and be sure the feed module is securely in place.

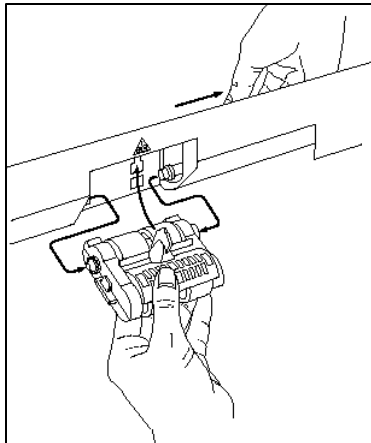

5. Close the swing out door.

Replacing the feed module tires

To replace the feed module tires:

1. Open the swing out door.
2. Remove the feed module.
3. With one hand, press the locking tabs (one on each side) while holding the bottom housing with the other hand, pull the upper housing up and away from the rollers.

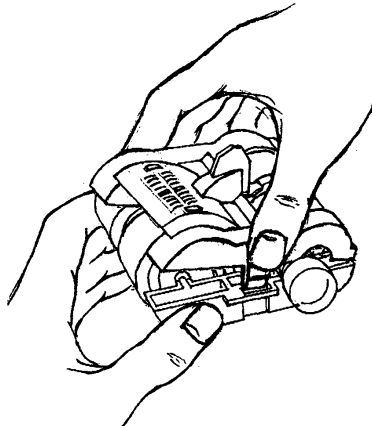

4. Remove one core assembly.
5. Replace each tire by sliding the tire off the core.

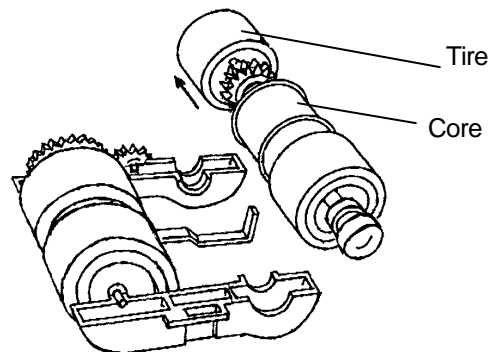

6. Install each new tire by gently stretching it over the core.

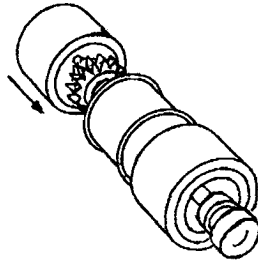

IMPORTANT: *Do not overstretch the tire; it may tear.*

7. Replace the core assembly in the feed module.

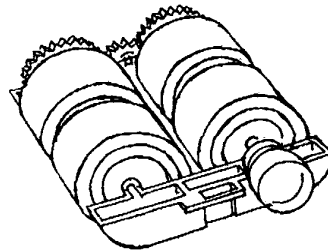

8. Repeat Steps 4 through 7 for the other core assembly.
9. Align the tabs on the upper housing with the slots on the lower housing.

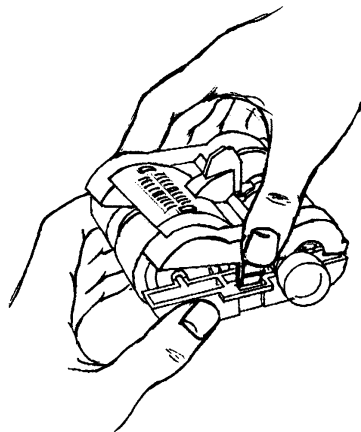

10. Press the upper and lower housings together until they snap into place.
11. Insert the feed module by aligning the pins and fitting it into position. Verify that it is securely in place.
12. Close the swing out door.

Separation roller and tires

This section provides procedures for changing the separation roller and tires.

Replacing the separation roller

To replace the separation roller:

1. Open the swing out door.
2. Lift the roller cover.
3. Pull the separation pad holder forward and remove the separation roller.

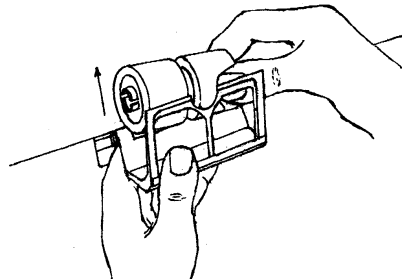

To install the new separation roller:

4. Pull the separation pad holder forward and put the new separation roller in place.

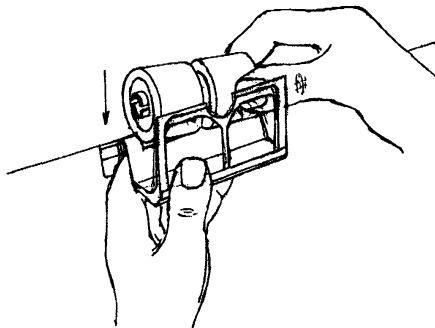

NOTE: Be sure to line up the slots on the separation roller with the holders.

5. Push the separation roller holder back in place.
6. Lower the roller cover.
7. Close the swing out door.

Replacing the separation roller tires

To replace the separation roller tires:

1. Remove the separation roller as previously directed.
2. Replace each tire by sliding the tire off the core.
3. Install each new tire by gently stretching it over the core.
IMPORTANT: Do not overstretch the tire; it may tear.
4. Reinstall the separation roller as previously directed.

Changing the separation pad

Change the pre-separation pad when the frequency of double-fed documents increases.

1. Open the swing out door.
2. Lift the roller cover.
3. Remove the pre-separation pad.

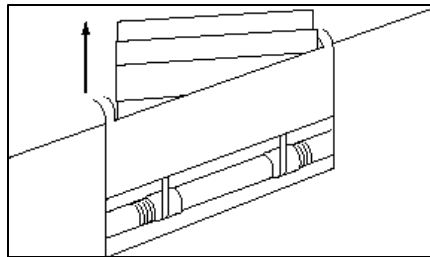

4. Install the new pre-separation pad. Be sure it snaps into place.
5. Lower the roller cover.
6. Close the swing out door.

Cleaning the feed module tires and separation roller tires

The cleaning procedures below should be performed daily. More frequent cleaning may be necessary depending on throughput and document type. Daily cleaning of the feed module tires and separation roller tires prevent ink, toner, dust and paper contaminants from collecting on the rollers, which help documents to separate properly when feeding.

1. Open the swing out door.
2. Remove the feed module.
3. Lift the roller cover.
4. Remove the feed module and separation roller.
5. Rotate the feed module tires and separation roller tires and scrub with an Emulsiclean wipe. Continue cleaning until all residue is removed from the tires.
6. Dry the tires with a dry, lint-free cloth.
7. Reinstall the separation roller.
8. Lower the roller cover.
9. Reinstall the feed module.
10. Close the swing out door.

Replacing lamps

There are four identical lamps in the scanner. Replace all lamps using the same procedure.

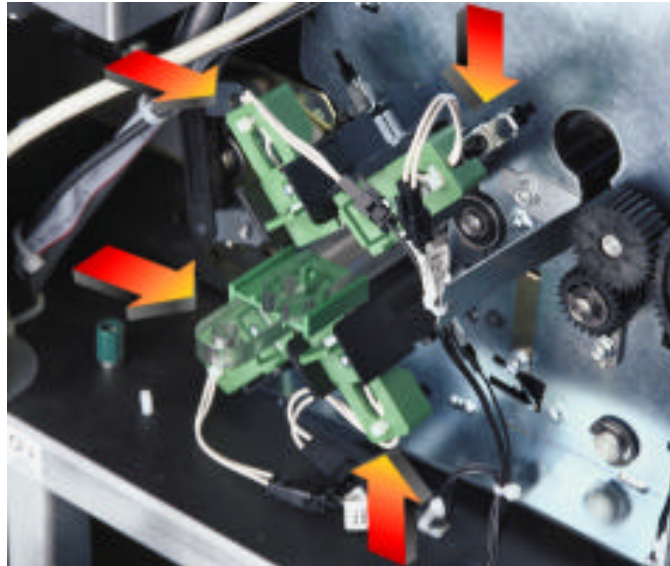

CAUTION: Lamps that have been operating are HOT. Before attempting to replace the lamps, make sure the scanner is turned off and you have allowed the lamps to cool for at least 10 minutes.

1. Open the bi-fold door.

2. Grasp the green handle of the lamp connector.

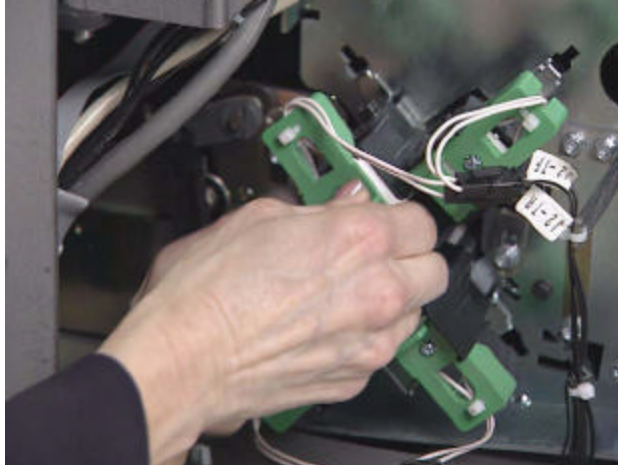

3. Slightly raise the edge of the black holder and remove the lamp connector.
4. Grasp the end of the lamp and slowly pull the lamp straight out.

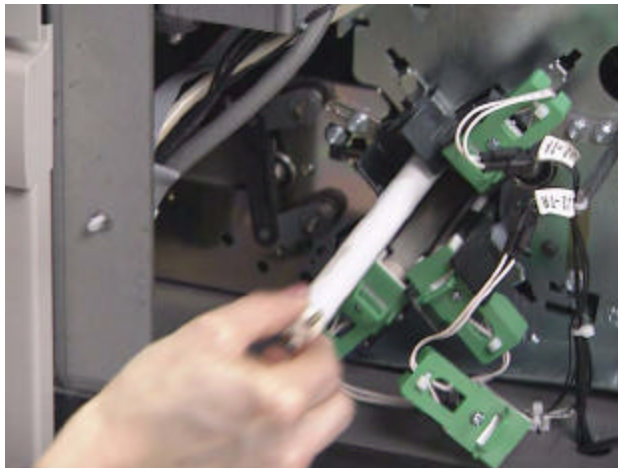

NOTE: Like most fluorescent lamps, these lamps contain a small amount of mercury and should be disposed of in accordance with local regulations.

5. Position the new lamp in the lamp holder.

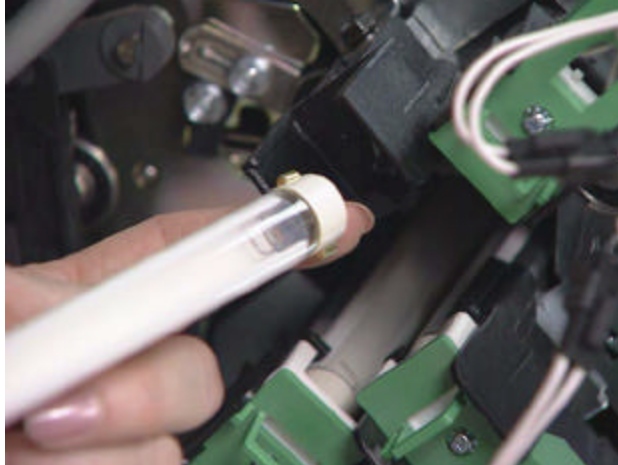

IMPORTANT: *Make sure that the clear surface of the lamp is positioned facing the imaging guides. (NOTE: The imaging guides are not installed in the illustration above.) Replace one lamp at a time to ensure the correct connector is inserted with each lamp; otherwise lamps may not function properly.*

6. Push firmly on the end of the lamp to seat the lamp into the socket on the other end.
7. Replace the green lamp connector and push it in firmly so the connector is fully seated.
8. Close the bi-fold door.
9. Allow 10 minutes for the lamps to warm up.
10. Calibrate the scanner. See Chapter 3, *Operator Control Panel Functions* for procedures.

Replacing the imaging guides

To replace the imaging guides:

1. Open the bi-fold door.
2. Remove the imaging guides.

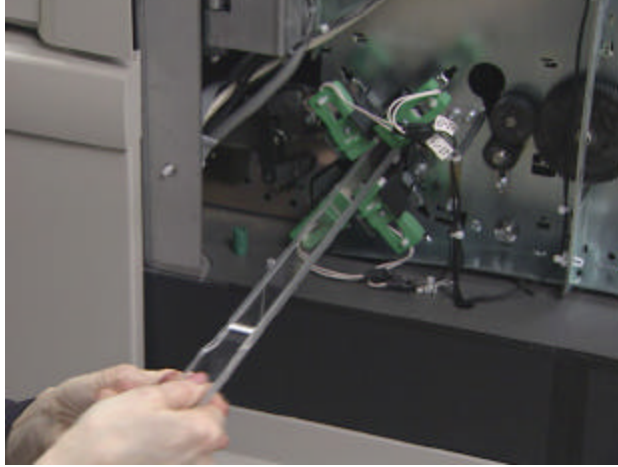

3. Slide a new upper imaging guide in place. Make sure the notched side is facing up and that the imaging guide is pushed in all the way and fully seated in its slot.
4. Slide a new lower imaging guide in place. Make sure the notched side is facing up and that the imaging guide is pushed in all the way and fully seated in its slot.
5. Close the bi-fold door.

Customizing the side guides for self-centering feeding

A spacer is installed in the output tray, which allows the side guides to move independently. If you want the side guides to move together (self-centering) you can install the geared spacer that is included with the scanner. To change the side guides for self-centering feeding, follow the procedures below.

Tools needed: Phillips Head Screwdriver

1. Pull the output tray forward and remove it.



2. Open the side guides to the widest position, remove the end stop and turn the tray upside down.



3. Use the screwdriver to release the center screw.



4. Remove the spacer and washer.



5. Take the geared spacer and place it over the post, being sure to align the teeth on the racks.



6. Add the washer and screw and gently tighten until the spacer and washer are firm.

NOTE: Do not overtighten.

7. Turn the tray right-side up, reinstall the end stop and verify the guides move freely.
8. Replace the output tray.

Changing the output tray side guides

The output tray comes with a set of short and tall side guides, which can be easily changed.

Tools needed: Phillips Head Screwdriver

1. Remove the output tray.
2. Remove the end stop.
3. Turn the tray upside down.
4. Use the screwdriver to release the screws.

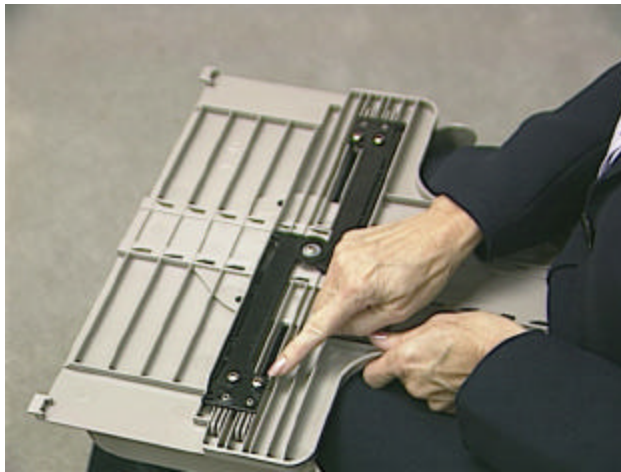

5. Turn the tray over and remove the short (or tall) side guides.



6. Take one tall (or short) side guide, position the guide and hold it in place.



7. Continue to hold the side guide in place and turn the output tray over. Put the screws in place and tighten.
8. When finished with the first side guide, turn the tray back over and attach the other side guide; follow Steps 6 and 7.
9. Replace the end stop (short or tall as required).
10. Replace the output tray.



Ordering supplies

The following supplies are available to properly maintain your system. Order them in the United States by calling DI Supply at 1-888-247-1234 or contact your local Kodak Reseller.

Outside of the United States, contact your local Kodak dealer.

Description	CAT No.
Calibration Target (Qty 50)	149 1869
Emulsiclean Wipes (Qty 24)	853 5981
Feeder Consumables Kit for i800 Series Scanners – includes 2 feed modules, 2 separation roller assemblies, 10 pre-separation pads, 50 replacement tires	838 9181
Imaging Guide Set – includes one upper and one lower guide	156 4418
Ink Blotter Kit (Qty 60)	140 1728
Paper Path Cleaners (Qty 50)	169 0783
Printer Ink Cartridge Carrier for i800/3000/4000 Scanners	826 7486
Printer Ink Cartridges for Scanner Series 3000/4000/7000/9000/i800	135 5155
Staticide Wipes (Qty 144)	896 5519
White Imaging Lamp for Scanner Series 3000/5000/7000/i800 (1/carton)	876 6545
<i>Kodak Feeder Kit for Ultra-Lightweight Paper – includes 2 feed modules, 2 separation roller assemblies, 10 pre-separation pads, 50 replacement tires. This kit is used as a replacement when very thin documents are scanned exclusively.</i>	880 3041

6 Troubleshooting/Messages

This chapter provides the following:

- procedures for clearing the document path,
- information regarding document printing problems,
- a message listing and the actions you can take to clear the message,
- a problem solving chart and when to call Service.

Clearing the document path

In the rare instance when a document becomes lodged in the transport, the scanner stops running and a message appears on the Operator Control Panel. The scanner will become disabled.

Documents can become lodged under conditions that could include (but not limited to):

- Documents are fed with excessive skew.
- Documents are torn, badly folded or wrinkled.
- Staples and paper clips are not removed.
- Imaging guides are not installed properly.
- Baffle plates are not firmly closed.

IMPORTANT: *Use the green handles when accessing scanner components.*

Front cover access

1. Remove any visible documents from the elevator and output tray areas.



2. Attempt to clear any other lodged documents by selecting the Jog button.

If there are still lodged documents:

3. Open the swing out door.
4. Lift the horizontal transport plate and remove any documents.

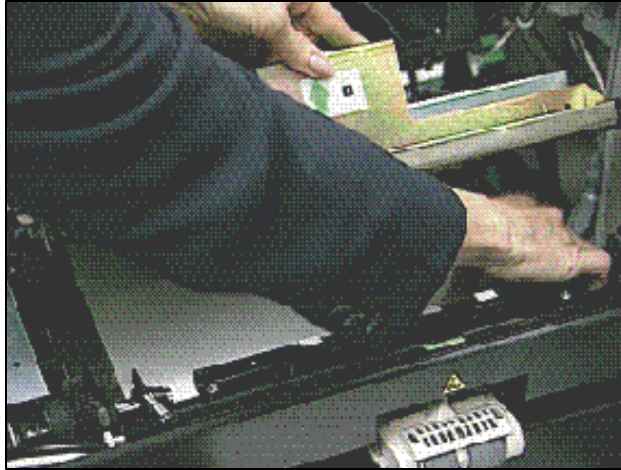

5. Close the horizontal transport plate.
6. Close the swing out door.

Top cover access

7. Open the top cover.
8. Open the exit transport plate and remove any lodged documents.



9. Close the exit transport plate.

10. Open the upper turn roller and remove any lodged documents.

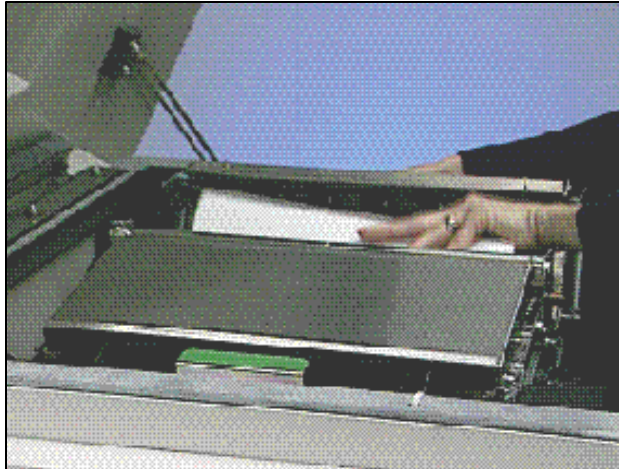

11. Close the upper turn roller.

12. Close the top cover.

Clearing the document path – bi-fold door access

Occasionally documents can become lodged in the imaging guide area. If this is the case:

13. Open the bi-fold door.

14. Remove the imaging guides.

15. Lower the vertical transport plate and remove any lodged documents.



16. Slide out the horizontal baffle plate and remove any lodged documents.

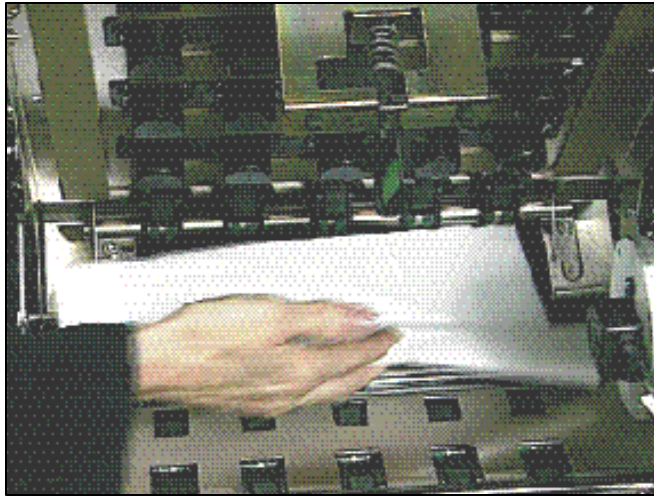

17. Slide the horizontal baffle plate back into position and close the vertical transport plate.

NOTE: Be sure the vertical transport plate is securely locked into position.

18. Reinstall the imaging guides.
19. Close the bi-fold door.
20. Re-enable the scanner from the host.

Message Listing

Following is a list of messages and corrective actions you can take if one of the following messages appears on the Operator Control Panel. Most corrective actions can be found in this User's Guide; appropriate chapters are referenced.

If one of the following messages appears, take the following action:

- Determine whether or not the error can be addressed from the host system.
- If the error cannot be addressed by the host system, attempt to clear the error by taking the action listed below.
- If the prescribed action(s) does not clear the error, initiate a controlled power-down sequence:

Controlled Power-down Sequence

1. Wait for all information currently held in the buffer to be transferred to the host system.
2. Turn off the scanner.
3. Wait 30 seconds.
4. Turn the scanner back on.

If the error condition is not cleared after using the controlled power-down sequence, call Service.

Message	Description
Message Action	Calibrate scanner now You must calibrate the scanner now. See Chapter 3, <i>Operator Control Panel Functions</i> for calibration procedures.
Message Action	Calibrate scanner soon Calibrate the scanner when the current batch has completed. See Chapter 3, <i>Operator Control Panel Functions</i> for calibration procedures.
Message Action	Calibration failed Perform a controlled power-down sequence and recalibrate the scanner. Be sure you are using the correct calibration target. Clean the imaging guides. See Chapter 3, <i>Operator Control Panel Functions</i> for the correct calibration target. If the message persists, call Service.
Message Action	Calibration succeeded Informational message. The scanner has been successfully calibrated.

Message	Description
Message Action	<p>Check document preparation The documents are not prepared properly for scanning. See Chapter 2, <i>Using the Scanner</i>, for procedures on how to properly prepare your documents.</p> <p>The documents are too close together as they enter the scanner. Change the separation rollers and pre-separation pad. See Chapter 5, <i>Maintenance</i> for the procedure for changing the separation roller and pre-separation pad.</p> <p>The cropping parameters are set improperly. If cropping is set to “Relative to document”, the cropped area must fit inside of the document dimensions. See the “Image Processing Guide”, Chapter 3, <i>Using the Twain Data Source</i> or Chapter 4, <i>Using the ISIS Driver</i> for instructions.</p> <p>One or more documents that passed through the transport were not scanned. Refeed all documents for which images were not obtained.</p>
Message Action	<p>Clean imaging guides The imaging guides or white patches are dirty.</p> <p>The imaging guides are not fully seated. Push the imaging guides all the way in until fully seated. See Chapter 5, <i>Maintenance</i>, for cleaning procedures.</p>
Message Action	<p>Clean the S1 sensor The S1 (pre-imaging) sensor is dirty. See Chapter 5, <i>Maintenance</i>, “Cleaning the Transport area” for cleaning procedures. See the diagram at the end of this chapter for the approximate location of this sensor.</p>
Message Action	<p>Clean the S2 sensor The S2 (post-imaging) sensor is dirty. See Chapter 5, <i>Maintenance</i>, “Cleaning the Transport area” for cleaning procedures. See the diagram at the end of this document for the approximate location of this sensor.</p>
Message Action	<p>Control panel button depressed An Operator Control Panel button is stuck in the engaged position. Depress and release all of the buttons and perform a controlled power-down sequence. If the message persists, call Service.</p>
Message Action	<p>Document jam A document is lodged somewhere in the scanner. Clear the paper path. See “Clearing the document path”, earlier in this chapter for procedures.</p> <p>One or more documents that passed through the transport were not scanned. Refeed all documents for which images were not obtained.</p>
Message Action	<p>Elevator self test failed The self-test of the elevator test failed. The feed module may not be installed or may not be installed properly. See Chapter 5, <i>Maintenance</i> “Replacing the feed module” for correct procedures. Perform a controlled power-down sequence on the scanner. If the problem persists, call Service.</p>
Message Action	<p>Error; Reset Scanner An error occurred that the scanner cannot resolve without recycling the scanner. Try turning the scanner on and off and on again. If error persists, call Service.</p>

Message	Description
Message Action	Feeder self test failed The self-test of the paper feeder failed. Perform a controlled power-down sequence on the scanner. If the problem persists, call Service.
Message Action	Front image cal unsuccessful The imaging calibration for the front camera was unsuccessful. Clean the imaging guides and retry calibration. See Chapter 5, <i>Maintenance</i> , "Cleaning the imaging guides" for cleaning procedures.
Message Action	Image address field overflow One of the image address fields has exceeded its maximum configured count. Check to make sure that a level change was not missed or reconfigure the scanner to allow a larger value for the overflowed field.
Message Action	Image buffer almost full The feeder has stopped and the transport is still running because the image buffer is almost full. Processing will resume when the buffer is less full.
Message Action	Image buffer full The image buffer overflowed. One or more documents that passed through the transport were not scanned. Refeed all documents for which images were not obtained.
Message Action	Images in buffer You tried to enable the scanner when images were still in the buffer. Not all images were retrieved. Retrieve the remaining images or clear the buffer. When the buffer is cleared, you may enable the scanner.
Message Action	Interlocks are closed Informational message. All doors are closed.
Message Action	Interlocks are open One of the doors is not closed or an error has not been cleared since the door(s) was last opened. Check to see that all doors are closed and clear the error by pressing the Return arrow (left button) on the Control Panel.
Message Action	Invalid IA level The image address level you tried to enter is not valid. Re-enter a correct image address level. For more information about image addressing, see Kodak publication, <i>Kodak i800 Series Scanners, Image Processing Guide, A-61510</i> .
Message Action	IPB needs firmware There is no firmware in an image processing board. Firmware needs to be installed in all image processing boards before scanning is possible. Call Service.
Message Action	Lamps not ready Calibration and/or scanning was attempted before the lamps were warmed up. See Chapter 3, <i>Operator Control Panel Function's</i> for calibration guidelines and procedures.
Message Action	Lamps ready for scanning Although lamps have warmed up sufficiently to allow scanning, image quality will be best after the lamps have stabilized after approximately 10 minutes.

Message	Description
Message Action	Mechanical cal unsuccessful The mechanical calibration was unsuccessful. Be sure the correct calibration target was used and that the arrows on the target were feed into the transport first. See Chapter 3, <i>Operator Control Panel Functions</i> , "Calibration" for more information.
Message Action	Motor self test failed The self-test of the paper transport motor failed. Perform a controlled power-down sequence on the scanner. If the problem persists, call Service.
Message Action	Multi-feed count: Informational message. Displays the multi-feed count from the "Count only" mode.
Message Action	Multi-feed detected A multi-feed has been detected due to a length checking condition or an ultrasonic multi-feed condition. Depending on how your scanner is programmed, you may need to restart the scanner from your host computer. Always check your host monitor to verify images as overlapped documents may need to be rescanned. This condition may be caused by poor document separation; replace the separation roller tires and pre-separation pad. See Chapter 5, <i>Maintenance</i> for instructions.
Message Action	Multi-feed failed self test A multi-feed detection subsystem has failed self-test. You can still scan documents, but multi-feed detection will not work. Perform the self-test again or a controlled power down sequence. If the problem persists, call Service.
Message Action	Multi-feed cal unsuccessful The multi-feed calibration failed. Be sure the sensors are clean and that the correct calibration target is used. Retry calibration. See Chapter 5, <i>Maintenance</i> , "Cleaning the Transport area" for cleaning procedures. See the diagram at the end of this document for the approximate location of sensors. Also see Chapter 3, <i>Operator Control Panel Functions</i> , "Calibration" for more information.
Message Action	No paper in tray An attempt was made to start the scanner with no paper in the elevator tray. Place paper in the elevator tray and restart.
Message Action	Page count: Informational message. Displays the page count from the "Count only" mode.
Message Action	Patch count: Informational message. Displays the number of documents containing a patch from the "Patch Test" mode.
Message Action	Patch hardware not present The Patch Reader head is not properly connected to the scanner. Be sure the patch head is properly seated in position and try again. If the problem persists, call Service.
Message Action	Power-on self-test succeeded Informational message. The scanner self-test has been performed successfully.

Message	Description
Message Action	Print head not present An attempt was made to use the Document Printer and no print head is installed. Be sure the cables are properly connected to the print head and printer board. Be sure the print cartridge is installed in the print head assembly. See Chapter 4, <i>Document Printer and Patch Reader</i> for procedures.
Message Action	Rear image cal unsuccessful The imaging calibration for the rear camera was unsuccessful. Clean the imaging guides and retry calibration. See Chapter 5, <i>Maintenance</i> , "Cleaning the imaging guides" for cleaning procedures.
Message Action	Refeed document set The documents are too close together as they enter the scanner. Replace the separation roller tires and pre-separation pad. See Chapter 5, <i>Maintenance</i> for instructions. One or more documents that passed through the transport were not scanned. Refeed all documents for which images were not obtained. A hole or tear in the document triggered a false count on the exit sensor. Align documents so that holes and tears do not pass beneath the left feed tire.
Message Action	Replace lamps soon You will need to replace all four lamps soon. See Chapter 5, <i>Maintenance</i> regarding lamp replacement procedures.
Message Action	S1 sensor is blocked A document may be blocking the S1 sensor. Clear the paper path by following the procedures outlined earlier in this chapter. See the diagram at the end of this document for the approximate location of this sensor.
Message Action	S2 sensor is blocked A document may be blocking the S2 sensor. Clear the paper path by following the procedures outlined earlier in this chapter. See the diagram at the end of this document for the approximate location of this sensor.
Message Action	Self-test failed One of the scanner subsystems failed self-test. The subsystem's functionality will not be available. Turn the power off and on again and perform another self-test. If the problem persists, call Service.
Message Action	Self-test passed Informational message. The self-test performed was successful.
Message Action	Sequential count overflow The sequential count overflowed. Reconfigure the scanner to allow a larger value for sequential count.
Message Action	Settings conflict Conflicting or unacceptable settings have been downloaded to the scanner. For example, if you attempt to set a 200 dpi bi-tonal front with a 300 dpi bi-tonal rear or if you try to enable color scanning on a <i>Kodak i810</i> or <i>i830</i> Scanner.

Message	Description
Message Action	Unable to enable Check to be sure all doors are closed. If all the doors are closed, perform a controlled power-down sequence. If the error persists, call Service.
Message Action	Unable to execute command You have tried to perform a function that is not permitted in the current state of the scanner or with invalid parameters. For example, you attempted to run the scanner when it is not enabled; or if you attempted to run the scanner when you have a paper jam.

Document sensor location

The illustration below shows the location of the document sensors.

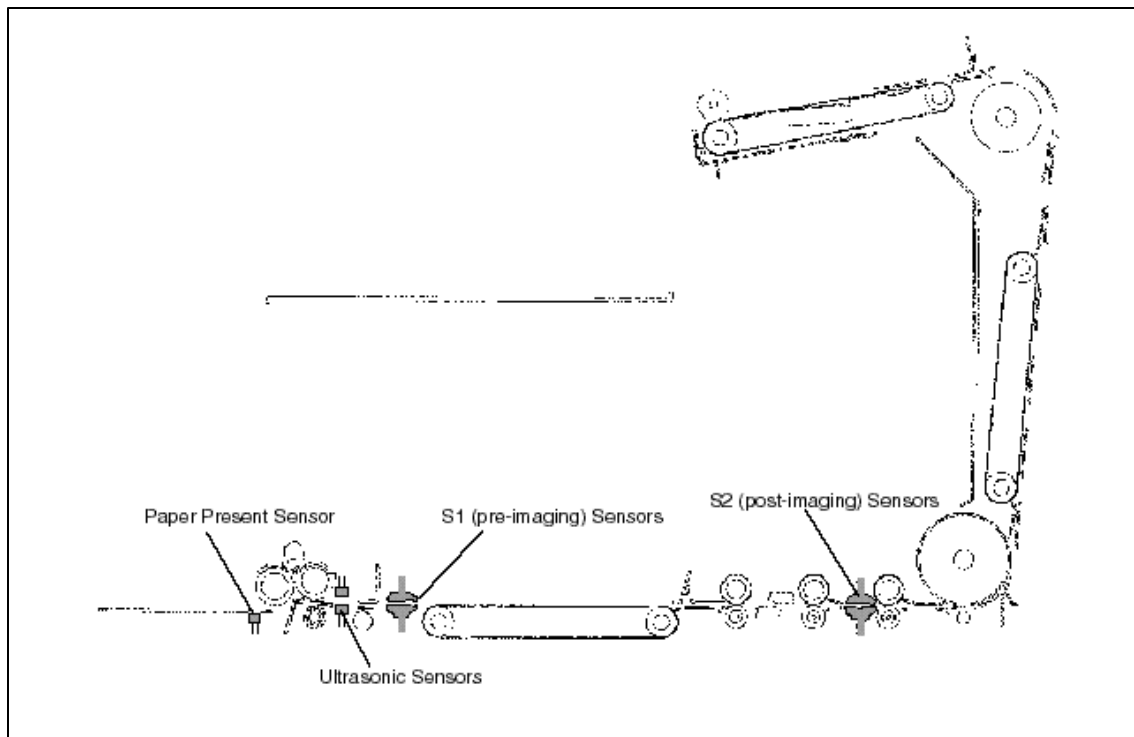



Problem solving chart

Use the chart below as a guide to check possible solutions to problems you may encounter when using the *Kodak i800 Series Scanners*.

Problem	Possible Solutions
Scanner does not power on (Control Panel is not illuminated)	<p>Make sure that:</p> <ul style="list-style-type: none">• the power cord is plugged securely into the receptacle in the back of the scanner.• the wall outlet is not defective (call a licensed electrician).• the power switch is on.
The scanner will not scan/feed documents	<p>Make sure that:</p> <ul style="list-style-type: none">• the power cord is plugged in and the power is on.• all doors are completely closed.• the scanner is enabled from the host.• documents are making contact with the feed module.• for thicker documents, press the gap release lever during feeding.• the documents meet specifications for size, weight, height of batched documents, etc.• you check the feed module and separation roller for signs of wear and replace these parts if necessary.
Image quality is poor or has decreased	<p>Make sure that:</p> <ul style="list-style-type: none">• the scanner has been calibrated (see Chapter 3, <i>Operator Control Panel Functions</i>, "Calibrating the Scanner").• the imaging guides are clean (see Chapter 5, <i>Maintenance</i>, "Cleaning the imaging guides").• the lamp timeout is set for greater than 10 minutes. <p>If unsatisfactory image quality persists, or if the scanner fails calibration, replace the lamps (see Chapter 5, <i>Maintenance</i>, "Replacing the lamps". Be sure to calibrate the scanner after installing the new lamps. Make sure that the new lamps have been on at least 10 minutes before you calibrate.</p>
The first few scanned images are very dark	<p>Make sure that:</p> <ul style="list-style-type: none">• the lamps have been on for at least 3 minutes, then scan the documents again.• the lamp timeout is set for greater than 10 minutes.

Problem	Possible Solutions
Calibration has failed	<p>Make sure that:</p> <ul style="list-style-type: none"> • the lamps have been on at least 10 minutes. • you are using the proper calibration target and it is oriented correctly. • the imaging guides are clean (see Chapter 5, <i>Maintenance</i>, ‘Cleaning the imaging guides’’). • the transport area is clear of obstructions. • the sensors are clean. • the lamp timeout is set for greater than 10 minutes. <p>Try calibration again. If calibration fails again, replace the lamps (see Chapter 5, <i>Maintenance</i>, ‘Replacing the lamps’’). Be sure to calibrate the scanner after installing the new lamps. Make sure the new lamps have been on for 10 minutes before you calibrate.</p>
Documents are jamming	<p>Make sure that:</p> <ul style="list-style-type: none"> • the output tray and side guides are adjusted for the length of documents being scanned. • all jammed documents have been removed from the transport area. • documents meet specifications for size, weight, height of batched documents, etc. • the sensors are clean. • the separation roller, feed module, and pre-separation pad are clean and properly installed. • the transport rollers are clean. • the imaging guides are properly installed.
Elevator tray is vibrating and stuck in place	<p>You may have leaned on the elevator tray or the document extenders. To recover from this:</p> <ol style="list-style-type: none"> 1. Gently push the elevator tray down as far as you can. Do not force it. 2. Disable the scanner from the host. 3. Enable the scanner from the host. <p>If the problem persists, cycle the power to the scanner following the controlled power-down sequence as outlined earlier in this chapter.</p>
Long documents are not feeding or are jamming	<p>Make sure that:</p> <ul style="list-style-type: none"> • the elevator tray extenders are pulled out to provide support for long documents. • the output tray is adjusted for the length of the documents being scanned. • the output tray is installed properly.
There are frequent multi-feed detection errors	<p>Make sure that:</p> <ul style="list-style-type: none"> • the scanner has been calibrated. • documents are larger than 2.75 inches (6.98 cm) in length. • stickers are adhered correctly to the document. • the access doors are completely closed. <p>If the problem persists, try a different sensitivity setting on the host.</p>

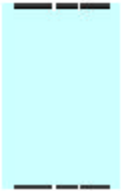
Problem	Possible Solutions
The output tray cannot be adjusted in or out	Make sure the output tray is installed properly.
Roller marks appear on documents after scanning	Clean the feed module rollers, separation rollers and transport rollers (see Chapter 5, <i>Maintenance</i>).
Vertical streaks appear on the image	<ul style="list-style-type: none"> • Be sure when you calibrate the scanner that you are using a good, clean calibration target. Use the calibration target provided with your scanner. Additional calibration targets can be ordered. See Chapter 5, <i>Maintenance</i>, "Ordering Supplies" for more information. • The imaging guides may be dirty. Clean the imaging guides. For procedures see Chapter 5, <i>Maintenance</i>, "Cleaning the imaging guides".
The document printer is not printing as desired	<p>If you are having problems printing on scanned documents:</p> <ul style="list-style-type: none"> • the tip of the ink cartridge may be plugged. Purge the ink cartridge as instructed in Chapter 4, <i>Document Printer and Patch Reader</i>. If the ink still does not flow properly, replace the ink cartridge. Dispose of used ink cartridges properly. • verify that the ink cartridge is not empty. The ink bladder inside the ink cartridge is flat when it is empty. • make sure that the ink cartridge is properly installed in the Document Printer. • make sure that the ink cartridge is located in the correct position for printing. • make sure that the ink cartridge carrier is properly seated in its slot. • verify that all printer connectors are securely fastened and that the printer cables are securely in the white clip and are not folded or creased. • verify that the printer has been enabled through the host and that the expected print string has been specified. • conduct a Print Test via the Operator Control Panel (see Chapter 3, <i>Operator Control Panel Functions</i>, "Performing a print test").
White lines appear at the top of the image and run through the documents	<ul style="list-style-type: none"> • The imaging guides may be dirty. Clean the imaging guides. For procedures see Chapter 5, <i>Maintenance</i>, "Cleaning the imaging guides". • Check for scratches on the imaging guides. If scratches are on the imaging guides, change them. For procedures see Chapter 5, <i>Maintenance</i>. <div style="text-align: center;">  </div>

Problem	Possible Solutions
<p>White lines appear at the top of the document then stop as the document is imaged.</p>	<p>Clean the black backer strip on the horizontal baffle plate. For procedures see Chapter 5, "Cleaning the vertical transport area".</p>  

EASTMAN KODAK COMPANY
Commercial Imaging
Rochester, New York 14650

Kodak is a trademark of Eastman Kodak
Company.

Printed on recycled paper.



A-61169 7/03

CAT No.

©Eastman Kodak Company, 2003

Printed in U.S.A.

Free Manuals Download Website

<http://myh66.com>

<http://usermanuals.us>

<http://www.somanuals.com>

<http://www.4manuals.cc>

<http://www.manual-lib.com>

<http://www.404manual.com>

<http://www.luxmanual.com>

<http://aubethermostatmanual.com>

Golf course search by state

<http://golfingnear.com>

Email search by domain

<http://emailbydomain.com>

Auto manuals search

<http://auto.somanuals.com>

TV manuals search

<http://tv.somanuals.com>