

---

# **KODAK PROFESSIONAL 8660/8670 PS Thermal Printer**

## **Network Interface Guide**



Part Number 6B4389



## Kodak Professional 10/100 Network Interface Card Quick Configuration Reference Guide



### NIC Identification (EK Cat # 844-5074)

- Stickers on packaging and on NIC with Cat #, Serial #, and Ethernet Hardware Address
- NIC advertises on networks as KOD\_XXXXXX . . . , where xxxxxx is last the 6 digits of the NIC Ethernet Hardware Address.

### Protocols Supported

- TCP/IP, IPX/SPX, AppleTalk, NetBEUI

### Networked Platforms Supported

- Windows and Macintosh
- Novell, NT, and Unix Servers

### NIC Interfaces

- 100 Mbit (100baseTX) or 10 Mbit (10baseT) connectivity. (The speed of network environment is automatically determined by NIC.)
- Serial port for NIC configuration or debug. (Remote configuration utilities are also available.).

**Note:** Refer to the user's guide provided with the Network Interface Card for details on configuring the NIC and user platforms to print to your networked Kodak printer. Kodak printer and NIC documentation/software are also available on the Kodak Web site ([www.kodak.com](http://www.kodak.com)).

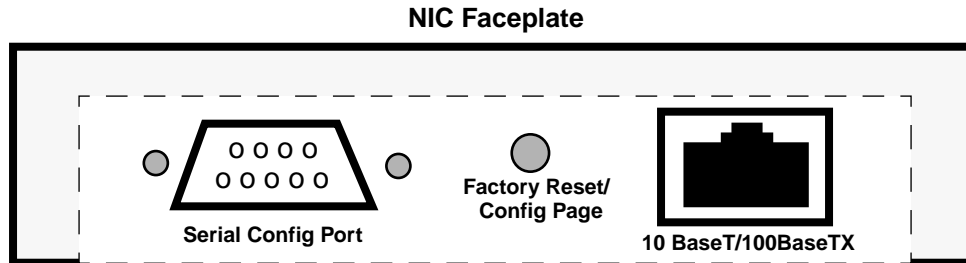

### Faceplate - Reset/Configuration Page Push-button Switch

The NIC has a single, recessed push-button switch located between the serial port and network connector. It has the following functions:

- To print a configuration test page, press the switch in for at least one-eighth second but less than five seconds
- To reset the unit back to factory default settings, press the switch and hold it in for at least 5 seconds.

**Note:** Reset and configuration pages can also be generated by using remote configuration utilities.

### Faceplate - 10baseT/100baseTX Network Cable Connector

- A 100baseTX/10baseT RJ45 connector accommodates 100 Mbit (100baseTX) or 10 Mbit (10baseT) connectivity.

### Faceplate - Serial Configuration Port

- The serial port may be used for NIC configuration and diagnostics.

**Note:** Remote configuration utilities are usually used instead of the serial port because the necessary computer resources are already on the network.

### NIC LEDs (Not on Faceplate)

There are 3 LEDs, red, yellow, and green, located on the bottom of the NIC when it is installed in the printer. The back of the printer must be pulled out to view the LEDs.

- **Red TEST LED** - When the printer is powered up, the red LED should blink momentarily and then go out. If the red LED blinks continuously, there is a problem.
- **Green LINK OK LED** - When the printer is READY, the green LED is lit continuously if valid link connectivity to a corresponding hub/switch network port is established.
- **Yellow 100baseT LED** - When the printer is READY, the yellow LED is lit continuously if the NIC detects 100 Mbit network operation. If the yellow LED is OFF, the NIC has detected 10 Mbit network operation.

### NIC Configuration Utilities

**Note:** The printer must be either reset using remote configuration tools or power cycled after changing NIC parameters.

- **Printer Front Control Panel:** Some NIC configuration parameters such as the TCP/IP address can be configured from the printer's front control panel.
- **Web Browser:** Any platform with internet access can use a Web browser tool to access and configure the NIC by entering the printer (NIC) IP address as the Web location. (It may be necessary to turn proxies off.) The NIC default access password is "access".
- **Windows:** The NIC may be configured from Windows platforms using a Web browser, XAdmin, XConfig or Telnet.
- **Macintosh:** The AppleTalk Name can be modified by using LaserWriter utilities provided with Macintosh systems. Refer to Apple's Web site for these utilities.
- **Unix:** Use a Web Browser or Telnet.
- **Serial Interface to NIC:** A serial interface is also provided on the NIC face plate for NIC configuration and troubleshooting.

### Printer/NIC Installation and Configuration Overview

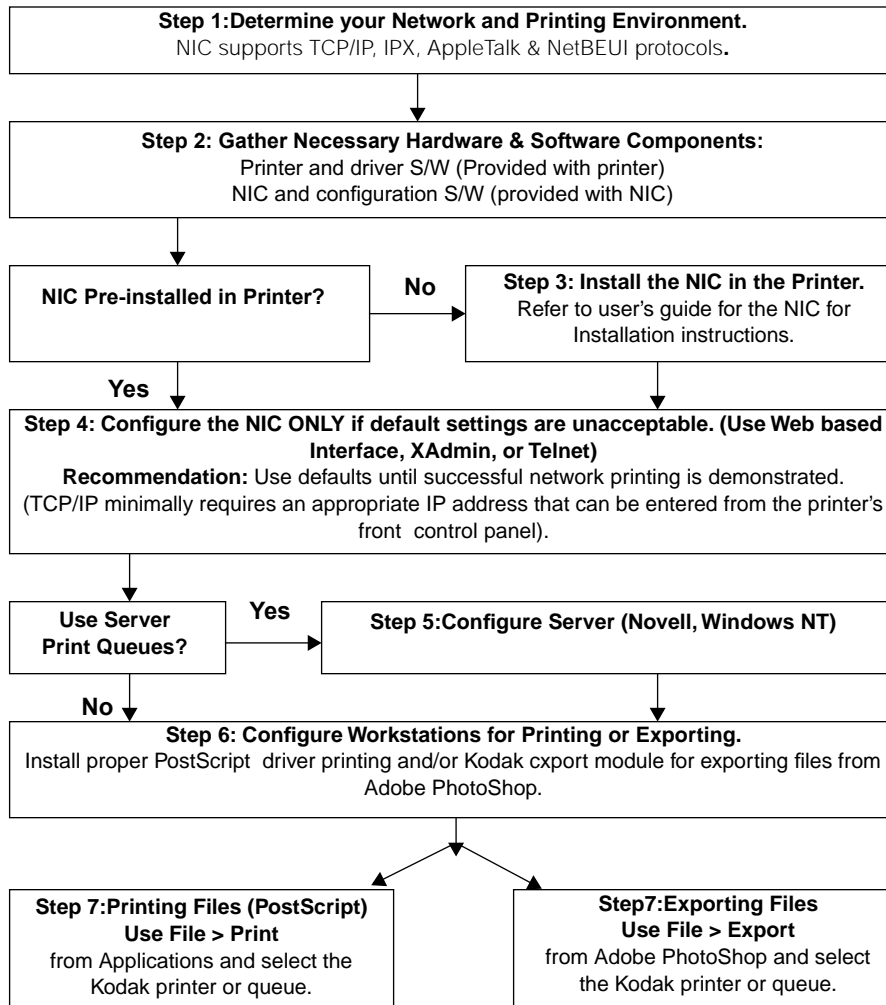

# Contents

<b>1</b>	<b>Introduction</b> .....	<b>1-1</b>
	About this Guide .....	1-1
	About the Network Interface Card .....	1-1
	Features .....	1-1
	Protocols.....	1-2
	Network Operating System Compatibility .....	1-2
	Compliance.....	1-2
	Getting Help.....	1-2
	Overview of Installing and Configuring the N IC.....	1-3
<b>2</b>	<b>Installing the Hardware</b> .....	<b>2-1</b>
	Static Electricity Precautions .....	2-1
	Package Contents .....	2-1
	Requirements .....	2-2
	Installing the NIC in an 8660 Printer.....	2-2
	Installing the NIC in an 8670 PS Printer.....	2-4
	Installing the Ethernet Cable .....	2-7
	Printing a Test Page .....	2-7
	Configuring the NIC .....	2-8
<b>3</b>	<b>Using Configuration Utilities</b> .....	<b>3-1</b>
	Using a Web Browser to Configure the NIC .....	3-2
	Service Names .....	3-3
	Examples of Configuration Screens .....	3-4
	Using the XAdmin Utility .....	3-8
	Using XConfig Utility.....	3-12
	Telnet Configuration Utility (Any Platform) .....	3-14
	Connecting the NIC Serial Configuration Port to a Console Terminal.....	3-16
	Configuring the NIC from the Printer's Display Panel.....	3-17

Additional Mechanisms for Establishing an IP Address .....	3-19
Enabling IP access using ARP .....	3-19
Using Arp on Unix Systems .....	3-19
<b>4 Configuring Servers and Workstations for Printing.....</b>	<b>4-1</b>
AdobePS Drivers and Export Modules .....	4-1
Novell Servers .....	4-1
Windows NT 4.0, Windows 2000 Servers and Workstations .....	4-1
Unix Servers and Workstations .....	4-2
Windows for Work Groups (3.x) .....	4-2
Windows 95/98 .....	4-2
Macintosh .....	4-2
<b>5 Microsoft Peer to Peer Print Services (NetBEUI).....</b>	<b>5-1</b>
Workstation Networking Software for Peer to Peer Services .....	5-1
Setting up a Kodak PostScript Printer for Windows 95/98 .....	5-2
Setting up a Kodak PostScript Printer for Windows NT.....	5-4
AdobePS Setup Utility for Windows NT.....	5-6
Verification of AdobePS Driver .....	5-9
Setting up Windows 95/98/NT to Export Kodak Raster Files .....	5-10
<b>6 Novell NetWare .....</b>	<b>6-1</b>
Before You Begin .....	6-1
NIC Operating Modes with Novell NetWare .....	6-2
Configuring for a Novell NetWare Network.....	6-2
Novell Queue and Printer/NIC Association Using JetAdmin.....	6-3
Novell Queue and Printer/NIC Association Using XAdmin or XConfig .....	6-3
Configuring for NDS Using NWAdmin .....	6-4
Configuring for NDS Using JetAdmin or XAdmin .....	6-4
Configuring for NDS Using PCONSOLE and XConfig .....	6-5
PCONSOLE.....	6-5



---

	XConfig .....	6-6
	Configuring for Queue Server Mode using PCONSOLE and XConfig .....	6-7
	PConsole .....	6-7
	XConfig.....	6-8
<b>7</b>	<b>Configuring for TCP/IP .....</b>	<b>7-1</b>
	Configuration Summary.....	7-2
	Networking Software for TCP/IP.....	7-2
	Novell Netware Servers .....	7-2
	Configuring TCP/IP (LPR) Printers on NT Systems .....	7-3
	Installing the Printing Software for Windows NT Systems.....	7-4
	Installing the Export Module for Raster Printing (8660/8670 Printers).....	7-4
	Installing the Printing Software for PostScript Printing (8670 Printer) .....	7-4
	Configuring an LPR Printer on NT Systems .....	7-7
	Configuring Unix Systems for TCP/IP Printing .....	7-12
	Adding the Kodak Printer to the Host Table .....	7-12
	Assigning a Print Queue .....	7-12
	Setting Up the Remote Printer.....	7-12
	Creating a Spool Directory.....	7-16
<b>8</b>	<b>Configuring for AppleTalk Networks .....</b>	<b>8-1</b>
	Printer and NIC Installation.....	8-1
	Finding the Printer's Name in the Chooser.....	8-2
	Changing the Printer's Name .....	8-2
	Changing the Printer's Zone.....	8-2
	Windows NT Systems vs AppleTalk.....	8-3
<b>9</b>	<b>Troubleshooting .....</b>	<b>9-1</b>
	NIC Start-up Sequence .....	9-1
	Intermittent Problems .....	9-3
	TCP/IP Troubleshooting .....	9-3

NetWare Troubleshooting .....	9-5
AppleTalk Troubleshooting .....	9-6
Windows NT Troubleshooting.....	9-6
Windows Peer-to-Peer Troubleshooting.....	9-7
Technical Assistance .....	9-7
Kodak Customer Assistance Center .....	9-7
<b>Appendix A NIC Services.....</b>	<b>A-1</b>
Overview .....	A-1
Environment/Protocol .....	A-2
BOT/EOT Strings.....	A-2
Filters .....	A-3
<b>Appendix B Command Summary.....</b>	<b>B-1</b>
General Server Commands .....	B-1
TCP/IP Commands.....	B-4
NetWare Commands .....	B-5
AppleTalk Commands .....	B-6
<b>Index .....</b>	<b>I-1</b>

# 1 Introduction

## About this Guide

This guide provides instructions for network administrators on installing the Kodak Professional 10/100 network interface card in the Kodak Professional 8660 and 8670 PS thermal printers and configuring the printers for use over a network. This guide also provides instructions on configuring workstations to send jobs to the printers.

## About the Network Interface Card

The Kodak Professional 10/100 network interface card (NIC) is an integral PCI bus compatible print server that allows a printer to be shared on an Ethernet 10 MB or Fast Ethernet 100MB network. Because the NIC has multiprotocol capabilities, users with computers running different network operating systems can simultaneously access the same printer.

Before you install the NIC in the printer, unpack and set up your printer and install the printing software on each workstation that will send jobs to the printer.

## Features

The NIC has the following features:

- connects to either a 10BaseT or 100Base TX Fast Ethernet network and autodetects the network type.
- contains flash memory for updating the firmware.
- contains a serial port to connect a console terminal or a serial printer.
- connects to the printer through a 33MHz 32-bit PCI bus.
- is configurable remotely using a Web browser.
- is compatible with Hewlett-Packard's JetAdmin NetWare, Windows 95 Peer-to-Peer printer management software, and XAdmin Windows-based NetWare management utility.
- has remote console capability management using Telnet or NetWare.
- contains IP security to restrict printing based on IP address

## Protocols

The NIC supports the following protocols:

- TCP/IP
- IPX/SPX
- AppleTalk
- NetBEUI

## Network Operating System Compatibility

The NIC is compatible with the following operating systems:

- Systems that support either the Berkeley lpr/lpd printing protocol, the HP JetDirect card, or printing to a raw TCP port
- Novell NetWare V2.15 or above, V3.xx, or V4.xx, including support for NetWare Directory Services (NDS)
- AppleTalk Phase 2
- Windows NT and NT Server V4.0
- Windows 95/98 (Peer-to-Peer or client mode)
- NetBIOS/SMB

## Compliance

The NIC complies with Part 15 of the FCC Rules. The operation of the NIC may not cause harmful interference, and it must accept any interference received including any that may cause undesired operation.

## Getting Help

Help is available on the Kodak Web site at [www.kodak.com](http://www.kodak.com). The site contains questions and answers, user documentation, and printing software. Refer to "Troubleshooting" before contacting your retailer or Kodak for technical assistance.

## Overview of Installing and Configuring the NIC

To install and configure the NIC:

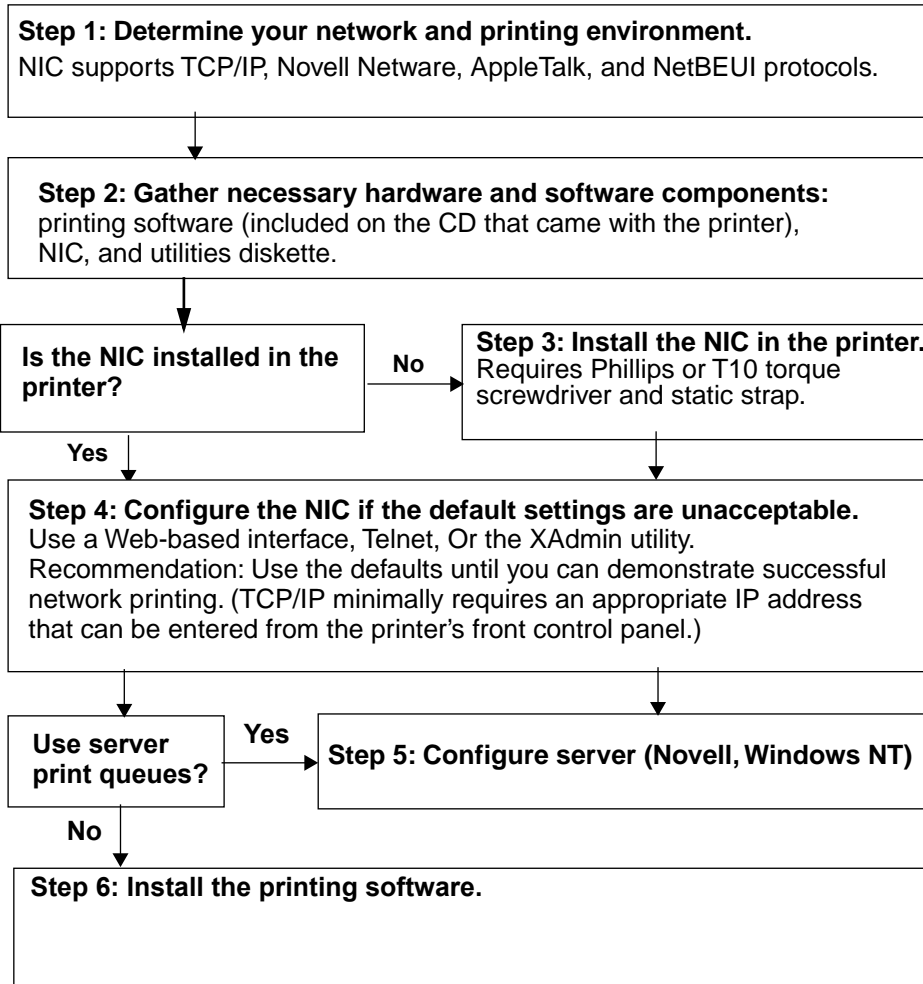

### **Step 1: Assess your network and printing environments.**

Consult with your system/network administrator regarding:

- **Servers**—Determine the servers or queues to spool and manage jobs sent to the printer.
- **Printing Platforms**—Determine the workstation platforms that will be used for creating and sending jobs to the printer.
- **Protocols**—Determine the network protocols for TCP/IP, Novell IPX, AppleTalk, or NetBEUI that will be used for communicating to the printer. All protocols are enabled by default.

### **Step 2: Gather the necessary components.**

- **Hardware**— printer, NIC, and network cabling certified for 10 or 100 MB operation depending upon the speed of your network.
- **Networking components**—cables, converters, hubs, and switches are not included with the NIC. You must purchase interconnecting networking components to support a specific environment separately.
- **NIC Configuration software**— XAdmin software is provided for configuring the NIC from Windows workstations. Web based configuration and Telnet do not require additional software installation.

NOTE: Make sure that the printing software is installed on the workstations that will be sending jobs to the printer. If the CD included with the printer does not include the appropriate printing software for your workstation's operating system, it may be available through alternate vendors who support the 8660 and 8670 PS thermal printers. You can use a generic PostScript or LaserWriter driver. However, they may not support all of the printer's features.

### **Step 3: Install the NIC.**

- Install the NIC in the printer if it was not preinstalled. Refer to "Installing the Network Interface Card" for instructions.

#### **Step 4: Configure the NIC from the desired platform**

- With the exception of TCP/IP, it is not necessary to reconfigure the NIC unless its default parameters are unacceptable. We recommend that you verify that the printer functions on your network before you modify existing NIC parameters.
- The use of TCP/IP requires only that you enter an appropriate IP address at the printer's display panel or by using one of the NIC's configuration utilities.
- In Macintosh environments, you may wish to change the printer's default name (the NIC's unique Ethernet hardware address) to a name that is more recognizable on your network.

#### **NIC Configuration Utilities:**

See Appendix A for information on using the following utilities to configure the NIC.

- configuring NIC parameters such as the TCP/IP Address from the printer's display panel.
- configuring the NIC from Windows platforms using a Web browser, XAdmin, or Telnet.
- configuring the NIC from Macintosh platforms using a Web browser or Telnet. You may be able to use the LaserWriter utilities provided on Macintosh systems to modify the printer's name over AppleTalk name and its zone.
- configuring the NIC from Unix workstations using a Web browser or Telnet.
- using the serial interface on the NIC faceplate for configuration and troubleshooting.

#### **Step 5: Configure the print servers**

Determine if server print queues will be used, and configure the appropriate Novell or NT servers.

#### **Step 6: Configure the printer on the workstations.**

Follow the appropriate steps to add a printer to each workstation that will send jobs to the printer. Refer to the platform specific chapters to configure the workstations.

**Step 7: Printing**

From your application select either Print or Export to verify that the workstations can send a job to the printer.



## **2 *Installing the Hardware***

This chapter describes how to:

- install the Kodak Professional 10/100 network interface card (NIC) in the printer.
- install the Ethernet cable.
- make a test print.

### **Static Electricity Precautions**

To help prevent static electricity from damaging the NIC during installation:

- Touch the metal frame of the printer to discharge the static electricity from your body.
- Grasp the NIC only by its edges.
- Avoid movement during installation that can generate static electricity.
- Avoid working in a carpeted area.

### **Package Contents**

The following items are included in the package for the NIC:

- Network Interface Card
- 3.5 inch diskette containing PCONSOLE and XConfig utilities
- Antistatic strap
- Network Interface Guide

## Requirements

You need the following to install the NIC:

- Network cabling certified for 10 and 100 MB operation. The NIC supports 10BaseT and 100BaseT cabling. Use category 5 unshielded twisted pair cabling for 100 MB operation.
- Phillips-head screwdriver
- If a BNC (10Base2) connection is required, purchase a BNC/RJ45 transceiver or hub from your local dealer or distributor.
- If a connection from a single computer to a printer is required, use a mini-hub and two network cables.

**NOTE:** You can use an Rx/Tx crossover cable as a direct connection to a single computer without a hub. However, an Rx/Tx crossover cable is a nonstandard cable that may not be available from a local dealer. If you use an Rx/Tx crossover cable, make sure that it is clearly labeled so it is not confused with standard network cables for use with network hubs or switches.

## Installing the NIC in an 8660 Printer

1. Turn off, and unplug the 8660 printer.

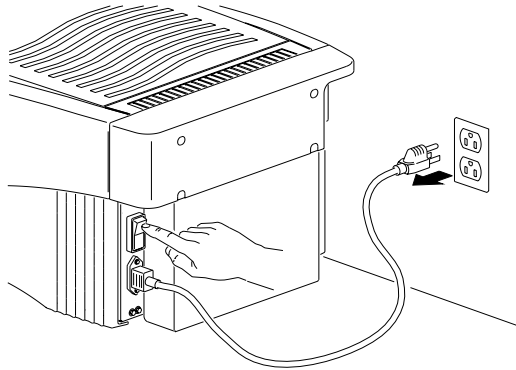

2. Remove the four screws on the back of the 8660 printer.

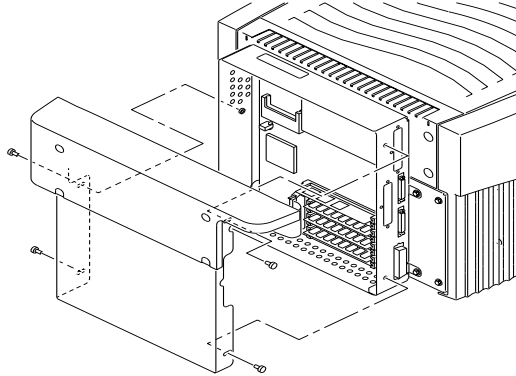

3. Remove the back panel.
4. Attach the wrist portion of a static strip to your wrist. Attach the other end of the strap to the metal frame of the 8660 printer.

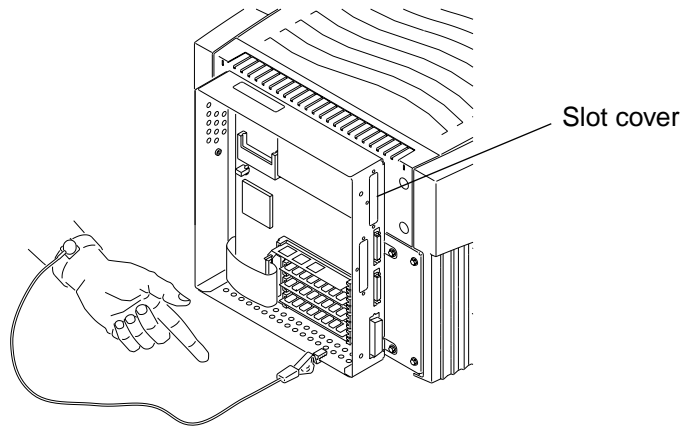

**CAUTION:** Wear the antistatic strap during this installation procedure so that you do not generate static electricity that can damage the 8660 printer.

5. Remove the screws which hold the slot cover for the Network Interface Card in place.
6. Remove the Network Interface Card from the antistatic bag.

7. Hold the card so that the network cable receptacle is toward the slot cover. Tilt the card slightly and slide the face plate connector against the slot.
8. Position the printer interface connectors against the receptacles on the motherboard to seat the NIC. Press the NIC gently into place.
9. Install the screws that held the faceplate in place to secure the NIC.
10. Install the back cover and the 4 screws.
11. Go to the section in this chapter on "Installing the Ethernet Cable."

### **Installing the NIC in an 8670 PS Printer**

1. Turn off, and unplug the printer.

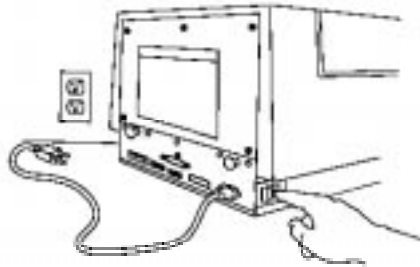

2. Attach the wrist portion of the antistatic strap to your wrist. Attach the other end of the strap to the metal plate on the back of the printer.

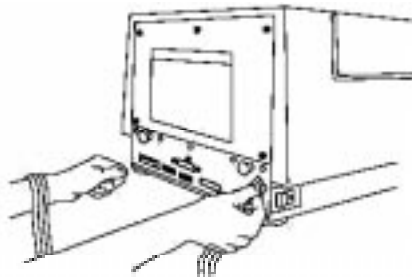

**CAUTION:** Wear the antistatic strap during this installation procedure so that you do not generate static electricity that can damage the printer.

3. Remove the five screws on the back of the printer.

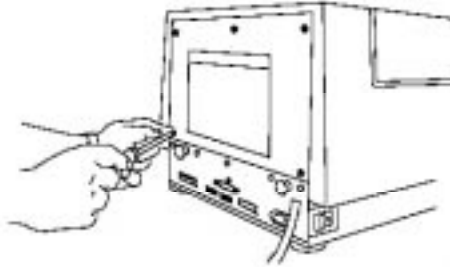

4. Grasp the two black handles on the metal plate. Slowly pull the drawer out about six inches.

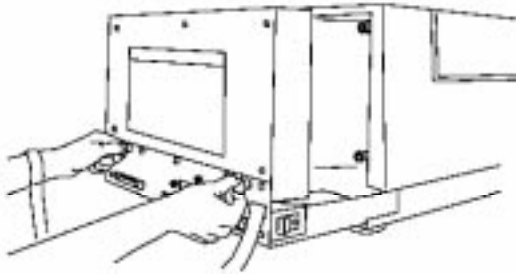

5. Remove the screws that hold the slot cover for the NIC in place (slot nearest to power receptacle).
6. Remove the slot cover, and set it aside.

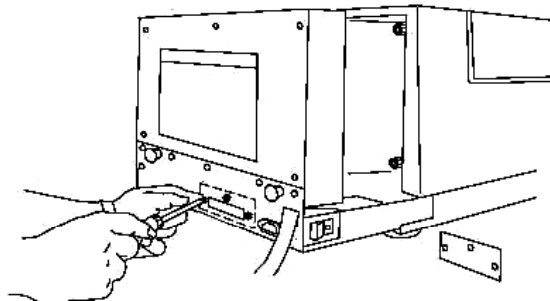

7. Remove the NIC from the antistatic bag.

8. Hold the card so that the printer connectors are on the bottom and the network cable receptacle is toward you.

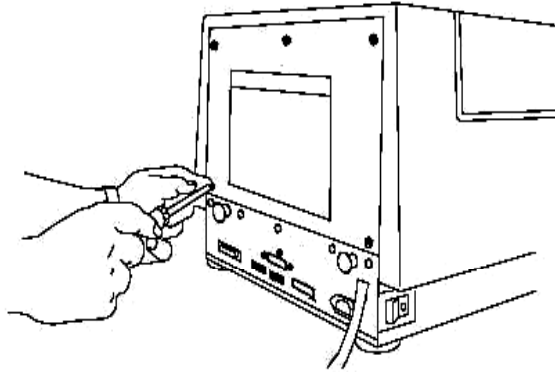

9. Hold the card so that the network cable receptacle is toward the slot cover. Tilt the card slightly, and slide the face plate connector against the NIC slot.
10. Position the printer interface connectors against the receptacles to seat the NIC. Press the NIC gently into place.
11. Secure the NIC faceplate to the printer by replacing the screws you removed.

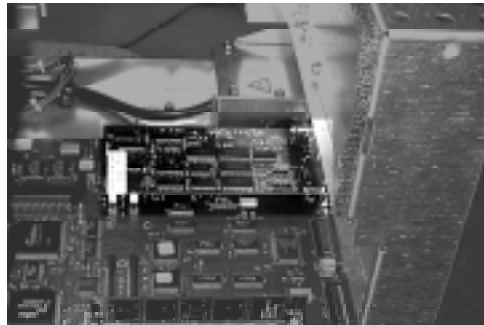

12. Grasp the handles on the back of the printer, and slide the back of the printer in.
13. Replace the back panel screws you removed.

## Installing the Ethernet Cable

To connect the NIC to a 10baseT or 100baseTX Fast Ethernet network, you need a 10 or 100 MB capable Ethernet hub/switch with at least one unused port installed on your network and an appropriate length of RJ45 modular cable. Category 5 cabling is necessary for 100 MB operation.

1. Connect one end of the RJ45 network cable to the Ethernet port on the NIC.

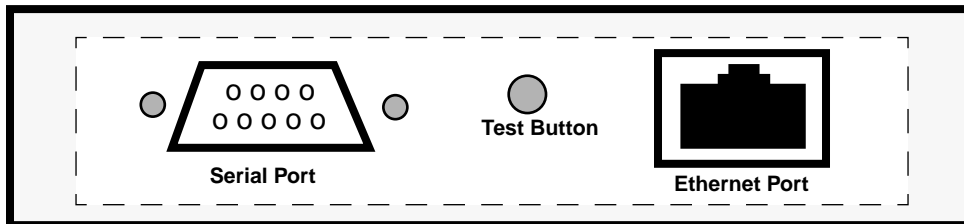

2. Connect the other end of the RJ45 network cable to the Ethernet port on your hub or switch.

The NIC automatically senses if it is connected to a 10BaseT or a 100BaseTX network.

## Printing a Test Page

You need to print a test page to verify that the NIC is installed correctly. Use the test button on the NIC face plate to make a test print. The test button is located between the Ethernet port and the serial port.

**NOTE:** The test button is also used to reset the NIC to factory defaults. Press the switch, and hold it in for at least 5 seconds to reset the NIC to factory defaults.

To print a test page:

1. Make sure that the printer is connected to a functioning network. If the NIC does not detect protocols such as AppleTalk, it automatically disables that protocol.
2. Turn on the power to the printer.
3. Locate the test button on the NIC faceplate.

4. If this is the first time you are setting up or verifying NIC operation, push in on the NIC test button for at least five seconds to set all of the NIC configuration parameters to factory defaults.
5. Push in on the test button again for approximately a second (less than 5 seconds) to print a test page.

Retain the test print. It contains information you will need to configure the NIC.

If the test page does not print:

- make sure that the NIC is installed securely in the printer.
- check the LEDs on the bottom of the NIC. When you turn on the power to the printer, the NIC runs a set of power-up diagnostics. If the NIC operates correctly, the red test LED blinks momentarily and then goes out. The test LED blinking continuously indicates a problem with either the installation of the NIC or the Ethernet cable.

Refer to the chapter “TroubleShooting” for more information on diagnosing the problem.

## **Configuring the NIC**

If the NIC test page printed, configure the NIC for network printing only if you wish to change the default settings. Refer to “Using Configuration Utilities” for information on the various utilities that you can use to configure the NIC.



### 3 Using Configuration Utilities

You can use various utilities to configure the Kodak Professional 10/100 network interface card (NIC):

**Web Browser Configuration Tool** —Graphical interface; configure from any platform that supports Web access; requires an IP address. No additional configuration software necessary.

**XAdmin Configuration Utility**— Graphical interface; use for Windows only; software provided with the NIC. Does not provide AppleTalk configuration.

**Apple LaserWriter Utilities**—Graphical interface; Macintosh only; software provided with the Macintosh operating system or is available on Apple's Web site; functionality limited to AppleTalk parameters and downloading a PostScript file.

**XConfig Utility** —Command line interface; Windows only; software provided with the NIC. Does not provide AppleTalk configuration. Refer to Appendix B for more information on the NIC configuration commands.

**Telnet**—Command line interface; configure from any platform that supports the use of Telnet (TCP/IP); requires an IP address. Refer to Appendix B for more information on the NIC configuration commands

**NIC Serial Port**—Command line interface; configure from any serial terminal. Refer to Appendix B for more information on the NIC configuration commands

**Printer Front Control Panel**—Describes NIC configuration parameters such as IP address that can be established from the printer's control panel.

**Additional Mechanisms for Establishing an IP Address**— Describes use of ARP, RARP and BOOTP.

**NIC Services**—Services and names are summarized in Appendix B.

**NIC Commands**—Commands for command line configuration utilities are summarized in the Appendix B.

NOTE: The Web browser and Telnet tools provide capability for configuring all protocols. Other utilities such as XAdmin and XConfig limit configuration capabilities for Windows environments.

Kodak support is limited to networked printers using the NIC in NetBIOS/NetBeui, NetWare (IPX/SPX), TCP/IP and AppleTalk environments. However, the various print server utilities provided are generic and reference additional protocols and services such as Banyan, DEC LAT, DLC/LCC and POP3/SMTP. These additional environments have not been tested and are not supported by Kodak for use with the NIC.

### Using a Web Browser to Configure the NIC

To configure the NIC from your Web browser:

1. From any internet browser on any platform, enter the NIC's IP address as the internet location.

NOTE: It may be necessary to disable proxies for your Web browser to access the NIC.

The Network Configuration window appears.



2. Enter **Access** for the password.

A screen that lists your configuration options appears.



3. Click on the desired option.

## Service Names

Service names associated with the various protocols correspond to names that will show up on your network such as Windows Network Neighborhood and Macintosh Chooser. Default service names reflect the NIC's unique Ethernet hardware address digits.

If you wish to change the service names that are advertised on your network to something more descriptive of your printer, click on the corresponding service and type the name you prefer.

**NOTE:** For any modified parameters to take effect, they must be saved by resetting the print server before terminating your Web browser connection or by turning the printer off and then on.

## Examples of Configuration Screens

The following screens are examples of Web interface features that are supported.

### TCP/IP

The screenshot shows a web browser window titled "Webpage - PrintServer Web Configuration". The address bar shows the URL: `http://129.128.131.134/ps/cfg?access=C30712E87E1D4D3&password=&language=`. The page content is titled "Kodak Network PrintServer Configure TCP/IP".

TCP/IP	<input checked="" type="checkbox"/> Enable <input type="checkbox"/> Disable
Enabled Services	<a href="#">KOD_006940_P1</a> <a href="#">HD3ARY_P1</a> <a href="#">TEXT_P1</a> <a href="#">POSTSCRIPT_P1</a> <a href="#">RASTER_P1</a>
IP Address	IP Address: <input type="text" value="129.128.131.134"/> Subnet Mask: <input type="text" value="255.255.255.0"/> Gateway: <input type="text" value="0.0.0.0"/> Boot Method: <input type="text" value="STATIC"/> Boot Time: <input type="text" value="0"/>
RARP Boot Settings	<input type="checkbox"/> No Subnet Mask <input type="checkbox"/> No Gateway
TCP Window	<input type="text" value="10240"/>
TCP Timeout	<input type="text" value="30"/> min
LPD Settings	<input type="checkbox"/> LPD Banner Enable <input checked="" type="checkbox"/> LPD Retry Enable

Buttons:

Links: [\[Main\]](#) [\[Help\]](#)

## Novell Network

The screenshot shows the 'Kodak Network PrintServer Configure Network' web page. The browser window title is 'Netscape - [PrintServer Web Configuration]'. The address bar shows 'http://128.126.134.134/np/printserver.cgi?access=C:381121E6%0D03&password=lang.asp#0'. The page content includes:

Network	<input checked="" type="radio"/> Enable <input type="radio"/> Disable
Enabled Services	KOD_02E640_P1
Active Servers and Queues	None
Frame Type	[0] AUTO
Network Password	Enter new password: <input type="text"/> Confirm new password: <input type="text"/>

Buttons: [Reset] [Submit] [\[Main\]](#) [\[Help\]](#)

## NetBEUI

The screenshot shows the 'Kodak Network PrintServer Configure NetBEUI' web page. The browser window title is 'Netscape - [PrintServer Web Configuration]'. The address bar shows 'http://128.126.134.134/np/netbeui.cgi?access=C:381121E6%0D03&password=lang.asp#0'. The page content includes:

NetBEUI	<input checked="" type="radio"/> Enable <input type="radio"/> Disable
Enabled Services	KOD_02E640_P1
NETBIOS Name	KOD_02E640_P1
Domain Name	WORKGROUP

Buttons: [Reset] [Submit] [\[Main\]](#) [\[Help\]](#)

### AppleTalk





## Using the XAdmin Utility

The XAdmin utility is provided with the NIC for use with Windows operating systems. A setup utility must be executed to install XAdmin. XAdmin can be used as an alternative to JetAdmin NetWare if you are using Netware.

Most parameters for NetBEUI, NetWare, and TCP/IP can be modified with XAdmin. For configuration of additional parameters, use a Web browser, XConfig, or Telnet utilities.

1. To start XAdmin, either use the Win 95/NT Start > Programs > XAdmin > XAdmin mechanism or click on the XAdmin executable installed in the XAdmin folder.
2. Double-click on the appropriate NIC represented as KOD\_xxxxxx\_P1 in the list.
3. Enter **Access** as the password.

NOTE: Your password will not appear as it does in the illustration.

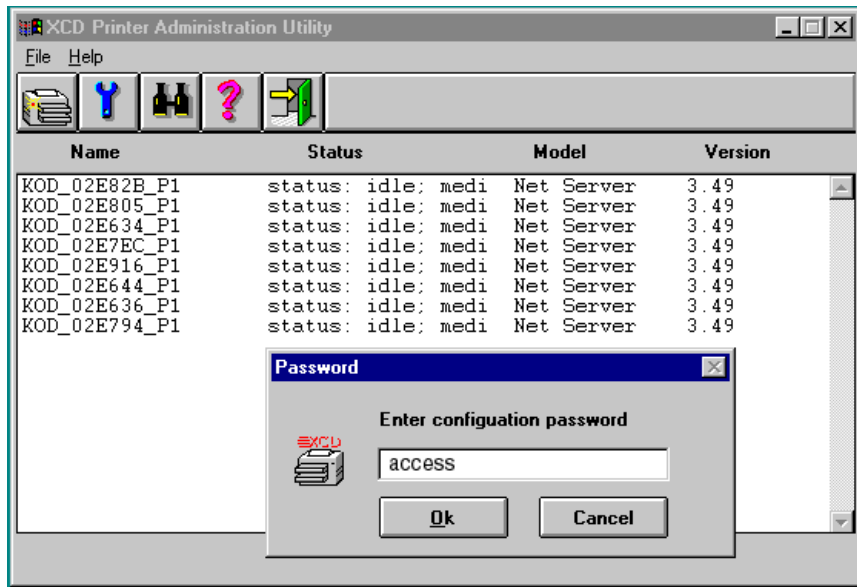



The following screens illustrate XAdmin interface features:

**KOD\_02E916\_P1 Configuration**

General | Network | TCP/IP | NetBEUI | Internet | Banyan | Services | Firmware

**Node Name**

**Serial Number**

**Enabled Protocols**

<input checked="" type="checkbox"/> TCP/IP	<input type="checkbox"/> DLC/LLC
<input checked="" type="checkbox"/> Network	<input checked="" type="checkbox"/> NetBEUI
<input checked="" type="checkbox"/> AppleTalk	<input type="checkbox"/> LAT
<input type="checkbox"/> POP3/SMTP	<input type="checkbox"/> Banyan

**Password**

**New Password**

**New Password Verify**

Save password

Restore Factory defaults

Print Test Page

Note: For help on each field, press F1 when the field is highlighted.

**KOD\_02E916\_P1 Configuration**

General | **Network** | TCP/IP | NetBEUI | Internet | Banyan | Services | Firmware

**Operating Mode**

Queue Server

Remote Printer

**Queue Server Settings**

**Print Server Name**

**NDS Tree**

**NDS Context**

**Bindery Print Queues**

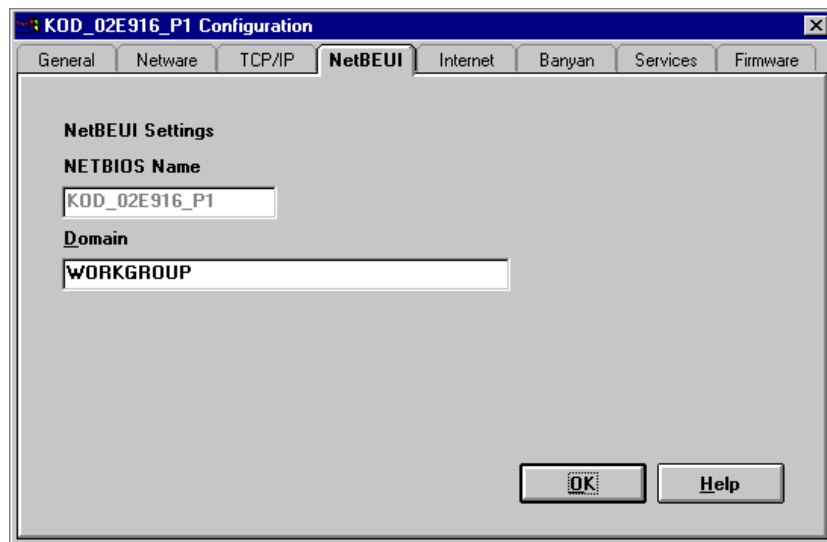
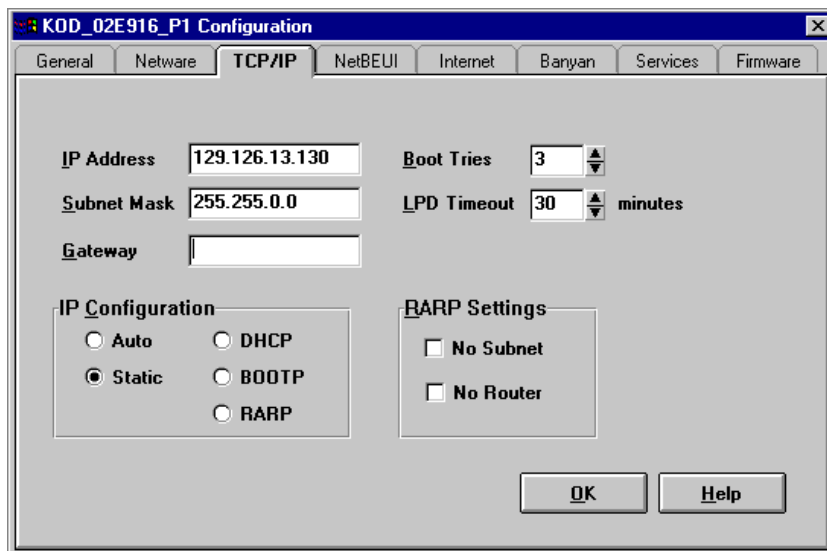

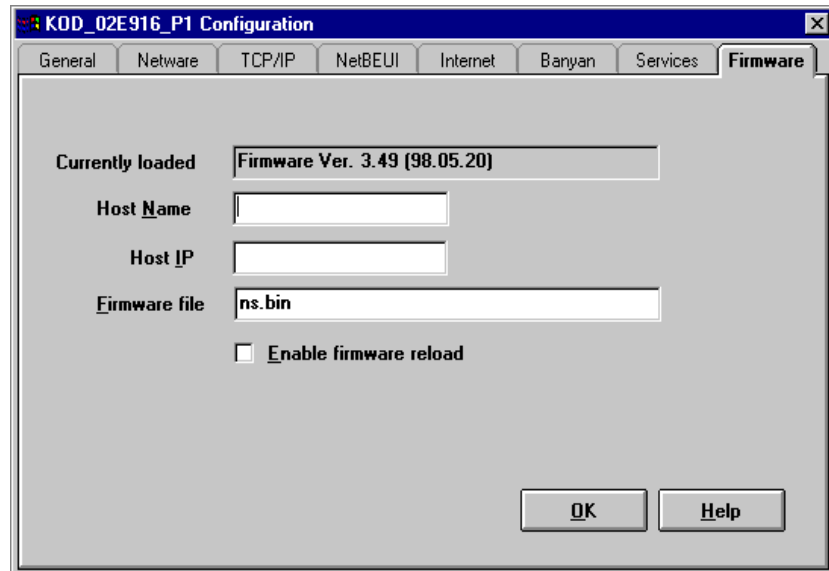
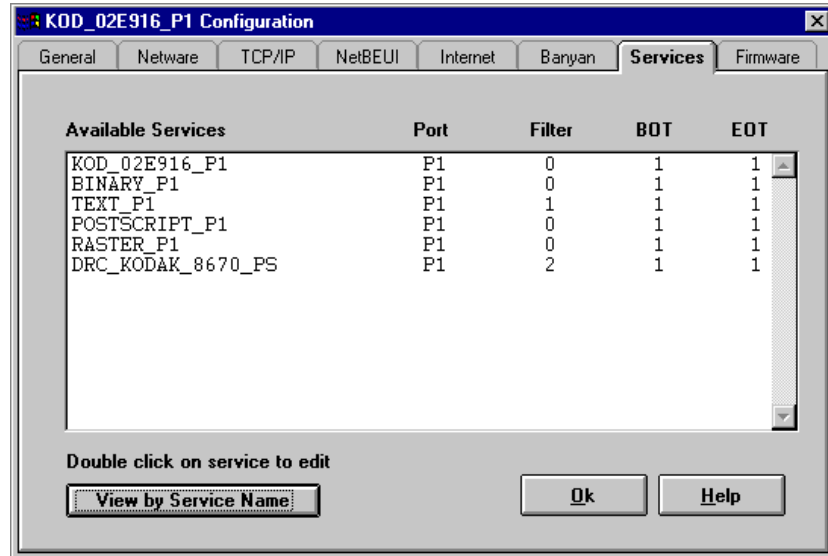

## Using XConfig Utility

The XConfig utility is provided with the NIC for use with Windows operating systems. Use the setup utility to install XConfig along with XAdmin. XConfig is a command line interface that can be used to issue commands and get a status from the NIC.

XConfig and Telnet are equivalent command line interfaces. XConfig does not require a prior address configuration if your system is configured to support IPX. (The NIC can be selected from its default "KOD\_xxxxx\_P1" address.) However, Telnet requires that an IP address first be established on the NIC.

1. To start XConfig, either use the Win 95/NT Start > Programs > XAdmin > XConfig mechanism or click on the XConfig executable which is installed in the XAdmin folder.

If you have one printer with a NIC installed, you will be immediately connected. If you have more than one NIC, a screen appears that gives you a list of available NICs.

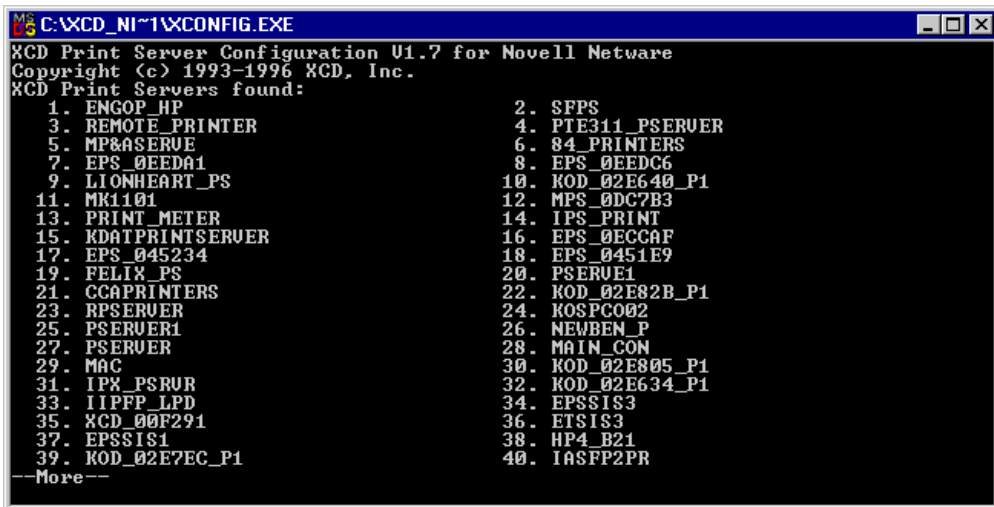

```
MS-DOS C:\XCD_NI~1\XCONFIG.EXE
XCD Print Server Configuration U1.7 for Novell Netware
Copyright (c) 1993-1996 XCD, Inc.
XCD Print Servers found:
 1. ENGOP_HP
 2. SFPS
 3. REMOTE_PRINTER
 4. PTE311_PSERUER
 5. MP&ASERUE
 6. 84_PRINTERS
 7. EPS_0EEDA1
 8. EPS_0EEDC6
 9. LIONHEART_PS
10. KOD_02E640_P1
11. MK1101
12. MPS_0DC7B3
13. PRINT_METER
14. IPS_PRINT
15. KDATPRINTSERUER
16. EPS_0ECCAF
17. EPS_045234
18. EPS_0451E9
19. FELIX_PS
20. PSERUE1
21. CCAPRINTERS
22. KOD_02E82B_P1
23. RPSEUER
24. KOSPC002
25. PSERUER1
26. NEWBEN_P
27. PSERUER
28. MAIN_CON
29. MAC
30. KOD_02E805_P1
31. IPX_PSRUR
32. KOD_02E634_P1
33. IIPFP_LPD
34. EPSSIS3
35. XCD_00F291
36. ETSIS3
37. EPSSIS1
38. HP4_B21
39. KOD_02E7EC_P1
40. IASFP2PR
--More--
```

2. Select the appropriate NIC represented as KOD\_xxxxx\_P1.

3. Enter Access at the # prompt for the password.

```

C:\XCD_NI~1\XCONFIG.EXE
53. DOROTHY
55. NCTPSERVER
57. KRL_SITOP_PRINTERS
59. KOD_02E636_P1
61. OISR02
63. ADM
65. LU1
67. LP001
69. KOD_02E794_P1
54. HAIRNET
56. EEO
58. MK1191
60. OISR01
62. MPS_1BF2CD
64. IAS1PRMT
66. RIANDON
68. FSD

Printer to configure [1-69]: 69
Contacting KOD_02E794_P1
Connection established
Press ESC to exit

#

Kodak Network PrintServer
Configuration Program U3.3

Type HELP for command list

Enter username>

```

```

C:\XCD_NI~1\XCONFIG.EXE

#

Kodak Network PrintServer
Configuration Program U3.3

Type HELP for command list

Enter username>

Local> help

EXIT/^D          Exit program
HElP             Information on available commands
INitialize       Reset unit
CLEAR/PURge/DELeTe Remove configuration item
SET/DEFine/CHange Modify unit parameters
SHoW             Display unit parameters
ZEro             Zero statistical counts

Type 'HElP <cmd>' for more information

Local>

```

4. Type Help for further assistance.

```
C:\XCD_NI~1\XCONFIG.EXE
Zero statistical counts
Type 'HElP <cmd>' for more information
Local> help set
APpletalk      AppleTalk Parameters
BAnyan         Banyan Parameters
DEFAULT        Set parameters to factory defaults
DLC            DLC Parameters
IP             LPD/TCP/TELNET Parameters
LAt            LAT parameters
LOAd           Firmware update parameters
NetBEUI        NetBEUI Parameters
NETWare        Netware Parameters
PAssword <password> Set console password
POP3           POP3 Parameters
POrt <name> ...  Parameter for port <name>
PROtect <password> Set update password
SERVEr         Server and LAT parameters
SERVIce <name>  Service Parameters
SMTP           SMTP Parameters
SNMP           SNMP Variables
Local>
```

NOTE: Refer to the configuration command section in Appendix B for a summary of commands and syntaxes for use with XConfig, Telnet or serial port sessions with the NIC.

### Telnet Configuration Utility (Any Platform)

The Telnet utility is not provided with the NIC as utility software. Telnet is typically provided with any system that supports communications with TCP/IP.

XConfig and Telnet are essentially equivalent command line interfaces. However, Telnet requires that an IP address first be established on the NIC.

An IP address can be established in a variety of ways. One method is to enter an IP address on the printer's front display panel by entering the setup menu and following the prompts. Refer to the Operator's Guide on the CD that came with the printer for more information on using the Setup menu.

1. A Telnet session is typically established by entering the following command line:

telnet <IP Address>

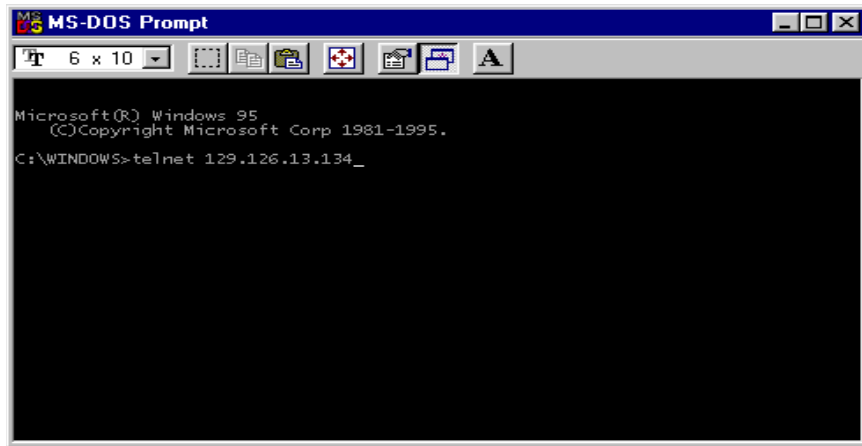

2. Enter Access as the password.
3. Type **Help** for further assistance.



NOTE: Refer to the configuration command section in Appendix B for a summary of commands and syntaxes for use with XConfig, Telnet or serial port sessions with the NIC.

## Connecting the NIC Serial Configuration Port to a Console Terminal

The console facility is used for diagnosing and configuring the NIC. It can also be used for downloading new firmware to the NIC. The console is accessed from the NIC's serial port which has a PC-compatible 9-pin male D-connector.

The following table lists the function of each of the pins in the D-connector:

DE9			DTE	DCE
Pin	Signal	Signal	Pin	Pin
1	Not Used	Not Used	-	-
2	Recve Data	Trnsmt Data	2	3
3	Trnsmt Data	Recve Data	3	2
4	DTR Out	DSR In	6	20
5	Signal Grnd	Signal Grnd	7	7
6	DSR In	DTR Out	20	6
7	RTS Out	CTS In	5	4
8	CTS In	RTS Out	4	5
9	Not Used	Not Used	-	-
Settings:	9600 bps	No Parity	XOn/XOff	8 bit Chars

The standard 9-pin female to 25-pin male PC cables require a null modem to connect to most printers or terminals. The cable must connect input signals such as receive data on the NIC to the equivalent output signals such as transmit data on the device and vice-versa.



The serial port always operates at 9600 bps with no parity, XON/XOFF flow control, and 8-bit characters when in console mode. Make sure that your terminal is set to these parameters.

NOTE: Refer to Appendix B for a summary of commands and syntaxes for use with XConfig, Telnet or serial port sessions with the NIC.

## Configuring the NIC from the Printer's Display Panel

Some NIC parameters can be configured from the printer's display panel.

Keys on the printer control panel can be used to:

- enter the Setup menu (Setup/Select key).
- scroll up through menus (Print key).
- scroll down through menus (Cancel key).
- select items (Setup/Select key).

Setup menu items can either be viewed for status or configured to accommodate your network printing environment. Use the scroll keys to scroll to the next number.

1. When the printer is in the Ready state, select Setup.
2. Scroll through the menu items to select Status or Ports for NIC parameters.
3. Exit the setup mode.
4. Reset the NIC to save any configuration changes.

The following items are available on the Status menu for the NIC:

```
Status>  NIC>  Serial #  
  
                FW Version  
  
                Link
```

The following options are available from the Ports menu:

Ports>	Network			
		IPX	FrameTypes	802.3
				802.2
				SNAP
				Ethernet II
				Auto (Default)
		TCP/IP	Status	IP Address
				Router Addr
				Subnet Mask
			Address	IP Address
				Router Addr
				Subnet Mask
			Type	Static
				BootP
				RARP
				DHCP
				Auto (Default)
			# of Tries	3 (Default)
		EtherTalk	Version 2	
		Test Print <sup>1</sup>	NIC Config	Parameters
		Reset <sup>2</sup>	(NIC Only)	

<sup>1</sup>This test print is for NIC configuration parameters. Exit Setup before the test print can be generated. Do not confuse this test print with the test print generated by pressing Print on the front display.

<sup>2</sup>Resets the NIC for parameter changes.

## Additional Mechanisms for Establishing an IP Address

### Enabling IP access using ARP

You must be on the same Ethernet segment to use the `arp -s` command. There cannot be a router between the NIC and the system using ARP.

The `arp` mechanism will only enable that workstation to access the NIC using the IP address used in the `arp` command. It is still necessary to set that IP address on the NIC using any NIC configuration utility in order for that IP address to be saved on the NIC.

To use `arp` on Windows:

1. From the MS-DOS prompt use the `arp -s` command to enter the IP address into the NIC as shown in the following example:

```
arp -s 192.189.207.77 00-40-17-00-ed-d6
```

Substitute your actual IP address for 192.189.207.77, and replace the 00-40-17-00-ed-d6 with the actual Ethernet address of the NIC.

2. Use the `ping` command with the NIC's IP address to verify the connection. For example:

```
ping 192.189.207.77
```

Substitute your actual NIC IP address in 192.189.207.77 in the above examples. You should get a response back from the NIC if the IP address has been set and the NIC installed in the printer is alive on the network.

### Using Arp on Unix Systems

To use `arp`, enter the following command at the UNIX system prompt:

```
arp -s ipaddress ethernetaddress temp
```

Ethernetaddress is the Ethernet address of the print server, and IPaddress is the IP address of the print server. For example:

```
arp -s 192.189.207.2 00:40:17:00:c3:e4 temp
```

### Using rarp to Configure the IP Address

You can configure the NIC IP address using the reverse ARP (rarp) utility on the host computer. To use rarp, edit the `/etc/ethers` file with an entry similar to the following. If the file does not exist, you can create it.

```
00:40:17:00:01:07 KOD_000107
```

The first entry is the Ethernet address of the NIC print server, and the second entry is the name of the NIC.

NOTE: The name must be the same as the one you entered in the `/etc/hosts` file.

If the rarp daemon is not already running, start it by using one of the following commands:

- `rarpd`
- `rarpd -a in.rarpd -a`

NOTE: Refer to the system's documentation for more information about starting the rarp daemon.

To verify that the rarp daemon is running on a Berkeley Unix system, type the following command:

```
ps -ax | grep -v grep | grep rarpd
```

For At&T UNIX systems, type the following command:

```
ps -ef | grep -v grep | grep rarpd
```

The NIC will get the IP address from the rarp daemon when it is powered on.

### Using BOOTP to Configure the IP Address

BOOTP is an alternative to rarp that allows configuration of the subnet mask and gateway. To use BOOTP to configure the IP address into the NIC, make sure that BOOTP is installed and running on your host computer. It should appear in the `/etc/services` file on your host as a real service.

BOOTP is usually started from the `/etc/inetd.conf` file. To enable it, remove the `#` in front of the bootp entry in that file. For example, a typical bootp entry in the `/etc/inetd.conf` file would be:

```
#bootp dgram udp wait /usr/etc/bootpd bootpd -1
```

Depending on the system, this entry might be called `bootps` instead of `boot`.

To enable BOOTP, use an editor to delete the # sign. If the # sign does not appear, BOOTP is enabled.

Edit the BOOTP configuration file (usually `/etc/bootptab`) to enter the name, network type (1 for Ethernet), Ethernet address (found on the label on the NIC box), and IP address, subnet mask and gateway of the NIC.

NOTE: Refer to your system documentation to determine how to enter this information.

Some BOOTP host software implementations will not respond to BOOTP requests if you have not included a download filename in the configuration file. If necessary, create a null file on the host and specify the name of this file and its path in the configuration file.

The NIC will load its IP address from the BOOTP server when the printer is powered on.

If you do not have subnets, use one of the following default subnet masks:

255.255.255.0 for class C networks

255.255.0.0 for class B networks

255.0.0.0 for class A networks

NOTE: The type of network you have can be identified by the leftmost group of digits in your IP address. The value of this group ranges from 192 through 255 for Class C networks, 128 through 191 for Class B networks, and 1 through 127 for Class A networks.

3. Enter the address of the gateway with the command `SET IP ROUTER`. The router address is the desired IP address of the gateway you wish to assign to the NIC. For example:

```
Local> SET IP ROUTER 192.198.207.1
```

4. Enter `SHOW IP` to verify that you have entered the IP information correctly.
5. Press `CTRL-D` to end the remote console session.

6. Use the Unix ping command with the IP address of the NIC to verify the connection between the host and the NIC:

```
ping 192.189.207.3
```

NOTE: You should get a message that the NIC is active. You will not be able to print if you cannot ping the NIC. If you get an error message or no response, there is no connection. Verify that you have set up the host and the NIC correctly and check the connections. Refer to "Troubleshooting".

7. Use the standard lpr command with the -P option to specify the queue name. For example, to print the file TEST on the queue laser1, you would enter:

```
lpr -Plaser1 TEST
```

Some AT&T Unix systems such as SCO and HP/UX use the standard lp command instead of lpr. For these systems use the -d option instead of -P to specify the queue name as shown in the following example:

```
lp -dlaser1 TEST
```

## **4 *Configuring Servers and Workstations for Printing***

### **AdobePS Drivers and Export Modules**

The AdobePS drivers (supplied with your Kodak printer software) must be installed on each workstation that will be printing files to a Kodak PostScript printer.

The Kodak export module (supplied with your Kodak printer software) must be installed on each workstation that will be exporting files to a Kodak raster printer.

NOTE: Kodak does not provide drivers and export modules for Unix systems. Refer to "Configuring for TCP/IP" for more information on Unix support.

### **Novell Servers**

Refer to "Novell NetWare" for details on configuring Novell server queues to support your Kodak printer.

Novell Netware 5.x supports communications using TCP/IP. Prior versions (3.x, 4.x) support IPX and AppleTalk Print Services but do not support TCP/IP. Refer to your Novell Netware 5.x documentation for information about using TCP/IP and configuring print queues.

### **Windows NT 4.0, Windows 2000 Servers and Workstations**

Refer to "Configuring for TCP/IP" for details on configuring these platforms as servers or workstations using an LPR port.

Windows 95/98/NT systems also support Peer to Peer printing using NetBEUI. Refer to "Microsoft Peer to Peer Printing Services (NetBEUI)" for configuration details. For PostScript printing, a local printer must be set up on each workstation. For raster file printing, the printer can be selected by browsing the network from the export module for a network queue.

## **Unix Servers and Workstations**

Refer to “Configuring for TCP/IP” for details on configuring these platforms as servers or workstations. Also refer to the notes in that chapter regarding support for Unix systems.

## **Windows for Work Groups (3.x)**

Windows for Work Groups systems can not be set up to print directly to printers over the network. An existing network print queue must be selected and captured to an LPT port.

## **Windows 95/98**

It is recommended that a Novell, NT or Unix network server print queue be established to support printing from Windows 95/98 systems. This method will support both PostScript and raster file printing.

Windows 95/98/NT systems also support Peer to Peer printing using NetBEUI. Refer to the “MicroSoft Peer to Peer Print Services NetBEUI” for configuration details. For PostScript printing, a local printer must be set up on each workstation. For raster file printing, the printer can be selected by browsing the network from the PhotoShop export module for a network queue.

## **Macintosh**

Macintosh systems use AppleTalk for network communications. Refer to “Configuring for AppleTalk” for details on network printing using AppleTalk.



## **5 Microsoft Peer to Peer Print Services (NetBEUI)**

Windows 95, Windows 98 and Windows NT systems provide Microsoft Peer to Peer services which allow these systems to share resources within a limited network domain. These native services utilize the system's NetBIOS in conjunction with NetBEUI protocol.

Native Peer to Peer services can also utilize the system's NetBIOS in conjunction with IPX protocol. Refer to the section at the end of this chapter for configuring peer to peer services using IPX and JetAdmin tools. The Kodak Professional 10/100 Network Interface Card (NIC) supports these peer to peer services by supporting communications via NetBEUI

By default the NIC's NetBEUI domain name is workgroup. This parameter must match the domain name defined for your Windows peer to peer network in order for the printer to appear as a resource in that domain. The NIC's domain name can be changed to reflect your domain name with NIC configuration utilities.

KOD\_XXXXXX\_p1 is the default NIC (printer) name advertised for peer to peer services. XXXXXX corresponds to the last six digits of the NIC's Ethernet address.

NetBEUI is a non-routable protocol. This means that peer to peer service resources such as printers will ONLY be accessible to users on the same subnet (and domain) that the printer is on.

### **Workstation Networking Software for Peer to Peer Services**

The following system software components must be installed on each Windows system that must support peer to peer resource sharing. Use the Network Control Panel to view or install these components.

- Client: Client for Microsoft Networks
- Service: File and Printer Sharing for MicroSoft Networks
- Protocol: NetBEUI

**Note:** Refer to the documentation and software provided with your printer for specific installation details you may need to know for that printer, especially if you encounter problems.

## Setting up a Kodak PostScript Printer for Windows 95/98

1. Run the AdobePS setup utility provided on your printer CD.

Note: Only significant setup screens are illustrated.

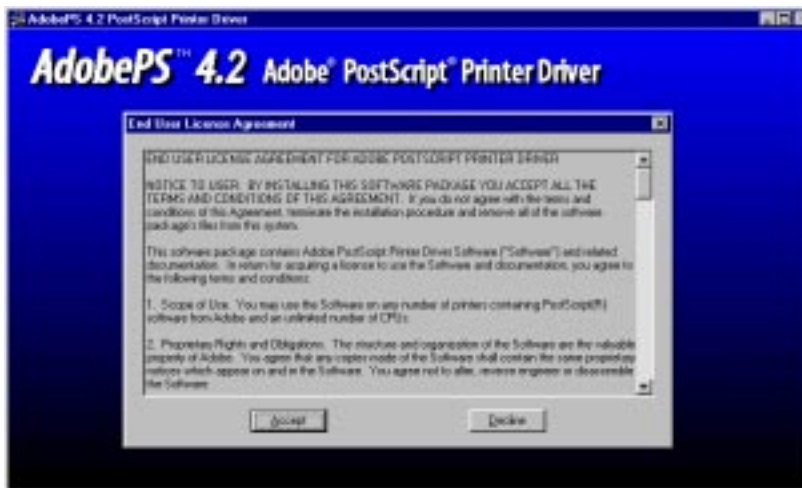

You may see additional self-explanatory screens for reading readme files and copying the AdobePS setup utility.

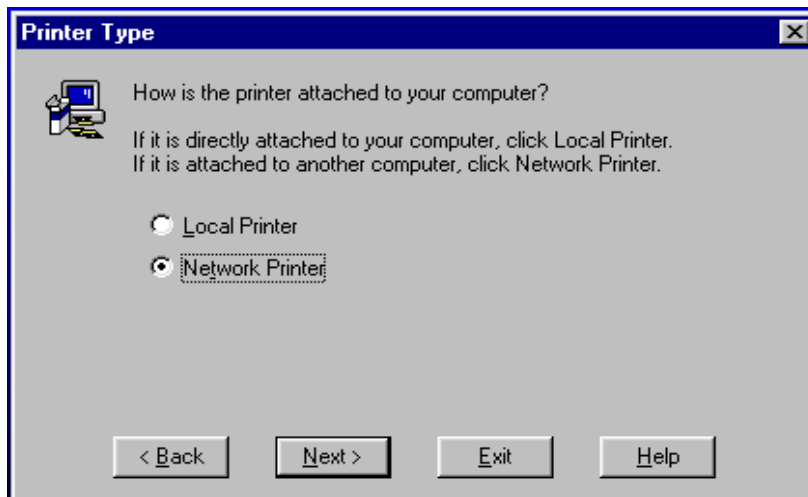

2. When prompted for the type of connection, select Network Printer.

3. Browse the network for your Kodak printer.

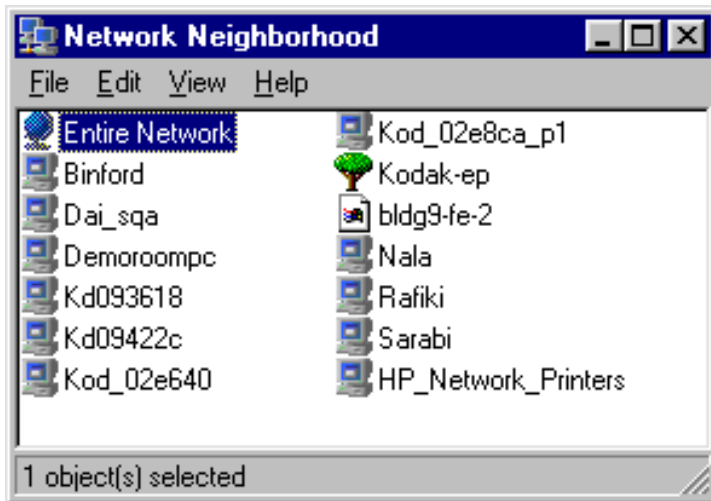

4. If the printer displays immediately as KOD\_xxxxxx\_p1 (default name), select it and continue.

Otherwise continue your search by selecting Entire Network > Microsoft Windows Network > Peer to Peer Domain Name (WorkGroup by default), for example until your printer is located.

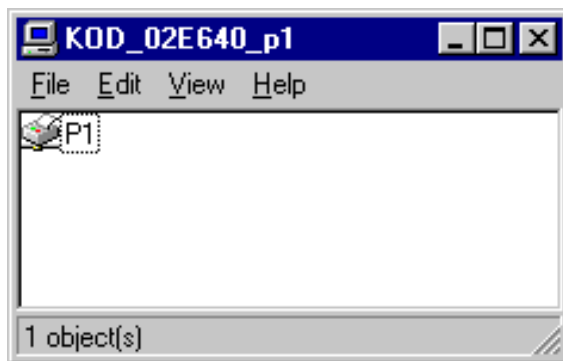

Note: If you receive Network Path not Found, Not a Win95 Host messages after selecting KOD\_xxxxxx\_p1 and then p1 as the corresponding printer port, ignore them and continue

5. Locate the drive and directory where the printing software resides for your Kodak printer and select the Kodak printer, Kodak 8670 PS.

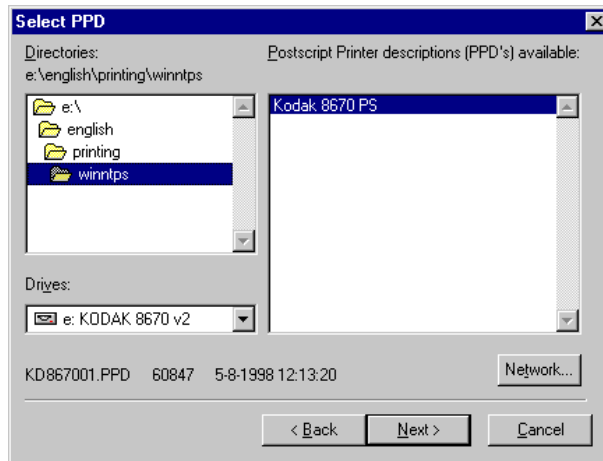

6. Continue through setup screens, assign a printer name, and finish by selecting the appropriate printer media in the Properties menus.

The user may now print from applications after selecting the Kodak printer from the list of printers available in the Print/Setup windows.

## Setting up a Kodak PostScript Printer for Windows NT

The setup for Windows NT is similar to the Windows 95/98 setup using the AdobePS setup utility. On NT systems however, peer to peer resources that are not host resources or queues do not show up in the AdobePS utility when browsing for a network printer.

On NT systems, it is necessary to establish a local printer port mapped to the NetBEUI resource first and then run the AdobePS setup utility selecting the resource as a local instead of a network printer.

Note: KOD\_XXXXX\_p1 and p1 are default printer/NIC NetBeui names. A resulting printer/port would appear in a text window as \\KOD\_XXXXX\_p1\p1.

Use the Network Neighborhood utility to locate your NetBEUI network resource in the form of KOD\_XXXXX\_p1 and then p1 as the corresponding printer port in the following manner:

1. Select Entire Network (If KOD\_xxxxxx\_p1 does not already appear.)

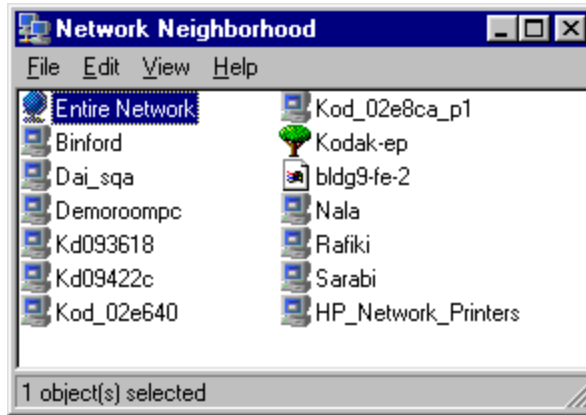

Note: If Microsoft Windows Network appears, select it and then > Peer to Peer Domain Name (WorkGroup by default) until your printer is located.

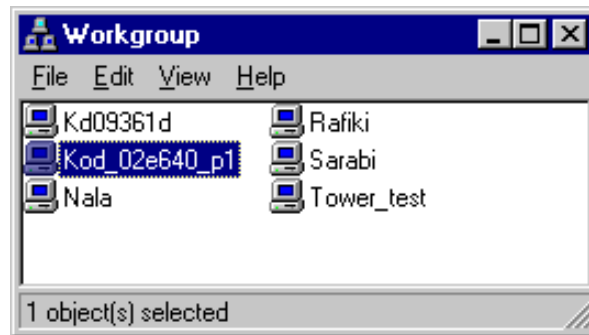

2. By selecting p1, you will be prompted to setup the printer. Select any driver since you are merely establishing a port on your system.

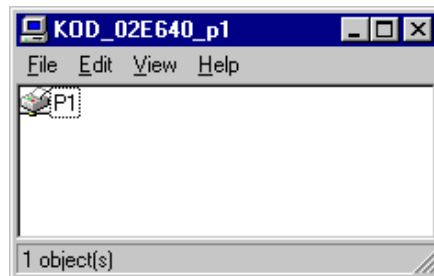

After completing this setup utility, the NetBEUI network port is added to your system as an available printer port which can now be selected when running the AdobePS setup utility.

## AdobePS Setup Utility for Windows NT

1. Run the AdobePS setup utility provided with your printer.

Note: Only significant setup screens are illustrated.



You may see additional self-explanatory screens for reading readme files and copying the AdobePS setup utility.

2. When prompted for the type of connection, select Local Printer.

Note: The network cannot be selected because the NetBEUI print service does not show up in when browsing.

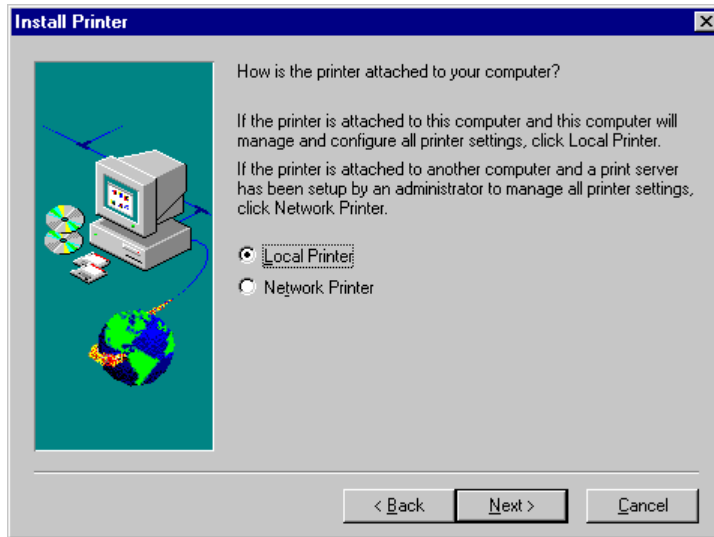

3. Locate the drive and directory where the printing software for your Kodak printers located, and select the Kodak printer.

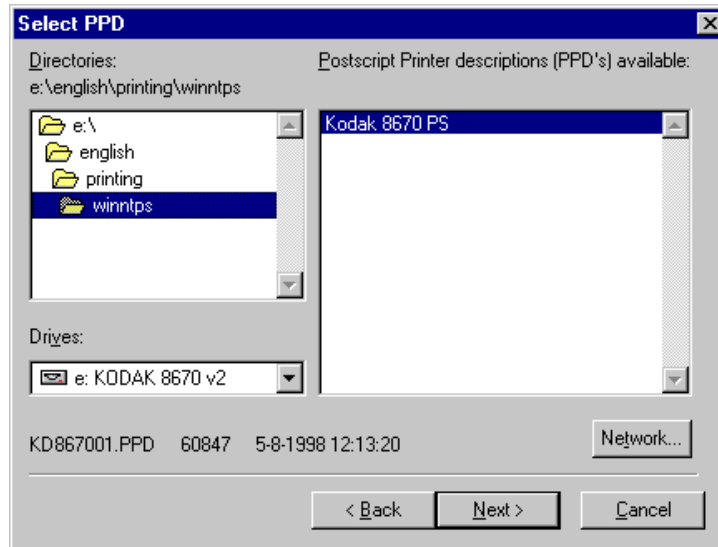

4. Select the NetBEUI printer port designated as \\KOD\_xxxxxx\_p1\p1. (KOD\_xxxxxx\_p1 is the default NetBEUI name for the printer (NIC).

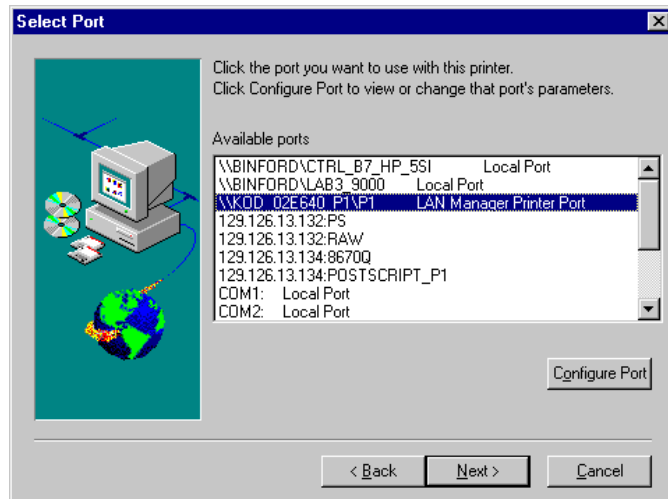

5. If the printer is shared, enter a queue name. The printer setup on subsequent systems will be simply a matter of selecting Network Printer and browsing for a network queue

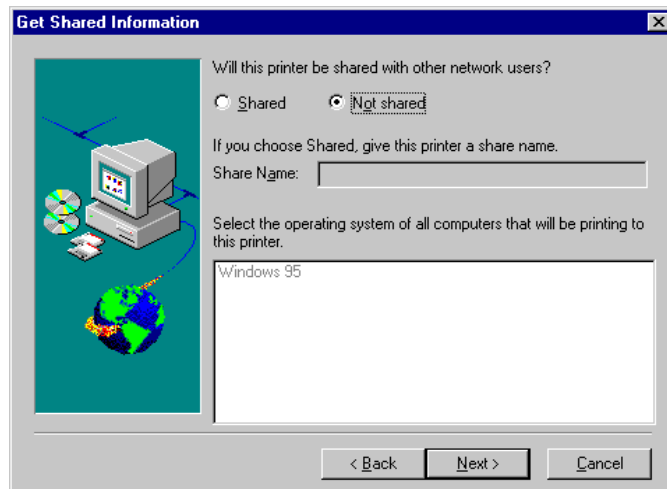

6. Continue through setup screens to assign a printer name and select the appropriate printer media in the Properties and/or document defaults menus.



The user may now print from applications after selecting the Kodak printer from the list of printers available in the Print/Setup windows.

## Verification of AdobePS Driver

After installation, the AdobePS driver should appear as an available driver in any printer Properties window.

1. Check the properties for the printer that was created in the previous steps to make sure that the AdobePS driver, AdobePS Kodak 8670 PS, appears in the driver pulldown selections.

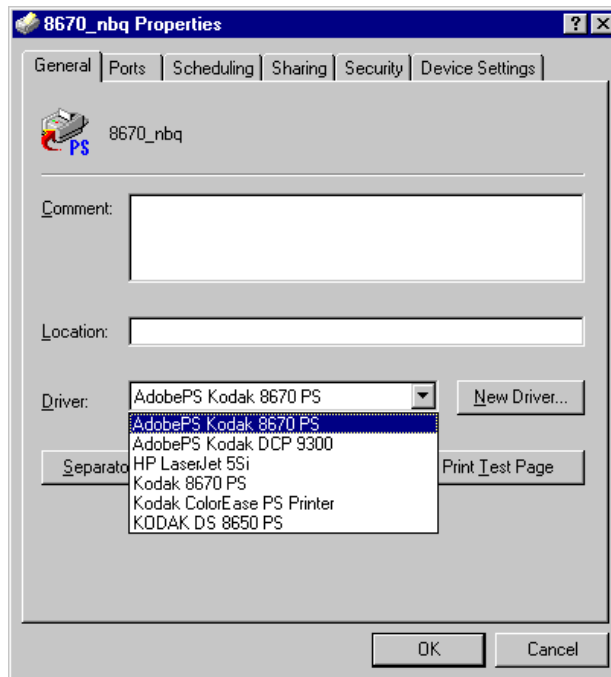

**Note:** If Kodak 8670 PS appears without the AdobePS prefix, the Microsoft PostScript driver with the Kodak PPD has been installed. This driver is NOT recommended because it does not provide all of the features that are available with the AdobePS driver.

If the AdobePS driver has already been installed, select it as the driver for any subsequent printers created. Make sure you also check the remaining printer property tabs and make selections for the media in the printer.

## **Setting up Windows 95/98/NT to Export Kodak Raster Files**

1. Run the Export - setup utility provided with your printer software. This will install the necessary plug-ins and media files necessary for exporting files from Adobe PhotoShop. To exporting files from Photoshop:
1. From Adobe PhotoShop, select File > Export > Kodak Printer Name.
2. Select the Kodak printer as KOD\_XXXXXX\_p1/p1 (default name) where XXXXXX corresponds to the last six digits of the printer's (NIC) Ethernet address.
3. Select Print.

## 6 **Novell NetWare**

A NetWare file server provides print spooling for clients so that they can print over a network. The file server holds print jobs until it is contacted by a print server on the network which in turn sends the job to the appropriate printer. NetWare print servers are typically special-purpose networking hardware such as the Kodak Professional 10/100 network interface card (NIC).

NOTE: It is assumed that network administrators are familiar with setting up Novell NetWare systems and print queues using appropriate utilities such as PConsole and NWAdmin.

This chapter provides details on selecting and configuring the printer/NIC to service Novell queues.

### **Before You Begin**

Before you begin the configuration for NetWare, make sure that you have completed the following steps:

- Establish the NetWare queues and services before you configure the printer 's network Interface to service them.
- Consult NetWare documentation for instructions on setting up queues and services.
- Set up the printer. Refer to the QuickSetup card or the Operator's Guide which is included on the CD for instructions on setting up your printer.
- Install the NIC in the printer and connect it to an Ethernet network. Refer to "Installing the Hardware" for instructions on installing and verifying the NIC and the network connection.
- Install printer software for Windows 95, Windows NT, or Windows 3.11 on PCs that will be sending jobs to the printer. This software is included on the CD that came with the printer.

## NIC Operating Modes with Novell NetWare

To service NetWare print queues, the NIC operates in the following two modes:

### **Remote printer mode or NPRINT mode on NetWare 4.xx or RPRINT mode on NetWare 2.xx or 3.xx networks.**

In remote printer mode, the user sends the print job to the file server which then spools it to a print server and sends it to the printer. Remote printer mode does not use a user license on the file server. If you have NetWare 4.xx and need to take advantage of NetWare Directory Services, you must use remote printer mode.

### **Queue server mode also called printer server or PSERVER mode.**

In queue server or print server mode, the NIC functions as a NetWare print server eliminating the need for a dedicated print server. Jobs from the a PC are spooled to the file server which in turn spools the job directly to the NIC. Queue server and print server mode, however, require a user slot on the file server.

NOTE: We recommend that you use queue server mode if you have NetWare2.xx or 3.xx unless you have a limited number of available user slots.

## Configuring for a Novell NetWare Network

To use the NIC on a Novell network, one or more file servers must be configured with a print queue that the NIC can service. Users send their print requests to the file server's print queue, and the jobs are then spooled to the NIC directly or through an intermediate print server in remote printer mode.

## **Novell Queue and Printer/NIC Association Using JetAdmin**

The NIC is compatible with Hewlett-Packard's JetAdmin tool. JetAdmin may be used to select a particular printer/NIC that is advertising its services on the network. The NIC's NetWare service is KOD\_XXXXXX\_P1, by default where XXXXXX is the last six digits of the NIC's Ethernet hardware address. The NIC can then be associated with a particular Novell server and queue.

NOTE: You must be logged into the particular Novell server as an administrator in order to set up NIC parameters associated with that server.

JetAdmin can be used to configure NetWare related parameters on the NIC.

## **Novell Queue and Printer/NIC Association Using XAdmin or XConfig**

Refer to "Using Configuration Utilities" for additional details on using the following configuration utilities for the NIC:

- XAdmin is a graphic configuration utility which is included on the diskette that comes with the NIC. XAdmin allows an administrator to establish and associate the NIC with a NetWare queue using the NetWare submenu options.

NOTE: You must be logged into the particular Novell server as an administrator to set up NIC parameters associated with that server.

- XConfig is a command line oriented NIC configuration utility which is included on the diskette that comes with the NIC. It is similar to invoking a Telnet session without the necessity of first establishing an IP address on the NIC.

NOTE: A new name can be entered for the NIC if desired. Changing the name also changes any other protocols that use the same name.

## Configuring for NDS Using NWAdmin

Refer to your NWAdmin documentation for specific details on using NWAdmin.

Make sure that you are logged in as Admin in NDS mode on the NetWare 4.xx file server.

To configure the NIC using NWAdmin:

1. Select the desired organizational unit that will contain the new printer.
2. Create/Add a new printer object with the name of the printer (NIC).
3. Select the desired container object (organizational unit) that will contain the default print queue.
4. Create a new print queue.
5. Select the print queue and assign the print queue to the printer you created.
6. Exit NWAdmin.

## Configuring for NDS Using JetAdmin or XAdmin

Refer to your JetAdmin documentation for specific details on the use of JetAdmin.

NOTE: The same service cannot be used for both queue server mode and remote printer mode. If you wish to enable remote printer capabilities or services other than the default NetWare services, you must define the new services that are enabled for NetWare and for the desired port.

1. Double-click on the icon for JetAdmin or XAdmin. Select the name of the NIC from the list

NOTE: The default name of the NIC is KOD\_XXXXXX.

2. From JetAdmin or Xadmin, select the remote printer as the operating mode. Select the name of your printer/NIC as the print server name, and select the number of the printer you made a note of as the printer number.
3. Select the desired default printer driver.

4. Exit Jet Admin or XAdmin.
5. Reload the PSERVER NLM from the NetWare file server console.

## **Configuring for NDS Using PCONSOLE and XConfig**

The following steps describe how to use PCONSOLE and XConfig to configure the NIC for remote printer operation.

### **PCONSOLE**

1. Make sure that the PSERVER NetWare Loadable Module (NLM) is loaded on your file server.
2. Log in as supervisor (Netware 3.xx) or as admin (NetWare 4.xx).

NOTE: If you want NDS support, do not log in under bindery mode.

3. Run the PCONSOLE utility from your PC workstation.
4. Create a new print queue. Enter a volume name, if necessary.
5. Select Print Servers from the PCONSOLE menu and then select the name of the printer/NIC.
6. Enter the printer name from the Object and Class menus.
7. Select the printer's name, and make a note of the printer number assigned by PCONSOLE.
8. Select the print queue, and assign it to the remote printer.
9. Exit PCONSOLE.

## XConfig

1. Insert the diskette that came with the NIC into the disk drive.  
Enter:  
A:XCONFIG.
2. Select the NIC from the list of print servers. Press ENTER when the message that the NIC is connected appears.
3. Enter the password access when the # prompt appears.
4. Press ENTER when the Enter Username> prompt appears.
5. When the Local> prompt appears, enter:  
SET NETW NPrinter pserver number ON service  
SET NEW RESCAN  
EXIT

Pserver is the name of the printer/NIC on your file server. Number is the printer number which must match the printer number you selected during the PCONSOLE configuration in the previous steps. Service is the name of the service where the default service is KOD\_XXXXXX. The XXXXXX is the last 6 digits of the Ethernet address. For example, to set up remote printer 3 on the NIC, KOD\_00C3E4 using the printer/NIC called KOD1PS, you would enter:

```
SET NETW NPrinter KOD1PS 3 ON KOD 00C3E4 P1  
SET NETW RESCAN  
EXIT
```

NOTE: You cannot use the same service for both queue server mode and remote printer mode.

To enable remote printer capabilities on services other than the default NetWare services, define the new services that are enabled for NetWare and the desired port. Refer to Appendix A for more information.

6. Reload the PSERVER NLM from your NetWare file server console to apply the changes.



## Configuring for Queue Server Mode using PCONSOLE and XConfig

The following steps describe how to use the standard Novell PCONSOLE utility with XCONFIG to set up your print queues.

### PConsole

1. Log in as Supervisor for Netware 3.xx or as ADMIN for NetWare 4.xx. Make sure that you specify the /b option for bindery mode.
2. Run the PCONSOLE utility from your PC workstation.
3. Select Print Servers from the available Options menu.
4. To create a new print server, enter the NIC Netware service name. The default name is KOD\_XXXXXX. The XXXXXX is the last 6 digits of the Ethernet address. Press ENTER.
5. Create a new queue on the file server. Enter the new queue name, and press ENTER.

NOTE: The name does not need to be related to the name of the NIC print server resources, but it should be short and convenient for users to remember.

6. Configure the queue by selecting Print or Queue Servers and specify which network print servers can print jobs from this print queue.
7. Select the NIC NetWare service name to add it to the list.
8. Exit PCONSOLE.
9. To force the NIC to rescan the file servers for print jobs, turn the printer off and then on.

NOTE: You may also use the XConfig command SET NETWORK RESCAN to force the NIC to rescan for file servers.

## XConfig

1. Log in as Supervisor (Netware 3.xx) or as Admin (NetWare 4.xx). Make sure that you specify the /b option for bindery mode.
2. Insert the diskette that came with the NIC into the disk drive. Enter the following at the DOS prompt:  
A:XCONFIG or A:XCONFIG ppsname  
Ppsname is the name of the NIC. The default name is KOD\_XXXXXX. The XXXXXX is the last six digits of the Ethernet address.
3. Select the NIC from the list of print servers if you did not specify the print server name in the XConfig command.
4. 4. When you get the message that the NIC is connected, enter the password Access in response to the # prompt. Press Enter in response to the Enter Username> prompt.
5. At the Local> prompt, enter:  
SET NETWARE SERVER servername ENABLED

NOTE: The servername is the name of the file server on which the print queue will reside. If there is more than one file server from which you wish to print, repeat this command as many times as necessary.

6. Exit XConfig.

## 7 *Configuring for TCP/IP*

The Kodak Professional 10/100 network interface card (NIC) supports TCP/IP. The NIC appears to the network as a print server with its own IP address using the lpd line printer daemon protocol. Any host computer that supports the remote lpr command can spool jobs to the NIC. The NIC also supports gateways for communications with hosts on remote networks. For special applications, a raw TCP port is available. Kodak develops printing software and supports networked printing environments for Windows and Macintosh platforms.

### **Windows**

For Windows platforms, NT is the only platform that supports TCP/IP printing. Win95/98 systems do not support direct printing using TCP/IP printing without the addition of special purpose TCP/IP LPR printing software.

### **Macintosh**

Macintosh systems use AppleTalk protocol for network communications and do not support TCP/IP printing without the addition of special purpose TCP/IP software.

### **Unix**

- Kodak does not develop printing software for Unix platforms. However, Kodak assists third-party developers who provide applications and printing software to support Kodak printers. Refer to the Kodak Web site ([www.kodak.com](http://www.kodak.com)) for information on third-party developer solutions.
- Some customers who have Unix applications and drivers capable of generating PostScript output files may wish to submit these files to Kodak PostScript printers.
- General information for configuring printers on Unix platforms is provided to accommodate the use of lpr to send output files to Kodak printers. If you encounter problems, administrators should refer to the documentation for their specific Unix platform for configuring print queues.

NOTE: Although generic PostScript files should print on Kodak PostScript printers, Kodak cannot guarantee the quality of output generated from non-Kodak drivers that may not support features such as calibration of Kodak printers.

## Configuration Summary

The following are the steps you need to complete to set up your printer for network printing:

1. Set up the printer. Refer to the QuickSetup card or the Operator's Guide that is included on the CD for instructions on setting up your printer.
2. Install the NIC in the printer and connect it to an Ethernet network. Refer to Chapter 2 for instructions on installing the NIC and Ethernet cable.
3. Obtain an IP address for the printer (NIC). Assign the IP address to the printer (NIC) using the printer's front control panel or by using remote NIC configuration tools.
4. Print a NIC configuration page to verify that the installation is correct. Refer to Chapter 2 for instructions on printing a NIC configuration page.
5. Configure network communications using TCP/IP on each workstation or server that will be communicating directly with the printer.

NOTE: Configuring network communications between workstation clients and servers is beyond the scope of this manual. For client/server environments, it is presumed that a functional client/server network environment already exists.

6. Install the printing software (AdobePS driver for and PPD for PostScript printing and/or export module for raster printing) on each workstation that will be sending jobs to the printer.

## Networking Software for TCP/IP

### Novell Netware Servers

Novell Netware 5.x supports communications using TCP/IP. Prior versions (3.x, 4.x) support IPX and AppleTalk Print Services, but do not support TCP/IP. Refer to your Novell Netware 5.x documentation for communications using TCP/IP and configuring print queues.

## Configuring TCP/IP (LPR) Printers on NT Systems

NOTE: You should refer to the documentation and software provided with your printer for specific installation details.

To configure a printer on a Windows NT workstation/server, first configure an IP address for both the workstation and the printer.

The following steps describe how to configure TCP/IP on a Windows NT workstation:

1. Install TCP/IP on your Windows NT 4.0 or Windows 2000 system:
  - Click on Start, and select Settings and then Control Panel.
  - Double-click on the Network icon.
  - Click on the Protocols tab, and select Add.
  - Double-click on TCP/IP protocol.
  - Insert the requested system disk to copy the required files.
  - Click on the Services tab, and double-click on Microsoft TCP/IP Printing.
2. Click on the TCP/IP protocol, and add the host's IP address, subnet mask, and gateway address.

NOTE: If you are not directly connected to the Internet, assign any arbitrary Class C address. Use the following example: aaa.bbb.ccc.ddd where aaa is any number from 192 to 222, bbb and ccc are any number from 0 to 255, and ddd is any number from 0 to 254. You may also use a subnet mask of 255.255.255.0 with no gateway address.

3. If the printer (NIC) does not have a valid IP address, assign an IP address to the printer using the printer's front control panel; or use remote configuration methods. Refer to "Using Configuration Utilities" for more information.

## Installing the Printing Software for Windows NT Systems

### Installing the Export Module for Raster Printing (8660/8670 Printers)

The export module must also be installed on each workstation that will be exporting files from Adobe PhotoShop to a Kodak raster printer. Run the setup utility provided with the export module.

### Installing the Printing Software for PostScript Printing (8670 Printer)

Users must install and use the AdobePS driver on all workstations that are directly sending PostScript files to the printer or through a server queue.

To Install the printing software:

1. Run the AdobePS setup utility that is provided with the printing software for your NT workstation.



- When prompted for the type of connection, select Local Printer.

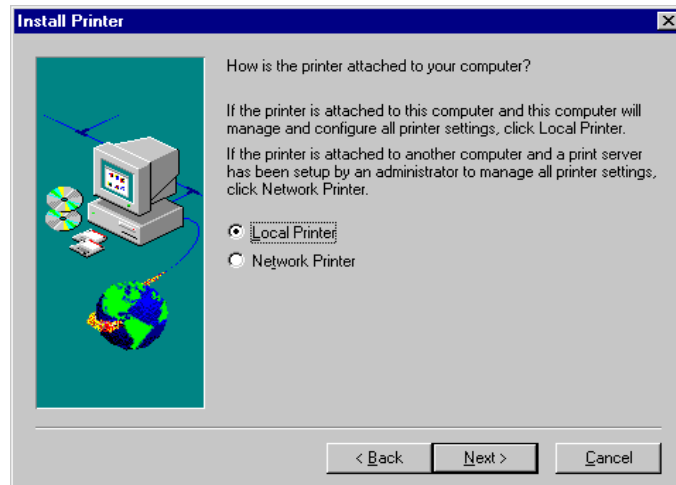

NOTE: Select Network only if a print server queue has already been established and can be selected by browsing the network.

- When prompted for an appropriate PPD, navigate to the drive and directory that contains the software for Windows NT.

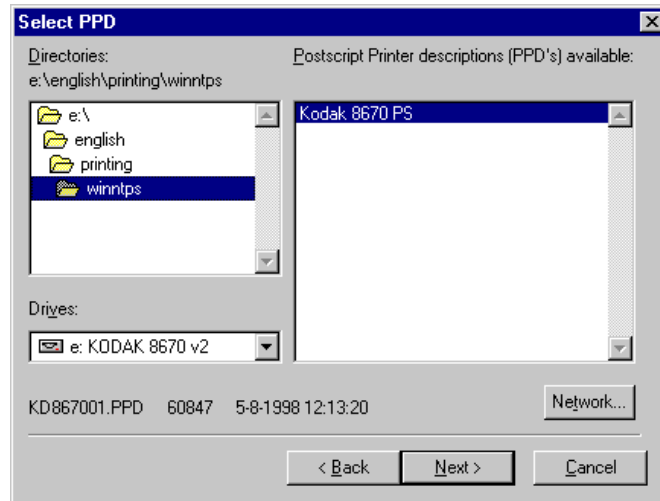

4. When prompted for a printer port, choose LPT1.

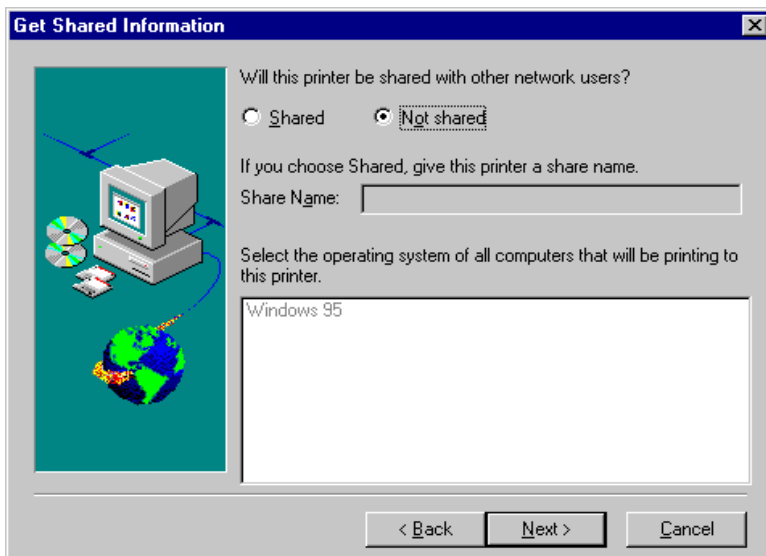

5. Select:

- Not Shared if you will be printing from this NT workstation.
- Select Shared if you are establishing an NT print queue for others to print through. Enter in an appropriate name for the print queue.

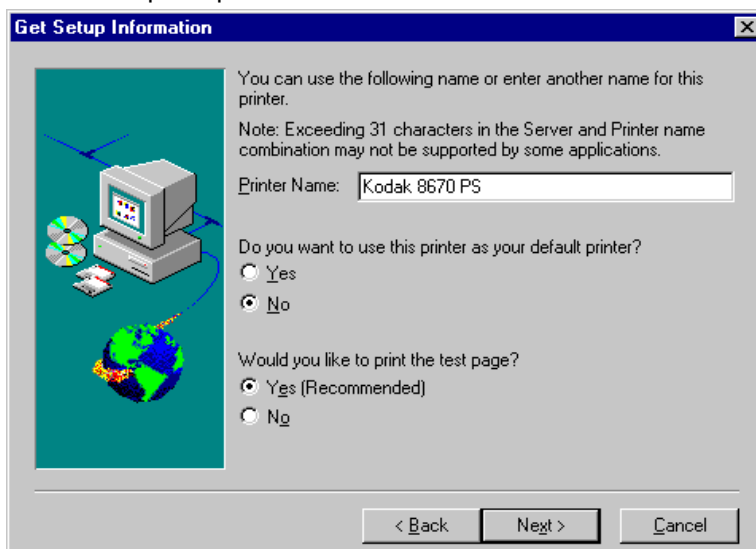



6. Enter the name of this printer. This is the name that will appear in the Printers window after you install the printing software.
7. Select the appropriate properties when a Printer Properties window appears.

NOTE: This is only necessary if you will be printing from this workstation.

The AdobePS Kodak 8670 PS driver should appear in the list of available drivers in any Printer Properties window. Selected it as the driver to use after an LPR printer is established.

### Configuring an LPR Printer on NT Systems

The following steps describe how to add an LPR port and corresponding printer IP address on an NT workstation/server.

1. Select Settings from the Start menu and then select Printer.
2. Double-click on the Add Printer icon. Click on Next.
3. Select My Computer, and click on Next.

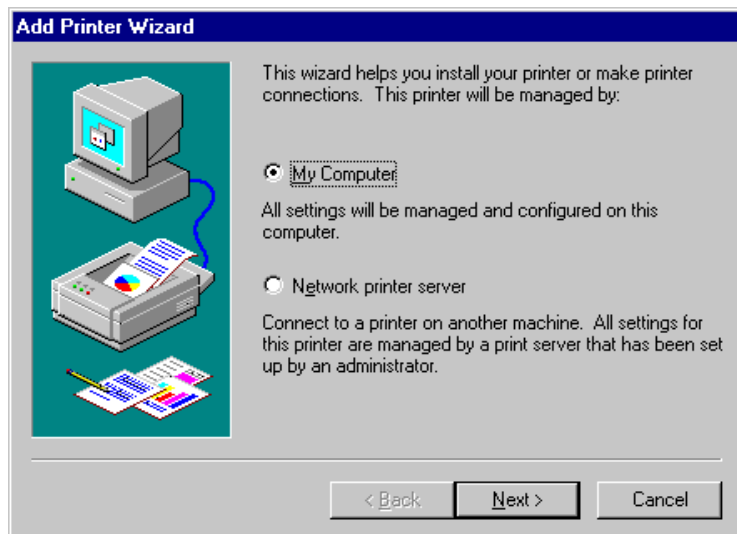

4. Select Add Port and then LPR Port from the list of available ports. Click on New Port.

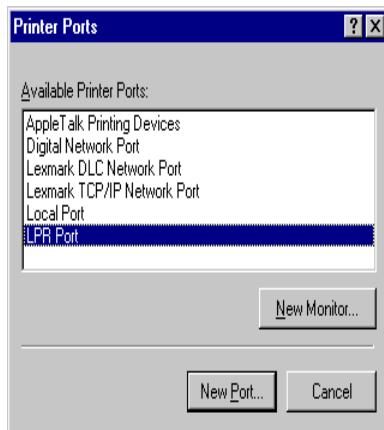

5. Enter the IP address you wish to assign to the NIC in the Name or address of server providing lpd box. Enter anything you wish in the Name of printer or print queue on that server box.



NOTE: If you do not have a router on the network, the IP address must match the first three octets of the IP address of your computer.

6. Click on OK, and then click on Close.

The new print server IP address should be listed and highlighted as an available port.

7. Click on Next.

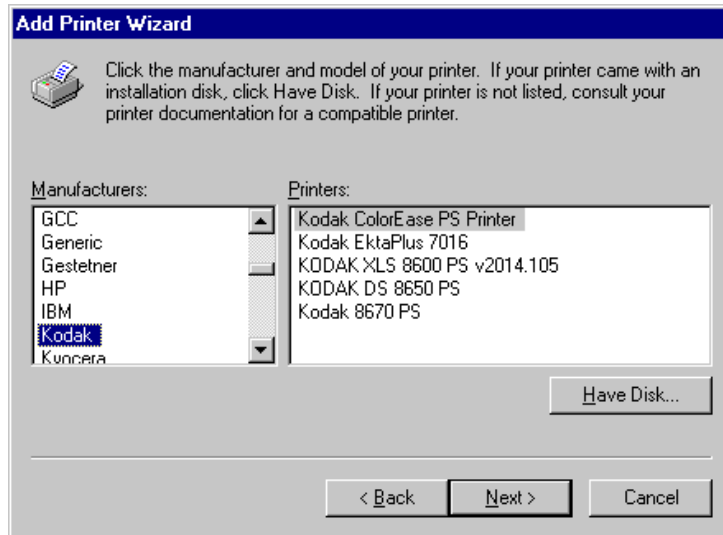

8. Select a printer driver, and click on Next.

NOTE: You can select any driver because it will be replaced with the AdobePS driver after the LPR printer is established.

9. Select Keep Existing Driver.
10. Change the name of the printer, if desired, and/or set it as the default printer. Click on Next.

11. If desired, make the printer shared; and enter a queue name. Click on Next.

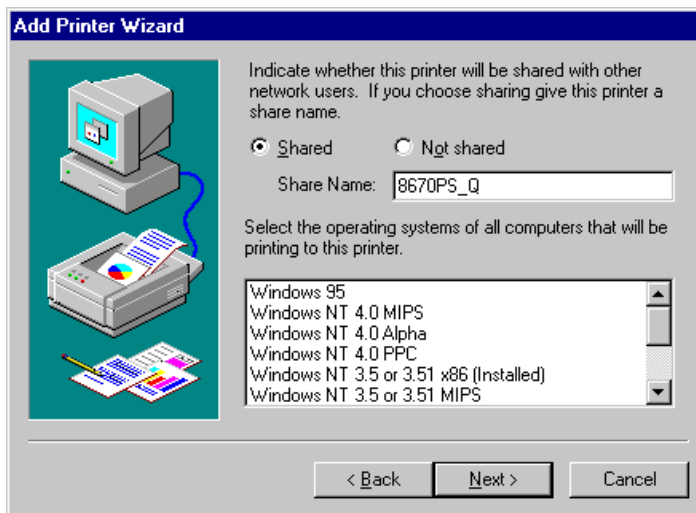

NOTE: If users will be exporting images from Adobe PhotoShop, the printer must be shared since the export module only allows selection of a network print queue.

12. Select Yes to print a test page, and click on Finish.

If a print queue has been established, the following remaining steps are NOT necessary since properties and document defaults will be set up on each workstation printing through the queue.

If the printer is NOT shared, the resulting LPR printer's properties and document defaults must now be selected to select the AdobePS driver and printer media settings.

13. Select Settings from the Start menu and then select Printer.
14. Select the new LPR printer and use the pulldown menu to select the printer's properties.
15. Select the AdobePS driver from the list of available drivers.

16. Select the new LPR printer.

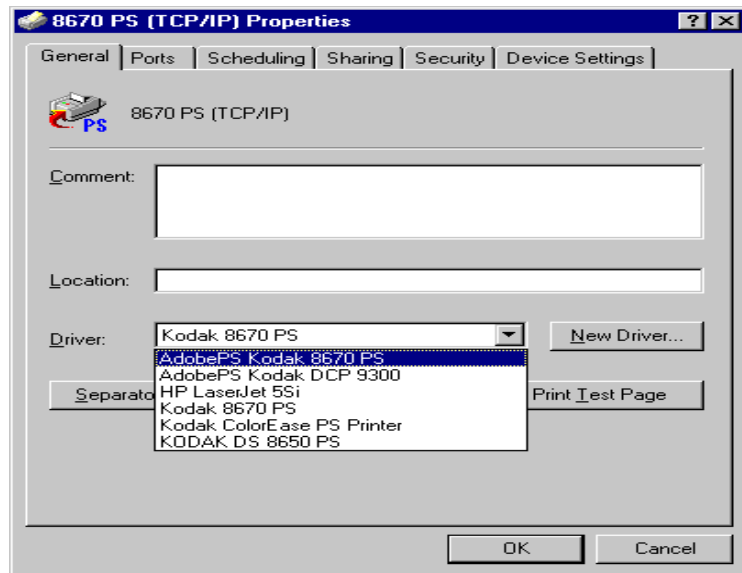

17. Use the pulldown menu to select the printer's document defaults.

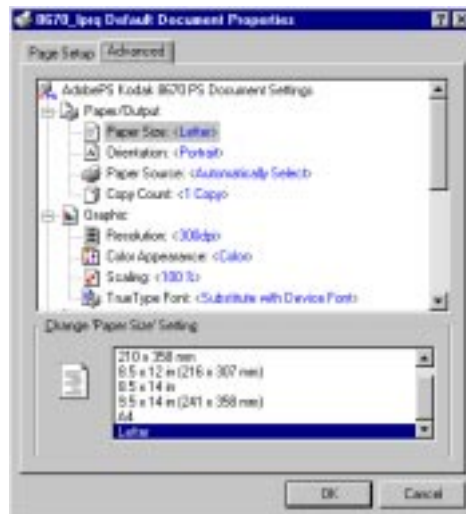

NOTE: Make selections consistent with the media for your printer.

## Configuring Unix Systems for TCP/IP Printing

Refer to notes on Unix support at the beginning of this chapter regarding support for Unix platforms.

Assign an IP address to the printer (NIC) using the printer's front control panel or by using utilities described in the "Using Configuration Utilities."

The configuration procedure for Unix TCP/IP printing includes the following steps on a Unix workstation:

- Adding the 8670 printer to the host table.
- Assigning a print queue.
- Setting up the remote printer.
- Creating a spool directory.

### Adding the Kodak Printer to the Host Table

Use an editor to add an entry to the hosts file containing the IP address and node name of the NIC. An example of an IP address and node are:

```
1982.189.207.3      KOD_00C351
```

NOTE: Some systems such as HP/UX and AIX allow you to enter the IP address as the host name when setting up the print queue. In this case you do not need to configure the `/etc/hosts` file.

### Assigning a Print Queue

Choose the NIC service you wish to use.

### Setting Up the Remote Printer

Modify the `/etc/printcap` file to set up the remote printer for most Unix systems. If you have an RS/6000 AIX, HP/US, Sun Solaris 2.xx, and other systems that do not use the `printcap` file, skip to the appropriate section for the Unix system you have to configure the Unix workstations for TCP/IP.

### **Modifying the /etc/printcap File to Set Up the Remote Printer**

Configure the /etc/printcap file on each workstation to specify the local print queue, the NIC name (also called remote machine or rm), and the print server service name (also called remote printer, remote queue, or rp), and the spool directory.

The following is an example of a typical printcap file:

```
Kodak1IPrinter on Floor 1:\
```

```
:IP=:\
```

```
:rm=KOD_003C51:\
```

```
:rp=BINARY_P1:\
```

```
:sd=/usr/spool/lpd/Kodak1:
```

This creates a queue named Kodak1 on the host computer that communicates to the NIC with a node name (rm) of KOD\_003C51 and a service name (rp) of BINARY\_P1 for printing files through the spool directory /usr/spool/lpd/Kodak1.

### **Setting Up the Remote Printer for HP/UX Systems**

For HP/UX systems, use the same program to set up the remote printer.

1. Enter sam, and select Peripheral Devices and then Add Remote Printer.
2. Enter the following remote printer settings:
  - Line printer name (user selectable).
  - Remote system name. The name of the NIC must match the name in the hosts file NIC or use the NIC IP address.
  - Remote printer queue (NIC binary or text service name).
  - Remote Printer is on a BSD System (Yes).

### **Setting Up the Remote Printer for IBM RS/6000 AIX Systems**

The RS/6000 AIX operating system uses the smit program to set up the remote printer.

1. Enter smit, and select devices.
2. Select printer/plotter.

3. Select manage remote printer subsystem:.
4. Select client services.
5. Select remote printer queues.
6. Select add a remote queue.
7. Enter the following remote queue settings:
  - Name of queue to add (user selectable)
  - Activate the queue (Yes)
  - Destination host (NIC name which must match name in /etc/hosts file or use the NIC IP address)
  - Name of queue on remote printer (Pony Print Server Binary or text service name)
  - Name of device to add (user selectable; for example, lp0)

### **Setting Up the Remote Printer for IBM RS/6000 AIX Systems**

Sun Solaris 2.x uses the `lpsystem` and `lpadmin` programs for remote printer configuration:

```
lpsystem -t bsd queue
```

```
lpadmin -p queue -sPPSname!PPService
```

```
accept queue
```

```
enable queue
```

Queue is the name of the local print queue, PPSname is the name of the NIC (must match the entry in the `/etc/hosts` file), and PPS service is the NIC binary service. If this is the first printer you are configuring, you must also use the `lpsched` command immediately prior to the `accept` command.

You may use the Printer Manager in the `admintool` utility under Open Windows. Select Edit, Add, and Add Access to Remote Printer. Enter the NIC name in the format `Sname!PPService` as described above. Make sure that the Printer Server OS is set to BSD, the default setting, and click on Add.



### Setting Up the Remote Printer for SCO Unix Configurations

SCO Unix requires TCP/IP V1.2 or later to work with the NIC. Configure the files `/etc/hosts` and `/etc/printcap` as described in the Adding the 8670 Printer to the Host Table and the Modifying the `/etc/printcap` File to Set Up the Remote Printer sections. Run the `sysadmsh` program as follows:

1. Select Printers.
2. Select Configure.
3. Select Add.
4. Enter the name of the print queue you entered in the `/etc/printcap` file as the printer name.
5. Enter anything as the comment and class name.
6. Select Existing for use printer interface.
7. Press F3 to get a list of available interfaces, and select the desired one as the name of interface using the arrow keys and Enter keys.
8. Select Direct as the connection
9. Enter the desired device name. (`/dev/lp` generally works.)
10. Select Hardwired as the device.
11. Select No for the Require banner field.

### Other Systems

Other systems use similar programs to set up the NIC. These programs require the following information:

Requested Information	Use:
remote printer	NIC binary service name
remote host computer name	Any name (must match name in <code>printcap</code> file if any) or in some cases, you may enter the print server IP address
remote host IP address	NIC IP address

## **Creating a Spool Directory**

If you have not already created a spool directory, you need to do so now. If you are using HP/UX, AIX, Solaris 2.xx, and some other systems, a spool directory has already been created. The lpd spool directory is located in the /usr/spool directory. Check with your system manager to see if the location is different for your system.

Use the mkdir command to create a spool directory. For example, to create a spool directory for the queue kodak1, you would enter:

```
mkdir /usr/spool/lpd/kodak1
```

NOTE: It is also necessary to start the daemon on some systems.

Use the lpc start command on the Berkeley-compatible Unix systems. For example:

```
lpc start kodak1
```

Adding an IP Address

## **8 Configuring for AppleTalk Networks**

The Kodak Professional 10/100 network interface card (NIC) supports the AppleTalk protocol allowing Macintosh computers to print jobs to a Kodak printer simultaneously with jobs from computers using TCP/IP, Novell NetWare, and NetBEUI.

The NIC broadcasts AppleTalk information to computers on the network and automatically appears in the Chooser on workstations.

The NIC is compatible with Apple LaserWriter 8 printer drivers as well as the AdobePS and PhotoShop export module for Macintosh that came with the printer.

### **Printer and NIC Installation**

Before you begin the configuration for AppleTalk, make sure you have completed the following steps:

1. Set up the printer, and install the printing software on the workstations that will be sending jobs to the printer. Refer to the QuickSetup card or the Operator's Guide which is included on the CD for instructions on setting up the printer.
2. Install the NIC in the printer, and connect it to your Ethernet network.
3. Generate a NIC configuration page, and verify that the AppleTalk service on the NIC is enabled. Refer to Chapter 2 for instructions on installing and verifying the NIC configuration.

**NOTE:** The NIC will automatically disable AppleTalk if the printer is powered up when it is NOT connected to a functional network. You should be able to re-enable AppleTalk by power cycling the printer when it is connected to an AppleTalk network.

4. Enable Ethernet from the Macintosh's control panel.

## Finding the Printer's Name in the Chooser

From the Chooser:

1. Select the AdobePS icon.
2. Select the correct zone from the list of AppleTalk zones.
3. Select the name of the printer from the list of printers.

NOTE: The default name for the printer (NIC) is KOD\_XXXXXX\_P1\_AT. The XXXXX represents the last six digits of the NIC Ethernet address.

## Changing the Printer's Name

1. Select the printer in the Chooser.
2. Double-click on the LaserWriter Utility.

NOTE: If LaserWriter utilities are not already installed on your Macintosh, they are available from Apple's Web site ([www.apple.com](http://www.apple.com)).

3. Select Name Printer from the Utilities menu.  
The currently-selected printer is listed in the dialog box.
4. Enter a new name for the printer, and click on Rename.
5. Click on OK in the confirmation box.

The new name for the printer should now appear in the list of printers in the Chooser.

## Changing the Printer's Zone

The printer (NIC) will automatically detect the EtherTalk zone it resides in and show up (in Chooser) in that zone. It should not be necessary to define a zone for the NIC unless the particular subnet that it resides on has multiple logical zones assigned to it.

If your LaserWriter utility supports zone naming, then use it in the same manner as for Changing the Printer Name. Otherwise, refer to "Using the Configuration Utilities" for alternate methods.

## Windows NT Systems vs AppleTalk

Kodak supports printing using AppleTalk ONLY from Macintosh systems. Kodak does not recommend or support the use of AppleTalk printing from Windows NT systems.

### Cautions and Limitations using NT AppleTalk

- Unreliable and inconsistent results have been encountered in mixed Macintosh/Windows environments when NT servers are used to secure and/or limit access to AppleTalk resources. There is otherwise, no benefit for configuring the printer on an NT server as an AppleTalk printer since the Kodak printer supports other Windows compatible protocols such as TCP/IP, NetBEUI, and Novell (IPX).
- Using an NT server to configure and capture an AppleTalk printer may subsequently prevent the printer from showing up on Macintosh systems.
- Kodak printers that are raster only will not show up on an AppleTalk network as LaserWriter printers. Therefore, they cannot be set up as NT AppleTalk printers.



## 9 Troubleshooting

This chapter describes procedures for troubleshooting problems you may encounter with the Kodak Professional 10/100 network interface card (NIC).

### NIC Start-up Sequence

#### NIC LEDs

The NIC should go through the following start-up sequence upon power up:

1. The NIC will run through a set of power-up diagnostics for a few seconds. If the NIC is operating properly, the red TEST LED will blink momentarily and then go out. If the TEST LED blinks continuously, there is a problem. If this is the case, first verify that you have a good Ethernet connection and then try powering the unit off and then on again.

#### NIC Factory Defaults

2. If this does not work, try pressing the push button switch on the NIC for at least 5 seconds (factory defaults) and powering the NIC off and then on again. If the problem persists, the NIC may be defective.

It will then try for a few seconds to obtain TCP/IP configuration information via BOOTP and RARP.

3. The print server will then check that the code in the Flash-ROMs is valid. If so, it will load that code and begin normal execution.

Once the Flash code has been loaded and the unit is running normally, the yellow 100baseT LED will come on solid if a 100baseT connection is detected and the green LINK OK LED lights when a valid link is established. If the lights do not come on as described, there may be a cabling problem or a bad hub port. If necessary, try a different cable and/or hub port.

#### NIC Configuration Page

4. Generate a NIC configuration page as described in Chapter 2 to verify that the connection between the printer and the NIC is good. If the test fails, turn the printer off and reinstall the NIC making sure that it is securely seated.

### Protocol Checks

- If you have a TCP/IP capable system, ping the NIC from the host operating system prompt with the ping ipaddress command. If a successful response is received, go to the TCP/IP troubleshooting section.
  - If you have a Novell system, verify that the NIC can be seen on the network. Log in as the SUPERVISOR, go into PCONSOLE, select PRINT SERVER INFORMATION, and select the name of the NIC. If you can see Print Server Status and Control in the menu, the NIC is visible to the network. Proceed to the NetWare troubleshooting section.
  - If you are running AppleTalk and you have a PostScript printer, make sure that you can see the print server name under the LaserWriter icon in the Chooser. If it is visible, the connection is good. Go to the AppleTalk troubleshooting section.
5. If you cannot make any of the protocol connections, check the following:

### Networking Component Checks

- Make sure the printer is powered on and is on line.
- Verify that the cabling and network connections are good. If possible, try the print server on a different connection on the network. Do a printer self-test to see if bytes are being transmitted and received.
- If you using a repeater or hub, make sure that SQE is turned off at the hub. If you have a hub or multiport repeater, verify that the hub or repeater port is good by trying the print server on a different port.



- If you have a bridge or router located between the print server and the host computer, make sure that the device is set up to allow the print server to send and receive data from the host. For example, a bridge can be set up to only allow certain types of Ethernet addresses to pass through. Therefore, such a bridge must be configured to allow NIC addresses. Also, a router can be set up to pass only certain protocols, so make sure that the desired protocol can be passed through to the NIC.
- If the job exits the queue but does not print, make sure that you are not printing a text job to a PostScript printer. Make sure that the printer is not forced into PostScript mode.
- Make sure that you are not performing an illegal operation such as attempting to print a job on a paper size not supported by the printer.

## Intermittent Problems

If the NIC and printer start up but you intermittently have printing problems, do the following:

1. Disable NetWare with the command SET NETWARE DISABLED.
2. Make sure you have enough memory in your computer if you can print small jobs but large graphics jobs are distorted or incomplete.
3. Check the individual protocol troubleshooting sections in this chapter for additional causes of intermittent printing problems.

## TCP/IP Troubleshooting

If you are using TCP/IP and cannot print to the print server and you have checked the hardware and network as described in the previous steps, check the following:

1. The problem may be the result of mismatched or duplicate IP addresses. Verify that the IP address is correctly loaded into the print server via the self-test page or through the remote console and make sure that no other nodes on the network

have this address. Duplicate IP addresses are the greatest cause of TCP/IP printing problems. If the address is not correct, check if the loading procedure was properly executed.

2. If you used XCONFIG to enter the IP address, make sure that you exited the remote console properly using CTRL-D and that you turned the printer off and then on. It may take up to two minutes for the IP address to take effect.
3. If you used rarp, make sure that you started the rarp daemon using the rarpd, rarpd -a, or equivalent command. Verify that the /etc/ethers file contains the correct Ethernet address and that the print server name matches the name in the/etc/hosts file.
4. If you used bootp, make sure that bootp is enabled. The # should be removed from the bootp entry.  
  
/etc/inetd.conf. Verify that the /etc/bootptab file is correctly configured.
5. Verify that the host computer and the print server are either on the same subnet or that the router is properly configured to pass data between the two devices.
6. Make sure that the /etc/printcap file is entered correctly. In particular look for missing ":" and "\n" characters because a small error anywhere in the file can have major consequences. Also, check the /usr/spool directory to make sure that you have created a valid spool directory.
7. If you are using a Berkeley-based UNIX, make sure that the daemon is started on Berkeley based systems with the command lpc start printer where printer is the name of the local print queue.
8. If you are using an AT&T based Unix operating system, make sure the printer is enabled (enable printer where printer is the name of the local print queue.)
9. Make sure that the lpr/lpd remote line printer service is running on the host computer. Refer to your host computer documentation for information on how to do this.
10. If you cannot print more than one job at a time, increase the IP time out using the SET IP TIMEOUT command.

11. If PostScript jobs do not print or run together, set the service (remote printer) with EOT set to string number 3 (control-D). For example:

```
SET SERVICE HP_PRINTER EOT 3
```

12. If you cannot print long jobs (over 1 MB, add the line mx#0 to your /etc/printcap file entry.

NOTE: If you are using Sun Solaris V2.4 or earlier, there is a bug with long print jobs on the NIC.

## NetWare Troubleshooting

If you cannot print from NetWare and you have checked the hardware and network as described in the previous steps, verify that the NIC is attached to the server queue by going to PCONSOLE selecting PRINT QUEUE INFORMATION and then CURRENTLY ATTACHED SERVERS. If the NIC does not appear in the list of attached servers, check the following:

1. If you changed the log in password, change the password in both the NIC printer server using the SET NETWARE PASSWORD command and in the file server using the PCONSOLE Print Server Information Change Password command.
2. Make sure that you have enabled at least one NetWare file server using the SET NETWARE SERVER servername ENABLED command.
3. Check if you have exceeded your NetWare user limit.
4. Make sure that the print server name you used in PCONSOLE exactly matches the name that is configured in the NIC server and make sure it is defined as a Queue Server for the print queue.
5. If you are running both 802.3 and Ethernet II frames on different file servers on your network, the NIC print server may not make a connection to the desired file server. Force the frame type to the desired one using the SET NETWARE FRAME command from the Print server remote console.
6. If you are losing portions of your print job, set the TIMEOUT parameter in your CAPTURE statement to a higher value—at least 50 seconds for Windows.

## AppleTalk Troubleshooting

If you cannot print from a Macintosh computer with AppleTalk, check the following:

1. Make sure that you are running Phase 2 AppleTalk and that you have selected the correct network interface from the Network Control Panel on the Macintosh.
2. If you have a large network, make sure that you have the AdobePS, LaserWriter 8.xx, or equivalent driver since earlier versions may cause PostScript errors. Verify that you get the correct printer information when you select Printer Info from the Setup button in the Chooser.
3. Make sure that you have selected the correct Printer Description File from the Chooser.
4. Verify that you selected the correct AppleTalk zone. Because the NIC receives its zone information from router broadcasts, it may not be in the zone you expect and will not show up in the Choose. You may need to force the zone name with the SET APPLETALK ZONE command.
5. If you are running an old version of Macintosh OS, verify that the Laser Prep versions on all Macintosh computers that need to print to the NIC are the same.

## Windows NT Troubleshooting

If you are having trouble printing with Windows NT, check the following:

1. Make sure that you can ping the NIC using the DOS command PING *ipaddress* where *ipaddress* is the IP address of the NIC.
2. Make sure that TCP/IP is installed and running on the Windows NT system.

3. If you cannot print to the NIC from a client PC that is connected to a Windows NTAS file server, verify that you can print directly from DOS. If you can print from the file server but not from the client, the problem is probably with the NetBEUI communications rather than with the TCP/IP link to the NIC. Check your file server network setup to make sure that you can print from the client to other printers on the network.

## Windows Peer-to-Peer Troubleshooting

If you cannot print on a Windows Peer-to-Peer network, check the following:

### Peer to Peer using NetBEUI

If the print server does not show up in the Network Neighborhood on a Windows Peer-to-Peer network, remove the Windows network software for netBEUI from the Network Control panel and then reinstall it.

- Install the NetBEUI Protocol, the client for Microsoft Networks, and the network adapter card driver.

### Peer to Peer using IPX

If the print server does not show up under JetAdmin on a Windows Peer-to-Peer network, remove the Windows network software from the Network Control panel and then reinstalling it as follows:

- Install the IPX/SPX-Compatible Protocol, the client for Microsoft Networks, and the network adapter card driver.
- Restart the system, and add the HP JetAdmin service.

## Technical Assistance

If you have questions about the printer or the NIC, the retailer from whom you purchased the printer may be able to answer them. Kodak provides retailers with additional technical information.

### Kodak Customer Assistance Center

Contact the Kodak Customer Assistance Center if you:

- have questions about your warranty.
- want to know where to get service.
- have questions about the printing software.

In the US, call 1-800-235-6325 from 9:00 a.m. to 8:00 p.m. Eastern Standard Time on regular business days. Refer to the Operator's Guide for telephone numbers outside the United States.

## Appendix A NIC Services

### Overview

A service is a resource for the Kodak Professional network interface card (NIC) that must be selected by computers configured to print to a NIC. The NIC provides the following predefined services as defaults (xxxxxx is the last six digits of the NIC's Ethernet address):

Service	Port	Filter	BOT	EOT	OPT	Protocols
KOD_xxxxxx_P1	P1	0	1	1	BQ	NW, NB, IP
BINARY_P1	P1	0	1	1	BQ	IP
* TEXT_P1	P1	1	1	1	BQ	IP
POSTSCRIPT_P1	P1	0	1	1	BQ	IP
RASTER_P1	P1	0	1	1	BQ	IP
KOD_xxxxxx_P1_AT	P1	2	1	1	BQ	AT

Use the default services for the NIC used in typical Windows and Macintosh networked environments. However, it may be desirable to modify a service name to reflect something more meaningful to users when browsing a network for a Kodak printer.

- Service TEXT\_P1 is not applicable to Kodak PostScript/raster printers and should not be used.
- Port P1 is the representation of the NIC's interface port to the printer. Since there is only one interface, P1 is the only option.
- Filter 0 = No filter. The AppleTalk filter (#2) is the only pertinent filter that must be used to define an AppleTalk compatible service, KOD\_xxxxxx\_P1\_AT.
- BOT & EOT = 1 = "Null String". This means that there are no Beginning or End Of Transfer command strings associated with any of the default services.
- Options = Bidirectional and queueing are enabled for all services.

- Protocols = NetWare, NetBEUI, TCP/IP, and AppleTalk are the protocols that Kodak supports for this NIC. (Do not be alarmed with references to LAT & DLC protocols. You may wish to disable LAT and DLC protocols, but this is not necessary for proper NIC operation with other protocols.)

### Environment/Protocol

For Netware environments, the KOD\_XXXXXX\_P1 identifier should appear in Network Neighborhood as a resource.

For NetBEUI environments, the KOD\_XXXXXX\_P1 identifier should appear in Network Neighborhood under a default domain called WorkGroup as a resource. If a different domain name exists for your environment, the NetBEUI domain parameter must be modified to reflect it.

For TCP/IP environments, it is necessary to select any NIC service with IP enabled as the remote printer queue name (any service except Text\_P1 and KOD\_XXXXXX\_P1\_AT).

For AppleTalk environments, select an AppleTalk related service, for example, KOD\_XXXXXX\_P1\_AT.

### BOT/EOT Strings

The following begin of transfer and end of transfer strings are included here for reference only.

No. String	Definition
1 NULL	Null string
2 \1BE	PCL reset (<ESC>E)
3 \04	PostScript reset (CTRL-D)
4 \1B%-123435X	PJL UEL
5 @PJL	Enter PJL mode
6 Enter Language=	PJL language switch
7 PCL0A	PJL PCL command



<b>No. String</b>	<b>Definition</b>
8 PostScript\0A	PJL PostScript command
9 \FF\04\FF\05\FF\06\FF\07	Enter Language=PCL
10 \FF\04\FF\05\FF\06\FF\08	Enter Language=PostScript
11 \0C	Formfeed

### **Filters**

A filter is a program built into the NIC that performs a specific function. Four filters are available. The only filter pertinent to this NIC used in Kodak printers is the AppleTalk filter(#2).

<b>Filter No.</b>	<b>Description</b>
1	Substitutes one user-specified character string for another character string. By default it adds a carriage return character plus a line feed character every time a line feed character is encountered in the data stream. It is useful for printing Unix text files because these files do not have carriage returns at the end of lines.
2	Default AppleTalk filter (no binary support)
3	Converts a text file to PostScript for use with PostScript only printers. Requires V3.27 or later firmware.
4	Allows AppleTalk binary files to be printed on any printer that supports the HP Tagged Binary Communications Protocol



## Appendix B Command Summary

Command line input applies to the use of the following NIC configuration mechanisms:

- XConfig
- Telnet
- Terminal on NIC Serial Port

When connecting to the NIC, you get a message such as Console Connected or Remote Console Reserved when you are connected. Press RETURN, type the password ACCESS when you get the # prompt, and type anything in response to the Enter Username prompt. Enter commands at the Local>prompt.

NOTE: The commands available are generally a subset of the commands used on terminal servers. There is no distinction between the SET and DEFINE commands or between the CLEAR and PURGE commands. When you type CTRL-D to exit the remote console, any of these commands take effect, and the results are stored permanently. It is not necessary to enter both a SET and a DEFINE to execute a command and save the results.

### General Server Commands

CLear SErVErSTRing *stringnumber*

Removes a string number. Refer to Appendix B for more information.

CLear FAtal

Deletes fatal error log

CLear POrt P1 JOB

clears current entry in the NIC's internal queue

EXIT/^D

Exits print server console

HElp

Provides information on available commands

INitalize

Resets the NIC

SET DEFAULT

Sets the NIC's parameters to factory defaults

SET LOAD Disable

Disables firmware reload after exit

SET LOAD ENable

Enables firmware reload after exit

SET LOAD HOst <name>

Sets node name of boot host for (NetWare firmware load)

SET LOAD IP aa.bb.cc.dd

Sets IP address of load host (TCP/IP firmware load)

SET LOAD SOftware <filename>

Sets host filename of firmware to load

SET PASSord <password>

Sets console password (default password is ACCESS)

SET PORT P1 BIDIR [ENIDIS]

Enable/disable bidirectional mode on print server

SET PROtect <password>

Set console protection password to prevent access to SET commands (use UNPROTECT command to access SET commands)

SET SERVEr DEscription

Sets node description string displayed with SHOW SERVER command

SET SERVEr STRing n "..."

Defines server BOT/EOT string. Refer to Appendix B.

SET SERVIce <servicename><protocol> [ENIDIS]

Enable or disables specified protocol on the specified service.

SET SERVIce <servicename> BOT nn

Set service BOT string to nn. Refer to Appendix B.

SET SERVICE <servicename>EOT nn  
Set service EOT string to nn. Refer to Appendix B.

SET SERVICE <servicename>Filter nn  
Set service filter to nn. See Appendix B.

SET SERVICE <servicename> FMS <matchnumber>  
Set service with specified match string number. See Appendix B.

SET SERVICE <servicename> FRS <replacenum>  
Set service with specified replacement string number. See Appendix B.

SET SERVICE <servicename> Filter nn  
Set service filter to nn. See Appendix B.

SET SERVICE IP <servicename>[ENIDIS]  
Enables or disables IP jobs.

SET SERVICE <servicename> NAmE <newname>  
Changes service name.

SET SERVICE <servicename> RECEive [ENIDIS]  
Set receive only mode on specified service.

SHoW FAtal  
Show fatal error log.

SHoW FRee  
Shows memory available.

SHoW LOAd  
Shows firmware update parameters.

SHoW POrt  
Shows port parameters.

SHoW POrt P1 STA  
Shows current port status

SHoW SERVEr

Shows server and LAT parameters

SHoW SERVEr COunters  
Shows server statistics

SHoW SERVice  
Shows service Parameters

SHoW TEStpage  
Prints test page

SHoW VErsion  
Shows server firmware version

UNPROtest  
Allows system manager to temporarily access SET commands when the remote console is in protected mode. Refer to SET PROTECTION command. The SET DEFAULT command can be used to permanently disable the protected mode.

ZERo  
Zeroes statistical counts.

### **TCP/IP Commands**

SET IP ACcess [ENIDIIALL] aa.bb.cc.dd {MAsk ee.ff.gg.hh}  
Allows or prevents specified IP address from accessing the NIC.

SET IP ADdress aa.bb.cc.dd  
Sets IP address of print server.

SET IP BOot n  
Number of BOOTP/RARP tries.

SET IP ENable/DISable  
Enables or Disables IP Processing

SET IP RARp nn

Sets procedure used by the NIC when obtaining its IP address. By default the IP address is set along with a default subnet mask and a router address that is the same as the address of the load host. By setting *nn* to 1, the subnet mask is not set. If *nn* is set to 2, the router address is not set. If *nn* is set to 3, neither the subnet mask nor the router address is set.

SET IP ROuter aa.bb.cc.dd  
Sets default router address.

SET IP SUBnet aa.bb.cc.dd  
Sets subnet mask.

SET IP Timeout n  
Sets inactivity timeout (min).

SET SERVICE <servicename> IP [ENDIS]  
Enables or disables TCP/IP jobs on specified service.

SET SERVICE <servicename> TCP *nn*  
Sets TCP port number (>1023) on service.

SHow IP  
Shows LPD/TCP/TELNET Parameters

SHow IP ACcess  
Shows IP addresses that are allowed to access print server.

## NetWare Commands

CLear NETware SErver *server*  
Removes specified NetWare file server from PontPrint server access list.

SET NETware ADvertise n  
Sets advertising frequency of the NIC.

SET NETware [ENIDIS]  
Enables or disables NetWare protocol of the NIC.

SET NETware FRame [802.2, 802.3, ETH, AL, AU, SNA].

Sets NetWare frame type to 802.2, 802.3, Ethernet II, ALL, AUTO, or SNAP

SET NETware NETwork n  
Sets NetWare internal network number.

SET NETware NPrinter <pserver> n ON <service>  
Set NPrinter mode on service.

SET NETware PAssword <psw>  
Sets the NIC log in password.

SET NETware POLLing n  
Sets the queue polling time in seconds.  
SET NETware QServer <fileserver> ON <service>  
Sets Queue Server mode on service

SET METware REscan  
Rescans the NIC for new queues

SET NETware SErver <name> [ENIDIS]  
Enables the NIC.

SET SERVIce <servicename> NET [ENIDIS]  
Enables or disables NetWare jobs on specified service.

Shows NETware  
Shows NetWare parameters

### **AppleTalk Commands**

SET Appletalk [ENIDIS]  
Enables or disables AppleTalk Processing.

SET APpletalk ZOne <name>  
Set AppleTalk zone name

SET Appletalk [ENIDIS]  
Enables or disables AppleTalk Processing.

SET SERVIce <servicename> APP [ENIDIS]  
Enables or disables AppleTalk jobs on specified service.



SET SERVICE <servicename> RECEIVE [ENIDIS]

Enables or disables AppleTalk spooling to allow printers that do not support bidirectional communications to be connected to the print server.

SHOW APpletalk

Shows AppleTalk parameters.



# Index

## Numerics

---

- 8660 printer
  - Installing NIC in 2-2-2-4
- 8660/8670 printers
  - Installing the export module for raster printing 7-4
- 8670 printer
  - Installing NIC in 2-4-2-6
  - Installing the printing software 7-4-7-7

## A

---

- About this guide, 1-1
- AdobePS
  - Drivers and export modules 4-1
  - Setup utility for Windows NT 5-6-5-8
  - Verifying the driver 5-8
- AIX systems 7-13-7-14
- Apple LaserWriter utilities 3-1
- AppleTalk
  - Cautions and limitations 8-3
  - Commands B-6-B-7
  - Finding the 8670 printer in the Chooser, 8-2
  - Troubleshooting 9-6
  - Vs Windows NT 8-3
- AppleTalk networks 8-1-8-3
  - Configuring for 8-1-8-3
  - Printer and NIC installation 8-1
- ARP
  - Using on Unix systems 3-18
  - Using to enable IP address 3-18

## B

---

- BOOTP
  - Using to configure the IP address 3-19
- BOT/EOT strings A-2-A-3

## C

---

- Cable, 100BaseT
  - Required for installation, 2-2
- Cable, 10BaseT
  - Required for installation, 2-2
- Commands B-1–B-7
  - AppleTalk B-6–B-7
  - General server B-1–B-4
  - NetWare B-5–B-6
  - TCP/IP B-4–B-5
- Components, Gathering networking 1-4
- Configuration
  - Screens 3-4–3-7
  - Software 1-3
  - Summary 7-2
  - Utilities 1-5, 3-1
- Configuring
  - For Appletalk networks 8-1–8-3
  - For TCP/IP 7-1–7-16
  - LPR printer on NT systems 7-7–7-11
  - NIC 1-3, 1-4, 2-8
    - From the printer's display panel 3-16–3-17
    - Using Web browser 3-2
  - Print servers 1-5
  - Printer on workstations 1-5
  - Servers and workstations for printing 4-1–4-2
  - TCP/IP (LPR) printers on NT systems 7-3
  - Unix systems for TCP/IP printing 7-12–7-16
- Connecting
  - NIC serial configuration port to a console terminal 3-15–3-16
- Contents of package 2-1
- Customer assistance 9-7

## D

---

- Defaults 9-1

## E

---

- Environment A-2
  - Assessing 1-3
- Ethernet
  - Installing cable 2-7
  - Printer port, 2-7
- Export module for raster printing
  - Installing 7-4

## F

---

- FCC rules 1-2
- Filters A-3

## G

---

- General server commands B-1–B-4
- Getting help
  - From your dealer, 9-7

## H

---

- Hardware
  - Gathering 1-4
  - Installing 2-1–2-8
  - Installing NIC 1-4
- Host table
  - Adding the Kodak printer to 7-12
- HP/UX systems 7-13

## I

---

- IBM RS/6000 AIX systems 7-14
- Installation requirements 2-1
- Installing
  - Ethernet cable 2-7
  - Export module for raster printing 7-4
  - Hardware 2-1–2-8

- NIC hardware 1-3, 1-4
- NIC in an 8660 printer 2-2-2-4
- NIC in an 8670 printer 2-4-2-6
- Printing software
  - For PostScript printing 7-4-7-7
  - For Windows NT systems 7-4-7-7
- Intermittent problems with the network interface card, 9-3
- IP address 3-18-3-21
  - Configuring using BOOTP 3-19
  - Configuring using rarp 3-19
  - Enabling using ARP 3-18
- IPX
  - With Peer to Peer 9-7

## **J**

---

- JetAdmin
  - Configuring a Novell server with 6-3
  - Using to configure for NDS 6-4

## **K**

---

- Kodak
  - Adding a printer to the host table 7-12
  - Customer Assistance Center, 9-7
  - PostScript printer
    - Windows 95/98 5-2-5-4
  - Web site 1-2
- Kodak PostScript printer
  - Windows NT 5-4-5-5

## **L**

---

- LPR printers
  - Configuring on NT systems 7-3-7-11

## **M**

---

- Macintosh 4-2
  - TCP/IP 7-1

Microsoft  
Peer to Peer print services 5-1–5-10  
Modifying 7-13

## **N**

---

### Names

Service 3-3

NetBEUI 5-1–5-10

With Peer to Peer 9-7

### NetWare

Commands B-5–B-6

Troubleshooting 9-5

### Network

Assessing 1-3

Operating system compatibility 1-2

Printer parameters 8-1–8-3

### Network Interface Card 1-1

Autosensing feature 2-7

Installing in the 8670 printer, 2-2

installing in the 8670 printer, 2-4

Installing, 2-4, 2-6

installing, 2-6

Package contents, 2-1

Requirements for installing, 2-2

Test button 2-8

### Networking

Component checks 9-2

Software for TCP/IP 7-2

### Networks 8-1

### NIC

#### Configuration

Page 9-1

Utilities 1-5

#### Configuring 2-8

From the printer's display panel 3-16–3-17

Connecting the serial configuration port to a console terminal 3-15–3-16

Factory defaults 9-1

#### Installing

And configuring 1-3

- In an 8660 printer 2-2-2-4
  - In an 8670 printer 2-4-2-6
- LEDs 9-1
- Protocol checks 9-2
- Serial port 3-1
- Services A-1-A-3
- Startup sequence 9-1-9-2
- Novell
  - NetWare servers 7-2
  - Servers 4-1
- Novell NetWare
  - Operating modes 6-2
- NWAdmin
  - Using to configure for NDS 6-4

## **P**

---

- Package contents 2-1
- PCONSOLE
  - Using to configure for NDS 6-5
  - Using to configure for Queue Server 6-7
- Peer to Peer
  - Services 5-1-??
    - Using IPX 9-7
    - Workstation networking software 5-1
  - Troubleshooting 9-7
  - Using IPX 9-7
  - Using NetBEUI 9-7
- Platform
  - Print drivers 1-5
  - Printing 1-4
- Precautions
  - Static electricity 2-1
- Print drivers platform 1-5
- Print queue, Assigning 7-12
- Print server, Configuring 1-5
- Printer
  - And NIC installation
    - On AppleTalk Networks 8-1
  - Configuring NIC from the display panel 3-16-3-17
  - Configuring on workstations 1-5



- Front control panel 3-1
- Name
  - Changing 8-2
  - Finding in the Chooser 8-2
- Zone 8-2
- Printer's zone 8-2
- Printing 1-5
  - Environment, assessing 1-3
  - Software for PostScript printing
    - Installing 7-4–7-7
  - Test page 2-7
- Protocol A-2
  - Checks 9-2
- PSERVER mode 6-2

## **Q**

---

- Queue server mode 6-2

## **R**

---

- Rarp
  - Using to configure the IP address 3-19
- Remote printer
  - Modifying the /etc/printcap file 7-13
  - Setting up 7-12
  - Setting up for HP/UX systems 7-13
  - Setting up for IBM RS/6000 AIX systems 7-13–7-14
  - Setting up for SCO UNIX configurations 7-15
- Requirements 2-1

## **S**

---

- SCO UNIX configurations 7-15
- Serial configuration port
  - Connecting to a console terminal 3-15–3-16
- Servers 1-4
  - Configuring for printing 4-1–4-2
  - Unix 4-2
  - Windows NT 4.0 4-1

- Service names 3-3
- Software
  - NIC configuration 1-4
- Spool directory
  - Creating 7-16
- Static electricity
  - Precautions 2-1
- System requirements 2-1

## T

---

### TCP/IP

- Adding
  - 8670 printer to the host table, 7-12
  - IP address using BOOTP, 3-19
  - IP address using rarp utility, 3-19
  - IP address, 7-16
- Assigning a print queue, 7-12
- Commands B-4–B-5
- Configuration summary 7-2
- Configuring for 7-1–7-16
- Creating a spool directory, 7-16
- LPR printers
  - Configuring on NT systems 7-3
- Macintosh 7-1
- Networking software for 7-2
- Printing
  - Configuring Unix systems for 7-12–7-16
- Setting up remote printer
  - For HP/systems, 7-13
  - For SCO Unix configurations, 7-15
  - With /etc/printcap file, 7-13
- Setting up the remote printer 7-12
  - For IBM RS/6000 AIX systems, 7-13
- Troubleshooting 9-3–9-5
- Unix 7-1
- Windows 7-1

Technical assistance 9-7–9-8

Telnet 3-1

- Configuration utility 3-13–3-14

Test page

- Printing 2-7
- Troubleshooting 9-1–9-8
  - AppleTalk 9-6
  - NetWare 9-5
  - Problems with the NIC, 9-1
  - TCP/IP 9-3–9-5
  - Windows NT 9-6–9-7
  - Windows Peer to Peer 9-7

## **U**

---

- Unix
  - Servers and workstations 4-2
  - TCP/IP 7-1
- Unix systems
  - Assigning a print queue 7-12
- Unix systems
  - Adding the Kodak printer to the host table 7-12
  - Configuring for TCP/IP printing 7-12–7-16
- Using Windows 95 5-1

## **V**

---

- Verification of AdobePS driver 5-8

## **W**

---

- Web browser
  - Configuration tool 3-1
  - Configuring
    - NIC from 3-2
- Web site 1-2
- Windows 5-4
  - 95/98 4-2
    - For Work Groups (3.x) 4-2
    - NT 4.0 4-1
    - TCP/IP 7-1
- Windows 2000 servers and workstations 4-1
- Windows 95
  - Using 5-1

- Windows 95 Peer-to-Peer
  - Troubleshooting, 9-7
- Windows 95/98
  - Setting up a Kodak PostScript printer 5-2–5-4
  - Setup for exporting Kodak raster files 5-9–5-10
- Windows NT
  - Adding an IP address for, 7-3
  - AdobePS setup utility for 5-6–5-8
  - Configuring an LPR printer 7-7–7-11
  - Configuring TCP/IP (LPR) printers on 7-3
  - Installing the printing software 7-4–7-7
  - Setting up a Kodak PostScript printer 5-4–5-5
  - Setup for exporting Kodak raster files ??–5-10
  - Troubleshooting 9-6–9-7
  - Vs AppleTalk 8-3
  - Windows 2000 servers and workstations 4-1
- Windows Peer to Peer
  - Troubleshooting 9-7
- Workstation networking software
  - For Peer to Peer services 5-1
- Workstations
  - Configuring for printing 4-1–4-2
  - Configuring the printer 1-5
  - Unix 4-2
  - Windows NT 4.0 4-1

## X

---

- XAdmin
  - Configuration utility 3-1
  - Using to configure for NDS 6-4
  - Using to establish a Novell queue 6-3
  - Utility 3-8–3-10
- XConfig
  - Configuration utility 3-1
  - Using to configure for PCONSOLE 6-6
  - Using to configure for Queue Server 6-7
  - Using to establish a Novell queue 6-3
  - Utility 3-11–3-13

**Z**

---

Zone

Changing for printer 8-2





EASTMAN KODAK COMPANY  
Rochester, New York 14653

KODAK CANADA INC.  
Toronto, Ontario M6M 1V3  
Canada

Kodak and Kodak Professional are  
trademarks of Eastman Kodak Company.

PostScript is a trademark of Adobe  
Systems Incorporated or its subsidiaries.





## Free Manuals Download Website

<http://myh66.com>

<http://usermanuals.us>

<http://www.somanuals.com>

<http://www.4manuals.cc>

<http://www.manual-lib.com>

<http://www.404manual.com>

<http://www.luxmanual.com>

<http://aubethermostatmanual.com>

Golf course search by state

<http://golfingnear.com>

Email search by domain

<http://emailbydomain.com>

Auto manuals search

<http://auto.somanuals.com>

TV manuals search

<http://tv.somanuals.com>