



KPS 25s

Krell Playback System™

Instructions for Use



Owner's Reference

**KPS 25s
Krell Playback System™**

Krell® Industries, Inc.

45 Connair Road

Orange, CT 06477-3650 USA

TEL 203-799-9954

FAX 203-799-9796

E-MAIL krell@krellonline.com

www.krellonline.com

CONTENTS

	Page
INTRODUCTION	3
UNPACKING	3
PLACEMENT	4
AC Power Guidelines	4
INSTALLING THE ACRYLIC COVER	4
CONNECTING THE KPS 25s TO YOUR SYSTEM	8
Additional Connections	11
REMOTE CONTROL OPERATION	11
How to Write a Program	12
Battery Installation and Removal	14
MENU FUNCTIONS	15
WARRANTY	17
RETURN AUTHORIZATION PROCEDURE	18
SPECIFICATIONS	20

ILLUSTRATIONS

	Page
INSTALLING THE ACRYLIC COVER ONTO THE KPS 25s BACK PANEL	5-7
THE KPS 25s BACK PANEL	8
THE KPS 25s FRONT PANEL	9
THE KPS 25s TABLETOP REMOTE CONTROLLER	10
THE KPS 25s HANDHELD REMOTE CONTROLLER	11

CE Marking

This product complies with the EMC directive (89/336/EEC) and the low-voltage directive (73/23/EEC).

Introduction

Thank you for your purchase of the Krell KPS 25s Krell Playback System™. The KPS 25s is an integrated design incorporating a compact disc player, a preamplifier, and a digital-to-analog converter in one chassis.

To obtain the best performance from your KPS 25s, pay careful attention to its placement, installation, and operation. A thorough understanding of these details will help insure satisfactory operation and long life for the KPS 25s and related system components.

THERE ARE NO USER-SERVICEABLE PARTS INSIDE ANY KRELL® PRODUCT.

Please contact your authorized dealer, distributor, or Krell®, if you have any questions not addressed in this reference manual.

Unpacking

1. Open the shipping box and remove the top layer of foam. You will see these items:

- 1 KPS 25s chassis
- 1 Acrylic Cover in velvet pouch
- 1 KPS 25s Handheld Remote Controller
- 1 KPS 25s Tabletop Remote Controller
- 1 package of AAA batteries
- 1 Disc Clamp
- 1 AC power cord
- 1 12 Volt remote cable
- 1 T-10 Torx wrench
- 1 cleaning kit for the Acrylic Cover
- 1 packet containing an introductory letter from Dan D'Agostino, C.E.O., the Owner's Reference, and the Warranty Registration Card

NOTE: *If any of these items are not included in the box, please contact your authorized Krell® dealer or distributor for assistance.*

2. Carefully remove the unit and accessories from the box. Remove the protective plastic wrap from the unit.

NOTE: *Save all packing materials. If you ship your KPS 25s in the future, repack the unit in its original packaging to prevent transit damage.*

Placement

WARNINGS

The Krell Playback System™ must not be located where it could be exposed to dripping or splashing fluids.

Before you install the KPS 25s into your system, review the following guidelines to choose the location for the KPS 25s. This will facilitate a clean, trouble-free installation. The KPS 25s does not require a special rack or cabinet for installation. *For the dimensions of the KPS 25s see **Specifications** on page 20.*

1. Place the KPS 25s on a firm level surface, away from excessive heat, humidity or moisture.
2. The KPS 25s incorporates an advanced suspension system and does not require additional mass coupling or isolation. You may experiment with feet or cones as long as they are not permanently affixed to the chassis. Any unauthorized modifications to the electronics or chassis will void the warranty.

IMPORTANT: *Please do not attach enhancement accessories such as rings, mats, or dampers to individual CDs. These*

accessories may cause problems with the transport mechanism, resulting in erratic playback and/or poor sound.

AC Power Guidelines

WARNING

Do not remove or bypass the ground pin on the end of the AC cord. This may cause RFI (radio frequency interference) to be induced into your playback system.

The KPS 25s has superb regulation and does not require a dedicated AC circuit. Avoid connections through extension cords or multiple AC adapters. High quality 15 amp grounded AC strips are acceptable. High quality AC line conditioners or filters can be used if they are grounded and meet or exceed the unit's power supply rating of 100 VA.

Installing the Acrylic Cover

Install the Acrylic Cover onto the top of the KPS 25s, before connecting the KPS 25s to your system. Follow the easy steps outlined on pages 5, 6, and 7.

INSTALLING THE ACRYLIC COVER ONTO THE KPS 25s

NOTE: Attach the Acrylic Cover before connecting the flex-foil cable.

1. Carefully remove the Acrylic Cover from the velvet pouch and place it on a soft surface.

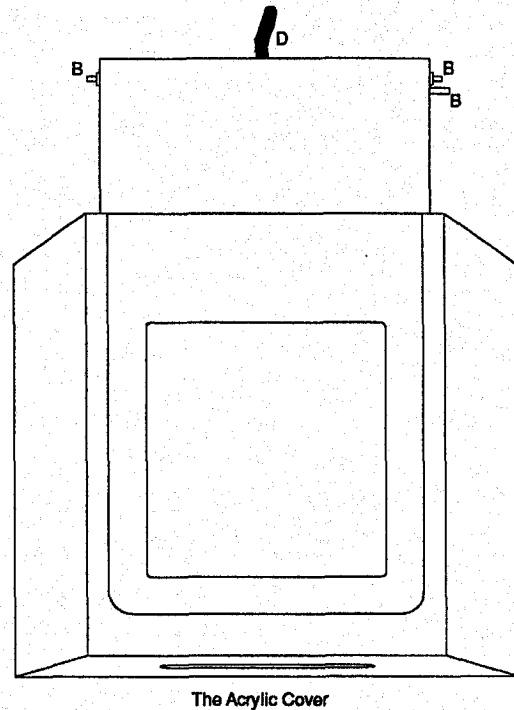

2. Pull the push-pull pins (A) until they are fully extended.

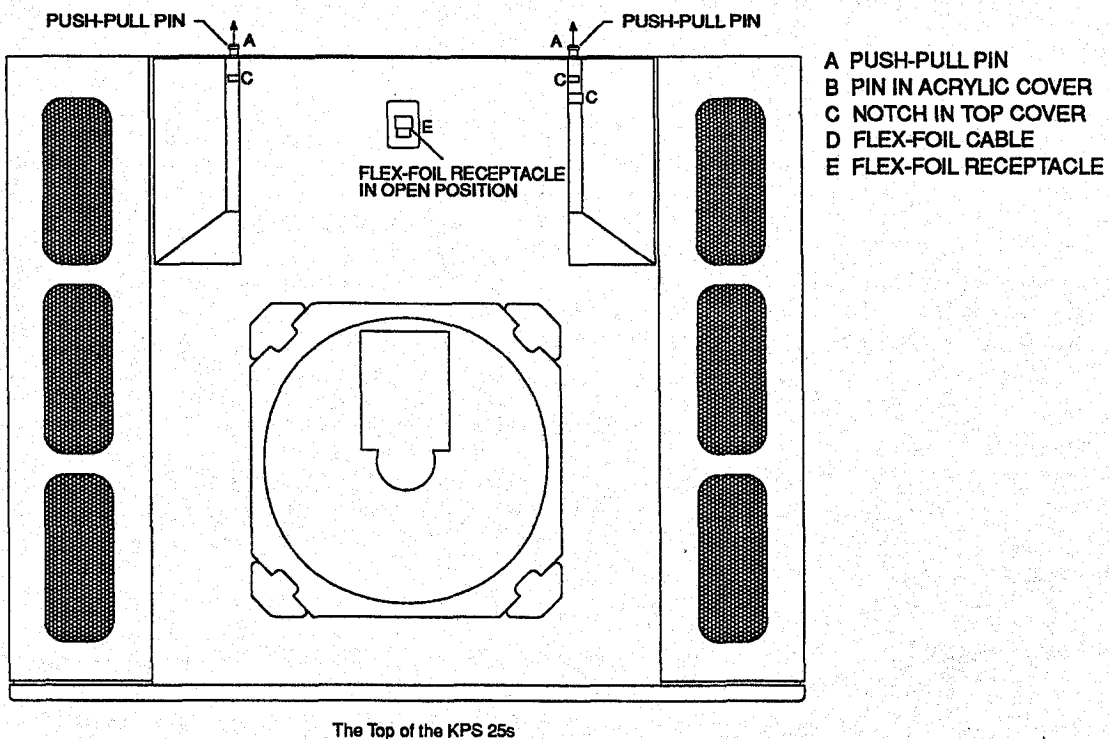

INSTALLING THE ACRYLIC COVER ONTO THE KPS 25s, continued

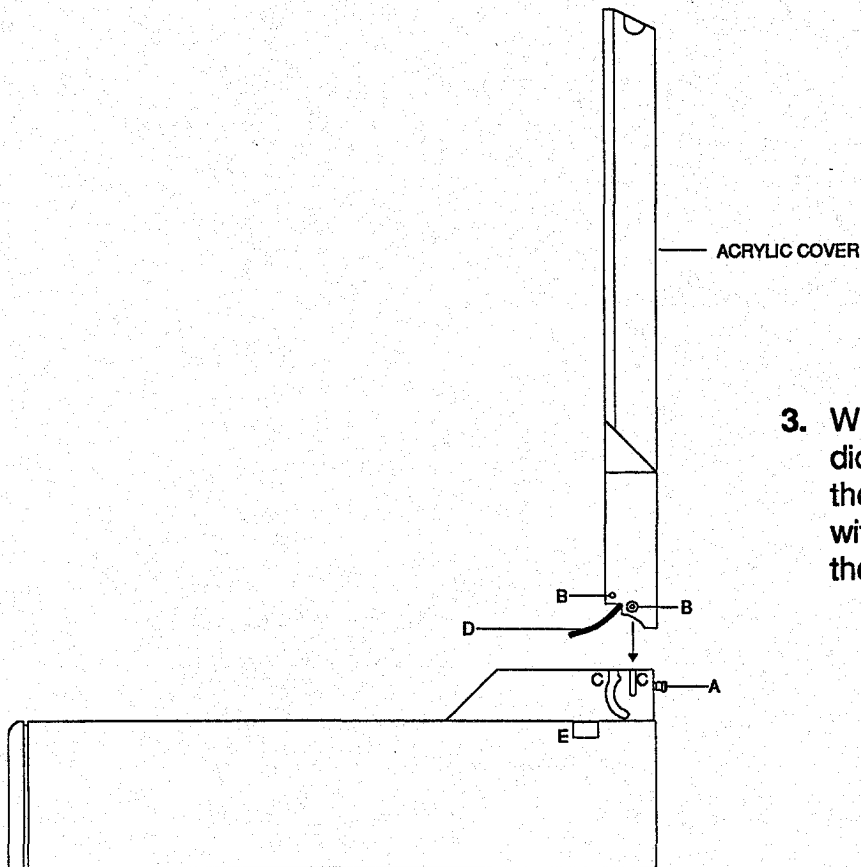

Acrylic Cover, Right View, Perpendicular to the KPS 25s

3. With the Acrylic Cover perpendicular to the KPS 25s, line up the pins in the Acrylic Cover (B) with the notches in the top of the KPS 25s (C).

4. Gently lower the Acrylic Cover into the notches.

- A PUSH-PULL PIN
- B PIN IN ACRYLIC COVER
- C NOTCH IN TOP COVER
- D FLEX-FOIL CABLE
- E FLEX-FOIL RECEPTACLE

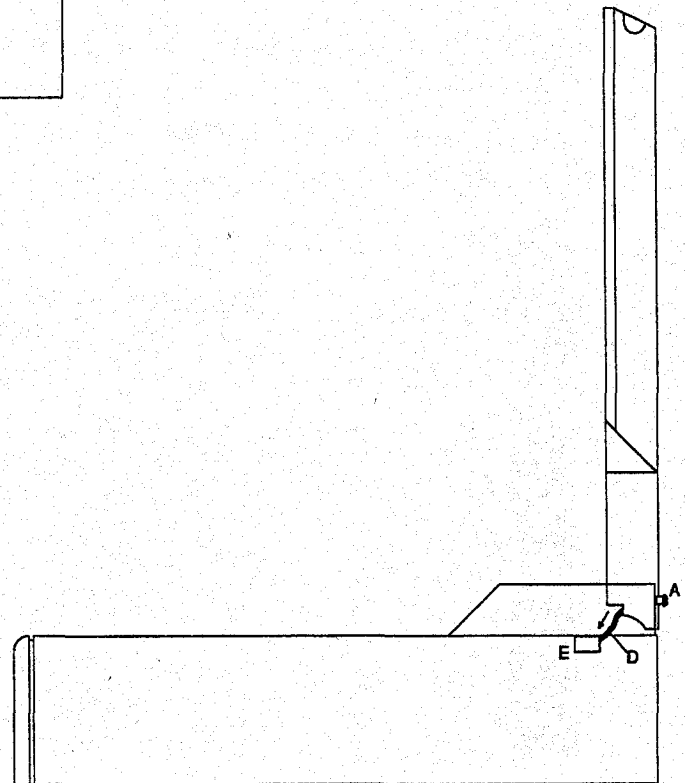

Acrylic Cover with Flex-Foil Cable in Flex-Foil Receptacle

INSTALLING THE ACRYLIC COVER ONTO THE KPS 25s, continued

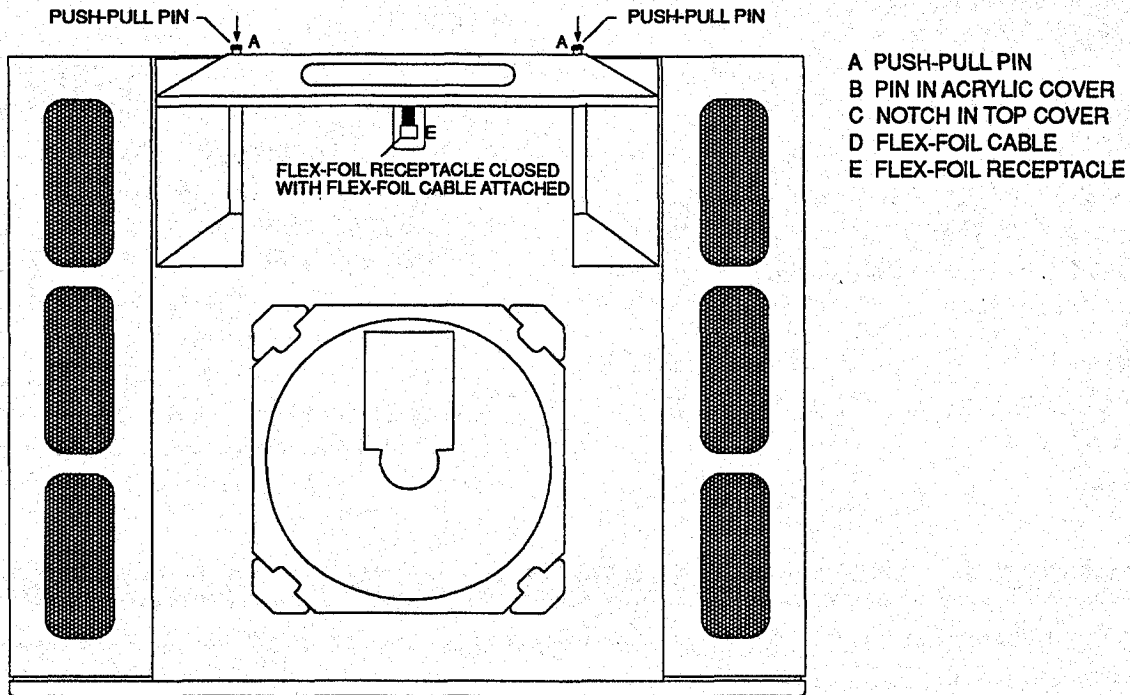

The Top of the KPS 25s with Acrylic Cover and Flex-Foil Cable in Place

5. Push the push-pull pins (A) into the closed position.
6. Make sure the flex-foil receptacle is in the open position. Feed the flex-foil cable (D) attached to the Acrylic Cover back toward the flex-foil receptacle (E) on the top of the KPS 25s. Carefully align the flex-foil cable so the tip of the flex-foil cable is parallel to the flex-foil receptacle.
7. Insert the flex-foil cable into the flex-foil receptacle (E). Close the flex-foil receptacle by sliding the flex-foil receptacle sleeve toward the transport. There will be an audible "click" when the flex-foil cable is locked in position.

Connecting the KPS 25s to Your System

WARNING

When making connections to this component or any other, make sure the power amplifier is Off. Make sure all cable terminations are of the highest quality, free from frayed ends, shorts, or cold solder joints.

1. Connect the outputs of associated source equipment to the inputs of the KPS 25s.
2. Connect the left and right outputs of the

KPS 25s to the appropriate associated equipment.

3. When connecting the KPS 25s to AC power, first connect the EIC Standard 15 amp AC power cord between the KPS 25s and the wall socket. Then switch the power on from the Rear Panel Power Switch. The word KRELL will momentarily appear in the Menu Display Window located on the right front panel of the KPS 25s. This indicates that the KPS 25s has initialized and is ready for operation. The unit is in Stand-by mode.

THE KPS 25s BACK PANEL

- | | | |
|---|--|---|
| 1 Left and right balanced inputs | 11 Variable level single-ended outputs | 17 SPDIF co-axial digital inputs (via RCA connectors) |
| 2 Inputs from tape deck | 12 Krell® CAST™ outputs (variable level outputs for use with other Krell® CAST™ equipped components) | 18 AES/EBU digital input (via an XLR connector) |
| 3 Outputs to tape deck | 13 EIAJ fiber optic digital outputs (via TosLink™ connectors) | 19 Main on/off power switch |
| 4 Single-ended input 1 | 14 SPDIF co-axial digital outputs (via RCA connectors) | 20 Fuse holder |
| 5 Single-ended input 2 | 15 AES/EBU digital output (via an XLR connector) | 21 IEC Standard 15 amp AC power cord receptacle |
| 6 Single-ended input 3 | 16 EIAJ fiber optic digital inputs (via TosLink™ connectors) | 22 Krell® RemoteLink™ communications output data port |
| 7 Acrylic Cover damper adjustment control | | 23 Krell® RemoteLink™ communications input data port |
| 8 Fixed level balanced outputs | | 24 RC-5 baseband input |
| 9 Variable level balanced outputs | | 25 12 Volt trigger output |
| 10 Fixed level single-ended outputs | | |

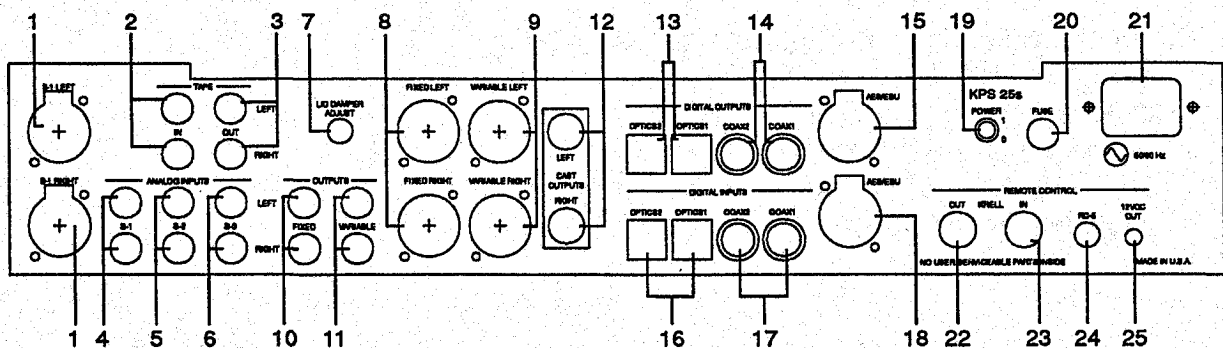

The KPS 25s is equipped with the following analog and digital inputs:

- 1 set of balanced analog inputs (via an XLR connector)
- 3 sets of single-ended analog inputs (via RCA connectors)
- 1 set of tape monitor analog inputs
- 2 EIAJ fiber optic digital inputs (via TosLink™ connectors)
- 2 SPDIF co-axial digital inputs (via RCA connectors)
- 1 AES/EBU digital input (via an XLR connector)

The KPS 25s is equipped with the following analog and digital outputs:

- 1 set of fixed balanced outputs (via an XLR connector)
- 1 set of variable balanced outputs (via an XLR connector)
- 1 set of fixed single-ended outputs (via an RCA connector)
- 1 set of variable single-ended outputs (via an RCA connector)
- 1 set of Krell® CAST™ outputs (via a 4-pin bayonet connector)
- 2 EIAJ fiber optic digital outputs (via TosLink™ connectors)

THE KPS 25s FRONT PANEL

- | | | |
|---|---|--|
| 1 Compact Disc Transport Display Window | 12 Main power button | 21 Balanced input selector button |
| 2 Transport Pause button | 13 Operating Indicator light | 22 Single-ended input selector button |
| 3 Transport Play button | 14 Compact disc player input selector button | 23 Single-ended input selector button |
| 4 Transport Stop button | 15 AES/EBU input selector button | 24 Tape deck input selector button |
| 5 Transport HDCD ¹ Indicator light | 16 EIAJ fiber optic digital input selector button | 25 Level control knob |
| 6 Transport SYNC ² Indicator light | 17 SPDIF co-axial input selector button | 26 Menu display window |
| 7 Transport Search Back button | 18 SPDIF co-axial input selector button | 27 Fixed output mute selector button |
| 8 Transport Search Forward button | 19 EIAJ fiber optic digital input selector button | 28 Variable output mute selector button |
| 9 Transport Track Back button | 20 Single-ended input selector button | 29 Menu control button |
| 10 Transport Track Forward button | | 30 Absolute phase indicator light ³ |
| 11 Transport Drive On/Off button | | |

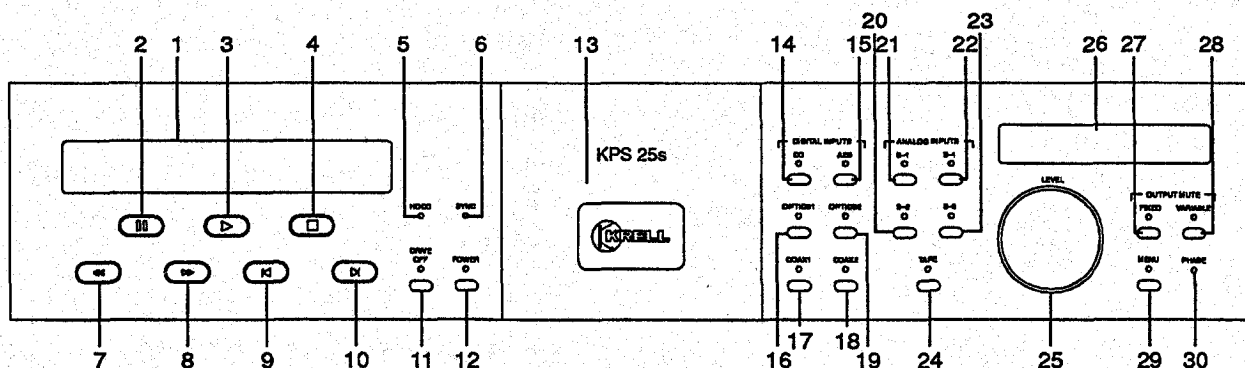

¹ HDCD® is the registered trademark of Pacific Microsonics, Inc.

² Indicates that the digital data is functioning properly.

³ Illuminates when the absolute polarity of the main output is inverted 180°.

THE KPS 25s TABLETOP REMOTE CONTROLLER

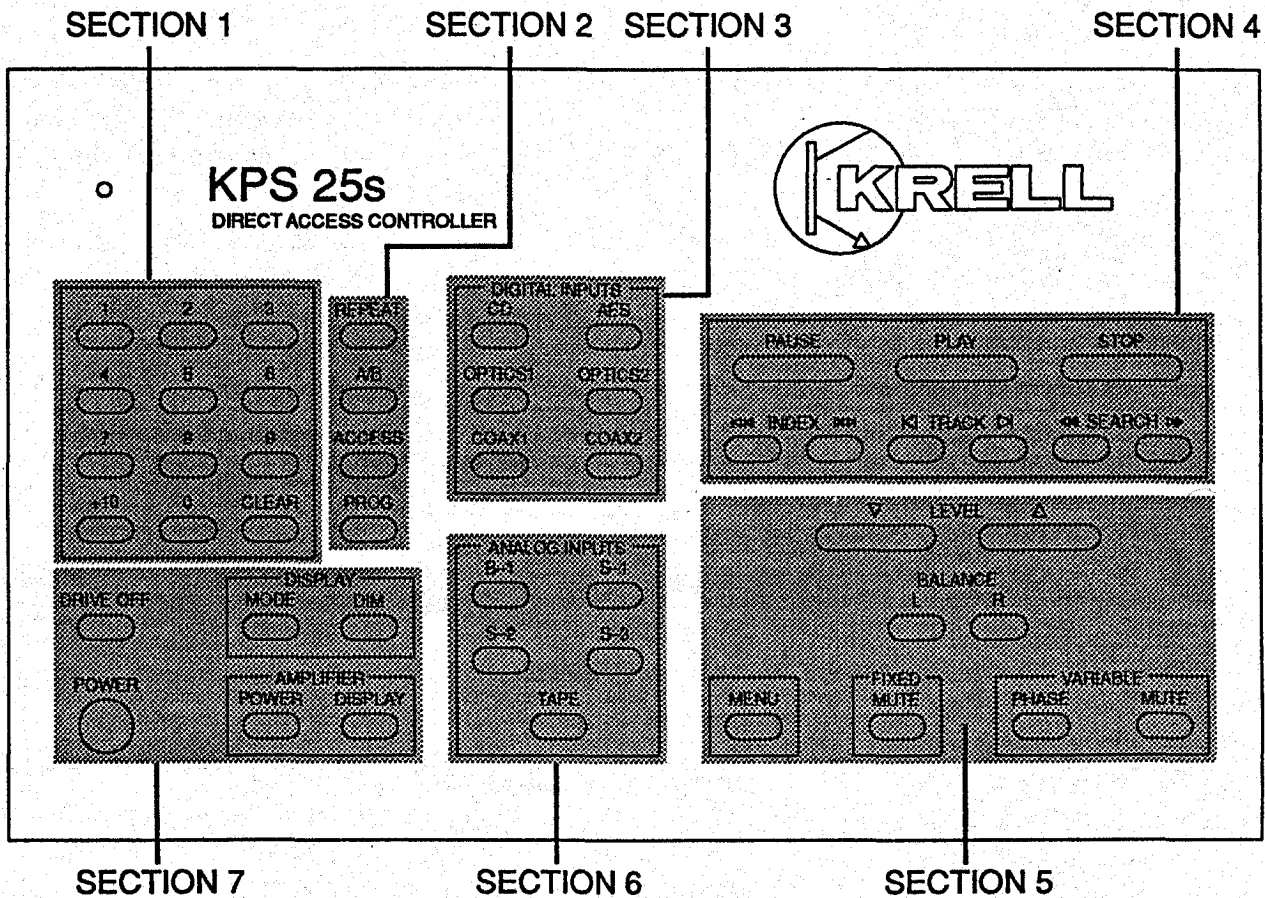

- 2 SPDIF co-axial digital outputs (via RCA connectors)
- 1 AES/EBU digital output (via an XLR connector)

Krell® recommends the use of balanced interconnects. Balanced interconnects not only have the ability to minimize sonic loss but also have immunity to induced noise, especially for installations using long cable lengths. Balanced connections have 6dB more gain than single-ended connections. When level matching is critical, keep this specification in mind.

The XLR pin configuration is described below:

- Pin 1 Ground
- Pin 2 Non-inverting (0°)
- Pin 3 Inverting (180°)

The left and right channel RCA and balanced outputs are labeled on the back panel. Please maintain the correct left/right orientation.

NOTE: Both balanced and single-ended outputs can be used to simultaneously feed different systems.

When the KPS 25s is connected directly to a stereo power amplifier or a pair of monaural power amplifiers, use the variable output terminals to insure proper level control.

Using the fixed outputs in this configuration may cause damage to associated power amplifier and loudspeakers.

Additional Connections

RC-5

The RC-5 input makes custom installation easy and secure by accepting baseband RC-5 input commands from hardwired remote controllers.

12 VDC OUT

The remote power output transmits 12 Volt power on/off signals to other Krell® components, as well as to other components that accept 12 Volt power on/off trigger commands.

NOTE: Consult the owner's reference of the components used in a custom installation to take full advantage of the remote capability of the KPS 25s.

THE KPS 25s HANDHELD REMOTE CONTROLLER

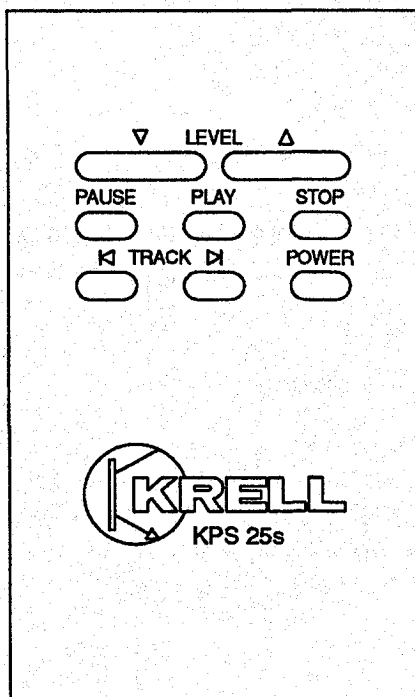

Remote Control Operation

The KPS 25s is equipped with two remote controllers. The KPS 25s Handheld Remote Controller provides the basic functions of Power, Play, Pause, Stop, Track, and Level. The KPS 25s Tabletop Remote Controller, named the Direct Access Controller, provides complete CD transport functions as well as Krell® preamplifier and power amplifier remote control functions. A description of the buttons and their functions follows.

NOTE: The Tabletop Remote Controller also includes functions used with Krell® amplifiers.

Section 1

Direct Number Access Keypad

The Direct Number Access Keypad makes track selection quick and easy. When using the direct track access function, the selected track will begin play immediately after a track is selected. If the track you want to play is numbered 1-9, press the button that corresponds to the track. Use the +10 button to access tracks numbered 10 or higher. The +10 button selects a track in increments of 10.

EXAMPLE: To access Track 8, press the number 8 button once. To access Track 10, press the +10 button once and the 0 button once. To access Track 24, press the +10 button twice and press the 4 button once.

Tracks consisting of two digits must be keyed within eight seconds of each other.

Clear

Deletes the last entry selected in a programmed sequence.

Section 2

Special Play Functions

Repeat

Press once to repeat the entire disc or track program continuously. Press twice to repeat the current track continuously. Press a third time to cancel this function. When selecting the desired Repeat function, press the Repeat button once and REPEAT will appear in the Compact Disc Transport Display Window. Press the Repeat button twice and REPEAT and SINGLE will appear in the Compact Disc Transport Display Window.

A/B

Creates a loop between two pre-determined points within a single track or sequential tracks. To create an A/B loop, start the play of a track. When you hear the part that you want as the beginning of the loop, press A/B to insert the start position. Press A/B again to insert the finish position. A/B will automatically begin and continue indefinitely. Press Stop or A/B again to delete the A/B program.

Access

When an exact start positions is critical, use the Access button to numerically select a position within a specific track program:

Track Programming

Track programming gives you the ability to select the tracks you want to hear, in the order in which you want to hear them. This method of programming is short term and will be cleared when you press the Stop button twice. A maximum of twenty tracks may be stored in a program sequence.

NOTE: *Track Forward, Track Back, Repeat, and Pause function normally within a programmed sequence.*

Prog

Press once to access the track programming mode.

How to Write a Program

1. Press Program on the KPS 25s remote control. PROGRAM will appear in the Compact Disc Transport Display Window.
2. Key in the desired track sequence using the numeric keypad. Tracks consisting of two digits must be keyed within eight seconds of each other. The number of tracks and total playing time of the programmed sequence will appear in the Compact Disc Transport Display Window. Track numbers will appear in the Compact Disc Transport Display Window in the order in which they are stored within a programmed sequence.
3. Press Play to begin playback of a programmed sequence.
4. Press the Stop button twice to erase a programmed sequence.

Section 3

Digital Inputs

The KPS 25s has six digital inputs: CD, AES, OPTICS 1, OPTICS 2, COAX 1, and COAX 2. Press the appropriate button to select the input that supports your source.

Section 4

Track Functions

Pause

Press once to temporarily suspends playing the current track. Press the Pause or Play button to resume playing the track at the point Pause was engaged.

Play

To activate playback from the beginning of the CD, press the Play button after inserting the CD onto the transport. Clamp the CD down, and close the Acrylic Cover. Playback will begin from the first track. If the CD is loaded and the disc contents have been scanned, press Play on the front panel or remote control. The disc will start playing from Track 1 or the beginning of a programmed track sequence. When an HDCD[®] encoded CD is played, the HDCD[®] led illuminates, indicating that HDCD[®] decoding is functioning.

Stop

Terminates CD playback.

|< |<: Index Back

Press once to select the index number prior to the current index number within a specific track, if the CD has been recorded with separate indexing.

>| >|: Index Forward

Press once to select the index number following the current index number within a specific track, if the CD has been recorded with separate indexing.

NOTE: *Some discs do not have index numbers programmed within tracks. When the Index buttons are pressed, the display will default to the current track number.*

|<: Track Back

Press once to select and begin playing the track that precedes the current track.

>|: Track Forward

Press once to select and begin playing the track that follows the current track.

<<: Search Back

Perform a sustained press of the button to scroll backward through the current track.

>>: Search Forward

Perform a sustained press of the button to scroll forward through the current track.

Section 5

Volume Adjustment and Menu Functions

Level Up and Down

Press to adjust the volume and to scroll through menu functions.

Balance Left and Right

Press to balance speakers.

Menu

Press to access menu functions. See also Menu Functions page 15.

Fixed Mute

Press to activate. There is no signal on the fixed output when the led on the front panel of the KPS 25s is on.

Variable Mute

Press to activate. There is no signal on the variable output when the led on the front panel of the KPS 25s is on.

Variable Phase

Press to invert the absolute polarity of the main output 180 degrees. When the polarity is reversed, the led on the front panel of the KPS 25s is on.

Section 6

Analog Inputs

The KPS 25s has five analog inputs. Press the button to select the input that supports your source. B-1, S-1, S-2, S-3, TAPE.

¹HDCD[®] is the registered trademark of Pacific Microsonics, Inc.

Section 7

Amplifier and Display Window Functions

NOTE: Use the Amplifier Power and Amplifier Display buttons to access a Krell® amplifier connected to your system. These buttons do not activate the KPS 25s.

Display Mode

Cycles the Compact Disc Transport Display Window through three options: the elapsed time of the track currently playing, the time remaining in the current track, and the total remaining time of the disc or program. Press the CD button and then press the Mode button. The options will appear in the Compact Disc Transport Display Window as they are selected.

Display Dim

Turns the Compact Disc Transport Display Window On/off.

Amplifier Power

Turns a Krell® remote controlled amplifier On/off.

Amplifier Display

Operates the display of a Krell® remote controlled amplifier.

Drive Off

Turns the CD transport On/off.

Power

The main power switch that turns the KPS 25s On/off.

Battery Installation and Removal

NOTE: Batteries should be replaced when functions activated by the remote controller become intermittent. The KPS 25s Tabletop Remote Controller uses four AAA size 1.5 Volt batteries. The KPS 25s Handheld Remote Controller uses two AAA size 1.5 Volt batteries.

1. Remove the backplate to expose the batteries.
2. Remove the old batteries.
3. Install the new batteries, following the battery position diagram on the plastic battery receptacle.
4. Re-install the backplate.
5. Check to make sure the remote control is functioning properly.

Menu Functions

All initial set up and subsequent system configuration adjustments may be made using either the Tabletop Remote Controller, or the front panel controls. Several menu features that customize the KPS 25s are described below.

To adjust the brightness of the Menu Display Window:

1. Press the Menu button. The word MENU will appear in the Menu Display Window.
2. Turn the Level Control Knob until the word BRIGHT appears.
3. Press the Menu button again. The current brightness level will appear in the Menu Display Window.
4. Turn the Level Control Knob to the left or right to view brightness levels. The display may be set to mute the brightness completely. When the brightness level is set to the desired level, press the Menu button one more time to lock the setting in place.
5. To exit the Menu mode completely, press the Menu button again.

To assign custom names to any of the digital or the analog inputs of the KPS 25s:

1. Press the Menu button. The word MENU will appear.
2. Turn the Level Control Knob until the word NAME appears.
3. Press the Menu button again. The word AESEBU will appear.

4. Turn the Level Control Knob to select the input to which you want to assign a custom name.
5. Press the Menu button. The word PHONO will appear.
6. Turn the Level Control Knob to select the desired name.
7. Press the Menu button to lock the selected name to the selected input.
8. To exit the Menu mode completely, press the menu button again.

NOTE: The input for CD cannot be renamed.

To select an input for Theater Throughput™:

1. Press the Menu button. The word MENU will appear.
2. Turn the Level Control Knob until the word THEATER appears.
3. Press the Menu button again. The word CD will appear.
4. Turn the Level Control Knob to select the input for Theater Throughput™.
5. Press the Menu button again to display the current theater mode setting. When the display reads YES, Theater Throughput™ is active. When the display reads NO, Theater Throughput™ is inactive.
6. Turn the Level Control Knob to select the desired theater mode setting.
7. Press the Menu button to lock the setting in place.
8. To exit the Menu mode completely, press the Menu button again.

To change the shutter operation mode:

1. Press the Menu button. The word MENU will appear.
2. Turn the Level Control Knob until the word SHUTTER appears.
3. Press the Menu button again. The current shutter operation mode will appear.
4. Turn the Level Control Knob to select the desired shutter operational mode.
5. Press the Menu button to lock the setting.
6. To exit the Menu mode completely, press the Menu button again.

To change the cover operational modes:

1. Press the Menu button. The word MENU will appear.
2. Turn the Level Control Knob until the word COVER appears.
3. Press the Menu button again. The current cover operational mode will appear.
4. Turn the Level Control Knob to select the desired cover operational mode.
5. Press the Menu button to lock the setting.
6. To exit the Menu mode completely, press the Menu button again.

To change an input's volume trim:

1. Press the Menu button. The word MENU will appear.
2. Turn the Level Control Knob until the words VOL TRIM appear.
3. Press the Menu button again. The word CD will appear.

4. Turn the Level Control Knob to select the input for volume trim.
5. Press the Menu button again. The current volume trim will appear.
6. Turn the Level Control Knob to select the desired volume trim.
7. Press the Menu button to lock the setting.
8. To exit the Menu mode completely, press the Menu button again.

To change the volume control sensitivity:

1. Press Menu button. The word MENU will appear.
2. Turn the Level Control Knob until the words VOL SPEED appear.
3. Press the Menu button again. The current volume speed will appear.
4. Turn the Level Control Knob to select the desired volume speed.
5. Press the Menu button to lock the setting.
6. To exit the Menu mode completely, press the Menu button again.

To return all settings to factory default values:

1. Press the Menu button. The word MENU will appear.
2. Turn the Level Control Knob until the words ALLCLEAR appear.
3. Press the Menu button again. The word WAIT will appear.
4. To exit the Menu mode completely, press the Menu button again.

Warranty

THERE ARE NO USER-SERVICEABLE PARTS INSIDE ANY KRELL PRODUCT.

The KPS 25s Krell® Playback System has a limited and transferable warranty of five years for parts and labor and three years on transport related parts. The warranty period begins on the date of retail purchase, as noted on the retail sales slip provided by an authorized Krell® dealer or distributor, or on the warranty registration card sent to Krell®. In the event adequate proof of purchase date is unavailable, the warranty period will begin on the date the unit was originally shipped from the factory. The original ship date can be determined by Krell® from the serial number.

The warranty for Krell® products is valid only in the country to which they were originally shipped, through the authorized Krell® distributor for that country, and at the factory. There may be restrictions on, or changes to Krell's warranty because of regulations within a specific country. Please check with your distributor for a complete understanding of the warranty in your country.

Freight to the factory is your responsibility. Second day return freight within the United States (U.S.A.) is included in the warranty. If you have purchased your Krell® product outside the U.S.A. and wish to have it serviced at the factory, all freight and associated charges to the factory are your responsibility. Krell® will pay return freight to the

U.S.A.-based freight forwarder of your choice. Freight and other charges to ship the unit from the freight forwarder to you are also your responsibility.

The operating voltage of this unit is determined by the factory and can only be changed by an authorized Krell® distributor or at the factory. The voltage for the KPS 25s Krell Playback System in the U.S.A. can not be changed until six months from the original purchase date. Any unauthorized voltage conversion, disassembly, component replacement, perforation of chassis, updates, or modifications performed to the unit will void the warranty.

Krell® is not responsible for any damage incurred in transit. Krell® will file claims for damages as necessary for units damaged in transit to the factory. You are responsible to file claims for shipping damages during the return shipment.

The use of any packing material other than original is not recommended. Krell® may, at its discretion, pack a unit in new packing for the return shipment and bill you for such packing if the unit was packed in non-standard packing or the original packaging is so damaged as to be unusable. Should you need to purchase additional packaging please contact your authorized Krell® dealer, distributor or Krell® for assistance.

All operational features, functions, and specifications and policies are subject to change without notification.

Return Authorization Procedure

IMPORTANT: If you believe there is a problem with your unit, please contact your dealer, distributor, or the Krell® factory immediately. Do not return any unit to Krell® for repair without first discussing the problem and obtaining a Return Authorization Number.

To return a product, the owner is required to:

- Obtain a Return Authorization Number (R/A number) and shipping address from the Krell® Service Department.
 - Insure and accept all liability for loss or damage to the product during shipment to the Krell® factory and prepay all shipping charges. The product may also be hand delivered if arrangements with the Service Department have been made in advance. Proof of purchase may be required for warranty validation at the time of hand delivery.
 - Use the original packaging to insure the safe transit of the product to the factory, dealer, or distributor. The use of any packaging material other than the original packaging materials is not recommended. Krell® may, at its discretion, return a product in new packaging and bill the owner for such packaging if the product received by Krell® was boxed in non-standard packaging or if the original packaging was so damaged that it was unusable. If Krell® determines that new packaging is required, the owner will be notified before the product is returned.
- To purchase additional packaging, please contact your authorized Krell®

dealer, distributor, or the Krell® Service Department for assistance.

Krell® is not responsible for any damage incurred in transit. Krell® will file claims for damages as necessary for products damaged in transit to the factory. The owner is responsible for filing claims for shipping damages that occur during the return shipment.

Replacement parts and/or products will be furnished on an exchange basis only; any parts and/or products returned to Krell® for exchange become the property of Krell®.

No expressed or implied warranty is made for any Krell® product damaged by accident, abuse, misuse, natural or personal disaster, or unauthorized modification.

In the event that Krell® receives a product for warranty service which has been modified in any way without Krell® authorization, all warranties on that product will be void. The product will be returned to original factory layout specifications at the owner's expense before it is repaired. All repairs required after the product has been returned to original factory specification will be charged to the customer, at current parts and labor rates.

To contact the Krell Service Department

TEL 203-799-9954
Monday-Friday
9:00 AM to 5:00 PM EST
FAX 203-799-9796
E-MAIL pbresnahan@krellonline.com

KPS 25s

PRODUCT

SERIAL NUMBER

To register your product for warranty benefits, complete and return the Warranty Registration Card enclosed in the shipping box within 15 days of purchase.

Krell® Industries, Inc.
45 Connair Road
Orange, CT 06477-3650 USA

TEL 203-799-9954, FAX 203-799-9796
E-MAIL krell@krellonline.com
www.krellonline.com

KPS 25s

Krell Playback System™

Specifications

FREQUENCY RESPONSE

0.1 Hz-1 MHz 0, -3 dB

REMOTE CONTROL

- 1 handheld wireless infrared
- 1 tabletop multi-function wireless infrared

TRANSPORT

JVC EXU-901A

ANALOG INPUTS

- 1 Pair balanced (via an XLR connector)
- 4 Pair single-ended (via RCA connectors)

ANALOG OUTPUTS

- 2 Pair balanced (via XLR connectors)
- 3 Pair single-ended (via RCA connectors)
- 1 Pair CAST™ (via a 4-pin bayonet connector)

GAIN

6 dB (single-ended) 12 dB (balanced)

SIGNAL TO NOISE RATIO

97dB (balanced) "A" weighted

DISTORTION

1KHz less than 0.005% THD (balanced)

20KHz less than 0.008% THD (balanced)

INPUT IMPEDANCE

98k Ohms

OUTPUT IMPEDANCE

17 Ohms

OUTPUT VOLTAGE

13 volts R.M.S. (balanced)

DIGITAL INPUTS/OUTPUTS

2 EIAJ optical (via TosLink™ connectors)

2 SPDIF coaxial (via RCA connectors)

1 AES/EBU balanced (via an XLR connector)

DIMENSIONS

19w x 5.25h x 15.38d in.

48.3w x 13.3h x 39.1d cm

WEIGHT

Shipping 55 lbs., 25 kg

Unit only 45 lbs., 20.5 kg

All operational features, functions, specifications, and policies are subject to change without notification.

Free Manuals Download Website

<http://myh66.com>

<http://usermanuals.us>

<http://www.somanuals.com>

<http://www.4manuals.cc>

<http://www.manual-lib.com>

<http://www.404manual.com>

<http://www.luxmanual.com>

<http://aubethermostatmanual.com>

Golf course search by state

<http://golfingnear.com>

Email search by domain

<http://emailbydomain.com>

Auto manuals search

<http://auto.somanuals.com>

TV manuals search

<http://tv.somanuals.com>