

Stealthbox®

INSTALLATION GUIDE
for the
SB-SC-TC/10W3v3
2005 - Up Scion tC



Thank you for choosing a JL Audio Stealthbox® for your automotive sound system. With proper installation, your new vehicle-specific enclosed subwoofer system will deliver years of listening pleasure.

We strongly recommend that you have your new Stealthbox® installed by your authorized JL Audio dealer. The installation professionals employed by your dealer have the necessary tools and experience to disassemble and reassemble your vehicle properly. Also, keep in mind that your warranty coverage extends to 1 year if your system is installed or approved by your authorized JL Audio dealer. If you prefer to perform your own installation, please read this installation guide completely before beginning the process.

JL AUDIO®
Ahead of the Curve™

! IMPORTANT

If you choose to perform the installation yourself, it is absolutely vital that the Stealthbox® be properly mounted to the vehicle according to these instructions. Failure to mount the enclosure properly presents two problems:

- 1) The sub-bass performance will suffer due to the movement of the enclosure caused by the force exerted by the woofer(s).
- 2) A loose enclosure presents a serious safety hazard in the event of a collision or sudden deceleration.

INSTALLATION DIFFICULTY:

2 OUT
OF
5



STEP 1

Place the rears seats in the upright position.

Remove the factory cargo cover, carpeted flooring, jack tools and the spare tire.

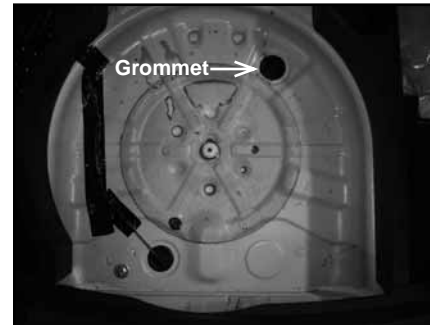

STEP 2

Remove the black foam blocks and the large round rubber grommet from the spare tire wheel.



STEP 3

Place the Stealthbox® into the spare tire wheel. The flat end of the Stealthbox® is to face the back of the vehicle.

**STEP 4**

Place the spare tire onto the Stealthbox®, with the yellow side up.

Position the spare tire and Stealthbox® so the spare tire matches up with the curve of the rear sill plate.

**STEP 5**

Position the spare tire and Stealthbox® so the spare tire matches up with the curve of the left side foam panel.

**STEP 6**

Make sure that the front L-bracket's mounting hole is positioned over the hole from the removed grommet.

**STEP 7**

Remove the spare tire without disturbing the Stealthbox®.

Remove the rear sill plate from vehicle.

**STEP 8**

Note: Before drilling, make sure that you are not going to be drilling into any gas lines, brake lines, transmission lines, electrical wiring or anything else that might cause a reduction in your weekly pay.
Always wear eye protection when drilling!

With a drill and a 3/8-inch drill bit, using the rear L-bracket's mounting hole as a guide. Drill through the vehicle's wheel well.

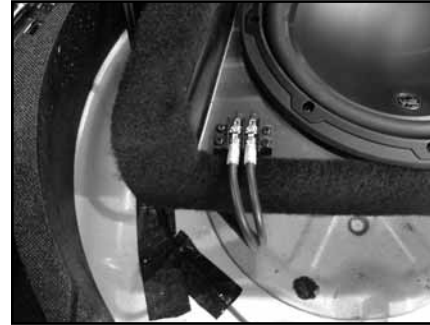
**STEP 9**

Lay the Stealthbox® onto its top side.

Run speaker wire from the amplifier location to the Stealthbox® location, apply spade forks onto the speaker wire, secure to the terminal and check for proper operation of the woofer.

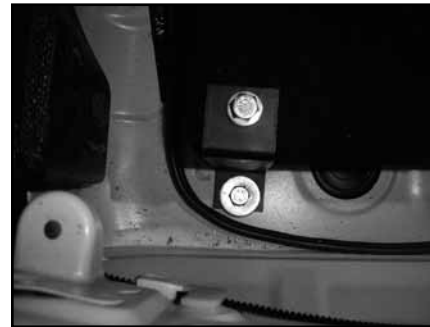
**STEP 10**

Lay the Stealthbox® back to its original position.

Apply a supplied flat washer onto a supplied hex cap screw.

Insert this bolt assembly through the rear Z-bracket and the drilled hole.

**STEP 11**

Apply a supplied flat washer onto a supplied hex cap screw.

Drop this bolt assembly through the front L-bracket and large factory hole.

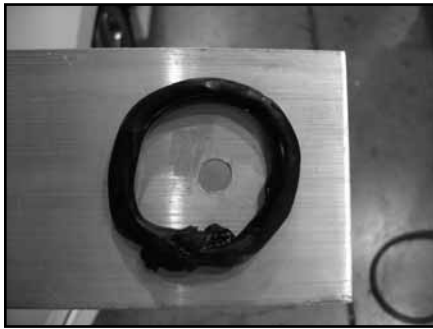

STEP 12

Apply a bead of silicon or any adhesive sealant around the hole of the supplied aluminum plate.

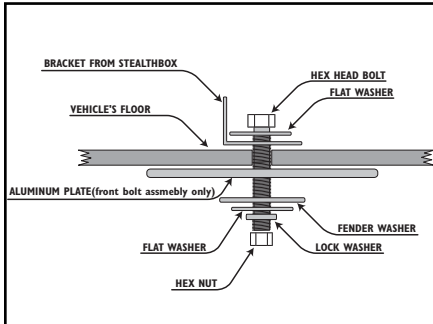

STEP 13

From under the vehicle, place the supplied aluminum plate(front bolt assembly only), fender washers, flat washers, lock washers and then hex nuts onto each protruding hex cap screws and secure.

Note: For added protection, it is recommended that you apply a bead of silicone between the vehicle and the fender washer. After the bolt assembly is tightly secured, it is also recommended that vehicle under-coating material is applied to the exposed assembly.

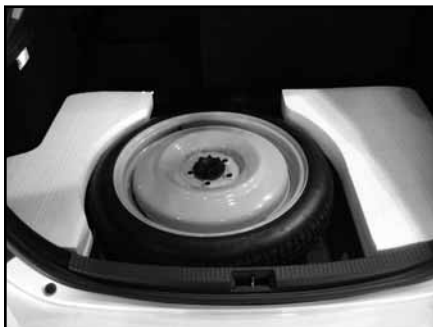

STEP 14

Place both supplied foam supports around the spare tire as shown to the left.

Place the spare tire with the yellow side up onto the Stealthbox® and secure with the factory hold down bolt that was removed in STEP 1.

Place the supplied replacement flooring into vehicle. Note: If the child LATCH system will be used, slight modification of the supplied flooring is required.



CONGRATULATIONS

You have completed the installation for this model!

Please refer to the Power Recommendation section for an amplifier recommendation and basic set-up help.

INCLUDED HARDWARE

- (4) 3/8-inch USS Flat Washer
- (2) 3/8-inch Split Lock Washer
- (4) 3/8-inch x 1-1/4-inch Fender Washer
- (2) 3/8-inch x 1-3/4-inch -16 Hex Cap Screws
- (1) 4-inch x 6-inch x 3/16-inch Aluminum Plate
- (2) 3/8-inch -16 Hex Nut
- (2) Foam Flooring Spacers
- (1) Carpeted Flooring

SPECIFICATIONS

Enclosure Type: Acoustic Suspension (sealed)
 Driver Type: 10W3v3-4
 Nominal Impedance: 4 ohms mono
 Continuous Power Handling: 300 Watts

POWER RECOMMENDATION

JL Audio recommends using a high quality amplifier such as the JL Audio 250/1. The diagram below shows the recommended crossover, infrasonic filter and equalizer settings for the 250/1 when being used to power your Stealthbox®.

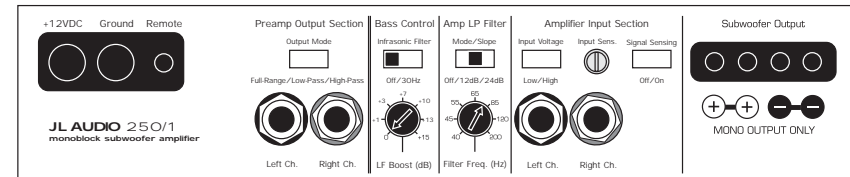

The JL Audio 250/1 is a very versatile audio component. Please consult the owner's manual for even more detailed information about installing and tuning this amplifier.

MID/HIGH FREQUENCY DRIVER FITMENT

A variety of JL Audio coaxial and component systems will fit in the factory speaker locations of your vehicle.

Front Speaker Size / Location: 6.5-inch Separates / Front Doors
 Fits JL Audio Models: TR650-CSi, TR650-CXi, VR650-CSi, VR650-CXi, XR650-CSi, XR650-CXi & ZR650-CSi

Rear Speaker Size / Location: 5.25-inch / Rear Deck
 Fits JL Audio Models: TR525-CXi, VR525-CXi & XR525-CXi



JL AUDIO®
Ahead of the Curve™

(954) 443-1100

www.jlaudio.com

All specifications are subject to change without notice. "JL Audio" and the JL Audio logo, "Stealthbox" and the Stealthbox logo are registered trademarks of JL Audio, Inc. "Ahead of the Curve" and its respective logo is a trademark of JL Audio, Inc.
 JLA-SKU#011224-11-28-2006 • Printed in USA • ©2005 JL Audio, Inc. • U.S. PATENTS: #5,734,734 #5,949,898 #6,118,884 #6,229,902 #6,243,479 #6,294,959 #6,501,844 #6,496,590 #6,441,685 #5,687,247 #6,219,431 #6,625,292 #D472,891 #D480,709 Other U.S. & Foreign patents pending. For more detailed information please visit us online at www.jlaudio.com.



Free Manuals Download Website

<http://myh66.com>

<http://usermanuals.us>

<http://www.somanuals.com>

<http://www.4manuals.cc>

<http://www.manual-lib.com>

<http://www.404manual.com>

<http://www.luxmanual.com>

<http://aubethermostatmanual.com>

Golf course search by state

<http://golfingnear.com>

Email search by domain

<http://emailbydomain.com>

Auto manuals search

<http://auto.somanuals.com>

TV manuals search

<http://tv.somanuals.com>