

FATHOM® IWS

IWS-SYS-1  
IWS-SYS-2

Owner's Manual



**JL AUDIO®**  
*Ahead of the Curve™*

## IMPORTANT SAFETY INSTRUCTIONS

**WARNING:** TO REDUCE THE RISK OF FIRE OR ELECTRIC SHOCK, DO NOT EXPOSE THIS PRODUCT TO RAIN OR MOISTURE.

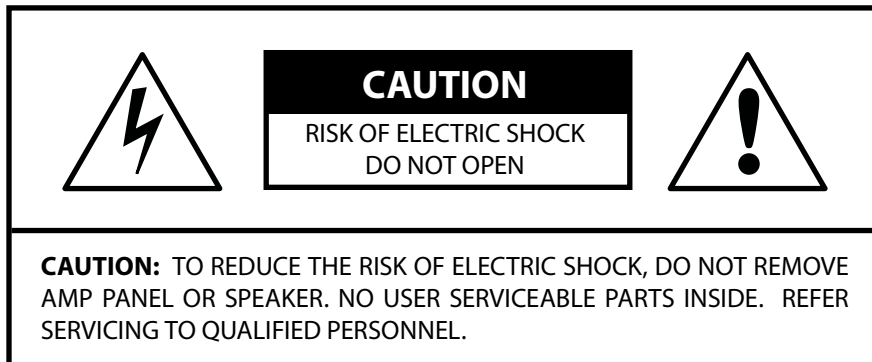

- 1) **Read the Instructions** — All safety and operating instructions should be read before the subwoofer is operated.
- 2) **Retain the Instructions** — The safety and operating instructions should be retained for future reference.
- 3) **Heed Warnings** — All warnings on the subwoofer and in the operating instructions should be followed.
- 4) **Follow Instructions** — All operating and use instructions should be followed.
- 5) **Water and Moisture** — The subwoofer should NOT be used near water – for example, near a bathtub, washbowl, sink, laundry tub, in a wet basement, near a swimming pool, etc.
- 6) **Ventilation** — The subwoofer amplifier should be situated so that its location or position does not interfere with its proper ventilation. For example, the subwoofer amplifier should not be situated on a bed, sofa, rug, or similar surface that may block airflow over the heatsink fins. If placing the subwoofer amplifier in a “built-in” installation, ensure that airflow to the heat sinks are not impeded. Do not cover the amplifier heatsink with tablecloths, curtains, etc.
- 9) **Heat and Flames** — The subwoofer and amplifier should be situated away from heat sources such as radiators, heat registers, stoves, fireplaces, or other devices which produce heat. Do not place candles on top of or near the subwoofer or amplifier.
- 10) **Power sources** — The subwoofer should only be connected to a power supply of the type described in the operating instructions or as marked on the product.
- 11) **Power Cord Protection** — Power-supply cords should be routed so that they are not likely to be walked on or pinched by items placed upon or against them, paying particular attention to cords at plugs, convenience receptacles, and the point where they exit the subwoofer.



*The lightning flash with arrowhead symbol, within an equilateral triangle, is intended to alert the user to the presence of uninsulated “dangerous voltage” within the product’s enclosure that may be of sufficient magnitude to constitute a risk of electric shock to persons.*



*The exclamation point within an equilateral triangle is intended to alert the user to the presence of important operating and maintenance instructions in the literature accompanying the product.*

- 12) **Cleaning** — The subwoofer and amplifier should be cleaned only as recommended in the operating instructions.
- 13) **Nonuse Periods** — The power cord of the subwoofer amp should be unplugged from the outlet when the subwoofer is left unused for long periods of time.
- 14) **Lightning and Power Surges** — We recommend that you disconnect the subwoofer amp from the electrical outlet during electrical storms and/or recurring power interruptions to prevent damage due to power surges.
- 15) **Object or Liquid Entry** — Care should be taken so that objects do not fall into and liquids are not spilled onto the subwoofer enclosure. Do not expose the subwoofer to dripping or splashing from liquids. Do not place objects filled with liquids on top of, or near the subwoofer or amplifier. For example: flower vases, beverages, liquid-fueled lamps, etc.
- 16) **Damage Requiring Service** — The subwoofer should be serviced by qualified service personnel when:
- a. the power-supply cord or plug has been damaged
  - b. objects have fallen or liquid has been spilled into the subwoofer
  - c. the subwoofer has been exposed to rain
  - d. the subwoofer does not appear to operate normally or exhibits a marked change in performance
  - e. the subwoofer has been dropped or the cabinet has been damaged
  - f. the subwoofer driver's cone and/or suspension has been physically damaged
- 17) **Servicing** — The user should not attempt to service the subwoofer beyond what is described in the operating instructions. All other servicing should be referred to qualified service personnel.
- 18) **Overloading** — Do not overload wall outlets, extension cords, or outlet strips as this can result in a risk of fire or electric shock.
- 19) **Grounding** — This subwoofer is supplied with a three-prong, grounded power cord. Precautions should be taken so that the grounding means of the subwoofer are not defeated. Defeating the grounding prong on the subwoofer power cord could increase the risk of electric shock and could result in permanent damage to the subwoofer's electronics.

WARNING



THIS SUBWOOFER IS CAPABLE OF PRODUCING VERY HIGH SOUND PRESSURE LEVELS. PLEASE EXERCISE RESTRAINT IN ITS OPERATION TO PROTECT YOUR HEARING FROM PERMANENT DAMAGE.

## FCC COMPLIANCE STATEMENT

**NOTE:** This equipment has been tested and found to comply with the limits of Part 15 of the FCC Rules. These limits are designed to provide reasonable protection against harmful interference in a residential installation. This equipment generates, uses and can radiate radio frequency energy and, if not installed in accordance with the instructions, may cause harmful interference to radio communications. However, there is no guarantee that interference will not occur in a particular installation. If this equipment does cause harmful interference to radio or television reception, which can be determined by turning the equipment off and on, the user is encouraged to try to correct the interference by one or more of the following measures:

- Reorient or relocate the receiving antenna.
- Increase the separation between the equipment and receiver.
- Connect the equipment into an outlet on a circuit different from that to which the receiver is connected.
- Consult the dealer or an experienced radio/TV technician for help.

## TABLE OF CONTENTS

Important Safety Instructions: . . . . .	2-3
Introduction: . . . . .	4
Product Overview: . . . . .	5
Placing your Fathom IWS in Your Listening Room: . . . . .	6-10
Front Control Panel Layout: . . . . .	11
Rear Control and Connector Panel Layout: . . . . .	11
Front Panel Controls in Detail: . . . . .	12-15
Connecting your Fathom IWS(s): . . . . .	16-23
Recommended Setup Procedure: . . . . .	24-28
Frequently Asked Questions: . . . . .	29
Troubleshooting: . . . . .	30
Limited Warranty / Service Information: . . . . .	31
Specifications: . . . . .	32

## INTRODUCTION

Congratulations on your purchase of a JL Audio Fathom powered subwoofer system. This product has been critically engineered to deliver exceptional performance in your home theater or audio system for many years to come.

As a company, we are intensely committed to core research into high-performance loudspeaker and amplifier technologies. JL Audio's long excursion subwoofer driver designs are widely considered as reference standards for linear behavior and high output. We have also focused our efforts to create powerful amplifier and signal-processing technologies specifically aimed at delivering exceptional low-frequency performance. Your Fathom combines these core disciplines within a compact, beautifully crafted package to deliver an unparalleled listening experience.

**We sincerely thank you for your purchase and invite you to read this manual thoroughly in order to achieve the highest level of performance with your *Fathom IWS* subwoofer system. Enjoy.**

## JL AUDIO TECHNOLOGIES INCLUDED IN *Fathom IWS* SUBWOOFERS

### DMA-Optimized Motor System

DMA is JL Audio's proprietary Dynamic Motor Analysis system aimed at improving dynamic motor behavior. As a result of DMA optimization, loudspeaker motors remain linear in force over an extreme range of excursion and also maintain a highly stable fixed magnetic field over a wide power range. This leads to vastly reduced distortion and faithfully reproduced transients... or put simply: tight, clean, articulate bass.

### Concentric Tube Suspension

(U.S. Patent #5,734,132 & #6,095,280)

The suspension technology of the Fathom IWS driver permits high linear excursions within a very shallow frame design.

### Floating-Cone™ Attach Method

(U.S. Patent #6,501,844)

This assembly technique ensures proper surround geometry in the assembled speaker for better excursion control and dynamic voice coil alignment.

### Plateau-Reinforced Spider Attachment

(U.S. Patent #6,118,884)

This high-integrity suspension attachment relieves stress from the spider material at high-excursions for enhanced reliability.

### High-Damping Feedback Circuit

(U.S. Patent #6,441,685)

This proprietary, discrete control circuit design allows our Class D switching amplifiers to maintain an excellent damping factor for improved transient behavior and fidelity.

## PRODUCT OVERVIEW

JL Audio Fathom IWS subwoofers combine a state-of-the-art JL Audio subwoofer driver and electronics/amplifier package with a highly optimized enclosure to deliver an exceptional listening experience in your home theater or home audio system.

The subwoofer driver in your Fathom subwoofer system is capable of outstanding linear excursion without distress or audible distortion. This reference-quality driver enables your Fathom to reproduce powerful low frequency events with stunning impact and unprecedented accuracy.

To get the most from this long excursion driver platform, prodigious amounts of controlled power are needed. Our electronics engineering team conducted an intense analysis of typical program material and its dynamic demands in order to balance current draw and actual output power requirements relative to the system's impedance characteristics. After careful study, a pair of precisely engineered switching amplifiers employing patented feedback technology were created. These advanced designs are capable of unclipped output voltages equivalent to 1000 watts (System 1) and 2000 watts (System 2) of RMS power when referenced to the nominal loudspeaker impedance, allowing us to take full advantage of each driver's full excursion envelope.

The beautiful cabinet enclosing the workings of your Fathom is also the result of careful engineering. To contain the pressures created by the Fathom driver, we utilized CNC-cut, cabinet-grade baltic birch plywood with extensive internal bracing features and advanced assembly techniques.

Your listening room is the other enclosure that affects the way your bass will sound. All rooms create a specific sonic signature, which must be effectively managed to achieve well-balanced low frequency performance. To aid in this process, the Fathom includes an extensive set of signal processing tools aimed at optimizing your Fathom's performance within your listening space. These features include JL Audio's exclusive Automatic Room Optimization system.

As you can see from this brief introduction, there is a lot of technology in this in-wall subwoofer. The contents of this manual will explain the features, guide you through the setup and tuning of your Fathom subwoofer and help you achieve your ultimate low-frequency listening experience.

**If you require assistance, we urge you to contact your authorized JL Audio retailer for expert setup advice and service.**

IMPORTANT



**IMPORTANT! IT IS A VERY GOOD IDEA TO READ THE NEXT SECTION BEFORE UNPACKING YOUR FATHOM IWS. UNPACKING THE SUBWOOFER NEAR ITS FINAL LOCATION IS RECOMMENDED.**

## PLACING YOUR FATHOM IWS CABINETS IN YOUR LISTENING ROOM:

Your listening room or theater is an integral part of your sound reproduction system. The physical dimensions of the room and its furnishings, materials, doors and windows play an important role in defining how your system sounds.

When you place a sound source in an enclosed rectangular space, “standing waves” are created, resulting from the relationship between the sound’s wavelength and your room’s dimensions. In other words, standing waves result from sound energy that is trapped in the room as it bounces back and forth between opposing walls. Standing waves in the room create acoustic peaks and dips where the sound is either louder or softer, based solely on your physical position in the room. Energy also “builds up” at the room’s boundaries, creating exaggerated bass response at certain frequencies. These fundamental room resonances are called room “modes.”

The moral of this mode story is to try and avoid seating positions in standing wave peak or dip regions. It is highly recommended that you place your listening chairs in areas where modal peaks and dips are moderate and do not reinforce one another. The two most obvious areas to avoid are those near the exact center of the room and those close to any of the room’s walls.

Just as your listening seat can be in a peak or dip region, so can your subwoofer. When placed in a room corner, a subwoofer maximally excites the room’s mode structure, creating the strongest output with the fewest dips. When the subwoofer is pulled away from a corner or wall, the room modes are excited less, which can alter the sound at your listening seat.

Be sure to experiment with both your listening seat position and subwoofer position to find the best solution. Careful experimentation usually leads to a superior sounding system. Use our setup suggestions (illustrated on the opposing page and the following pages) to get you started.

If you cannot avoid placing your sofa against the back wall or your subwoofer in a less than optimal position, all is not lost. Your Fathom IWS’s Automatic Room Optimization (A.R.O.) System can dramatically improve these less-than-ideal situations.

**We recommend that you begin by placing your Fathom IWS enclosure in the front of the room, near the front left or right speaker, but not directly in the corner of the room.** Because the IWS enclosures are built into the walls, you cannot move them later if the corner-loaded bass turns out to be too strong. Please refer to the following illustrations for further placement ideas.

We recommend that you avoid placing the Fathom IWS enclosures near windows to prevent rattling and sound transmission to the outside world.



*If you are planning to install your Fathom IWS amplifier inside a cabinet, please refer to the guidelines on page 8.*

# Recommended Subwoofer Placement Options for One Fathom IWS Enclosure

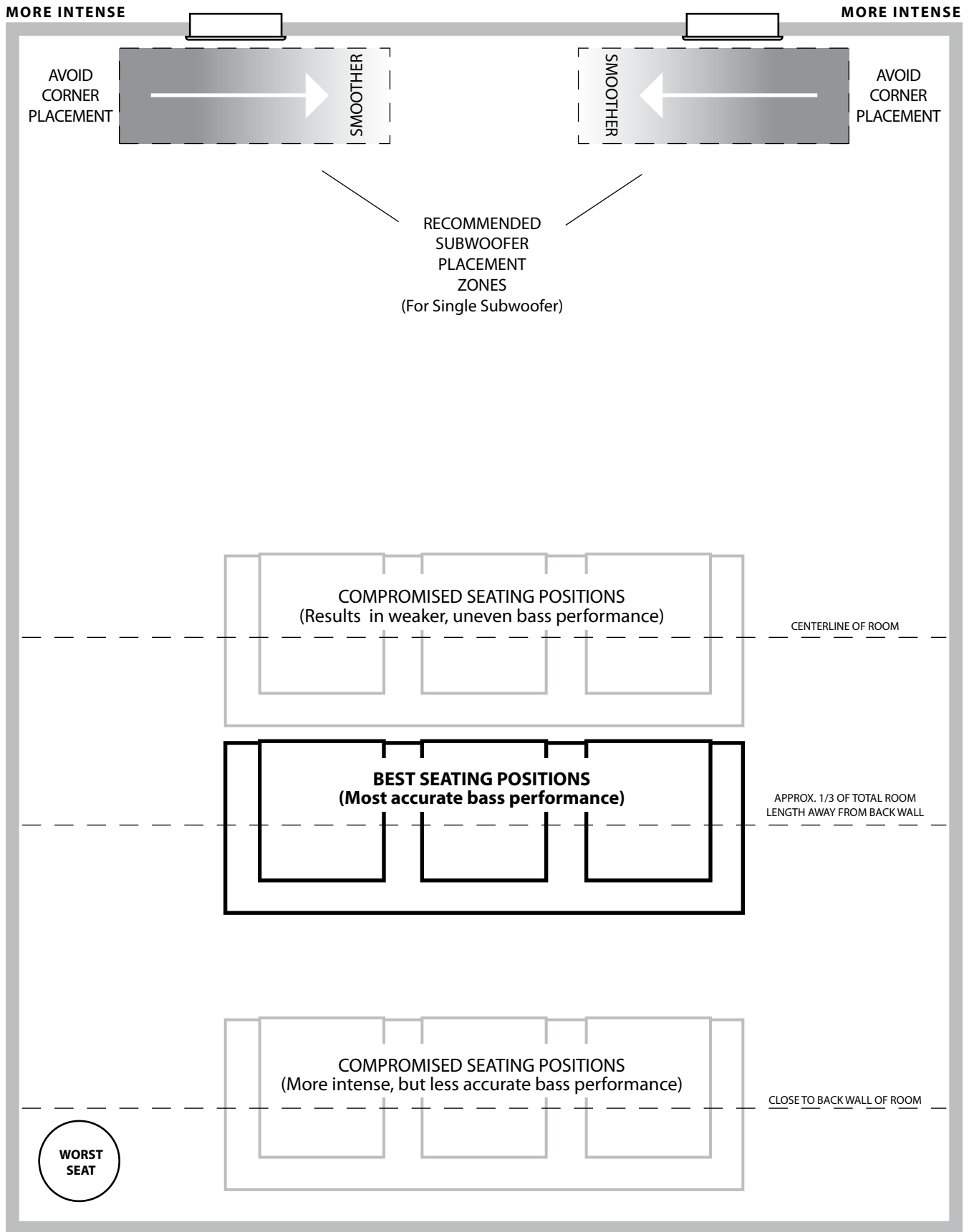

## SPECIAL AMPLIFIER CONSIDERATIONS FOR RACK MOUNTING OR CUSTOM CABINET INSTALLATIONS

Fathom IWS amplifiers are designed to be “built-in” friendly. All typically needed controls are located on the front panel. A Fathom IWS amp can be easily integrated into an equipment rack or custom cabinetry by following a few simple guidelines.

- 1) Allow adequate clear space around the Fathom IWS amp’s side-mounted heatsinks for adequate cooling. Also allow space behind the amp for connector clearance.
- 2) The Fathom IWS amp ships ready to be mounted in a standard equipment rack.
- 3) The Fathom IWS amplifier also includes table-top hardware. Special front-panel end covers that replace the rack ears and rubber feet are included with the IWS amp. To use the amp on a table top, simply remove the hex screws that attach the rack ears and then install the covers. The rubber feet screw into threaded holes in the bottom of the amplifier case.
- 4) While the Fathom IWS amp generally runs only warm during spirited operation, we do recommend that adequate heat vents are included in any custom cabinet which encloses the Fathom IWS amp. A pair of 3 inch (7.5 cm) diameter vents near the bottom of the cabinet and near the top of the cabinet, will allow cool air to circulate over the heatsinks of your Fathom IWS amp keeping it cool and happy.

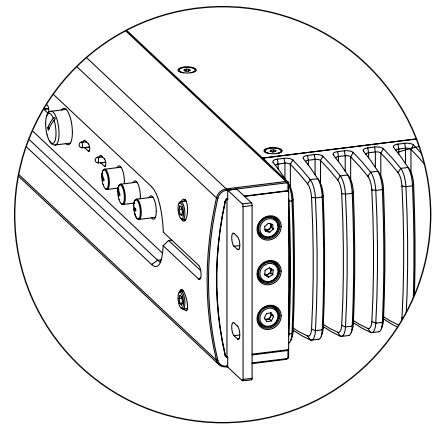

**Rack Ears**

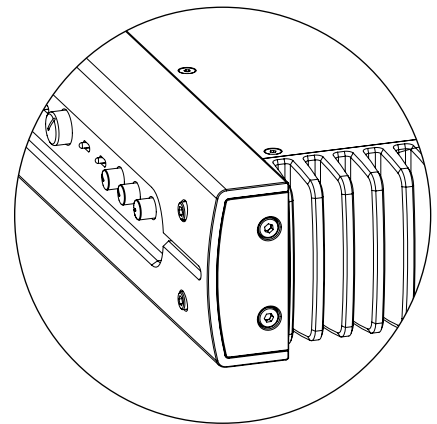

**End Covers**



### Using Two Fathom IWS Enclosures

When using two Fathom IWS boxes, try placement along the front wall near the front left and right speakers, or at the center points of opposing walls as shown at right.

Experimentation with listener placement is recommended to achieve the best results – the benefits can be substantial.

High-resolution measurements and professional system calibration are recommended for the best possible results & system performance.

### Recommended Subwoofer Placement Options for Two Fathom IWS boxes

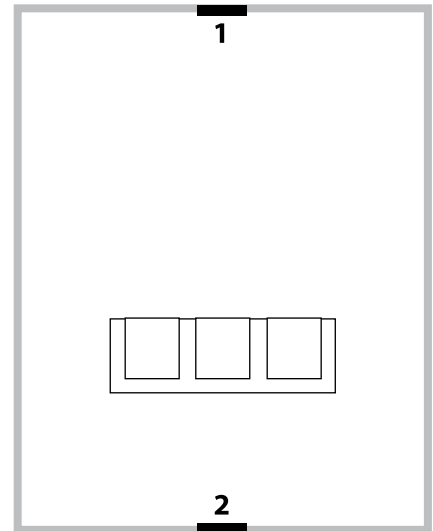
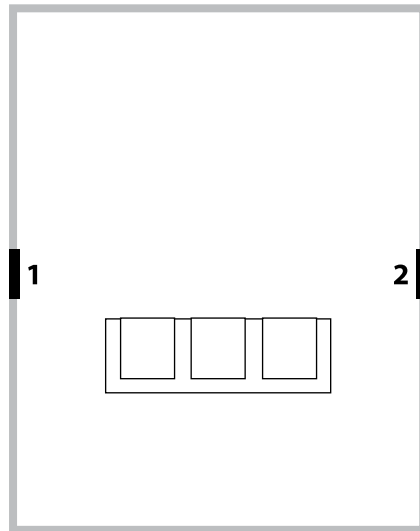
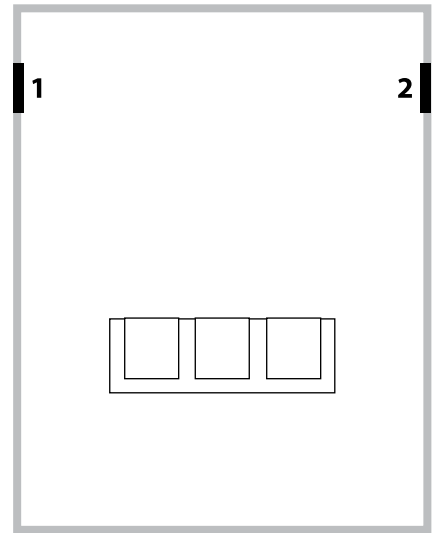
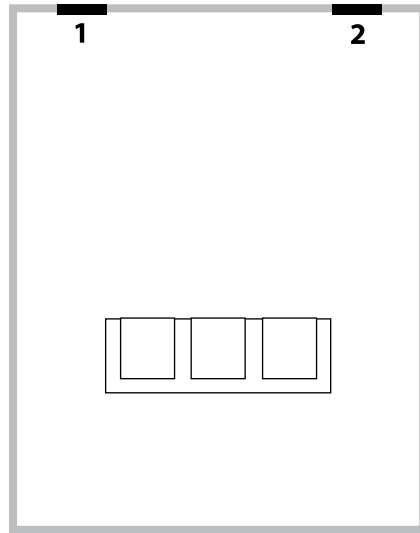

### Recommended Subwoofer Placement Options for Three Fathom IWSs

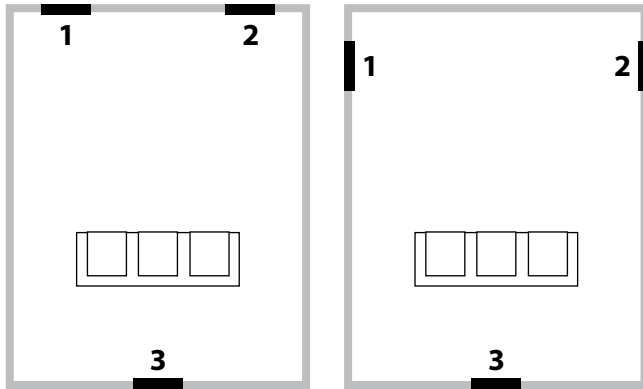

### Using Three or Four Fathom IWS boxes

Research indicates that the smoothest bass response for a large listening area can be achieved using four subwoofers, placing one at the midpoint of each of the four walls (although using two or three subwoofers can be almost as good).

Experimentation with subwoofer and listener placement is recommended to achieve the best results – the benefits can be substantial.

High-resolution measurements and professional system calibration are recommended for the best possible results & system performance.

### Recommended Subwoofer Placement Options for Four Fathom IWSs

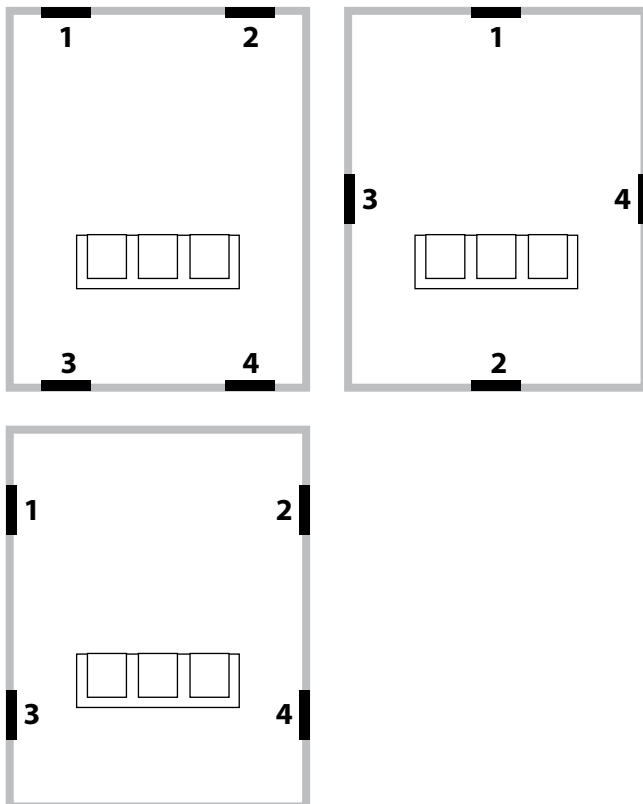

## Front Control Panel

The labeled Figure below depicts the front control panel of a Fathom IWS subwoofer.

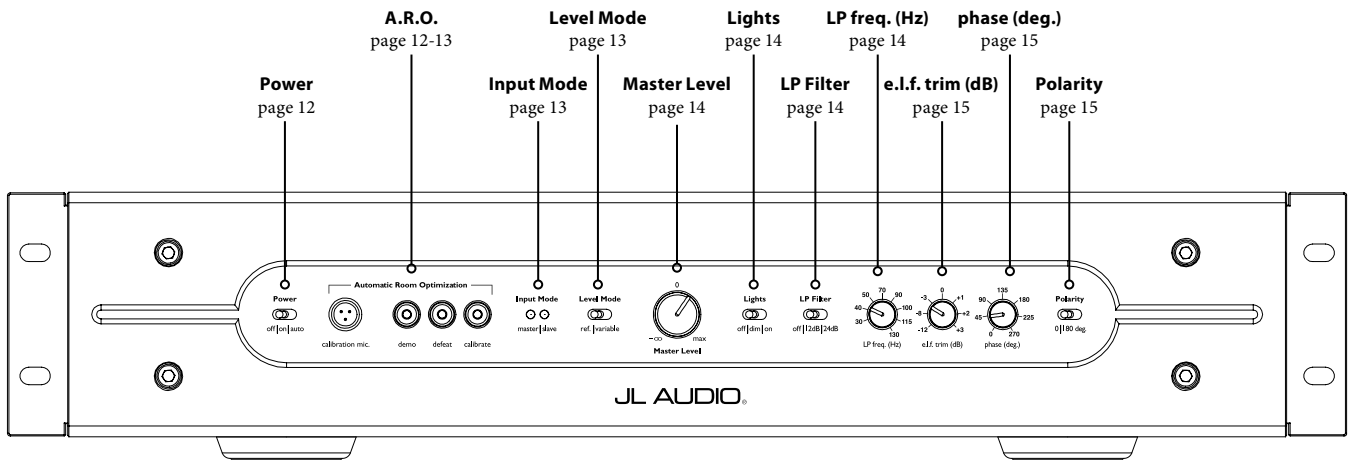

## Rear Controls and Connectors

The labeled Figure below depicts the rear panel of a Fathom IWS subwoofer.

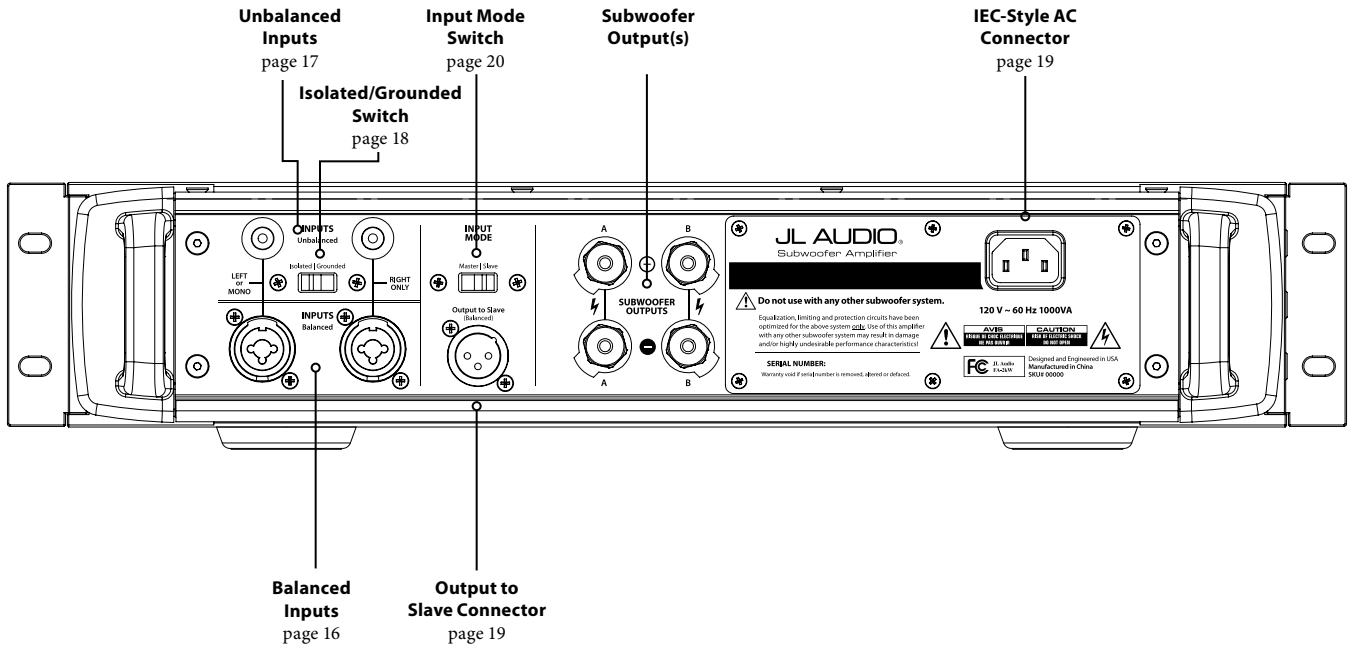

## FRONT PANEL CONTROLS IN DETAIL

### Power Switch

The “Power” switch determines the operational readiness of the Fathom IWS system and should be the only switch used to turn the Fathom IWS amp on and off. Do not use a power strip switch, switched outlet or any other external switch as these may result in undesirable and potentially damaging transient pops. Do not unplug the Fathom IWS’s AC power cord while the unit is turned on.

#### The power switch has three positions:

“On”: The Fathom IWS amp is fully powered at all times. Front panel lights are on unless they have been turned off via the “Lights” switch.

“Off”: The Fathom IWS’s power amplifier is powered down. In this state, a negligible current draw will exist for operating the main power relays. All front panel lights are off.

“Auto”: The Fathom IWS amp will power up when an audio signal is present at any of its inputs and will power down the internal amplifier if no signal has been detected at its inputs for thirty (30) minutes. When dormant, the Fathom IWS will draw a very small amount of current (< 10 watts) to power its signal-sensing circuitry. Front panel lights will turn off when the Fathom IWS powers down and light when the Fathom IWS powers up (unless they have been turned off via the “Lights” switch).

In the unlikely event that the Auto feature is not sensitive enough for a particular system, use a Y-cable adaptor to split the incoming signal into both RCA or XLR inputs on the Fathom IWS. This will increase the input sensitivity by 6 dB. Please be aware that if the Auto sensitivity is too high or if there is significant noise on the input cable, the Fathom IWS may not turn off as desired. If this happens, remove the Y-cable adaptor or look for the noise source in the upstream components.

### Automatic Room Optimization (A.R.O.)

A powerful feature of the JL Audio Fathom IWS subwoofers is their innovative Automatic Room Optimization (A.R.O.) technology. This one-touch system serves to eliminate the largest acoustic response peaks in your home theater at the main listening seat, greatly improving the in-room low-frequency response. Calibration of the A.R.O. system is fully automated. Please consult the next section of this manual for details on how to use the A.R.O. system.

Using the included JL Audio calibration microphone, the A.R.O. calibration procedure takes less than three minutes. In brief, you will connect the included microphone to the “Calibration Mic.” input, press the Calibrate button, and then hold the microphone at ear height in your main listening seat during the test. A noise sequence will be played through the Fathom IWS subwoofer, and the room response will be automatically measured, analyzed and equalized to eliminate the single largest acoustic room response peak at your listening seat. **For detailed instructions on the A.R.O. setup procedure, refer to pages 29-30.**

### Calibration Mic. Input

This input is for connecting the supplied JL Audio calibration microphone to the Fathom IWS subwoofer. Connect one end of the supplied cable to the microphone and the other end to this jack prior to using the A.R.O. system. The A.R.O. system is specifically calibrated to this microphone and its connection scheme is specific to the supplied microphone. The calibration sequence will not operate when a different microphone is connected or if no microphone is connected.



IMPORTANT

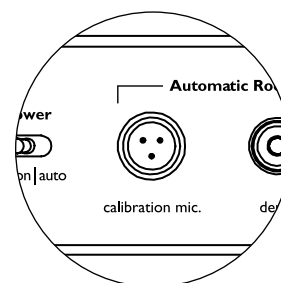
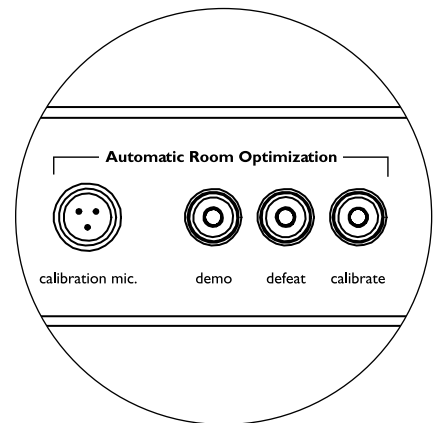
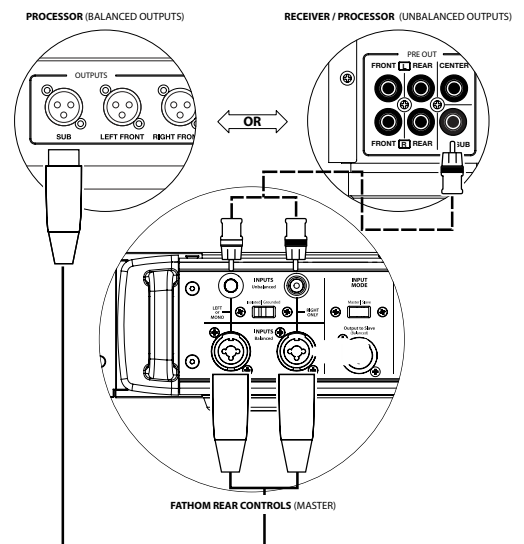
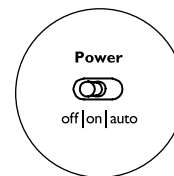

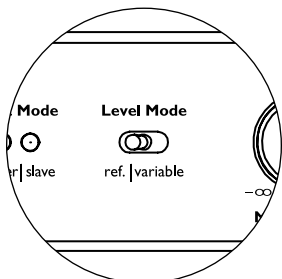
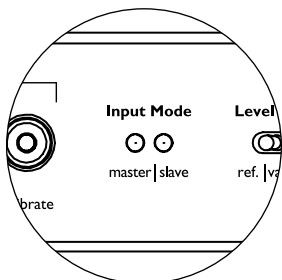
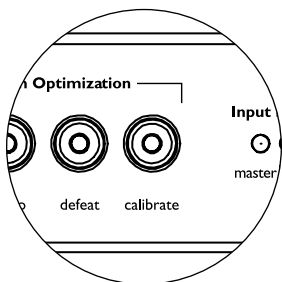
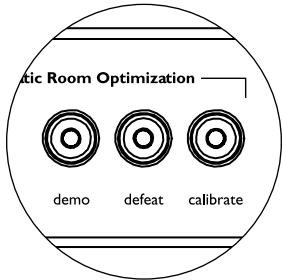
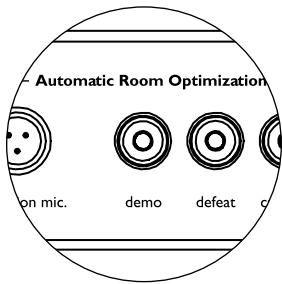

### Demo Button

The Demo button triggers a 20 second long tone sequence that briefly demonstrates the sound of the Fathom IWS subwoofer. The Demo function is useful for showcasing the output capability of the Fathom IWS and to verify that the Fathom IWS (or multiple Fathom IWSs) are operational during system troubleshooting.

The Demo button is also used (in combination) to clear (return to flat) the A.R.O. equalizer settings. **To clear the A.R.O.'s settings & turn off the Calibrate light,** press and hold the Demo button and then press the Defeat button. Please note that you must perform this button sequence quickly. If you hold the Demo button for more than 2 seconds without touching the Defeat button, the Demo tones will start. Should this happen, simply wait for the Demo sequence to end and try again.

### Defeat Button

If "Demo" or "Calibrate" is pressed while the defeat function is active, "Defeat" is automatically canceled. No other front panel controls will alter the A.R.O. Defeat state. The Fathom IWS's Defeat setting is stored in non-volatile memory and will not change even if power is disconnected.

The Defeat button is also used (in combination) to clear (return to flat) the A.R.O. equalizer settings. **To clear the A.R.O.'s settings & turn off the Calibrate light,** press and hold the Demo button and then press the Defeat button. Please note that you must perform this button sequence quickly. If you hold the Demo button for more than 2 seconds without touching the Defeat button, the Demo tones will start. Should this happen, simply wait for the Demo sequence to end and try again.

### Calibrate Button

During the ARO test sequence the Calibrate button's green LED will blink quickly to alert the user to two special conditions:

1. **"JL Audio Microphone NOT Connected"**: If you forget to connect the mic before trying to start a Calibration you will get this alert. Press the Calibrate button once to cancel the alert, connect the A.R.O. microphone, and try again.
2. **"Inappropriate Sound Level for A.R.O. Calibration"**: Since the A.R.O. sequence is completely automatic, this alert likely indicates a problem with the microphone. Press the Calibrate button once to cancel the alert. Ensure that the JL Audio microphone is properly connected and try again. For further help, please refer to Troubleshooting on page 33.

### Input Mode Indicators

The Input Mode indicator LEDs show the input mode, either "Master" or "Slave", selected by the switch on the Fathom IWS's back panel (unless the "Lights" switch is set to "off"). For further details, see page 20.

### Level Mode

The two-position Level Mode switch allows you to select between the following modes:

**"Reference"** - In this mode, the Master Level control knob has no effect on the Fathom IWS's output level. Use this setting if you will primarily be controlling the subwoofer level via your receiver or preamplifier/processor. For those of us with small children or overenthusiastic teenagers, this mode of operation will prevent direct manipulation of the Master Level.

**"Variable"** - In this mode, the Master Level control knob determines the output level of the Fathom IWS subwoofer. This mode is also useful when level matching the Fathom IWS subwoofer to a pair of stereo speakers in a two-channel system.

## Master Level Knob

The Master Level Knob is used to control the output level of the Fathom IWS when the Variable Level mode is selected on the front control panel.

When rotated fully counter clockwise, the Fathom IWS's output will be fully muted. When at the "0" or straight up position, the Variable gain level matches the Reference level setting. When turned fully clockwise, the Fathom IWS's output level is 15 dB higher than the Reference setting.

## Lights

The "Lights" selector switch allows the user to select one of three indicator light modes.

"Off" turns off all of the front panel LED's at all times.

"Dim" sets all of the front panel LEDs to a low brightness level when the Fathom IWS is turned on.

"On" sets all of the front panel LEDs to full brightness level when the Fathom IWS is turned on.

**IMPORTANT: WHEN TROUBLESHOOTING OR CALIBRATING THE A.R.O. FEATURE, MAKE SURE THAT THE "LIGHTS" SWITCH IS SET TO "DIM" or "ON."**

## LP Filter

The Low Pass (LP) Filter selector switch determines the operating mode of the Fathom IWS's built-in low pass filter.

"Off" defeats the low pass filter, completely removing this circuit from the signal path.

"12 dB" sets the roll off slope of the low pass filter to a 12 dB per octave slope (Butterworth alignment).

"24 dB" sets the roll off slope of the low pass filter to a 24 dB per octave slope (Linkwitz-Riley alignment).

The 24 dB setting more aggressively attenuates high frequencies above the LP Frequency setting (see below). If you are using the Fathom IWS's built-in low pass filter, experiment with the LP Filter slope setting to achieve the best transition to your satellite speakers. If you prefer to use the filters and bass management features in your receiver or preamplifier, defeat the on-board filter by selecting the "Off" position.

If the Fathom IWS enclosure is placed close to the listening position, it may be very easy to localize the sub's output. Experiment with the low pass filter to make the subwoofer less easy to localize.

## LP Freq

The Low Pass (LP) Frequency selector knob allows the user to choose the roll-off frequency of the Fathom IWS's internal low pass filter. The frequency is variable between 30 Hz (full counter-clockwise) to 130 Hz (full clockwise). This knob does not affect the input signal in any way if the LP Filter switch is set to "Off". 80 Hz is a commonly used filter frequency and usually serves as a good starting point for adjustments.

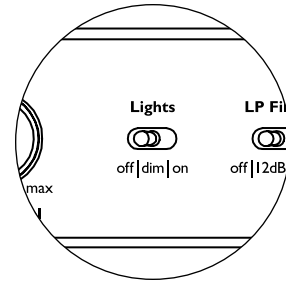
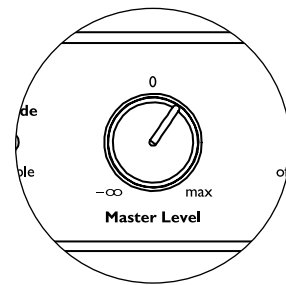

IMPORTANT

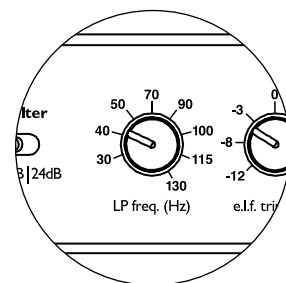
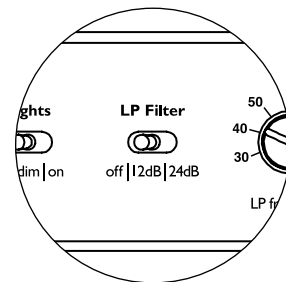

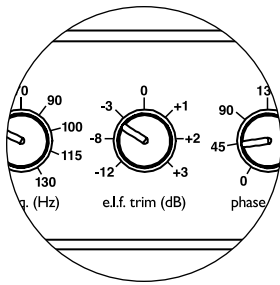

### E.L.F. Trim

The Extreme Low Frequency (“e.l.f. trim”) knob allows the user to apply a certain amount of signal equalization at 23 Hertz (extremely low bass). At full counterclockwise rotation, the signal at 23 Hz is cut by 12 dB. At “0” the equalizer is set flat for zero contribution to the signal. At full clockwise rotation, the signal at 28 Hz is boosted by 3 dB.

The E.L.F. Trim feature is useful for tailoring the Fathom IWS’s very low frequency output for your particular room. Adding some boost can make certain material more exciting. Using the cut function can help to compensate for room or boundary gain in the low frequencies. Room boundaries and the room’s finite (limited) size naturally cause very low frequencies to be boosted relative to other parts of the signal. As such, using the E.L.F. Trim feature to cut the lowest frequencies can help to tame “bloat” or unnatural sounding low bass in small to medium sized rooms (and can also reduce unwanted vibrations in the room or throughout the house).

The E.L.F. function affects frequencies 2 to 3 times higher than the 23 Hz specification. This frequency tapering effect may reduce the overall output of the subwoofer and require the user to increase the Main Level control after adjusting the E.L.F. Trim.

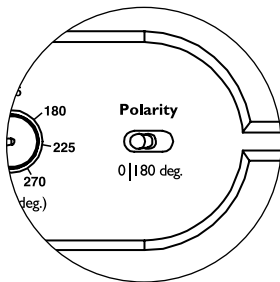

### Polarity

The Polarity switch allows the user to select between normal (0 deg) and reversed (180 deg) signal polarity. The Polarity switch will primarily affect the small frequency range around the crossover point between your subwoofer and satellite speakers.

Unlike the Phase control, which effectively adds time delay, the Polarity switch produces an instantaneous reversal of the signal’s amplitude peaks. For example, if at a given reference point a sine wave has an amplitude peak, by flipping the phase switch you instantly convert that peak into a trough or amplitude dip. Because the effect of the Polarity switch is immediate, it compliments the operation of the Phase control and cannot be replaced by it.

When placing your Fathom IWS in the room, experiment with the Polarity switch before adjusting the “Phase” control. Either position of the Polarity switch may provide a smoother transition between your Fathom IWS subwoofer and the satellite speakers. Use source material with good mid and upper bass content for evaluation.

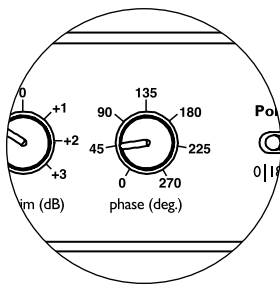

### Phase

The Phase control knob allows the user to adjust the “timing” of the subwoofer output relative to the main speakers. The Phase control will primarily affect the small frequency range around the crossover point between your subwoofer and satellite speakers. The Phase control’s labels are referenced to 80 Hz since this is the most common crossover point between satellite speakers and a subwoofer. Phase settings between 0 degrees (full counter-clockwise rotation) and 270 degrees (full clockwise rotation) are possible.

Speaker, subwoofer, and listening seat positions vary greatly in home theater installations. Since physical positioning of speakers relative to the room boundaries and each other greatly affects the perceived quality of sound output, sometimes it is helpful to delay the subwoofer output. This is exactly what occurs when you turn the Phase control beyond 0 degrees.

Once your Fathom IWS has been placed in your listening room to give you the smoothest overall sound and after you have determined the optimum “Polarity” switch position (see preceding section), experiment with the position of the Phase control. Using familiar source material with good mid and upper bass content, adjust the Phase control and listen for better defined mid-bass and a smoother transition between the subwoofer and satellite speaker systems. If no single setting sounds better than another, leave the Phase control at 0 degrees.

## CONNECTING YOUR Fathom IWS

### Balanced Inputs

If your home-theater receiver or preamplifier/processor provides balanced outputs, the Fathom IWS amp's balanced inputs are the preferred connection. Balanced connections are used extensively in professional studios and sound reinforcement applications for a number of very good reasons. Besides ensuring proper grounding between components, balanced signal transmission is designed to cancel induced cable noise from the surrounding environment (particularly important with long cable runs). The bottom line is that your system will be far less likely to exhibit humming or other extraneous noises if you use balanced connections.

The Fathom IWS subwoofers feature individual left and right balanced input connections with XLR "combo" jacks. These special jacks accept either a three-pin male XLR connector or a "tip-ring-sleeve" (TRS) 1/4-inch (6.3 mm) connector for compatibility with a wide range of equipment.

For systems with a mono subwoofer or "LFE" channel connection, only the jack labeled "Left or Mono" will be used. This applies to most modern multi-channel receivers and preamplifier/processors. Separate left and right input jacks are provided for systems without a dedicated mono subwoofer connection. This typically applies to two-channel audio equipment.

Appropriate balanced cables are available from your JL Audio dealer and are not included with the Fathom IWS.

#### Technical Notes:

- Do not use the balanced inputs with unbalanced signals via adaptors. The unbalanced inputs of the Fathom IWS are optically isolated and preferable in situations where only an unbalanced signal source is available. Balanced input impedance is **10 kohms**.
- Input connectors are configured according to Audio Engineering Society recommendations for balanced signal cables as follows:

#### XLR Connection

- Pin 1: Shield
- Pin 2: Positive
- Pin 3: Negative

#### TRS connection:

- Tip: Positive
- Ring: Negative
- Sleeve: Shield

**IMPORTANT: IF YOUR RECEIVER OR PREAMPLIFIER/PROCESSOR DOES NOT HAVE XLR OR 1/4-INCH TRS BALANCED OUTPUTS, PLEASE REFER TO THE "UNBALANCED INPUTS" SECTION ON PAGE 17 FOR INPUT CONNECTION INFORMATION. DO NOT ATTEMPT TO CONNECT UNBALANCED OUTPUTS TO THE Fathom IWS'S BALANCED INPUTS VIA ADAPTORS.**

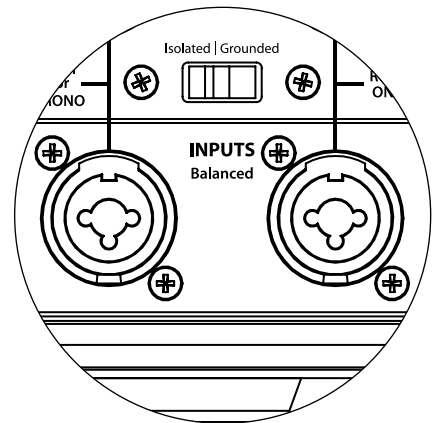

*The Left and Right inputs on the Fathom IWS are internally summed to a single mono channel. Since the Fathom IWS is inherently a "mono" or single channel device, you can use the Left and Right inputs for the master Fathom IWS and then distribute the summed mono signal to additional slave Fathom IWSs in the system.*



IMPORTANT



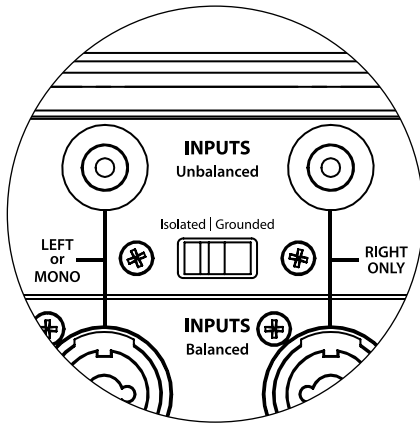

IMPORTANT



### Unbalanced Inputs

The Fathom IWS subwoofer amp features individual left and right unbalanced RCA-type input connectors. These are the most commonly used connectors for home audio applications and must be used if your receiver or preamplifier/processor does not provide balanced outputs. While unbalanced connections are not as noise-immune as a balanced connection, Fathom IWS subwoofers employ optical isolation on the unbalanced inputs to minimize the possibility of noise in your system.

For systems with a mono subwoofer or “LFE” channel connection, only the RCA-type jack labeled “Left or Mono” will be used. This applies to most modern multi-channel receivers and preamplifier / processors. Separate left and right RCA-type input jacks are provided for systems without a dedicated mono subwoofer connection. This typically applies to two-channel audio equipment.

### Technical Notes:

- When balanced outputs are not available on the signal source, you must use the RCA-type unbalanced inputs. Fathom IWSs feature optical isolation circuitry on the unbalanced inputs to minimize the likelihood of ground loop induced noise. Unbalanced input impedance is **10 kohms**.
- Connections are industry-standard for unbalanced signal cables as follows:

#### RCA-type connection:

Tip: Positive

Sleeve: Negative

**IMPORTANT:** IF NOISE EXISTS AFTER CONNECTION, Fathom IWS AMPS ALLOW FOR GROUNDING OR ISOLATION OF THE UNBALANCED INPUTS. PLEASE REFER TO THE “INPUT MODE SWITCHES” SECTION ON PAGE 20 OF THIS MANUAL FOR FURTHER INFORMATION ON MINIMIZING NOISE.

### Input Mode Switches:

Two switches are located on the rear panel to control unbalanced signal grounding and master/slave operation.

#### “Grounded / Isolated” Switch

The “Grounded / Isolated” Input Mode switch **affects only the unbalanced RCA inputs** and is designed to facilitate a quiet, hum-free connection to your audio or home theater system. This feature is included to deal with the signal grounding issues often encountered in home theater systems when several components from different manufacturers are interconnected.

The Fathom IWS ships with this switch in the “Isolated” mode. If, with all system components connected and turned on (but no source material playing), you hear a continuous low-frequency hum through your Fathom IWS, flip this switch to the “Grounded” position and evaluate the difference in the noise level. Use whichever switch position provides the least hum or noise.

**IMPORTANT: PLEASE NOTE**

THAT CHANGING ANY COMPONENT IN THE OPTIMIZED SYSTEM (RECEIVER, AMPLIFIER, DVD PLAYER, CABLE OR SATELLITE BOX, ETC.) COULD ALTER THE SIGNAL GROUNDING SCHEME AND CAUSE HUM TO APPEAR IN YOUR PREVIOUSLY QUIET SYSTEM. IF YOU ADD OR CHANGE AN UPSTREAM COMPONENT IN YOUR HOME THEATER SYSTEM, YOU MAY NEED TO REVISIT THIS INPUT MODE SETTING ON THE Fathom IWS SUBWOOFER FOR OPTIMUM NOISE PERFORMANCE. CABLE & SATELLITE BOXES ARE PARTICULARLY TROUBLESOME IN THIS WAY.

#### Master / Slave Switch

The Fathom IWSs are designed to easily accommodate the implementation of multiple subwoofers in your home theater system through a Master/Slave connection chain. This method allows you to utilize the signal processing features of one Fathom IWS to centrally control multiple Fathom IWSs in the room. Master/Slave functionality also makes it possible for the A.R.O. system to optimize the response of a multiple subwoofer installation.

The Fathom IWS ships with this switch in the “Master” position. If you are using a single Fathom IWS you will use the “Master” position and you need not concern yourself with this section any further.

If your installation incorporates two or more Fathom IWS amplifiers, you will designate one Fathom IWS as the “Master” and all others in the system as “Slave” via the “Master/Slave” switch on the rear amplifier panel of each Fathom IWS. LED’s on the front panel of the Fathom IWS are provided to indicate whether the “Master” or “Slave” mode is selected for a given subwoofer.

From the Fathom IWS operating in “Master” mode, the “Output to Slave” signal carries any signal processing selected on the Master Fathom IWS (including the Master Level setting and A.R.O. processing) to further Fathom IWSs operating in “Slave” mode. “Slave” subwoofer signal processing and level controls will be inoperable. In this mode, the user does not have to worry about level, crossover, and other settings for the slave subwoofers.

#### Technical Notes:

- Selecting the “Slave” position defeats all user-definable signal processing and the master level control. Because of this, there are some special situations in which you may want to operate a single Fathom IWS in “Slave” mode. If you are utilizing outboard signal processing and level-matching controls, activating the “Slave” mode will prevent anyone from affecting system parameters with the manual controls on the Fathom IWS.

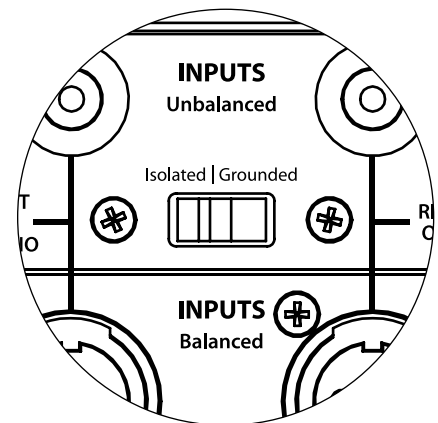

IMPORTANT

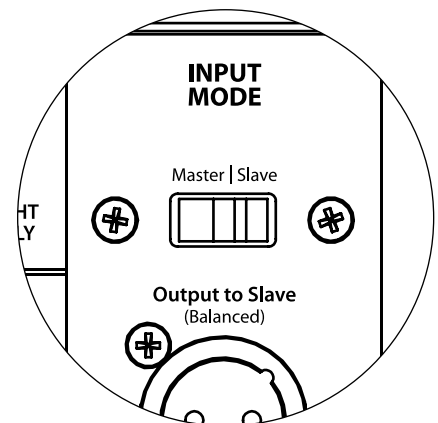

IMPORTANT



**IMPORTANT:** PLEASE REFER TO THE “SYSTEM CONNECTION DIAGRAMS” ON PAGES 26-29 FOR MORE INFORMATION ON USING THE INPUT / OUTPUT CONNECTIONS.

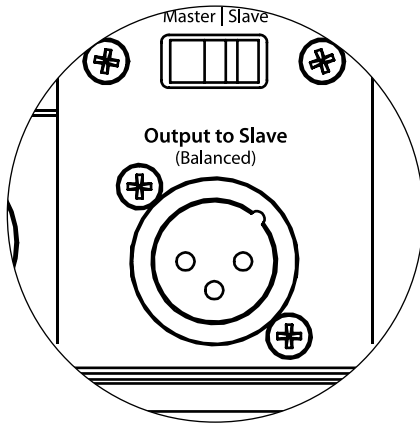

### “Output to Slave” Connector

If you are operating more than one Fathom IWS subwoofer in one home theater system, you will designate one Fathom IWS as the Master (see page 20), and then feed signal from it to the remaining “Slave” Fathom IWSs via this balanced XLR output. The “Output to Slave” cable can be connected to the “Left or Mono” balanced XLR input on the next Fathom IWS. When a Fathom IWS is in “Slave” Mode, its “Output to Slave” connection can be used to pass signal to further Fathom IWSs operating in “Slave” mode.

### The “Output to Slave” connector is designed to be used as follows:

- 1) From the “Master” Fathom IWS’s “Output to Slave” connector to the first “Slave” Fathom IWS’s “Left or Mono” XLR balanced input.
- 2) From the first “Slave” Fathom IWS’s “Output to Slave” connector to the second “Slave” Fathom IWS’s “Left or Mono” XLR balanced input.
- 3) From the second “Slave” Fathom IWS’s “Output to Slave” connector to the third “Slave” Fathom IWS’s “Left or Mono” XLR balanced input. Etc, etc. (up to ten Fathom IWSs may be connected in this configuration).

Appropriate balanced cables with XLR terminations are available from your JL Audio dealer and are not included with the Fathom IWS.

### Technical Notes:

- The “Output to Slave” signal carries any signal processing selected on the Master Fathom IWS (including the Master Level setting and A.R.O. processing) to further Fathom IWSs operating in “Slave” mode.
- From Fathom IWSs operating in “Slave” mode, the “Output to Slave” signal is an exact, buffered replica of the balanced input signal, making this method of signal distribution preferable to using Y-adapters or splitters.
- Use only shielded, connection cables with high quality XLR connectors for Master/Slave connection. Never use unbalanced cables with adaptors.

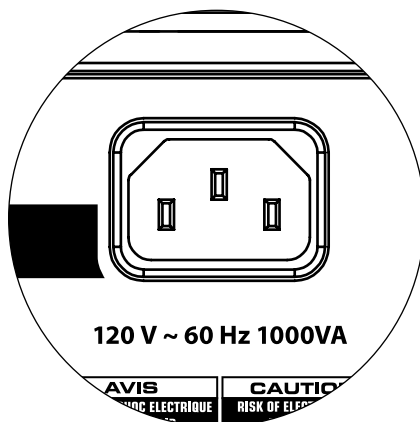

### IEC-Style AC Connector

The IEC-style AC cord receptacle receives the heavy-gauge, 6 ft. (1.8 m) long, power cord included with your Fathom IWS subwoofer. Your Fathom IWS should only be powered from a 120 V AC, 60 Hz outlet. Do not use any AC power cord other than the one supplied with the Fathom IWS.

The Fathom IWS subwoofer is a very powerful device and can draw a lot of current. If too many components are connected with a Fathom IWS subwoofer to one electrical outlet, you risk tripping a household circuit breaker during very demanding program material. If this happens, split the Fathom IWS and other components between two AC electrical circuits. If possible, for maximum performance, dedicate an AC circuit to each Fathom IWS.

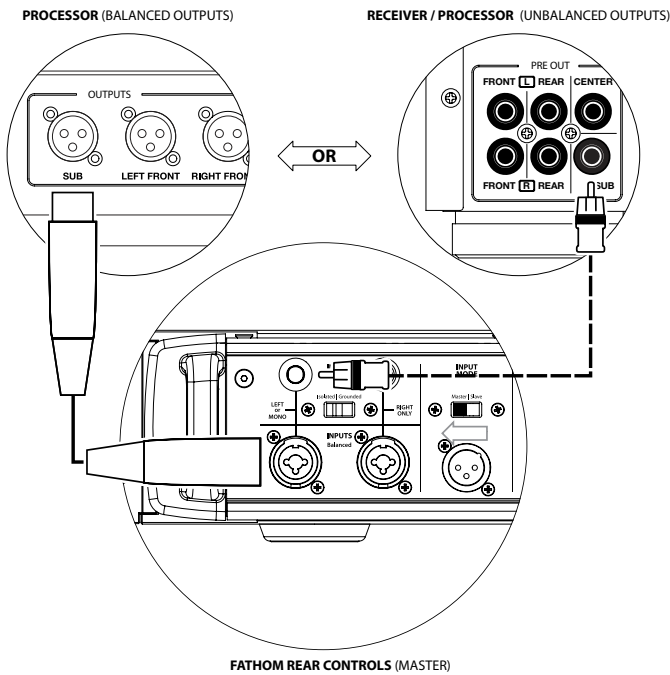

**SYSTEM CONNECTION DIAGRAM 1:  
One Fathom IWS to  
Home Theater Receiver or  
Home Theater Preamp/Processor**

Most home theater receivers and preamp/processors provide a single (mono) subwoofer output. When connecting a mono subwoofer output to your Fathom IWS, you will only use the Fathom IWS's "Left or Mono" input.

Two connection types are available for connecting the Fathom IWS to your home theater system: balanced (XLR or 1/4-inch TRS connector) and unbalanced (RCA-type connector). Balanced connections provide superior noise rejection and ensure proper grounding between components. If your receiver or processor has balanced outputs, we highly recommend that you use them.

In the connection diagram at left, balanced connections are shown as solid lines, unbalanced connections are shown dotted. You will only use one of these input connection methods (not both).

**WARNING!** TURN OFF THE Fathom IWS AND ALL OTHER EQUIPMENT IN THE SYSTEM BEFORE MAKING OR CHANGING ANY CONNECTIONS!



WARNING

**SYSTEM CONNECTION DIAGRAM 2:  
Multiple Fathom IWSs to  
Home Theater Receiver or  
Home Theater Preamp/Processor**

To greatly simplify using multiple subwoofers in a single home theater system, Fathom IWSs incorporate a “Master/Slave” signal distribution system. This allows control of all the Fathom IWSs in a system from a single “Master” unit.

First, you will select one of the Fathom IWS subwoofers as the “Master” via its upper “Input Mode” switch. Generally, you will designate the Fathom IWS closest to the receiver/preamp as the master. In some cases; for example, when the control panel of certain units is difficult to access, you may prefer to designate the one which is easiest to access as the master.

Two connection types are available for connecting the master Fathom IWS to your home theater system: balanced (XLR or 1/4-inch TRS connector) and unbalanced (RCA-type connector). Balanced connections provide superior noise rejection and ensure proper grounding between components. If your receiver or processor has balanced outputs, we highly recommend that you use them to connect to the Fathom IWS designated as the master.

In the connection diagram at right, balanced connections are shown as solid lines, unbalanced connections are shown dotted. You will only use one of these input connection methods for the Fathom IWS designated as the master (not both).

The remaining Fathom IWSs in the system will be configured as “Slave” units via their “Input Mode” switches. Using balanced XLR cables, you will connect the master Fathom IWS’s “Output to Slave” to the “Left or Mono” balanced input of the first slave Fathom IWS. That slave unit’s “Output to Slave” connector will feed the “Left or Mono” input of the next slave unit via another balanced XLR cable. Subsequent slave units will be connected in the same manner.



**IMPORTANT**

*Connections between the “Master” and “Slave” Fathom IWSs and between “Slave” Fathom IWSs are via balanced XLR cables ONLY.*

**WARNING**



**WARNING! TURN OFF THE Fathom IWS(S) AND ALL OTHER EQUIPMENT IN THE SYSTEM BEFORE MAKING OR CHANGING ANY CONNECTIONS!**

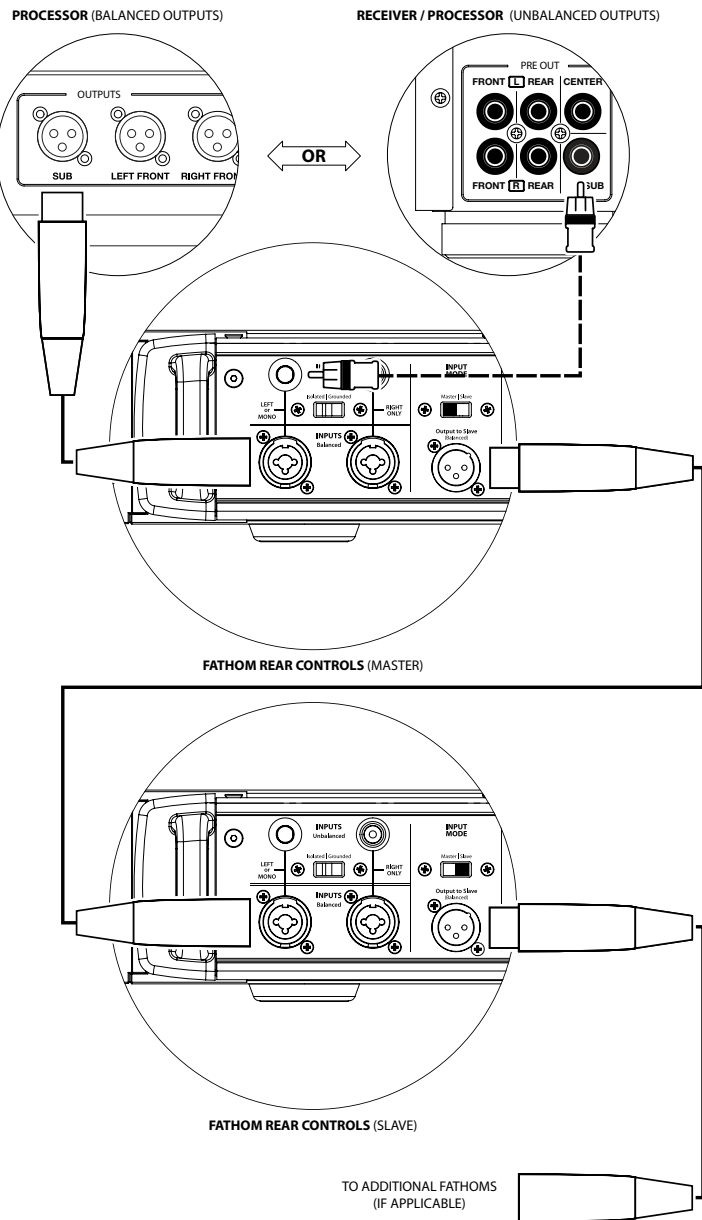

STEREO ACTIVE CROSSOVER (BALANCED OUTPUTS)

STEREO ACTIVE CROSSOVER (UNBALANCED OUTPUTS)

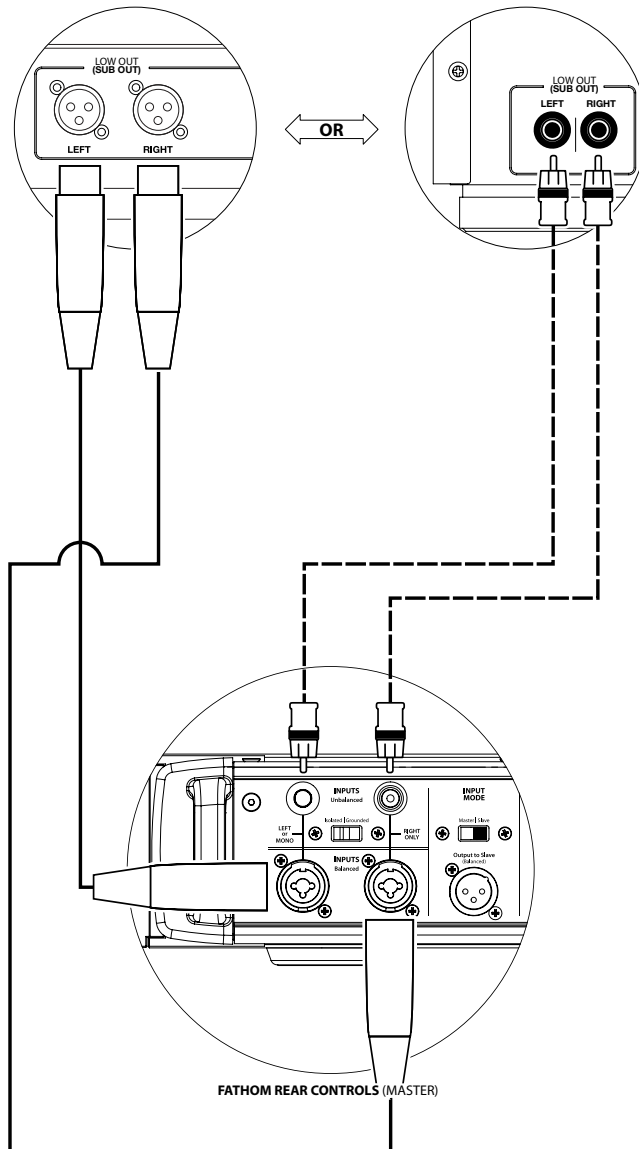

### SYSTEM CONNECTION DIAGRAM 3: One Fathom IWS in Mono to Two-Channel Audio System

When connecting a Fathom IWS (or multiple Fathom IWSs) in mono to a two-channel audio system you will use both the “Left or Mono” and the “Right” inputs. Summing circuitry in the Fathom IWS’s input section will sum the stereo signals to mono.

We strongly recommend that you use a high-quality active crossover to divide your preamplifier’s signals prior to connection to the Fathom IWS and to the amplifier driving your main speakers. This will allow you to filter low frequencies out of the signals driving the main speakers, resulting in better performance.

If you are not using an active crossover and are comfortable running your main speakers full-range, you can split your preamplifier’s output signals using appropriate Y-connectors in place of the active crossover shown in the diagram.

Two connection types are available for connecting the Fathom IWS to your two-channel audio system: balanced (XLR or 1/4-inch TRS connector) and unbalanced (RCA-type connector). Balanced connections provide superior noise rejection and ensure proper grounding between components. If your preamplifier or active crossover offers balanced outputs, we highly recommend that you use them.

In the connection diagram at left, balanced connections are shown as solid lines, unbalanced connections are shown dotted. You will only use one of these input connection methods (not both).

**NOTE:** If desired, additional Fathom IWSs can be connected in “Slave” mode to the Fathom IWS connected as shown on this diagram. See “Connection Diagram 2” on page 23 for slave connection explanation.

**WARNING!** TURN OFF THE Fathom IWS AND ALL OTHER EQUIPMENT IN THE SYSTEM BEFORE MAKING OR CHANGING ANY CONNECTIONS!



WARNING

**SYSTEM CONNECTION DIAGRAM 4:  
Two Fathom IWSs in Stereo to  
Two-Channel Audio System**

When connecting two Fathom IWSs in stereo to a two-channel audio system you will only use the “Left or Mono” inputs of each Fathom IWS. The “Input Mode” switch on each Fathom IWS will be set in the “Master” position.

We strongly recommend that you use a high-quality active crossover to divide your preamplifier’s signals prior to connection to the Fathom IWS and to the amplifier driving your main speakers. This will allow you to filter low frequencies out of the signals driving the main speakers, resulting in better performance.

If you are not using an active crossover and are comfortable running your main speakers full-range, you can split your preamplifier’s output signals using appropriate Y-connectors in place of the active crossover shown in the diagram.

Two connection types are available for connecting the Fathom IWSs to your two-channel audio system: balanced (XLR or 1/4-inch TRS connector) and unbalanced (RCA-type connector). Balanced connections provide superior noise rejection and ensure proper grounding between components. If your preamplifier or active crossover offers balanced outputs, we highly recommend that you use them.

In the connection diagram at right, balanced connections are shown as solid lines, unbalanced connections are shown dotted. You will only use one of these input connection methods (not both).

**NOTE:** If desired, additional Fathom IWSs can be connected in “Slave” mode to each Fathom IWS connected as shown on this diagram. See “Connection Diagram 2” on page 23 for slave connection explanation.

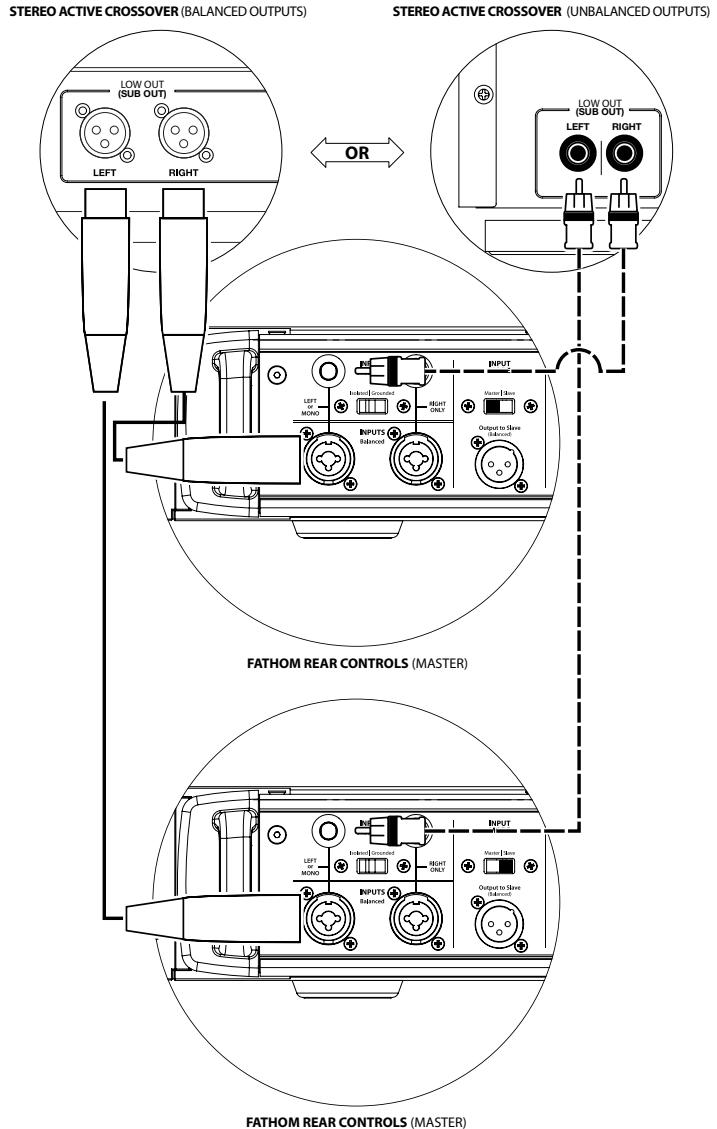

**WARNING!** TURN OFF THE Fathom IWS(S) AND ALL OTHER EQUIPMENT IN THE SYSTEM BEFORE MAKING OR CHANGING ANY CONNECTIONS!

## RECOMMENDED SETUP PROCEDURES

1) Preparation for Setup Process: .....	24-25
2) Apply A.R.O: .....	26-27
3) Level Setting: .....	27
4) Polarity/Phase Adjustment: .....	28
5) Adjust E.L.F. Trim: .....	28

### PREPARATION FOR SETUP PROCESS:

Please confirm the following system settings before beginning the setup process. This will ensure a neutral starting point and an effective setup of your subwoofer system.

#### On your Home Theater Receiver or Preamp/Processor:

Before beginning setup of your Fathom IWS subwoofer system we recommend that you set your receiver or preamp/processor as follows:

##### 1. Speaker Size

In the speaker setup menu of your receiver or preamp/processor, set up all of your high-frequency speakers as “small” with a crossover point of 80 Hz. This will send ALL bass to the Fathom IWS(s).

##### 2. Speaker Distance

In the speaker setup menu, properly set all speaker distances to the primary listening seat, including the subwoofer’s distance. Use a tape measure to determine these distances (time coherence is important.) If multiple Fathom IWSs are being used, average their distances to the primary listening seat and use that number to set the subwoofer distance.

##### 3. Subwoofer Level

Set the subwoofer level in the receiver or preamp/processor “0” or its middle position.

##### 4. Tone Controls / Equalizers

Set all tone controls to “0” and defeat all equalizer features.

#### On your Active Crossover or Bass Management Processor:

If you are using an active crossover or bass-management processor, we recommend that you set it as follows before beginning setup of your Fathom IWS subwoofer system (please turn off all Fathom IWSs in the system prior to making these adjustments):

##### 1. Low-Pass Filter Frequency

Select a low-pass filter frequency of 80 Hz (12dB/octave slope)

##### 2. High-Pass Filter Frequency

Select a high-pass filter frequency of 80 Hz (12dB/octave slope)

##### 3. Low-Pass (Subwoofer) Output Level

Set the subwoofer output level to “0” or its middle position.



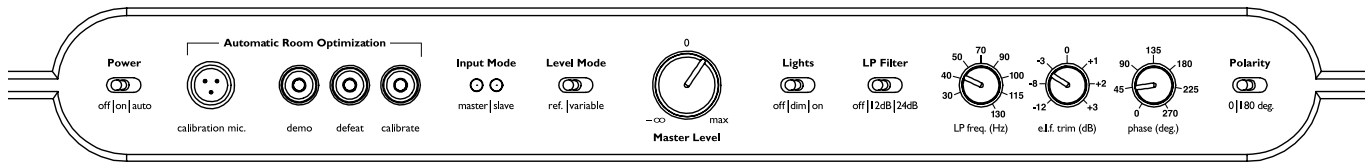

### On the Fathom IWS's Front Panel:

Please turn off the home theater receiver or preamp/processor to make these adjustments.

#### 1. "Power" Switch

Flip each Fathom IWS's "Power" switch to the "On" position.

#### 2. "Lights" Switch

Flip each Fathom IWS's "Lights" switch to the "On" position. If you don't see any lights on the front panel, you may have forgotten to plug the Fathom IWS in or there may be a problem with the electrical circuit.

#### 3. "Input Mode" Indicator Lights

If you are using a single Fathom IWS, confirm that its "Input Mode" indicator light is on the "Master" position. If not, you will need to access the "Input Mode" switch on the rear panel of the Fathom IWS.

If you are using multiple Fathom IWSs in a Master/Slave configuration, confirm that the unit connected directly to your receiver or preamp/processor is indicating "Master" on its "Input Mode" lights and that all other units are indicating "Slave" on their "Input Mode" lights. If not, you will need to access the "Input Mode" switches on the rear panels of the Fathom IWSs.

#### 3. "Level Mode" Switch

Flip the master Fathom IWS's "Level Mode" switch to the "REF" position.

#### 4. "LP Filter" Switch

If your home theater receiver/processor is handling bass management (speakers set on "small") or if you are using an outboard crossover/bass-management processor, flip the master Fathom IWS's "LP Filter" switch to "OFF." If not, select the "12 dB" position.

#### 5. "LP Freq. (Hz)" Knob

Rotate the "LP Freq." knob to the "80 Hz" position.

#### 6. "e.l.f. trim (dB)" Knob

Rotate the "e.l.f. trim" knob to "0"

#### 7. "Polarity" Switch

Flip the "Polarity" switch to "0".

#### 8. "phase (deg.)" Knob

Rotate the "phase" knob to "0" degrees

#### 9. A.R.O. Defeat Switch

Press the A.R.O. defeat switch so that the red light in the switch remains lit.

## RECOMMENDED SETUP PROCEDURES *(continued)*

### Subwoofer System Setup:

Once you have set the controls on your home theater receiver or preamp/processor and on your Fathom IWS(s) to the settings recommended on pages 24-25, you are ready to begin setting up your Fathom IWS for optimum performance.

**In some systems, the Fathom IWS amplifier will be installed away from the listening environment. For these cases, the ARO microphone cable will not be long enough to perform the Calibration.**

To facilitate Calibration with the Fathom IWS amplifier in the listening room, the Fathom IWS subwoofer enclosure includes front-mounted speaker terminals (standard banana jacks - see figure). These terminals will allow the user to temporarily connect the amplifier to the enclosure for Calibration, even after the enclosure is permanently installed in the wall cavity.

If your system has a Master / Slave configuration, you only need to have the amplifier designated as Master located in the listening room. You must run a temporary XLR cable to the remotely located Slave unit(s).

### 1) Applying Automatic Room Optimization (A.R.O.)

You are now ready to apply the power of JL Audio's exclusive Automatic Room Optimization system. This system will measure the response of the subwoofer at your primary listening seat and apply a powerful equalizer to tame the peaks caused by room modes, resulting in smoother, more accurate bass performance. If you are using multiple Fathom IWSs in a master/slave configuration, you will only need to address the unit designated as "Master" to perform A.R.O. calibration for the entire subwoofer system. Note that all front-panel signal processing is defeated during A.R.O. calibration, regardless of the knob settings. Normal operation is restored once calibration is complete.

- a) Set the Main Power switch to the "ON" position and be sure the Fathom IWS's indicator lights are switched "ON" via the "Lights" switch.
- b) Remove the calibration microphone from its protective pouch and connect its cable to the mini-XLR jack on the Fathom IWS's front control panel.

**NOTE:** A.R.O. Calibration is only possible when the included JL Audio test microphone is plugged in to the Fathom IWS front panel. The "Calibrate" feature is disabled with no microphone plugged in to prevent accidental loss of settings.

- c) Connect the microphone to the other end of the mic cable and temporarily place the mic in the primary listening seat. If you have a microphone stand, you can place the microphone at head height and position in the primary listening seat.
- d) On the Fathom IWS's control panel, press the "Calibrate" button. The green light on the "Calibrate" button will flash slowly, indicating that calibration will begin in 5 seconds.



IMPORTANT

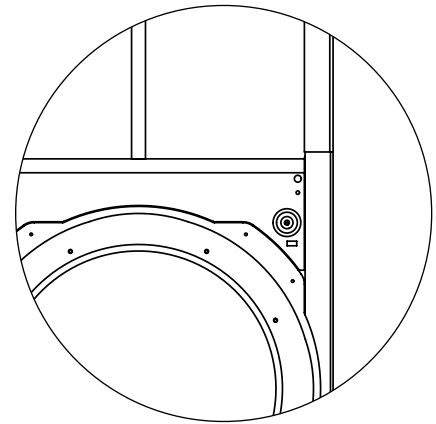

IMPORTANT



**IMPORTANT!** MAKE SURE THE ROOM IS QUIET DURING A.R.O. CALIBRATION! TURN OFF ANY NOISY APPLIANCES NEAR THE LISTENING ROOM (DISHWASHERS, WASHING MACHINES, ETC.)

IT IS PARTICULARLY IMPORTANT TO TURN OFF AIR CONDITIONERS OR HEAT PUMPS DURING CALIBRATION. THESE FORCED-AIR-TYPE HVAC SYSTEMS CAN CREATE MODERATE LEVELS OF 15 – 20 HZ NOISE THAT MAY INTERFERE WITH CALIBRATION.

- e) Within 5 seconds of pressing the “Calibrate” button, return to your primary listening seat and hold the microphone in your **normal, seated head position at the approximate height of your ears.**
- f) A noise sequence will be played through the Fathom IWS that sounds like hashy static (like when your old FM radio was between stations). The sequence will last approximately 3 minutes. During this process, the A.R.O. system is taking a frequency response measurement at your seat and correcting the problems it finds. The A.R.O. system also compensates for any before & after level differences so that your subwoofer will have a similar perceived loudness after the calibration process. When A.R.O. is finished calibrating, the “Calibrate” button will light and stay on, indicating a successful calibration.

Should you wish to run a new calibration, simply repeat the steps above.

**To clear the A.R.O.’s settings (i.e., return them to flat) & turn off the Calibrate light, press and hold the Demo button and then press the Defeat button.** Please note that you must perform this button sequence quickly. If you hold the Demo button for more than 2 seconds without touching the Defeat button, the Demo tones will start. Should this happen, simply wait for the Demo sequence to end and try again. You can perform a new calibration by following the normal procedure outlined above.

## 2) Level Setting

Using familiar music or movie material with deep bass content, adjust the subwoofer level to blend with the other speakers using your receiver or preamp / processor’s subwoofer level control. This method is more immune to tampering than using the Fathom IWS’s “Master Level” knob (think toddlers or curious visitors).

In the unlikely event that the subwoofer level control in your receiver or preamp/processor cannot be turned up enough to level match the Fathom IWS, return that control to “0”. Then, flip the Fathom IWS’s “Level Mode” switch to “Variable” and with “0” as your reference point (REF mode gain and Variable “0” gain are identical) use the “Master Level” control to level match the subwoofer with the other speakers. **MAKE NOTE OF THIS SETTING FOR FUTURE USE.**

For more detailed information on your Fathom IWS’s level setting controls, please refer to the “Level Mode” and “Master Level” sections on pages 15 - 16 of this manual.

### 3) Polarity and Phase Adjustment

It is often helpful to have a second person operating these controls so that you can easily hear the changes from the primary listening seat.

Listening to familiar source material (preferably music with good upper bass and midbass response), flip the “Polarity” switch from “0” to “180” and listen for differences. The correct setting will sound most natural with the best upper bass punch and articulation. If both sound similar, choose “0”.

Once Polarity is set, use the same music material to audition different “Phase” control settings and choose the one that further enhances the upper and midbass response. If you can’t hear a difference, set the control to “0.”

### 4) Extreme Low Frequency (e.l.f.) Trim

Use the “e.l.f. trim” control to adjust the extreme low bass extension of the Fathom IWS. This control allows -12 dB of cut or +3 dB of boost at 28 Hertz and is particularly useful when using a Fathom IWS (or two) in a small to medium sized home theater. Since smaller enclosed spaces help to boost the level of the lowest bass frequencies, smaller theaters can be overwhelmed by the strong low-bass output of the Fathom IWS subwoofer. This can create a “thick” or “bloated” character in the lower bass region. Turning down the “e.l.f. trim” knob cuts the extreme low bass level and alleviates this condition. Feel free to experiment and listen to a variety of demanding material until you find the best match for your room and your tastes.

**Your Fathom IWS is now optimized for maximum bass performance at your listening seat. Congratulations!**

**IMPORTANT!** WRITE DOWN ALL SETTINGS PERFORMED IN STEPS 2-4 FOR FUTURE REFERENCE.



IMPORTANT

**IMPORTANT!** IF YOU MOVE YOUR PRIMARY LISTENING SEAT IN THE FUTURE, YOU WILL NEED TO RUN A.R.O. AGAIN. ANY PARTICULAR CALIBRATION IS UNIQUE TO THAT PARTICULAR SUBWOOFER POSITION AND LISTENING SEAT POSITION COMBINATION. SIMPLY FOLLOW THE STEPS ABOVE TO CREATE A NEW CALIBRATION CURVE.



IMPORTANT

## FREQUENTLY ASKED QUESTIONS

### **Is the Fathom IWS magnetically shielded?**

Fathom IWS subwoofers are not magnetically shielded. To avoid magnetic distortion with certain television types, place the Fathom IWS at least 3-4 feet (1 - 1.5m) from your screen.

### **Will my electric bill be high if I leave the Fathom IWS in “Auto” mode?**

When in “Auto” mode, the Fathom IWS amplifier is only powered up when a significant signal is detected on the inputs. When powered down, only “housekeeping” circuits remain on, which draw negligible amounts of power from the wall (less than 10 watts).

### **Should I unplug my subwoofer during a thunderstorm or extended absence?**

YES. You should unplug your Fathom IWS during (or before) thunderstorms. This will prevent any possible damage from voltage spikes due to lightning. In these conditions, it's a good idea to unplug all of your audio / video components. If you are going to be away from home for several days, it is also a good idea to unplug your home theater components to prevent damage from unexpected storms or power line conditions.

## TROUBLESHOOTING

### No sound from subwoofer.

1. Verify that Fathom IWS amp is plugged in, turned “ON” & that front panel lights are “ON”. If the Fathom IWS amp will not power up, check the circuit breaker that feeds its outlet.
2. Test subwoofer using DEMO button on front panel of amp– if sub emits demo tones the subwoofer’s internal circuitry is fine and an input problem is likely. Check the input cable connections at the Fathom IWS amp and at the receiver/preamp/processor.
3. Verify that your receiver’s subwoofer settings have not changed.
4. If your other speakers play, but the Fathom IWS does not, try changing the cable that connects the Fathom IWS to the system.
5. If the problem persists, call your dealer or JL Audio Technical Support for assistance.

### The bass level has changed.

1. Make sure your level settings (on the Fathom IWS amp and in your receiver/preamp/processor) have not changed.
2. If you are using the Fathom IWS’s “Master Level” knob to set the subwoofer level, confirm that the “Level Mode” switch is set to “Variable”.
3. Verify the position of the ELF Trim knob.

### Hums or other unusual noises from your Fathom IWS

1. See Input Mode discussion on page 20 of this manual, especially if any upstream components, cables, etc., have recently changed.
2. Turn off the Fathom IWS, disconnect all its input and output signal cables, turn the Fathom IWS back on. If the noise disappears, the noise is being caused elsewhere in your system - reconnect cables one at a time to help locate the problem.

### Bass sounds “muddy” or “too heavy”.

1. Try decreasing the 23 Hertz level using the ELF Trim control. Muddy bass can sometimes be caused by too much low frequency output in a moderately sized room.
2. Decrease the overall subwoofer level.
3. Verify your receiver’s subwoofer settings.
4. Try a different main listening seat location. Changing your seating location can have a HUGE effect on how your system sounds. See the placement discussion on pages 6-10 of this manual.

### A.R.O. Calibration attempt gives fast blinking Calibrate light

1. Be sure that the included JL Audio Microphone is properly plugged into the front panel jack. Calibration will ONLY proceed with the JL Audio microphone connected. Connecting any other mic will cause the calibration to fail.
2. If calibration fails with the JL Audio microphone properly connected, try running calibration again with the microphone placed ~ 6 feet away from the Fathom IWS speaker enclosure. If calibration fails again, the microphone or microphone cable is bad and will need to be replaced. Contact JL Audio Customer Service.

## LIMITED WARRANTY / SERVICE INFORMATION

JL AUDIO warrants this product to be free of defects in materials and workmanship for a period of **three (3) years** from the original date of purchase.

Damage caused by the following is not covered under warranty: accident, misuse, abuse, product modification or neglect, failure to follow installation instructions, unauthorized repair attempts, misrepresentations by the seller. This warranty does not cover incidental or consequential damages and does not cover the cost of removing or reinstalling the unit(s) or shipping the unit(s) to JL Audio for service. Cosmetic damage due to accident or normal wear and tear is not covered under warranty.

This warranty is not transferable and applies only to the original purchaser of the product from an authorized JL AUDIO dealer. Warranty is voided if the factory-applied product serial number is removed or defaced.

Should service be necessary under this warranty for any reason due to manufacturing defect or malfunction, JL AUDIO will, at its discretion, repair or replace the defective product with new or remanufactured product at no charge.

Any applicable implied warranties are limited in duration to the period of the express warranty as provided herein beginning with the date of the original purchase at retail, and no warranties, whether express or implied, shall apply to this product thereafter. Some states do not allow limitations on implied warranties, therefore these exclusions may not apply to you. This warranty gives you specific legal rights, and you may also have other rights which vary from state to state.

WARNING



**WARNING:** THIS PRODUCT CONTAINS NO USER-SERVICEABLE PARTS. PRODUCT IN WHICH DISASSEMBLY, REPAIR AND/OR MODIFICATION HAS BEEN ATTEMPTED BY UNAUTHORIZED PARTIES WILL NOT BE COVERED UNDER WARRANTY.

### **If you need service on your JL AUDIO product:**

All warranty returns should be sent to JL AUDIO freight prepaid through an authorized JL AUDIO dealer and must be accompanied by proof of purchase (a copy of the original sales receipt.) Direct returns from consumers or non-authorized dealers will be refused unless specifically authorized by JL AUDIO with a valid return authorization number. Warranty expiration on products returned without proof of purchase will be determined from the manufacturing date code. Coverage may be invalidated as this date is previous to purchase date. Return only defective components. Non-defective items received will be returned freight-collect. Customer is responsible for shipping charges and insurance in sending the product to JL AUDIO. Freight damage on returns is not covered under warranty. Always include proof of purchase (sales receipt).

### **For Service Information in the U.S.A. please call:**

JL Audio customer service:

(954) 443-1100 during normal business hours (Eastern Time)

JL Audio, Inc • 10369 North Commerce Parkway, Miramar, FL 33025

### **International Warranties:**

Products purchased outside the United States of America are covered only by that country's distributor and not by JL Audio, Inc.

# FATHOM® IWS

## FEATURES

### Unbalanced Inputs:

Stereo or Mono (two RCA jacks - Input Impedance of 10k Ohms)

### Balanced Inputs:

Stereo or Mono (two female XLR jacks - Input Impedance of 10k Ohms)

### Output To Slave:

Balanced (one male XLR jack)

### Input Modes:

Master or Slave

### Level Modes:

Reference (fixed gain) or Variable from full mute to +15dB over reference gain

### Power Modes:

Off, On or Automatic Signal-Sensing

### Light Modes:

Off, On or Dim

### Low Pass Filter Mode:

Off, 12 dB per octave or 24 dB per octave

### Low Pass Filter Cutoff Frequency:

Variable from 30 Hz – 130 Hz

### Polarity:

0 or 180 degrees

### Phase:

Variable from 0 – 270 degrees

### E.L.F. Trim:

Variable from -12 dB to +3 dB at 23 Hz

**Automatic Room Optimization (A.R.O.)** with included laboratory-grade calibration microphone, defeatable.

Specifications	IWS-SYS-1 Fathom IWS home subwoofer	IWS-SYS-2 Fathom IWS home subwoofer
Enclosure Type:	Single Sealed Enclosure	Two Sealed Enclosures
Driver(s):	13.5-inch (nominal diameter)	13.5-inch (nominal diameter) in each of two enclosures
Frequency Response (anechoic):	26 Hz - 101 Hz (+/- 1.5 dB) -3dB at 25 Hz / 112 Hz -10dB at 22 Hz / 150 Hz	26 Hz - 101 Hz (+/- 1.5 dB) -3dB at 25 Hz / 112 Hz -10dB at 22 Hz / 150 Hz
Effective Piston Area:	98.26 sq. in. / 0.0634 sq. m.	196.51 sq. in. / 0.1268 sq. m.
Effective Displacement:	147.3 cu. in. (2.41 liters)	294.6 cu. in. (4.82 liters)
Amplifier Power:	1000 watts RMS short-term	2000 watts RMS short-term
Grille Dimensions: (H) Height x (W) Width x (D) Depth	17.25 inches x 20 inches 438 mm x 508 mm	
Wall Opening Dimensions: (W) Width x (H) Height	14.5 inches x 17.25 inches 368 mm x 438 mm	
Amplifier Dimensions: (H) Height x (W) Width x (D) Depth Height Dimensions DO NOT include feet.	3.5 in. x 17.4 in. x 17.9 in. 89 mm x 442 mm x 455 mm	
Amplifier Net Weight:	35 lbs. (15.9 kg)	43 lbs. (19.5 kg)
Cabinet Finish:	Black Texture-Coated	Black Texture-Coated
Grille Finish:	White (paintable)	

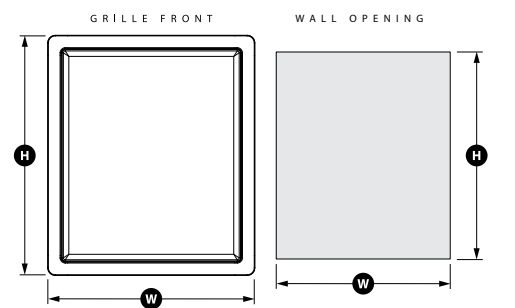
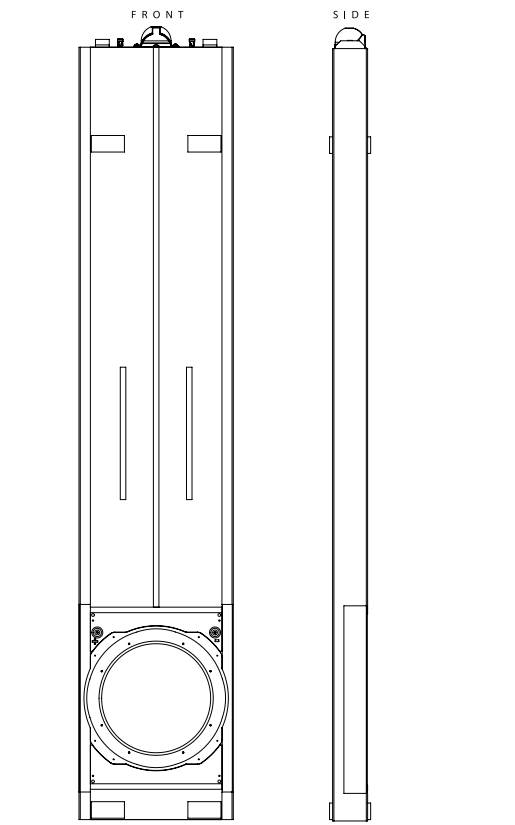
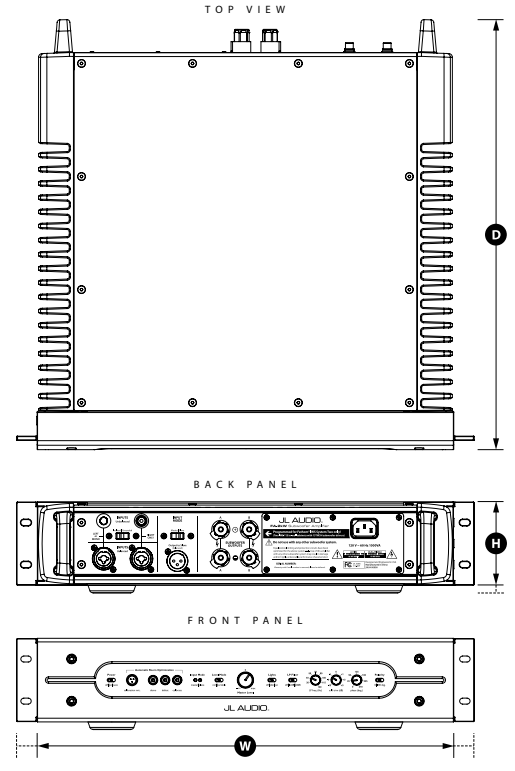

"JL Audio", "Fathom IWS" and the JL Audio logo are registered trademarks of JL Audio, Inc., "Ahead of the Curve" is a trademark of JL Audio, Inc. Due to continuous product development, all specifications are subject to change without notice.

Printed in USA • ©2010 JL Audio, Inc. • U.S. PATENTS: #5,734,734 #5,949,898 #6,118,884 #6,229,902 #6,243,479 #6,294,959 #6,501,844 #6,496,590 #6,441,685 #5,687,247 #6,219,431 #6,625,292 #D472,891 #D480,709 Other U.S. & Foreign patents pending. For more detailed information please visit us online at [www.jlaudio.com](http://www.jlaudio.com).

10369 North Commerce Parkway • Miramar, Florida • 33025 • USA

SKU-011310-04-2010



## Free Manuals Download Website

<http://myh66.com>

<http://usermanuals.us>

<http://www.somanuals.com>

<http://www.4manuals.cc>

<http://www.manual-lib.com>

<http://www.404manual.com>

<http://www.luxmanual.com>

<http://aubethermostatmanual.com>

Golf course search by state

<http://golfingnear.com>

Email search by domain

<http://emailbydomain.com>

Auto manuals search

<http://auto.somanuals.com>

TV manuals search

<http://tv.somanuals.com>