



**JL AUDIO e2150**  
two-channel full-range amplifier  

---

owner's manual

*Thank you for purchasing a JL Audio amplifier for  
your automotive sound system.*

*Your amplifier has been designed and manufactured to exacting standards in order to ensure years of musical enjoyment in your vehicle. For maximum performance and extended warranty coverage, we highly recommend that you have your new amplifier installed by an authorized JL Audio dealer. Your authorized dealer has the training, expertise and installation equipment to ensure optimum performance from this product. Should you decide to install the amplifier yourself, please take the time to read this manual thoroughly so as to familiarize yourself with its installation requirements and setup procedures.*

*If you have any questions regarding the instructions in this manual or any aspect of your amplifier's operation, please contact your authorized JL Audio dealer for assistance. If you need further assistance, please call the JL Audio Technical Support Department at (954) 443-1100 during business hours (Eastern Time Zone).*



## PROTECT YOUR HEARING!

We value you as a long-term customer. For that reason, we urge you to practice restraint in the operation of this product so as not to damage your hearing and that of others in your vehicle. Studies have shown that continuous exposure to high sound pressure levels can lead to permanent (irreparable) hearing loss. This and all other high-power amplifiers are capable of producing such high sound pressure levels when connected to a speaker system. Please limit your continuous exposure to high volume levels.

While driving, operate your audio system in a manner that still allows you to hear necessary noises to operate your vehicle safely (horns, sirens, etc.).

## SERIAL NUMBER

In the event that your amplifier requires service or is ever stolen, you will need to have a record of the product's serial number. Please take the time to enter that number in the space provided below. The serial number can be found on the bottom panel of the amplifier and on the amplifier packaging.

Serial Number: \_\_\_\_\_

## INSTALLATION APPLICATIONS

This amplifier is designed for operation in vehicles with 12V, negative-ground electrical systems. Use of this product in vehicles with positive ground and/or voltages other than 12V may result in damage to the product and will void the warranty.

This product is **not** certified or approved for use in aircraft.

Do not attempt to "bridge" the outputs of this amplifier with the outputs of a second amplifier; including an identical one.

## PLANNING YOUR INSTALLATION

It is important that you take the time to read this manual and that you plan out your installation carefully. The following are some considerations that you must take into account when planning your installation.

### Cooling Efficiency Considerations:

The outer shell of your JL Audio amplifier is designed to remove heat from the amplifier circuitry. For optimum cooling performance, this outer shell should be exposed to as large a volume of air as possible. Enclosing the amplifier in a small, poorly ventilated chamber can lead to excessive heat build-up and degraded performance. If an installation calls for an enclosure around the amplifier, we recommend that this enclosure be ventilated with the aid of a fan. In normal applications, fan-cooling is not necessary.

## ! IMPORTANT

**Mounting the amplifier upside down is strongly discouraged.**

If mounting the amplifier under a seat, make sure there is at least 1 inch (2.5 cm) of space above the amplifier's outer shell to permit proper cooling.

### Safety Considerations:

Your amplifier needs to be installed in a dry, well-ventilated environment and in a manner which does not interfere with your vehicle's safety equipment (air bags, seat belt systems, ABS brake systems, etc.). You should also take the time to securely mount the amplifier using the supplied screws so that it does not come loose in the event of a collision or a sudden jolt to the vehicle (8 lbs. of aluminum traveling at 60 MPH will hurt you).

### Stupid Mistakes to Avoid:

- Check before drilling any holes in your vehicle to make sure that you will not be drilling through a gas tank, brake line, wiring harness or other vital vehicle system.
- Do not run system wiring outside or underneath the vehicle. This is an extremely dangerous practice which can result in severe damage to your vehicle and person.
- Protect all system wires from sharp metal edges and wear by carefully routing them, tying them down and using grommets and loom where appropriate.
- Do not mount the amplifier in the engine compartment, under the vehicle, on the roof or in any other area that will expose the amplifier circuitry to the elements.

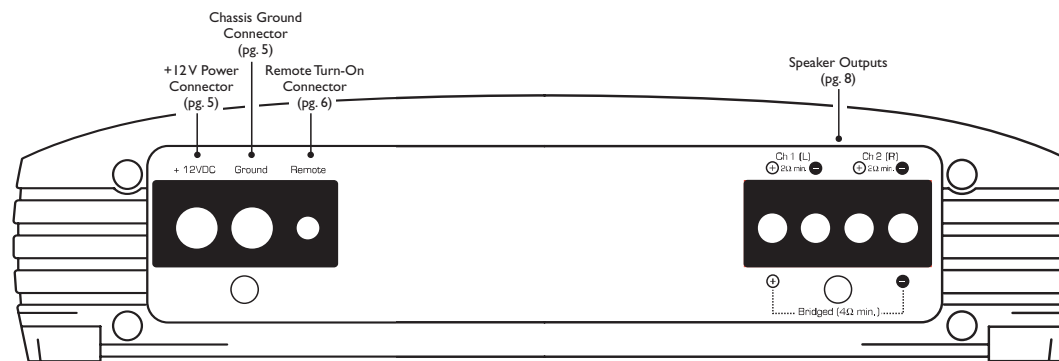
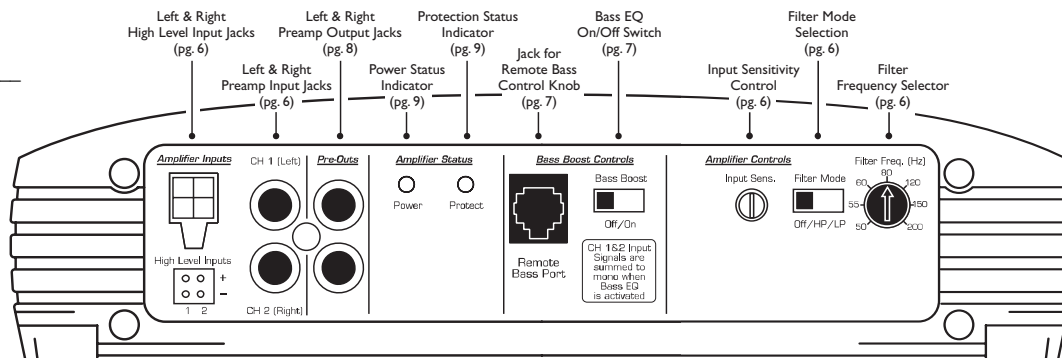

## PRODUCT DESCRIPTION

The JL Audio e2150 is a two-channel full-range amplifier utilizing patented Absolute Symmetry™ Class AB technology for both channels.

The e2150 can be operated with a wide variety of source units and system configurations.

## TYPICAL INSTALLATION SEQUENCE

The following represents the sequence for a typical amplifier installation, using an aftermarket source unit. Additional steps and different procedures may be required in some applications. If you have any questions, please contact your authorized JL Audio dealer for assistance.

1) Disconnect the negative battery post connection and secure the disconnected cable to prevent accidental re-connection during installation. **This step is not optional!**

2) Run power wire (minimum 8 AWG) from the battery location to the amplifier mounting location, taking care to route it in such a way that it will not be damaged and will not interfere with vehicle operation. Use 4 AWG or larger power wire and a power distribution block if additional amplifiers are being installed with the e2150.

3) Connect power wire to the positive battery post. Fuse the wire with an appropriate fuse block (and connectors) within 18 inches (45 cm) wire length of the positive battery post. **This fuse is essential to protect the vehicle. Do not install the fuse until the power wire has been connected to the amplifier.**

4) Run signal cables and remote turn-on wire from the source unit to the amplifier mounting location.

5) Run speaker wire from the speaker systems to the amplifier mounting location.

6) Find a good, solid metal grounding point close to the amplifier and connect the negative power wire to it using appropriate hardware. Use the same size power wire as the wire connected to the "+12V" connection (min. 8 AWG), no longer than 36 inches (90 cm) from the amplifier to the ground connection point. In some vehicles, it may be necessary to upgrade the battery ground wire. (See page 5 for important notice).

7) Securely mount the amplifier using the supplied screws.

8) Connect the positive and negative power wires to the amplifier. A fuse near the amplifier is not necessary.

9) Connect the remote turn-on wire to the amplifier.

10) Connect the input cables to the amplifier.

11) Connect the speaker wires to the amplifier.

12) Carefully review the amplifier's control settings to make sure that they are set according to the needs of the system.

13) Install the power wire fuse (20A for a single e2150) and reconnect the negative battery post terminal.

14) Turn on the source unit at a low level to double-check that the amplifier is configured correctly. Resist the temptation to crank it up until you have verified the control settings.

15) Make necessary adjustments to the input sensitivity controls to obtain the right overall output and the desired balance in the system. See Appendix A (page 10) for the recommended input sensitivity setting method.

16) Enjoy the fruits of your labor with your favorite music.

## POWER CONNECTIONS

Before installing the amplifier, disconnect the negative (ground) wire from the vehicle's battery. This will prevent accidental damage to the system, the vehicle and your body during installation.

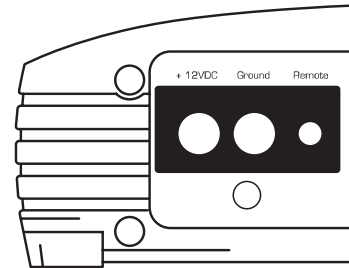

The e2150's "+12VDC" and "Ground" connections are designed to accept 8 AWG - 4 AWG power wire. **8 AWG is a minimum power wire size for this amplifier.**

If you are installing the e2150 with other amplifiers and wish to use a single main power wire, use 4 AWG or larger main power wire (depending on the overall current demands of all the amplifiers in the system). This 4 AWG or larger power wire should terminate into a distribution block mounted as close to the amplifiers as possible and should connect to the e2150 with 8 AWG - 4 AWG power wire.

Please note that smaller AWG numbers mean bigger wire and vice-versa (1/0 AWG is the largest, 2 AWG is smaller, then 4 AWG, then 8 AWG, etc.).

To connect the power wires to the amplifier, first back out the set screw on the top of the terminal block, using the supplied 2.5 mm hex wrench. Strip 1/2 inch (12 mm) of insulation from the end of each wire and insert the bare wire into the terminal block, seating it firmly so that no bare wire is exposed. While holding the wire in place, tighten the set screw firmly, taking care not to strip the head of the screw.

The ground connection should be made using the same gauge wire as the power connection and should be kept as short as possible, while accessing a solid piece of sheet metal in the vehicle. The surface of the sheet metal should be sanded at the contact point to create a clean, metal-to-metal connection between the chassis and the termination of the ground wire. The use of a star washer to lock down the connection is advisable.

Any wires run through metal barriers (such as firewalls), must be protected with a high quality rubber grommet to prevent damage to the insulation of the wire. Failure to do so may result in a dangerous short circuit.

## ! IMPORTANT

Many vehicles employ small (10 AWG - 6 AWG) wire to ground the battery to the vehicle chassis and to connect the alternator's positive connection to the battery. To prevent voltage drops, these wires should be upgraded to 4 AWG when installing amplifier systems with main fuse ratings above 60A.

## FUSE REQUIREMENTS

It is absolutely vital that the main power wire(s) to the amplifier(s) in the system be fused within 18 inches (45 cm) of the positive battery post connection. The fuse value at each power wire should be high enough for all of the equipment being run from that power wire. If only the e2150 is being run from that power wire, we recommend a 20A fuse be used. AGU (big glass fuse) or MaxiFuse™ (big plastic-body fuse) types are recommended.

No fuse is required or recommended directly before the amplifier power connection. If one is desired, we recommend the use of a 20A AGU fuse or MaxiFuse™ type.

## TURN-ON LEAD

The e2150 uses a conventional +12V remote turn-on lead, typically controlled by the source unit's remote turn-on output. The amplifier will turn on when +12V is present at its "Remote" input and turn off when +12V is switched off. If a source unit does not have a dedicated remote turn-on output, the amplifier's turn-on lead can be connected to +12V via a switch that derives power from an ignition-switched circuit.

The e2150's "Remote" turn-on connector is designed to accept 18 AWG – 12 AWG wire. To connect the remote turn-on wire to the amplifier, first back out the set screw on the top of the terminal block, using the supplied 2.5 mm hex wrench. Strip 1/2 inch (12mm) of wire and insert the bare wire into the terminal block, seating it firmly so that no bare wire is exposed. While holding the wire in the terminal, tighten the set screw firmly, taking care not to strip the head of the screw and making sure that the wire is firmly gripped by the set screw.

## INPUT SECTION

The e2150 has one input section with two distinct input connection options. These are:

- 1) A pair of traditional RCA type connections designed to accept input from source units with line level outputs.
- 2) A four-pin connector designed to accept input from amplified sources such as factory source units or source units not equipped with line level outputs.

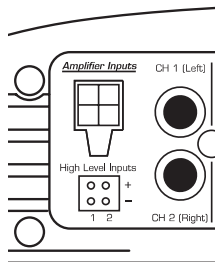

## AMPLIFIER CONTROLS

### Input Sensitivity

This control, labeled "Input Sens.," can be used to match the source unit's output voltage to the input stage of the e2150 for maximum clean output. Rotating the control clockwise will result in higher sensitivity (louder for a given input voltage). Rotating the control counter-clockwise will result in lower sensitivity (quieter for a given input voltage.)

To properly set the amplifier for maximum clean output, please refer to Appendix A (page 10). After using this procedure, you can then adjust the "Input Sens." level downward if this is required to achieve the desired system balance.

**Do not increase any "Input Sens." setting for any channel(s) of any amplifier in the system beyond the maximum level established during the procedure outlined in Appendix A (page 10). Doing so will result in audible distortion and possible speaker damage.**

### Filter Controls

Most speakers are not designed to reproduce the full range of frequencies audible by the human ear. For this reason, most speaker systems are comprised of multiple speakers, each dedicated to reproducing a specific frequency range. Filters are used to select which frequency range is sent to each section of a speaker system. The division of frequency ranges to different speakers can be done with passive filters (coils and/or capacitors) between the amplifier outputs and the speakers), which are acceptable and commonly used for filtering between mids and tweeters. Filtering between subwoofer systems and satellite speaker systems is best done with active filters, which cut off frequency content at the input to the amplifier. Active filters are more stable than passive filters and do not introduce extraneous resistance, which can degrade subwoofer performance.

The active filter built into the e2150 can be used to eliminate potentially harmful and/or undesired frequencies from making their way through the amplifier section to the speaker(s). This serves to improve tonal balance and to avoid distortion and possible speaker failure. Correct use of this filter can substantially increase the longevity and fidelity of your audio system.

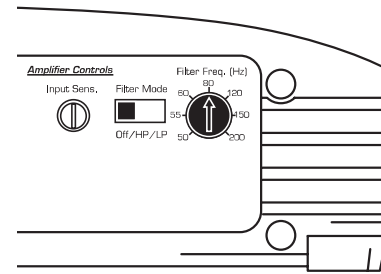

1) "Filter Mode" Control: The e2150 employs a 12dB per octave filter. This filter can be configured into one of two filter types or defeated completely by way of the three-position "Filter Mode" switch: "Off": Defeats the filter completely, allowing the full range of frequencies present at the inputs to feed the amplifier. This is useful for systems utilizing outboard crossovers or requiring full-range reproduction from the e2150.

"LP" (Low-Pass): Configures the filter to attenuate frequencies above the selected filter frequency at a rate of 12dB per octave. Useful for connection of subwoofer(s) to the e2150 in a bi-amplified system.

"HP" (High-Pass): Configures the filter to attenuate frequencies below the selected filter frequency at a rate of 12dB per octave. Useful for connection of coaxial or component satellite speaker systems to the e2150 in a bi-amplified system.

2) "Filter Freq. (Hz)" The filter frequency markings surrounding this rotary control are for reference purposes and are generally accurate to within 1/3 octave or better. If you would like to select the filter cutoff frequency with a higher level of precision, consult the chart in Appendix B (page 11).

**Tuning Hint:** If you are using the e2150 to drive a subwoofer system ("LP" mode) or a component satellite speaker system ("HP" mode), 100 Hz is a good baseline "Filter Freq. (Hz)" setting. After properly adjusting the "Input Sens.," as outlined in Appendix A (page 10), you can fine tune the "Filter Freq. (Hz)" control to achieve the desired system frequency response.

## BASS BOOST CONTROLS

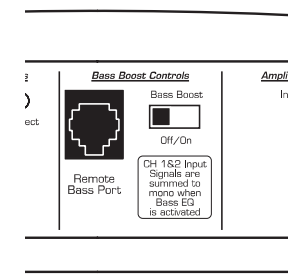

1) **Bass Boost:** This switch allows the user to activate a 6 dB boost centered at 48 Hz. When the "Bass Boost" is activated, the inputs to "CH 1 (Left)" and "CH 2 (Right)" are summed to create a mono signal. The "Filter Mode" switch in the "Channel 1 & 2" section must be in the "LP" position for the bass boost to be functional.

2) **Remote Bass Port:** This port allows you to connect an optional remote boost knob (sold separately, JL Audio Model RBC-1) that can be mounted in the front of the vehicle. With the RBC-1 connected, the boost is no longer limited to 0 or +6 dB, allowing a range of 0 - 12 dB of boost to be selected.

## PRE-OUTS

The e2150's "Pre-Outs" connectors output unprocessed (pass-through) left and right channel preamp level signals, permitting connection of additional amplifiers in a system.

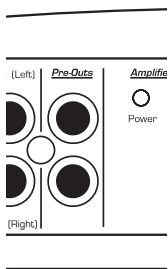

When using either the line level inputs (RCA input connections) or the "High Level Inputs" (four-pin connector), the output signals are identical to the input signals. If the "High Level Inputs" are used, the signal present at the "Pre-Outs" can still be sent to another JL Audio amplifier. In either case, the "Pre-Outs" signals are not affected by any settings in the "Amplifier Controls" or "Bass Boost Controls" sections.

## SPEAKER OUTPUTS

The e2150's speaker outputs are designed to accept 8 AWG - 16 AWG wire.

The e2150 is designed to deliver power into speaker loads equal to or greater than  $2\Omega$  when using a "stereo" configuration and speaker loads equal to or greater than  $4\Omega$  when using a "bridged" configuration.

To connect the speaker wires to the amplifier, first back out the set screws on the top of the terminal block, using the supplied 2.5 mm hex wrench. Strip 1/2 inch (12 mm) of insulation from the end of each wire and insert the bare wire into the terminal block, seating it firmly so that no bare wire is exposed. While holding the wire in place, tighten the set screw firmly, taking care not to strip the head of the screw.

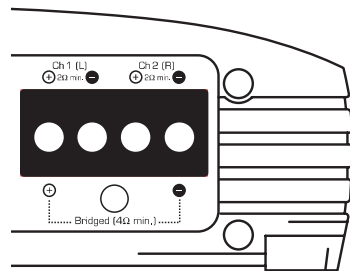

### ! IMPORTANT

Speaker loads below  $2\Omega$  nominal per channel are not recommended and may cause the amplifier to initiate a protection mode and shut itself off.

## BRIDGING CONSIDERATIONS

Bridging is the practice of combining the output of two amplifier channels to drive a single load. When bridged, each channel produces signals of equal magnitude, but opposite polarity. The combined output of the two channels provides twice the output voltage available from a single channel. The e2150 has been designed for bridging of its two channels without the need for input inversion adaptors.

To bridge the e2150's two channels, use the "Ch1 +" and "Ch2 -" speaker connectors only (the "Ch1 -" and "Ch2 +" remain unused). When bridged, the e2150 will deliver optimum power into a  $4\Omega$  load.

### ! IMPORTANT

When bridged, the e2150 will deliver 150W x 1 into a  $4\Omega$  load or 90W x 1 into an  $8\Omega$  load.

**Operating a bridged e2150 into a load lower than  $4\Omega$  is not recommended.**

Because a bridged pair of channels requires that both channels receive input, you need to connect both left and right inputs to the source unit. Connection of only one input will result in reduced power output, increased distortion and can cause the amplifier to overheat. **Do not do this!**

When the e2150 is operating in bridged mode, the output will be in mono (only one channel). This mono channel can contain right channel only information, left channel only information or the sum of the information from both the right and left

channels. In order to achieve one of these options, configure the inputs in one of these two ways:

### 1) Left Channel Only or Right Channel Only

**Information:** If you wish to send a Left-only or Right-only signal to the e2150, use a "Y-Adaptor" to split the single channel signal into both left and right RCA inputs (or parallel-connect both positive and both negative high-level input connections to a single channel source signal). This option is useful when using one e2150 to drive the left channel speakers only and another e2150 to drive right channel speakers only.

### ! IMPORTANT

When parallel-connecting both positive and both negative high-level input connections as described above, make sure to connect negative (-) wires to negative (-) wires and positive (+) wires to positive (+) wires.

**2) Left + Right Channel Information:** When bridged and fed by a stereo input, the e2150 will automatically combine the left and right channels into a summed mono (left + right) channel. This option is useful when using the e2150 to drive a subwoofer system or a summed mono center channel.

## AMPLIFIER STATUS INDICATOR LIGHTS / PROTECTION CIRCUITRY

There are two status indicator lights on the input / control end of the amplifier:

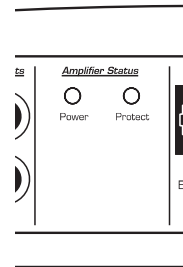

1) "Power" (Green): lights to indicate that the amplifier is turned on and operating normally.

2) "Protect" (Red): lights or flashes to indicate that the amplifier protection circuitry has been activated to prevent product failure.

a) If the red "Protect" indicator lights steadily (without flashing), the amplifier has exceeded its safe operating temperature. This causes the amplifier to shut off in order to protect its circuitry. When the amplifier's temperature drops to a safe level, the red "Protect" indicator will shut off and the amplifier will return to normal operation.

b) If the red "Protect" indicator flashes intermittently, the protection circuitry has detected a short-circuit or a dangerously low impedance connected to the amplifier output(s). Connecting the speaker outputs to an impedance lower than  $2\Omega$  stereo ( $4\Omega$  bridged) will cause this protection mode to activate. The amplifier's output may cycle on and off when this protection mode is activated. When the problem is eliminated, the amplifier will return to normal operation.

## SERVICING YOUR JL AUDIO AMPLIFIER

If your amplifier fails or malfunctions, please return it to your authorized JL Audio dealer so that it may be sent in to JL Audio for service. There are no user serviceable parts or fuses inside the amplifier. The unique nature of the circuitry in the JL Audio amplifiers requires specifically trained service personnel. Do not attempt to service the amplifier yourself or through unauthorized repair facilities. This will not only void the warranty, but may result in the creation of more problems within the amplifier.

If you have any questions about the installation or setup of the amplifier not covered in this manual, please contact your dealer or the **JL AUDIO Technical Department** for assistance:

(954) 443-1100

9:00 AM – 5:30 PM Eastern Time,  
Monday – Friday

## APPENDIX A:

### Input Sensitivity Level Setting

Following the directions below will allow the installer to adjust the input sensitivity of the amplifier(s) simply and easily in just a few minutes using equipment which is commonly available in installation bays.

#### Necessary Equipment

- Digital AC Voltmeter
- CD with a sine-wave test tone recorded at 0 dB reference level in the frequency range to be amplified for that set of channels (50 Hz for subwoofer channels, 1 kHz for a midrange application). Do not use attenuated test tones (-10 dB, -20 dB, etc.).

#### The Nine-Step Procedure

- 1) Disconnect the speaker(s) from the amplifier's speaker output connectors.
- 2) Turn off all processing (bass/treble, loudness, EQ, etc.) on the source unit, processors (if used) and amplifier. Set fader control to center position and subwoofer level control to 3/4 of maximum (if used to feed the e2150).
- 3) Turn the "Input Sens." control all the way down.
- 4) Set the source unit volume to 3/4 of full volume. This will allow for reasonable gain overlap with moderate clipping at full volume.
- 5) Using the chart on this page, determine the target voltage for input sensitivity adjustment according to the nominal impedance of the speaker system connected to the amplifier outputs.
- 6) Verify that you have disconnected the speakers before proceeding. Play a track with an appropriate sine wave (within the frequency range to be amplified by the e2150) at 3/4 source unit volume.
- 7) Connect the AC voltmeter to the speaker output connectors of the amplifier: If the channel pair is operating in stereo, it is only necessary to measure one channel. If bridged, make sure you test the voltage at the correct connectors (L+ and R-).
- 8) Increase the "Input Sens." control until the target voltage is observed with the voltmeter.

- 9) Once you have adjusted the e2150 to its maximum low-distortion output level, lower the system volume (on the source unit) and reconnect the speaker(s). The "Input Sens." controls can now be adjusted **downward** if the amplifier requires attenuation to achieve the desired system balance.

#### ! IMPORTANT

Do not increase any "Input Sens." setting for any amplifier in the system beyond the maximum level established during this procedure. Doing so will result in audible distortion and possible speaker damage.

It will be necessary to re-adjust the "Input Sens." for the affected channels if any equalizer boost is activated after setting the "Input Sens." with this procedure. This applies to any EQ boost circuit, including source unit tone controls or EQ circuits. EQ cuts will not require re-adjustment.

Nom. Impedance	Target AC Voltage	
	Stereo	Bridged
8Ω	13.4V	26.8V
6Ω	13.4V	25.6V
4Ω	13.4V	24.6V
3Ω	12.8V	not recommended
2Ω	12.3V	not recommended

## APPENDIX B:

### Precise Frequency Selection Chart

"FILTER FREQ" AMP FILTER		
Detent Number	Panel Marking	Actual Freq.
<b>Full counter-clockwise: 53</b>		
01		.53
02	"50"	.53
03		.53
04		.54
05		.54
06		.55
07		.55
08	"55"	.56
09		.56
10		.57
11		.58
12		.59
13		.62
14	"60"	.65
15		.65
16		.66
17		.70
18		.73
19		.77
20	"80"	.81
21		.84
22		.88
23		.94
24		1.01
25		1.04
26	"120"	1.15
27		1.18
28		1.28
29		1.37
30		1.46
31		1.64
32	"150"	1.77
33		1.93
34		1.97
35		2.09
36		2.13
37		2.16
38	"200"	2.18
39		2.25

**Full-clockwise: 225**

## APPENDIX C:

### e2150 Specifications

#### GENERAL SPECIFICATIONS:

Recommended Fuse Value: 20A

Recommended Fuse Type: AGU or MaxiFuse™

#### INPUT SECTIONS:

No. of Inputs: One Stereo Pair

Input Type: Differential, noise-cancelling with RCA jack inputs (low-level) and multi-pin jack (high-level)

Input Range: 200mV - 8V RMS

#### AMPLIFIER SECTION:

Amplifier Topology: Class AB with patented Absolute Symmetry™ dual N-Channel MOSFET output design

Power Supply: Unregulated MOSFET switching type

Rated Power (Stereo):

45W RMS × 2 @ 4Ω (12.5V)

75W RMS × 2 @ 2Ω (12.5V)

Rated Power (Bridged):

90W RMS × 1 @ 8Ω (12.5V)

150W RMS × 1 @ 4Ω (12.5V)

THD at Rated Power: <0.08% @ 4 ohms per channel (20 Hz - 20 kHz)

Signal to Noise Ratio: >104 dB referred to rated power (A-weighted, 20 Hz-20 kHz noise bandwidth)

Frequency Response: 10 Hz - 25 kHz (+0, -1 dB)

Damping Factor: >200 @ 4Ω per ch./50 Hz, >100 @ 2Ω per ch./50 Hz

Slew Rate: ± 22V/μs

#### AMPLIFIER FILTER:

Filter Type: State-variable, 12dB/octave Butterworth with continuously variable cutoff frequency selection from 50-200 Hz. Configurable as Low-Pass or High-Pass. Defeatable.

#### PREAMP OUTPUT:

Pass-through type. Output signal is identical to the signal at the Amp Inputs.

#### DIMENSIONS (LxWxH):

9.8" × 9.25" × 2.36" (250mm × 235mm × 60mm)

Due to ongoing product development, all specifications are subject to change without notice.

### “MY AMPLIFIER DOESN’T TURN ON”

---

**Check** to make sure there is +12V at the “Remote” connection of the amplifier. In some cases, the turn-on lead from the source unit is insufficient to turn on multiple devices and the use of a relay is required. To test for this problem, jump the “+12V” wire to the “Remote” terminal to see if the amplifier turns on. If this does not work, proceed to the next step.

**Check** the fuse, not just visually, but with a continuity meter. It is possible for a fuse to have poor internal connections that cannot be found by visual inspection. It is best to take the fuse out of the holder for testing. If no problem is found with the fuse, inspect the fuse-holder.

### “I GET A DISTORTED / ATTENUATED SOUND COMING OUT OF THE SPEAKER(S)”

---

**Check** the input signal and input signal cables to make sure signal is present at the “Amplifier Inputs” and the cables are not pinched or loose. It may be helpful to try a different set of cables and/or a different signal source to be sure.

### “MY AMPLIFIER SHUTS OFF ONCE IN A WHILE, USUALLY AT HIGHER VOLUMES”

---

**Check** your voltage source and grounding point. The power supply of the e2150 will operate with charging system voltages down to 8V. Shutdown problems at higher volume levels can occur when the charging system voltage drops below 8V. These dips can be of very short duration making them extremely difficult to detect with a common DC voltmeter. To ensure proper voltage, inspect all wiring and termination points. It may also be necessary to upgrade the ground wire connecting the battery to the vehicle’s chassis and the power wire connecting the alternator to the battery. Many vehicles employ small (10 AWG - 6 AWG) wire to ground the battery to the vehicle’s chassis and to connect the alternator to the battery. To prevent voltage drops, these wires should be upgraded to 4 AWG when installing amplifier systems with main fuse ratings above 60A. Grounding problems are the leading cause of mis-diagnosed amplifier failures.

### “MY AMPLIFIER TURNS ON, BUT THERE IS NO OUTPUT”

---

**Check** the input signal using an AC voltmeter to measure the voltage from the source unit while an appropriate test tone is played through the source unit (disconnect the input cables from the amplifier prior to this test). The frequency used should be in the range that is to be amplified by the amplifier (example: 50 Hz for a sub bass application or 1 kHz for a full range / high-pass application). A steady, sufficient voltage (between 0.2 and 8.0V) should be present at the output of the signal cables.

**Check** the output of the amplifier. Using the procedure explained in the previous check item (after plugging the input cables back into the amplifier) test for output at the speaker outputs of the amplifier. Unless you enjoy test tones at high levels, it is a good idea to remove the speaker wires from the amplifier while doing this. Turn the volume up approximately half way. 5V or more should be measured at the speaker outputs. This output level can vary greatly between amplifiers but it should not be in the millivolt range with the source unit at half volume. If you are reading sufficient voltage, check your speaker connections as explained below.

**Check** to ensure that the speaker wires are making a good connection with the metal inside the terminal block. The speaker wire connectors are designed to accept up to 12 AWG wire. Make sure that 1/2 inch (12 mm) of insulation has been stripped from the end of each wire and the bare wire is seated firmly in the terminal block so that no bare wire is exposed.

### “MY AMPLIFIER’S OUTPUT FLUCTUATES WHEN I TAP ON IT OR HIT A BUMP”

---

**Check** the connections to the amplifier. Make sure that the insulation for all wires has been stripped back far enough to allow a good contact area inside the terminal block.

**Check** the input connectors to ensure that they all are making good contact with the input jacks on the amplifier.

### “HOW DO I PROPERLY SET THE INPUT SENSITIVITY ON MY AMPLIFIER”

---

**Please** refer to Appendix A (page 10) to set the input sensitivity for maximum, low-distortion output.

**INSTALLATION NOTES:**

Use this diagram to document your amplifier's switch and control positions.

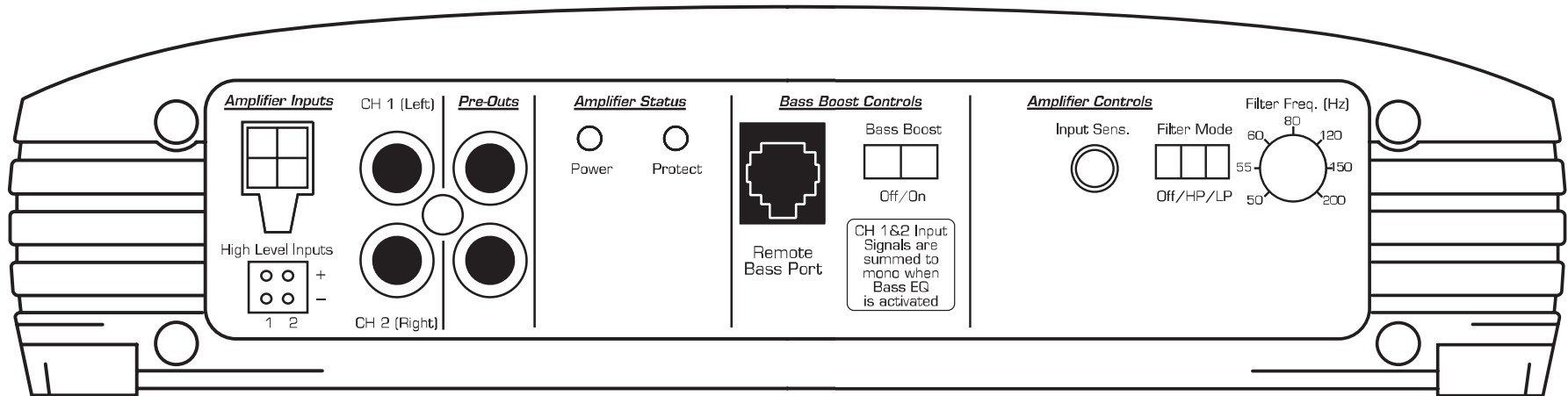



## LIMITED WARRANTY - AMPLIFIERS (USA)

JL AUDIO warrants this product to be free of defects in materials and workmanship for a period of ninety (90) days from the original date of purchase. The warranty term is extended to two (2) years if installation is performed or approved by an authorized JL AUDIO dealer (proof of installation or approval required on purchase receipt).

This warranty is not transferrable and applies only to the original purchaser from an authorized JL AUDIO dealer. Should service be necessary under this warranty for any reason due to manufacturing defect or malfunction, JL AUDIO will (at its discretion), repair or replace the defective product with new or remanufactured product at no charge. Damage caused by the following is not covered under warranty: accident, misuse, abuse, product modification or neglect, failure to follow installation instructions, unauthorized repair attempts, misrepresentations by the seller. This warranty does not cover incidental or consequential damages and does not cover the cost of removing or reinstalling the unit(s). Cosmetic damage due to accident or normal wear and tear is not covered under warranty.

### **Warranty is void if the product's serial number has been removed or defaced.**

Any applicable implied warranties are limited in duration to the period of the express warranty as provided herein beginning with the date of the original purchase at retail, and no warranties, whether express or implied, shall apply to this product thereafter. Some states do not allow limitations on implied warranties, therefore these exclusions may not apply to you. This warranty gives you specific legal rights, and you may also have other rights which vary from state to state.

### **If you need service on your JL AUDIO product:**

All warranty returns should be sent to JL AUDIO 's Amplifier Service Facility freight-prepaid through an authorized JL AUDIO dealer and must be accompanied by proof of purchase (a copy of the original sales receipt). Direct returns from consumers or non-authorized dealers will be refused unless specifically authorized by JL AUDIO with a valid return authorization number.

Warranty expiration on products returned without proof of purchase will be determined from the manufacturing date code. Coverage may be invalidated as this date is previous to purchase date. Non-defective items received will be returned freight-collect. Customer is responsible for shipping charges and insurance in sending the product to JL AUDIO. Freight damage on returns is not covered under warranty.

### **For Service Information in the U.S.A. please call:**

JL Audio customer service: (954) 443-1100  
during normal business hours (9:00 AM – 5:30 PM Eastern Time)

#### **JL Audio, Inc**

10369 North Commerce Pkwy,  
Miramar, FL 33025

(do not send product for repair to this address)

### **International Warranties:**

Products purchased outside the United States of America are covered only  
by that country's distributor and not by JL Audio, Inc.

**Absolute Symmetry™ Class AB Amplifier Circuit is covered by U.S. Patent #6,294,959 and is pending in the countries listed below.** Austria, Belgium, Brazil, Canada, China, France, Germany, Indonesia, Italy, Japan, Republic of Korea, Mexico, Netherlands, Norway, Russian Federation, Singapore, Sweden, Switzerland, United Kingdom, and all other PCT countries.

## Free Manuals Download Website

<http://myh66.com>

<http://usermanuals.us>

<http://www.somanuals.com>

<http://www.4manuals.cc>

<http://www.manual-lib.com>

<http://www.404manual.com>

<http://www.luxmanual.com>

<http://aubethermostatmanual.com>

Golf course search by state

<http://golfingnear.com>

Email search by domain

<http://emailbydomain.com>

Auto manuals search

<http://auto.somanuals.com>

TV manuals search

<http://tv.somanuals.com>