

KENWOOD

SIRIUS 

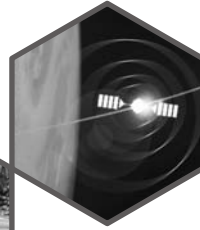

Here<sub>2</sub>Anywhere™

**KPA-H2C**  
Car Docking Kit  
Installation Guide

## Box contents

Unpack your KPA-H2C kit carefully and make sure that everything listed here is present:

1 x Cradle

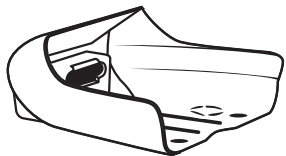

1 x Base



1 x Antenna

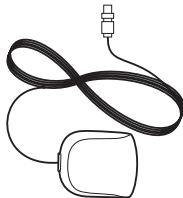

1 x Cassette adapter

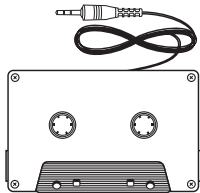

1 x Cigarette lighter power adapter



1 x Audio cable

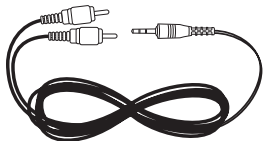

1x Carry Bag



1 x Hardware bag



If anything is missing or damaged, notify your dealer immediately. If your KPA-H2C was shipped to you directly, notify your shipper immediately. Kenwood recommends that you retain the original carton and packing materials in case you need to ship your KPA-H2C in the future.

## Safety precautions

### ⚠ Warning

Take the following precautions to prevent traffic accidents and avoid personal injury:

- Installation must be performed according to this installation manual. Kenwood is not responsible for issues arising from installations not performed according to the procedures in this manual.
- Do not install the unit where it may obstruct your view through the windshield or of your vehicle's indicator displays.
- Do not install the unit where it may hinder the function of safety devices such as an airbag. Doing so may prevent the airbag from functioning properly in the event of an accident.
- The installation and use suggestions contained in this manual are subject to any restrictions or limitations that may be imposed by applicable law—the purchaser should check applicable law for any restrictions or limitations before installing and/or operating this unit.

### ⚠ Caution

Take the following precautions to keep the unit in proper working order:

- Failure to follow these safety instructions and warnings may result in a serious accident.
- Be sure the unit is connected to a 12V DC power supply with a negative ground connection.
- Do not install the unit where it will be exposed to high levels of humidity, moisture, or dust.
- When replacing a fuse, use only a new one with the proper rating. Using a fuse with the wrong rating may cause the unit to malfunction.
- To prevent a short circuit when replacing a fuse, first unplug the cigarette lighter adapter from the cigarette lighter.
- When drilling holes to mount the unit, make sure not to damage wiring or other systems on the other side.

## Installation in a vehicle

Note: Do not put Here<sub>2</sub>Anywhere in the docking station until you have completed the installation.

1. Determine where you want to mount Here<sub>2</sub>Anywhere.

- Do not install Here<sub>2</sub>Anywhere where it may obstruct your view through the windshield or your view of your vehicle's indicator displays.
- Do not install Here<sub>2</sub>Anywhere where it will hinder your access to the vehicle's controls.
- Do not install Here<sub>2</sub>Anywhere where it may hinder the function of safety devices such as an airbag. Doing so may prevent the air-bag from functioning properly in the event of an accident.
- Find a location that provides good visibility of and access to Here<sub>2</sub>Anywhere's front panel.
- Kenwood strongly recommends that you mount Here<sub>2</sub>Anywhere in a location where the base can be attached with the provided screws.

2. The leaves on the base can be bent to conform to curved mounting surfaces.

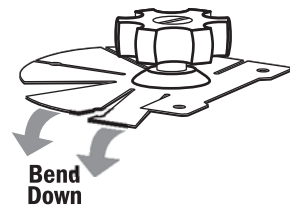

3. Peel the covering away from the adhesive on the bottom of the base and adhere it to the mounting surface. Use the provided screws to securely attach the base to the surface.

- If using screws, be sure that you do not damage wiring or other systems on the other side of the mounting surface.

4. Using the provided screw, assemble the docking station cradle to the base.

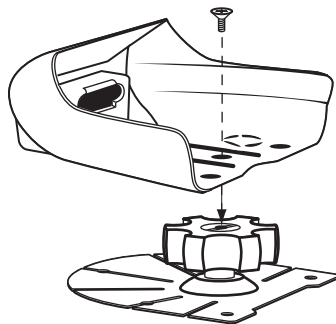

## Installation in a vehicle (continued)

5. Plug the cigarette lighter adapter into the back of the cradle, as shown. Don't plug the adapter into the cigarette lighter until the installation is completed.

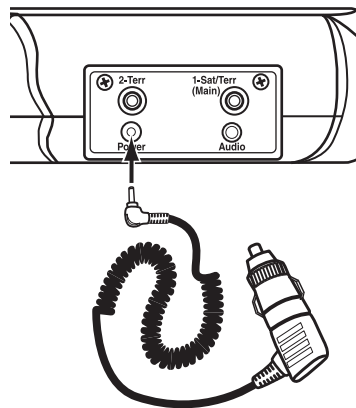

- 6A. Plug the cassette adapter into the back of the cradle, as shown.

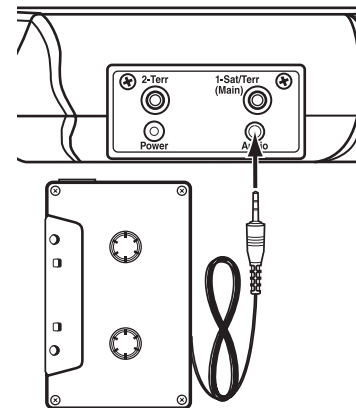

- 6B. If your car stereo has an aux input, plug the supplied audio cable into the back of the cradle instead of the cassette adapter. Plug the audio cable's white (L ch.) and red (R ch.) connectors into your car stereo.

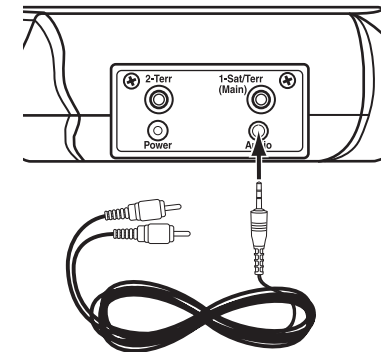

## Installation in a vehicle: Mounting the antenna

1. Temporarily plug the antenna into the “1-Sat/Terr (Main)” connector on the back of the cradle until it is firmly seated, as shown.

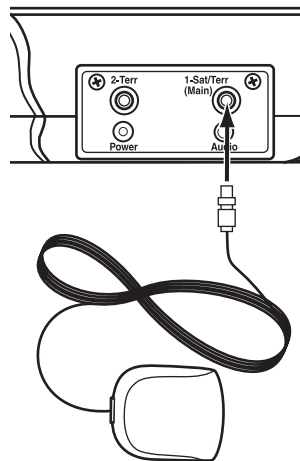

Note: If you're using the Kenwood CX-SR10 SIRIUS antenna, you'll need to remove the plastic housings from the antenna connectors—we recommend labeling the wires with their respective colors. (See pg. 9, figure 16 of the CX-SR10 Installation Manual for details). Once you've removed the housings, connect the wire that had the yellow connector to the connector on the cradle labeled “1-Sat/Terr (Main)”, and connect the other one to the connector labeled “2-Terr”.

2. Find an antenna location on a metal surface at least 12” x 12”, and at least 6” from a window.
  - Best reception is achieved with the antenna mounted on the roof; mounting on the trunk lid will work for convertibles.
  - If the vehicle has a roof rack or skid ribs, it may be necessary to mount the antenna off-center.
3. The antenna's powerful magnet will secure it to the metal surface.
- Before routing the antenna cable, confirm that the antenna is mounted in a good location:
4. Temporarily plug the cigarette lighter adapter into the cigarette lighter.
5. Slide Here<sub>2</sub>Anywhere all the way into the cradle so that the connector at the rear of the unit makes proper contact in the cradle. Press the POWER button to turn Here<sub>2</sub>Anywhere on.
6. Aim the remote control at Here<sub>2</sub>Anywhere, press the DIRECT button, then enter the number “1-8-4”, and press the SELECT button. If your Here<sub>2</sub>Anywhere has been properly connected and the antenna is receiving the SIRIUS signal you will hear audio. If you do not hear audio, the display will read “Acquiring Signal”. Re-orient the antenna until you hear audio. (See *Antenna Signal*, on page 25 to use the ANTENNA SIGNAL screen to aim the antenna.)
  - Make sure the vehicle is not in garage, or somewhere the satellite signal could be blocked
7. Turn Here<sub>2</sub>Anywhere's power off and remove it from the cradle; unplug the cigarette lighter adapter from the cigarette lighter; unplug the antenna from the cradle.

## Installation in a vehicle: Routing the cable

8. Route the cable from the antenna to the vehicle's interior by tucking it underneath the rubber molding around rear window, as shown below.

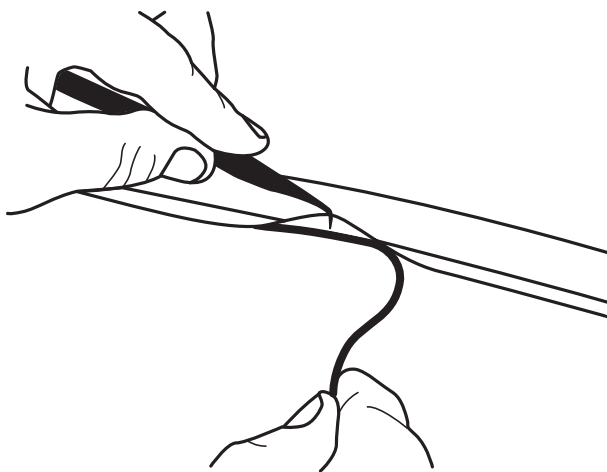

9. Route the cable from the lowest point of the rear window into the trunk. Take advantage of any existing cable channels or wiring conduits.
  - For SUVs, minvans & 5-door vehicles, bring the cable into the vehicle under the rubber molding for the tailgate, and continue under the interior trim
10. From the trunk, route the cable around the passenger compartment and to the back of the cradle.
  - Keep the wire away from areas where it could become tangled in driver's and passenger's feet.
11. Plug the antenna into the back of the cradle (see pg. 6, Step 1).
12. Plug the cigarette lighter adapter into the cigarette lighter.
  - KENWOOD RECOMMENDS UNPLUGGING THE CIGARETTE LIGHTER ADAPTER AFTER YOU TURN THE VEHICLE'S IGNITION OFF. (In some vehicles, the cigarette lighter remains active after the ignition has been turned off, and leaving Here<sub>2</sub>Anywhere's cigarette lighter adapter plugged-into the cigarette lighter could drain the vehicle's battery.)

The logo consists of a black trapezoidal shape at the top containing the word 'KENWOOD' in white, uppercase letters. Below this is a grey trapezoidal shape pointing downwards, and to the right is another grey trapezoidal shape pointing to the left.

**KENWOOD**

**[www.kenwoodusa.com](http://www.kenwoodusa.com)**

**[www.kenwoodusa.com/inquiry](http://www.kenwoodusa.com/inquiry)**

**1-800-KENWOOD**

**Main Office**

P.O. Box 22745

Long Beach, CA 90801-5745

©2003 Kenwood USA Corporation.  
All Rights Reserved.

## Free Manuals Download Website

<http://myh66.com>

<http://usermanuals.us>

<http://www.somanuals.com>

<http://www.4manuals.cc>

<http://www.manual-lib.com>

<http://www.404manual.com>

<http://www.luxmanual.com>

<http://aubethermostatmanual.com>

Golf course search by state

<http://golfingnear.com>

Email search by domain

<http://emailbydomain.com>

Auto manuals search

<http://auto.somanuals.com>

TV manuals search

<http://tv.somanuals.com>