

RAPID CHARGER

# KSC-25

## SERVICE MANUAL

# KENWOOD

© 2002-2 PRINTED IN JAPAN  
B51-8626-00 (N) 1509

This KSC-25 service manual is the revised edition of the KSC-25 information in the TK-2140 (B51-8602-00) and TK-3140 (B51-8603-00) service manual.

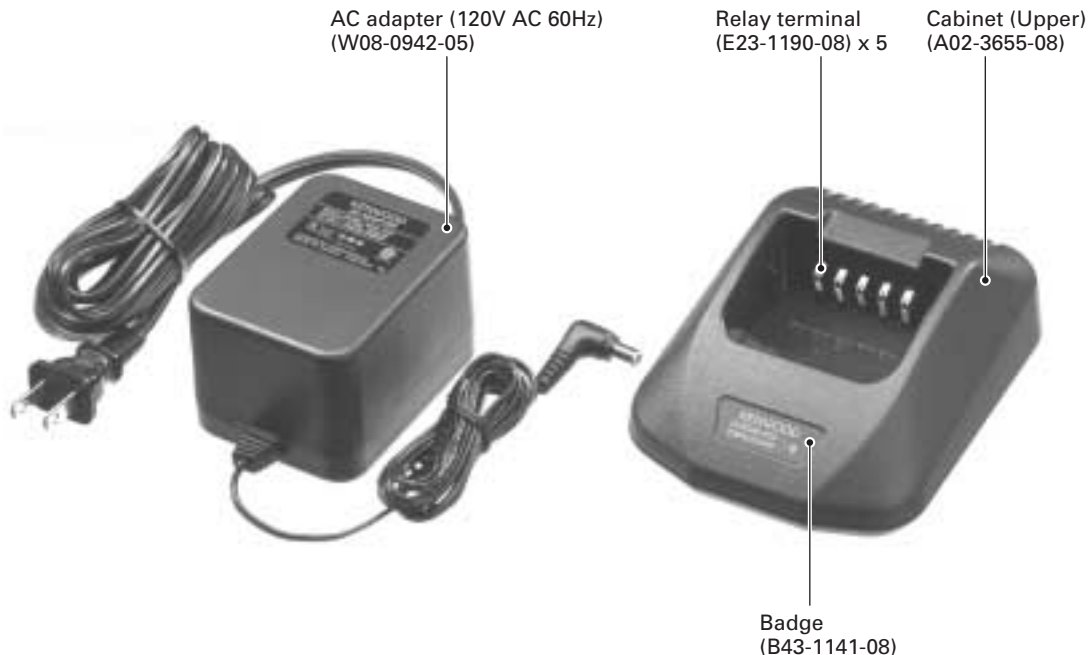

## PARTS LIST

\* New Parts.

Ref. No.	Address	New parts	Parts No.	Description	Destination
			A02-3655-08	Cabinet Upper	
			A02-3656-08	Cabinet Bottom	
			B43-1141-08	Badge	
			B62-1607-00	Instruction manual	
			E03-0200-08	DC jack	
			E23-1190-08	Relay terminal	
			G13-1547-08	Cushion	
			N80-2610-45	Screw	
			W02-3641-08	Charger unit	
			W08-0942-05	AC adapter 120VAC 60Hz	K

## CHARGER FLOW CHART

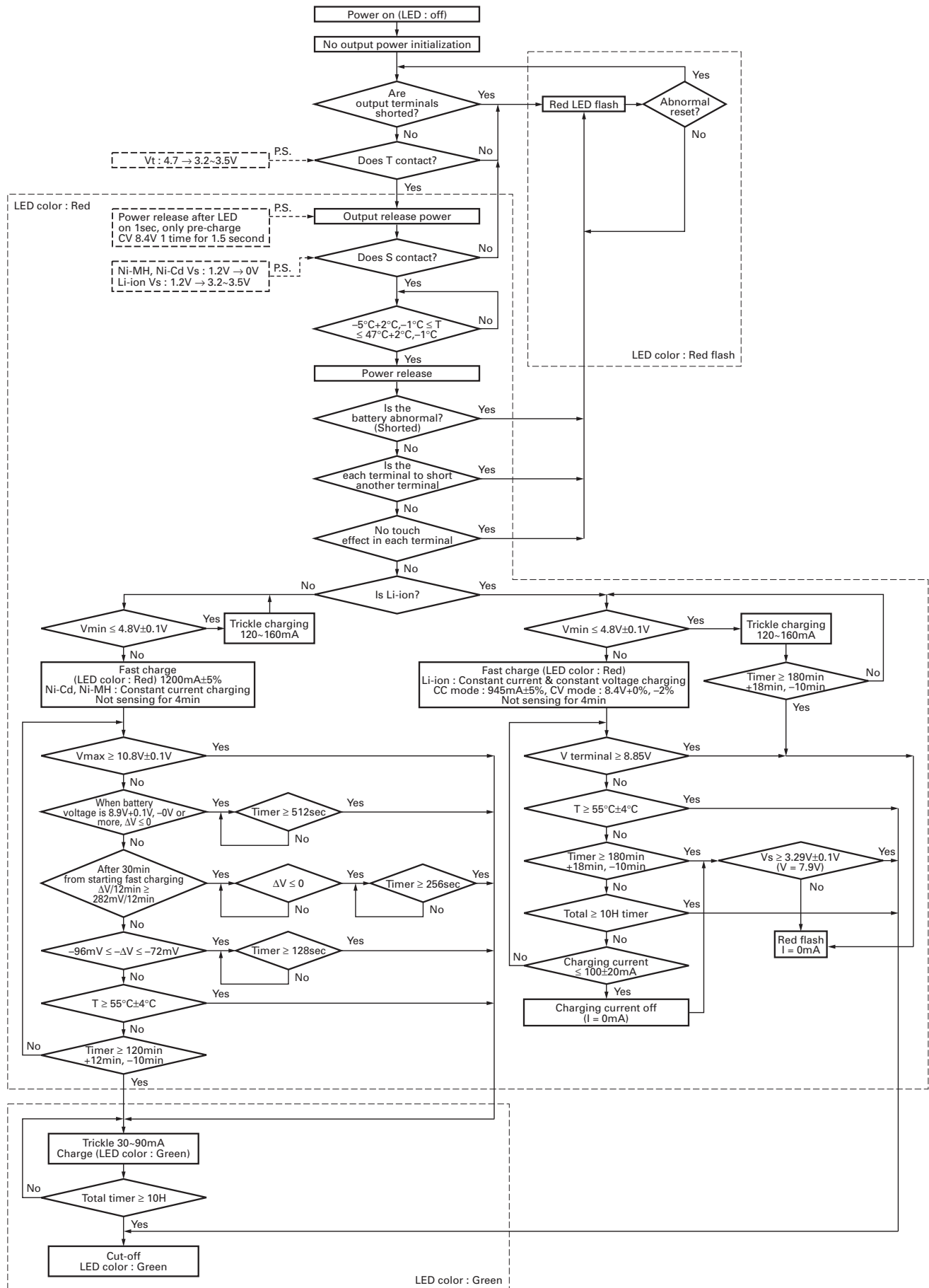

## PC BOARD VIEWS

**CHARGER UNIT (W02-3641-08) Component side view**

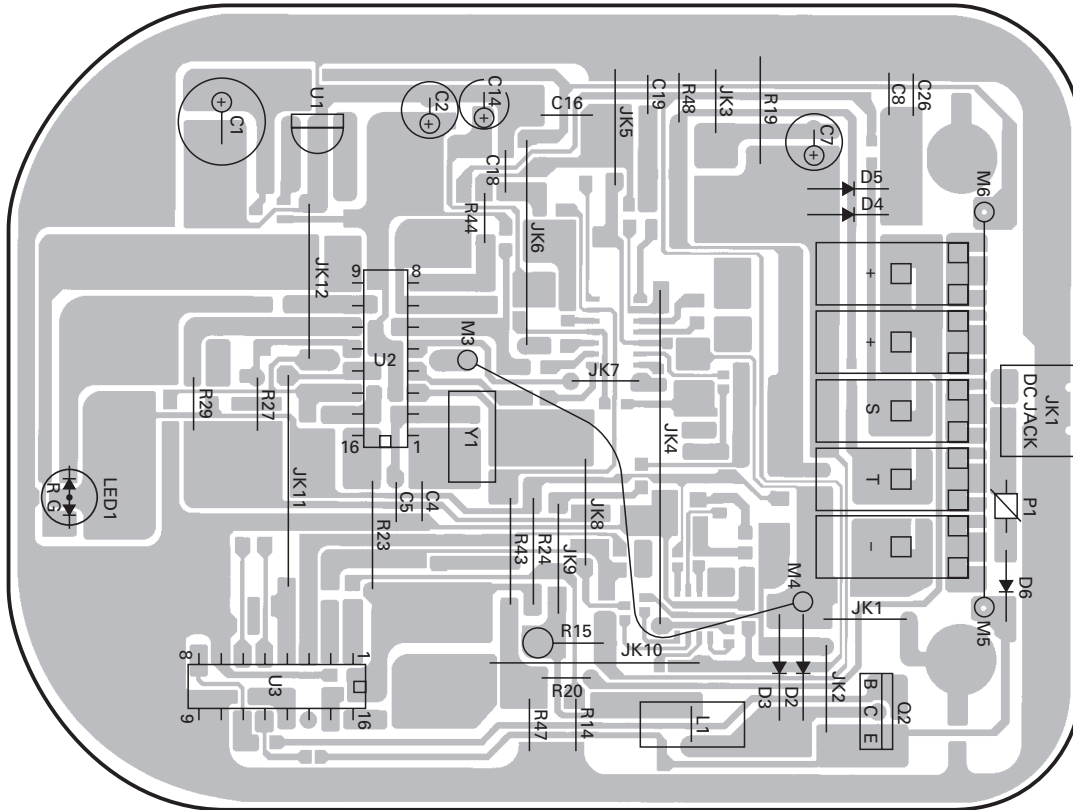

**CHARGER UNIT (W02-3641-08) Foil side view**

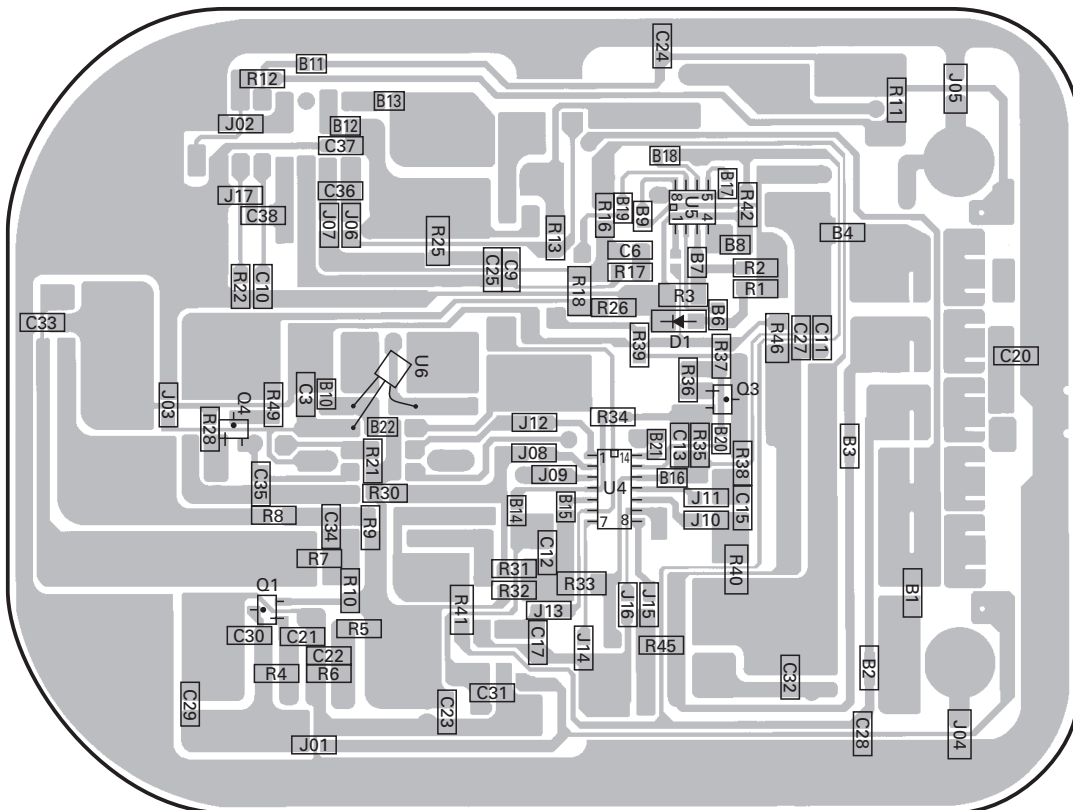

## SCHEMATIC DIAGRAM

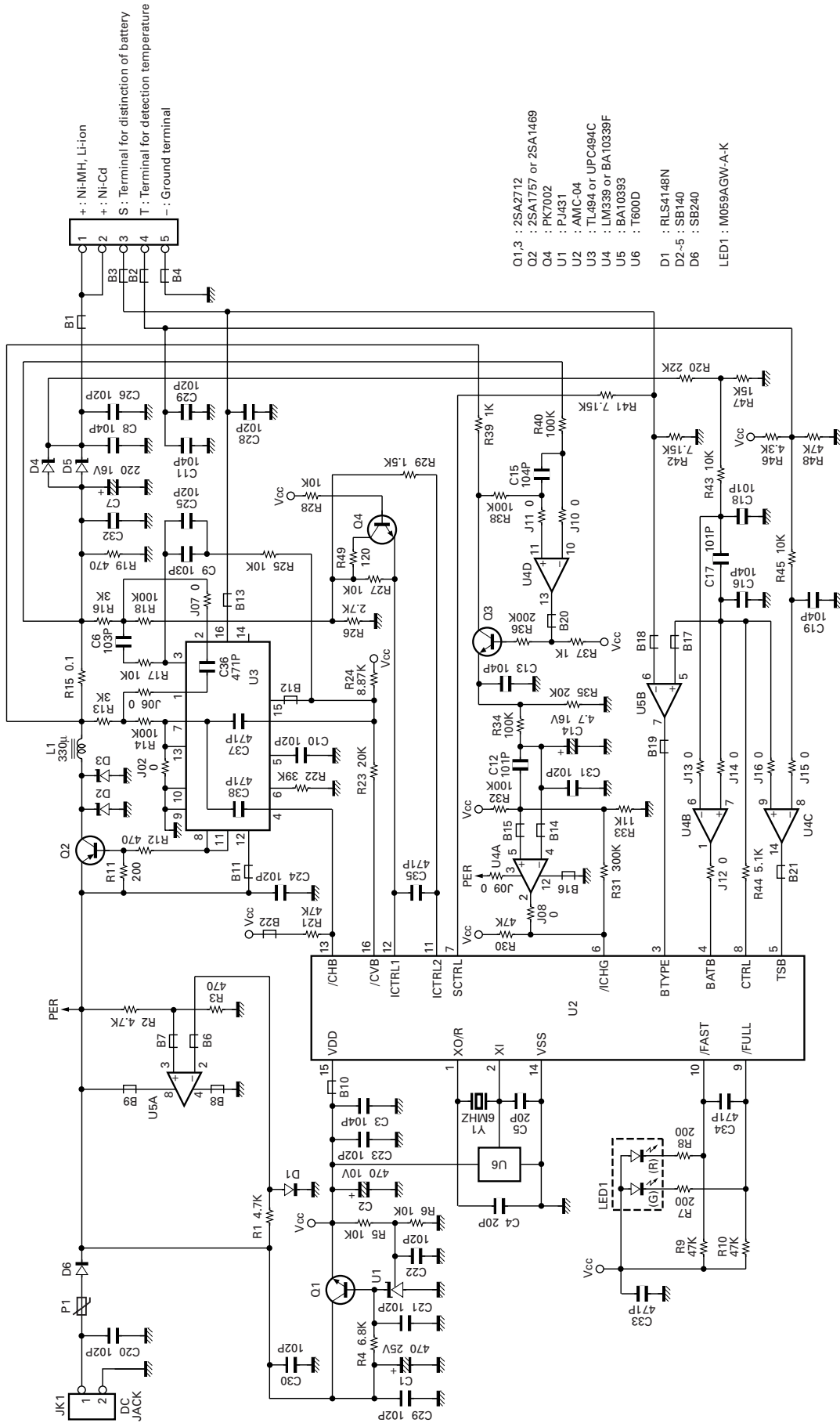

## BATTERY PACK

### KNB-24L (Li-ion Battery Pack : 1400mAh)

#### ■ External View



#### ■ Schematic Diagram

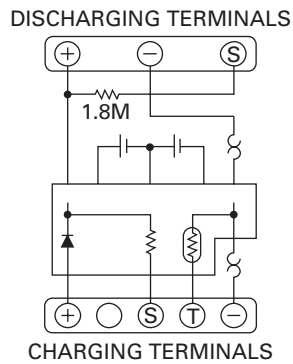

### KNB-26N (Ni-MH Battery Pack : 2000mAh)

#### ■ External View



#### ■ Schematic Diagram

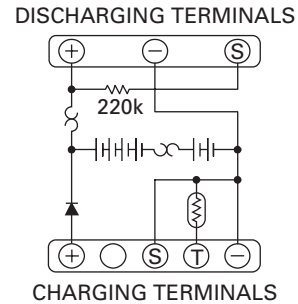

### KNB-25A (Ni-Cd Battery Pack : 1200mAh)

#### ■ External View



#### ■ Schematic Diagram

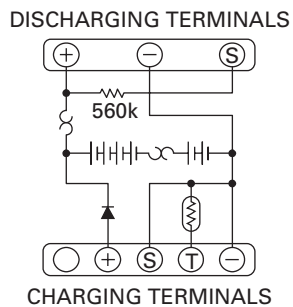

## **KENWOOD CORPORATION**

14-6, Dogenzaka 1-chome, Shibuya-ku, Tokyo 150-8501, Japan

### **KENWOOD SERVICE CORPORATION**

P.O. BOX 22745, 2201 East Dominguez Street, Long Beach, CA 90801-5745, U.S.A.

### **KENWOOD ELECTRONICS CANADA INC.**

6070 Kestrel Road, Mississauga, Ontario, Canada L5T 1S8

### **KENWOOD ELECTRONICS DEUTSCHLAND GMBH**

Rembrücker Str. 15, 63150 Heusenstamm, Germany

### **KENWOOD ELECTRONICS BELGIUM N.V.**

Leuvensesteenweg 248 J, 1800 Vilvoorde, Belgium

### **KENWOOD ELECTRONICS FRANCE S.A.**

13, Boulevard Ney, 75018 Paris, France

### **KENWOOD ELECTRONICS U.K. LIMITED**

KENWOOD House, Dwight Road, Watford, Herts., WD1 8EB United Kingdom

### **KENWOOD ELECTRONICS EUROPE B.V.**

Amsterdamseweg 37, 1422 AC Uithoorn, The Netherlands

### **KENWOOD ELECTRONICS ITALIA S.p.A.**

Via G. Sirtori, 7/9 20129 Milano, Italy

### **KENWOOD IBERICA S.A.**

Bolivia, 239-08020 Barcelona, Spain

### **KENWOOD ELECTRONICS AUSTRALIA PTY. LTD.**

(A.C.N. 001 499 074)

16 Giffnock Avenue, Centrecourt Estate, North Ryde, N.S.W. 2113 Australia

### **KENWOOD ELECTRONICS (HONG KONG) LTD.**

Unit 3712-3724, Level 37, Tower one Metroplaza, 223 Hing Fong Road, Kwai Fong, N.T., Hong Kong

### **KENWOOD ELECTRONICS TECHNOLOGIES(S) PTE LTD.**

Sales Marketing Division

1 Ang Mo Kio Street 63, Singapore 569110



## Free Manuals Download Website

<http://myh66.com>

<http://usermanuals.us>

<http://www.somanuals.com>

<http://www.4manuals.cc>

<http://www.manual-lib.com>

<http://www.404manual.com>

<http://www.luxmanual.com>

<http://aubethermostatmanual.com>

Golf course search by state

<http://golfingnear.com>

Email search by domain

<http://emailbydomain.com>

Auto manuals search

<http://auto.somanuals.com>

TV manuals search

<http://tv.somanuals.com>