

KENWOOD



FP510 series

FP520 series

FP530 series

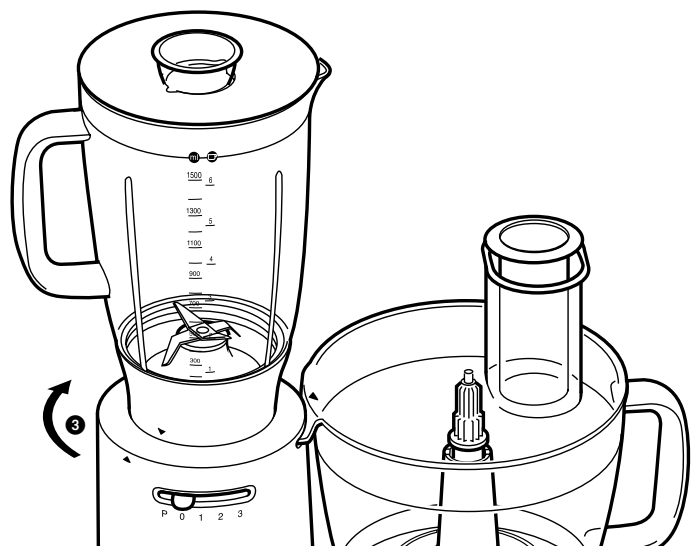
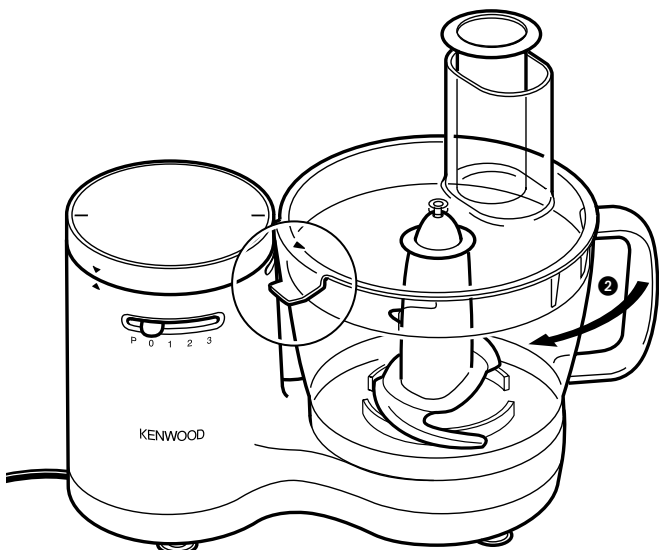
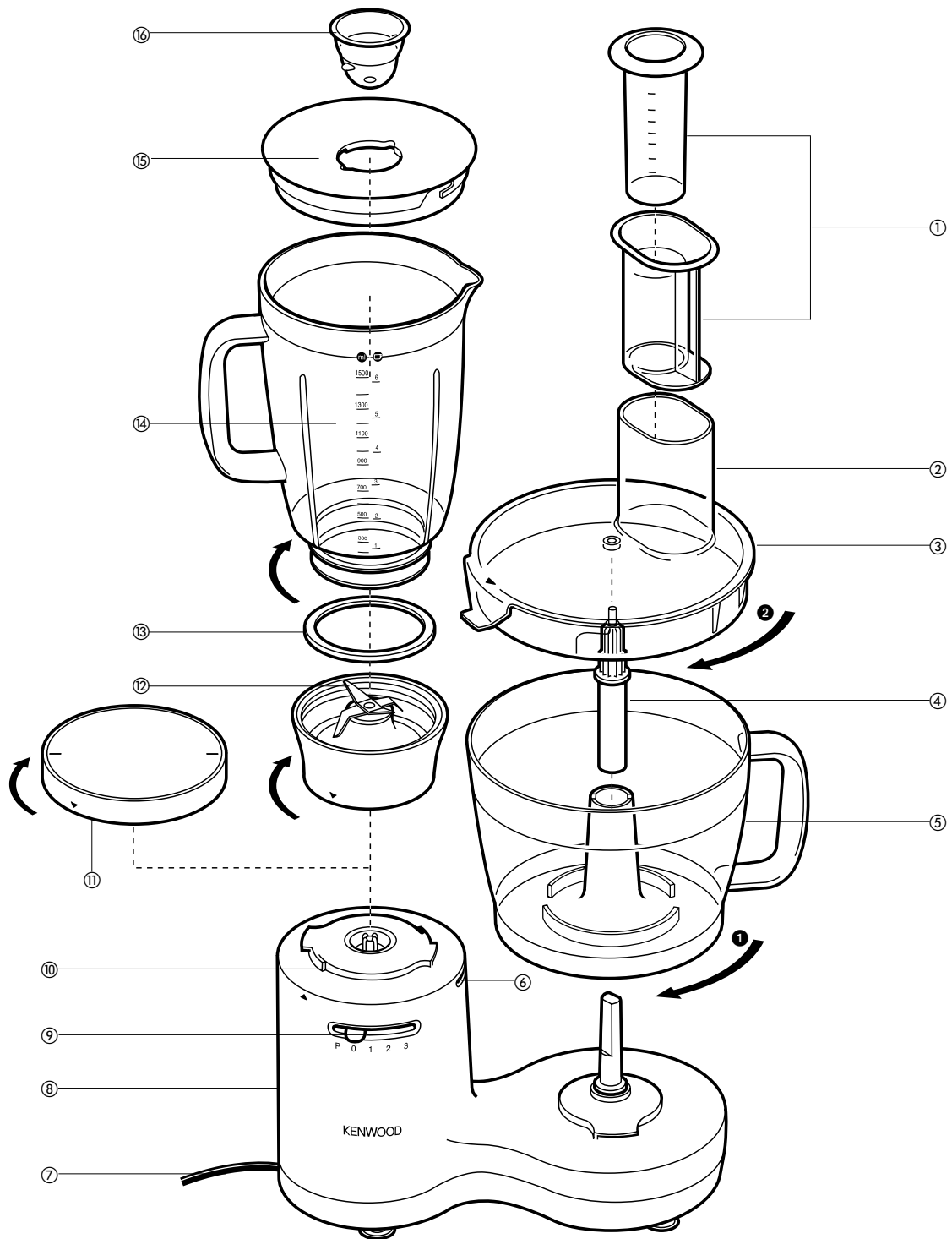

safety

- The blades and discs are very sharp, handle with care.
Always hold the knife blade by the finger grip **Ⓐ at the top, away from the cutting edge, both when handling and cleaning.**
- Always remove the knife blade before pouring contents from the bowl.
- Keep hands and utensils out of the processor bowl and liquidiser jug whilst connected to the power supply.
- Switch off and unplug:
 - before fitting or removing parts
 - after use
 - before cleaning
- Never use your fingers to push food down the feed tube. Always use the pusher/s supplied.
- Before removing the lid from the bowl or liquidiser/mill from the power unit:-
 - switch off;
 - wait until the attachment/blades have completely stopped;
 - Be careful not to unscrew the liquidiser jug or mill from the blade unit.
- Allow hot liquids to cool before blending in the liquidiser - if you haven't fitted the lid securely and it comes off, you could get splashed.
- **This machine will be damaged and may cause injury if the interlock mechanism is subjected to excessive force.**
- Do not use the lid to operate the processor, always use the on/off speed control.
- This machine is not intended for use by young children or infirm persons without supervision.
- Never use an unauthorised attachment.
- Don't let children play with this machine.
- Never leave the machine on unattended.
- Never use a damaged machine. Get it checked or repaired: see 'service'.
- Never let the power unit, cord or plug get wet.
- Don't let excess cord hang over the edge of a table or worktop or touch hot surfaces.
- Never misuse your food processor and only use it for its intended domestic use.

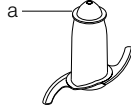

before plugging in

- Make sure your electricity supply is the same as the one shown on the underside of your machine.

important- UK only

- The wires in the cord are coloured as follows:
Blue = Neutral
Brown = Live
- This appliance complies with European Economic Community Directive 89/336/EEC.

before using for the first time

- 1 Remove all packaging including the plastic blade covers from the knife blade.
Take care the blades are very sharp. These covers should be discarded as they are to protect the blade during manufacture and transit only.
- 2 Wash the parts see 'cleaning'

key

processor

- ① pushers
- ② feed tube
- ③ lid
- ④ detachable drive shaft
- ⑤ bowl
- ⑥ safety interlock
- ⑦ cord storage (at back)
- ⑧ power unit
- ⑨ speed/pulse control
- ⑩ liquidiser outlet/interlock
- ⑪ liquidiser outlet cover/safety interlock

liquidiser

- ⑫ blade unit
- ⑬ sealing ring
- ⑭ jug
- ⑮ lid
- ⑯ filler cap

additional attachments

Not all of these attachments listed below will be included with your food processor. Please refer to your content list supplied. To buy an attachment not included in your pack, contact the dealer from whom you purchased your appliance.

- ⑰ knife blade
- ⑱ dough tool (FP530 only)
- ⑲ twin beater geared whisk
- ⑳ maxi-blend canopy
- ㉑ thick slicing/coarse shredding disc
- ㉒ thin slicing/fine shredding disc (FP520/FP530)
- ㉓ fine (Julienne style) chipper disc (FP530 only)
- ㉔ rasping disc (UK pack - not supplied)
- ㉕ geared citrus press (FP520/FP530)
- ㉖ mill (if supplied)
- ㉗ KENSTORE™ attachments carousel
- ㉘ spatula
- ㉙ recipe book (if supplied)

to use your food processor

- **When using the food processor bowl, the liquidiser outlet cover must be fitted and locked in position or the processor will not work. Ensure the ▼ on the outlet cover lines up with the ▲ on the power unit.**

- 1 Fit the bowl. Place the handle towards the back, lower and turn clockwise until it locks ①.
- 2 Then fit the detachable shaft ④ over the power unit fixed shaft.
- 3 Fit an attachment over the drive shaft.
 - Always fit the bowl and attachment onto the machine before adding ingredients.
- 4 Fit the lid onto the bowl ② - turn clockwise until the arrow on the lid aligns with the line on the outlet cover.
- 5 Switch on and select a speed.
 - **The processor won't work if the lid or outlet cover are fitted incorrectly.**
 - Use the pulse (P) for short bursts. The pulse will operate for as long as the lever is held in position.
- 6 Reverse the above procedure to remove the lid, attachments and bowl.
 - **Always switch off before removing the lid.**

important

- Your processor is not suitable for crushing or grinding coffee beans, or converting granulated sugar to caster sugar.
- When adding almond essence or flavouring to mixtures avoid contact with the plastic as this may result in permanent marking.

to use your liquidiser

- 1 Fit the sealing ring ⑬ into the blade unit ⑫ - ensuring the seal is located correctly.
Leaking will occur if the seal is damaged or not fitted correctly.
- 2 Screw the jug onto the blade unit.
- 3 Put your ingredients into the jug.
- 4 Put the filler cap in the lid, then turn.
- 5 Turn the lid in a clockwise direction to lock onto the jug.
- 6 Remove the liquidiser outlet cover by turning in an anti-clockwise direction.
- 7 Place the liquidiser onto the liquidiser outlet and turn to lock ③.

important

- **The liquidiser attachment will work only with the processor bowl and lid in position.**
- **When using the liquidiser outlet we recommend that there are no tools in the bowl.**

8 Select a speed or use the pulse control.

hints

- When making mayonnaise, put all the ingredients, except the oil into the liquidiser. Then with the machine running, pour the oil into the filler cap and let it run through.
- Thick mixtures, eg pates and dips, may need scraping down. If it's difficult to process, add more liquid.
- When crushing ice, add 15mls (1tbsp) water to 6 ice cubes. Use the pulse control.
- Allow hot liquids to cool before blending in the liquidiser – if you haven't fitted the lid securely and it comes off, you could get splashed.
- To ensure the long life of your liquidiser, never run it for longer than 60 seconds. Switch off as soon as you've got the right consistency.
- Don't process spices - they may damage the plastic.
- The machine won't work if the liquidiser is fitted incorrectly.
- Don't put dry ingredients into the liquidiser before switching on. If necessary, cut them into pieces; remove the filler cap; then with the machine running, drop them through one by one.
- Don't use the liquidiser as a storage container. Keep it empty before and after use.
- Never blend more than 1½ litres (2pts 12fl oz) - less for frothy liquids like milkshakes.

choosing a speed for all functions

tool/attachment	function	speed	
		FP510/520	FP530
knife blade	Cake making	1-2	1-3
	Rubbing fat into flour	2	3
	Adding water to combine pastry ingredients	1	1
	Chopping/pureeing/pates	2	3
knife blade with maxi-blend canopy	Soups	1	1-2
whisk	egg whites	2	3
	egg & sugar for fatless sponges	2	3
	cream	1	1-2
dough tool	yeasted mixes	2	2-3
discs - slicing/shredding/chipping	Firm food items such as carrots, hard cheeses	2	2-3
	Softer items such as cucumbers, tomatoes	1	1
rasping disc	Parmesan cheese, Potato for German potato dumplings	2	3
citrus press	Citrus fruits	1	1
liquidiser	All processing	2	3
mill	All processing	2	3

maximum capacities

- Shortcrust pastry Flour wt 340g/12oz
- Yeast dough Flour wt 500g/1lb 2oz
- One Stage Cake Total wt 1.5Kg/3lb 5oz
- Chopping meat Total wt 600g/1lb 6oz
- Liquid with canopy 1.5litres/2pts 12fl.oz
- Twin geared whisk 6 egg whites

using the attachments

see chart above for speed of each attachment.

17 knife blade/18 dough tool

The knife blade is the most versatile of all the attachments. The length of the processing time will determine the texture achieved. For coarser textures use the pulse control. Use the knife blade for cake and pastry making, chopping raw and cooked meat, vegetables, nuts, pate, dips, pureeing soups and to also make crumbs from biscuits and bread. It can also be used for yeasted dough mixes if the dough tool is not supplied.

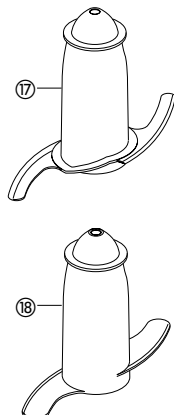

Use the dough tool for yeasted mixes.

hints

knife blade

- Cut food such as meat, bread, vegetables into cubes approximately 2cm/3/4in before processing.
- Biscuits should be broken into pieces and added down the feed tube whilst the machine is running.
- When making pastry use fat straight from the fridge cut into 2cm/3/4in.cubes.
- Take care not to over-process.

dough tool

- Place the dry ingredients in the bowl and add the liquid down the feed tube whilst the machine is running. Process until a smooth elastic ball of dough is formed this will take 60 - 90 secs.
- Re-knead by hand only. Re-kneading in the bowl is not recommended as it may cause the processor to become unstable.

19 twin beater geared whisk

Use for light mixtures only eg egg whites, cream, evaporated milk and for whisking eggs and sugar for fatless sponges. Heavier mixtures such as fat and flour will damage it.

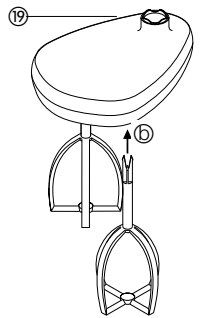

using the whisk

- 1 Fit the drive shaft and bowl onto the power unit
- 2 Push each beater securely into the drive head
- 3 Fit the whisk by carefully turning until it drops over the drive shaft.
- 4 Add the ingredients.
- 5 Fit the lid - ensuring the end of the shaft locates into the centre of the lid.
- 6 Switch on.

important

- **The whisk is not suitable for making one-stage cakes or creaming fat and sugar as these mixes will damage it. Always use the knife blade for cake making.**

hints

- Best results are obtained when the eggs are at room temperature.
- Ensure the bowl and whisks are clean and free from grease before whisking.

20 maxi-blend canopy

When blending liquids, use the maxi-blend canopy with the knife blade. It allows you to increase the liquid processing capacity from 1 litre to 1.5 litres, prevents leaking and improves the chopping performance of the blade.

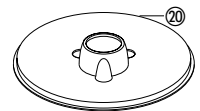

- 1 Fit the drive shaft and bowl onto the power unit.
- 2 Fit the knife blade.
- 3 Add ingredients to be processed.
- 4 Fit the canopy over the top of the blade ensuring it sits on the ledge inside the bowl. **Do not push down on the canopy, hold by the centre grip.**
- 5 Fit the lid and switch on.

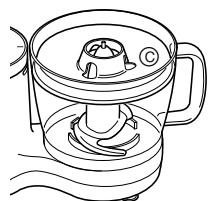

slicing/shredding discs

reversible slicing/shredding discs - thick 21, thin 22

Use the shredding side for cheese, carrots, potatoes and foods of a similar texture.

Use the slicing side for cheese, carrots, potatoes, cabbage, cucumber, courgette, beetroot and onions.

fine (Julienne style) chipper disc 23

Use to cut: potatoes for Julienne style French fries; firm ingredients for salads, garnishes, casseroles and stir fries (eg carrot, swede, courgette, cucumber).

rasping disc 24

Grates Parmesan cheese and potatoes for German potato dumplings.

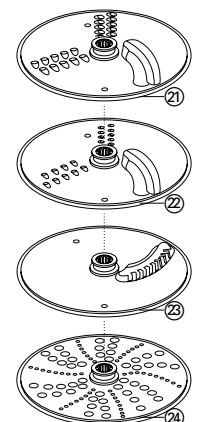

safety

- **Never remove the lid until the cutting disc has completely stopped.**
- **Handle the cutting discs with care - they are extremely sharp**

to use the cutting discs

- 1 Fit the drive shaft and bowl onto the power unit.
- 2 Holding by the centre grip (ⓐ), place the disc onto the drive shaft with the appropriate side uppermost (ⓑ).
- 3 Fit the lid.
- 4 Choose which size feed tube you want to use. The pusher contains a smaller feed tube for processing individual items or thin ingredients.
To use the small feed tube - first put the large pusher inside the feed tube.
To use the large feed tube - use both pushers together.
- 5 Put the food in the feed tube.
- 6 Switch on and push down evenly with the pusher - **never put your fingers in the feed tube.**

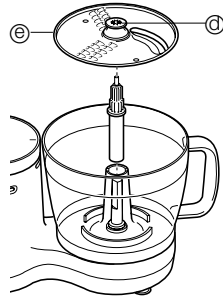

hints

- Use fresh ingredients
- Don't cut food too small. Fill the width of the large feed tube fairly full. This prevents the food from slipping sideways during processing. Alternatively use the small feed tube.
- When using the chipper disc, place ingredients horizontally.
- When slicing or shredding: food placed upright (ⓑ) comes out shorter than food placed horizontally (ⓐ).
- There will always be a small amount of waste on the plate or in the bowl after processing.

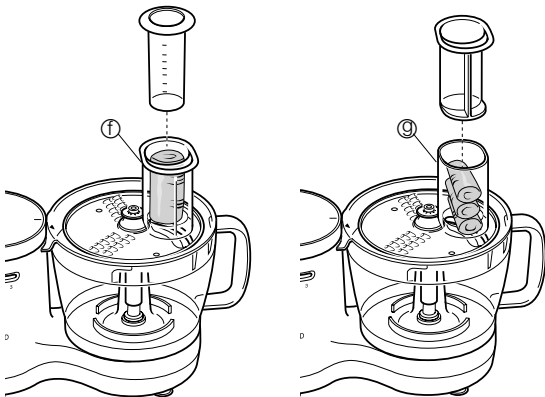

ⓑ citrus press

Use the citrus press to squeeze the juice from citrus fruits (eg oranges, lemons, limes and grapefruits).

- 1 cone
- 2 sieve

to use the citrus press

- 1 Fit the drive shaft and bowl onto the power unit.
 - 2 Add the sieve and turn clockwise until the interlock fin on the sieve aligns with the line on the outlet cover (ⓐ).
 - 3 Place the cone over the drive shaft turning until it drops all the way down (ⓑ).
 - 4 Cut the fruit in half. Then switch on and press the fruit onto the cone.
- **The citrus press will not operate if the sieve is not locked correctly.**

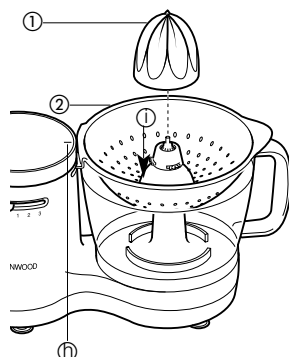

ⓐ mill

Use the mill for milling herbs, nuts and coffee beans.

- 1 blade unit
- 2 sealing ring
- 3 jar
- 4 sprinkler lid

safety

- Never fit the blade unit to your machine without the jar fitted.
- Never unscrew the jar while the multi-mill is fitted to your machine.
- Don't touch the sharp blades. Keep the blade unit away from children.
- Never remove the multi-mill until the blades have completely stopped.

important

- To ensure long life of your mill, never run for longer than 30 seconds. Switch off as soon as you've got the right consistency.
- Don't process spices - they may damage the plastic.
- The machine won't work if the mill is fitted incorrectly.
- Use for dry ingredients only.

to use your mill

- 1 Put your ingredients into the jar. Fill it no more than half full.
- 2 Fit the sealing ring into the blade unit.
- 3 Turn the blade unit upside down. Lower it into the jar, blades down.
- 4 Screw the blade unit onto the jar until it is finger tight.
- 5 Remove the liquidiser outlet cover by turning in an anti clockwise direction.
- 6 Place the mill on the liquidiser outlet and turn to lock in a clockwise direction (ⓐ).
- 7 Switch on to maximum speed or use the pulse control.
- 8 After milling, you can replace the blade unit with the sprinkler lid and shake out your food.

- The sprinkler lid is not airtight.

hints

- Herbs are best milled when clean and dry.

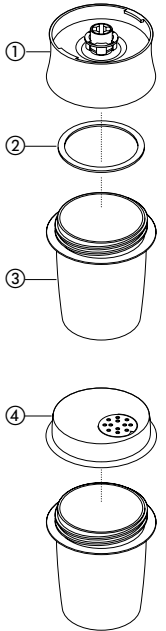

ⓐ KENSTORE™ attachments carousel

Your food processor is supplied with an attachment storage carousel that fits inside the bowl.

to use the storage carousel

- 1 Fit the knife blade to the bowl.
- 2 Then fit the whisk, discs and canopy into the carousel (ⓐ).
- 3 Fit the carousel over the knife blade and place the processor lid on top (ⓑ).

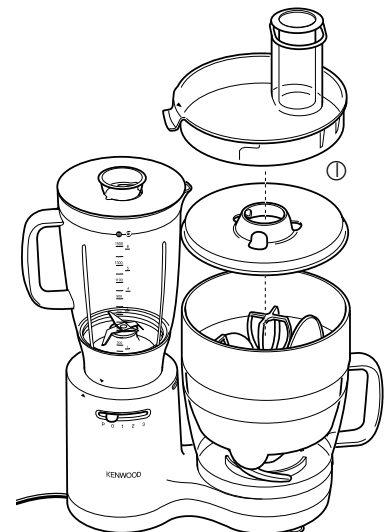
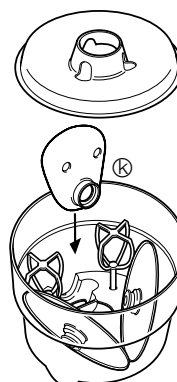

care & cleaning

- Always switch off and unplug before cleaning.
- Handle the blades and cutting discs with care - they are extremely sharp.
- Some foods may discolour the plastic. This is perfectly normal and won't harm the plastic or affect the flavour of your food. Rub with a cloth dipped in vegetable oil to remove the discolouration.

power unit

- Wipe with a damp cloth, then dry. Ensure that the interlock area is clear of food debris.
- Wrap excess cord around the bracket at the back of the appliance.

liquidiser/mill

- 1 Empty the jug/jar before unscrewing it from the blade unit.
- 2 Wash the jug/jar by hand.
- 3 Remove and wash the sealing ring.
- 4 Don't touch the sharp blades - brush them clean using hot soapy water, then rinse thoroughly under the tap. **Don't immerse the blade unit in water.**
- 5 Leave to dry upside down.

twin beater geared whisk

- Detach the beaters from the drive head by gently pulling them free. Wash in warm soapy water.
- Wipe the drive head with a damp cloth, then dry. **Do not immerse the drive head in water.**

all other parts

- Wash by hand, then dry.
- Alternatively they can be washed on the top rack of your dishwasher. A short low temperature programme is recommended.

service & customer care

- If the cord is damaged it must, for safety reasons, be replaced by Kenwood or an authorised Kenwood repairer.

● **If you experience any problems with the operation of the processor, before calling for assistance refer to the troubleshooting guide.**

UK

If you need help with:

- Using your machine
- Servicing or repairs (in or out of guarantee)

☎ call Kenwood customer care on **023 92392333**. **Have your model number ready** - it's on the underside of the processor.

spares and attachments

☎ call 0870 2413653

other countries

Contact the shop where you brought the food processor.

guarantee UK only

If your food processor goes wrong within one year from the date you bought it, we will repair it (or replace it if necessary) free of charge provided:

- you have not misused, neglected, or damaged it;
- it has not been modified (unless by Kenwood);
- it is not second hand;
- it has not been used commercially;
- you have not fitted a plug incorrectly; and
- **you supply your receipt to show when you bought it.**

This guarantee does not affect your statutory rights.

troubleshooting guide

Problem	Cause	Solution
The processor will not operate.	No Power. Liquidiser outlet cover not locked on. Bowl lid not locked on correctly. Liquidiser not locked on correctly.	Check processor is plugged in. When using the processor bowl the outlet cover must be fitted and locked on or the processor will not operate. The processor and liquidiser will not operate if the bowl lid is not fitted correctly. The liquidiser will not operate if fitted incorrectly. If none of the above check the fuse/circuit breaker in your home.
Lid unlocked but speed control light is still on	If the lid is unlocked whilst a speed is selected the processor will stop but the speed control will remain lit. This is to remind you that the unit will start up as soon as you re-lock the lid.	Always turn the speed control to "0" before removing the lid.
Liquidiser leaking from blade assembly base.	Seal missing Seal incorrectly fitted Seal damaged.	Check seal is fitted correctly and not damaged. Contact Customer Care for a replacement seal.
Poor performance of tools/attachments	Refer to hints in relevant "Using the attachment" section. Check attachments are assembled correctly.	

recipes

For the speeds of the attachments see page 3

shortcrust pastry

300g (12oz) plain flour
150g (6oz) mixture of lard and margarine cut into small pieces
2.5 mls (½ tsp) salt
45mls (3tbsp) cold water

- 1 Fit the knife blade and add the flour, salt and fat. Process for approximately 10 seconds or until the mixture looks like coarse breadcrumbs.
- 2 Then add the water down the feed tube on low speed until the mixture looks like it is about to stick together.
- 3 Turn out the mixture onto a worksurface and shape by hand. Use as required.
- For best results allow the pastry to rest before use. Place in a plastic bag or wrap in clingfilm and chill in the fridge for 20 minutes.

meringues

4 egg whites
200g (8oz) caster sugar

- 1 Whisk the egg whites at high speed until stiff.
- 2 Add half the sugar and continue to whisk until the mixture is glossy.
- 3 Remove the whisk and carefully fold in the remaining sugar with a metal spoon.
- 4 Pipe the mixture onto trays lined with non-stick baking paper.
- 5 Bake in a pre-heated oven at 110°C/225°F/Gas mark ¼ for about 4 - 5hours until firm and crisp. If they start to brown, leave the door slightly ajar.

winter warmer soup

carrots, potatoes, onions: twenty 2cm (¾") cubes of each.
bacon stock
150g (6oz) red lentils, washed.
375mls (¾pint) vegetable stock
one and a half 400g (14oz) tins chopped tomatoes.
salt and pepper
300g (12oz) cooked bacon joint cut into 1cm (½")cubes.

- 1 Put the carrots, potatoes and onions into the blender in that order.
- 2 Add bacon stock up to 1½ litre mark.
- 3 Blend for no more than 5 secs.
- 4 Pour into a saucepan. Then add the lentils, tomatoes, vegetables, stock and seasoning.
- 5 Bring to the boil, stirring constantly. Then simmer for about 1 hour, stirring regularly, until the ingredients are cooked.
- 6 Add the bacon cubes and heat through for 5- 10minutes. Serve immediately.

lasagne

300g (12oz) braising steak, cubed.
400g can of tomatoes
30mls (2tbsp) tomato puree
1 onion
5mls (1tsp) basil
100g (4oz) lasagne
200g (8oz) mozzarella cheese
15mls (1tbsp) oil
salt and pepper

- 1 Grate the cheese using the shredding disc.
- 2 Then separately chop the meat and onions with the knife blade.
- 3 Pre-heat the oil and fry the onions until softened, add the meat and fry until brown.
- 4 Then add the tomatoes, tomato puree and seasonings.
- 5 Stir well, cover and simmer gently for about 40minutes.
- 6 Cook the lasagne in plenty of salted boiling water until tender. Then drain well.
- 7 Place layers of meat, lasagne and cheese in a 1litre/2pint oven proof dish. Finish with a layer of cheese.
- 8 Bake at 190°C/375°F/Gas Mark 5 for 30minutes or until golden and bubbling.

victoria sandwich

150g (6oz) soft margarine
150g (6oz) caster sugar
150g (6oz) self raising flour
5mls (1tsp) baking powder
3 eggs
15mls (1tbsp) warm water

filling & decoration

3tbsp strawberry jam
150mls (¼pt) double cream whipped (optional)
1tbsp icing sugar or caster sugar

- 1 Pre-heat the oven to 180°C/350°F/Gas mark 4 and grease two 18cm(7") shallow cake tins.
- 2 Fit the knife blade. Place all the ingredients for the sponge in the bowl and process for 5 seconds. Using a spatula, scrape the mixture into the centre of the bowl and process for a further 5 seconds.
- 3 Pour the mixture into the prepared tins and bake for 20-25minutes or until firm to a light touch and coming away from the edges slightly. If you are unsure whether the cake is cooked insert a thin skewer in the centre and it should come out clean. Turn out onto a wire cooling rack.
- 4 When cool spread the jam and cream over one of the cakes, top with the other cake and sprinkle with the sugar.

fruit cake

125g (5oz) block margarine (cut into cubes)
125g (5oz) caster sugar
2 eggs
80 - 100mls (5-6tbsp) milk
275g (11oz) mixed fruit
200g (8oz) self raising flour
5mls (1tsp) mixed spice

- 1 Fit the knife blade and place the cubed margarine and sugar in the bowl.
- 2 Mix until smooth, light and fluffy, scraping down as necessary.
- 3 Add the eggs one at a time.
- 4 Add the flour, spices and milk. Pulse until ingredients combined.
- 5 Add the fruit using the pulse.
- 6 Pour the mixture into a greased and lined 7"/18cm round cake tin. Bake in a preheated oven 150°C/300°F/Gas Mark 2 for approximately 2 hours or until cooked. Turn out of the tin when cool.

whisked sponge

3 eggs
75g/3oz caster sugar
75g/3oz plain flour (sieved twice)

- 1 Fit the twin beater geared whisk and add the sugar and eggs into the bowl.
- 2 Whisk until the mixture is thick and leaves a trail.
- 3 Fold the flour in carefully by hand using a metal spoon.
- 4 Pour the mixture into a deep lined and greased 7"/18cm cake tin. Bake in a preheated oven at 190°C/375°F/Gas Mark 5 for approximately 25minutes or until the cake springs back when touched.
- 5 Remove from the tin and cool on a wire rack.

white bread

500g(1lb 2oz) strong white bread flour
5mls (1tsp) salt
15g(½oz) lard
15g (½oz) fresh yeast or 10mls(2tsp) dried yeast + 5mls (1tsp) caster sugar.
300mls (11fl oz) warm water, 100mls (3½ fl oz) boiling water to 200mls (7½ fl oz)
cold water

- 1 **Dried yeast (the type that needs reconstituting):** Add the yeast and sugar to the warm water. Leave to stand for 5 - 10 minutes until frothy.
Fresh yeast: crumble into the flour
Other types of yeast: follow the manufacturer's instructions.
- 2 Fit the dough tool or knife blade and add the flour (with fresh yeast if used), salt and lard. Process for a few seconds to evenly distribute the ingredients.
- 3 Then with the motor running quickly pour the liquid in a steady stream down the feed tube until the mixture forms an elastic soft dough. This will take about 45 - 60 seconds.
- 4 Remove the dough, place in a bowl, cover with an oiled piece of clingfilm or a plastic bag, and leave in a warm place for 45 - 60 minutes or until doubled in size.
- 5 Re-knead by hand for 2-3 minutes. Re-kneading in the bowl is not recommended as it may cause the processor to become unstable. Shape into a loaf or 15 rolls and place on greased baking trays and leave until double in size.
- 6 Then bake in a pre-heated oven at 230°C/450°F/Gas mark 8 for 20 - 25 minutes for the loaf or 10 - 15 minutes for bread rolls. When ready they should sound hollow when tapped on the base.



Kenwood Limited, New Lane, Havant, Hampshire PO9 2NH, UK
www.kenwood.co.uk

Free Manuals Download Website

<http://myh66.com>

<http://usermanuals.us>

<http://www.somanuals.com>

<http://www.4manuals.cc>

<http://www.manual-lib.com>

<http://www.404manual.com>

<http://www.luxmanual.com>

<http://aubethermostatmanual.com>

Golf course search by state

<http://golfingnear.com>

Email search by domain

<http://emailbydomain.com>

Auto manuals search

<http://auto.somanuals.com>

TV manuals search

<http://tv.somanuals.com>