

KENWOOD

CD PLAYER

DP-R5070



INSTRUCTION MANUAL

KENWOOD CORPORATION

For your records

Record the serial number, found on the back of the unit, in the spaces designated on the warranty card, and in the space provided below. Refer to the model and serial numbers whenever you call upon your dealer for information or service on this product.

Model _____ Serial Number _____

Unpacking

Unpack the unit carefully and make sure that all accessories are put aside so they will not be lost.

Examine the unit for any possibility of shipping damage. If your unit is damaged or fails to operate, notify your dealer immediately. If your unit was shipped to you directly, notify the shipping company without delay. Only the consignee (the person or company receiving the unit) can file a claim against the carrier for shipping damage.

We recommend that you retain the original carton and packing materials for use should you transport or ship the unit in the future.

Accessories

Audio cord 1 Batteries (R6/AA) 2

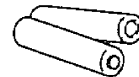

System control cord 1

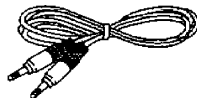

Remote control unit 1



AC plug adaptor 1

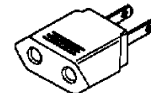

(Except for U.S.A., Canada and Australia.)

Contents

Caution: Read the pages marked carefully to ensure safe operation.

Special features 2	Playing desired tracks in desired order 10
Before applying power 2	Repeated play 12
Safety precautions 2	Random play 13
Before operation 3	Playing tracks in a random order 13
System connections 4	Editing 14
Controls and indicators 6	Normal EDIT 14
Operation of remote control unit 7	MULTI EDIT 15
Manual play 8	Program file 17
Playing a CD from the beginning 8	Timer operation 18
Listening from the desired track 9	In case of difficulty 19
Programmed play(PGM mode) 10	Specifications 20

B60-2007-00 (S) (K, P, X, Y, M) (AP)

Special features

Adoption of mechanism that enables disc changing even during Playback	4 other discs can be changed not only when the unit is stopped, but also during playback. (Refer to page 9.)
Programmed play	The program mode allows you to play desired tracks in the order you want to hear them. A maximum of 32 selections can be entered in memory. (Refer to page 10.)
Program file	The programmed contents of up to 100 discs can be stored in the program file (up to 16 songs per disc). (Refer to page 17.)
MULTI EDIT	Several CDs can be edited and recorded on 1 tape. (Refer to page 15.)

Before applying power

 **Caution: Read this section carefully to ensure safe operation.**

Units are designed for operation as follows.

U.S.A. and Canada	120 V only
Australia	240 V only
Europe and U.K.	230 V only
*Other countries	110-120 / 220-240 V switchable

For the United Kingdom

Factory fitted moulded mains plug

1. The mains plug contains a fuse. For replacement, use only a 13-Amp ASTA-approved (BS1362) fuse.
2. The fuse cover must be refitted when replacing the fuse in the moulded plug.
3. Do not cut off the mains plug from this equipment. If the plug fitted is not suitable for the power points in your home, or the cable is too short to reach a power point, then obtain an appropriate safety approved extension lead or adaptor, or consult your dealer. If nonetheless the mains plug is cut off, remove the fuse and dispose of the plug immediately, to avoid a possible shock hazard by inadvertent connection to the mains supply.

IMPORTANT

The wires in the mains lead are coloured in accordance with the following code.

Blue : Neutral
Brown : Live

Do not connect those leads to the earth terminal of a three-pin plug.

* AC voltage selection

The AC voltage selector switch on the rear panel is set to the voltage that prevails in the area to which the unit is shipped. Before connecting the power cord to your AC outlet, make sure that the setting position of this switch matches your line voltage. If not, it must be set to your voltage in accordance with the following direction.

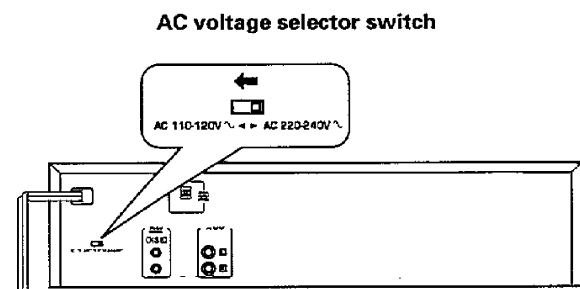





Move switch lever to match your line voltage with a small screwdriver or other pointed tool.

Note: Our warranty does not cover damage caused by excessive line voltage due to improper setting of the AC voltage selector switch.

Safety precautions

 **Caution: Read this section carefully to ensure safe operation.**

WARNING: TO PREVENT FIRE OR ELECTRIC SHOCK, DO NOT EXPOSE THIS APPLIANCE TO RAIN OR MOISTURE.

	<p>CAUTION RISK OF ELECTRIC SHOCK DO NOT OPEN</p>		<p>CAUTION: TO REDUCE THE RISK OF ELECTRIC SHOCK, DO NOT REMOVE COVER (OR BACK). NO USER-SERVICEABLE PARTS INSIDE, REFER SERVICING TO QUALIFIED SERVICE PERSONNEL.</p>
	<p>THE LIGHTNING FLASH WITH ARROWHEAD SYMBOL, WITHIN AN EQUILATERAL TRIANGLE, IS INTENDED TO ALERT THE USER TO THE PRESENCE OF UNINSULATED "DANGEROUS VOLTAGE" WITHIN THE PRODUCT'S ENCLOSURE THAT MAY BE OF SUFFICIENT MAGNITUDE TO CONSTITUTE A RISK OF ELECTRIC SHOCK TO PERSONS.</p>		
	<p>THE EXCLAMATION POINT WITHIN AN EQUILATERAL TRIANGLE IS INTENDED TO ALERT THE USER TO THE PRESENCE OF IMPORTANT OPERATING AND MAINTENANCE (SERVICING) INSTRUCTIONS IN THE LITERATURE ACCOMPANYING THE APPLIANCE.</p>		

Before operation

Disc handling precautions

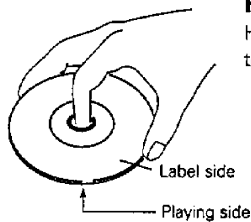

Handling

Hold compact discs so that you do not touch the playing surface.

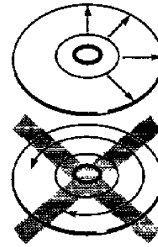

Cleaning

If fingerprints or foreign matter become attached to the disc, lightly wipe the disc with a soft cotton cloth (or similar) from the center of the disc outwards in a radial manner.



Do not attach paper or tape to either the playing side or the label side of compact discs.

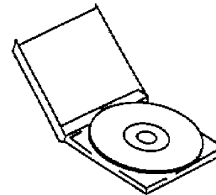

Storage

When a disc is not to be played for a long period of time, remove it from the CD player and store it in its case.

Caution on disc used



Never play a cracked or warped disc.

During playback, the disc rotates at high speed in the player. Therefore, to avoid danger, never use a cracked or deformed disc or a disc repaired with tape or adhesive agent.

Discs which can be played with this unit

CD (12 cm, 8 cm), CDV (only the audio part)

- With CD-G (CD Graphics) discs, this unit can play only the audio.

Note related to transportation and movement

Before transporting or moving this unit, carry out the following operations.

1. Turn the power ON but do not load a disc.
2. Wait a few seconds and verify that the display shown appears. Wait further a few seconds.
3. Turn the power OFF.

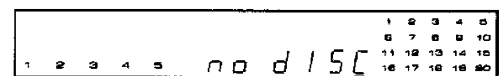

Beware of condensation

When water vapor comes into contact with the surface of cold material, water drops are produced.

If condensation occurs, correct operation may not be possible, or the unit may not function correctly.

This is not a malfunction, however, the unit should be dried.

(To do this, turn the POWER switch ON and leave the unit as it is for several hours.)

Be specially careful in the following conditions.

- When the unit is brought from a cold place to a warm place, and there is a large temperature difference.
- When a heater starts operating.
- When the unit is brought from an air-conditioned place to a place of high temperature with high humidity.
- When there is a large difference between the internal temperature of the unit and ambient temperature, or in conditions where condensation occurs easily.

System connections

Make connections as shown below. When connecting the related system components, refer also to the instruction manuals of the related components.
Do not plug in the power lead until all connections are completed.

Malfunction of microcomputer

If operation is not possible or erroneous display appears even though all connections have been made properly, reset the microcomputer referring to "In case of difficulty".

■ Connection to a general-use amplifier

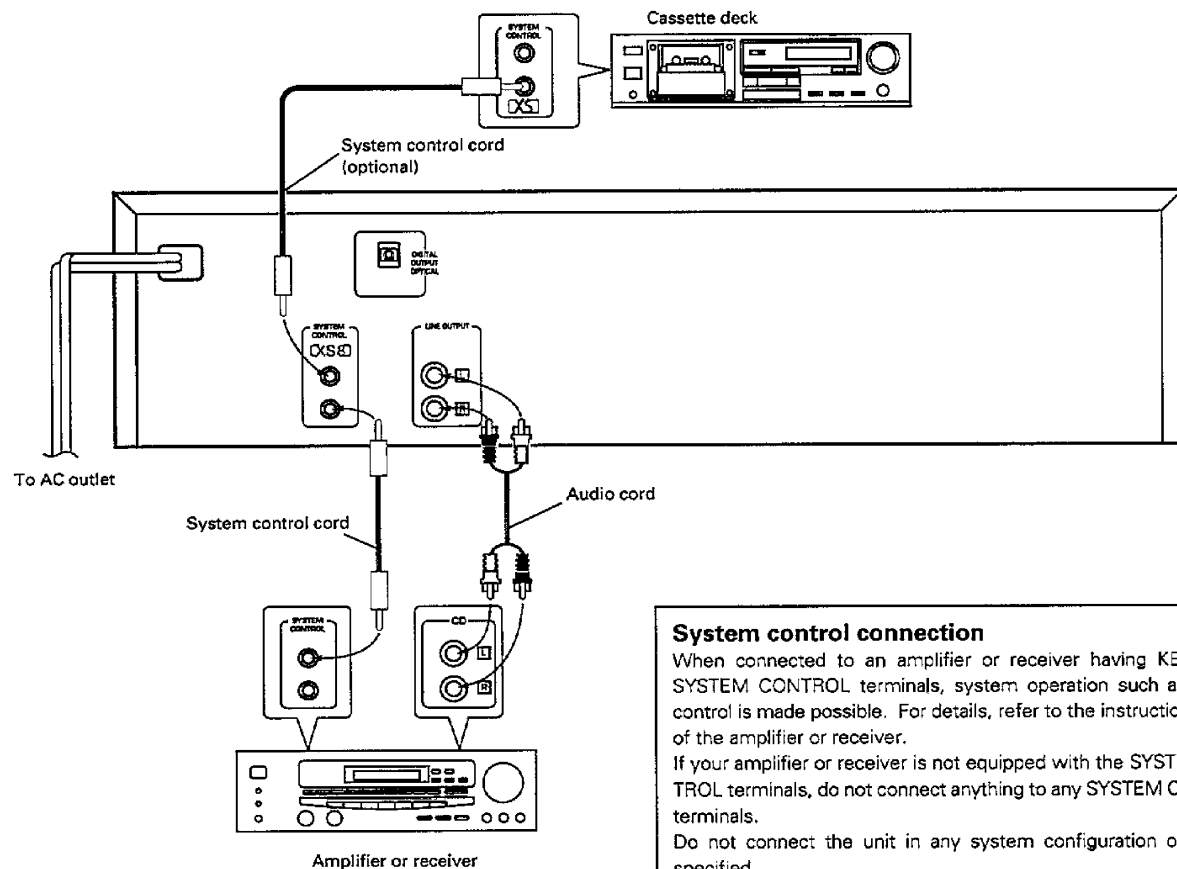

System control connection

When connected to an amplifier or receiver having KENWOOD SYSTEM CONTROL terminals, system operation such as remote control is made possible. For details, refer to the instruction manual of the amplifier or receiver.

If your amplifier or receiver is not equipped with the SYSTEM CONTROL terminals, do not connect anything to any SYSTEM CONTROL terminals.

Do not connect the unit in any system configuration other than specified.

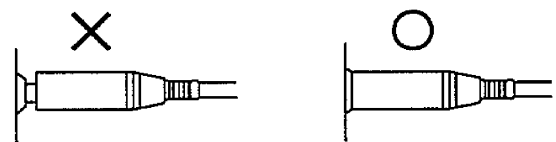

- Be sure to insert the system control cord plugs fully into the SYSTEM CONTROL terminals.
- If the system control cord and audio cords are not connected properly, the automatic system governing remote control and system functions will not operate.

CCRS

By connecting the SYSTEM CONTROL terminal of this unit with the "XS" SYSTEM CONTROL terminal of a KENWOOD cassette deck, CCRS recording can be carried out.

The CCRS function is used when recording from a CD to a tape in a cassette deck, and operates to adjust the cassette deck's recording level to the optimum setting according to the playing level of the CD. For details on the CCRS function, refer to the instruction manual provided with your cassette deck.

Notes:

1. Connect all cords firmly. If connections are loose, there could be loss of sound or noise produced.
2. When plugging and unplugging connection cords, be sure to first remove the power cord from the AC outlet.
Plugging/unplugging connection cords without removal of the power cord can cause malfunctions or damage to the unit.

■ Connection to digital components

The OPTICAL DIGITAL OUTPUT jack converts the digital codes of the audio signal into light signals for output. Connect this unit with a commercial optical fiber cable to the OPTICAL INPUT jack of a DAT, an MD recorder, etc.

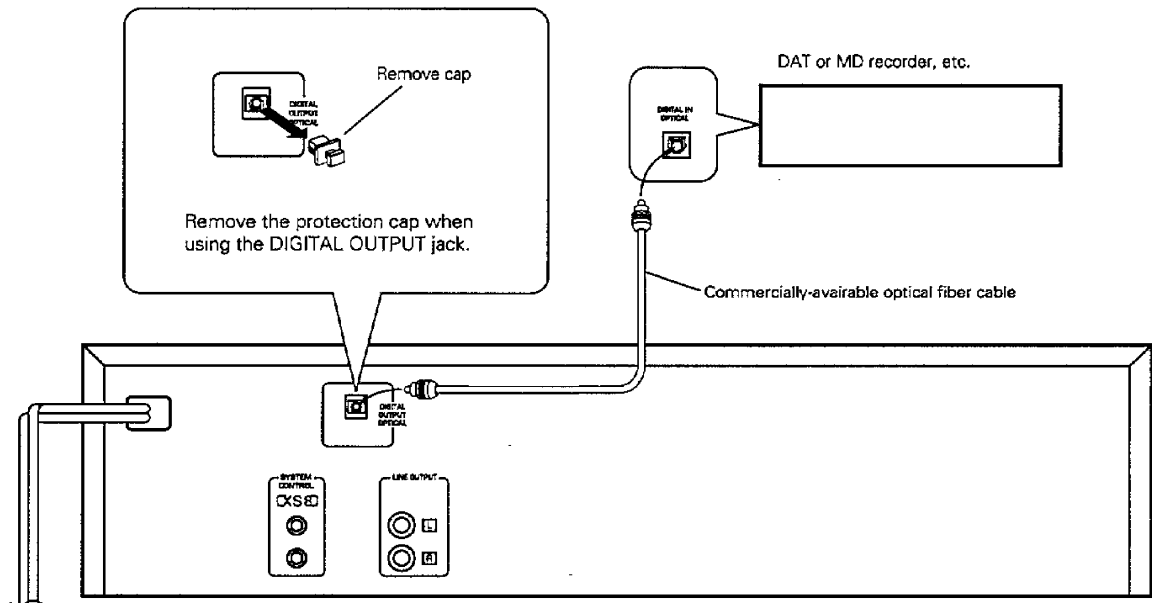

Optical fiber cable connection

1. When using an optical fiber cable to connect this unit to a digital amplifier, insert the plug straight into the jack until a snap sound is heard.
2. Be careful not to bend, coil, or bundle the optical fiber cable.
3. Optical fiber cables available on the market may not always be able to be used with this player. If your cord cannot be used with this unit, consult the store from which you purchased the cord or your nearest dealer.

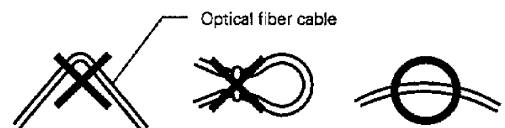

Controls and indicators

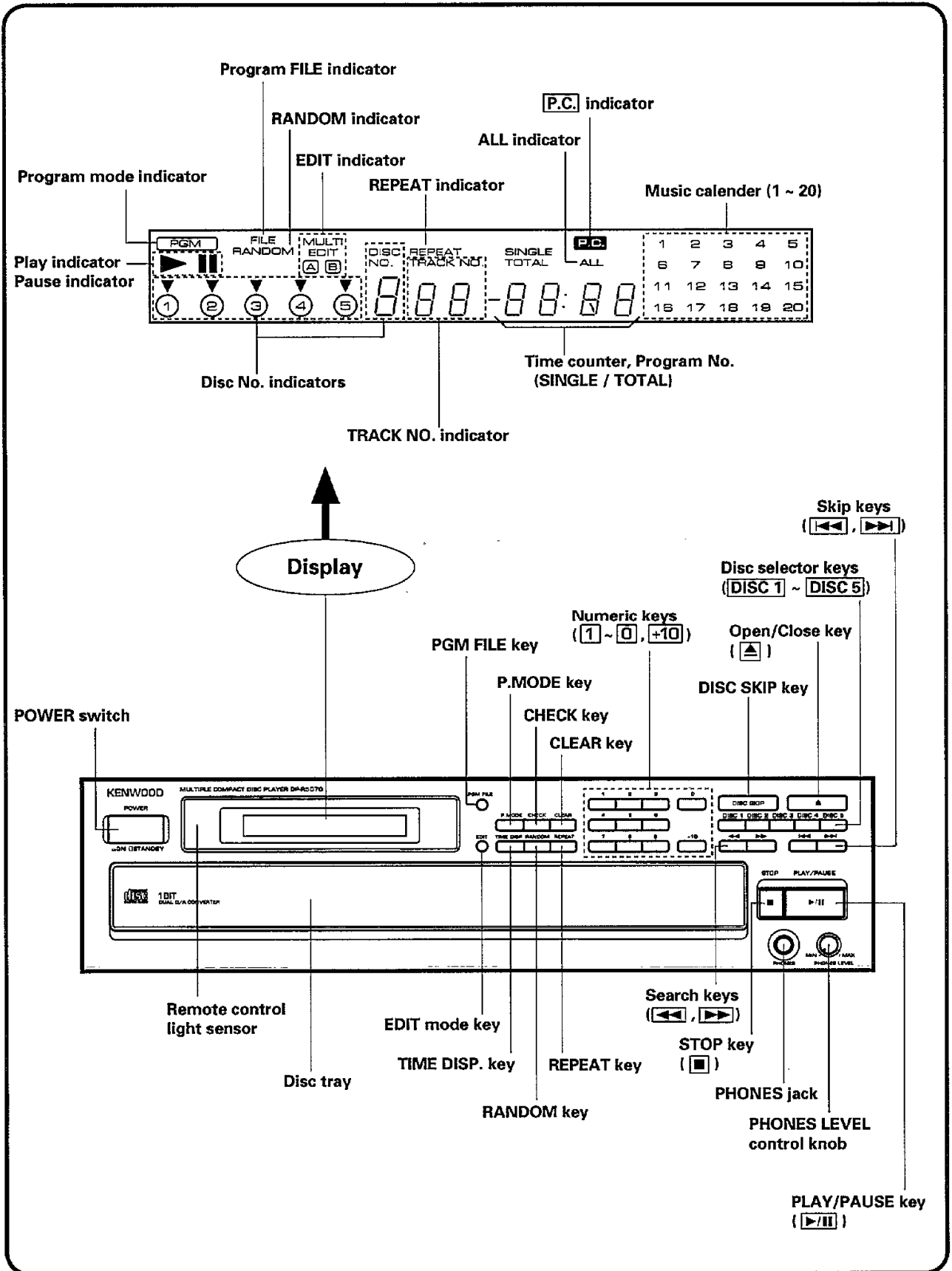

Operation of remote control unit

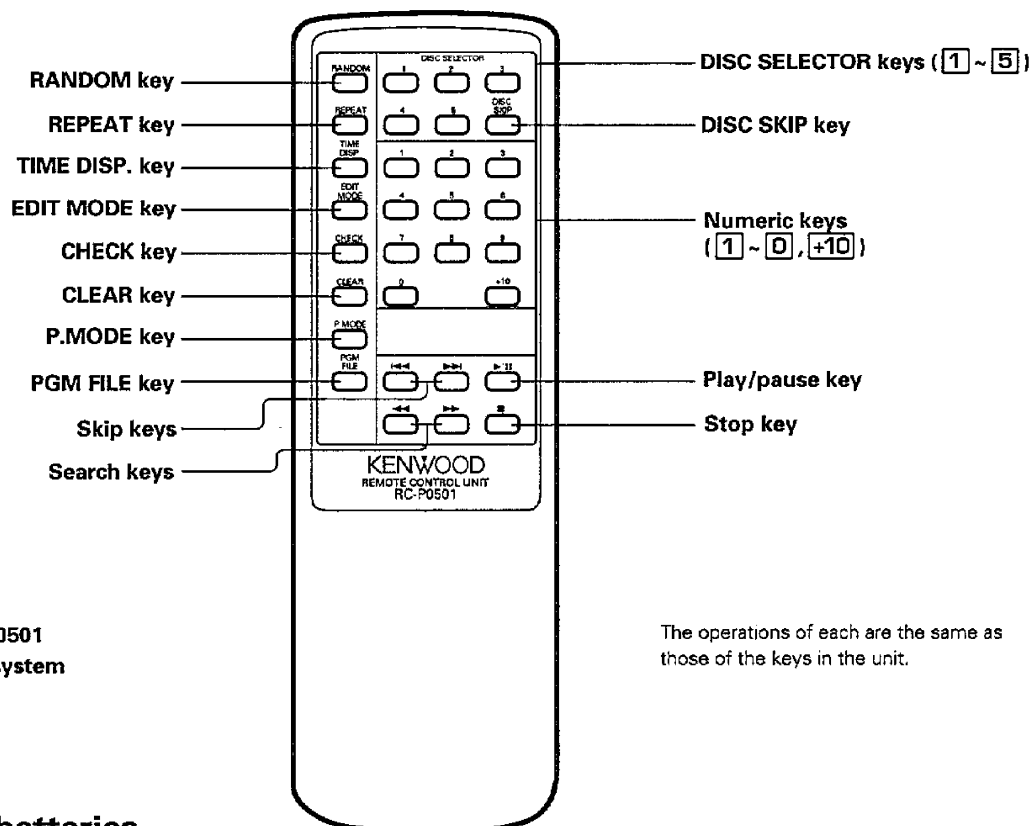

■ Loading batteries

- 1 Remove the cover.**
- 2 Insert batteries.**

 - Insert two AA-size (R6/SUM-3) batteries as indicated by the polarity marking.
- 3 Close the cover.**

Operating range

Approx. operating range

- When two operation keys on the remote control unit are pressed successively, press each key securely reserving an interval of more than 1 second for each press.

Notes:

1. The supplied batteries are intended for use in operation checks. Therefore, their lives may be shorter than ordinary batteries.
2. When the remote-controllable distance gets shorter than before, replace both batteries with new ones.
3. Malfunction may occur if direct sunlight or the light of a high-frequency lighting fluorescent lamp enters the remote control light sensor. In such a case, change the system installation position to prevent the malfunction.

Manual play

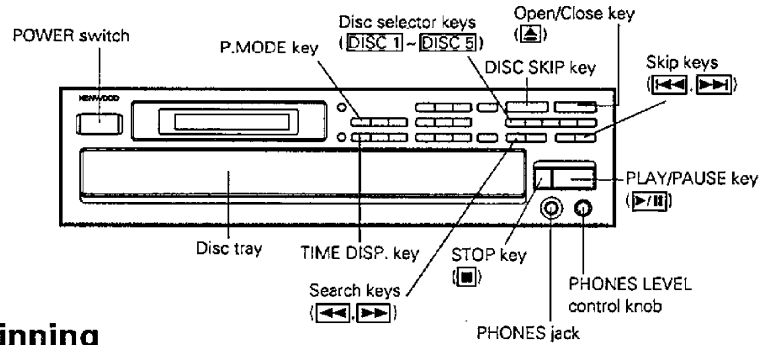

■ Playing a CD from the beginning

1 Press the POWER switch to ON.

2 Load a CD.

① Open the disc tray.

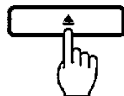

➔

② Place a disc on the tray.

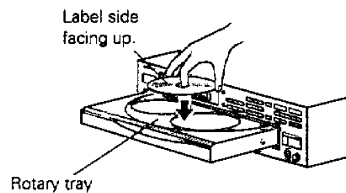

- When inserting three or more discs, use the DISC SKIP key to rotate the tray. Up to five discs may be inserted.
- When inserting a disc while the tray rotates, a malfunction might occur. Insert the disc when the tray does not rotate.



Hold the disc taking care not to touch the side to be played.

3 Close the tray.

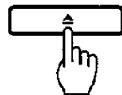

All disc indicators "O" light regardless of how many discs are present.

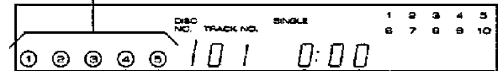

4 Start playback.

Select the disc.



If there is no disc in the selected disc tray, the corresponding indicator goes out.

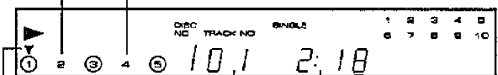

Disc indicator during Playback (▼)

Track No. being played

Elapsed time from the beginning of track being played

- Play will commence from the disc selected. When two or more discs are inserted, the discs will be played in ascending order from disc 1.
- When the PLAY/PAUSE key (▶||) is pressed without selecting a disc, playback will start from the indicated DISC NO.

To pause CD play



Lights up

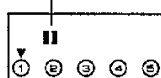

To resume playback, press the (▶||) key again.

To stop CD play



■ Listening from the desired track

1 Make sure the **PGM** indicator is extinguished.



PGM indicator goes off.

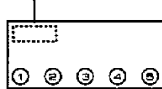

- If the **PGM** indicator is lighted, press the **P.MODE** key.

2 Select the desired disc.

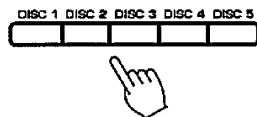

3 Select the desired track.

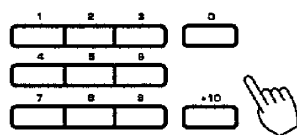

Examples of input

Track No. 7: **7**

Track No. 11: **+10** **1**

Track No. 20: **+10** **+10** **0**

- Play starts from the selected tune and after.

To skip tracks



- When the **[<<]** key is pressed once during play, the track starts again from the beginning.

To fast forward and backward

Fast-reverse

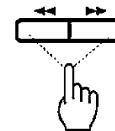

Fast-forward

- The track will start to play from where you release the key.

■ Changing Discs

During playback:

① Open the disc tray.

- Press the **[▲]** key.

② Change discs.

- During playback of disc ①, discs ③ and ④ can be changed.
- When changing disc ② or ⑤, press the **DISC SKIP** key and rotate the rotary tray.

Rotary tray

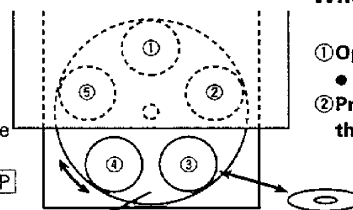

When the unit is stopped:

① Open the disc tray.

- Press the **[▲]** key.

② Press the **DISC SKIP** key, rotate the rotary tray, and change discs.

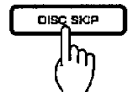

■ Listening through headphones

1 Insert the headphone plug into the headphones jack.

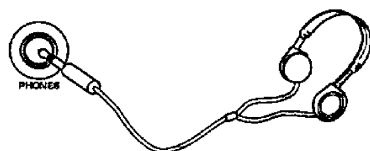

2 Adjust the volume.



Programmed play (PGM mode)

The program mode allows you to play desired tracks in the order you want to hear them. A maximum of 32 selections can be entered in memory.

■ Playing desired tracks in desired order

1 Press the STOP key.



2 Enter the PGM mode.

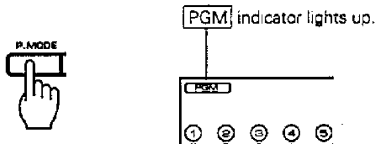

3 Program desired tracks in desired order.

Example: Select track 5 on DISC 4.

① Select the disc.

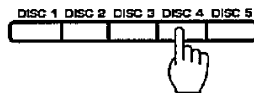

② Select the track number.

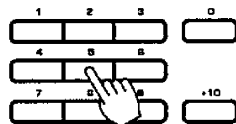

- By repeating steps ① and ②, up to 32 tracks may be selected. If "FULL" is displayed, no further programming can be accepted.
- If you made a mistake, press the **CLEAR** key and select the correct track.

To program all tracks on a disc:

- By pressing the **P.MODE** key without selecting track numbers, all the tracks on the disc selected in step ① will be programmed.

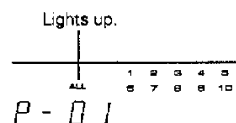

4 Start playback.



- If one of the skip keys (**▶▶** or **◀◀**) is pressed during programmed playback, the track being played is skipped in the forward or reverse direction.

To check the programmed order

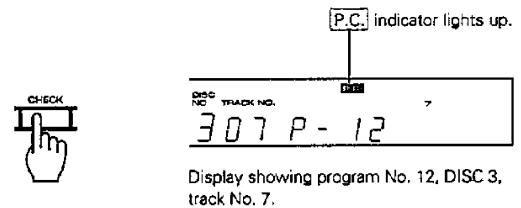

Display showing program No. 12, DISC 3, track No. 7.

- Every time the **CHECK** key is pressed, the track No. and the order it was programmed (P-No.) are displayed in the order of programming.
- The previous display will resume in a few seconds.

To resume normal playback



- The playback in the order of the track Nos. on CD will start after the track being played.

To stop programmed playback



■ To add a track to the program

1 Press the STOP key.



2 Select the track No. to be added.

① Select the disc.

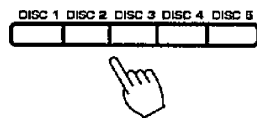

② Select the track number.

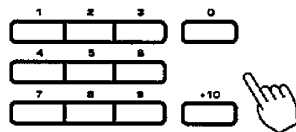

Examples of input

Track No. 7: **7**

Track No. 11: **+10 1**

Track No. 20: **+10 +10 0**

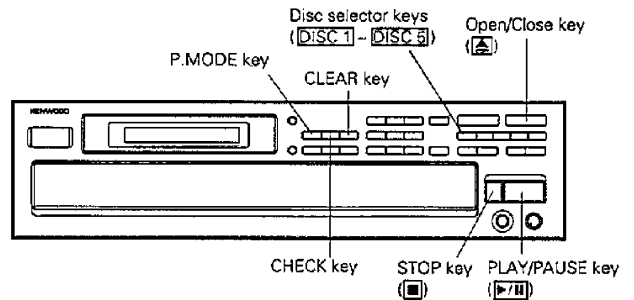

■ To change a track in the program

1 Press the STOP key.



2 Press the CHECK key.



P.C. indicator lights up.

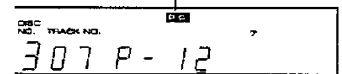

Press until the P.No. to be changed is displayed.

3 Select the track No. to replace the previous one.

① Select the disc.

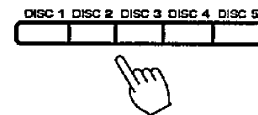

② Select the track number.

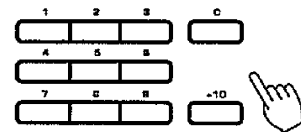

Examples of input

Track No. 7: **7**

Track No. 11: **+10 1**

Track No. 20: **+10 +10 0**

■ To clear tracks from the program

Clearing from the last track



- Every time the key is pressed, tracks are cleared from the last track in order.
- The track being played cannot be cleared.

Clearing the whole program

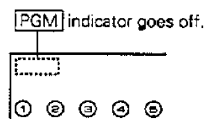

- Selected tracks can be also completely cleared just by pressing the **Open/Close** key.

Auto-Space function

In the program mode, a space of about 4 seconds is inserted automatically between the programmed tracks. This function is provided to facilitate the DPSS function of the cassette deck. However, such a space may also be inserted in case the sound of two tracks are continued, for example with some classic music and live recordings.

Repeated play



■ Repeated playback

One-disc repeat

- 1 Press the STOP key.**

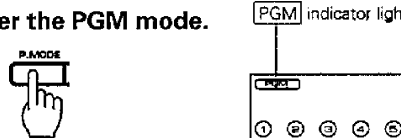

- 2 Enter the PGM mode.** PGM indicator lights up.

- 3 Select the desired disc.**

①  → ② 

Press the [P.MODE] key once again.
- 4 Press the REPEAT key.** REPEAT indicator lights up.



- 5 Start playback.**



Repeated playback of programmed tracks

- 1 Press the STOP key.**

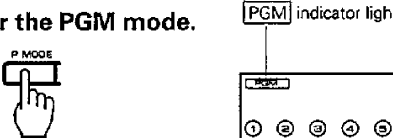

- 2 Enter the PGM mode.** PGM indicator lights up.

- 3 Select the desired track(s).**

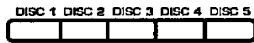
① **Select the disc.**

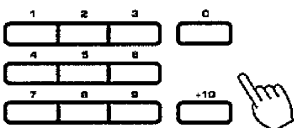

② **Select the track number.**

 - All of the selected tracks will be played repeatedly.
 - If only one track is selected, that track will be played repeatedly.

4 Press the REPEAT key. REPEAT indicator lights up.

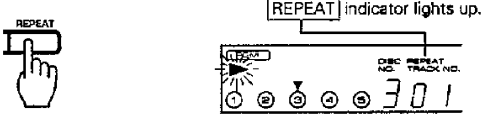

5 Start playback.

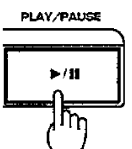

All-disc repeat

- 1 Make sure the PGM indicator is extinguished.**

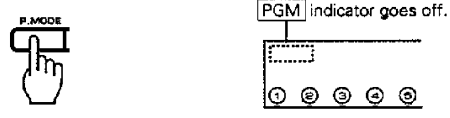

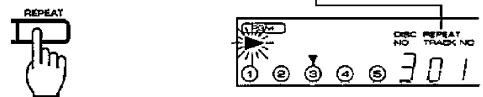
- 2 Press the REPEAT key.** REPEAT indicator lights up.

- 3 Start playback.**

 - All tracks on all discs in the tray will be played repeatedly.

To stop repeat play

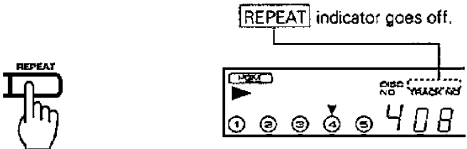
Press the [REPEAT] key again.



Random play

The random play function chooses tracks at random (non-selected), and in differing order.

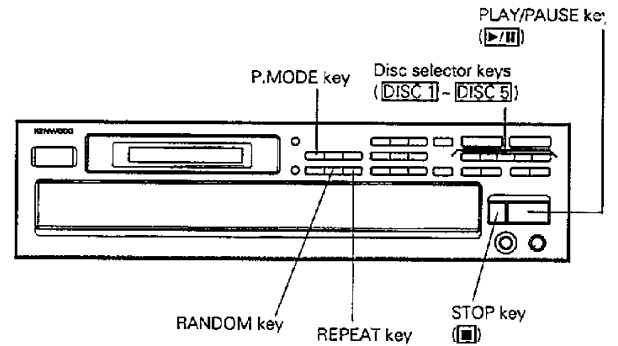

■ Playing tracks in a random order

1 Make sure the PGM indicator is extinguished.



PGM indicator goes off.

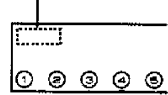

- If the PGM indicator is lighted, press the P.MODE key.

2 Press the RANDOM key.



During random track selection

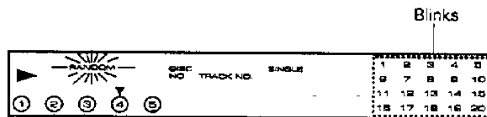

During random selection play

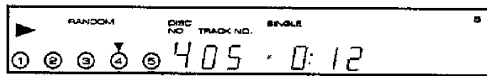

- Tracks from all the disc(s) in the tray will be played randomly.
- When the first track has been played, another track is selected at random again, and played.
- Random play stops after all of the tunes have been played once.
- If the REPEAT key is pressed, random play operation is repeated continuously.

To select another track during random play

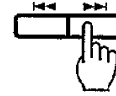

To cancel random play

Press any one of these keys.

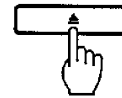

- Normal play starts from the track being played.

- Playback stop.

TIME DISPLAY

Press the TIME DISP. key when you want to check the elapsed time and remaining time of the track being played. Every time the TIME DISP. key is pressed, the displayed time changes as shown below.

During random play or programmed play, display will show SINGLE TIME only.

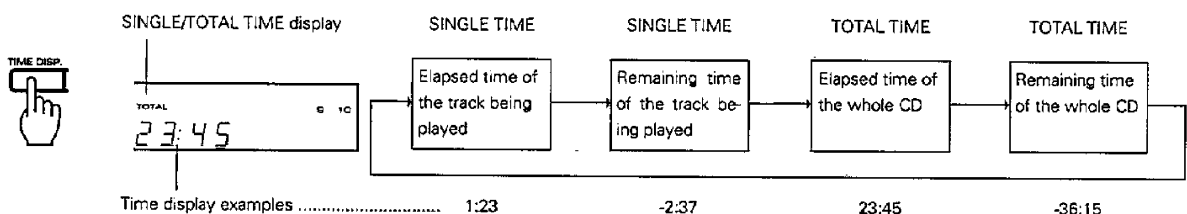

Editing

Normal EDIT: Edit from one disc.
MULTI EDIT: Edit and record from several discs.

Normal EDIT

This function is for editing when you are recording the contents of a CD onto a tape. It is to ensure that the final track on each side of the tape is fully recorded and that the possible recording time on the tape will be fully used.

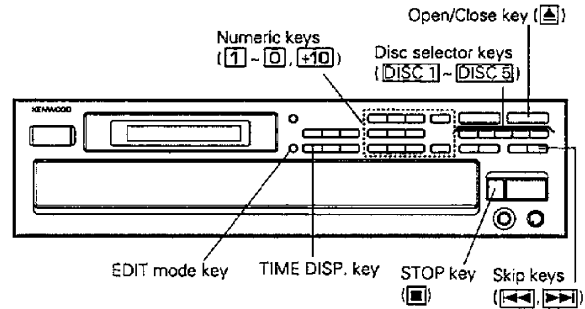

1 Press the STOP key.

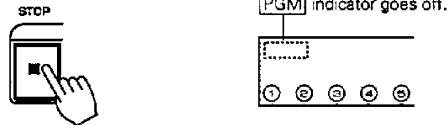

- Make sure the PGM indicator is extinguished.

2 Press the EDIT mode key.

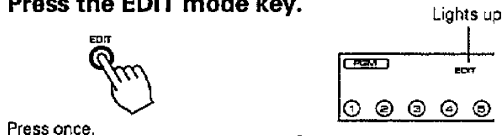

3 Select the disc to be edited (one disc only).

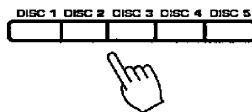

- The edit function cannot be used for two or more discs.

4 Input the recording time of the tape.

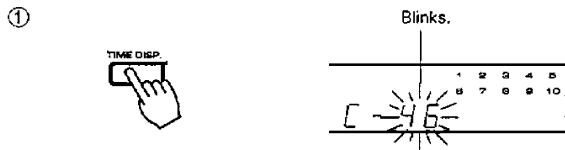

- By pressing the TIME DISP key the set time-length intervals will change in this order: 46→54→60→90→---
- When "--" is displayed, the interval length can be adjusted with the skip keys [▶] and [◀] in units of one minute (to a maximum of 99 minutes).

[▶] : increase by one minute.
 [◀] : decrease by one minute.

② Press the EDIT mode key once again.



Entry of the tape time with the numeric keys:

Press the numeric keys as shown below.

30-minute tape: [+10] [+10] [+10] [0]

46-minute tape: [+10] [+10] [+10] [+10] [6]

- When the interval length has been set using the numeric keys, the EDIT key does not have to be pressed after the interval has been set.

The CD contents are edited as follows.

- (1) The input tape recording time is divided by two, and tracks that can be accommodated in file A (which refers to tracks on tape side A) are selected in order of their track Nos.

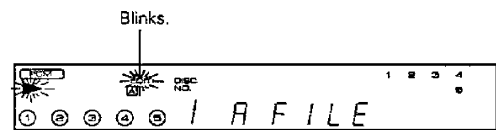

- (2) In a few seconds, the time left on tape side A is displayed, then file B (tracks on tape side B) is edited in the same manner.

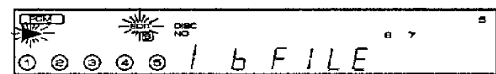

- If the [STOP] key or [Open/Close] key is pressed during editing, editing will be suspended and the function will be terminated.

Completion of editing

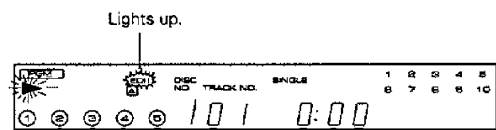

The order of CD tracks are changed automatically so that no tunes is interrupted at the end of tape sides A and B.

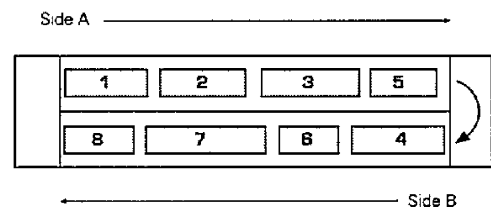

■ MULTI EDIT

Several CDs can be edited and recorded on 1 tape. Choose songs from each disc, and edit/record while confirming the remaining time on files A and B, respectively.

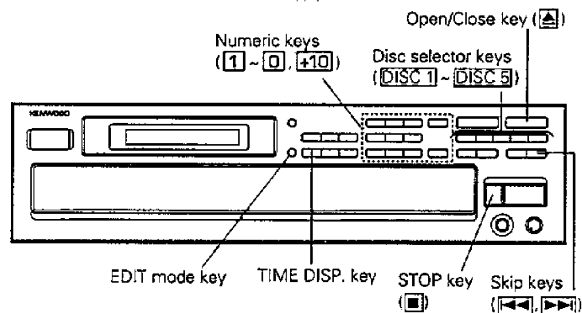

1 Press the STOP key.

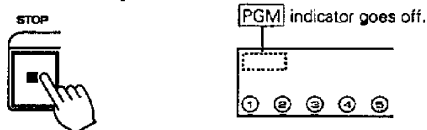

- Make sure the **PGM** indicator is extinguished.

2 Press the EDIT mode key.

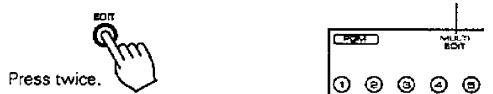

3 Input the recording time of the tape.

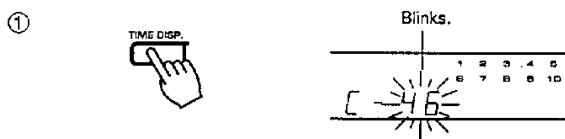

- By pressing the **TIME DISP.** key the set time-length intervals will change in this order: 46→54→60→90→--
- When "--" is displayed, the interval length can be adjusted with the skip keys **▶▶** and **◀◀** in units of one minute (to a maximum of 99 minutes).
 - ▶▶** : increase by one minute.
 - ◀◀** : decrease by one minute.

② Press the EDIT mode key once again.



Entry of the tape time with the numeric keys:

Press the numeric keys as shown below.

30-minute tape: **+10 +10 +10 0**

46-minute tape: **+10 +10 +10 +10 6**

- When the interval length has been set using the numeric keys, the **EDIT** key does not have to be pressed after the interval has been set.

4 Select the disc to be edited (one disc only).

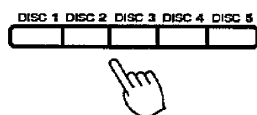

5 Select the tracks to be recorded.

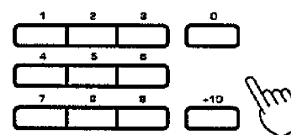

- If you made a mistake, press the **CLEAR** key and select the correct track.
- The time remaining on side A or side B is indicated on the display.
- When the time left on side A is less than the play time of the selected song, that song will be programmed on side B.
- If "b-FULL" is displayed, no further programming can be accepted.

6 Recording

When recording with a cassette deck equipped with CCRS function:

Press the CCRS key.

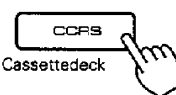

- With the CCRS function, the recording starts after about 1 minute.
- If you have a cassette deck capable of Double-speed recording, use Normal-speed recording.

When recording with a normal cassette deck:

- ① Adjust the recording levels.
- ② Press the record key.
- ③ Play the CD.

When recording the 2nd and 3rd discs, repeat steps 4 - 6.

- Change discs and, if the "b-01" indication is given when you first select a song, turn the tape to the start of side B.

Recording occurs as shown below (example when three CDs are to be recorded).

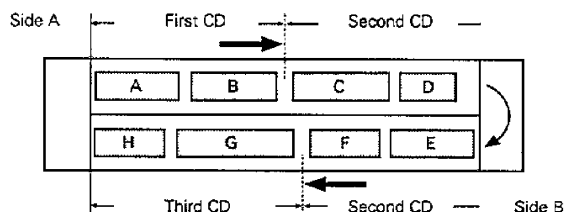

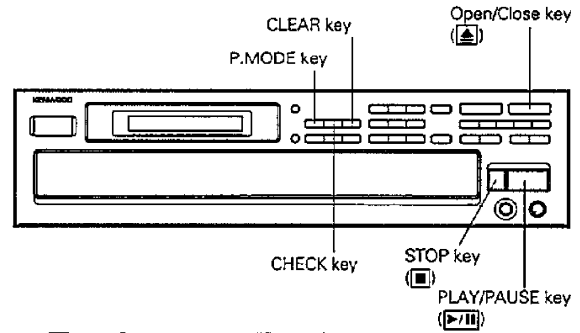

■ To check the edited contents

Press the CHECK key.

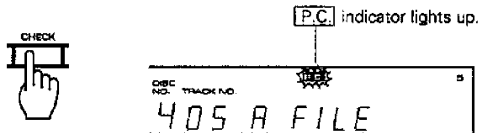

During normal EDIT:

When the [CHECK] key is pressed, the track Nos. of edited songs will automatically be displayed in the order they are edited.

During MULTI EDIT:

Every time the [CHECK] key is pressed, the track Nos. are displayed in the edited order.

■ To play an edited program

① To play the A file:

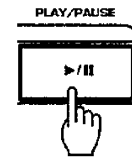

The tunes in the A file are played in sequence and the player enters pause mode at the beginning of the B file.

② To play the B file:

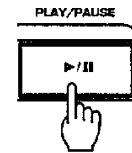

● Playback stops after having played the B file.

■ To record an edited program

The CCRS recording function may be used by connecting the CD player to any KENWOOD cassette deck with an "OX5" mark, using a system control cord. For details please refer to "Recording of CD playback" section in your cassette deck instruction manual.



● If you have a cassette deck capable of Double-speed recording, use Normal-speed recording.

■ To clear the edited contents

Normal EDIT :

Press either of these keys.

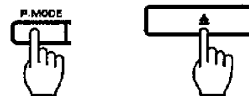

MULTI EDIT :



Notes:

1. While you can edit with a different time setting to that of the tape you are using, part of the tape may be left with nothing recorded on it, or the last track on side A or side B may be cut short.
2. Up to a maximum of 32 tracks can be edited using this function.
3. The EDIT function may not operate properly for discs having only one track or having tracks of long duration such as classical music.

Program file

The programmed contents of up to 100 discs can be stored in the program file (up to 16 songs per disc). Your favorite songs can be selected and played in order.

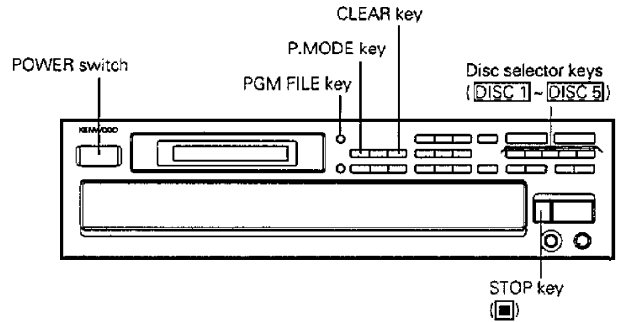

■ To create a program file

Preparation: Confirm that PGM FILE is OFF ("FILE" indicator is extinguished).

1 Select 1 disc and program your favorite songs.

Refer to page 10.
Steps 1 - 3 can be completed.

- Up to 16 tracks can be programmed per disc.
- Programming spanning between discs cannot be recorded on the program file.

2 Store the program in a program file.



When a program has been stored, the flashing light will go out.

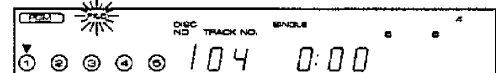

To change to another program file:

Press **P.MODE** once and extinguish the **PGM** indicator. Then press **P.MODE** again and repeat steps 1 and 2.

When 100 files have been programmed in the program file, 'FULL' is displayed.

■ Playing a program file

1 Make sure the **PGM** indicator is extinguished.

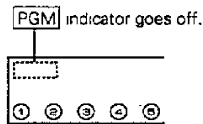

2 Press the PGM FILE key.

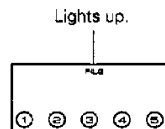

3 Select the disc you want to play.

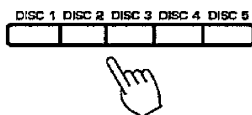

- Discs without a recorded program file will start to play back from the first track.

■ To erase program files

Erasing one specific program file

- 1 Make sure the **PGM** indicator is extinguished.
- 2 Confirm that PGM FILE is OFF ("FILE" indicator is extinguished).
- 3 Press the **PGM FILE** key.
- 4 Select the disc with the program file you want to erase.
- 5 After confirming that the "FILE" indicator is illuminated, press the **STOP** key.
- 6 Press the **CLEAR** key.

- If you want to erase another program file, repeat steps 1 - 5.

Erasing all program files

- 1 Switch the power OFF.
- 2 Turn the power ON while holding the **CLEAR** key depressed.

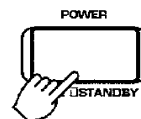

Timer operation

The unit has the timer stand-by function.

With this function and commercially-available audio timer, playback can be started at the desired time.

1 Connect the power cord.

- Connect each unit's power cord to the SWITCHED outlet of the timer
- Refer to the instruction manual of the timer.

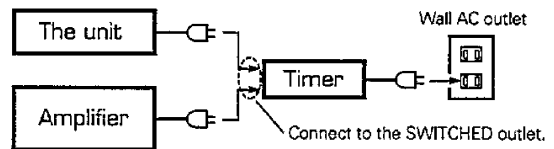

2 Turn on the amplifier and the unit.

3 Insert a disc and set the starting time of the timer.

- Set the timer while the unit and the amplifier are ON.
- Playback starts at the set time.
- Be careful of the volume setting of the amplifier. (The loud sound may damage the speakers.)

Note:

When operating the unit other than CD player using an audio timer, be sure to remove the disc from the CD player.

**The marking of products using lasers
(Except for some areas.)**

**CLASS 1
LASER PRODUCT**

The label is attached to the rear panel and says that the component uses laser beams that have been classified as Class 1. It means that the unit is utilizing laser beams that are of a weaker class. There is no danger of hazardous radiation outside the unit.

For the U.S.A.

CAUTION:

Use of controls or adjustments or performance of procedures other than those specified herein may result in hazardous radiation exposure.

In compliance with Federal Regulations, following are reproductions of labels on, or inside the product relating to laser product safety.

KENWOOD CORPORATION
2967-3, ISHIKAWA-CHO, HACHIOJI-SHI,
TOKYO, JAPAN

KENWOOD CORP. CERTIFIES THIS EQUIPMENT
CONFORMS TO DHHS REGULATIONS NO. 21
CFR 1040.10, CHAPTER I, SUBCHAPTER J.

Location: Back Panel



In case of difficulty

When appears to be a malfunction may not always be serious. If your unit should not perform as expected, consult the table below to see if the problem can be corrected before seeking help from your dealer or service representative.

Operation to reset

The microcomputer may fall into malfunction (impossibility to operate, erroneous display, etc.) when the power cord is unplugged while power is ON or due to an external factor. In this case, execute the following method to reset the microcomputer and return it to normal condition.

Unplug the power cord from the power socket and plug the power cord into the socket again.

Symptom	Cause	Remedy
No power is applied with the POWER switch ON.	<ul style="list-style-type: none"> ● Power plug is loosely connected. ● With the power plug connected to the switched AC outlet of an amplifier, the power of the amplifier is turned off. 	<ul style="list-style-type: none"> ● Insert the power plug firmly to the AC outlet. ● Turn the amplifier's power ON.
Disc is loaded, player does not play.	<ul style="list-style-type: none"> ● Disc is loaded upside down. ● Disc is loose. ● Disc is dirty. ● Disc is cracked. ● Condensation occurred on the optical lens unit. 	<ul style="list-style-type: none"> ● Load the disc again with its label side up. ● Insert disc properly. ● Wipe off the dust on the surface of the disc referring to "Disc handling precautions". ● Replace the disc with a new one. ● Leave the player for about 1 hour so that the condensation is removed.
No sound.	<ul style="list-style-type: none"> ● Disc is not loaded. ● Play mode is not entered (The play/pause indicator is not lit). ● Disc is too dirty. ● Disc is cracked. ● The connection cords are inserted loosely. 	<ul style="list-style-type: none"> ● Load a disc and press the PLAY/PAUSE key . ● Press the PLAY/PAUSE key . ● Wipe off the dust on the disc surface referring to "Disc handling precautions". ● Replace the disc with a new one. ● Connect all connection cords firmly.
Music is interrupted. (Sound is skipped.)	<ul style="list-style-type: none"> ● Disc is too dirty. ● Disc is cracked. ● Oscillation is applied to this unit. 	<ul style="list-style-type: none"> ● Wipe off the dust on the disc surface referring to "Disc handling precautions". ● Replace the disc with a new one. ● Try selecting a place where no strong vibrations occur by changing the installation place, etc.
Disc begins to play when power is switched ON.	<ul style="list-style-type: none"> ● The CD player will automatically play when a disc has been inserted and power is switched ON. 	<ul style="list-style-type: none"> ● To avoid disc playing automatically, remove disc before switching off power.

Note:

Do not use contact cleaners because it could cause a malfunction. Be specially careful against contact cleaners containing oil, for they may deform the plastic components.

Specifications

[Format]

System Compact disc digital audio system
Laser Semiconductor laser
Number of channels 2 channels
Playing rotation 200 rpm - 500 rpm (CLV)

[D/A convertors]

D/A conversion 1 Bit
Oversampling 8 fs (352.8 kHz)

[Audio]

Frequency response 2 Hz ~ 20 kHz, ± 1.0 dB
Signal to noise ratio More than 96 dB
Dynamic range More than 94 dB
Total harmonic distortion + noise
..... Less than 0.005 % (at 1 kHz)
Channel separation More than 92 dB (at 1 kHz)
Wow flutter Unmeasurable limit
Output level/impedance
Fixed 2.0 V/3.3 k Ω
Headphone output (max.) 20 mW/32 Ω
Digital output
optical -15 dBm ~ -21 dBm
(Wave length 660 nm)

[General]

Power consumption 10 W
Dimensions W: 440 mm (17-5/16")
H : 119 mm (4-11/16")
D : 394 mm (15-1/2")
Weight (Net) 5.0 kg (11.0 lb)

Note:

KENWOOD follows a policy of continuous advancements in development. For this reason specifications may be changed without notice.

For CANADA DOC REGULATION

"This digital apparatus does not exceed the CLASS B limits for radio noise emissions from digital apparatus as set out in the radio interference regulations of the Canadian Department of Communications".

For the U.S.A. FCC WARNING

This equipment may generate or use radio frequency energy. Changes or modifications to this equipment may cause harmful interference unless the modifications are expressly approved in the instruction manual. The user could lose the authority to operate this equipment if an unauthorized change or modification is made.

NOTE

This equipment has been tested and found to comply with the limits for a Class B digital device, pursuant to Part 15 of the FCC Rules. These limits are designed to provide reasonable protection against harmful interference in a residential installation. This equipment may cause harmful interference to radio communications, if it is not installed and used in accordance with the instructions. However, there is no guarantee that interference will not occur in a particular installation. If this equipment does cause harmful interference to radio or television reception, which can be determined by turning the equipment off and on, the user is encouraged to try to correct the interference by one or more of the following measures:

- Reorient or relocate the receiving antenna.
- Increase the separation between the equipment and receiver.
- Connect the equipment into an outlet on a circuit different from that to which the receiver is connected.
- Consult the dealer or an experienced radio/TV technician for help.

Free Manuals Download Website

<http://myh66.com>

<http://usermanuals.us>

<http://www.somanuals.com>

<http://www.4manuals.cc>

<http://www.manual-lib.com>

<http://www.404manual.com>

<http://www.luxmanual.com>

<http://aubethermostatmanual.com>

Golf course search by state

<http://golfingnear.com>

Email search by domain

<http://emailbydomain.com>

Auto manuals search

<http://auto.somanuals.com>

TV manuals search

<http://tv.somanuals.com>