

KENWOOD

K-CD01

CD-RECEIVER

INSTRUCTION MANUAL

KENWOOD CORPORATION



© B64-2923-00/00 (M) (TKR)

Contents

Safety precautions	3	Menu system	15
WARNING		Function Set	
CAUTION		Contrast Adjustment	
NOTE		Selecting display mode	
Notes	5	Touch Sensor Tone	
About CDs	6	Security Code	
General features	7	Built-in Amp Mute Setting	
Power		Security Indicator	
Selecting the Source		Manual Clock Adjustment	
Volume		Tuning Mode	
Audio Control		Auto Memory Entry	
Defeat Setting		Text Scroll	
Switching Display		B.M.S. (Bass Management System)	
Subwoofer Output		B.M.S. Frequency Offset	
Tuner/TV control features	9	AMP Control	
Tuning		Basic Operations of remote	19
Direct Access Tuning		Accessories/ Installation Procedure	21
Station Preset Memory		Connecting Wires to Terminals	22
Auto Memory Entry		Installation	23
Preset Tuning		Removing the Unit	24
CRSC (Clean Reception System Circuit)		Troubleshooting Guide	25
Frequency Step Setting		Specifications	27
TV Tuning			
Preset TV Tuning			
TV Preset Memory			
Direct TV Tuning			
CD/External disc control features	12		
Playing CD			
Playing External Disc			
Fast Forwarding and Reversing			
Track Search			
Disc Search			
Direct Track Search			
Direct Disc Search			
Track/Disc Repeat			
Scan Play			
Random Play			
Magazine Random Play			
Text/Title Scroll			

Safety precautions

▲WARNING

To prevent injury or fire, take the following precautions:

- Insert the unit all the way in until it is fully locked in place. Otherwise it may fall out of place when jolted.
- When extending the ignition, battery, or ground wires, make sure to use automotive-grade wires or other wires with a 0.75mm² (AWG18) or more to prevent wire deterioration and damage to the wire coating.
- To prevent a short circuit, never put or leave any metallic objects (such as coins or metal tools) inside the unit.
- If the unit starts to emit smoke or strange smells, turn off the power immediately and consult your Kenwood dealer.
- Be careful not to drop the unit or subject it to strong shock.
The unit may break or crack because it contains glass parts.
- Do not touch the liquid crystal fluid if the LCD is damaged or broken due to shock. The liquid crystal fluid may be dangerous to your health or even fatal.
If the liquid crystal fluid from the LCD contacts your body or clothing, wash it off with soap immediately.

▲CAUTION

To prevent damage to the machine, take the following precautions:

- Make sure to ground the unit to a negative 12V DC power supply.
- Do not open the top or bottom covers of the unit.
- Do not install the unit in a spot exposed to direct sunlight or excessive heat or humidity. Also avoid places with too much dust or the possibility of water splashing.
- When replacing a fuse, only use a new one with the prescribed rating. Using a fuse with the wrong rating may cause your unit to malfunction.
- To prevent a short circuit when replacing a fuse, first disconnect the wiring harness.
- Do not use your own screws. Use only the screws provided. If you use the wrong screws, you could damage the unit.

Safety precautions

About CD players/disc changers connected to this unit

KENWOOD disc changers/ CD players released in 1998 or later can be connected to this unit.

Refer to the catalog or consult your Kenwood dealer for connectable models of disc changers/ CD players.

Note that any KENWOOD disc changers/ CD players released in 1997 or earlier and disc changers made by other makers cannot be connected to this unit. Unsupported connection may result in damage.

Setting the "O-N" Switch to the "N" position for the applicable KENWOOD disc changers/ CD players. The functions that can be used and the information that can be displayed will differ depending on the models being connected.



- You can damage both your unit and the CD changer if you connect them incorrectly.

LX-bus connection

The LX AMP and the sensor unit cannot be connected simultaneously.

You must connect any of them at a time.

(The power supply does not turn ON if you have connected both of them.)

NOTE

- If you experience problems during installation, consult your Kenwood dealer.
- If the unit fails to operate properly, press the Reset button. The unit returns to factory settings when the Reset button is pressed. If the unit still fails to operate properly after the Reset button has been pressed, contact your local KENWOOD dealer for assistance.
- Press the reset button if the disc auto changer fails to operate correctly. Normal operation should be restored.

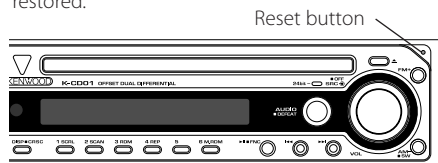

- Characters in the LCD may become difficult to read in temperatures below 41 °F (5 °C).
- The illustrations of the display and the panel appearing in this manual are examples used to explain more clearly how the controls are used. Therefore, what appears on the display in the illustrations may differ from what appears on the display on the actual equipment, and some of the illustrations on the display may represent something impossible in actual operation.

Lens Fogging

Right after you turn on the car heater in cold weather, dew or condensation may form on the lens in the CD player of the unit. Called lens fogging, CDs may be impossible to play. In such a situation, remove the disc and wait for the condensation to evaporate. If the unit still does not operate normally after a while, consult your Kenwood dealer.

Notes

Cleaning the Unit

If the faceplate of this unit is stained, wipe it with a dry soft cloth such as a silicon cloth.

If the faceplate is stained badly, wipe the stain off with a cloth moistened with neutral cleaner, then wipe neutral detergent off.



- Applying spray cleaner directly to the unit may affect its mechanical parts. Wiping the faceplate with a hard cloth or using a volatile liquid such as thinner or alcohol may scratch the surface or erase characters.

Cleaning the CD Slot

As dust tends to accumulate in the CD slot, clean it every once in a while. Your CDs can get scratched if you put them in a dusty CD slot.

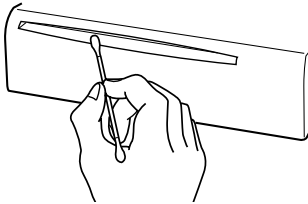

The marking of products using lasers (Except for some areas)

**CLASS 1
LASER PRODUCT**

The label is attached to the chassis/case and says that the component uses laser beams that have been classified as Class 1. It means that the unit is utilizing laser beams that are of a weaker class. There is no danger of hazardous radiation outside the unit.

About CDs

Handling CDs

- Don't touch the recording surface of the CD.

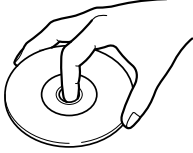

- CD-R and CD-RW are easier to damage than a normal music CD. Use a CD-R or a CD-RW after reading the caution items on the package etc.
- Don't stick tape etc. on the CD. Also, don't use a CD with tape stuck on it.

When using a new CD

If the CD center hole or outside rim has burrs, use it after removing them with a ball pen etc.

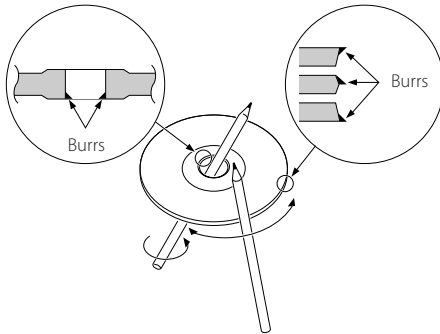

CD accessories

Don't use disc type accessories.

CD cleaning

Clean from the center of the disc and move outward.

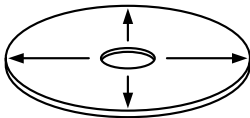

Removing CDs

When removing CDs from this unit pull them out horizontally.

CDs that can't be used

- CDs that aren't round can't be used.

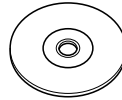

- CDs with coloring on the recording surface or that are dirty can't be used.
- This unit can only play the CDs with



It may not correctly play discs which do not have the mark.

- A CD-R or CD-RW that hasn't been finalized can't be played. (For the finalization process refer to your CD-R/CD-RW writing software, and your CD-R/CD-RW recorder instruction manual.)

CD storage

- Don't place them in direct sunlight (On the seat or dashboard etc.) and where the temperature is high.
- Store CDs in their cases.

General features

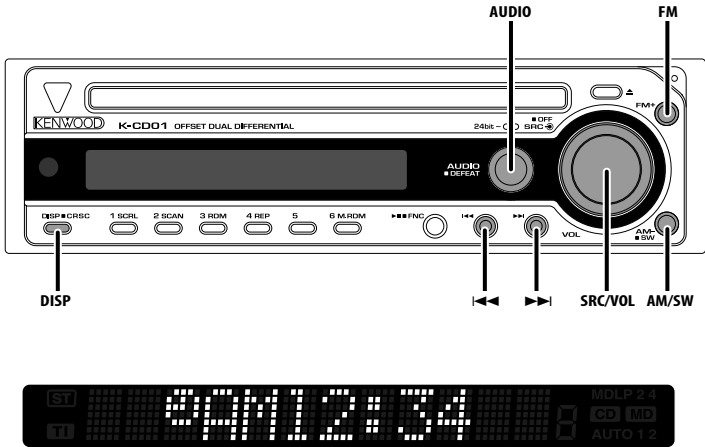

Power

Turning ON the Power

Press the [SRC] button.

Turning OFF the Power

Press the [SRC] button for at least 1 second.

Selecting the Source

Press the [SRC] button.

Source required	Display
Tuner	"Tuner"
CD	"Compact Disc"
External disc (Optional accessory)	"CD CH"
TV (Optional accessory)	"TV"
Auxiliary input (Optional accessory)	"AUX EXT"
Standby (Illumination only mode)	"Standby"

Volume

Increasing Volume

Turn the [VOL] knob clockwise.

Decreasing Volume

Turn the [VOL] knob counterclockwise.

General features

Audio Control

- Select the source for adjustment**
Press the [SRC] button.
- Enter Audio Control mode**
Press the [AUDIO] button.
"Audio CTRL" is displayed.
- Select the Audio item for adjustment**
Press the [FM] or [AM] button.
Each time the button is pressed the items that can be adjusted switch as shown below.
- Adjust the Audio item**
Press the [◀◀] or [▶▶] button.

Adjustment Item	Display	Range
Loudness	"Loudness"	ON/OFF
Bass level	"Bass"	-9 — +9
Middle level	"Middle"	-9 — +9
Treble level	"Treble"	-9 — +9
Balance	"Balance"	Left 15 — Right 15
Fader	"Fader"	Rear 15 — Front 15
Subwoofer level	"SW-Level"	-15 — +15
Volume offset	"V-Offset"	-8 — ±0



- Volume offset: Each source's volume can be set as a difference from the basic volume.
- Loudness: Compensating for low and high tones during low volume.
- Subwoofer level: You can control this function when 'Subwoofer Output' (page 8) is set to "S-Woofer On".
- Loudness, Bass level, Middle level and Treble level: You can control this function when 'Defeat Setting' (page 8) is set to "Defeat Off".

- Exit Audio Control mode**
Press the [AUDIO] button.

Defeat Setting

When Defeat is set to ON, loudness and tone control circuit are to be by-passed, and then the sound quality is improved.

Press the [AUDIO] button for at least 1 second.

Each time the button is pressed Defeat setting turns ON or OFF.
When it's ON, "Defeat On" is displayed.

Switching Display

Switching the information displayed.

Press the [DISP] button.

Each time the button is pressed the display switches as shown below.

In Tuner source

Information	Display
Frequency	
Clock	"Clock"
LX-AMP display	"AMP Display"

In CD & External disc source

Information	Display
Play time & Track number	
Disc title	"Disc Title"
Track title	"Track Title"
Clock	"Clock"
LX-AMP display	"AMP Display"

In Auxiliary input source

Information	Display
Auxiliary input	
Clock	"Clock"
LX-AMP display	"AMP Display"



- If the Disc title, or Track title is selected when the disc which does not have Disc title, or Track title is played, track number and play time are displayed.
- LX-AMP display appears when LX-AMP is connected. Refer to the user instruction of the LX-AMP for details.
- If 'Selecting display mode' (page 16) is set to "Display Off", the display is disappeared and the sound quality can be improved.

Subwoofer Output

Turning the Subwoofer output ON or OFF.

Press the [SW] button for at least 1 second.

Each time the button is pressed Subwoofer output switches ON or OFF.

When it's ON, "S-Woofer On" is displayed.

Tuner/TV control features

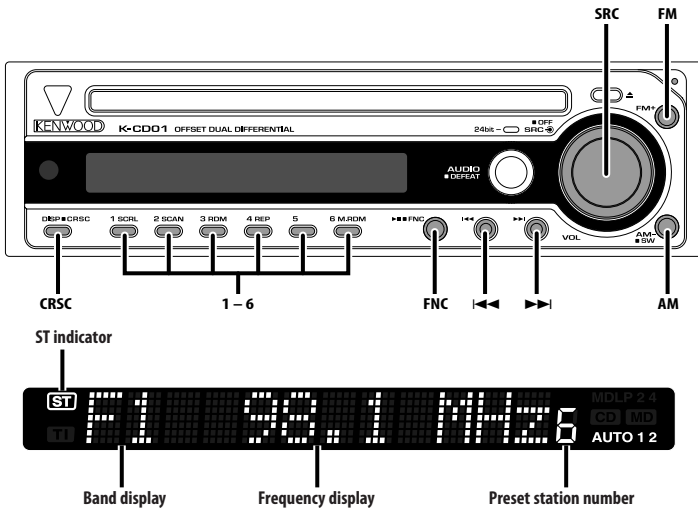

Tuning

Selecting the station.

1 Select tuner source

Press the [SRC] button.

Select the "Tuner" display.

2 Select the band

Press the [FM] or [AM] button.

Each time the [FM] button is pressed it switches between the FM1, FM2, and FM3 bands.

3 Tune up or down band

Press the [◀◀] or [▶▶] button.



- During reception of stereo stations the "ST" indicator is ON.

Function of remote

Direct Access Tuning

Entering the frequency and tuning.

1 Select the band

Press the [FM] or [AM] button.

2 Enter Direct Access Tuning mode

Press the [DIRECT] button on the remote.

"- - - -" is displayed.

3 Enter the frequency

Press the number buttons on the remote.

Example:

Desired frequency	Press button
92.1 MHz (FM)	[0], [9], [2], [1]
810 kHz (AM)	[0], [8], [1], [0]

Canceling Direct Access Tuning

Press the [DIRECT] button on the remote.

Station Preset Memory

Putting the station in the memory.

- 1 Select the band**
Press the [FM] or [AM] button.
- 2 Select the frequency to put in the memory**
Press the [◀◀] or [▶▶] button.
- 3 Put the frequency in the memory**
Press the desired [1] — [6] button for at least 2 seconds.
The preset number display blinks 1 time.
On each band, 1 station can be put in the memory on each [1] — [6] button.

Auto Memory Entry

Putting a station with good reception in the memory automatically.

- 1 Select the band for Auto Memory Entry**
Press the [FM] or [AM] button.
- 2 Enter Function set mode**
Press the [FNC] button for at least 1 second.
"Function Set" is displayed.
- 3 Select the Auto Memory Entry mode**
Press the [FM] or [AM] button.
Select the "AME Ready" display.
- 4 Open Auto Memory Entry**
Press the [FNC] button for at least 2 seconds.
When 6 stations that can be received are put in the memory Auto Memory Entry closes.

Preset Tuning

Calling up the stations in the memory.

- 1 Select the band**
Press the [FM] or [AM] button.
- 2 Call up the station**
Press the desired [1] — [6] button.

CRSC (Clean Reception System Circuit)

Temporarily have reception switched from stereo to mono to reduce multi-path noise when listening to the FM station.

Press the [CRSC] button for at least 1 second.

Each time the button is pressed CRSC turns ON or OFF.

When it's ON, "CRSC On" is displayed.

Frequency Step Setting

Changing the tuning frequency step.
The original setting is FM band 50 kHz, and AM band 9 kHz.

- 1 Turn the power OFF**
Press the [SRC] button for at least 1 second.

- 2 Switch the frequency step**
While pressing the [1] and [5] button, press the [SRC] button. When the display turns on, release [1] and [5] button.

The frequency step changes to FM band 200 kHz, and AM band 10 kHz.



- When the same operation is repeated, it returns to the original setting.
- When the frequency step is switched, the frequencies in the memory are deleted.

Function of LX BUS Television

TV Tuning

The TV channel of a connected LX BUS Television (optional accessory) can be selected. The action depends on the setting of the connected LX BUS Television. Refer to the user instruction of the LX BUS Television for details.

1 Select TV source

Press the [SRC] button.

Select the "TV" display.

2 Select the TV band and Video input

Press the [FM] button.

Each time the [FM] button is pressed TV bands and Video input switch.

3 Select the TV channel

Press the [◀◀] or [▶▶] button.

Function of LX BUS Television

Preset TV Tuning

Calling up the TV channels in the memory.

1 Select the TV band

Press the [FM] button.

2 Call up the TV channel

Press the desired [1] — [6] button.

Function of LX BUS Television

TV Preset Memory

Putting the TV channels in the memory.

1 Select the TV band

Press the [FM] button.

2 Select the TV channel to put in the memory

Press the [◀◀] or [▶▶] button.

3 Put the TV channel in the memory

Press the desired [1] — [6] button for at least 2 seconds.

The preset number display blinks 1 time.

On each band, 1 TV channel can be put in the memory on each [1] — [6] button.

Function of LX BUS Television

Function of remote

Direct TV Tuning

Entering the TV channel and tuning.

1 Select the TV band

Press the [FM] button.

2 Enter Direct TV Tuning mode

Press the [DIRECT] button on the remote.

"--" is displayed.

3 Enter the TV channel

Press the number buttons on the remote.

Example:

Desired TV channel	Press button
8 ch	[0], [8]

Canceling Direct TV Tuning

Press the [DIRECT] button on the remote.

CD/External disc control features

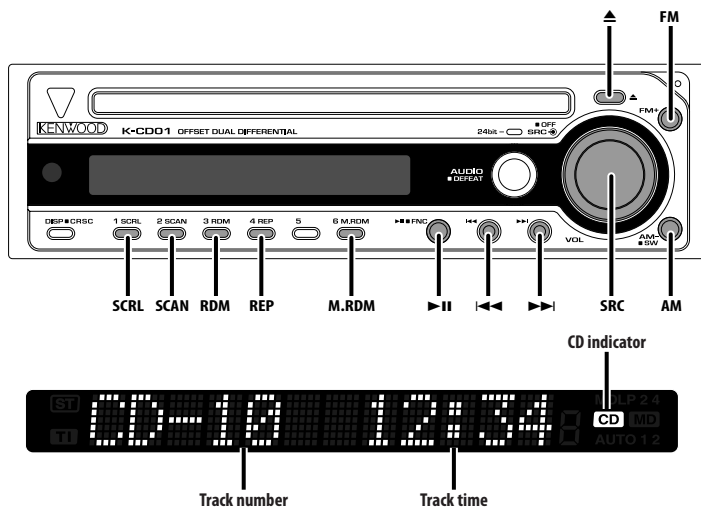

Playing CD

When a CD is inserted

Press the [SRC] button.

Select the "Compact Disc" display.



- When a CD is inserted, the "CD" indicator is ON.

Pause and play

Press the [▶||] button.

Each time the button is pressed it pauses and plays.

Eject the CD

Press the [▲] button.

Playing External Disc

Playing discs set in the optional accessory disc player connected to this unit.

Press the [SRC] button.

Select the display for the disc player you want.

Display examples:

Display	Disc player
"CD2"	CD player
"CD CH"	CD changer
"MD CH"	MD changer
"VCD CH"	Video CD changer

Pause and play

Press the [▶||] button.

Each time the button is pressed it pauses and plays.



- The functions that can be used and the information that can be displayed will differ depending on the external disc players being connected.

Fast Forwarding and Reversing

Fast Forwarding

Hold down on the [▶▶] button.

Release your finger to play the disc at that point.

Reversing

Hold down on the [◀◀] button.

Release your finger to play the disc at that point.

Track Search

Selecting the song you want to hear.

Press the [◀◀] or [▶▶] button.

Function of disc changer

Disc Search

Selecting the disc you want to hear.

Press the [AM] or [FM] button.

Function of remote

Direct Track Search

Doing Track Search by entering the track number.

1 Enter the track number

Press the number buttons on the remote.

2 Do Track Search

Press the [◀◀] or [▶▶] button.

Canceling Direct Track Search

Press the [▶II] button.

Function of disc changers with remote

Direct Disc Search

Doing Disc Search by entering the disc number.

1 Enter the disc number

Press the number buttons on the remote.

2 Do Disc Search

Press the [DISC+] or [DISC-] button.

Canceling Direct Disc Search

Press the [▶II] button.



- Input "0" to select disc 10.

Track/Disc Repeat

Replaying the track/disc you're listening to.

Press the [REP] button.

Each time the button is pressed the Repeat Play switches as shown below.

Repeat play	Display
Track Repeat	"Repeat"
Disc Repeat (Function of disc changer)	"Disc Repeat"
OFF	"Repeat Off"



- During Repeat play, it switches to "REP"/"D.REP" display if the play time is displayed.

Scan Play

Playing the first part of each song on the disc you are listening to and searching for the song you want to listen to.

1 Start Scan Play

Press the [SCAN] button.

"Track Scan" is displayed.

2 Release it when the song you want to listen to is played

Press the [SCAN] button.



- During Scan play, it switches to "SCAN" display if the play time is displayed.

Random Play

Playing all the songs on the disc in random order.

Press the [RDM] button.

Each time the button is pressed Random Play turns ON or OFF.

When it's ON, "Random" is displayed.



- When the [▶▶|] button is pressed, the next song select starts.
- During Random play, it switches to "RDM" display if the play time is displayed.

Function of disc changer

Magazine Random Play

Play the songs on all the discs in the disc changer in random order.

Press the [M.RDM] button.

Each time the button is pressed the Magazine Random Play turns ON or OFF.

When it's ON, "M-Random" is displayed.



- When the [▶▶|] button is pressed, the next song select starts.
- During Random play, it switches to "M.RDM" if the play time is displayed.

Text/Title Scroll

Scrolling the displayed CD text or MD title.

Press the [SCRL] button.



- You can control this function when 'Selecting display mode' (page 16) is set to "Display On".

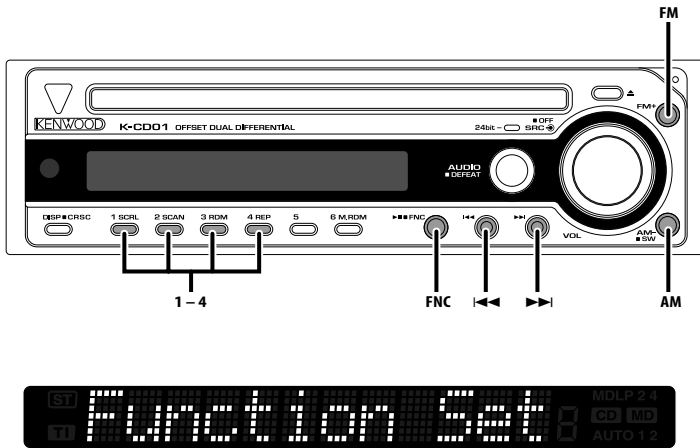

Function Set

Setting during operation beep sound etc. functions.

The Function Set basic operation method is explained here. The reference for the Function items and their setting content is after this operation explanation.

1 Enter Function Set mode

Press the [FNC] button for at least 1 second.

"Function Set" is displayed.

2 Select the Function Set item

Press the [FM] or [AM] button.

Example: When you want to set the beep sound select the "Beep" display.

3 Set the Function Set item

Press the [◀◀] or [▶▶] button.

Example: When "Beep" is selected, each time the button is pressed it switches "Beep On" or "Beep Off". Select 1 of them as the setting.

You can continue by returning to step 2 and setting other items.

4 Exit Function Set mode

Press the [FNC] button.



- When other items that are applicable to the basic operation method above are displayed afterwards their setting content chart is entered. (Normally the uppermost setting in the chart is the original setting.) Also, the explanation for items that aren't applicable ('Manual Clock Adjustment' etc.) are entered step by step.

Menu system

In Standby mode

Contrast Adjustment

Adjusting the display contrast.

Display and Setting
"Contrast 1"
⋮
"Contrast 7" (Original setting)
⋮
"Contrast 11"

In Standby mode

Selecting display mode

The sound quality can be improved by turning off the regular displays.

Display	Setting
"Display On"	Display is turned on
"Display Off"	Display is turned off



- Even though during Display off, the display appears if you do an operation, or the track of CD is changed.

In Standby mode

Touch Sensor Tone

Setting the operation check sound (beep sound) ON/OFF.

Display	Setting
"Beep On"	Beep is heard.
"Beep Off"	Beep canceled.

In Standby mode

Security Code

Because authorization by the Security Code is required when it's removed from the vehicle, personalizing this unit is by using the Security Code is a help in preventing theft.



- When the Security Code function is activated, the code can't be changed and the function can't be released. Note, the Security Code can be set as the 4 digit number of your choice.

1 Select the Security Code mode

Press the [FM] or [AM] button.

Select the "CODE STANDBY" display.

2 Enter Security Code mode

Press the [FNC] button for at least 1 second.

"CODE ****" is displayed.

3 Enter the Security Code

Press the [1] — [4] button.

Example: If the Security Code is "3510".

Step	Button	Times pressed	Display
1	[1]	4	"3"
2	[2]	6	"5"
3	[3]	2	"1"
4	[4]	1	"0"

4 Confirm the Security Code

Press the [FNC] button.

"CODE **** 1" is displayed.

5 Do the steps 3 through 4, and reenter the Security Code.

The Security Code function activates.



- When a Code different from step 3 is entered, repeat from step 3.

Press the Reset button and when it's removed from the battery power source

1 Turn the power ON.

2 Do the step 3 through 4 operation, and enter the Security Code.

"CODE OK!" is displayed.

The unit can be used.

In Standby mode

Built-in Amp Mute Setting

Toggles ON or OFF the mute control on the built-in amplifier.

Turning ON this control enhances the preout quality.

Display	Setting
"AMP Mute Off"	The built-in amplifier activates.
"AMP Mute On"	The built-in amplifier deactivates.

In Standby mode

Security Indicator

A red indicator will blink on the unit after the ACC is set to OFF, warning potential thieves.

Display	Setting
"S.I. Off"	LED OFF.
"S.I. On"	LED flashes.

In Standby mode

Manual Clock Adjustment

1 Select Clock Adjustment mode

Press the [FM] or [AM] button.

Select the "Clock Adjust" display.

2 Enter Clock Adjust mode

Press the [FNC] button for at least 1 second.

The "⊙" indicator blinks.

3 Adjust the hours

Press the [FM] or [AM] button.

Adjust the minutes

Press the [◀◀] or [▶▶] button.

4 Exit Clock adjustment mode

Press the [FNC] button.

In Tuner mode

Tuning Mode

Sets the tuning mode.

Tuning mode	Display	Operation
Auto seek	"AUTO 1"	Automatic search for a station.
Preset station seek	"AUTO 2"	Search in order of the stations in the Preset memory.
Manual	"Manual"	Normal manual tuning control.

In Tuner mode

Auto Memory Entry

For the operation method refer to 'Auto Memory Entry' (page 10).

In CD/External disc control mode

Text Scroll

Setting the displayed text scroll.

Display	Setting
"AT.SCRL On"	Repeats scroll.
"AT.SCRL Off"	Scrolls when the display changes.



- The text scrolled is shown below.
 - CD text
 - MD title

Menu system

In Tuner/CD/External disc control mode

B.M.S. (Bass Management System)

Adjust the bass boost level of the external amplifier using the main unit.

Display	Setting
"AMP Bass FLT"	Bass boost level is flat.
"AMP Bass +6"	Bass boost level is low (+6dB).
"AMP Bass +12"	Bass boost level is mid (+12dB).
"AMP Bass +18"	Bass boost level is high (+18dB).



- Refer to the catalog or instruction manual for power amplifiers that can be controlled from this unit.
- For amplifiers there are the model that can be set from Flat to +18 dB, and the model that can be set from Flat to +12 dB.

When an amplifier that can only be set to +12 is connected to the unit, "AMP Bass +18" won't work correctly even if it's selected.

In Tuner/CD/External disc control mode

B.M.S. Frequency Offset

Setting the central frequency boosted by B.M.S.

Display	Setting
"AMP Freq NML"	Boost with the normal central frequency.
"AMP Freq Low"	Drop the normal central frequency 20%.

When LX AMP unit connecting

AMP Control

You can control the LX AMP connected to the unit.

1 Select AMP Control mode

Press the [FM] or [AM] button.

Select the "AMP Control" display.

2 Enter AMP Control mode

Press the [FNC] button for at least 1 second.

3 Select the AMP Control item for adjustment

Press the [FM] or [AM] button.



- For the details of the AMP Control item, see the Instruction manual attached to the LX AMP.

4 Adjust the AMP Control item

Press the [◀◀] or [▶▶] button.

5 Exit AMP Control mode

Press the [FNC] button.



- You cannot use the LX AMP operation during standby mode.

Basic Operations of remote

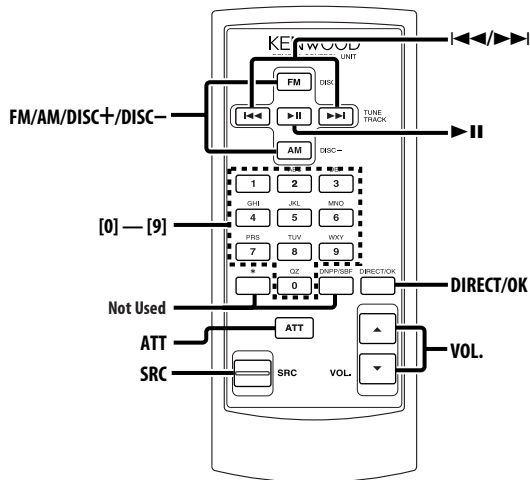

Loading and Replacing the battery

Use one lithium battery (CR2025).

Insert the batteries with the + and - poles aligned properly, following the illustration inside the case.

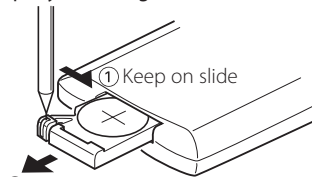

② Pull out

⚠ WARNING

- Store unused batteries out of the reach of children. Contact a doctor immediately if the battery is accidentally swallowed.



- Do not set the remote on hot places such as above the dashboard.

Basic operations

[VOL.] buttons

Adjusting the volume.

[SRC] button

Each time the button is pressed the source switches.

For the source switching order refer to 'Selecting the Source' (page 7).

[ATT] button

Turning the volume down quickly.

When it is pressed again it returns to the previous level.

Basic Operations of remote

In Tuner source

[FM]/ [AM] buttons

Select the band.

Each time the [FM] button is pressed it switches between the FM1, FM2, and FM3 bands.

[◀◀]/ [▶▶] buttons

Tune up or down band.

[0] — [9] buttons

Press buttons [1] — [6] to recall preset stations.

[DIRECT]/ [OK] button

Enters and cancels the 'Direct Access Tuning' (page 9) mode.

In Disc source

[◀◀]/ [▶▶] buttons

Doing track forward and backward.

[DISC+]/ [DISC-] buttons

Doing disc forward and backward.

[▶II] button

Each time the button is pressed the song pauses and plays.

[0] — [9] buttons

When in 'Direct Track Search' (page 13) and 'Direct Disc Search' (page 13), enter the track/disc number.

In TV source

[FM] button

Select the TV band and Video input.

Each time the [FM] button is pressed TV bands and Video input switch.

[◀◀]/ [▶▶] buttons

Select the TV channel.

[0] — [9] buttons

Press buttons [1] — [6] to recall preset TV channels.

[DIRECT]/ [OK] button

Enters and cancels the 'Direct TV Tuning' (page 11) mode.

Accessories/ Installation Procedure

Accessories

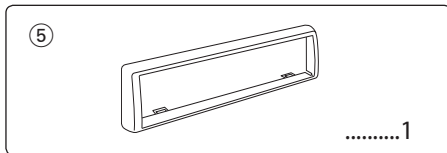
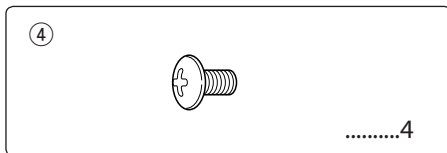
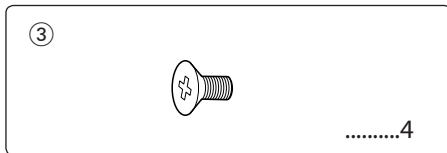
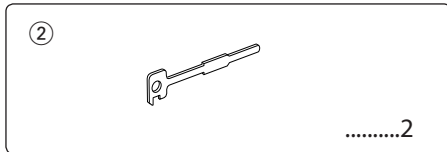
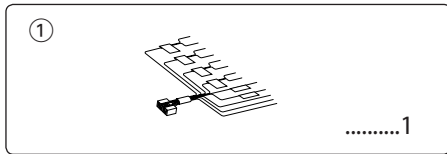

Installation Procedure

1. To prevent a short circuit, remove the key from the ignition and disconnect the ⊖ battery.
2. Make the proper input and output wire connections for each unit.
3. Connect the speaker wires of the wiring harness.
4. Connect the wiring harness wires in the following order: ground, battery, ignition.
5. Connect the wiring harness connector to the unit.
6. Install the unit in your car.
7. Reconnect the ⊖ battery.
8. Press the reset button.

▲WARNING

If you connect the ignition wire (red) and the battery wire (yellow) to the car chassis (ground), you may cause a short circuit, that in turn may start a fire. Always connect those wires to the power source running through the fuse box.



- If your car's ignition does not have an ACC position, connect the ignition wires to a power source that can be turned on and off with the ignition key. If you connect the ignition wire to a power source with a constant voltage supply, as with battery wires, the battery may die.
- If the console has a lid, make sure to install the unit so that the faceplate will not hit the lid when closing and opening.
- If the fuse blows, first make sure the wires aren't touching to cause a short circuit, then replace the old fuse with one with the same rating.
- Insulate unconnected wires with vinyl tape or other similar material. To prevent a short circuit, do not remove the caps on the ends of the unconnected wires or the terminals.
- Connect the speaker wires correctly to the terminals to which they correspond. The unit may be damaged or fail to work if you share the ⊖ wires or ground them to any metal part in the car.
- When only two speakers are being connected to the system, connect the connectors either to both the front output terminals or to both the rear output terminals (do not mix front and rear). For example, if you connect the ⊕ connector of the left speaker to a front output terminal, do not connect the ⊖ connector to a rear output terminal.
- After the unit is installed, check whether the brake lamps, blinkers, wipers, etc. on the car are working properly.
- Mount the unit so that the mounting angle is 30° or less.

Connecting Wires to Terminals

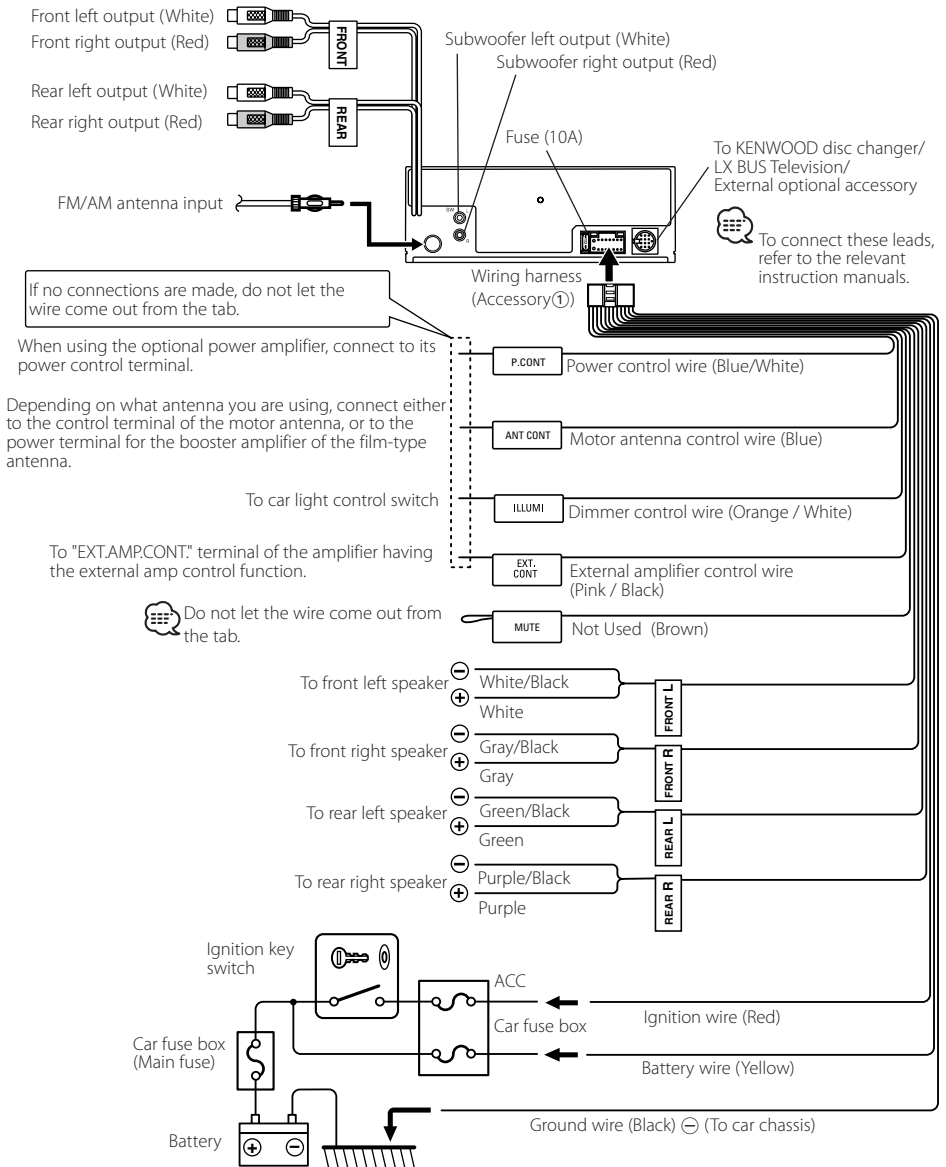

Installation

non-Japanese cars

Metal mounting strap
(commercially available)

Firewall or metal support

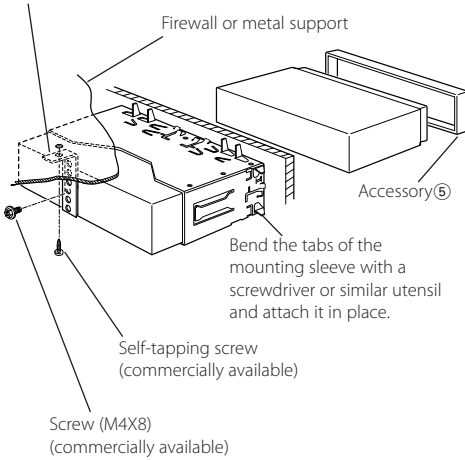

Japanese cars

Align the holes in the unit (two locations on each side) with the vehicle mounting bracket and secure the unit with the accessory screws.

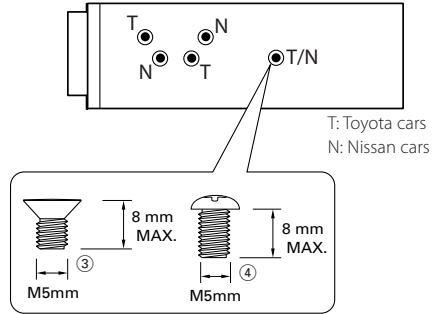

Accessory ③...for Nissan car

Accessory ④...for Toyota car



- During installation, do not use any screws except for those provided. The use of different screws might result in damage to the main unit.
- Damage may occur if a screwdriver or similar tool is used with excessive force during the installations.



- When you install or remove the unit, hold the chassis (Metal part) to conduct the operation. If you hold the control panel, it may cause damage.

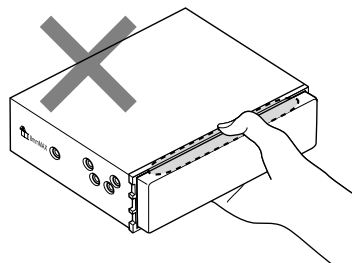
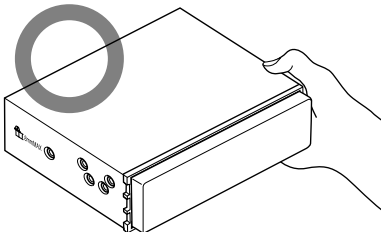

Removing the Unit

Removing the hard rubber frame

- 1 Engage the catch pins on the removal tool and remove the two locks on the upper level. Upper the frame and pull it forward as shown in the figure.

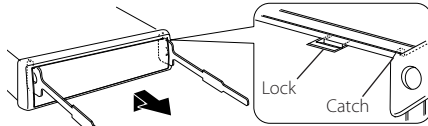

Accessory②
Removal tool

- 2 When the upper level is removed, remove the lower two locations.

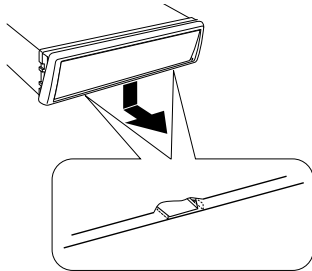

- The frame can be removed from the bottom side in the same manner.

Removing the Unit

- 1 Refer to the section 'Removing the hard rubber frame' (page 24) and then remove the hard rubber frame.
- 2 Remove the screw (M4 × 8) on the back panel.
- 3 Insert the two removal tools deeply into the slots on each side, as shown.

Screw (M4X8)
(commercially available)

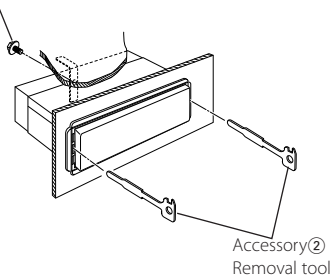

- 4 Lower the removal tool toward the bottom, and pull out the unit halfway while pressing towards the inside.

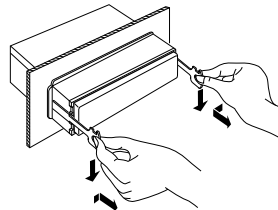

- Be careful to avoid injury from the catch pins on the removal tool.
- 5 Pull the unit all the way out with your hands, being careful not to drop it.

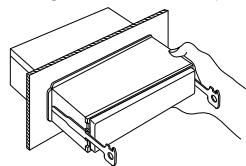

Troubleshooting Guide

What might seem to be a malfunction in your unit may just be the result of slight misoperation or miswiring. Before calling service, first check the following table for possible problems.

General

? The power does not turn ON.

- ✓ The fuse has blown.
 - ⓘ After checking for short circuits in the wires, replace the fuse with one with the same rating.
- ✓ Speaker cable touches on chassis etc.
 - ⓘ Wire or insulate the speaker cable properly and press the reset button.

? There's a source you can't switch.

- ✓ There's no media inserted.
 - ⓘ Set the media you want to listen to. If there's no media in this unit, you can't switch to each source.
- ✓ The Disc changer isn't connected.
 - ⓘ Connect the Disc changer. If the Disc changer isn't connected to its input terminal, You can't switch to an external disc source.

? The memory is erased when the ignition is turned OFF.

- ✓ The ignition and battery wire are incorrectly connected.
 - ⓘ Connect the wire correctly, referring to the section on 'Connecting Wires to Terminals'.

? There's no loudness effect.

- ✓ You're using Subwoofer preout.
 - ⓘ Loudness has no effect in Subwoofer preout.

? Even if Loudness is turned ON, high-pitched tone isn't compensated for.

- ✓ Tuner source is selected.
 - ⓘ High-pitched tone isn't compensated for when in Tuner source.

? No sound can be heard, or the volume is low.

- ✓ The fader or balance settings are set all the way to one side.
 - ⓘ Center the fader and balance settings.
- ✓ The input/output wires or wiring harness are connected incorrectly.
 - ⓘ Reconnect the input/output wires or the wiring harness correctly. See the section on 'Connecting Wires to Terminals'.
- ✓ The values of Volume offset are low.
 - ⓘ Turn up the Volume offset, referring to the section on 'Audio Control' (page 8).
- ✓ The 'Built-in Amp Mute Setting' (page 17) is ON.
 - ⓘ Turn it OFF.

? The sound quality is poor or distorted.

- ✓ One of the speaker wires is being pinched by a screw in the car.
 - ⓘ Check the speaker wiring.
- ✓ The speakers are not wired correctly.
 - ⓘ Reconnect the speaker wires so that each output terminal is connected to a different speaker.

? The Touch Sensor Tone doesn't sound.

- ✓ The preout jack is being used.
 - ⓘ The Touch Sensor Tone can't be output from the preout jack.

? The Dimmer function doesn't work.

- ✓ The Dimmer wire isn't connected correctly.
 - ⓘ Check the Dimmer wire connection.

Tuner source

? Radio reception is poor.

- ✓ The car antenna is not extended.
 - ⓘ Pull the antenna out all the way.
- ✓ The antenna control wire is not connected.
 - ⓘ Connect the wire correctly, referring to the section on 'Connecting Wires to Terminals'.

? The desired frequency can't be entered with the Direct Access Tuning.

- ✓ A station that can't be received is being entered.
 - ⓘ Enter a station that can be received.
- ✓ You're trying to enter a frequency with a 0.01 MHz unit.
 - ⓘ What can be designated in the FM band is to 0.1 MHz.

Troubleshooting Guide

Disc source

? "AUX EXT" is displayed without achieving External disc control mode.

- ✓ Unsupported disc changer is connected.
☞ Use the disc changer mentioned in the 'About CD players/disc changers connected to this unit' (page 4) of the section on 'Safety precautions'.

? The specified disc does not play, but another one plays instead.

- ✓ The specified CD is quite dirty.
☞ Clean the CD.
- ✓ The disc is loaded in a different slot from that specified.
☞ Eject the disc magazine and check the number for the specified disc.
- ✓ The disc is severely scratched.
☞ Try another disc instead.

? A CD ejects as soon as it is loaded.

- ✓ The CD is quite dirty.
☞ Clean the CD, referring to the CD cleaning of the section on 'About CDs' (page 6).

? Can't remove disc.

- ✓ The cause is that more than 10 minutes has elapsed since the vehicle ACC switch was turned OFF.
☞ The disc can only be removed within 10 minutes of the ACC switch being turned OFF. If more than 10 minutes has elapsed, turn the ACC switch ON again and press the Eject button.

? The disc won't insert.

- ✓ There's already another disc inserted.
☞ Press the [▲] button and remove the disc.

? Direct Search can't be done.

- ✓ Another function is ON.
☞ Turn Random Play or other functions OFF.

? Track Search can't be done.

- ✓ For the discs first or last song.
☞ For each disc, Track Search can't be done in the backward direction for the first song or in the forward direction for the last song.

If the following situations, consult your nearest service center:

Even though the disc changer is connected, the Disc Changer source is not ON, with "AUX EXT" showing in the display during the Changer Mode.

The messages shown below display your systems condition.

- EJECT: No disc magazine has been loaded in the changer. The disc magazine is not completely loaded.
☞ Load the disc magazine properly.
- No Disc: No disc has been loaded in the disc magazine.
☞ Load a disc into the disc magazine.
- Error 04: The CD is quite dirty. The CD is upside-down. The CD is scratched a lot.
☞ Clean the CD and load it correctly.
- Blank Disc: Nothing has been recorded on the MD.
- No Track: No tracks are recorded on the MD, although it has a title.
- Error 77: The unit is malfunctioning for some reason.
☞ Press the reset button on the unit. If the "Error 77" code does not disappear, consult your nearest service center.
- Mecha Error: Something is wrong with the disc magazine. Or the unit is malfunctioning for some reason.
☞ Check the disc magazine. And then press the reset button on the unit. If the "Mecha Error" code does not disappear, consult your nearest service center.
- HOLD: The protective circuit in the unit activates when the temperature inside the automatic disc changer exceeds 60°C (140°F), stopping all operation.
☞ Cool down the unit by opening the windows or turning on the air conditioner. As the temperature falls below 60°C (140°F), the disc will start playing again.
- LOAD: Discs are being exchanged in the Disc changer.
- "CD" indicator is Blink: The CD player section is not operating properly.
☞ Reinsert the CD. If the CD cannot be ejected or the display continues to flash even when the CD has been properly reinserted, please switch off the power and consult your nearest service center.

Specifications

Specifications subject to change without notice.

FM tuner section

- Frequency range (50 kHz space)
: 87.5 MHz – 108.0 MHz
- Frequency range (200 kHz space)
: 87.9 MHz – 107.9 MHz
- Usable sensitivity (S/N = 30dB)
: 9.3dBf (0.8 μ V/75 Ω)
- Quieting Sensitivity (S/N = 50dB)
: 15.2dBf (1.6 μ V/75 Ω)
- Frequency response (\pm 3 dB)
: 30 Hz – 15 kHz
- Signal to Noise ratio (MONO)
: 70 dB
- Selectivity (\pm 400 kHz)
: \geq 80 dB
- Stereo separation (1 kHz)
: 35 dB

AM tuner section

- Frequency range (9 kHz space)
: 531 kHz – 1611 kHz
- Frequency range (10 kHz space)
: 530 kHz – 1700 kHz
- Usable sensitivity (S/N = 20dB)
: 28 dB μ (25 μ V)

CD player section

- Laser diode
: GaAlAs
- Digital filter (D/A)
: 8 Times Over Sampling
- D/A Converter
: 1 Bit
- Spindle speed
: 500 – 200 rpm (CLV)
- Wow & Flutter
: Below Measurable Limit
- Frequency response (\pm 1 dB)
: 10 Hz – 20 kHz
- Total harmonic distortion (1 kHz)
: 0.005 %
- Signal to Noise ratio (1 kHz)
: 107 dB
- Dynamic range
: 95 dB
- Channel separation
: 90 dB

Audio section

- Maximum output power
: 40 W x 4
- Full Bandwidth Power (at less than 1% THD)
: 26 W x 4
- Tone action
Bass : 100 Hz \pm 9 dB
Middle : 500 Hz \pm 9 dB
Treble : 10 kHz \pm 9 dB
- Preout level / Load (during disc play)
: 2000 mV/10 k Ω
- Preout impedance
: \leq 600 Ω

General

- Operating voltage (11 – 16V allowable)
: 14.4 V
- Current consumption
: 10 A
- Installation Size (W x H x D)
: 178 x 50 x 160 mm
- Weight
: 1.3 kg

KENWOOD

Free Manuals Download Website

<http://myh66.com>

<http://usermanuals.us>

<http://www.somanuals.com>

<http://www.4manuals.cc>

<http://www.manual-lib.com>

<http://www.404manual.com>

<http://www.luxmanual.com>

<http://aubethermostatmanual.com>

Golf course search by state

<http://golfingnear.com>

Email search by domain

<http://emailbydomain.com>

Auto manuals search

<http://auto.somanuals.com>

TV manuals search

<http://tv.somanuals.com>