

KENWOOD

STEREO INTEGRATED AMPLIFIER/TUNER

R-K1000

INSTRUCTION MANUAL

Kenwood Corporation



**Declaration of Conformity with regard to
the EMC Directive 2004/108/EC**

Manufacturer:

Kenwood Corporation
2967-3 Ishikawa-machi, Hachioji-shi, Tokyo, 192-8525 Japan

EU Representative's:

Kenwood Electronics Europe BV
Amsterdamseweg 37, 1422 AC UITHOORN, The Netherlands



RDS

© B60-5712-00/00 (EW/XW) BT

Safety Precautions

Before Applying Power

 **Caution:** Read this page carefully to ensure safe operation.





Units are designed for operation as follows.

Australia AC 240 V only

Europe AC 230 V only

Safety precautions

WARNING : TO PREVENT FIRE OR ELECTRIC SHOCK, DO NOT EXPOSE THIS APPLIANCE TO RAIN OR MOISTURE.

 <div style="display: inline-block; border: 1px solid black; padding: 5px; text-align: center;">CAUTION RISK OF ELECTRIC SHOCK DO NOT OPEN</div> 	
CAUTION: TO REDUCE THE RISK OF ELECTRIC SHOCK, DO NOT REMOVE COVER (OR BACK). NO USER-SERVICEABLE PARTS INSIDE. REFER SERVICING TO QUALIFIED SERVICE PERSONNEL.	
	THE LIGHTNING FLASH WITH ARROWHEAD SYMBOL, WITHIN AN EQUILATERAL TRIANGLE, IS INTENDED TO ALERT THE USER TO THE PRESENCE OF UNINSULATED "DANGEROUS VOLTAGE" WITHIN THE PRODUCT'S ENCLOSURE THAT MAY BE OF SUFFICIENT MAGNITUDE TO CONSTITUTE A RISK OF ELECTRIC SHOCK TO PERSONS.
	THE EXCLAMATION POINT WITHIN AN EQUILATERAL TRIANGLE IS INTENDED TO ALERT THE USER TO THE PRESENCE OF IMPORTANT OPERATING AND MAINTENANCE (SERVICING) INSTRUCTIONS IN THE LITERATURE ACCOMPANYING THE APPLIANCE.

IMPORTANT SAFETY INSTRUCTIONS

⚠ Caution: Read this page carefully to ensure safe operation.

Read Instructions

– All the safety and operating instructions should be read before the product is operated.

Retain Instructions

– The safety and operating instructions should be retained for future reference.

Heed Warnings

– All warnings on the product and in the operating instructions should be adhered to.

Follow Instructions

– All operating and use instructions should be followed.

1. Cleaning

– Unplug this product from the wall outlet before cleaning. Do not use liquid cleaners or aerosol cleaners. Use a damp cloth for cleaning.

2. Attachments

– Do not use attachments not recommended by the product manufacturer as they may cause hazards.

3. Water and Moisture

– This product shall not be exposed to dripping and splashing – for example, near a bath tub, wash bowl, kitchen sink, or laundry tub; in a wet basement; or near a swimming pool; and the like. Do not place an object containing liquid, such as a flower vase, on the appliance.

4. Accessories

– Do not place this product on an unstable cart, stand, tripod, bracket, or table. The product may fall, causing serious injury to a child or adult, and serious damage to the product. Use only with a cart, stand, tripod, bracket, or table recommended by the manufacturer. Any mounting of the product should follow the manufacturer's instructions, and should use a mounting accessory recommended by the manufacturer.

A product and cart combination should be moved with care. Quick stops, excessive force, and uneven surfaces may cause the product and cart combination to overturn.



5. Ventilation

– Slots and openings in the cabinet are provided for ventilation and to ensure reliable operation of the product and to protect it from overheating, and these openings must not be blocked or covered. The openings should never be blocked by placing the product on a bed, sofa, rug, or other similar surface. This product should not be placed in a built-in installation such as a bookcase or rack unless proper ventilation is provided or the manufacturer's instructions have been adhered to.

6. Power Sources

– This product should be operated only from the type of power source indicated on the product. If you are not sure of the type of power supply to your home, consult your product dealer or local power company.

7. CAUTION – Polarization

– This product may be equipped with a polarized alternating-current line plug (a plug having one blade wider than the other). This plug will fit into the power outlet only one way. This is a safety feature. If you are unable to insert the plug fully into the outlet, try reversing the plug. If the plug should still fail to fit, contact your electrician to replace your obsolete outlet. Do not defeat the safety purpose of the polarized plug.

Continued to next page

IMPORTANT SAFETY INSTRUCTIONS

8. Power Cord Protection

– Power-supply cords should be routed so that they are not likely to be walked on or pinched by items placed upon or against them, paying particular attention to cords at plugs, convenience receptacles, and the point where they exit from the product.

9. Lightning

– For added protection for this product during a lightning storm, or when it is left unattended and unused for long periods of time, unplug it from the wall outlet and disconnect the antenna or cable system. This will prevent damage to the product due to lightning and power-line surges.

10. Overloading

– Do not overload wall outlets, extension cords, or integral convenience receptacles as this can result in a risk of fire or electric shock.

11. Object and Liquid Entry

– Never push objects of any kind into this product through openings as they may touch dangerous voltage points or short-out parts that could result in a fire or electric shock. Never spill liquid of any kind on the product.

12. Servicing

– Do not attempt to service this product yourself as opening or removing covers may expose you to dangerous voltage or other hazards. Refer all servicing to qualified service personnel.

13. Damage Requiring Service

– Unplug this product from the wall outlet and refer servicing to qualified service personnel under the following conditions:

- a) When the power-supply cord or plug is damaged,
- b) If liquid has been spilled, or objects have fallen into the product,
- c) If the product has been exposed to rain or water,

d) If the product does not operate normally by following the operating instructions.

e) If the product has been dropped or damaged in any way, and

f) When the product exhibits a distinct change in performance – this indicates a need for service.

g) If an abnormal smell or smoke is detected.

14. Replacement Parts

– When replacement parts are required, be sure the service technician has used replacement parts specified by the manufacturer or have the same characteristics as the original part. Unauthorized substitutions may result in fire, electric shock, or other hazards.

15. Safety Check

– Upon completion of any service or repairs to this product, ask the service technician to perform safety checks to determine that the product is in proper operating condition.

16. Wall or Ceiling Mounting

– This product should be mounted to a wall or ceiling only as recommended by the manufacturer.

17. Heat

– This product should be situated away from heat sources such as radiators, heat registers, stoves, or other products that produce heat. Do not place a flaming object, such as a candle or lantern, or near the product.

18. Power Lines

– An outside antenna system should not be located in the vicinity of overhead power lines or other electric light or power circuits, or where it can fall into such power lines or circuits. When installing an outside antenna system, extreme care should be taken to keep from touching such power lines or circuits as contact with them might be fatal.

19. Outdoor Antenna Grounding

– If an outside antenna or cable system is connected to the product, be sure the antenna or cable system is grounded so as to provide some protection against voltage surges and built-up static charges. Article 810 of the National Electrical Code, ANSI/NFPA 70, provides information with regard to proper grounding of the mast and supporting structure, grounding of the lead-in wire to an antenna discharge unit, size of grounding conductors, location of antenna-discharge unit, connection to grounding electrodes, and requirements for the grounding electrode.

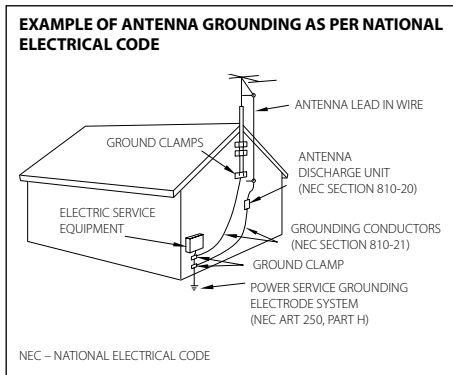

Notes:

1. Item 7 is not required except for grounded or polarized equipment.
2. Item 19 complies with UL in the U.S.A.

Information on Disposal of Old Electrical and Electronic Equipment (applicable for EU countries that have adopted separate waste collection systems)



Products with the symbol (crossed-out wheeled bin) cannot be disposed as household waste. Old electrical and electronic equipment should be recycled at a facility capable of handling these items and their waste byproducts. Contact your local authority for details in locating a recycle facility nearest to you. Proper recycling and waste disposal will help conserve resources whilst preventing detrimental effects on our health and the environment.

What the R-K1000 Can Do



Supports a host of component types

External Input Terminals

As well as analog input terminals for record players or cassette decks, the R-K1000 also features an input terminal for digital audio players.

It even has a digital input terminal with sampling rate converters so that you can use components such as digital tuners.



Create the perfect sound space for your installation setting

Room Equalizer

The R-K1000 automatically optimizes the audio settings for your room layout and system location.

You simply set up the microphone supplied with the R-K1000 in the listening position and then start up the Room Equalizer.



Realistic audio playback with near-original sound

Supreme EX

Original Kenwood audio enhancement technology that reproduces the high-bandwidth component in the original sound produces incredibly realistic audio that restores almost all the nuances of the original performance.

This reproduces high-range bands of 20 kHz and higher from audio CD or digital input.

It also reproduces the high-range bands lost through data compression when you connect to the CD player (DP-K1000 – sold separately) and play audio files (MP3/WMA/AAC).



Superb sound quality even at low volumes

Clear A Mode

The R-K1000 uses the “Clear A” mode to provide superb rich sound quality with excellent balance even at low volumes. This mode is ideal when you are sitting very close to the set or in situations where you want to keep the volume low, such as late-night listening.



Convenient and Easy to Use

System Control Function

The system control connection between the R-K1000 and the CD player (DP-K1000 – sold separately) enables you to turn both units on and off jointly and use the R-K1000 remote control for basic operations on the CD player.



To ensure safety, read the items carrying this marking carefully.

Before Using the System

Be sure to read these precautions.

△ Safety Precautions.....	2
△ Before Applying Power	2
△ IMPORTANT SAFETY INSTRUCTIONS	3
Accessories	8
Installing the System	9
Connecting the System	10
Component Names and Functions	16
How to Use This Manual.....	20
Basic Operation	22
Using CDs (DP-K1000 – sold separately)	24

Procedures by Input Source ▶▶ P.25

This chapter explains how to connect and use the system with the different input sources.

- Receiving Broadcast Stations
- RDS (Radio Data System)
- External Components
- D.AUDIO



Audio Settings ▶▶ P.37

This chapter explains how to tailor the system to your audio preferences.

- ROOM EQ (Room Equalizer)
- Digital Sound Equalizer
- Sound Presets
- Supreme EX
- Clear A
- BALANCE



Component Settings ▶▶ P.51

This chapter explains how to select the settings for the R-K1000.

- Setting the Time
- Setting the Timer
- Display Settings
- Auto Power Save (A.P.S.)



Maintenance ▶▶ P.61

This chapter explains how to store and maintain your system so that it continues to give pleasure for many years to come.

- Messages
- Troubleshooting
- Care and Storage
- Specifications



Accessories

AM loop antenna
(1)

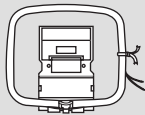

FM indoor antenna
(1)



Microphone for Room Equalizer
(Cord length: Approx. 5 m: 1)



Remote control
(RC-R0830E: 1)

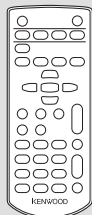

Batteries for the remote control
(R03: 2)

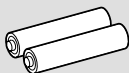

Installing the System

Notes on installing the system

- Always install the system on a flat, stable surface. When installing the system on a stand of some sort, be sure to check the strength of the stand.
- The magnets used in the speakers may cause color irregularities on TV or PC screens. Do not set up the speakers too close to a TV or PC.

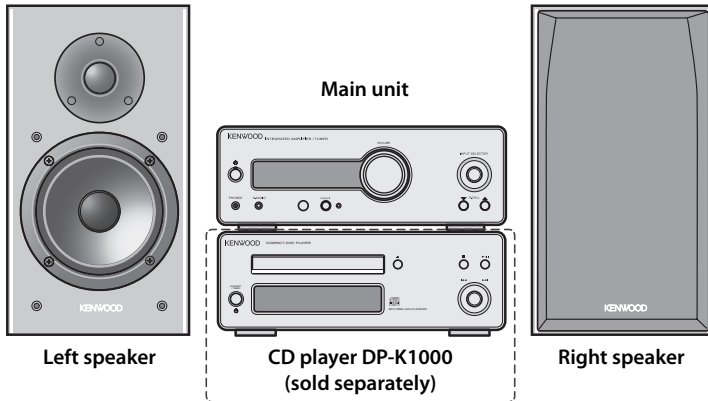

CAUTION

Observe the following cautions when installing the system. Insufficient heat radiation may build up internal heat and cause a malfunction or fire hazard.

- Do not place an object that may hinder heat radiation on the system.
- Leave the spaces specified below around the cabinets of the main unit.
Top panel: 50 cm or more Back panel: 10 cm or more
- Install the CD player (DP-K1000 - sold separately) underneath the R-K1000.

Install the system so that the power outlet is easily accessible from the user, and unplug the power cord from the power outlet immediately in case of a trouble.

Note that the power supply to the system is not shut down completely by simply setting the power key to OFF.

To shut down the power supply completely, it is required to unplug the power cord.

Getting the best acoustic effect

The sound will vary depending on the positioning of the speakers. To get the best possible sound quality, note the guidelines below.

- Ensure that the surroundings for the left and right speakers are as identical as possible. Set up the left and right speakers away from the wall and hang thick curtains on any windows to minimize echoes or reverberation.
- Place the left and right speakers as far apart as possible.
- Position the speakers at the same height as your ears when you are using the system.

Connecting the System

Main Connections

Ensure that all the cords are securely connected. Loose or incomplete connections may result in noise interference or no sound at all.

Caution for connection

Do not plug the AC power cord into an AC wall outlet until all the connections are completed. Before disconnecting any cords or cables, always turn the main unit off and unplug the power cord from AC wall outlet.

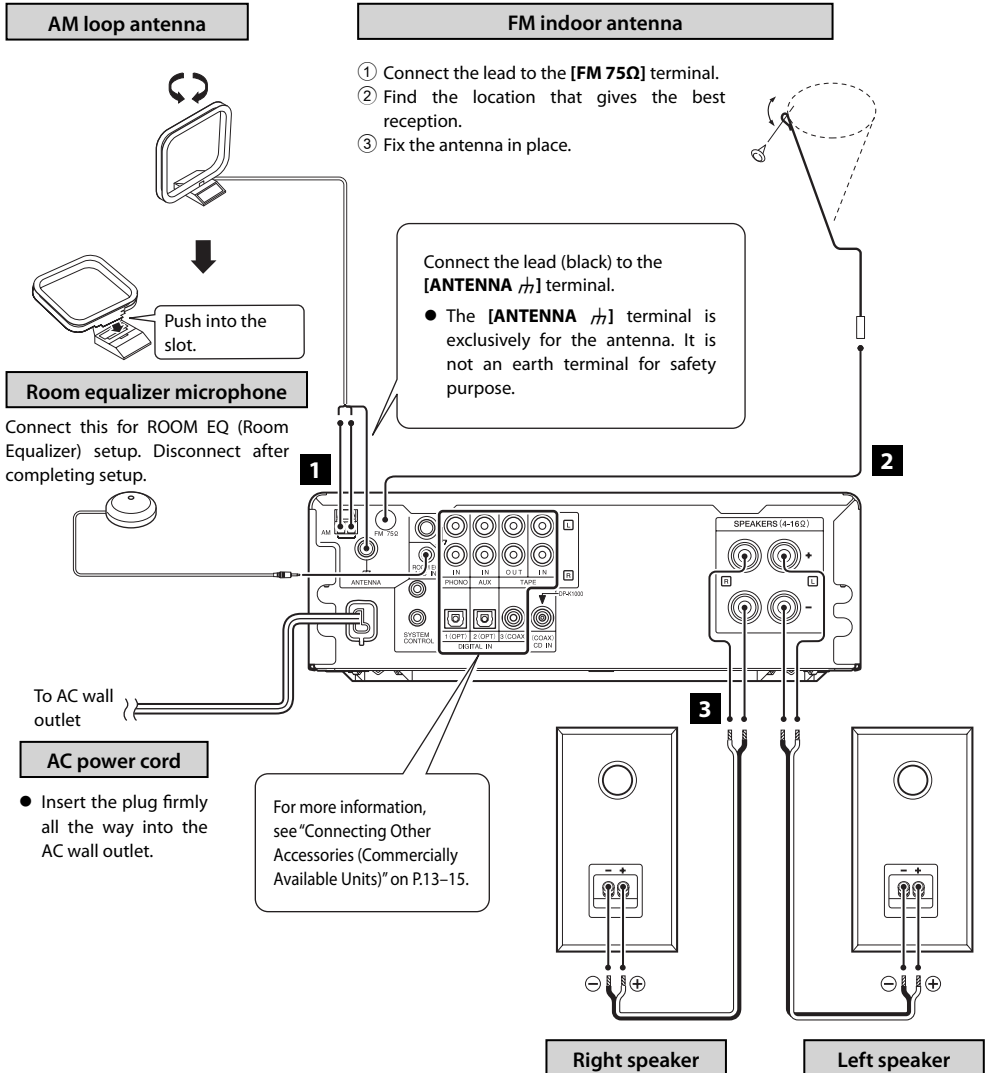

Microcomputer malfunctions

If the system is connected correctly and still does not operate normally or shows display errors, reset the microcomputer. (P.65)

1 Connecting the AM loop antenna

The antenna supplied with the system is for indoor use. Place it as far as possible away from the main unit, your TV set, the speaker cords and the power cord and point it in the direction that gives the best reception.

- **Connecting the antenna cord**

Place the AM antenna cord as shown on the right and connect the lead (red) to the right side of the [AM] terminal and the lead (white) to the left side.

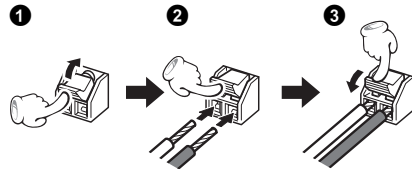
**2 Connecting the FM indoor antenna**

The antenna supplied with the system is a basic antenna for indoor use. For stable signal reception, the use of an outdoor antenna (commercially available unit) is recommended. To connect an outdoor antenna, first remove the indoor antenna.

3 Connecting the speakers**Notes on connecting the speaker cords**

Never short-circuit the positive (+) and negative (-) ends of the speaker cords. (Do not touch the + and - cords together.) Mistakenly reversing the positive and negative polarity will result in unnatural sound and unclear sound source (e.g. musical instruments) locations.

- **Preparing the ends of the speaker cords**

Twist the plastic sleeve on the end of the cord as you pull it off.

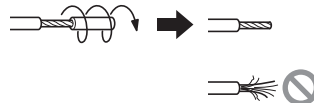

- **Connecting the speaker cords**

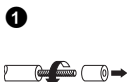

Twist and remove



Loosen the knob



Insert the cord



Tighten the knob

Connecting the CD Player (DP-K1000 – sold separately)



- When connecting a CD player, read the instruction manual for the DP-K1000 also.
- Ensure that all the cords are securely connected. Loose or incomplete connections may result in noise interference or no sound at all.

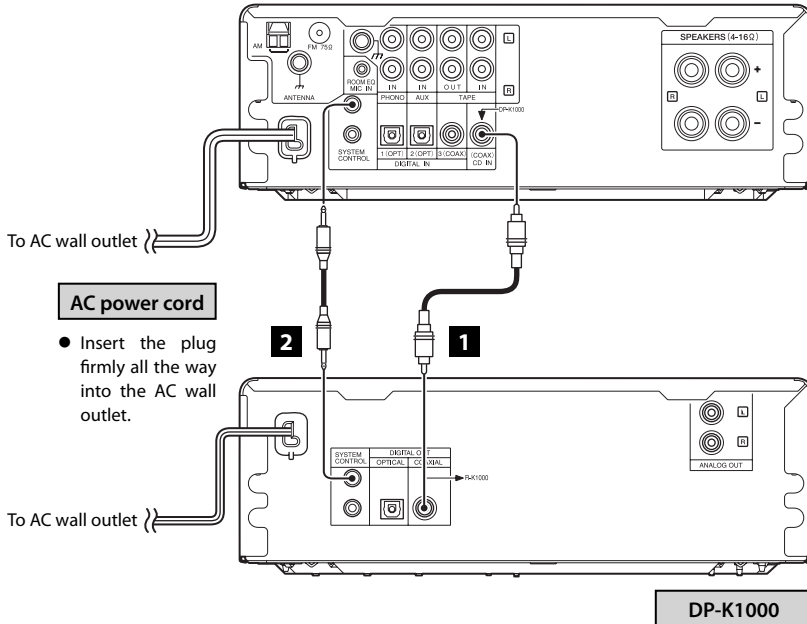

1 CD IN (COAX)

Use the coaxial cable supplied with the DP-K1000 to connect the **[DIGITAL OUT COAXIAL]** terminal on the DP-K1000 to the **[CD IN (COAX)]** terminal on the rear panel of the R-K1000.

2 SYSTEM CONTROL

Use the system control cable supplied with the DP-K1000 to connect the **[SYSTEM CONTROL]** terminal on the DP-K1000 to the **[SYSTEM CONTROL]** terminal on the rear panel of the R-K1000.



- To connect a CD player other than the DP-K1000 to the R-K1000, use an analog connection to connect the audio output terminal on the CD player to the **[AUX IN]** terminal on the rear panel of the R-K1000. When using a digital connection, connect the optical digital output terminal on the CD player to the **[DIGITAL IN 1 (OPT)]** or **[DIGITAL IN 2 (OPT)]** terminal on the rear panel of the R-K1000. When connecting from a coaxial output terminal on the CD player, use the **[DIGITAL IN 3 (COAX)]** terminal on the R-K1000.

Connecting Other Accessories (Commercially Available Units)



- When a related system component is connected, read the instruction manual for that component also.
- Ensure that all the cords are securely connected. Loose or incomplete connections may result in noise interference or no sound at all.



Caution for outdoor antenna installation

Since antenna installation necessitates skill and experience, always consult your dealer before installation. The antenna should be placed at a distance from the power distribution wires. Otherwise, an electric shock accident may occur if the antenna falls down.

PHONO IN

Connect record players with MM cartridges to the **[PHONO IN]** terminal on the rear panel of the main unit.

- The [⏏] (earth) terminal is used to reduce noise reduction when an analog record player is connected to the system. It is not an earth terminal for safety purposes.
- Record players with built-in equalizer amplifiers should be connected to the **[AUX IN]** terminal.

- You cannot connect a record player with an MC cartridge directly to the main unit. Connect a dedicated equalizer amplifier to the record player and then connect it to the **[AUX IN]** terminal.

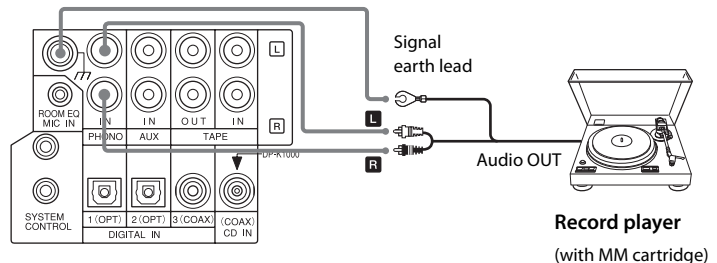

Record player
(with MM cartridge)

D.AUDIO

Connect digital audio players to the **[D.AUDIO]** terminal on the front panel of the main unit.

- If you connect a Kenwood player that supports digital audio link using the dedicated cable, you can control the player from the main unit and the remote control. (P.34) It can be connected using a 3.5 mm stereo mini-plug cable (commercially available unit).
- When you are not using the digital audio player, unplug the mini-plug cable from the main unit.

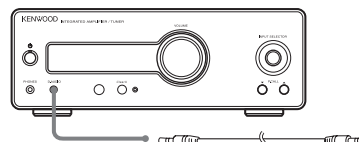

Digital audio player

TAPE IN/OUT

Connect the audio output and audio input terminals on the cassette deck to the **[TAPE IN]** and **[TAPE OUT]** terminals respectively on the rear panel of the R-K1000.

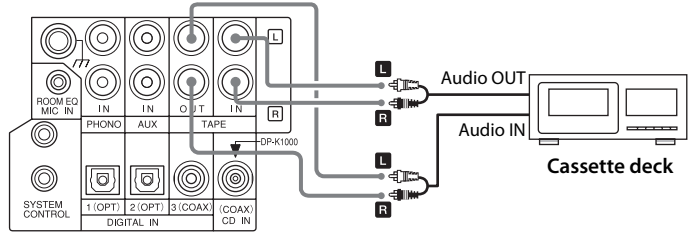

AUX IN

Connect the audio OUT terminals on components such as VCRs to the **[AUX IN]** terminal on the rear panel of the R-K1000.

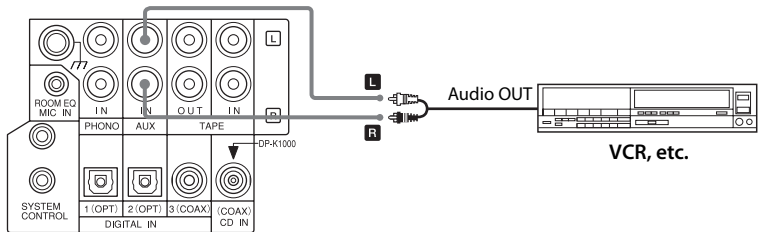

DIGITAL IN 1, 2 (OPT)

Connect the optical digital output terminal on components such as digital tuners to the **[DIGITAL IN 1 (OPT)]** or **[DIGITAL IN 2 (OPT)]** terminal on the rear panel of the R-K1000.

- Set the digital audio output on connected components to "PCM".

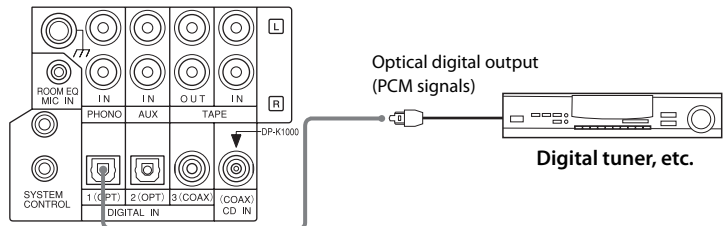

DIGITAL IN 3 (COAX)

Connect the digital coaxial type output terminal on components such as DVD players to the **[DIGITAL IN 3 (COAX)]** terminal on the rear panel of the R-K1000.

- Set the digital audio output on connected components to "PCM".

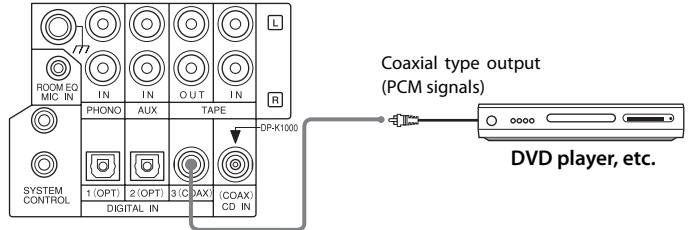

PHONES

Plug headphones equipped with a 3.5 mm stereo mini-plug into the **[PHONES]** jack on the front panel of the R-K1000.

- When you connect the headphones, sound from the speakers is muted and the volume adjustment range is from minus infinity ($-\infty$) dB to 0 dB.

HP VOL $-\infty$ dB

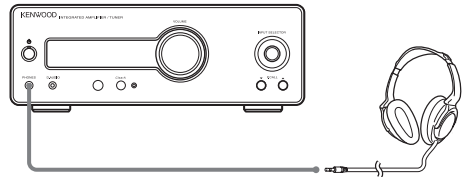

Component Names and Functions

Main unit

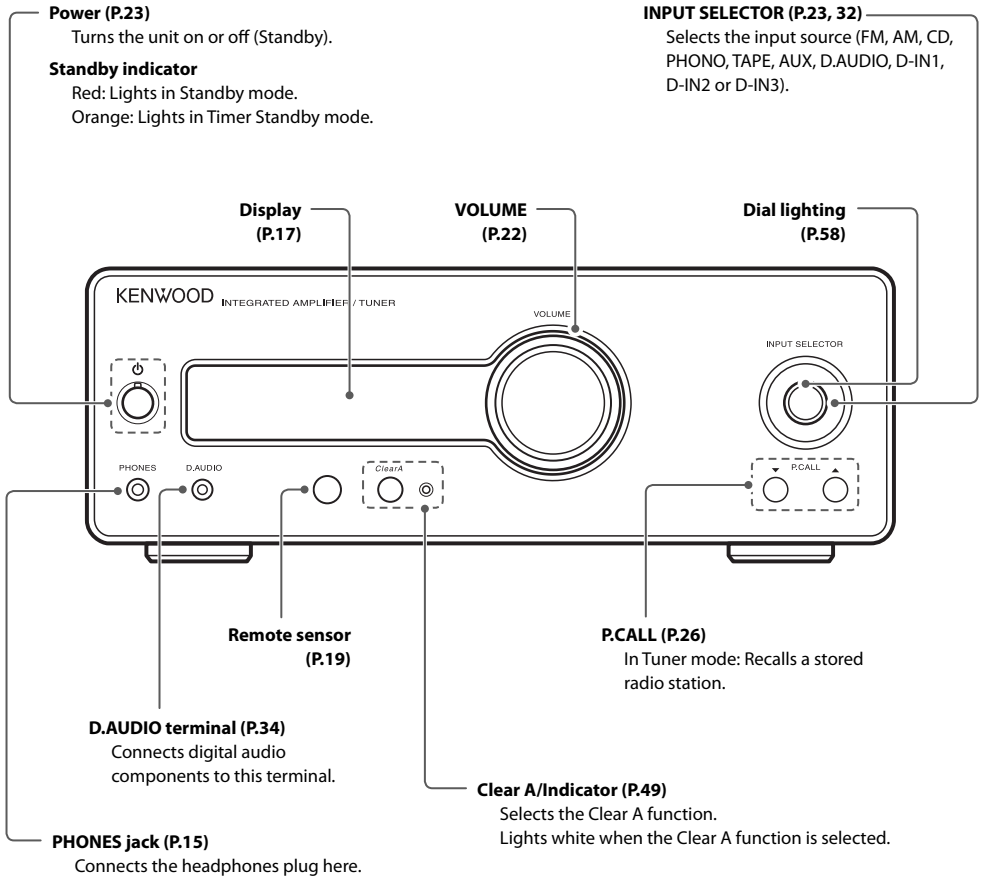

Standby Mode

While the Standby indicator on the main unit is lit, the unit is using a very weak current to maintain the built-in memory. This is called Standby mode. When the main unit is in this mode, you can turn it on using the remote control.

System Control Connection

If you use system control connection to connect a DP-K1000 (sold separately) to the R-K1000, the R-K1000 operates as follows:

- When you play a CD on the DP-K1000, input on the R-K1000 automatically switches to CD and you can use the R-K1000 remote control to control CD operations on the DP-K1000.
- Operation is linked so that turning the R-K1000 on and off turns the DP-K1000 on and off also.
- When the Dimmer, Display Saver and Auto Power Save functions are set on the R-K1000, they run on the DP-K1000 also.

Display

Displays shown in this manual may differ from the actual displays.

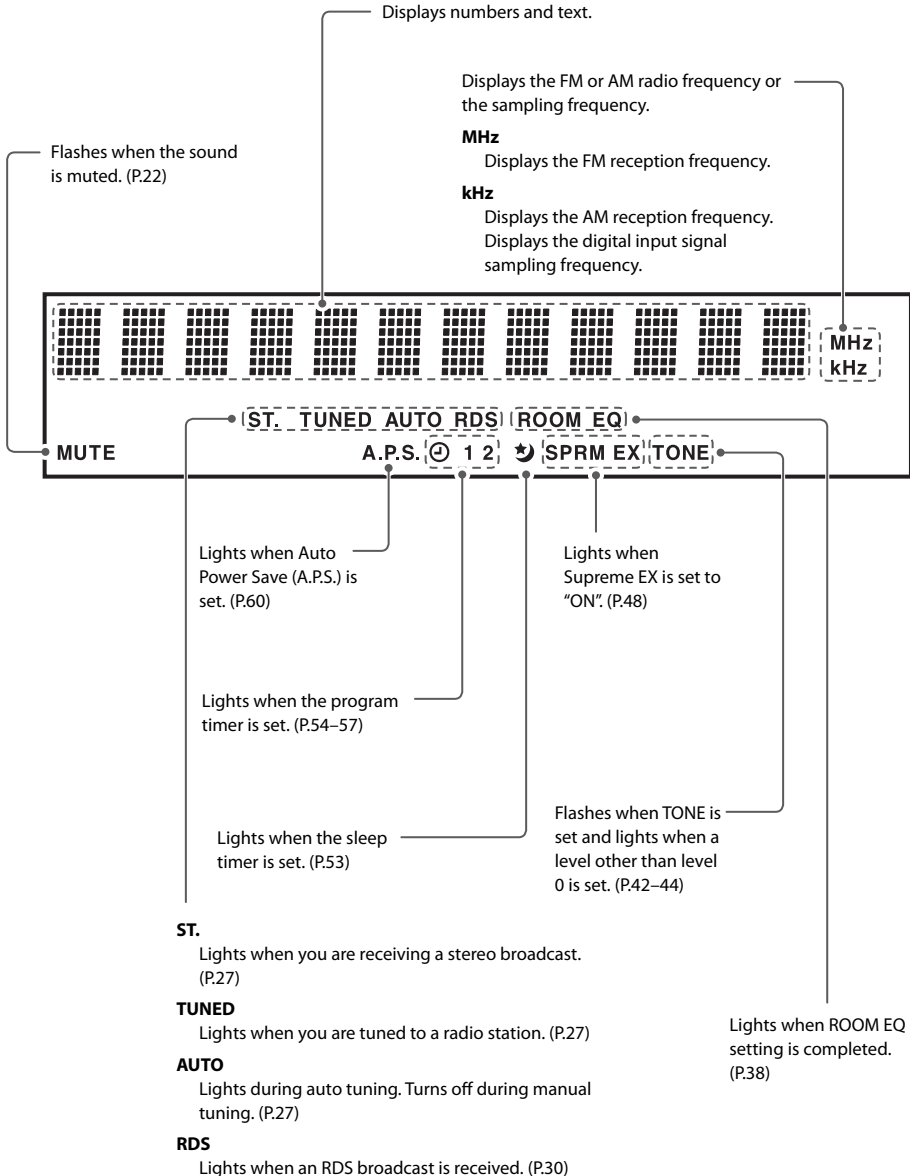

Remote control

Remote control keys with the same names as keys on the main unit have the same functions as the main unit keys.

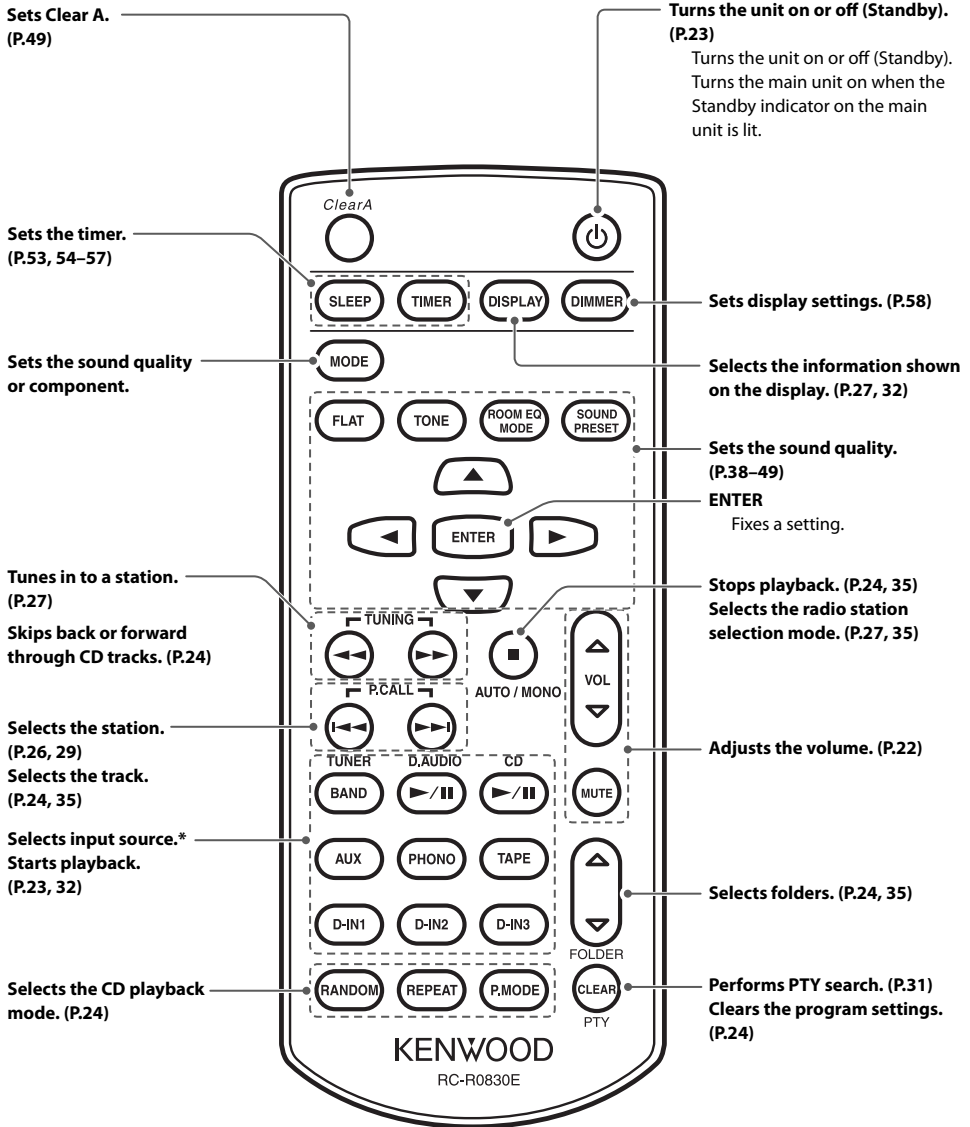

One-touch Operation

The main unit features a convenient one-touch operation function. When the main unit is Standby mode, you can turn it on by pressing the selection keys for input source*.

Using the remote control

After plugging the main unit into the AC wall outlet, press the power [⏻] key on the remote control unit to turn the system on.

Once the system is turned on, press the key for the function you want to use.

Point the remote control at the remote sensor when using it.

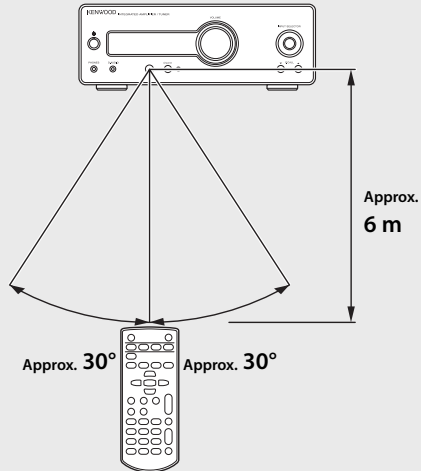

- The remote control may not operate correctly if direct sunlight or light from a high-frequency fluorescent lamp (such as an inverter type) is shining on the remote sensor. If this happens, install the main unit in a different location to avoid this sort of malfunction.

Loading the remote control batteries

- ① Remove the battery cover.

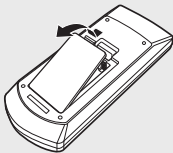

- ② Load the R03 batteries supplied with the system.

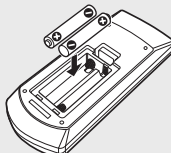

- ③ Close the battery cover.

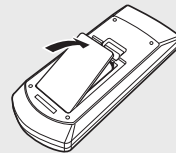

- Check the polarity of the batteries (⊕, ⊖) when loading them.

- The batteries supplied with the system are only for operation checking and may only last for a short time.
- When replacing the batteries, always load 2 new batteries.

How to Use This Manual

Operation procedure

While this system can be controlled from either the remote control or the main unit, the explanations in this manual primarily describe operation procedures using the remote control.

Remote control keys used in the procedure

Display shown during or after an operation

- The displays shown in this instruction manual may differ from the actual displays.

Receiving Broadcast Stations

Presetting Stations Automatically (AUTO MEMORY)

- Up to 40 stations can be preset in the system.
- For use of the RDS function, stations must be memorized by AUTO MEMORY.

1 Press the [MODE] key.

2 Select "AUTO MEMORY".

Press the [▲] or [▼] key.

AUTO MEMORY

Press the [ENTER] key.

- "AUTO MEMORY" flashes on the display and the receivable radio stations are preset automatically.
- A preset frequency can be rewritten later.



- RDS stations are given priority during auto presetting. If there is memory left after presetting, this unit continues presetting regular FM and AM stations.
- A broadcast station that cannot be preset with AUTO MEMORY should be set with Manual preset. (P. 29)
- Auto Memory setup may take a few minutes to complete.

Explanations of main unit procedures







Explanations of remote control procedures

Related functions that may also be helpful

- Related Information**
- Connecting Other Accessories (Commercially Available Units) → P13-15
 - Audio Settings → P37 onwards

External components



Operation icons

-  Explains the procedure for the radio.
-  Explains the procedures for external components.
-  Explains the procedure for digital audio players.
-  Explains how to set the sound quality.
-  Explains how to set up component units.
-  Explains how to carry out system maintenance.

Adjusting the External Component Input Level

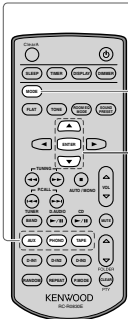
Use the procedure below to adjust the input level for the external component connected to the **[PHONO IN]**, **[TAPE IN]** or **[AUX IN]** terminal.
Use this adjustment when the volume from an external component is noticeably higher or lower than other input sources at the same volume setting.



-  **Select the input source to adjust the input level.**
 Turn the **[INPUT SELECTOR]** knob and select the input source to adjust the input level.
 - You can set the input level for each of PHONO, TAPE and AUX.

- Press the [MODE] key.**

- Select "INPUT LEVEL".**
Press the [▲] or [▼] key.

INPUT LEVEL

Press the **[ENTER]** key.

- Set the input level.**
Press the [▲] or [▼] key.

LEVEL +1

- You can adjust the input level in a range from -3 to +5.

Press the **[ENTER]** key.

-  If you adjust the input level for PHONO or AUX, the output level from the **[TAPE OUT]** terminal will also change.

Basic Operation

This section describes some basic procedures for using the system, such as turning the unit on or off, selecting input source, and adjusting the volume.

Preparations

Check the connections. (P.10–15)
Have the remote control ready. (P.19)

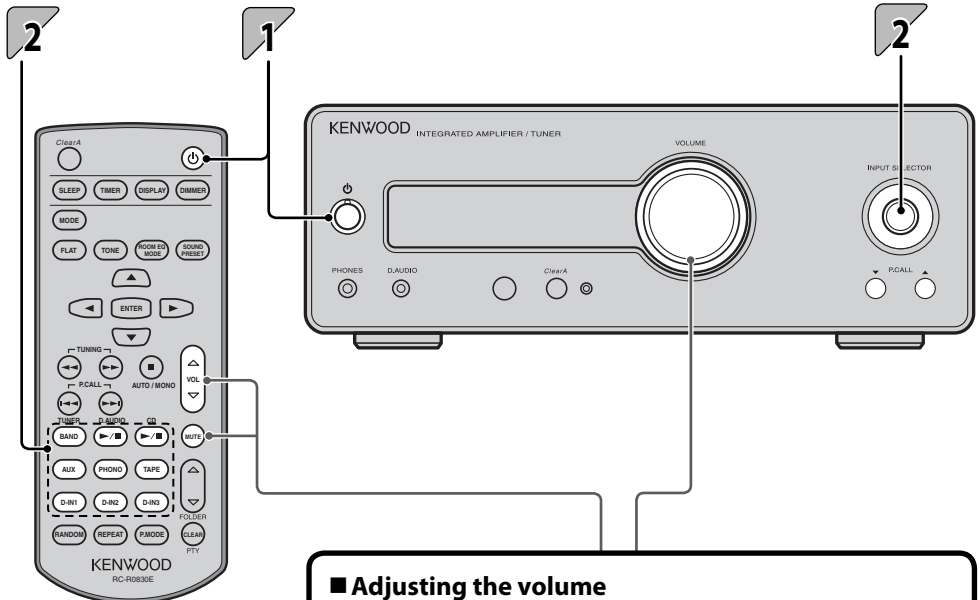

■ Adjusting the volume

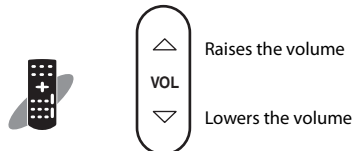
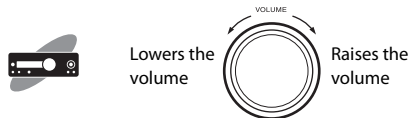

■ Mute



- Press this key again to unmute the sound.

1

Turn the system on (off).

- You can also turn the R-K1000 on by pressing **[BAND]**, **[D.AUDIO]**, **[CD]**, **[AUX]**, **[PHONO]**, **[TAPE]**, **[D-IN1]**, **[D-IN2]** or **[D-IN3]** on the remote control.



- Pressing the power  key when the unit is on turns it off (Standby mode).

2

Select the input source.

Turn the **[INPUT SELECTOR]** knob to select the input source to be used for playback.

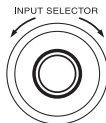

Press the selection key for the input source.

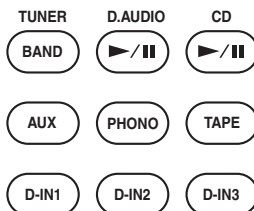

- See "Procedures by Input Source" (P.25–36) for the operation procedures for each input source.
- You can set your preferred sound quality. See "Audio Settings" (P.37–50) for details.

Using CDs (DP-K1000 – sold separately)

When a DP-K1000 (sold separately) is connected to the R-K1000, you can use the R-K1000 remote control to play CDs.

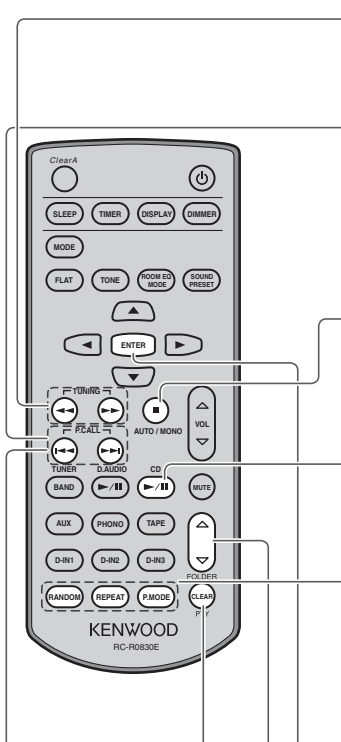

Skipping forward/back

Hold down the [◀◀] or [▶▶] key.

Skipping tracks, skipping back, skipping to the start

To skip to the previous or next track: Press the [◀◀] or [▶▶] key.
To return to an earlier track: Press the [◀◀] key two or more times in succession.
To return to the beginning of a track: Press the [◀◀] key once.

Stopping playback

Press the [■] key.

Pausing and resuming playback

Press the [CD▶/||] key.

Selecting the CD playback mode

Random playback: Press the [RANDOM] key and light "RANDOM".
Repeat playback: Press the [REPEAT] key and light "REPEAT".
Program playback: Press the [P.MODE] key and light "PGM".
Folder playback: Press the [P.MODE] key and light "CD".

Selecting the track (Program)

Use the [◀◀] or [▶▶] key to select the track and then press the [ENTER] key.
To clear the program settings: Press the [CLEAR] key.

Selecting the folder (When Folder playback is selected)

For MP3/WMA/AAC files

To go to the previous folder, press the [FOLDER ▲] key.
To go to the next folder, press the [FOLDER ▼] key.



For MP3/WMA/AAC files

- When you stop playback by pressing the [■] key, the track being played is stored and pressing the [CD▶/||] key restarts playback from the beginning of that track. (Resume function)
- The Resume function also works if you switch to another input source during playback.
- To cancel the resume function, press the [■] key twice.

Procedures by Input Source

This chapter explains the operation procedures for each input source.

For information on the sound quality settings and component settings regardless of the input source, see "Audio Settings" (P.37) and "Component Settings" (P.51).

If an error is displayed or a problem arises, see "Maintenance" (P.61).



Receiving Broadcast Stations

- Listening to FM/AM Radio 26
- Presetting Stations Automatically (AUTO MEMORY) 28
- Presetting Stations Manually (Manual Preset) 29

RDS (Radio Data System)

- PS (Program Service) Name Display 30
- Searching for a Desired Program Type (PTY Search) 31

External Components

- Playback from External Components 32
- Adjusting the External Component Input Level 33

D.AUDIO

- Playback from a Digital Audio Player 34
- Adjusting the Digital Audio Player Input Level 36



Receiving Broadcast Stations

This section explains how to listen to the FM/AM radio and set radio stations.

Listening to FM/AM Radio

- Simply pressing the [TUNER/BAND] key turns on the system and allows you to listen to the radio.

1 Press the [TUNER/BAND] key to select "FM" or "AM".

Each time you press the key, the band switches between "FM" and "AM".



2 Select a station.



Choosing from stored stations (Preset Call)

Select a station that you have stored.

- See P.28, 29 for more information on presets.

■ Selection with the [P.CALL] keys

Each time you press the [◀◀] or [▶▶] key () or the [▼] or [▲] key (), the tuning changes to the next stored station in sequence.

When you hold down the [◀◀] or [▶▶] key () or the [▼] or [▲] key (), the tuning changes to the next stored station in sequence at intervals of approximately 0.5 seconds.

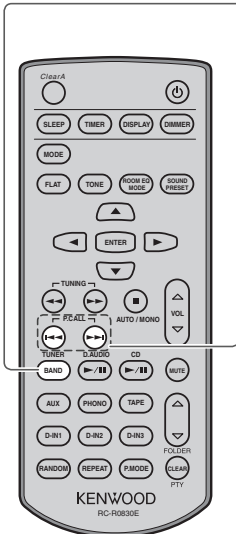

Related Information

- Presetting Stations Automatically (AUTO MEMORY) → P.28
- Presetting Stations Manually (Manual Preset) → P.29
- Audio Settings → P.37 onwards

Choosing from stations that are not stored (Auto/Manual tuning)



1 Select Auto tuning or Manual tuning.

Press the [AUTO/MONO] key.

The mode changes as shown below each time you press the key.

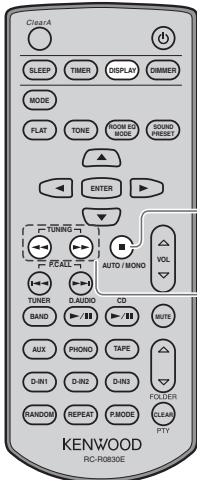

2 Select a station.

Press the TUNING [◀◀]/[▶▶] key.

When the station is tuned, "TUNED" lights up on the display. If you are receiving a stereo signal, "ST." also lights up.

■ Using Auto tuning

The radio automatically tunes in to the next station each time you press the key. Repeat this step until you are tuned in to your preferred station.

■ Using Manual tuning

Press the key until the desired station is tuned or until you reach the desired frequency.



- There is no sound while Auto/Manual tuning is in progress.
- Auto tuning provides stereo reception while manual tuning provides monaural reception.
- The display changes as shown below each time you press the [DISPLAY] key.

FM:

Program service name → Preset No. → Day/Clock

AM or when the program service name is not stored:

Preset No. → Day/Clock (AM)

Preset No. → "NO PS" → Day/Clock (non-RDS)

Presetting Stations Automatically (AUTO MEMORY)

- Up to 40 stations can be preset in the system.
- For use of the RDS function, stations must be memorized by AUTO MEMORY.

1 Press the [MODE] key.

2 Select "AUTO MEMORY".

Press the [▲] or [▼] key.



Press the [ENTER] key.

- "AUTO MEMORY" flashes on the display and the receivable radio stations are preset automatically.
- A preset frequency can be rewritten later.

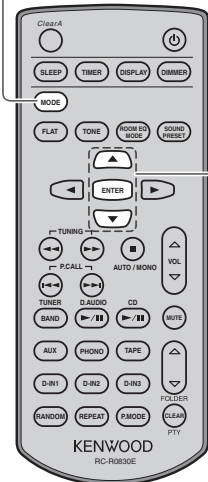

- RDS stations are given priority during auto presetting. If there is memory left after presetting, this unit continues presetting regular FM and AM stations.
- A broadcast station that cannot be preset with AUTO MEMORY should be set with Manual preset. (P. 29)
- Auto Memory setup may take a few minutes to complete.

Presetting Stations Manually (Manual Preset)

1 Select a desired station.

- Receive a station with either Auto Tuning or Manual Tuning. (P.27)
- To memorize an RDS station, wait for the station name to appear on the display before carrying out step 2.

2 Press the [ENTER] key.

The preset number flashes.



3 Select the desired preset number (P01 to P40).

■ Selection with the [P.CALL] keys

Press the [◀◀] or [▶▶] key.

The selected preset number is displayed.



- If the selected preset number already stores a station, the existing station will be overwritten by the newly selected station.

4 Press the [ENTER] key.

- To preset other stations, repeat steps 1 to 4 for each of them.

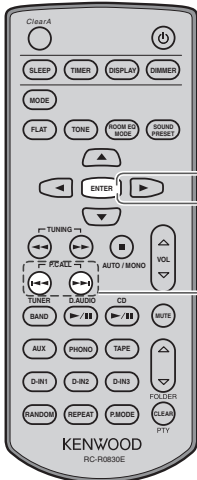



RDS (Radio Data System)

This system is designed for RDS reception, it can extract the information from the broadcast signal for use with various functions such as automatic display of the station name.

- Select the FM band.
- Preset RDS stations with the AUTO MEMORY function. (P.28)

PS (Program Service) Name Display

When an RDS broadcast is received, the station name is automatically displayed.



- The "RDS" lights up when an RDS broadcast (signal) is received.

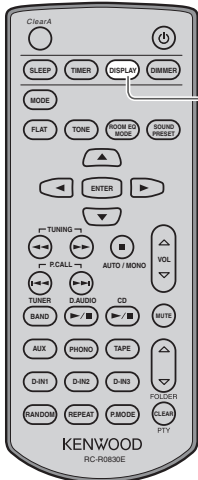

■ To switch the displays

Press the [DISPLAY] key.

- The mode changes as shown below each time you press the key.

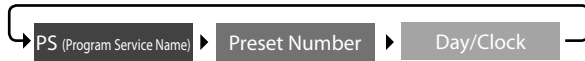

- Some stations may not be provided or be given different names depending on countries or areas.

Searching for a Desired Program Type (PTY Search)

The tuner automatically searches for a station which is currently broadcasting a specified program type (genre).



1 Press the [PTY] key.

- When an RDS broadcast is received, the program type is shown on the display. If no PTY data is available, or if the station is not an RDS station, "None" is displayed.

2 Press the [▲] or [▼] key to select the desired program type.

- Use program type table for your convenience.

Program type table

Program Type Name	Display
Pop Music	Pop M
Rock Music	Rock M
Easy Listening Music	Easy M
Light Classical	Light M
Serious Classical	Classics
Other Music	Other M
News	News
Current Affairs	Affairs
Information	Info
Sport	Sport
Education	Educate
Drama	Drama
Culture	Culture
Science	Science
Varied	Varied

Program Type Name	Display
Weather	Weather
Finance	Finance
Children's programs	Children
Social Affairs	Social
Religion	Religion
Phone In	Phone In
Travel	Travel
Leisure	Leisure
Jazz Music	Jazz
Country Music	Country
National Music	Nation M
Oldies Music	Oldies
Folk Music	Folk M
Documentary	Document

3 Press the [ENTER] key.

POP M PTY

- No sound is heard while "PTY" is flashing.
- If a program of the desired type is found, that program is received and the frequency display changes to the station name display.

■ To cancel the PTY search

Press the [PTY] key.



- If a program of the desired type cannot be found, "NO PROGRAM" flashes, then after several seconds the display returns to the original display.

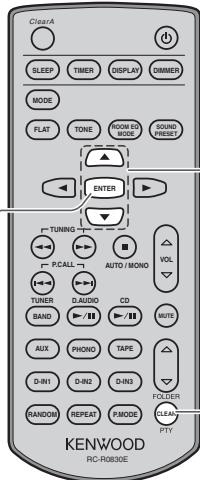



External Components

You can play tracks by connecting external components to the system.

Playback from External Components

Connect the external component to the system as described in “Connecting Other Accessories (Commercially Available Units)” (P.13–15).

- When connecting external components, always turn this system and the external components off beforehand.
- Refer also to the instruction manual for the external component to be connected.

1



Select the input source to be used for playback.



Turn the [INPUT SELECTOR] knob to select the input source to be used for playback.

The input source changes as shown below each time you press the key.



- When a digital component is selected, the input signal sampling frequency is displayed. The R-K1000 will play PCM (32 kHz – 96 kHz) digital signals.

2

Begin playback on the connected external component.

Begin playback using the controls on the connected external component.

3

Adjust the volume level.

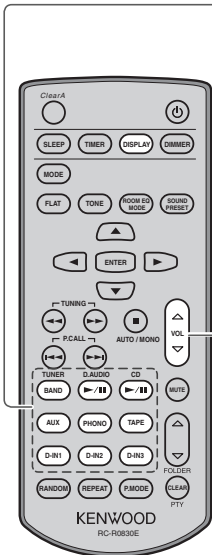

- The display changes as shown below each time you press the [DISPLAY] key.

When “D.AUDIO”, “PHONO”, “TAPE” or “AUX” is selected:

Selected input source ↔ Day/Clock

When “CD”, “D-IN1”, “D-IN2” or “D-IN3” is selected:

Selected input source/Sampling frequency ↔ Day/Clock

- Connecting Other Accessories (Commercially Available Units) → P.13-15
- Audio Settings → P.37 onwards

Adjusting the External Component Input Level

Use the procedure below to adjust the input level for the external component connected to the [PHONO IN], [TAPE IN] or [AUX IN] terminal.

Use this adjustment when the volume from an external component is noticeably higher or lower than other input sources at the same volume setting.



1 Select the input source to adjust the input level.

Turn the [INPUT SELECTOR] knob and select the input source to adjust the input level.

- You can set the input level for each of PHONO, TAPE and AUX.

2 Press the [MODE] key.

3 Select "INPUT LEVEL".

Press the [▲] or [▼] key.

INPUT LEVEL



Press the [ENTER] key.

4 Set the input level.

Press the [▲] or [▼] key.

LEVEL +1



Press the [ENTER] key.

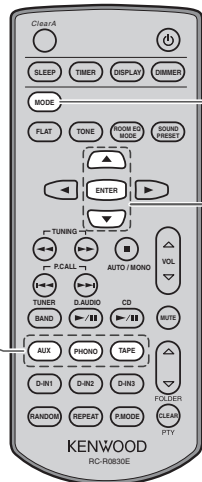

- If you adjust the input level for PHONO or AUX, the output level from the [TAPE OUT] terminal will also change.



D.AUDIO

You can connect a Kenwood digital audio player (referred to hereafter simply as “digital audio player”) to the system and use it to play tracks.

Playback from a Digital Audio Player

Use this procedure to connect a digital audio player to the system and use it to play tracks.

- When connecting the digital audio player, always turn this system and the digital audio player off beforehand.
- Refer also to the instruction manual for the digital audio player to be connected.
- Connecting the digital audio player using the dedicated cable allows you to operate the digital audio player using the main unit or the remote control.

Compatible Kenwood digital audio players

HDD audio player	Memory audio player
HD20GA7	M1GC7

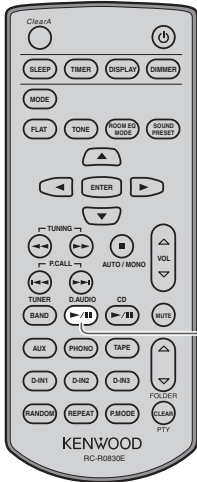

- 1 **Connect the digital audio player to the [D.AUDIO] terminal on the front panel of the main unit.**

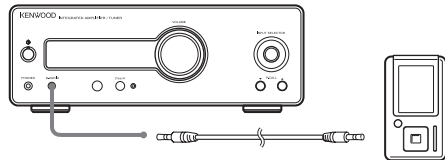

- 2 **Turn on the digital audio player.**

- 3 **Press the [D.AUDIO▶/II] key to begin playback.**

- Simply pressing the [D.AUDIO▶/II] key turns on the system and begins playback.
- If the digital audio player is not connected using the dedicated cable, use the controls on the connected digital audio player.



- If you use the dedicated cable for the connection, the volume and sound quality settings on the digital audio player are disabled.
- When you have finished using the digital audio player, disconnect the player's connection cable from the [D.AUDIO] terminal.

Related Information

- Adjusting the Digital Audio Player Input Level → P.36
- Audio Settings → P.37 onwards

■ Operations during digital audio player playback

Playing the tracks in the previous/next folder

To go to the previous folder, press the [**FOLDER ▲**] key.

To go to the next folder, press the [**FOLDER ▼**] key.

- These functions may not work with some digital audio player models.

Skipping forward/back

Hold down the [**I◀◀**] or [**▶▶I**] key.

Pausing and resuming playback

Press the [**D.AUDIO▶/||**] key.

Stopping playback

Press the [**■**] key.

Skipping tracks/ skipping back/ skipping to the start

Skip a track

Press the [**▶▶I**] key.

Skip back to the previous track

Press the [**I◀◀**] key two or more times in succession.

Return to the start of the track

Press the [**I◀◀**] key once.

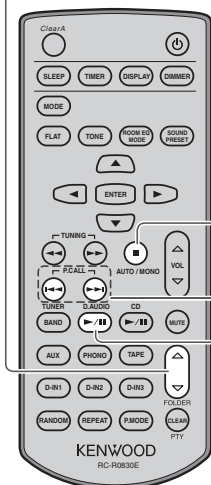

Adjusting the Digital Audio Player Input Level

Use the procedure below to adjust the input level for the external component connected to the [D.AUDIO] terminal.

Use this adjustment when the volume from an external component is noticeably higher or lower than other input sources at the same volume setting.

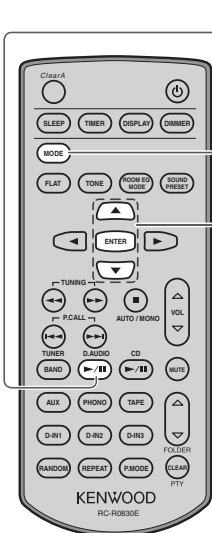

1 Press the [D.AUDIO ►/||] key.

2 Press the [MODE] key.

3 Select "INPUT LEVEL".

Press the [▲] or [▼] key.



Press the [ENTER] key.

4 Set the input level.

Press the [▲] or [▼] key.



Press the [ENTER] key.

- You can adjust the input level in a range from -3 to +5.



- If you adjust the input level for D.AUDIO, the output level from the [TAPE OUT] terminal will also change.

Audio Settings

Use the procedures in this chapter to specify the sound quality settings for your stereo system.

These procedures allow you to set up the Room Equalizer function, which will measure the acoustic characteristics of your room and optimize the system's acoustic effects. You can also use the system's digital sound equalizer function to customize the sound to your own preferences.

ROOM EQ (Room Equalizer)

- Automatically Setting the Acoustic Effects for the Room (ROOM EQ) 38
- Matching the Acoustic Effect to the Conditions..... 41



Digital Sound Equalizer

- Adjusting the Range Levels (TONE)..... 42

Sound Presets

- Registering Sound Effects 45
- Using Sound Presets 46
- Disabling Equalizer Effects (FLAT) 47

Supreme EX

- Setting Supreme EX 48

Clear A

- Setting Clear A 49

BALANCE

- Adjusting the Speaker Volume Balance 50

ROOM EQ (Room Equalizer)

The system measures the test signal emitted from the speakers using the microphone supplied with the system and automatically sets the optimum acoustic effect for the size of the room and the location in which the stereo is installed. You can also combine this with the TONE effects.

Automatically Setting the Acoustic Effects for the Room (ROOM EQ)

The system measures the acoustic characteristics using the microphone supplied with the system and automatically sets the following acoustic effects:

- The sound delay from speakers
- The volume level difference between the left and right speakers
- The speaker frequency characteristics and the acoustic characteristics in the room

The speakers emit a very loud test signal during the measurement. Carefully consider the impact on your neighbors and on children, particularly at night.

Do not place obstacles between the speakers and the microphone.

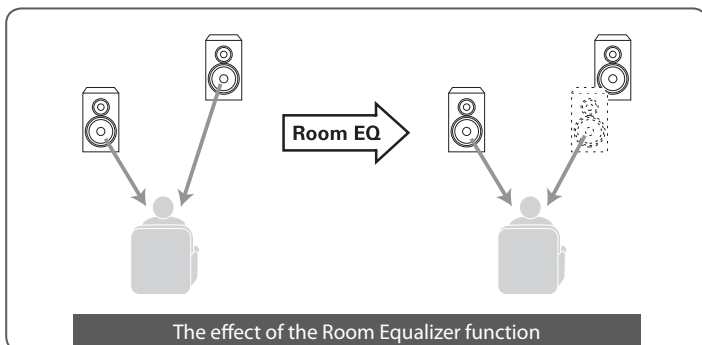
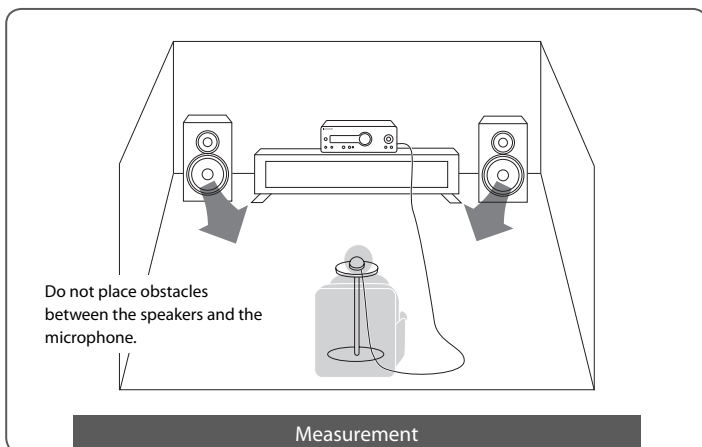

- 1 **Plug the room equalizer microphone supplied with the system into the [ROOM EQ MIC IN] jack on the rear panel of the main unit.**

See "Main Connections" (P.10) for details.

- 2 **Place the microphone in the listening position (at ear level).**

Do not place any obstacles between the microphone and speakers during measurement.

- 3 **Press the [MODE] key.**

- 4 **Select "ROOM EQ".**

Press the [\blacktriangle] or [\blacktriangledown] key.

ROOM EQ

Press the [ENTER] key.

R. EQ START

- 5 **Press the [ENTER] key.**

R. EQ SETUP

- During setup, "R.EQ SETUP" appears on the display and "ROOM EQ" flashes.
When setup is completed, "ROOM EQ" stops flashing and remains lit.

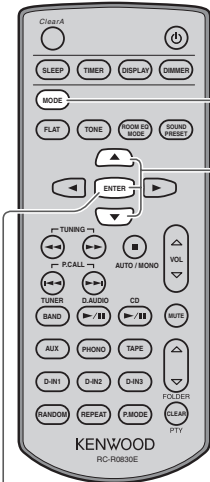

Canceling automatic setup

If you press the **[MODE]** key during automatic setup, the "R.EQ CANCEL?" message appears. If you press the **[ENTER]** key, "R.EQ CANCEL" is displayed and setup is canceled. Pressing the **[VOL]** key also cancels automatic setup.

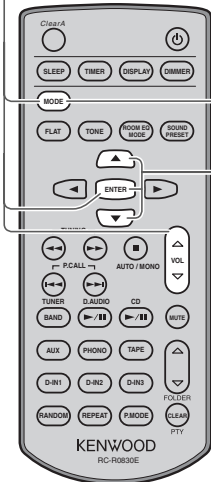

■ Temporarily canceling the characteristics set automatically

- 1 Press the **[MODE]** key.
- 2 Press the **[▲]** or **[▼]** key to select "ROOM EQ".
- 3 Press the **[ENTER]** key.
- 4 Press the **[▲]** or **[▼]** key to select "R.EQ OFF".
- 5 Press the **[ENTER]** key.

■ Restoring canceled characteristics

- 1 Press the **[MODE]** key.
- 2 Press the **[▲]** or **[▼]** key to select "ROOM EQ".
- 3 Press the **[ENTER]** key.
- 4 Press the **[▲]** or **[▼]** key to select "R.EQ CALL".
- 5 Press the **[ENTER]** key.



- Automatic setup takes about 1 minute to complete.
- If the room equalizer microphone is not connected, or if headphones are connected, the "CAN'T SETUP" message appears and measurement fails.
- Always disconnect the microphone from the main unit once measurement is completed.
- Depending on the conditions in which the system is used, the effects of the Room Equalizer may not be clearly apparent.
- Do not perform other operations during automatic setup.

Matching the Acoustic Effect to the Conditions

Carry out the "ROOM EQ" (P.38) procedure beforehand. This procedure then allows you to select the sound mode based on the selected sound effect and your listening conditions.

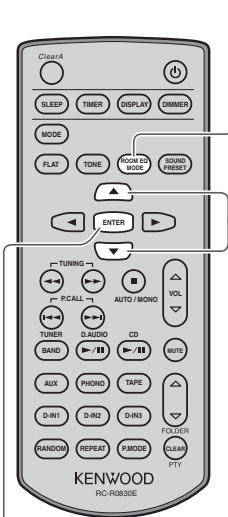

1 Press the [ROOM EQ MODE] key.

2 Press the [▲] or [▼] key to select the sound mode.

The display changes as shown below.

R.EQ NORMAL This mode faithfully reproduces the results of the ROOM EQ measurements.



R.EQ WIDE This mode allows you to enjoy music with no discernible loss of quality over a relatively wide area centered around the measurement position.



R.EQ NIGHT This mode enhances the reproduction of highly melodic music when you are listening at low volumes, as with late-night listening.



R.EQ LIVE This mode creates an environment with complex reverberations, similar to a concert hall.



R.EQ VOCAL This mode provides enhanced reproduction of vocals and speech.

3 Press the [ENTER] key.



- "ROOM EQ" does not appear and "ROOM EQ MODE" will not work prior to automatic setup or when "R.EQ OFF" is selected.



Digital Sound Equalizer

This system features a Digital Sound Equalizer function that uses DSP-based digital processing. This provides more detailed settings that allow you to adjust the sound to your own preferences.

Adjusting the Range Levels (TONE)

Use this feature to adjust low-, mid- and high-range tones. By choosing one of 3 frequencies (TURN OVER) for each tone range and then setting the levels, you can adjust the tones to match your preferences. You can also combine this with the ROOM EQ effects.

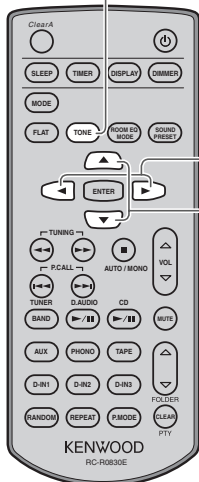
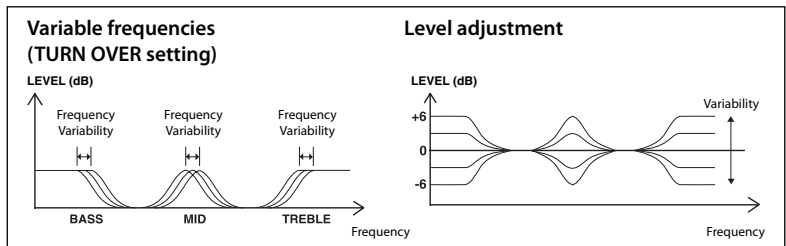

1 Press the [TONE] key.

- "TONE" flashes while setting is in progress.

2 Press the [◀] or [▶] key to select the frequency of the low tones (BASS) you want to adjust (60 Hz, 100 Hz, 150 Hz).

BASS 150Hz
TONE

3 Adjust the low tones (BASS) level by pressing the [▲] or [▼] key.

BASS +3
TONE

- While the "TONE" is flashing, you can adjust the level through a range from -6 to +6.

Related Information

● Sound Presets → P.45

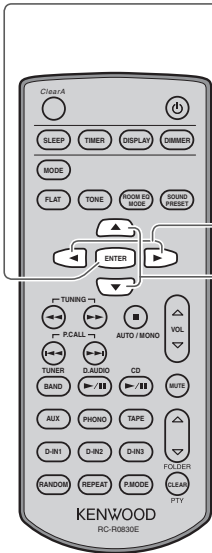

4 Press the [ENTER] key.

5 Press the [◀] or [▶] key to select the frequency of the mid tones (MID) you want to adjust (1 kHz, 2 kHz, 3 kHz).



6 Adjust the mid tones (MID) level by pressing the [▲] or [▼] key.



● While the “TONE” is flashing, you can adjust the level through a range from -6 to +6.



Continued to next page

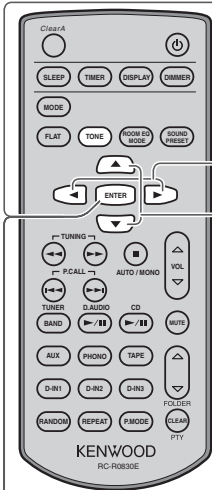

7 Press the [ENTER] key.

8 Press the [◀] or [▶] key to select the frequency of the high tones (TREBLE) you want to adjust (5 kHz, 7 kHz, 10 kHz).

TREBLE 10kHz
TONE

9 Adjust the high tones (TREBLE) level by pressing the [▲] or [▼] key.

TREBLE -2
TONE

- While the "TONE" is flashing, you can adjust the level through a range from -6 to +6.

10 Press the [ENTER] key.

- If you set a level other than 0, the "TONE" lights.



- If you do not need to adjust all the range levels, press the [TONE] key to end the settings after you have finished the range level adjustments you want to make.

Sound Presets

You can register up to 3 of the sound effects you have set as Sound Presets.

You can then recall and apply the registered Sound Presets simply by pressing the [SOUND PRESET] key.

Registering Sound Effects

You can register up to 3 of the sound effects you have set using ROOM EQ, ROOM EQ MODE or TONE.

- First use ROOM EQ (P.38), ROOM EQ MODE (P.41) or TONE (P.42) to set a sound effect.

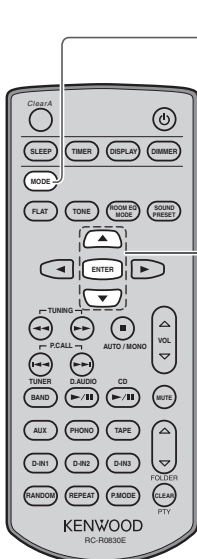

1 Press the [MODE] key.

2 Select "SOUND PRESET".
Press the [▲] or [▼] key.

SOUND PRESET

Press the [ENTER] key.

3 Select a Sound Preset number (1–3).
Press the [▲] or [▼] key.

PRESET 1 2 3

- The selected preset number flashes.

Press the [ENTER] key.

- The registered Sound Preset number lights and the sound effect currently set is registered.



Using Sound Presets

Use this procedure to recall and apply a registered Sound Preset.

- Register the sound effect you want to use as a Sound Preset beforehand. (P.45)

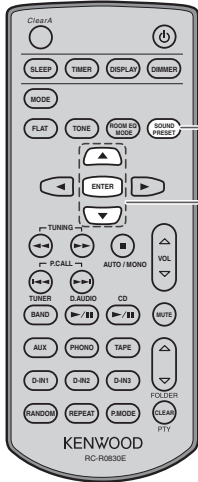

1 Press the [SOUND PRESET] key.

2 Select a Sound Preset number (1-3).

Press the [▲] or [▼] key.



Press the [ENTER] key.

Disabling Equalizer Effects (FLAT)

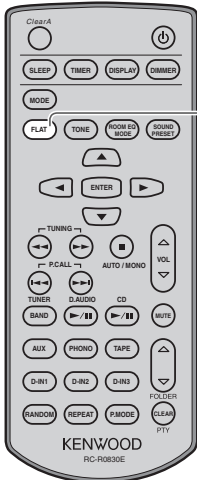

1 Press the **[FLAT]** key.

FLAT

- The "TONE" levels are set to 0 and "NORMAL" is set in "ROOM EQ MODE" and the TURN OVER settings also revert to their default values.
- Press the **[FLAT]** key again to restore the original settings.



Supreme EX

Supreme EX is Kenwood's original sound quality enhancement technology and is used for playing CDs and audio files or for playback using components connected to a digital input terminal.

Setting Supreme EX

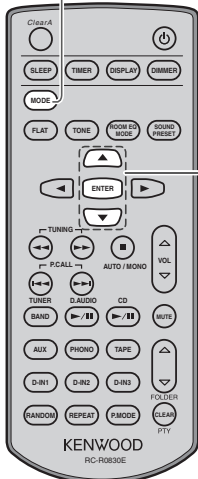

1 Press the [MODE] key.

2 Select "SUPREME SET".

Press the [▲] or [▼] key.

SUPREME SET

- The "SPRM EX" flashes.

Press the [ENTER] key.

3 Select "ON" or "OFF".

Press the [▲] or [▼] key.

SUPREME ON
SPRM EX

- "SPRM EX" lights when "SUPREME ON" is set and turns off when "SUPREME OFF" is set.

SUPREME OFF

Press the [ENTER] key.



- The Supreme EX function operates when "CD", "D-IN1", "D-IN2" or "D-IN3" is selected.
- Even when "CD", "D-IN1", "D-IN2" or "D-IN3" is selected, "SPRM EX" does not light if the input signal frequency is 96 kHz or 88.2 kHz.

Clear A

Clear A mode allows you to enjoy superb rich sound quality even at low volumes.

This function is particularly useful for situations when you want to keep the volume low, such as late-night listening.

Setting Clear A

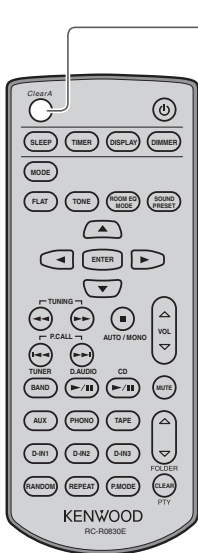

1

 Press the [Clear A] key.

 Press the [Clear A] key.

CLEAR A ON

- The volume adjustment range changes to minus infinity ($-\infty$) dB to 0 dB.

■ To cancel the Clear A function

Press the [Clear A] key.

CLEAR A OFF

- The volume adjustment range reverts to minus infinity ($-\infty$) dB to +8 dB.



- The Clear A function does not work while headphones are connected.
- When "CLEAR A ON" is set, the volume can be adjusted in half the normal increments.



BALANCE

Use this procedure to adjust the volume balance for the left and right speakers.

Adjusting the Speaker Volume Balance

1 Press the [MODE] key.

2 Select "BALANCE".

Press the [▲] or [▼] key.

BALANCE

Press the [ENTER] key.

3 Adjust the balance.

Press the [▲] or [▼] key.

L T R

Press the [ENTER] key.

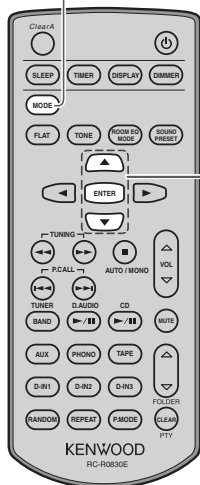

Component Settings

As well as the basic time settings, this chapter explains various functions that make the system easier to use, such as the timer and display settings.

Setting the Time52

Setting the Timer

- Setting the Sleep Timer (SLEEP) 53
- Setting the Program Timer (PROGRAM) 54

Display Settings

- Setting the Display Brightness (DIMMER) 58
- Turning the Display Saver ON/OFF 59

Auto Power Save (A.P.S.)60



Setting the Time

Set the system clock to the correct time. If you use the Program Timer for playback when the time is not set correctly, you will not be able to run the program at the correct time.

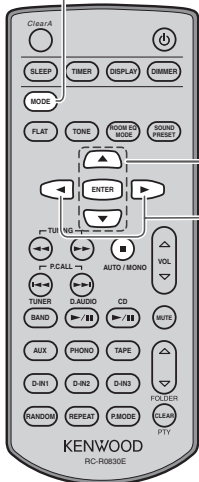

1 Press the [MODE] key.

2 Select "TIME ADJUST".

Press the [▲] or [▼] key.

TIME ADJUST

▶ Press the [ENTER] key.

3 Set the day of the week.

Press the [▲] or [▼] key.

SAT 0:00

▶ Press the [ENTER] key.

4 Set the time.

Press the [▲] or [▼] key.

Set the "hour".

● The "hour" flashes.

SAT 5:00

▶ Press the [ENTER] key.

Press the [▲] or [▼] key.

Set the "minute".

● The "minute" flashes.

SAT 5:30

▶ Press the [ENTER] key.

● The set day and time are displayed.

● If you make a mistake with the settings, press the [◀] or [▶] key to move the cursor and re-enter the settings.



● If there is a power failure or the system is unplugged from the wall outlet for some time, set the time again.

● Pressing the [■] key while the system is in the Standby mode will display the time for 5 seconds.

Setting the Timer

The system features the Sleep Timer, which automatically turns the system off after a set interval, and the Program Timer, which starts playback at a specified time.

Setting the Sleep Timer (SLEEP)

This function automatically turns the system off after a set interval. You can set an interval between 10 and 90 minutes in 10-minute increments until the system is turned off.

1

Press the [SLEEP] key.

The interval increases by 10 minutes each time you press the key. The setting after 90 minutes turns the timer off.

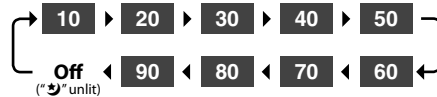

During Sleep Timer setting



- While the Sleep Timer is running, you can check the remaining time by pressing the [SLEEP] key.

■ To cancel the Sleep Timer

Press the power [⏻] key to turn the system off (Standby) or press the [SLEEP] key so that "⏻" is no longer displayed.

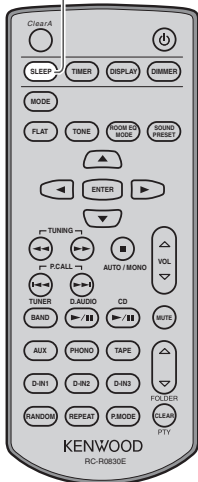

Setting the Program Timer (PROGRAM)

This function allows you to use the timer to automatically start playback at a specified time. You can set two timers (PROG. 1 and PROG. 2) at the same time. You can use the timer to activate CD, radio or external component.

- Set the system's clock to the correct time beforehand. (P.52)
- Separate the times for PROG. 1 and PROG. 2 by at least 1 minute to ensure that their operating times do not overlap.

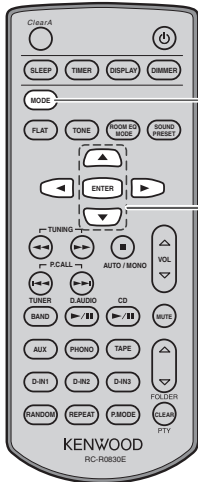

1 Press the [MODE] key.

2 Select "TIMER SET".

Press the [▲] or [▼] key.



Press the [ENTER] key.

3 Select "PROG. 1" or "PROG. 2".

Press the [▲] or [▼] key.



Press the [ENTER] key.

4 Select "ON" or "OFF".

Press the [▲] or [▼] key.



Press the [ENTER] key.

- Selecting "OFF" ends the procedure and restores the original display.

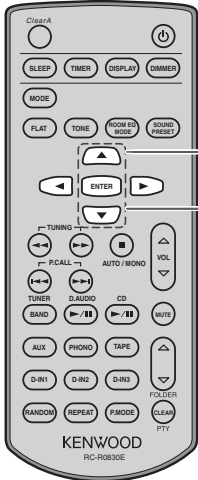

5 Select the day (or days) on which the Program Timer will run.

Press the [▲] or [▼] key.

The setting changes as shown below each time you press the key.

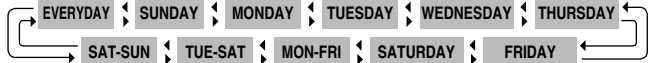

Press the [ENTER] key.

- If you selected "EVERYDAY", "MON-FRI", "TUE-SAT" or "SAT-SUN", proceed to step 7.

6 Select "EVERY WEEK" or "ONETIME".

Press the [▲] or [▼] key.



- The timer runs every week.



- The specified timer runs once only.

Press the [ENTER] key.

7 Specify the "ON" (start time) setting.

Press the [▲] or [▼] key.

Set the "hour".



- The "hour" flashes.
 - ▶ Press the [ENTER] key.

Press the [▲] or [▼] key.

Set the "minute".



- The "minute" flashes.
 - ▶ Press the [ENTER] key.

8 Specify the "OFF" (end time) setting.

Press the [▲] or [▼] key.

Set the "hour".



- The "hour" flashes.
 - ▶ Press the [ENTER] key.

Press the [▲] or [▼] key.

Set the "minute".



- The "minute" flashes.
 - ▶ Press the [ENTER] key.

Continued to next page

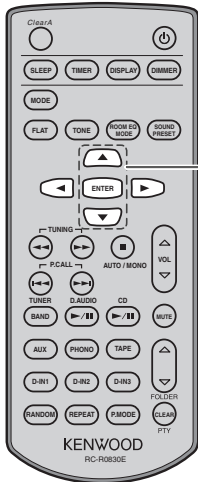

9 Select "PLAY" or "AI PLAY".

Press the [▲] or [▼] key.

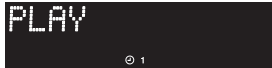

- Playback is at the volume set in step 11.



- Playback begins at the specified time and the volume gradually increases to the level set in step 11.

Press the [ENTER] key.

10 Select "CLEAR A ON" or "CLEAR A OFF".

Press the [▲] or [▼] key.



- The volume adjustment range changes to 0 dB to minus infinity ($-\infty$) dB.



- The volume adjustment range changes to minus infinity ($-\infty$) dB to +8 dB.

Press the [ENTER] key.

11 Set the volume.

Press the [▲] or [▼] key.



Press the [ENTER] key.

- You cannot use the [VOL] key to set the volume.



- You can also confirm the settings in steps 4 to 11 by pressing the [▶] key instead of the [ENTER] key. Also, pressing the [◀] key returns you to the previous setting and allows you to specify that setting again.

12 Select the input source.

Press the [▲] or [▼] key.

The input source changes as shown below each time you press the key.



Press the [ENTER] key.

- If you select an input source other than "TUNER", this completes the settings and "COMPLETE" is displayed briefly, after which the original display reappears.
- If you select "TUNER", use the [▲] or [▼] to select a preset number and then press the [ENTER] key. This completes the settings and "COMPLETE" is displayed briefly, after which the original display reappears.

13 Press the power [⏻] key to turn the power OFF.

The Standby indicator on the main unit lights orange.

- If the indicator lights red, set the clock to the correct time.

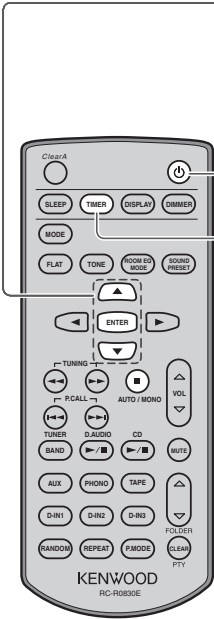

■ To cancel (off) or reset (on) the timer

- When the system is turned on, press the [TIMER] key. The setting changes each time you press the [TIMER] key.



- If there has been a power failure or the system was unplugged from the wall outlet for some time, the Standby indicator lights red. In that case, set the time again. (P.52)



- To modify the program settings, redo the timer settings from the beginning.
- When the system is in Standby mode, you can confirm the timer setting (on or off) for 5 seconds by pressing the [■] key.



Display Settings

Use these settings to adjust the brightness of the display and to specify the settings for the main unit dial lighting.

Setting the Display Brightness (DIMMER)

Use these settings to adjust the brightness of the display and to specify the settings for the main unit dial lighting. Adjust the brightness according to your preference and the conditions in the room.

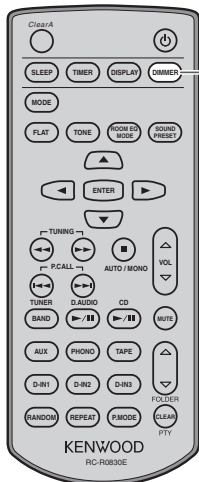

1

Press the [DIMMER] key.

The setting changes as shown below each time you press the key.

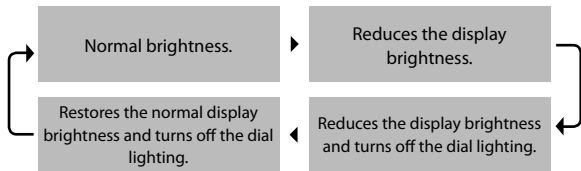

- If the R-K1000 is connected to the DP-K1000 (sold separately) using the system control connection, setting the DIMMER function runs the same function on the DP-K1000 also.

Turning the Display Saver ON/OFF

If the system is not used at all for a set period, this function scrolls the display to prevent burn-in of the text on the display and uneven display brightness.

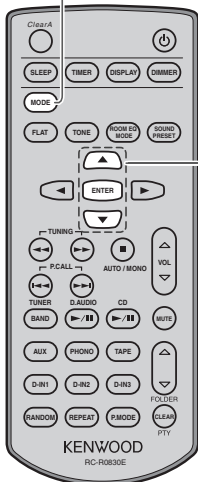

1 Press the [MODE] key.

2 Select "DISP. SAVER".

Press the [▲] or [▼] key.

DISP. SAVER

Press the [ENTER] key.

3 Select "ON" or "OFF".

Press the [▲] or [▼] key.

D. SAVER ON

• The display saver is active.

D. SAVER OFF

• The display saver is disabled.

Press the [ENTER] key.



- When you are playing a CD (when the DP-K1000 (sold separately) is connected), the display saver is activated if the system is not used at all for 10 minutes after the CD stops playing. If you selected another input source, the display saver is activated if the system is not used at all for 10 minutes after the last key is pressed.
- If the R-K1000 is connected to the DP-K1000 using the system control connection, the Display Saver runs on the DP-K1000 also.



Auto Power Save (A.P.S.)

Auto Power Save (A.P.S.) is a function that automatically turns the system off if it is not used at all for 30 minutes after a CD stops playing. (When the DP-K1000 (sold separately) is connected.)

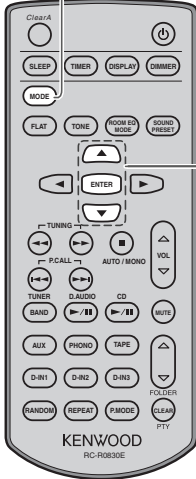

1 Press the [MODE] key.

2 Select "A.P.S. SET".
Press the [▲] or [▼] key.

A.P.S. SET
A.P.S.

● "A.P.S." flashes on the display.

Press the [ENTER] key.

3 Select "ON" or "OFF".
Press the [▲] or [▼] key.

A.P.S. ON
A.P.S.

● "A.P.S." lights up on the display.

A.P.S. OFF
A.P.S.

● "A.P.S." turns off.

Press the [ENTER] key.



- This function operates when the volume is set to minus infinity ($-\infty$) dB or when MUTE is set to on.
- When recording on external components, turn A.P.S. off or adjust volume to more than -88 dB.

Maintenance

This chapter explains how to deal with error messages displayed on the system or problems that may arise. It also describes how to store and maintain your system so that it continues to give pleasure for many years to come.

Messages	62
Troubleshooting	63
Care and Storage	66
Specifications	67



Messages

Displayed Message	Meaning
CAN'T SETUP	<ul style="list-style-type: none">● The ROOM EQ microphone is not connected. →Connect the ROOM EQ microphone. (P.10)● Headphones are plugged into the [PHONES] jack. →Unplug the headphones.
Non-PCM	The [CD IN (COAX)], [DIGITAL IN 1 (OPT)], [DIGITAL IN 2 (OPT)] or [DIGITAL IN 3 (COAX)] terminal is receiving non-PCM input signals. (P.14–16)
R.EQ ERROR1	Measurement failed because the room being measured is too noisy. →Reduce the amount of ambient noise.
R.EQ ERROR2	Measurement failed because there is no signal input to the microphone.
UNLOCK	The component connected to the [CD IN (COAX)], [DIGITAL IN 1 (OPT)], [DIGITAL IN 2 (OPT)] or [DIGITAL IN 3 (COAX)] terminal is not turned on. Alternatively, there is no signal input. (P.14–16)
--- kHz	The sampling frequency of the input PCM signals is outside the playable range.

Troubleshooting

Apparent faults or malfunctions may be easily resolved. Before calling for service, check the table below for symptoms that match yours.

Amplifier/Speakers

Symptoms	Possible Cause/Solution	Ref. page
There is no sound.	● Check that the system is connected properly, as described in "Connecting the System".	10-15
	● Increase the volume.	22
	● Cancel the MUTE setting.	22
	● If there are headphones plugged into the main unit, unplug them.	15
The Standby indicator is flashing red and there is no sound.	● One of the speaker cords is short-circuited. Unplug the power cord and then reconnect the speaker cord.	11
	● There may be an internal problem. Turn off the power to the main unit, unplug the power cord and request repairs.	—
There is no sound from the headphones.	● Check that the headphone plug is inserted correctly.	15
	● Increase the volume.	22
	● Cancel the MUTE setting.	22
There is no sound from "CD", "D-IN 1", "D-IN 2", or "D-IN 3".	● Check that the system is connected properly, as described in "Connecting the System".	14-16
	● Check whether "PCM" is selected as the digital audio output setting on the connected component.	
There is no sound from one of the speakers.	● Check that the system is connected properly, as described in "Connecting the System".	10
	● Adjust the balance.	50
There is a booming sound when I select PHONO as the input source.	● Insert the audio cord plugs securely into the [PHONO IN] jacks.	15
	● Connect the signal earth wire to the [地] terminal.	15
The clock display is flashing.	● Set the time as described in "Setting the Time".	52
The timer does not work.	● Set the time as described in "Setting the Time".	52
	● Set a start time and end time for the program timer.	54
Scrolls text on the display.	● Disable the Display Saver.	58



Tuner

Symptoms	Possible Cause/Solution	Ref. page
I can't get reception from a radio station.	<ul style="list-style-type: none"> ● Connect the antennas. ● Select the broadcast band (AM or FM). ● Tune the radio to the frequency of the desired station. 	10, 11 26 26
There is interference (noise).	<ul style="list-style-type: none"> ● Install an outdoor antenna away from the road. ● Turn off any electrical appliances that may be causing interference. ● Move the system away from the TV. 	—
I have used Auto Memory and pressed the [P.CALL] key, but I still can't get radio reception.	<ul style="list-style-type: none"> ● Run Auto Memory again. ● Manually preset stations with frequencies that you can receive. 	28 29



Components connected to the D.AUDIO terminal

Symptoms	Possible Cause/Solution	Ref. page
I can't use the remote control or main unit to control my Kenwood digital audio player.	<ul style="list-style-type: none"> ● Connect the player using the dedicated cable. ● Check whether the connected model is compatible. 	13 34

Remote control

Symptoms	Possible Cause/Solution	Ref. page
The remote control does not work.	<ul style="list-style-type: none"> ● Insert new batteries. ● Use the remote control from within its effective range. 	19 19
I can't use R-K1000 remote control to control the DP-K1000 (sold separately).	<ul style="list-style-type: none"> ● Connect the system control cable properly. 	12

Resetting the microcomputer

Symptoms	Possible Cause/Solution
<p>Microcomputer malfunction (the system does not work, the display is faulty, etc.).</p>	<ul style="list-style-type: none"> ● Malfunctions may occur due to an external cause or because a connection cord was unplugged while the system was turned on. Use the procedure below to reset the microcomputer. <ol style="list-style-type: none"> ① Unplug the power cord from the AC wall outlet. ② Plug the power cord back in while holding down the power [⏻] key on the main unit. <div style="display: flex; justify-content: space-around; align-items: center; margin-top: 10px;">   </div> ③ When the microcomputer is reset, the display shown on the right appears. <ul style="list-style-type: none"> ● Bear in mind that resetting erases any stored information and restores the system's default settings. <div style="text-align: center; margin-top: 10px;">  </div>



Care and Storage

Care and storage of main unit

■ Do not place in the following locations

- Place exposed to direct sunlight.
- Place subjected to excessive humidity or dirt.
- Place exposed to direct heat from heating equipment.

■ Be careful against condensation

When the difference in temperatures between the main unit and the environmental air is large, dew may be condensed inside the main unit and may cause malfunction of the main unit. If this happens, leave the main unit for a few hours until its internal mechanisms are dried up.

Take special care against condensation when the main unit is moved between places with a large temperature difference or into a room with high humidity.

■ When a main unit becomes dirty

When the front panel or case gets dirty, wipe with a soft dry cloth. Do not use lacquer thinner, benzine, alcohol or contact revitalizer for these chemicals will cause discoloration or deformation.

Specifications

[Amplifier]

Rated output

Rated output power (Clear A: OFF)
.....40 W + 40 W (63 Hz – 12.5 kHz, 0.7 %, 6 Ω, IEC)

Output power (Clear A: OFF)
.....50 W + 50 W RMS (1 kHz, 10 %, 6 Ω)
.....60 W + 60 W RMS (1 kHz, 10 %, 4 Ω)

Output power (Clear A: ON)
.....10 W + 10 W RMS (1 kHz, 10 %, 6 Ω)
.....15 W + 15 W RMS (1 kHz, 10 %, 4 Ω)

Total harmonic distortion (Clear A: ON)
.....0.08 % (1 kHz, 1 W, 6 Ω)

Frequency response (IHF '66)
LINE (AUX, TAPE, D.AUDIO)8 Hz – 30 kHz, +0 dB – -3 dB
LINE (CD, D-IN1, D-IN2, D-IN3)....8 Hz – 30 kHz, +0 dB – -3 dB

PHONO 'RIAA' response20 Hz – 20 kHz, ±1.0 dB
Maximum input level

PHONO (MM)50 mV, 0.1 % T.H.D. at 1 kHz

Signal to noise ratio (CD, D-IN1, D-IN2, D-IN3)....120 dB (IHF '66)
Tone control characteristics

BASS
(TURN OVER 60 Hz)±3.0 dB (at 60 Hz)
(TURN OVER 100 Hz) ±5.3 dB (at 60 Hz)
(TURN OVER 150 Hz) ±6.0 dB (at 60 Hz)

MID
(TURN OVER 1 kHz)..... ±6.0 dB (at 1 kHz)
(TURN OVER 2 kHz)..... ±6.0 dB (at 2 kHz)
(TURN OVER 3 kHz)..... ±6.0 dB (at 3 kHz)

TREBLE
(TURN OVER 5 kHz)..... ±5.6 dB (at 10 kHz)
(TURN OVER 7 kHz)..... ±4.9 dB (at 10 kHz)
(TURN OVER 10 kHz)..... ±3.0 dB (at 10 kHz)

Input terminals (Sensitivity/Impedance)

PHONO (MM) 3.5 mV / 29 kΩ
LINE (AUX, TAPE)..... 200 mV / 82 kΩ
LINE (D.AUDIO)..... 100 mV / 82 kΩ

Output terminals (Level/Impedance)

LINE (TAPE) 200 mV / 760 Ω

[Digital unit]

Sampling frequencies

..... 32 kHz, 44.1 kHz, 48 kHz, 88.2 kHz, 96 kHz

Supreme EX (CD, D-IN1, D-IN2, D-IN3)

Playable frequencies..... 1 Hz – 44 kHz

Digital input terminals (Sensitivity/Impedance/Wave length)

OPT (Optical)..... -24 dBm – -15 dBm, 660 nm ± 30 nm

COAX (Coaxial) 0.5 Vp-p, 75 Ω

[Tuner]

FM tuner

Reception frequency range

..... 87.5 MHz – 108 MHz (50 kHz step)

AM tuner

Reception frequency range..... 531 kHz – 1,602 kHz

[Power Supply, etc.]

Power consumption57 W

Power consumption (Standby)..... Less than 0.25 W

Dimensions

Width270 mm (10-10/16")

Height.....99 mm (3-14/16")

Depth..... 318 mm (12-8/16")

Weight (net)..... 5.3 kg (11.68 lb)

- Design and specifications are subject to change without notice.
- Full performance is not guaranteed in extremely cold environments (under water-freezing temperatures).



KENWOOD

For your records

Record the serial number, found on the back of the unit, in the spaces designated on the warranty card, and in the space provided below. Refer to the model and serial numbers whenever you call upon your dealer for information or service on this product.

Model _____

Serial Number _____

Free Manuals Download Website

<http://myh66.com>

<http://usermanuals.us>

<http://www.somanuals.com>

<http://www.4manuals.cc>

<http://www.manual-lib.com>

<http://www.404manual.com>

<http://www.luxmanual.com>

<http://aubethermostatmanual.com>

Golf course search by state

<http://golfingnear.com>

Email search by domain

<http://emailbydomain.com>

Auto manuals search

<http://auto.somanuals.com>

TV manuals search

<http://tv.somanuals.com>